



Administrator Guide

Amazon Connect



Amazon Connect: Administrator Guide

Copyright © 2024 Amazon Web Services, Inc. and/or its affiliates. All rights reserved.

Amazon's trademarks and trade dress may not be used in connection with any product or service that is not Amazon's, in any manner that is likely to cause confusion among customers, or in any manner that disparages or discredits Amazon. All other trademarks not owned by Amazon are the property of their respective owners, who may or may not be affiliated with, connected to, or sponsored by Amazon.

Table of Contents

What is Amazon Connect?	1
Features of Amazon Connect	1
Amazon Connect Agent Workspace	1
Amazon Connect chat and messaging	4
Amazon Connect Tasks	5
Amazon Connect Contact Lens	6
Amazon Q in Connect	11
Forecasting, capacity planning, and scheduling	12
Amazon Connect Voice ID	15
Amazon Connect Customer Profiles	16
Amazon Connect outbound campaigns	17
Amazon Connect Cases	17
Reporting	18
How to get started	21
Pricing	21
Services to use with Amazon Connect	21
Development	22
Storage	23
Database	23
Analytics	23
Machine Learning (ML) and Artificial Intelligence (AI)	24
Messaging	24
Security	24
Management	25
Supported Regions	25
Amazon Connect	26
Agent workspace and step-by-step guides	27
Agent workspace third-party applications	28
Amazon Q in Connect	28
AppIntegrations	29
Cases	30
Chat messaging: SMS subtype	31
Communications widget	32
Contact Lens	32

Customer Profiles	35
Forecasting, capacity planning, and scheduling	37
Global Resiliency	37
In-app, web, and video calling capabilities	37
Live media streaming	38
Outbound campaigns	38
Tasks	39
Voice ID	39
Supported browsers	40
Mobile browsers	41
Supported browsers and mobile OS for in-app, web, and video calling capabilities	42
Issue with Firefox	42
Accessibility compliance	43
Supported screen readers	43
Supported languages	43
Contact Control Panel	44
Chat message content	44
Amazon Connect admin website	44
Amazon Connect Cases	45
Amazon Connect Contact Lens	45
Amazon Connect forecasting, capacity planning, and scheduling	49
Amazon Q in Connect	49
Amazon Lex	50
Amazon Polly	50
Service quotas	50
Important things to know	50
Amazon Connect quotas	52
AppIntegrations quotas	57
Amazon Q in Connect quotas	57
Cases quotas	58
Contact Lens quotas	59
Customer Profiles quotas	61
Outbound campaigns quotas	62
Voice ID quotas	63
How contacts are counted	64
Feature specifications	66

Countries you can call by default	76
API throttling quotas	79
Get started	87
Next steps	87
Take a free online class	88
Concepts	88
Telephony	89
Web and mobile messaging	92
Tasks	96
Pause and resume tasks	106
Routing profiles	120
Queues: standard and agent	122
Queues: priority and delay	125
Queue-based routing	128
Channels and concurrency	128
Flows	129
Best practices	132
Flows	132
Lambda	133
Chat and Amazon Lex	134
Contact Control Panel	134
Tutorials	134
Tutorial 1: Set up your Amazon Connect instance	135
Tutorial 2: Test the sample voice and chat experience	146
Tutorial 3: Create an IT help desk	152
Design for low latency	181
Architectural guidance	183
Amazon Connect workload layers	183
Scenario and deployment approaches	190
Operational Excellence	203
Security	220
Reliability	231
Performance efficiency	232
Cost optimization	241
Plan identity management	244
Use an existing directory for identity management	245

Configure SAML with IAM for Amazon Connect	246
Troubleshoot SAML with Amazon Connect	256
Additional resources	260
Amazon Connect API Reference	260
Amazon Connect Participant Service API Reference	260
Amazon AppIntegrations Service API Reference	261
Contact Lens for Amazon Connect API Reference	261
Amazon Connect Customer Profiles API	261
Amazon Connect Voice ID API Reference	261
Amazon Q in Connect API Reference	261
Amazon Connect Streams	261
Amazon Connect Chat UI Examples	262
Administrative support	262
Set up your contact center	263
Create an Amazon Connect instance	264
Things to know before you begin	264
Step 1: Set identity	264
Step 2: Add administrator	265
Step 3: Set telephony	266
Step 4: Data storage	266
Step 5: Review and create	268
Next steps	268
Create a test instance	268
Find your instance ID	269
Find your instance name/alias	270
Update instance settings	271
Enable attachments to share files	274
Set up attachment scanning	279
Enable data streaming	281
Emergency admin login	285
Delete your instance	286
Tagging an instance	288
Set up granular billing	295
Test voice, chat, and task experiences	304
Test voice	304
Test chat	305

Test tasks	307
View metrics for the test experiences	313
Set up your phone numbers	314
Port your current phone number	315
Claim and manage your phone numbers	333
Use caller identification to personalize customer interaction	345
Third-party numbers	349
UIFN service - Inbound only	350
Region requirements for ordering and porting phone numbers	359
Set up outbound calling	487
Set up outbound caller ID	487
Set up US emergency calling	493
Enable outbound calls	502
Outbound calling restrictions	503
Optimize your reputation for outbound calling	506
Set up outbound campaigns	509
Before you begin	509
Create a AWS KMS key	509
Configure outbound campaigns	510
Create an outbound campaign	512
Disable outbound campaigns	516
Assign permissions	516
Best practices for outbound campaigns	517
Best practices for ring duration and caller ID	539
Add users	539
Add users	540
Edit users in bulk	545
View historical changes	550
Download users	552
Delete users	552
Reset passwords	556
Security profiles	557
Set up routing	604
How routing works	605
Create a queue	608
Disable a queue	610

Delete a queue	611
Set queue capacity	611
Set the hours of operation	615
Create a routing profile	619
Delete a routing profile	626
Set up queue-based routing	626
Routing using agent proficiencies	626
Set up agents	633
Set up agent hierarchies	634
Customize agent status	636
Configure agent settings	637
Predefined attributes	639
Assign proficiencies to agents	643
Enable auto-accept call	645
CCPv1: Set up automatic agent logout	647
Set up agents to assign tasks to themselves	649
Set up tasks	650
Create task templates	651
Assign permissions for creating task templates	657
Block agents from creating tasks	657
Set up applications for task creation	657
Create rules	677
Set up in-app, web, and video calling capabilities	680
Communication widget	681
How to set up in-app, web, and video calling	682
Option 1: Configure an out-of-the-box communication widget	682
Option 2: Integrate in-app, web, and video calling natively into your mobile application ..	688
Passing attributes	691
Integrate video calling into your custom agent desktop	697
Set up your customer's chat experience	700
More resources	700
Add a chat user interface to your website	701
Integrate chat into a mobile application	749
Create quick responses	760
Enable text formatting	773
Enable message <i>Delivered</i> and <i>Read</i> receipts	780

Set up chat timeouts	781
Enable persistent chat	785
Enable Apple Messages for Business	792
Enable real-time message streaming	821
Customize chat flow experiences	829
Set up SMS messaging	832
Step 1: Request a number in Amazon Pinpoint SMS	833
Step 2: Enable two-way SMS on the phone number	835
Step 3: Update flows to branch on SMS contacts	837
Step 4: Test sending and receiving SMS messages	839
Next steps	840
Upgrade to the latest CCP	841
Upgrade on your own schedule, before your automatic upgrade date	841
Upgrade later, automatically	841
My CCP URL ends with /ccp#	842
I use the Amazon Connect Streams API	855
Provide access to the CCP	857
Steps to ensure agents can access the CCP	857
Agent application: Everything in one place	858
Grant microphone access in Chrome, Firefox, or Edge	858
How to get help for CCP issues	859
Headset and workstation requirements	859
Can't hear caller or caller can't hear agent?	861
Agents can't hear indicator for incoming chat?	862
Embed a custom CCP	863
Using Amazon Connect with third-party cookies	863
Embed CCP into Salesforce	864
Embed CCP into Zendesk	864
Set up Amazon Connect Global Resiliency	865
Global Resiliency requirements	866
Get started	867
How to set up Amazon Connect Global Resiliency	867
Create a replica of your existing Amazon Connect instance	868
Create traffic distribution groups	873
Claim phone numbers to traffic distribution groups	875
Assign claimed phone numbers to traffic distribution groups	878

Update telephony traffic distribution across AWS Regions	880
Set up your agent's experience	881
Manage traffic distribution groups	892
List traffic distribution groups	892
Delete traffic distribution groups	892
Manage phone numbers across Regions	893
Claim phone numbers to instances across multiple AWS Regions	893
Move a claimed phone number to multiple instances across AWS Regions	894
Release numbers from traffic distribution groups	894
Manage chat across Regions	895
Configure the communication widget in the replica instance	896
Option to add more seamlessness	897
Set up your network	898
Option 1 (recommended): Replace Amazon EC2 and CloudFront IP range requirements with a domain allowlist	899
NLB endpoints	907
Option 2 (not recommended): Allow IP address ranges	909
About Amazon Connect IP address ranges	910
Stateless firewalls	911
Allow upload of time-off balances and allowances in Amazon Connect scheduling	911
Allow DNS resolution for softphones	912
Port and protocol considerations	912
Region selection considerations	913
Agents using Amazon Connect remotely	914
Rerouting audio	914
Using AWS Direct Connect	914
Agent workstation networking requirements for web calling voice/video	915
Detailed Network Paths	916
Voice calls	916
Authentication	918
Use Amazon Connect in a VDI environment	918
Use a split CCP model	919
Citrix cloud desktops	920
Things to consider when designing your VDI environment	920
Amazon Connect audio optimization for Citrix cloud desktops step-by-step guide	921
CCP connectivity	924

Use an allowlist for integrated applications	926
Update your domain	927
Custom code and integrations	928
Firewall allow list	930
About the Amazon Connect access URL and emergency login	930
Personal settings	931
Transport Layer Security (TLS)	932
Create flows	933
Required permissions	933
Default flows	934
Change a default flow	935
Default agent hold	939
Default agent transfer	941
Default customer queue	941
Default customer whisper	944
Default agent whisper	944
Set the default whisper flow for chat	945
Default customer hold	946
Default outbound	947
Default queue transfer	947
Default prompts from Amazon Lex	948
Sample flows	948
Sample inbound flow	949
Sample AB test	950
Sample customer queue priority	951
Sample disconnect flow	952
Sample queue configurations	953
Sample queue customer	956
Sample queued callback	957
Sample interruptible queue flow with callback	958
Sample Lambda integration	958
Sample recording behavior	959
Sample note for screenpop	960
Sample secure input with agent	960
Sample secure input with no agent	961
Flow block definitions	962

Supported channels for flow blocks	968
Amazon Q in Connect	971
Call phone number	974
Cases	977
Change routing priority / age	990
Check call progress	993
Check contact attributes	995
Check hours of operation	1000
Check queue status	1002
Check Voice ID	1005
Check staffing	1009
Contact tags	1012
Create persistent contact association	1015
Create task	1018
Customer profiles	1023
Disconnect / hang up	1045
Distribute by percentage	1046
End flow / Resume	1048
Get customer input	1050
Get queue metrics	1068
Hold customer or agent	1072
Invoke AWS Lambda function	1074
Invoke module	1077
Loop	1078
Loop prompts	1080
Play prompt	1083
Resume contact	1094
Return (from module)	1097
Set callback number	1100
Set contact attributes	1102
Set customer queue flow	1107
Set disconnect flow	1109
Set event flow	1112
Set hold flow	1115
Set logging behavior	1117
Set recording and analytics behavior	1118

Set routing criteria	1122
Set Voice ID	1131
Set voice	1136
Set whisper flow	1139
Set working queue	1142
Show view	1145
Start media streaming	1160
Stop media streaming	1162
Store customer input	1164
Transfer to agent (beta)	1169
Transfer to flow	1170
Transfer to phone number	1172
Transfer to queue	1177
Wait	1186
Create a flow	1189
Before you begin: develop a naming convention	1190
Choose a flow type	1190
Create an inbound flow	1193
Tag flows and flow modules	1195
Use the mini-map to navigate a flow	1198
Customize the name of a block	1199
Undo and redo history	1201
Add notes to a block	1202
Copy and paste flows	1204
Archive, delete, and restore flows	1206
Generate logs	1209
Roll back a flow	1210
Contact initiation methods and flow types	1211
Associate a phone number with a flow	1216
Flow modules	1217
Where you can use modules	1218
Limitations	1218
Security profile permissions for modules	1219
Create a module	1219
Add a module to a flow	1219
Example module	1219

Create prompts	1220
How to create prompts	1221
Supported file types	1222
Maximum length for prompts	1222
Bulk upload of prompts not supported in UI, API, or CLI	1222
Add text-to-speech to prompts	1223
Create dynamic text strings in Play prompt blocks	1225
Dynamically select which prompts to play	1226
Set up prompts to play from an S3 bucket	1228
Choose the voice for audio prompts	1231
Use SSML tags to personalize text-to-speech	1232
SSML tags aren't interpreted in chats	1232
SSML tags supported by Amazon Connect	1233
Set up contact transfers	1235
Overview of steps	1235
Create quick connects	1235
Delete quick connects	1240
How quick connects work	1241
Set up agent-to-agent transfers	1244
Resume a flow after transfer	1247
Manage contacts in a queue	1249
Transfer contacts to agent queue	1251
Set up recording behavior	1253
When is a conversation recorded?	1254
Where are recordings stored?	1254
When are recordings available?	1255
Prevent agents from accessing recordings	1256
Headset requirements	1256
How to set up recording behavior	1256
How to set up users	1258
How to set up S3 Object Lock for immutable call recordings	1258
Set up queued callback	1261
How callbacks keep their place in queue	1261
Steps to set up queued callback	1262
The routing process	1262
How queued callbacks affect queue limits	1263

Create a flow for queued callbacks	1263
Learn more about queued callbacks	1269
Import/export flows	1269
Export limitations	1270
Flows are exported to JSON files	1270
How to import/export flows	1270
Resolve resources in imported contact flows	1271
Add an Amazon Lex bot	1272
Create an Amazon Lex bot	1273
Configure the Amazon Lex bot	1274
Build and test the Amazon Lex bot	1279
Create a bot version (Optional)	1282
Create an alias for the bot	1283
Add the Amazon Lex bot to your Amazon Connect instance	1284
Create a flow and add your Amazon Lex bot	1286
Assign the flow to a phone number	1290
Try it!	1291
Add interactive messages to chat	1291
Invoke Lambda functions	1340
Create a Lambda function	1341
Add a function to your instance	1341
Invoke a Lambda from a flow	1343
Configure your function to parse the event	1347
Verify the function response	1348
Consume the response	1351
Tutorial: Create a Lambda function and invoke in a flow	1354
Live media streaming of customer audio	1366
Plan for live media streaming	1366
Enable live media streaming	1368
Access Kinesis Video Streams Data	1368
Test live media streaming	1369
Contact attributes for live media streaming	1370
Encrypt customer input	1371
How to decrypt data encrypted by Amazon Connect	1372
Track events in flows	1374
Storage for flow logs	1374

Enable flow logs	1375
Search flow logs	1377
Data in flow logs	1379
Track customers between flows	1380
Create alerts for flow log events	1381
Use contact attributes	1381
What is a contact attribute?	1381
List of attributes and their JSONPath reference	1385
How to reference contact attributes	1428
Display contact information to the agent	1429
Route based on number of contacts in a queue	1430
Route based on contact's channel	1434
Use Amazon Lex and attributes	1435
Lambda functions and attributes	1439
Migrate flows	1441
Real-time and historical metrics, dashboards, and reports	1443
Dashboards	1444
Get started	1445
Save, download, and share your dashboard	1445
Use the required filters	1447
Contact Lens conversational analytics dashboard	1447
Flows performance dashboard	1454
Outbound campaigns performance dashboard	1459
Queue performance dashboard	1465
Assign security profile permissions	1467
Real-time metrics reports	1468
Real-time metrics definitions	1469
Required permissions	1485
Real-time metrics tag-based access control	1486
How often real-time metrics refresh	1492
Use one-click drill-downs	1493
Visualize: Queue dashboard	1496
View contacts in queue	1497
Create a real-time metrics report	1500
No metrics or too few rows?	1502
List queues by routing profile	1503

List agents by routing profile	1503
Sort agents by activity	1504
Change an agent's activity status	1505
Download a real-time metrics report	1508
Historical metrics reports	1509
Historical metrics definitions	1510
Required permissions	1550
Tag-based access control	1551
Create a historical metrics report	1553
Report limits	1556
Schedule a historical metrics report	1557
Update a historical metrics report	1560
Download a historical metrics report	1560
Show agent queues in a Queues table	1562
How many contacts in queue on a specific date	1564
Agent activity audit report	1564
Login/Logout reports	1569
Report limit	1569
Required permissions	1570
Generate a Login/Logout report	1570
Edit a Saved Login/Logout Report	1572
Download a Login/Logout report as a CSV File	1572
Share a Login/Logout report	1572
Schedule a Login/Logout report	1573
Delete a Saved Login/Logout report	1574
Tag-based access control	1575
Agent event streams	1575
Enable agent event streams	1575
Sample agent event stream	1576
Determine how long an agent spends doing ACW	1580
Agent event streams data model	1587
Contact events	1598
Subscribe to Amazon Connect contact events	1598
Contact events data model	1601
Contact timestamps	1611
Sample to stop streaming an event type	1612

Sample contact event for when a voice call is connected to an agent	1613
Sample contact event for when a voice call is disconnected	1614
Sample contact data updated event	1616
Sample contact event for when a voice call is connected to an agent	1618
Sample event for when routing step expires on a contact	1620
Sample contact event for when a voice call is connected to an agent provided by the customer using routing criteria	1622
Contact records data model	1623
Important things to know	1623
Agent	1624
AgentHierarchyGroup	1626
AgentHierarchyGroups	1627
AttributeCondition	1628
ContactDetails	1629
ContactTraceRecord	1629
DeviceInfo	1638
DisconnectDetails	1639
Endpoint	1639
Expiry	1640
Expression	1640
ExternalThirdParty	1641
MediaStream	1641
QualityMetrics	1641
QueueInfo	1642
RecordingInfo	1643
RecordingsInfo	1643
References	1645
RoutingCriteria	1645
RoutingProfile	1646
StateTransitions	1646
Steps	1647
VoiceldResult	1647
WisdomInfo	1648
Authentication	1648
FraudDetection	1649
How to identify abandoned contacts	1651

View a contact record in the UI	1651
About agent status	1652
About custom agent statuses	1653
About ACW (After contact work)	1653
How do you know when an agent can handle another contact?	1654
What appears in the real-time metrics report?	1654
What appears in the agent event stream?	1654
"We couldn't find this agent. Use the agent's user name to identify them."	1654
About contact states	1655
Contact states in the agent event stream	1655
Events in the contact record	1657
About queued callbacks	1658
How properties in the Transfer to Queue block affect this flow	1178
Scheduled vs In queue	1660
Failed callback attempts	1662
Example: Metrics for a queued callback	1663
Save custom reports	1666
Personal saved reports count towards quota	1666
Create a naming convention	1666
How to save reports	1666
How to delete saved reports	1667
Share custom reports	1668
View a shared report	1670
Tips for viewing a shared report	1671
Publish reports	1671
View published reports	1672
Manage saved reports (admin)	1673
View and delete reports	1673
Monitor CloudWatch metrics	1674
Amazon Connect metrics sent to CloudWatch	1675
Amazon Connect CloudWatch metrics dimensions	1687
Amazon Connect Voice ID metrics sent to CloudWatch	1689
Amazon Connect Voice ID metrics dimensions	1691
Amazon AppIntegrations metrics sent to CloudWatch	1692
Amazon AppIntegrations metric dimensions	1694
Amazon Connect Customer Profiles metrics	1694

Amazon Connect Customer Profiles metric dimensions	1695
Use CloudWatch metrics to calculate concurrent call quota	1695
Use CloudWatch metrics to calculate concurrent active chats quota	1696
Use CloudWatch metrics to calculate concurrent task quota	1696
Logging service API calls	1696
Amazon Connect information in CloudTrail	1697
Example: Amazon Connect log file entries	1698
Example: Amazon Connect Voice ID log file entries	1699
EventBridge events emitted by Amazon Connect	1701
Analytics data lake	1701
Access Analytics data lake	1702
Associate tables for Analytics data lake	1705
Manage access to Resource link tables	1708
Data Type Definitions	1712
Data retention	1764
Agent Workspace	1765
Step-by-step Guides	1767
Overview	1767
Complex JSON Object support	1767
Enable step-by-step guides	1768
View resource	1769
Custom views	1769
AWS managed views	1773
HTML and JSX support	1793
No-code UI builder	1794
Accessing the no-code UI builder	1794
UI component library	1795
Customize panel	1798
Setting actions that appear in flows	1809
Saving and publishing view versions	1811
Templates to get started quickly	1811
Screen pop applications	1813
Sample data	1815
How to invoke a guide at the start of a contact	1816
How to deploy step-by-step guides in chats	1818
Enable step-by-step Guides in Amazon Connect chats	1818

Display contact attributes in the agent workspace	1820
Disposition codes	1820
PII Redaction	1822
Third-party applications	1823
Onboard third-party applications	1823
Assign permissions	1830
Events and Requests	1832
Access third-party applications in the agent workspace	1833
Third-party application SSO Federation setup	1836
Amazon Q in Connect	1838
Enable Amazon Q in Connect	1839
Supported content types	1840
Integration overview	1840
Before you begin	1841
Step 1: Create an Amazon Q in Connect domain	1843
Step 2: Encrypt the domain	1844
Step 3: Create an integration (knowledge base)	1849
Step 4: Configure your flow for Amazon Q in Connect	1856
When was your knowledge base last updated?	1857
Integrate with step-by-step guides	1857
Step 1: Identify the resources you want to integrate	1857
Step 2: Associate the step-by-step guide with the content	1860
Assign permissions	1861
Access Amazon Q in Connect in the agent application	1862
Cases	1863
Getting started with Cases	1863
Enable Cases	1864
Requirements	1864
How to enable Cases	1865
Next steps	1865
Assign permissions	1866
Required Cases permissions	1866
Required Customer Profiles permissions	1867
Required queue, quick connect, and user view permissions	1867
Description of Cases permissions	1868
Required permissions for custom IAM policies	1869

View Cases domain details	1869
Onboard to Cases	1871
Create case fields	1874
How to create case fields	1875
System case fields	1875
Custom case fields	1879
Create case templates	1881
How case templates look in the agent application	1881
How to create a template	1883
Case layouts	1884
Set up case assignment	1885
Set up agents and flows	1886
How agents assign case ownership	1886
How to configure the Cases block to assign case ownership in a flow	1889
Access Cases in the agent application	1890
Option 1: Use Cases with the CCP out-of-the-box	1890
Option 2: Embed Cases into a custom agent application	1890
Case event streams	1891
Set up case event streams	1891
Case event payload and schema	1895
Contact Lens	1899
Analyze conversations using conversational analytics	1900
Sample Contact details page for a call	1901
Sample Contact details page for real-time chat analytics	1902
Sample Contact details page for post-chat analytics	1902
Enable Contact Lens	1905
Assign permissions	1918
Contact Lens notification types	1923
Add custom vocabularies	1924
Create rules with Contact Lens	1928
Amazon Connect Cases - rules integration onboarding	1990
Create alerts on real-time metrics	1993
Monitor and update cases	1997
Search conversations	2002
Review analyzed conversations	2009
Quickly navigate transcripts and audio	2011

View generative AI-powered post-contact summaries	2014
View key highlights	2018
Use theme detection to discover issues	2020
Investigate sentiment scores	2023
Investigate non-talk time	2024
Investigate response time	2026
Investigate loudness scores	2027
Use sensitive data redaction	2028
Use the API for real-time call and chat analytics	2030
Use streaming for real-time contact analysis	2031
Output file locations	2053
Call: Example Contact Lens output files	2054
Chat: Example Contact Lens output files	2071
Troubleshoot	2114
Evaluate agent performance	2115
Create an evaluation form with a title	2117
View an evaluation form audit trail	2128
Evaluate performance using generative AI (preview)	2129
How scoring and weights work	2133
Create supervisor alerts on agent performance	2136
Search evaluation forms	2140
Use reference ID for questions	2141
Example evaluation form output	2141
Assign permissions for evaluation forms	2151
Set up and review agent screen recordings	2151
Amazon Connect Client Application	2154
Enable screen recording	2155
Download log files for the screen recording app	2160
Assign permissions	2161
Review agent screen recordings	2162
FAQ for screen recording capabilities	2165
Search for contacts	2168
Important things to know	2168
Key search features	2168
Required permissions	2171
How to search for a contact	2173

Additional fields: Add columns to your search results	2173
Download search results	2174
Search for in-progress contacts	2174
Search by custom contact attributes	2177
Monitor live & recorded conversations	2180
Set up live monitoring for voice and/or chat	2181
Assign permissions	2183
Monitor live conversations	2184
Barge live voice and chat conversations	2186
Review recorded conversations	2192
Troubleshoot monitoring conversations	2201
Manage contacts from the Contact details page	2209
Transfer contacts	2209
Reschedule contacts	2212
End contacts	2214
Customer Profiles	2216
What is a customer profile?	2217
Data storage	2217
Enable Customer Profiles for your instance	2218
Before you begin	2218
Enable Customer Profiles, and specify a dead-letter queue and KMS key	2221
Next steps	2231
Access Customer Profiles in the agent workspace	2231
Option 1: Use Customer Profiles with the CCP out-of-the-box	2231
Option 2: Embed Customer Profiles into a custom agent workspace	2233
Use contact attributes to autopopulate customer profiles	2234
Automatically associate a customer profile with a contact	2235
Assign permissions	2236
How update permissions for agents	2236
How update permissions for Flows	2237
How update permissions for Calculated Attributes	2237
Issue with permissions: How to assign new permissions	2238
Use Identity Resolution to consolidate similar profiles	2241
Enable Identity Resolution	2242
Machine learning for Identity Resolution	2245
Rule-based matching for Identity Resolution	2256

Identity Resolution metrics	2269
Disable Identity Resolution	2271
Integrate external applications	2271
Set up integrations	2272
Set up integration for featured applications in Amazon Connect	2272
Set up integration for external applications using Amazon AppFlow	2298
Delete/stop Customer Profiles integrations	2312
Object type mapping	2313
Concepts and terminology for customer object type mappings	2313
Create an object type mapping	2314
Object type mapping definition details	2323
Additional properties of object types	2384
Inferred profiles	2385
Contact record templates	2385
Automatically associate the Contact Record with one profile found using the <code>_phone</code> key	2390
Examples of object type mappings	2391
Implicit profile object types	2395
Generative AI powered data mapping	2395
Customer Profiles data limits	2401
Create and ingest customer data using Amazon S3	2404
Set up real-time export	2405
Enable real-time export	2405
Enable real-time export	2406
Real-time export Kinesis payload	2407
Real-time export troubleshooting	2409
Delete Customer Profiles domain	2411
Customer Profiles Calculated Attributes	2412
Calculated Attributes APIs	2413
Creating a custom calculated attribute definition	2428
Validating calculated attribute values using the API	2431
Default Calculated Attributes	2433
Error state and troubleshooting	2438
Amazon Connect admin website	2438
How to create Calculated Attributes	2438
How to view Calculated Attributes	2442

How to edit Calculated Attributes	2443
How to delete Calculated Attributes	2445
Use the Customer Profiles API	2445
Example: Integrate with S3	2446
Forecasting, capacity planning, and scheduling	2449
Get started	2450
Enable forecasting, capacity planning, and scheduling	2450
Assign permissions	2453
Troubleshooting forecasting, capacity planning, and scheduling	2454
Forecasting	2463
Getting started with forecasting	2464
Set the forecast and scheduling interval	2465
Set the forecast time zone	2466
Create forecast groups	2468
Import historical data	2471
Data requirements for forecasting	2476
Create forecasts	2477
Inspect a forecast	2479
Download a forecast	2480
Override a forecast	2481
Publish a forecast	2483
Capacity planning	2484
Getting started	2485
Create capacity planning scenarios	2486
Import estimated future shrinkage and available full-time employees	2488
Create capacity plans using forecasts and scenarios	2489
Review capacity plan output	2491
Override a capacity plan	2492
Re-run a capacity plan	2494
Download a capacity plan	2495
Publish a capacity plan	2497
Scheduling	2497
Getting started	2498
Scheduling roles: Who does what	2498
Terminology	2499
Create staff rules	2500

Create shift activities	2503
Create shift profiles	2505
Create staffing groups and rules	2508
Generate, review, and publish a schedule	2511
How supervisors view published schedules	2516
How agents view their schedule	2519
Add shift activities in draft or published schedules	2520
Time off management	2524
Overtime management	2538
Voluntary time off management	2541
Schedule Adherence	2544
Private optimization APIs	2549
Voice ID	2551
How Voice ID works	2551
Customer enrollment	2551
Customer authentication	2552
How much speech is needed for enrollment and authentication	2552
Batch enrollment	2552
Known fraudster detection	2553
Default watchlist	2553
Voice spoofing detection	2553
What data is stored?	2554
Voice ID domains	2554
Enrollment status	2557
Expired speakers	2557
Speaker and fraudster identifiers	2557
Enable Voice ID	2558
Before you begin	2558
Step 1: Read the BIPA Consent Acknowledgement	2559
Step 2: Create a new Voice ID domain and encryption key	2560
Step 3: Configure Voice ID in your flow	2563
Assign permissions	2564
Search and review Voice ID results	2565
Voice ID results in a contact record	2566
Use the Voice ID APIs	2567
Voice ID domain operations	2567

Amazon Connect Integration Association APIs	2568
Speaker, watchlist, and fraudster management APIs	2569
Batch enrollment using audio data from prior calls	2571
File schema for Speaker Enrollment Job	2572
Create and edit a fraudster watchlist	2575
File schema for Fraudster Registration Job	2577
Amazon Connect Streams Voice ID APIs	2580
Voice ID event schema	2580
Common fields in the event	2580
Start Session Action	2581
Update Session Action	2582
Evaluate Session Action	2583
Speaker Action	2584
Fraudster Action	2585
EnrollBySession	2585
StartSpeakerEnrollmentJob	2586
StartFraudsterRegistrationJob	2587
Security	2589
Data protection	2590
Data handled by Amazon Connect	2591
Encryption at rest	2596
Encryption in transit	2609
Key management	2609
VPC endpoints (AWS PrivateLink)	2610
Opt out of using your data for service improvement	2612
Identity and access management	2613
Audience	2614
Authenticating with identities	2615
Managing access using policies	2618
Required permissions for custom IAM policies	2620
Restrict AWS resources that can be associated with Amazon Connect	2651
How Amazon Connect works with IAM	2655
Identity-based policy examples	2660
Resource-level policy examples	2671
AWS managed policies	2680
Troubleshooting	2712

Use service-linked roles	2713
Use service-linked roles for outbound campaigns	2720
Using service-linked roles for Amazon AppIntegrations	2722
Using service-linked roles for Amazon Connect Customer Profiles	2728
Using service-linked roles for Amazon Connect Managed Synchronization	2731
Logging and monitoring	2736
Tag resources	2737
Tag-based access control	2739
Compliance validation	2740
Best practices for PII compliance	2741
Best practices for PCI compliance	2741
Best practices for HIPAA compliance	2742
Resilience	2742
Single-region telephony and softphone architecture	2743
More resources	2744
Infrastructure security	2744
Supported versions of TLS	2744
Other requirements	2745
Cross-service confused deputy prevention	2745
Amazon Connect Customer Profiles	2746
Amazon Connect Voice ID	2748
Amazon Connect chat message streaming cross-service confused deputy prevention	2749
Security Best Practices	2750
Amazon Connect preventative security best practices	2750
Amazon Connect detective security best practices	2752
Amazon Connect Chat security best practices	2752
Agent training guide	2754
Training video	2757
Launch the CCP	2757
Log in and log out of CCP	2758
Problems logging in?	2760
Log out of CCP	2761
Allow access to cookies	2762
What happens if you don't choose Grant access when prompted?	2763
Change your audio device settings	2764
Change audio device settings in the CCP	2765

Prerequisite: Allow your browser to access your microphone	2766
Firefox limitations	2766
What to check when your audio device isn't working as expected	2767
Forward calls to a mobile device	2767
View your schedule	2768
Set your status to "Available"	2769
Set your "Next status"	2769
How to cancel "Next status"	2770
Set "Next status" while handling only ACW contacts	2771
Example 2: Set "Next status" while managing some chats on contact and other chats in ACW	2772
Work with calls in the CCP	2773
Accept incoming calls	2773
Transfer calls	2774
Host multi-party calls	2780
Make outbound calls	2785
View a call transcript during ACW	2786
Work with chats	2787
How to use the CCP to chat with contacts	2788
Search for quick responses in CCP	2793
Transfer chats to another queue	2795
How to use the CCP to make a call while on a chat	2797
Work with tasks	2802
Accept a task	2802
Create a new task	2805
Transfer a task	2808
Use Customer Profiles	2810
Accept incoming contacts with Customer Profiles	2812
Create a new customer profile in the agent workspace	2820
Search for a customer profile in the agent workspace	2823
Use Cases	2825
Search and view cases	2826
Add comments to a case	2828
Create a case	2829
Associate a contact with a case	2834
Edit a case	2835

Create a task from a case	2836
Use Amazon Q in Connect	2837
Search for content	2838
Use real-time recommendations	2841
Use Voice ID	2842
Enroll a caller in Voice ID	2843
Verification of an enrolled caller	2843
Caller has opted out	2844
Authentication status = Not authenticated	2844
Authentication status: Inconclusive	2845
Troubleshooting	2846
Use the Endpoint Test Utility	2846
Parameters to customize the Endpoint Test Utility	2847
Common Contact Control Panel (CCP) Issues	2847
Download CCP logs	2849
Troubleshooting Tools and Information	2850
Gathering Helpful Information using the Streams API	2851
Analyzing the Data	2852
Validation Testing	2853
Mobile devices are not supported	2856
Can't make outbound calls	2856
Attachments are not appearing	2857
Internal firewall settings are preventing access	2857
Attachments are too large, too many, or don't meet file type requirements	2857
Humming sound in headset	2858
Verify Firefox sample rate	2858
Verify Chrome sample rate	2858
One-way audio from customers?	2861
Release notes	2862
June 2024 Updates	2862
Amazon Connect outbound campaigns performance dashboard	2862
Route contact within a queue to a specific agent	2862
Amazon Q in Connect recommends step-by-step guides	2862
Updated look and feel for the Amazon Connect agent workspace	2863
May 2024 Updates	2863
Multi-party calls	2863

Amazon Connect supports multiple features in Apple Messages for Business	2863
Set the forecast time zone	2864
Updated AmazonConnectServiceLinkedRolePolicy service-linked role managed policy	2864
New flow and flow module analytics	2864
Create rules for monitoring flow metrics	2864
New Amazon Connect Cases APIs	2865
Amazon Connect Contact Lens provides generative AI-powered agent performance evaluations (Preview)	2865
New metrics available on the Historical metrics page	2865
April 2024 Updates	2866
New definitions for NextContactId and PreviousContactId	2866
Use screen recording with multiple agents connecting to the same desktop in your environment	2867
Voice contacts rejected by an agent have a state of REJECTED	2867
March 2024 Updates	2867
Contact Lens enables you to automatically fill and submit evaluations	2867
Amazon Connect allows you to create rich, interactive chat experiences for customers using step-by-step guides	2867
Amazon Connect agent workspace supports third-party applications in general availability	2867
GA for generative AI-powered post-contact summaries	2868
Hierarchy-based access control (Preview)	2868
February 2024 Updates	2868
Amazon Connect provides case management metrics	2868
Amazon Connect Cases provides audit history on cases	2869
January 2024 Updates	2869
GA for Amazon Connect outbound campaigns voice dialing API	2869
Barge for chat: Managers can join ongoing chats between agents and customers	2869
GetRecommendations and QueryAssistant APIs will be discontinued starting June 1, 2024	2869
High-quality voice experiences for agents using Citrix Virtual Desktop Infrastructure (VDI) environments.	2870
Granular access controls using resource tags for historical metrics reports	2870
December 2023 Updates	2870
Update to third-party applications preview	2870

Amazon Connect provides granular access controls using resource tags configured for hours of operation and prompts in the Amazon Connect admin website	2870
Amazon Connect provides an API to programmatically update the priority of contacts ...	2871
Route contacts according to the proficiency of agents	2871
Added Amazon Connect Cloudformation resources	2871
Amazon Connect Contact Lens provides an API to programmatically search for contacts	2871
Pause and resume tasks	2871
Manage your cases and set up escalation workflows using the rules designer in the Amazon Connect UI	2872
Get a more granular view of your Amazon Connect bill and usage	2872
Customer Profiles calculated attributes that turn customer data into actionable insights	2872
Contacts Answered/Abandoned in X	2872
November 2023 Updates	2873
Customer Profiles provides a generative AI powered customer data mapping capability .	2873
No-code UI builder for step-by-step guides	2873
Added Amazon Q in Connect	2873
Amazon Connect Contact Lens provides real-time conversational analytics for chat	2873
Amazon Connect Contact Lens provides generative AI-powered post-contact summaries (Preview)	2874
Amazon Connect supports in-app, web, and video calling	2874
Amazon Connect supports two-way SMS	2874
Analytics data lake (Preview)	2875
Added metrics to the GetMetricDataV2 action	2875
Customer Profiles block enhancements	2876
View and manage applied service quotas for Amazon Connect using AWS Service Quotas	2876
Added an action to AmazonConnectServiceLinkedRolePolicy	2876
Amazon Connect provides a Contact Lens conversational analytics dashboard	2877
Amazon Connect provides a pre-built queue performance dashboard	2877
Amazon Connect prompts configuration page provides CloudTrail coverage	2877
Amazon Connect enables integration with your preferred file scanning application to detect malware	2877
Amazon Connect outbound campaigns voice dialing API	2878
Amazon Connect Cases supports author name on comments	2878
Updated AmazonConnectCampaignsServiceLinkedRolePolicy service-linked role managed policy	2878

Added Create persistent chat association flow block and CreatePersistentContactAssociation API	2878
Optimization to how the CCP detects and handles stale WebSocket connections	2878
Added new service-linked role policy and service-linked role	2879
Added Contact Lens conversational analytics metrics to the GetMetricDataV2 API	2879
Added configuration management across AWS Regions for Amazon Connect Global Resiliency customers	2879
October 2023 Updates	2879
Added actions to AmazonConnectServiceLinkedRolePolicy	2879
Third-party applications preview	2880
Added actions to AmazonConnectServiceLinkedRolePolicy	2880
Added the UpdatePhoneNumberMetadata API	2880
Add as many as four access control tags to a single security profile	2880
Added actions to AmazonConnectServiceLinkedRolePolicy	2880
CTI Adapter upgrade for third-party cookies	2881
Create and customize up to 15 communications widgets	2881
Access the trailing 90 days of historical agent and contact metrics	2881
Added actions to AmazonConnectServiceLinkedRolePolicy	2881
September 2023 Updates	2882
Released Amazon Connect Client Application v1.0.2.38	2882
Added "View my contacts" permission	2882
Streams API upgrade for third-party cookies	2882
Create alerts on real-time metrics	2882
"Maximum contacts in queue" includes all channels	2882
Manage contacts from the Contact details page	2883
Upload file attachments to cases	2883
Search for in-progress contacts	2883
Subscribe to the Contact Data Updated event in the contact event stream	2883
APIs to programmatically configure views in step-by-step guides	2883
Support for UIFN in more than 60 countries	2883
August 2023 Updates	2884
Voice dialing for outbound campaigns, no agents required	2884
Amazon Connect Cases supports nine additional languages	2884
Granular access controls using resource tags for the agent activity audit report	2884
Enhanced user bulk edit	2884
Amazon Connect scheduling supports agent group activities	2884

GA for global sign-in and agent distribution capabilities	2885
100 rows on real-time metrics tables	2885
Sorting on column header names	2886
Route based on time since last inbound contact	2886
July 2023 Updates	2886
Customize the names of flow blocks	2886
Archive, restore, and delete flows and modules	2886
Undo and redo actions in the flow designer	2887
Add notes to a flow block	2887
Use the mini-map to navigate a flow	2888
Restrict attributes to specific flows	2888
Import time off balances	2888
Schedule flexible days and shift activities based on shift length	2889
Amazon Connect Customer Profiles supports rule-based matching and merging	2889
Released Amazon Connect Client Application v1.0.1.33	2889
Amazon Connect Cases provides case assignment	2889
Contact Lens Conversational Analytics metrics in the API	2890
Amazon Connect Wisdom supports real-time recommendations for chat conversations .	2890
Delete queues and routing profiles programmatically	2890
June 2023 Updates	2891
Agents can change their audio device settings in the CCP and agent workspace	2891
Amazon Connect Chat: New interactive message types	2891
GetMetricDataV2 API: Region availability and new functionality	2891
Search for existing tags within an Amazon Connect instance	2891
Added screen recording capabilities to Contact Lens	2892
Amazon Connect scheduling allows agents to manage time off requests	2892
Real-time data export of unified customer profiles to an Amazon Kinesis Data Stream ...	2892
May 2023 Updates	2892
Added theme detection to Contact Lens	2892
New APIs for managing prompts	2892
Added supervisor alerts on agent performance	2893
Interactive messages: Rich formatting in chat titles and subtitles	2893
April 2023 Updates	2893
GA for Amazon Connect evaluation capabilities	2893
New API: Use CreateParticipant to customize chat flow experiences	2893
Customer Profiles displays case information in the agent workspace	2894

Added Cross-channel concurrency	2894
Set Voice ID block supports fraud watchlist ID	2894
Search, sort, and filter published agent schedules	2894
March 2023 Updates	2894
Added Wisdom support for Microsoft SharePoint Online	2894
Create step-by-step guides for your agents	2895
Added support for nested JSON in Invoke AWS Lambda function flow block	2895
Added Show View flow block	2895
Added staff level shift profile	2895
Added support for multiple fraudster watchlists	2895
Search and sort schedules in the Schedule Manager	2895
Added the ability to configure multiple IAM roles that can be assigned to a single user when using SAML 2.0	2896
Added panel template for interactive chat messages	2896
Added GetMetricDataV2 API	2896
February 2023 Updates	2896
Added new attribute type ENHANCED_CONTACT_MONITORING to Describe, List and Update Instance Attribute APIs	2896
Added the DeleteDomain API for Cases	2896
Added RelatedContactId to StartTaskContact API	2897
Amazon Connect Cases integrates with AWS PrivateLink	2897
Added support for more granular access controls (using resource tags) to view real-time metrics for agents, queues, and routing profiles	2897
Added support to provide more granular permissions to metrics reports, including new permissions for real-time metrics, historical metrics, and agent activity audit	2897
Added support to provide visibility into an agent's next activity	2897
Apply S3 Object Lock for the call recordings bucket	2897
CloudFormation templates for instance management	2898
January 2023 Updates	2898
Added long lasting, persistent chat experiences	2898
December 2022 Updates	2898
Added message receipts feature for chat messages	2898
Updates to GetCurrentMetricData and GetCurrentUserData	2898
Added chat timeouts for chat participants	2899
Microsoft Edge Chromium support	2899
Amazon Connect supports JSON as a content type for chat messages	2899

Added topic on Amazon Connect availability by Region	2899
Contact Lens granular data redaction	2899
Additional Contact Lens language support and Region availability	2899
Released Barge to allow contact center managers to join ongoing calls	2900
Added user hierarchy to bulk user upload	2900
Granular access controls using resource tags for users, security profiles, routing profiles, and queues	2900
Bulk user import now includes agent hierarchy and tags	2900
Released Rules Function language	2900
GA for Rules APIs	2900
Search contacts by agent's first or last name is available in AWS GovCloud	2901
November 2022 Updates	2901
Create step-by-step guides for your agents	2901
GA for Forecasting, capacity planning, and scheduling	2901
Released Contact Lens evaluation forms for preview	2901
Released Contact Lens conversational analytics capabilities for Amazon Connect chat	2901
Added configurable Lex timeouts in chat	2902
Create rules that send email notifications	2902
Added MonitorContact API	2902
Manage saved reports (admin)	2902
Search for profiles using multiple search keys	2902
Delete quick connects using the Amazon Connect console	2903
Added DismissUserContact API	2903
October 2022 Updates	2903
Add secondary email address and mobile number to user accounts	2903
Emojis for chat messages	2903
Released support for Enhanced 911 (E911)	2903
GA for Amazon Connect Global Resiliency	2903
Added Ctrl+Shift+F to search flow block titles and metadata	2904
Released Amazon Connect Cases for General Availability	2904
September 2022 Updates	2905
Searching for a contact? Choose from a list of categories	2905
Updated flow designer	2905
Search for Amazon Connect users by first name, last name, login, and more	2911
Queue dashboard	2912
August 2022 Updates	2912

Contact search: Apply "Match any" or "Match all" to Contact Lens category searches	2912
Evaluate calls for voice spoofing	2912
.....	2912
.....	2912
July 2022 Updates	2912
.....	2912
Released updates for rich text format rendering	2914
View call transcript using the CCP or agent application	2914
June 2022 Updates	2915
Support for Lex intent confidence scores and sentiment analysis	2915
Metrics Updates	2915
.....	2916
New contact transferred related metrics	2917
Changes to real-time metrics agent tables	2917
Faster reload times for the Real-time metrics page	2918
Released Amazon Connect Cases (Preview)	2918
GA for Amazon Connect outbound campaigns	2918
Released GetCurrentUserData API	2918
Released task templates	2918
New API to transfer contacts	2918
May 2022 Updates	2919
Updated workflow for outbound campaigns	2919
Voice ID expires speakers	2919
April 2022 Updates	2919
New API to change an agent's current status	2919
New API to search for users by name, agent hierarchies, and tags	2919
New APIs to claim and configure phone numbers	2919
Multi-party calls	2920
Play prompts from an S3 bucket	2922
CloudTrail support for queues and routing profiles	2922
March 2022 Updates	2923
Rich messaging for chat	2923
Customer Profiles: Object type mapping user interface	2923
February 2022 Updates	2923
Added bulk ingestion of data for Customer Profiles	2923
New CloudWatch metrics for chat	2923

January 2022 Updates	2923
Configure maximum chat duration up to 7 days	2923
Add custom vocabularies to Contact Lens	2923
Earlier Updates	2924
December 2021 Updates	2924
November 2021 Updates	2924
October 2021 Updates	2926
September 2021 Updates	2927
August 2021 Updates	2928
July 2021 Updates	2928
June 2021 Updates	2932
May 2021 Updates	2933
April 2021 Updates	2934
March 2021 Updates	2935
February 2021 Updates	2938
January 2021 Updates	2943
December 2020 Updates	2944
November 2020 Updates	2946
October 2020 Updates	2947
September 2020 Updates	2948
August 2020 Updates	2949
July 2020 Updates	2950
June 2020 Updates	2951
May 2020 Update	2955
April 2020 Update	2955
March 2020 Update	2956
February 2020 Update	2956
January 2020 Update	2956
December 2019 Update	2957
November 2019 Update	2957
October 2019 Update	2963
June 2019 Update	2964
May 2019 Updates	2964
April 2019 Updates	2964
March 2019 Update	2965
February 2019 Updates	2965

January 2019 Updates	2966
December 2018 Updates	2967
November 2018 Updates	2968
October 2018 Updates	2969
September 2018 Updates	2970
August 2018 Updates	2970
July 2018 Updates	2971
June 2018 Updates	2972
April and May 2018 Updates	2973
Upcoming changes to the CCP	2975
How to preview the updated CCP	2976
Before and after examples of the visual refresh	2978
CCP on the Agent Workspace	2985
Document history	2986
Earlier updates	3093
Glossary	3102
Channel	3102
Contact attribute	3102
Flow	3102
Instance	3102
Letter of Authorization	3102
Losing carrier	3103
Mutually agreed date and time	3103
Omnichannel	3103
Phone number portability	3103
Queue	3103
Winning carrier	3103

What is Amazon Connect?

Amazon Connect is an AI-powered cloud contact center. It automatically detects customer issues, and provides agents with contextual customer information and suggested responses and actions for faster resolution of issues.

You can [set up a contact center](#) in a few steps, add agents who are located anywhere, and start engaging with your customers. Amazon Connect supports the following communication channels:

- Voice (phone)
- Chat/SMS
- Web calling/video
- Tasks

Features of Amazon Connect

Amazon Connect Agent Workspace

Out-of-the-box, the [agent workspace](#) integrates all of your agent facing capabilities on one page. For example, when an agent accepts a call, chat, or task, they receive necessary information about the case and customer, plus real-time recommendations.

The following image shows the agent workspace with callouts indicating the features on the page.

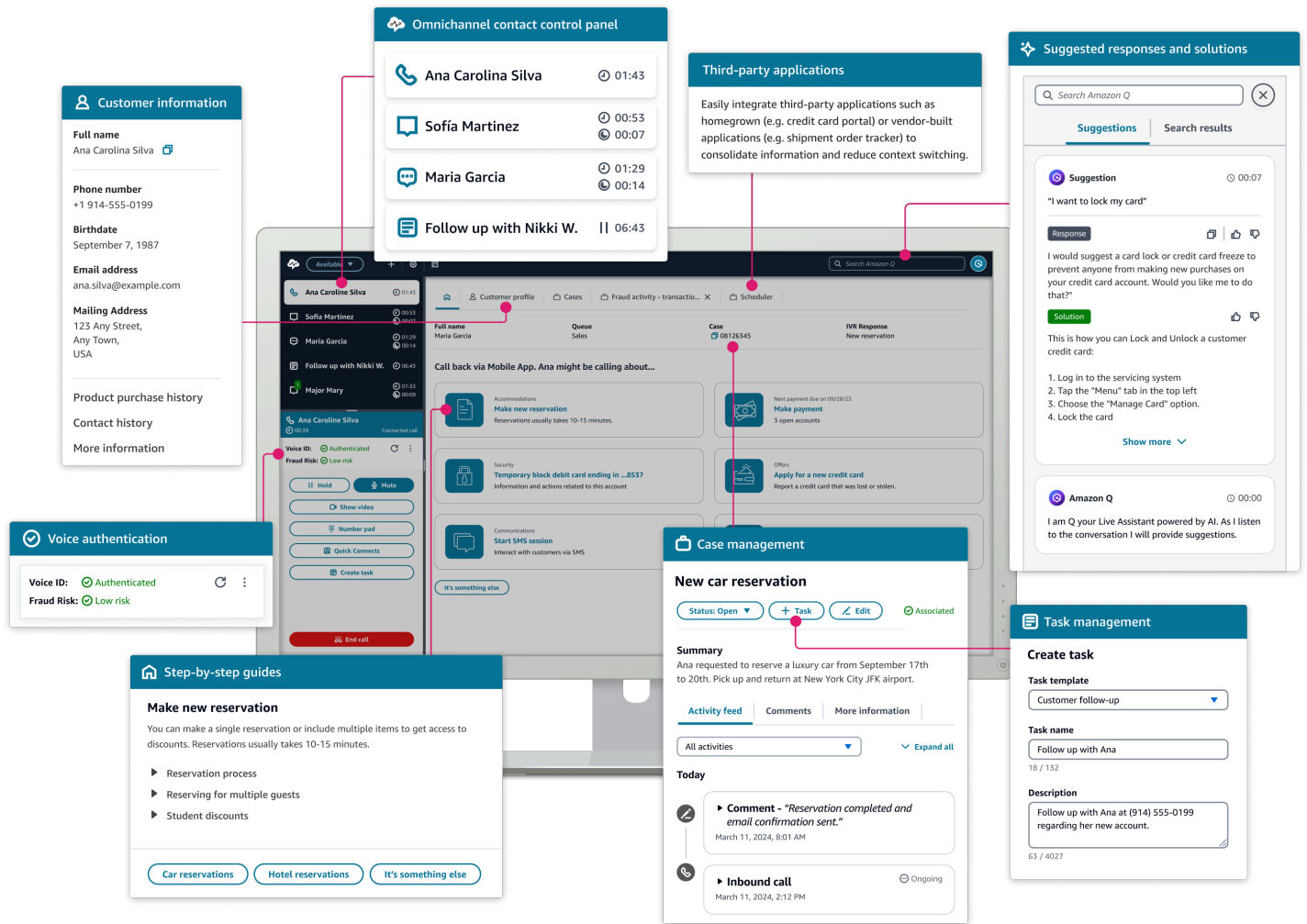

You can customize the agent workspace by creating [step-by-step guides](#) that suggest to agents what to do at a given moment during a customer interaction. For example, there are six step-by-step guides on the agent workspace in the following image.

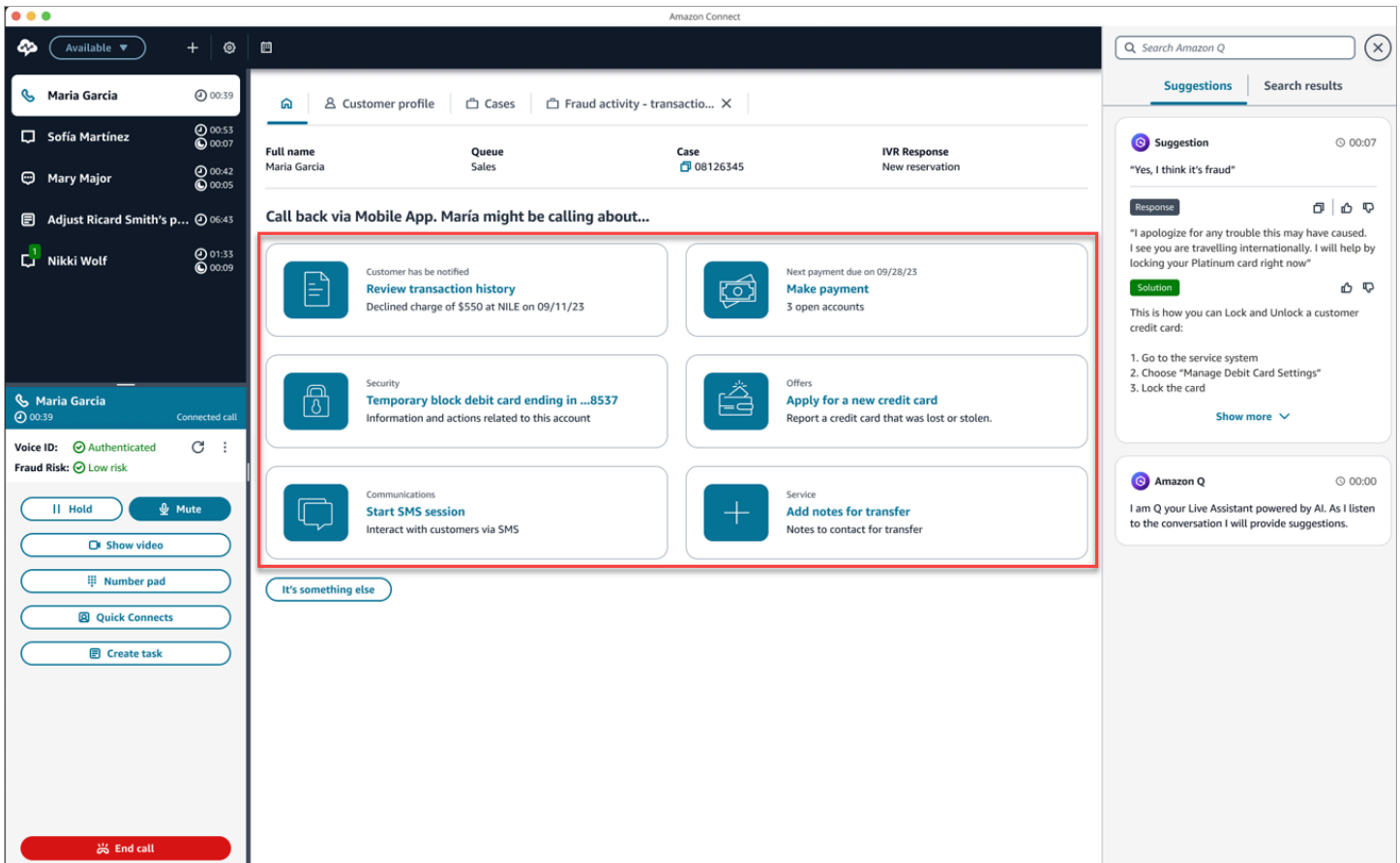

In the following image the **Review transaction history** guide is open, and the first step is displayed for the agent to choose **View transaction details** or **Choose a different account**.

The screenshot displays the Amazon Connect agent workspace. On the left, a sidebar lists agents: Maria Garcia (00:39), Sofia Martínez (00:53), Mary Major (00:42), Adjust Ricard Smith's p... (06:43), and Nikki Wolf (01:33). The main workspace shows a customer profile for Maria Garcia, with details like Full name, Queue (Sales), Case (08126345), and IVR Response (New reservation). A call log entry is highlighted with a red box, indicating a declined charge of \$550 at NILE on 09/11/23. Below this, a table shows transaction details for NILE Paris, with a declined status. The chat pane on the right features a suggestion from Amazon Q: "Yes, I think it's fraud" with a response and a solution for locking a Platinum card.

Amazon Connect chat and messaging

You can help customers through text-based communication channels, such as web chat, mobile chat, SMS, and third-party messaging apps, such as WhatsApp or Facebook Messenger. By using the [Amazon Connect chat and messaging](#) features, you can set up AI-powered chatbots and step-by-step guides so customers can self-serve. If customers need assistance, agents get all of the prior context from the self-service interactions to ensure a seamless transition.

In the following image of the agent workspace, the agent is on a chat with Nikki. At the bottom of the chat pane, the agent can search for [quick responses](#) that they can type in the chat. For example, they can type **brb** to respond in the chat with *Give me a couple of minutes while I investigate the issue.*

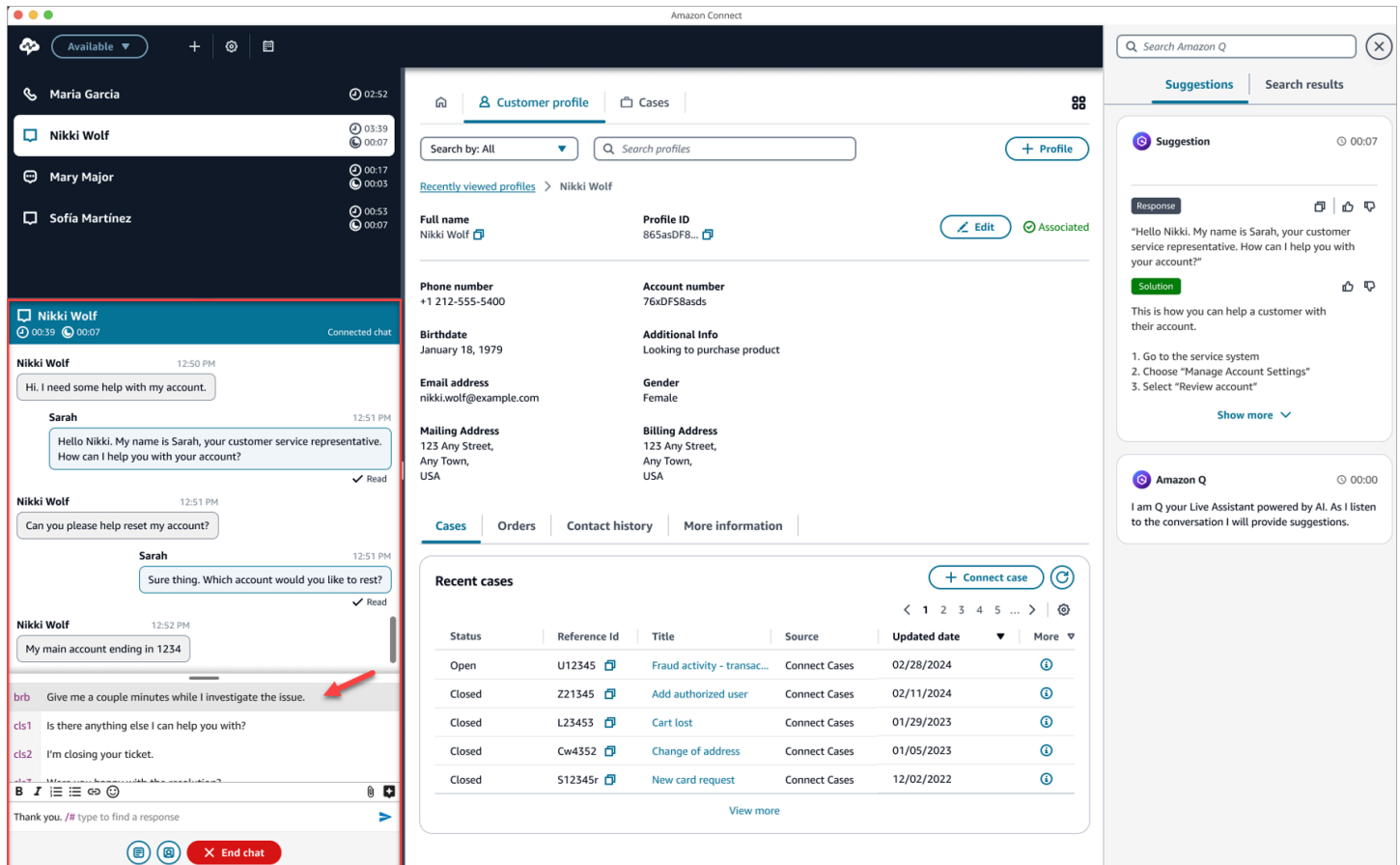

Amazon Connect Tasks

To ensure customer issues are quickly resolved, use [tasks](#) to prioritize, track, route, and automate agent tasks. Your agents can create and complete tasks in the same user interface where they take calls and chats. Managers can also use workflows to automate tasks that don't require agent interaction.

In the following image, the agent is creating a task for a contact named Maria, while at the same time on chats with Nikki and Mary. The agent also has a scheduled task to follow up with Maria.

The screenshot displays the Amazon Connect interface for a case titled "Fraud activity - transaction declined". On the left, a sidebar lists agents: Nikki Wolf, Maria Garcia, Mary Major, and James Murdoch. A "Create task" button is highlighted with a red arrow. The main content area shows the case details, including a summary, customer information, and an activity feed. A red box highlights an "Upcoming" task: "Tasks - Follow up with Maria" scheduled for March 12, 2024, at 11:00 AM. Other tasks in the feed include "John Doe - Explained to customer how they add travel plan before making international transactions." (Ongoing) and "Inbound call" (Completed).

Amazon Connect Contact Lens

You use Contact Lens to monitor, measure, and continuously improve contact quality and agent performance. You use it to perform the following tasks:

- [Analyze conversations using conversational analytics](#). You can uncover trends and improve customer service by understanding sentiment, conversation characteristics, emerging contact themes, and agent compliance risks.

The following image shows post-contact conversational analytics on the **Contact details** page. It includes a [generative AI-powered contact summary](#) to help you quickly understand essential information about the contact, how customer sentiment changes as the contact progresses, and the distribution of talk time between the agent and customer.

Contact details

Completed | Last updated: May 20, 2023

Actions Evaluations

Overview

Voice | Duration: 12 min 24 s (9:20 - 9:34 AM EST, Nov 20, 2022) | [Original contact](#) | [Previous contact](#) | [Next contact](#)

Queue: **BasicQueue** | Agent: janer (Roe, Jane) | Initiation method: Inbound | Disconnect reason: Customer disconnect | Customer phone number: +20 [REDACTED]

Summary Generated by AI

The customer wanted to book two suites at a hotel in Fresno, California for two nights from May 26th to May 28th. However, the agent did not have any suites available on those dates. The agent offered two king bedrooms instead at \$199 per night plus taxes and fees. But the customer thought the price was too high and decided to search for a better deal on their own.

Evaluations

Average for trailing four weeks (Feb 11, 2023 to Mar 4, 2023)

Metric	This contact	This agent avg.	All contacts avg.
Compliance	90%	~85%	~75%
Sales effectiveness	100%	~75%	~65%

Show 3 more

Conversational analytics

Customer sentiment trend

00:02:13

Customer sentiment

Sentiment	Percentage
Negative	33.3%
Positive	0%
Neutral	66.7%

Talk time

Category	Percentage
Agent talk time	16.1%
Customer talk time	17.8%
Non-talk time	66.1%

- [Evaluate agent performance](#). You can review conversations alongside contact details, recordings, transcripts, and summaries, without the need to switch applications. You can define and assess agent performance criteria (for example, script adherence, sensitive data collection, and customer greetings) and automatically pre-populate evaluation forms.

Managers can perform evaluations faster and more accurately with [generative AI-powered recommendations](#) for answers to questions in agent evaluation forms. For example, the following image shows the **Recording and transcript** section of the **Contact details** page. On the right side of the page is the evaluation, which includes generative AI-powered evaluation recommendations.

The screenshot displays the Amazon Connect interface for reviewing agent recordings. The top navigation bar includes 'Amazon Connect', 'Agent Workspace', and 'Contact Control Panel'. The main content area is titled 'Recording and transcript' and features a timeline with a bar chart showing agent activity. Below the timeline are 'Key highlights' (Issue, Outcome) and 'Categories' (hello-txt, helo-interruption). The transcript shows an agent greeting a customer and asking for assistance. A red arrow points from the transcript to a quality check panel on the right. The panel contains three questions: 1.5 'Did the agent properly greet the customer and introduce themselves?', 1.6 'When applicable, did the agent try to ask for more details to identify the problem the customer called about?', and 1.7 'Did the agent use inappropriate language?'. Each question has radio buttons for 'Yes', 'No', and 'Not Applicable', and an 'Ask AI' button.

- [Set up and review agent screen recordings](#). You can review agent actions handling customer contacts by reviewing screen recordings. This helps you ensure adherence to quality standards, compliance requirements, and best practices. It also helps you identify coaching opportunities and bottlenecks so you can streamline workflows.

Managers use the **Recording** section of the **Contact details** page to view the screen recording, as shown in the following image.

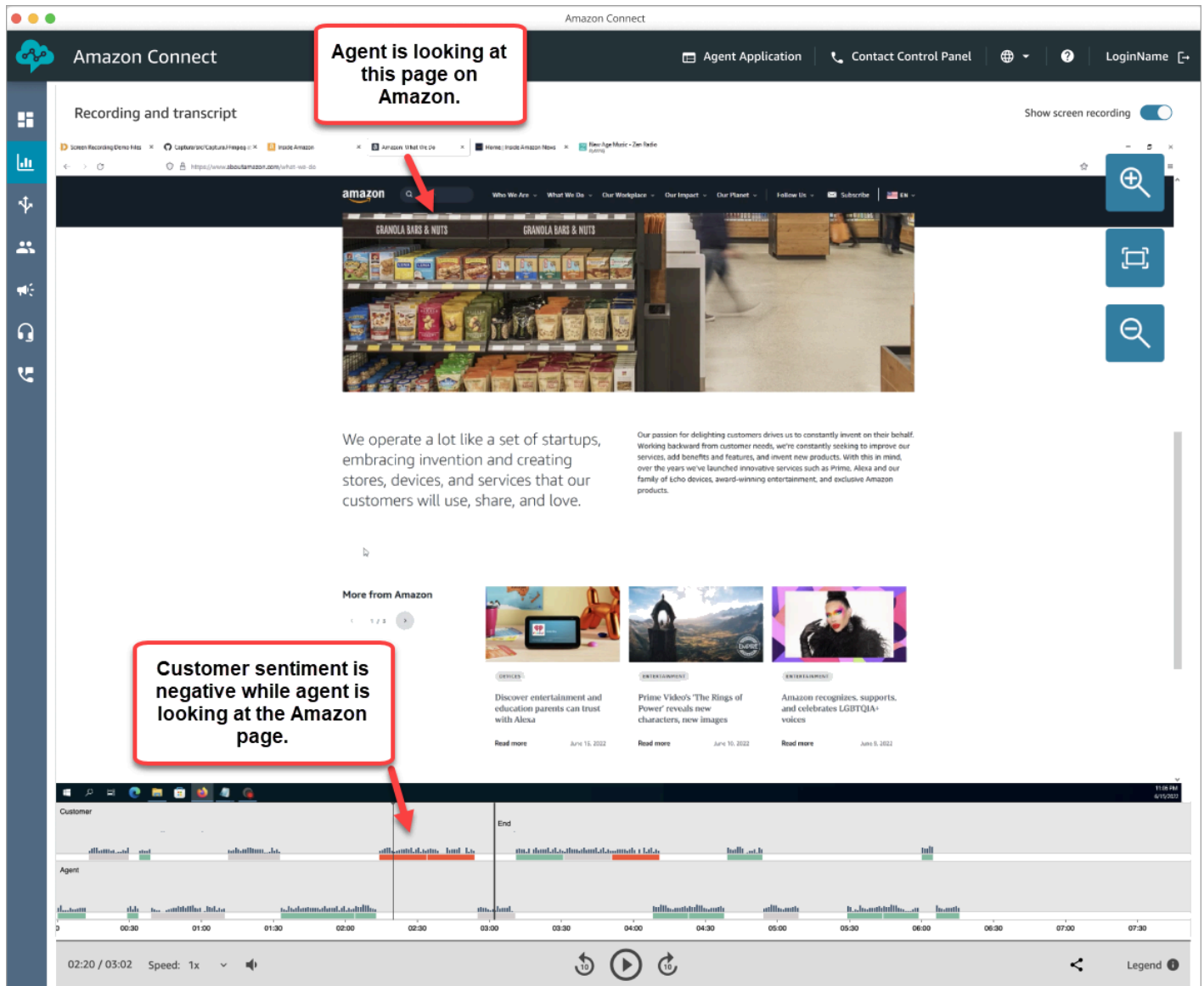

- [Search for contacts](#). You can search for contacts as far back as two years ago. Choose from an extensive list of filters to quickly find the contacts you need. For example, you can search by custom attributes specific to your business, such as MVP, and search for in progress contacts, as shown in the following image.

The screenshot shows the Amazon Connect interface with filters and a contact list. The filters section includes 'Time range: Initiated timestamp' set to 'August 17, 2023', 'Channel' set to 'All channels', and 'Contact status' set to 'Completed'. A dropdown menu for 'Contact status' is open, showing 'In progress' (checked) and 'Completed' (unchecked). A red arrow points to the 'In progress' option. The contact list below shows three contacts, all with a status of 'Completed'.

Contact ID	Channel	Contact status	Initiation timestamp
7dd1e384...	Voice	Completed	Aug 17, 2023, 01:28:16
8492ee4a...	Voice	Completed	Aug 17, 2023, 01:27:56 pm
7e1dcfb8...	Voice	Completed	Aug 17, 2023, 01:27:28 pm

Managers can view the **Contact details** page for an in progress contact, and the real-time transcript. In addition, they can [transfer](#), [reschedule](#), or [end](#) in-progress contacts.

- [Monitor live and recorded conversations](#). You can monitor live voice and chat conversations and barge live voice conversations. This is especially helpful for agents in training.

Managers use the Real-time metrics page to choose the contacts they want to monitor. For example, in the following image the manager can choose the eye icon to start monitoring the conversation.

The screenshot shows the 'Real-time metrics' page for 'Agents'. The table displays agent information including login, channels, status, duration, agent hierarchy, routing profile, and capacity. A red arrow points to the eye icon in the 'Voice' channel row for the first agent, indicating the option to monitor the conversation.

Agent login	Channels	Agents				
		Status	Duration	Agent hierarchy	Routing profile	Capacity
agent	All channels	On contact - barged	01:15:01	US/ West/ Dept A	RP name A	
	Voice					
	Chat total					
	Chat					
supervisor ram (IAM)	Voice	Barged	00:02:32	US/ West/ Dept A	RP name A	
loginname_c	All channels	On contact	00:28:13	US/ West/ Dept A	RP name B	

This takes them to CCP section of the agent workspace, as shown in the following image. They can monitor the call and toggle between the **Monitor** and **Barge** states. The following image shows the **Monitor** state.

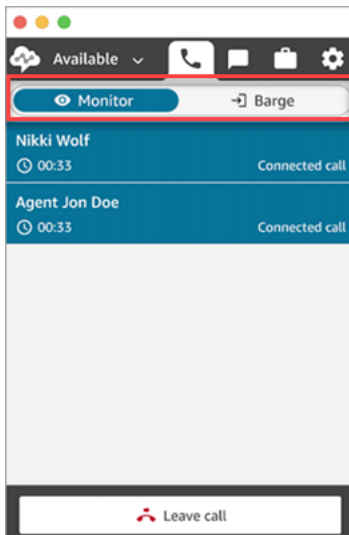

Amazon Q in Connect

You can use [Amazon Q in Connect](#) to automatically detect customer intent during calls and chats.

Amazon Q in Connect uses the real-time conversation with the customer, along with relevant company content, to automatically recommend what to say or what actions an agent should take to better assist the customer. Agents can also use natural language to search across connected knowledge sources to receive generated responses, recommended actions, and links to more information.

The following image shows how an article may appear in the agent application when the agent is on a call.

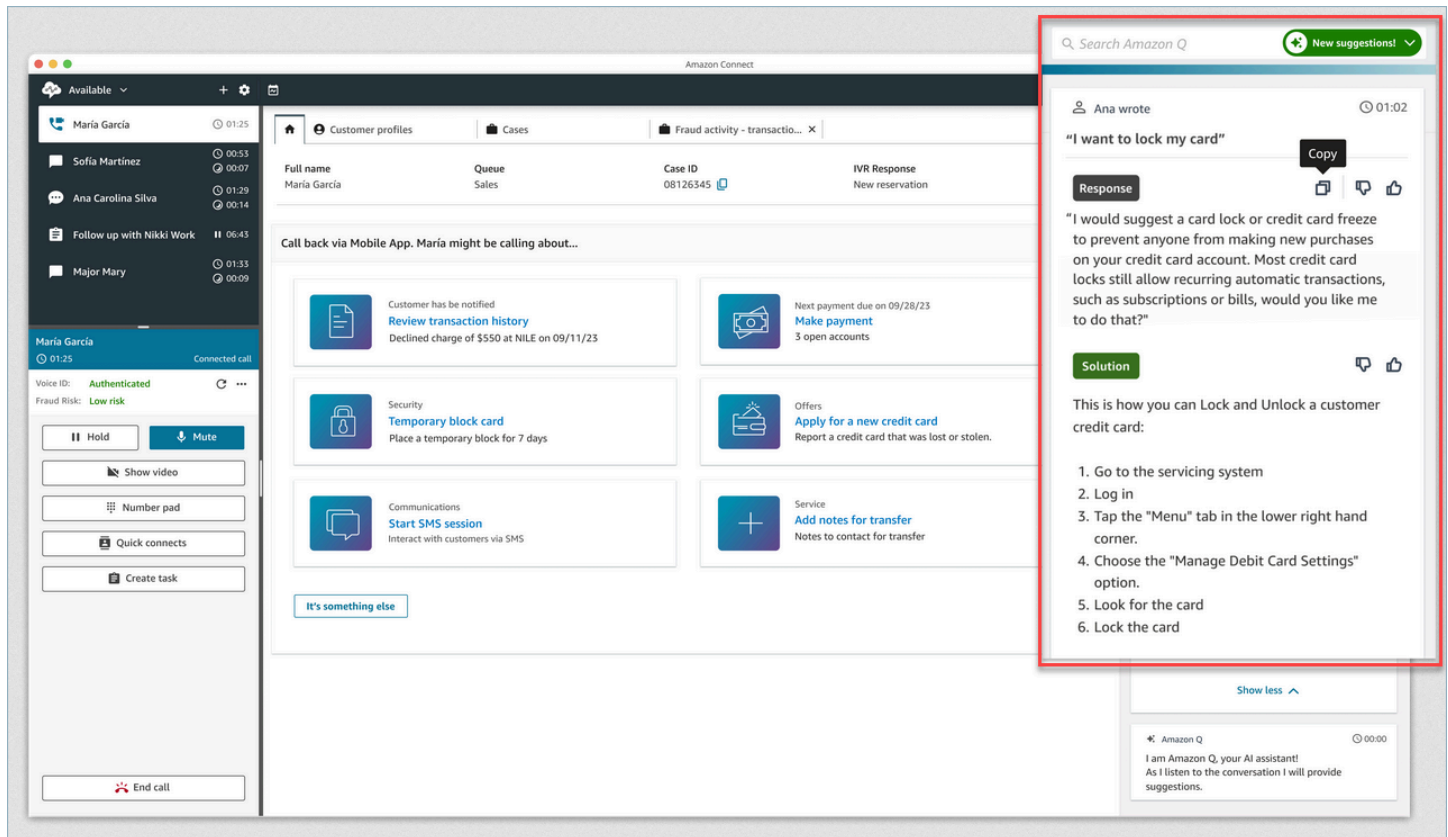

Forecasting, capacity planning, and scheduling

Forecasting, capacity planning, and scheduling are machine learning (ML)–powered features that help you predict, allocate, and verify that the right number of agents are scheduled at the right time. They help you meet your operational goals with minimal overstaffing. You can anticipate contact volume and arrival rates, convert forecasts into projected staffing needs, and assign daily shifts to the right number of agents.

- **Forecasting:** A forecast is the starting point for any scheduling and capacity planning activities. Before you can generate a schedule or capacity plan, you must create a corresponding forecast. A forecast attempts to predict future contact volume and average handle time. We use historical metrics to create the forecast.

Forecast data is displayed in graphs, as shown in the following image.

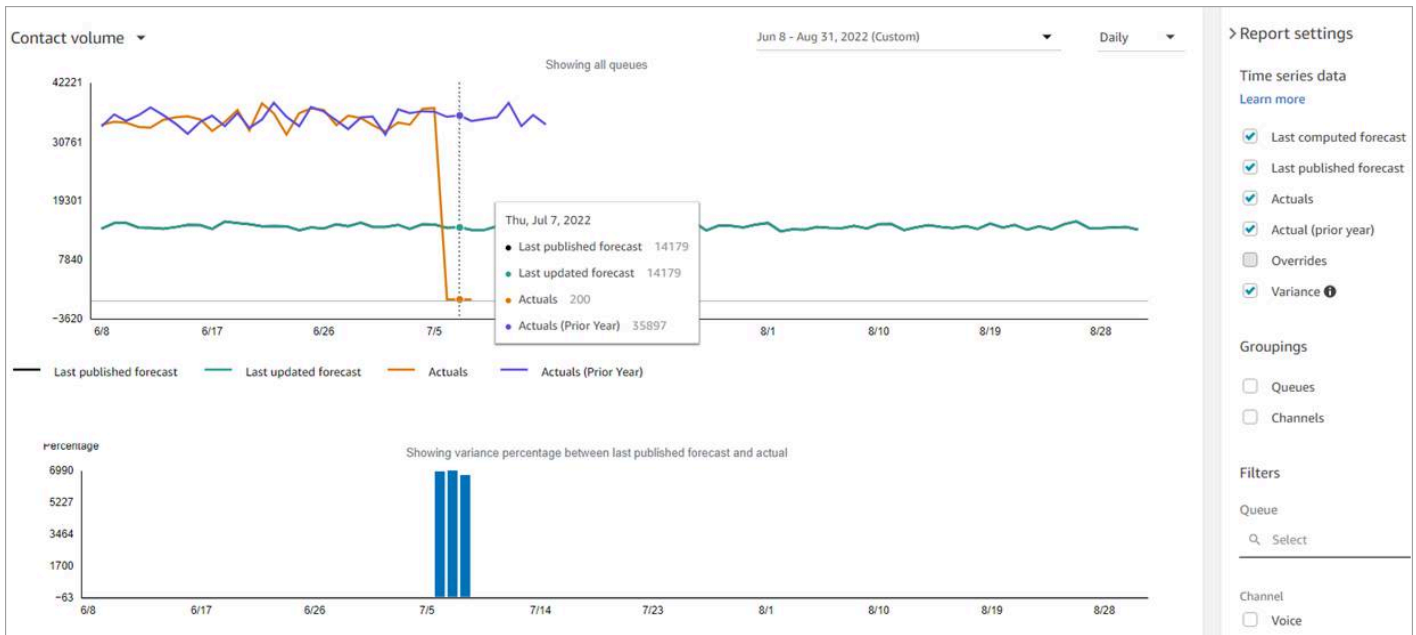

- **Capacity planning:** A capacity plan helps you estimate the long-term FTE (full-time equivalent) requirements for your contact center, up to 18 months. It specifies how many FTE agents are required to meet the service level target for a certain period of time.

The following image shows the plan output. It shows a week-by-week or month-by-month calculation. To switch from weekly to monthly view, select **Monthly** from the dropdown.

Plan Outputs

Weekly ↑

Metric	Mar 4 - Mar 10, 2022	Mar 11 - Mar 17, 2022	Mar 19 - Mar 25, 2022	Mar 26 - Apr 1, 2022	Apr 2 - Apr 8, 2022	Apr 9 - Apr 15, 2022	Apr 16 - Apr 22, 2022	Apr 23 - Apr 29, 2022	Apr 30 - May 6, 2022
Forecasting Inputs									
Forecasted Contact Volume	51719	54303	53952	53228	52421	47114	51085	51124	
Forecasted Average Handling Time (AHT), seconds	173	173	173	174	173	174	175	176	
Outputs									
Required FTEs (without Shrinkage)	99	103	103	102	100	91	99	99	
Forecasted Occupancy %	64%	63%	62%	63%	63%	62%	62%	63%	
Outputs with additional input									
Required FTEs (with Shrinkage)	116	128	128	126	124	112	122	123	
Available FTEs	102	124	126	126	127	126	122	127	
Metrics calculated from available FTE input									
Gap between available FTEs and required FTEs	-14	-4	-2	0	3	14	0	4	
Gap %	-14%	-3%	-2%	0%	2%	11%	0%	3%	
Required OT %	14%	3%	2%	0%	0%	0%	0%	0%	
Required VTO %	0%	0%	0%	0%	2%	11%	0%	3%	

Rows per page: 10 1-10 of 10

- **Scheduling:** Contact center schedulers or managers need to create agent schedules for day-to-day workloads that are flexible and meet business and compliance requirements. Amazon Connect helps you create efficient schedules that are optimized for per-channel Service Level or

Average speed of answer targets. You can generate and manage agent schedules based on the following:

- A short-term published forecast
- Shift profiles (templates for weekly shifts)
- Staffing groups (agents that can handle specific types of contacts from a specific forecast group)
- Human resources and business rules

The following image shows a sample schedule for a supervisor's team.

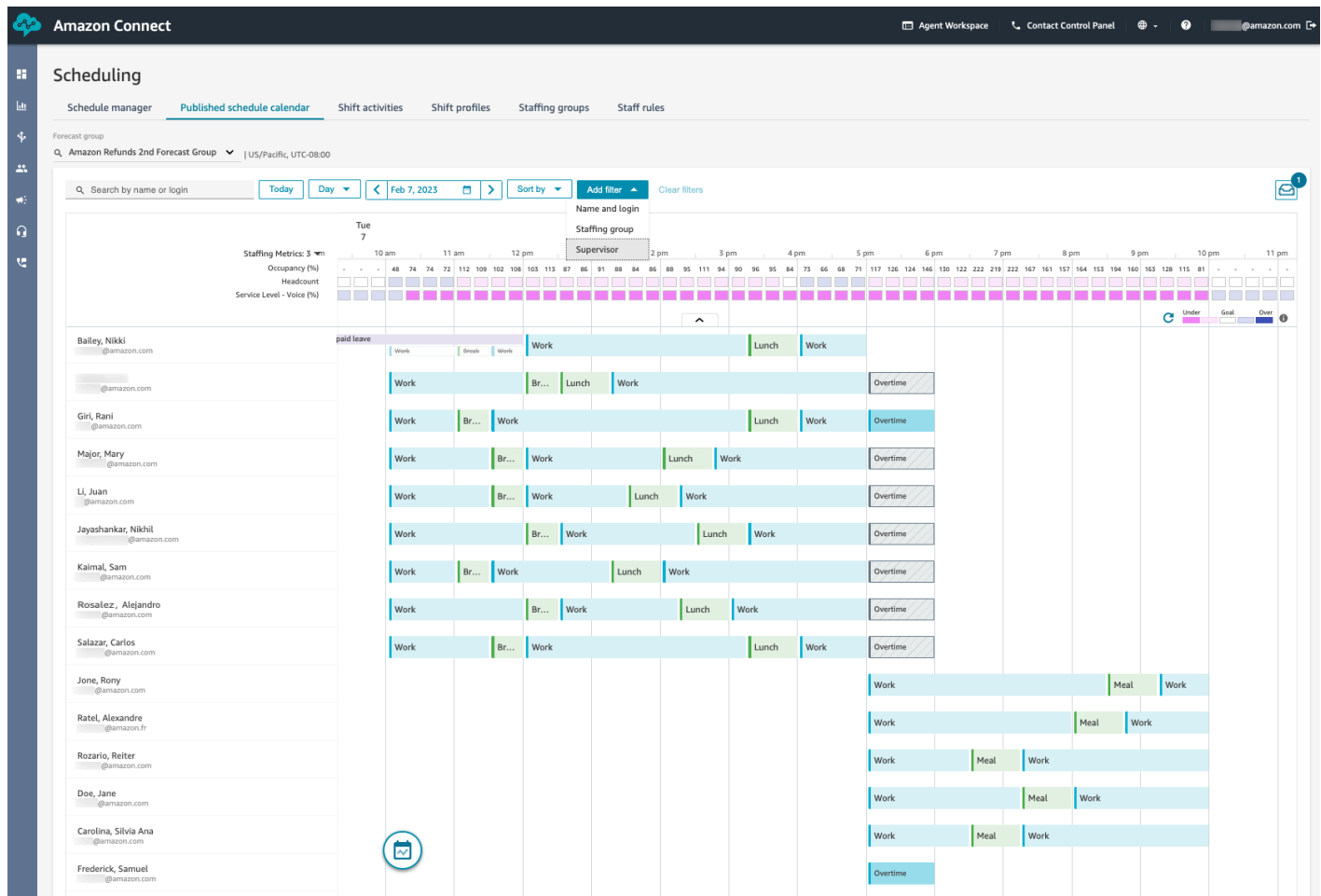

The following image shows a sample schedule that agents see in the agent application.

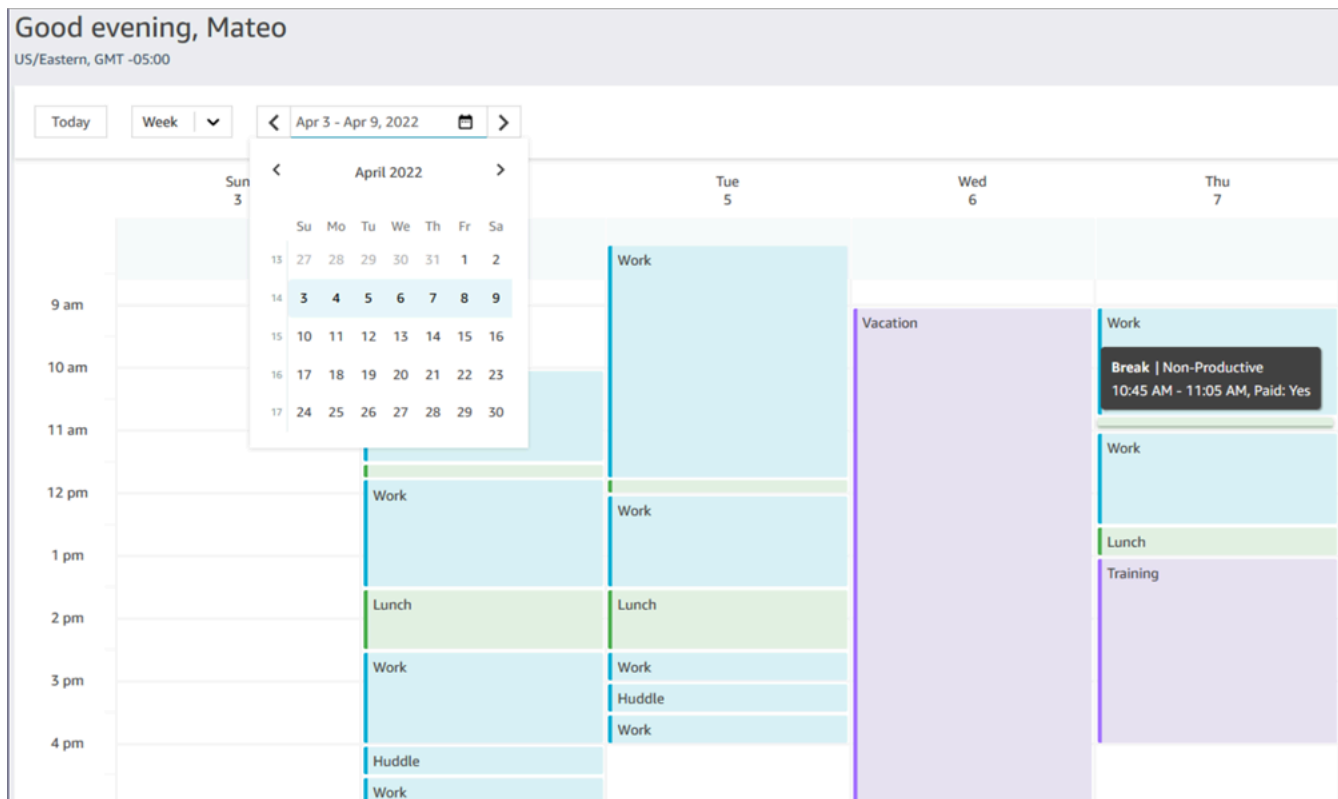

Amazon Connect Voice ID

You use [Amazon Connect Voice ID](#) for real-time caller authentication and fraud risk detection to make voice interactions faster and more secure.

Voice ID analyzes a caller's unique voice characteristic to provide agents and self-service interactive voice response (IVR) systems with a real-time decision on caller's identity. It also screens for fraudulent actors in real-time, based on your contact center's custom watchlist, reducing potential losses from fraudulent attacks.

In the following image, the agent is talking to a caller who has been authenticated. The fraud risk is low.

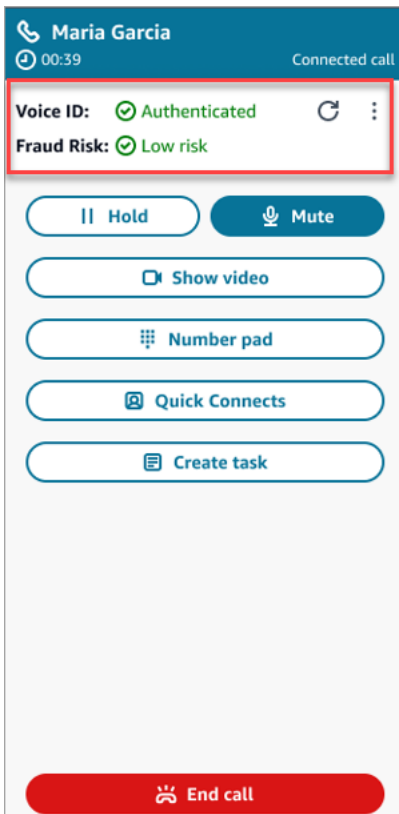

Amazon Connect Customer Profiles

You use [Amazon Connect Customer Profiles](#) to combine information from external applications with the contact history from Amazon Connect. For example, you can combined contacts with information from Salesforce, Zendesk, ServiceNow, or other customer relationship management (CRM) products to create customer profiles that have all the information that agents need during customer interactions in a single place.

With a single view of customer information, including their product, case, and contact history, agents can quickly confirm the customer's identity and determine the reason for the call or chat.

The following image shows the **Customer profile** tab of the agent workspace. It shows all of the recent cases associated with customer that the agent is currently talking to.

The screenshot displays the Amazon Connect interface. On the left, a sidebar shows a list of agents: Maria Garcia (00:39), Sofia Martínez (00:53), Mary Major (00:42), Adjust Ricard Smith's p... (06:43), and Nikki Wolf (01:33). Below this, a call control panel for Maria Garcia is visible, showing 'Voice ID: Authenticated' and 'Fraud Risk: Low risk'. The main area is titled 'Customer profile' and shows details for Maria Garcia, including her full name, profile ID, phone number, account number, birthdate, additional info, email address, gender, mailing address, and billing address. A red arrow points to the 'Customer profile' tab. Below the profile, a 'Cases' tab is selected, showing a table of recent cases. A second red arrow points to the 'Cases' tab. On the right, a 'Suggestions' panel shows a suggestion from Amazon Q regarding a fraud issue, with a response and a solution provided.

Customer profile details:

- Full name: Maria Garcia
- Profile ID: 1234abc...
- Phone number: +1 234-555-5400
- Account number: 233455
- Birthdate: September 7, 1987
- Additional info: 10+ years as a customer
- Email address: maria.garcia@example.com
- Gender: Female
- Mailing Address: 123 Any Street, Any Town, USA
- Billing Address: 123 Any Street, Any Town, USA

Recent cases table:

Status	Reference Id	Title	Source	Updated date	More
Open	795296	Fraud activity - transaction declined	Connect Cases	02/28/2024	ⓘ
Closed	B23456	Add authorized user	Connect Cases	02/11/2024	ⓘ
Closed	C34567	Cart lost	Connect Cases	01/29/2023	ⓘ
Closed	XYYY10	Change of address	Connect Cases	01/05/2023	ⓘ
Closed	EDD589	New card request	Connect Cases	12/02/2022	ⓘ

Amazon Connect outbound campaigns

You can create high volume ML-powered [outbound campaigns](#) to contact up to millions of customers daily for handling appointment reminders, marketing promotions, deliveries, and billing reminders. You can specify the contact list, channel, message, and even pre-recorded audio to play before connecting customers to agents for live service.

Outbound campaigns includes a predictive dialer and machine learning (ML)-powered answering machine detection. These feature can help you optimize agent productivity and increase live-party connections by not wasting agent time with unanswered calls.

Amazon Connect Cases

Agents use [Amazon Connect Cases](#) to track and manage customer issues that require multiple interactions, follow-up tasks, or teams in your contact center. They can document customer issues with all the relevant case details, such as date/time opened, issue summary, customer information, and status, in a single unified view.

The following image shows the agent workspace. The agent is talking to the contact on the phone and viewing a closed case for windshield damage. The case is associated with the customer's profile.

The screenshot displays the Amazon Connect agent workspace. On the left, a call control panel shows a connected call with the number +1 (206) 577-... and a duration of 01:10. The panel includes buttons for Hold, Mute, Number pad, Quick Connects, and Create task, along with an End call button at the bottom.

The main workspace is titled "Windshield damage - claim" and shows the case status as "Closed". A red arrow points to the "Status: Closed" dropdown menu. Other actions available include "+ Task", "Edit", "Assign to", and "Audit history". A green checkmark and the word "Associated" are visible on the right side, with another red arrow pointing to it.

The case summary indicates that the customer was driving on I90 on the way back from work, and a small rock hit their windshield. The customer's name is Jane Doe. The case was created on March 10, 2024, at 12:17 PM. It was last updated on March 11, 2024, at 8:01 PM. The policy number is 7017817. The VIN is JH4KA4650JC000403, and the owner's fault is False.

The activity feed shows three inbound calls, all completed, on March 11, 2024:

- Inbound call: March 11, 2024, 8:01 PM (Completed)
- Inbound call: March 11, 2024, 2:12 PM (Completed)
- Inbound call: March 11, 2024, 2:11 PM (Completed)

Reporting

Understanding your contact center at the most granular level is key to improving performance and lowering costs. Amazon Connect provides powerful analytics tools, including visual [dashboards](#) with customizable real-time and historical metrics.

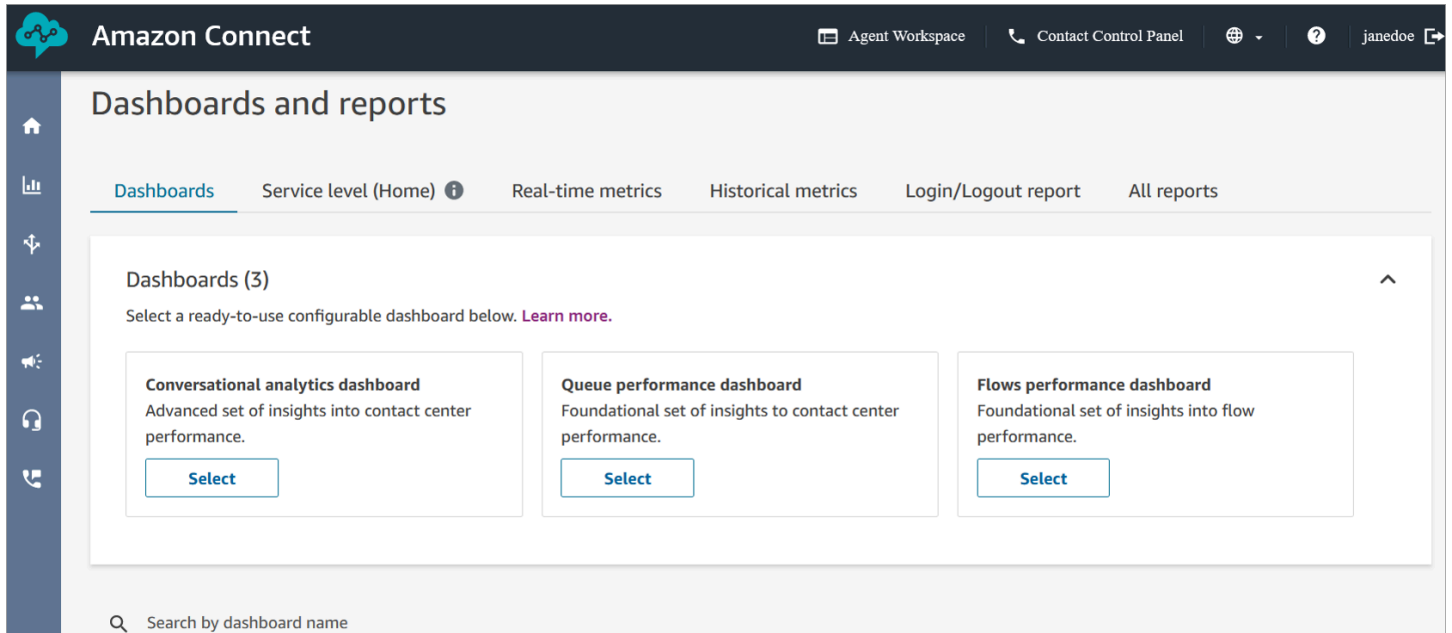

The following image shows an example of the [Contact Lens Conversational analytics dashboard](#). This dashboard helps you understand why customers are contacting you, the trends of contact drivers over time, and the performance of each of those call drivers (for example, average handle time for call driver "Where's my stuff?").

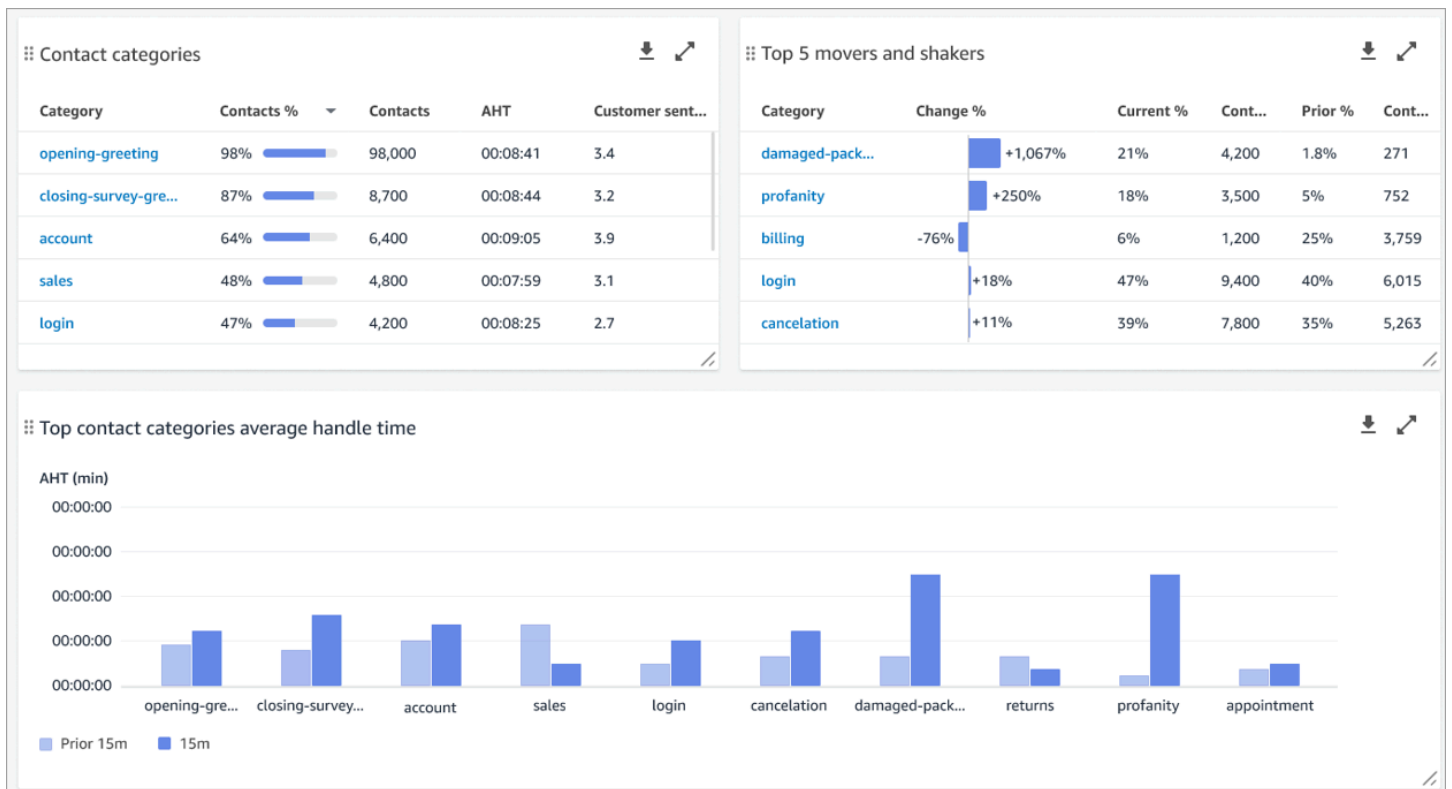

You can stream your most detailed contact metrics to the data lake of your choice, where you can analyze them with other data such as conversion rates or customer satisfaction. This help you make data-driven decisions that increase agent productivity and reduce customer wait times. Historical metrics also provide longer-term insights to identify common trends with customer issues and overall operational performance.

You can review the following out-of-the-box reports, and customize them to add more real-time and historical metrics:

- [Real-time metrics reports](#)
- [Historical metrics reports](#)
- [Login/logout reports](#)
- [Agent activity audit report](#)

The following image shows an example of a section of the Real-time metrics page for Queues.

Real-time Metrics

Queues 

Name	Agents						Contacts		Performance
	Online	On contact	NPT	ACW	Error	Available	Availability	Active	In queue
Summary	1	0	0	0	0	1	2	0	0
Callback queue	1	0	0	0	0	1	2	0	0
Queue 5	1	0	0	0	0	1	1	0	0
Fun Queue	1	0	0	0	0	1	2	0	0
Nate's Queue	1	0	0	0	0	1	2	0	0
BasicQueue	1	0	0	0	0	1	2	0	0
Queue 6	1	0	0	0	0	1	1	0	0

Note: Only queues for which there was activity during the report time range are included in the report. Queues without any activity are not included in the displayed report.

New table 

This next image shows a drill down into the real-time activity for Queue 4.

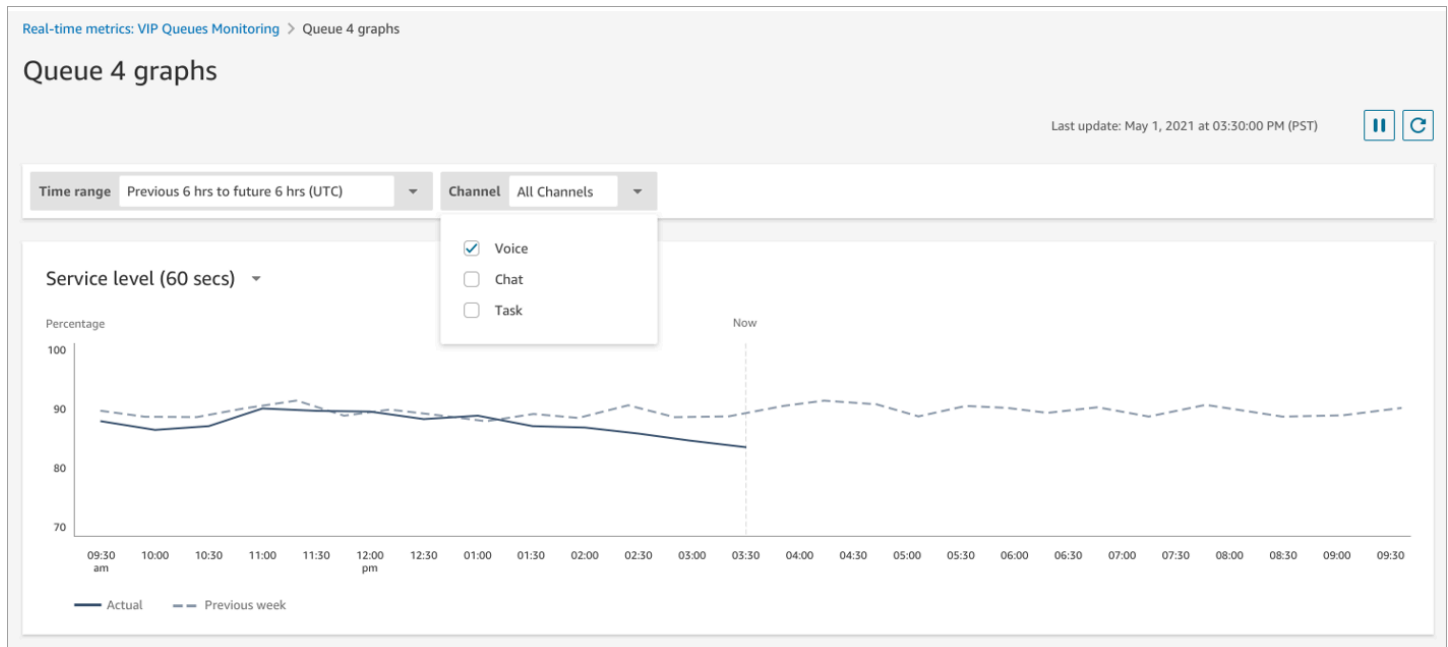

How to get started

If you are a first-time user of Amazon Connect, we recommend that you do the following:

- Explore Amazon Connect with our [tutorials](#)
- Read the [architectural guidance](#)
- [Set up your contact center](#)

Pricing

With Amazon Connect, you pay only for what you use. For more information, see [Amazon Connect pricing](#).

The power of AWS with Amazon Connect

To help provide a better contact center, you can use Amazon Connect with the following AWS services.



Development

You can use AWS Lambda functions to either look up or post data to sources outside of Amazon Connect. For example, you can look up an inbound caller on Salesforce based on the customer's phone number. The function may return such results as the customer name, membership level (for example, frequent flyer), last order, and order status. Then based on that information, the call can be routed to an Amazon Lex bot or an agent.

You can also use Lambda with AWS databases like DynamoDB to create dynamic routing abilities. For example, you can retrieve a prompt in a specific language, based on input from the customer.

API Gateway and Step Functions further enhance the abilities of Lambda.

For more information, see:

- [Invoke AWS Lambda functions](#)

Storage

Amazon Connect uses Amazon Simple Storage Service (Amazon S3) to store recorded conversations and exported reports. When you set up Amazon Connect, it creates default buckets for these requirements, or you can point it to existing Amazon S3 infrastructure. For more information, see [Step 4: Data storage](#) in [Create an Amazon Connect instance](#).

VPC endpoints are not supported.

You can also manage the Amazon S3 policies to move data to Amazon S3 Glacier for less expensive long-term storage. However, it breaks the link in the contact record in Amazon Connect. To fix this, use a Lambda function to rename the S3 Glacier object to match the data in the contact record.

Database

You can use AWS databases with Amazon Connect for a variety of reasons. For example, with DynamoDB, you can create quick tables of data.

You can also create tables of dynamic information for call routing. For example, a Lambda function can write inbound calls to a DynamoDB table, then query the table to see if there are other matches for the phone number. If so, a decision can be made to send the caller to the same queue as before, or to flag them as a repeat caller.

For more information, see:

- Blog post: [Creating dynamic, personalized experiences in Amazon Connect](#)

Analytics

Amazon Connect tracks all interactions using [contact records](#). Contact records are used for real-time and historical metrics reports. You can also use Amazon Kinesis to stream them to an AWS database like Amazon Redshift or Amazon Athena for BI analysis (Amazon QuickSight, or a third party such as Tableau). There are AWS CloudFormation templates available to set up this functionality for Amazon Redshift and Athena.

To perform analysis on your flow logs, you can set up an Amazon Kinesis stream to stream your flow log data from CloudWatch to a data warehouse service, such as Amazon Redshift. You can combine the flow log data with other Amazon Connect data in your warehouse, or run queries to identify trends or common issues with a flow.

For more information, see:

- [How to access Kinesis Video Streams data](#)
- Blog post: [Recovering abandoned calls with Amazon Connect](#)

Machine Learning (ML) and Artificial Intelligence (AI)

Amazon Connect uses the following services for ML/AI:

- Amazon Lex—Lets you create a chatbot to use as Interactive Voice Response (IVR). For more information, see [Add an Amazon Lex bot to Amazon Connect](#).
- Amazon Polly—Provides text-to-speech in all flows. For more information, see [Add text-to-speech to prompts](#) and [SSML tags supported by Amazon Connect](#).
- Amazon Transcribe—Grabs conversation recordings from Amazon S3, and transcribes them to text so you can review them.
- Amazon Comprehend—Takes the transcription of recordings, and applies speech analytics machine learning to the call to identify sentiment, keywords, adherence to company policies, and more.

Messaging

Amazon Connect uses the following services for messaging:

- Amazon Pinpoint—Use as an outbound messaging trigger for events; for example, bulk messaging (such as outbound marketing campaigns). For more information, see this blog post: [Using Amazon Pinpoint to send text messages in Amazon Connect](#).
- Amazon Simple Notification Service (Amazon SNS)—Use to send and receive SMS and other channel notifications. Amazon SNS is particularly useful for sending alerts and validations.
- Amazon Simple Email Service (Amazon SES)—Use to send validation e-mails, such as a password reset bot sending a confirmation of the transaction.

Security

Amazon Connect uses the following services for added security:

- AWS Identity and Access Management (IAM)—Use to manage permissions for users. Amazon Connect users require permission for services. For more information, see [Identity and access management for Amazon Connect](#).
- AWS Directory Service—Amazon Connect supports user federation through the internal directory (created in the Amazon Connect instance), using Active Directory integration (MAD, ADFS) or SAML 2.0.

For more information, see:

- [Plan your identity management in Amazon Connect](#)
- Blog post: [Enabling federation with AWS Single Sign-On and Amazon Connect](#)

Management

Amazon Connect uses the following services for monitoring usage:

- Amazon CloudWatch—Collects logs, service metrics, performance metrics for Amazon Connect. For more information, see [Monitoring your instance using CloudWatch](#).
- AWS CloudTrail—Provides a record of Amazon Connect API calls.

For more information about Amazon Connect and AWS CloudTrail, see [Logging Amazon Connect API calls with AWS CloudTrail](#).

- AWS CloudFormation—Amazon Connect supports using AWS CloudFormation for initiating an instance with all the supported channels enabled. For more information, see [AWS::Connect::Instance](#).

Availability of Amazon Connect features by Region

This topic lists the AWS Regions where Amazon Connect features are available.

Contents

- [Amazon Connect availability by Region](#)
- [Agent workspace and step-by-step guides](#)
- [Agent workspace third-party applications](#)
- [Amazon Q in Connect](#)
- [AppIntegrations availability by Region](#)

- [Cases availability by Region](#)
- [Chat messaging: SMS subtype](#)
- [Communications widget](#)
- [Contact Lens availability by Region](#)
- [Customer Profiles availability by Region](#)
- [Forecasting, capacity planning, and scheduling](#)
- [Global Resiliency availability by Region](#)
- [In-app, web, and video calling capabilities](#)
- [Live media streaming](#)
- [Outbound campaigns](#)
- [Tasks](#)
- [Voice ID availability by Region](#)

Amazon Connect availability by Region

Region Name	Region	Endpoint	Protocol
US East (N. Virginia)	us-east-1	connect.us-east-1.amazonaws.com	HTTPS
		connect-fips.us-east-1.amazonaws.com	HTTPS
US West (Oregon)	us-west-2	connect.us-west-2.amazonaws.com	HTTPS
		connect-fips.us-west-2.amazonaws.com	HTTPS
Africa (Cape Town)	af-south-1	connect.af-south-1.amazonaws.com	HTTPS
Asia Pacific (Seoul)	ap-northeast-2	connect.ap-northeast-2.amazonaws.com	HTTPS

Region Name	Region	Endpoint	Protocol
Asia Pacific (Singapore)	ap-southeast-1	connect.ap-southeast-1.amazonaws.com	HTTPS
Asia Pacific (Sydney)	ap-southeast-2	connect.ap-southeast-2.amazonaws.com	HTTPS
Asia Pacific (Tokyo)	ap-northeast-1	connect.ap-northeast-1.amazonaws.com	HTTPS
Canada (Central)	ca-central-1	connect.ca-central-1.amazonaws.com	HTTPS
Europe (Frankfurt)	eu-central-1	connect.eu-central-1.amazonaws.com	HTTPS
Europe (London)	eu-west-2	connect.eu-west-2.amazonaws.com	HTTPS
AWS GovCloud (US-West)	us-gov-west-1	connect.us-gov-west-1.amazonaws.com	HTTPS

Agent workspace and step-by-step guides

- US East (N. Virginia)
- US West (Oregon)
- Africa (Cape Town)
- Asia Pacific (Seoul)

- Asia Pacific (Singapore)
- Asia Pacific (Sydney)
- Asia Pacific (Tokyo)
- Canada (Central)
- Europe (Frankfurt)
- Europe (London)
- AWS GovCloud (US-West)

Agent workspace third-party applications

- US East (N. Virginia)
- US West (Oregon)
- Africa (Cape Town)
- Asia Pacific (Seoul)
- Asia Pacific (Singapore)
- Asia Pacific (Sydney)
- Asia Pacific (Tokyo)
- Canada (Central)
- Europe (Frankfurt)
- Europe (London)

Amazon Q in Connect

- US East (N. Virginia)
- US West (Oregon)
- Asia Pacific (Seoul)
- Asia Pacific (Singapore)
- Asia Pacific (Sydney)
- Asia Pacific (Tokyo)
- Canada (Central)
- Europe (Frankfurt)

- Europe (London)

Note

Amazon Connect instances in Asia Pacific (Tokyo) use Amazon Bedrock in Asia Pacific (Seoul). Amazon Connect instances in Asia Pacific (Singapore) use Amazon Bedrock in Asia Pacific (Sydney). All other Amazon Connect instances use Amazon Bedrock in their respective Regions.

AppIntegrations availability by Region

Region Name	Region	Endpoint	Protocol
US East (N. Virginia)	us-east-1	app-integrations.us-east-1.amazonaws.com	HTTPS
		app-integrations-fips.us-east-1.amazonaws.com	HTTPS
US West (Oregon)	us-west-2	app-integrations.us-west-2.amazonaws.com	HTTPS
		app-integrations-fips.us-west-2.amazonaws.com	HTTPS
Africa (Cape Town)	af-south-1	app-integrations.af-south-1.amazonaws.com	HTTPS
Asia Pacific (Seoul)	ap-northeast-2	app-integrations.ap-northeast-2.amazonaws.com	HTTPS
Asia Pacific (Singapore)	ap-southeast-1	app-integrations.ap-southeast-1.amazonaws.com	HTTPS

Region Name	Region	Endpoint	Protocol
Asia Pacific (Sydney)	ap-southeast-2	app-integrations.ap-southeast-2.amazonaws.com	HTTPS
Asia Pacific (Tokyo)	ap-northeast-1	app-integrations.ap-northeast-1.amazonaws.com	HTTPS
Canada (Central)	ca-central-1	app-integrations.ca-central-1.amazonaws.com	HTTPS
		app-integrations-fips.ca-central-1.amazonaws.com	HTTPS
Europe (Frankfurt)	eu-central-1	app-integrations.eu-central-1.amazonaws.com	HTTPS
Europe (London)	eu-west-2	app-integrations.eu-west-2.amazonaws.com	HTTPS

Cases availability by Region

Region Name	Region	Endpoint	Protocol
US East (N. Virginia)	us-east-1	cases.us-east-1.amazonaws.com	HTTPS
		cases-fips.us-east-1.amazonaws.com	HTTPS
US West (Oregon)	us-west-2	cases.us-west-2.amazonaws.com	HTTPS
		cases-fips.us-west-2.amazonaws.com	HTTPS

Region Name	Region	Endpoint	Protocol
Asia Pacific (Seoul)	ap-northeast-2	cases.ap-northeast-2.amazonaws.com	HTTPS
Asia Pacific (Singapore)	ap-southeast-1	cases.ap-southeast-1.amazonaws.com	HTTPS
Asia Pacific (Sydney)	ap-southeast-2	cases.ap-southeast-2.amazonaws.com	HTTPS
Asia Pacific (Tokyo)	ap-northeast-1	cases.ap-northeast-1.amazonaws.com	HTTPS
Canada (Central)	ca-central-1	cases.ca-central-1.amazonaws.com	HTTPS
Europe (Frankfurt)	eu-central-1	cases.eu-central-1.amazonaws.com	HTTPS
Europe (London)	eu-west-2	cases.eu-west-2.amazonaws.com	HTTPS

Chat messaging: SMS subtype

- US East (N. Virginia)
- US West (Oregon)
- Asia Pacific (Seoul)
- Asia Pacific (Singapore)
- Asia Pacific (Sydney)

- Asia Pacific (Tokyo)
- Canada (Central)
- Europe (Frankfurt)
- Europe (London)

Communications widget

- US East (N. Virginia)
- US West (Oregon)
- Asia Pacific (Seoul)
- Asia Pacific (Singapore)
- Asia Pacific (Sydney)
- Asia Pacific (Tokyo)
- Canada (Central)
- Europe (Frankfurt)
- Europe (London)

Contact Lens availability by Region

Region Name	Region	Endpoint	Protocol
US East (N. Virginia)	us-east-1	contact-lens.us-east-1.amazonaws.com	HTTPS
US West (Oregon)	us-west-2	contact-lens.us-west-2.amazonaws.com	HTTPS
Asia Pacific (Seoul)	ap-northeast-2	contact-lens.ap-northeast-2.amazonaws.com	HTTPS
Asia Pacific (Singapore)	ap-southeast-1	contact-lens.ap-southeast-1.amazonaws.com	HTTPS

Region Name	Region	Endpoint	Protocol
Asia Pacific (Sydney)	ap-southeast-2	contact-lens.ap-southeast-2.amazonaws.com	HTTPS
Asia Pacific (Tokyo)	ap-northeast-1	contact-lens.ap-northeast-1.amazonaws.com	HTTPS
Canada (Central)	ca-central-1	contact-lens.ca-central-1.amazonaws.com	HTTPS
Europe (Frankfurt)	eu-central-1	contact-lens.eu-central-1.amazonaws.com	HTTPS
Europe (London)	eu-west-2	contact-lens.eu-west-2.amazonaws.com	HTTPS

Contact Lens features by Region

Analytics capabilities

Region	Generative AI-powered post-contact summaries	Post-call analytics	Post-chat analytics	Real-time call analytics	Theme detection	Extended language support
US East (N. Virginia)	Yes	Yes	Yes	Yes	Yes	Yes
US West (Oregon)	Yes	Yes	Yes	Yes	Yes	Yes

Region	Generative AI-powered post-contact summaries	Post-call analytics	Post-chat analytics	Real-time call analytics	Theme detection	Extended language support
Africa (Cape Town)	-	Yes	Yes	-	-	Yes
Asia Pacific (Seoul)	-	Yes	Yes	Yes	Yes	Yes
Asia Pacific (Singapore)	-	Yes	Yes	Yes	Yes	Yes
Asia Pacific (Sydney)	-	Yes	Yes	Yes	Yes	Yes
Asia Pacific (Tokyo)	-	Yes	Yes	Yes	Yes	Yes
Canada (Central)	-	Yes	Yes	Yes	Yes	Yes
Europe (Frankfurt)	-	Yes	Yes	Yes	Yes	Yes
Europe (London)	-	Yes	Yes	Yes	Yes	Yes
AWS GovCloud (US-West)	-	-	-	-	-	-

Contact search, screen recording, and evaluation capabilities

Region	Contact search	Screen recording	Evaluation capabilities
US East (N. Virginia)	Yes	Yes	Yes
US West (Oregon)	Yes	Yes	Yes
Africa (Cape Town)	Yes	Yes	Yes
Asia Pacific (Seoul)	Yes	Yes	Yes
Asia Pacific (Singapore)	Yes	Yes	Yes
Asia Pacific (Sydney)	Yes	Yes	Yes
Asia Pacific (Tokyo)	Yes	Yes	Yes
Canada (Central)	Yes	Yes	Yes
Europe (Frankfurt)	Yes	Yes	Yes
Europe (London)	Yes	Yes	Yes
AWS GovCloud (US-West)	Yes	-	-

Customer Profiles availability by Region

Region Name	Region	Endpoint	Protocol
US East (N. Virginia)	us-east-1	profile.us-east-1.amazonaws.com	HTTPS
		profile-fips.us-east-1.amazonaws.com	HTTPS

Region Name	Region	Endpoint	Protocol
US West (Oregon)	us-west-2	profile.us-west-2.amazonaws.com	HTTPS
		profile-fips.us-west-2.amazonaws.com	HTTPS
Africa (Cape Town)	af-south-1	profile.af-south-1.amazonaws.com	HTTPS
Asia Pacific (Seoul)	ap-northeast-2	profile.ap-northeast-2.amazonaws.com	HTTPS
Asia Pacific (Singapore)	ap-southeast-1	profile.ap-southeast-1.amazonaws.com	HTTPS
Asia Pacific (Sydney)	ap-southeast-2	profile.ap-southeast-2.amazonaws.com	HTTPS
Asia Pacific (Tokyo)	ap-northeast-1	profile.ap-northeast-1.amazonaws.com	HTTPS
Canada (Central)	ca-central-1	profile.ca-central-1.amazonaws.com	HTTPS
		profile-fips.ca-central-1.amazonaws.com	HTTPS
Europe (Frankfurt)	eu-central-1	profile.eu-central-1.amazonaws.com	HTTPS
Europe (London)	eu-west-2	profile.eu-west-2.amazonaws.com	HTTPS

Forecasting, capacity planning, and scheduling

- US East (N. Virginia)
- US West (Oregon)
- Canada (Central)
- Asia Pacific (Sydney)
- Europe (London)
- Asia Pacific (Singapore)
- Europe (Frankfurt)
- Asia Pacific (Tokyo)
- Asia Pacific (Seoul)

Global Resiliency availability by Region

- US East (N. Virginia)
- US West (Oregon)
- Europe (Frankfurt)
- Europe (London)

In-app, web, and video calling capabilities

- US East (N. Virginia)
- US West (Oregon)
- Asia Pacific (Seoul)
- Asia Pacific (Singapore)
- Asia Pacific (Sydney)
- Asia Pacific (Tokyo)
- Canada (Central)
- Europe (Frankfurt)
- Europe (London)

Live media streaming

- US East (N. Virginia)
- US West (Oregon)
- Asia Pacific (Seoul)
- Asia Pacific (Singapore)
- Asia Pacific (Sydney)
- Asia Pacific (Tokyo)
- Canada (Central)
- Europe (Frankfurt)
- Europe (London)

Outbound campaigns

- US East (N. Virginia)
- US West (Oregon)
- Asia Pacific (Sydney)
- Canada (Central)
- Europe (Frankfurt)
- Europe (London)

The phone numbers that outbound campaigns can call are based on the AWS Region where your Amazon Connect instance is created.

- From instances created in US East (N. Virginia) or US West (Oregon) you can call all phone numbers based in the US.
- From instances created in Canada (Central) you can call all phone numbers based in Canada.
- From instances created in Asia Pacific (Sydney) you can call phone numbers based in Australia and New Zealand. There are a few specific restrictions explained in [Make predictive and progressive calls using Amazon Connect outbound campaigns](#).
- From instances created in Europe (Frankfurt) or Europe (London) you can call all phone numbers based in the UK, Italy, or Spain.

- No other combinations are supported. For example, you can't make campaign calls from Europe (London) to US phone numbers, or from Europe (Frankfurt) to New Zealand phone numbers.

Tasks

- US East (N. Virginia)
- US West (Oregon)
- Africa (Cape Town)
- Asia Pacific (Seoul)
- Asia Pacific (Singapore)
- Asia Pacific (Sydney)
- Asia Pacific (Tokyo)
- Canada (Central)
- Europe (Frankfurt)
- Europe (London)
- AWS GovCloud (US-West)

Voice ID availability by Region

Region Name	Region	Endpoint	Protocol
US East (N. Virginia)	us-east-1	voiceid.us-east-1.amazonaws.com	HTTPS
		voiceid-fips.us-east-1.amazonaws.com	HTTPS
US West (Oregon)	us-west-2	voiceid.us-west-2.amazonaws.com	HTTPS
		voiceid-fips.us-west-2.amazonaws.com	HTTPS
Asia Pacific (Singapore)	ap-southeast-1	voiceid.ap-southeast-1.amazonaws.com	HTTPS

Region Name	Region	Endpoint	Protocol
Asia Pacific (Sydney)	ap-southeast-2	voiceid.ap-southeast-2.amazonaws.com	HTTPS
Asia Pacific (Tokyo)	ap-northeast-1	voiceid.ap-northeast-1.amazonaws.com	HTTPS
Canada (Central)	ca-central-1	voiceid.ca-central-1.amazonaws.com	HTTPS
		voiceid-fips.ca-central-1.amazonaws.com	HTTPS
Europe (Frankfurt)	eu-central-1	voiceid.eu-central-1.amazonaws.com	HTTPS
Europe (London)	eu-west-2	voiceid.eu-west-2.amazonaws.com	HTTPS

Browsers supported by Amazon Connect

Important

Trying to contact Amazon support? See [Amazon Customer Service](#) (Amazon orders and deliveries) or [AWS Support](#) (Amazon Web Services).

Before you work with Amazon Connect, verify that your browser is supported using the following table.

Browser	Version	How to check your version
Google Chrome	Latest three versions	Open Chrome and type <code>chrome://version</code> in your address bar. The version is in

Browser	Version	How to check your version
		the Google Chrome field at the top of the results.
Microsoft Edge Chromium	Latest three versions	Open Edge. On the menu, choose Help and feedback and then choose About Microsoft Edge . The version number is listed in the About section.
Mozilla Firefox	Latest three versions	<p>Open Firefox. On the menu, choose the Help icon and then choose About Firefox. The version number is listed under the Firefox name.</p> <p>Please see Issue with Firefox version 86.</p>
Mozilla Firefox ESR	Versions are supported until their Firefox end-of-life date . For details, see the Firefox ESR release calendar .	Open Firefox. On the menu, choose the Help icon and then choose About Firefox . The version number is listed under the Firefox name.

For more requirements, see [Agent headset and workstation requirements for the CCP](#).

Browsers on mobile devices

The Amazon Connect console, Contact Control Panel (CCP), and agent workspace do not support mobile browsers. However, your agents can forward the audio portion of the call to their mobile device. For instructions, see [Forward calls to a mobile device \(iPhone, Android\)](#).

Supported browsers and mobile OS for in-app, web, and video calling capabilities

- Amazon Chime SDK for iOS and Android:
 - iOS version 13 and later
 - Android OS version 8.1 and later, ARM and ARM64 architecture
- Web browsers for out-of-the-box communications widget and JS SDK
 - Latest three versions of Google Chrome, Firefox, Safari, and Microsoft Edge Chromium on MacOS, Windows, iOS, and Android.

For more information, see [Set up in-app, web, and video calling capabilities](#).

The communications widget supports browser notifications for desktop devices. For more information, see [Browser notifications](#).

Issue with Firefox version 86

The following issue may occur if you embed the Amazon Connect Contact Control Panel (CCP) into your agent application and your users access the Amazon Connect CCP using the Firefox web browser with **Enhanced Tracking Protection** browser setting set to **Strict**.

An upgrade to Firefox, specifically Firefox non-ESR version 86 released on February 23, 2021, introduced [Total Cookie Protection](#) which modified cookie sharing behavior across sites for users with **Enhanced Tracking Protection** set to **Strict** (Firefox defaults to **Standard**). Users with this specific browser setting and version combination may be unable to access the Amazon Connect CCP when embedded in another application, preventing them from handling contacts.

To prevent impact to your users (agents), we recommend that your users do one of the following:

- Confirm (or set) **Enhanced Tracking Protection** as **Standard** in their browser settings. Users can do this by following instructions documented [here](#).
- Do not upgrade their Firefox browser version to v86 or higher.
- Use Google Chrome or Microsoft Edge to access the Amazon Connect CCP.

Accessibility compliance

We strive to provide an accessible user interface for Amazon Connect. See the accessibility compliance reports (ACR) that are regularly published in [AWS Artifact](#). For more information, see [Getting started with AWS Artifact](#)

For information about AWS compliance programs, see [Compliance validation in Amazon Connect](#).

Supported screen readers

You can use the following screen readers with the latest version of the Amazon Connect Contact Control Panel (the CCP URL ends with `/ccp-v2`):

- JAWS
- NVDA
- VoiceOver

Languages supported by Amazon Connect

This topic lists Amazon Connect features and which languages they support.

Contents

- [Contact Control Panel](#)
- [Chat message content](#)
- [Amazon Connect admin website](#)
- [Amazon Connect Cases](#)
- [Amazon Connect Contact Lens](#)
- [Amazon Connect forecasting, capacity planning, and scheduling](#)
- [Amazon Q in Connect](#)
- [Amazon Lex](#)
- [Amazon Polly](#)

Contact Control Panel

CCP	Supported languages
Contact Control Panel - latest version	<ul style="list-style-type: none">• Chinese (Simplified)• Chinese (Traditional)• English• French• German• Italian• Japanese• Korean• Portuguese (Brazilian)• Spanish
Contact Control Panel - earlier version	<ul style="list-style-type: none">• English• French• German• Italian• Japanese• Korean• Portuguese (Brazilian)• Spanish

Chat message content

Amazon Connect provides full Unicode support. You can chat with customers in any language of your choice.

Amazon Connect admin website

- Chinese (Simplified)
- Chinese (Traditional)

- English
- French
- German
- Italian
- Japanese
- Korean
- Portuguese (Brazilian)
- Spanish

Amazon Connect Cases

- Chinese (Simplified)
- Chinese (Traditional)
- English
- French
- German
- Italian
- Japanese
- Korean
- Portuguese (Brazilian)
- Spanish

Amazon Connect Contact Lens

This section includes the supported languages for the following features:

- [Post-call/chat analytics and Real-time call analytics and redaction](#)
- [Generative AI-powered post-contact summaries](#)
- [Key highlights](#)
- [Pattern match languages](#)
- [Theme detection](#)

Post-call/chat analytics and Real-time call analytics and redaction

Languages	Post-call/chat analytics	Post-call/chat redaction	Real-time call analytics	Real-time chat redaction
Arabic (Gulf)	✓			
English (Australia)	✓	✓	✓	✓
English (Great Britain)	✓	✓	✓	✓
English (New Zealand)	✓	✓		✓
English (South Africa)	✓	✓		✓
English (United States)	✓	✓	✓	✓
English (India)	✓	✓		✓
English (Ireland)	✓	✓		✓
English (Scotland)	✓	✓		✓
English (Wales)	✓	✓		✓
French (Canada)	✓		✓	
French (France)	✓		✓	
German (Germany)	✓		✓	
German (Switzerland)	✓			

Languages	Post-call/chat analytics	Post-call/chat redaction	Real-time call analytics	Real-time chat redaction
Hindi (India)	✓			
Italian (Italy)	✓		✓	
Japanese (Japan)	✓		✓	
Korean (South Korea)	✓		✓	
Mandarin (Mainland China)	✓		✓	
Portuguese (Brazil)	✓		✓	
Portuguese (Portugal)	✓			
Spanish (Spain)	✓			
Spanish (United States)	✓	✓	✓	✓

Generative AI-powered post-contact summaries

- English (Australia)
- English (Great Britain)
- English (New Zealand)
- English (South Africa)
- English (United States)
- English (India)
- English (Ireland)
- English (Scotland)

- English (Wales)

Key highlights

- English (Australia)
- English (Great Britain)
- English (New Zealand)
- English (South Africa)
- English (United States)
- English (India)
- English (Ireland)
- English (Scotland)
- English (Wales)

Pattern match languages

- English (United States)
- Arabic (Gulf)
- Chinese
- German (Germany)
- French (France)
- Hindi (Indian)
- Italian
- Japanese
- Korean
- Portuguese
- Spanish (Spain)

Theme detection

- English (Australia)
- English (Great Britain)

- English (New Zealand)
- English (South Africa)
- English (United States)
- English (India)
- English (Ireland)
- English (Scotland)
- English (Wales)

Generative AI-powered performance evaluations

- English (Australia)
- English (Great Britain)
- English (New Zealand)
- English (South Africa)
- English (United States)
- English (India)
- English (Ireland)
- English (Scotland)
- English (Wales)

Amazon Connect forecasting, capacity planning, and scheduling

- English (United States)

Amazon Q in Connect

- English (Australia)
- English (Great Britain)
- English (United States)

Amazon Lex

See [Languages and locales supported by Amazon Lex V2](#) in the *Amazon Lex V2 Developer's Guide*.

Amazon Polly

See [Voices in Amazon Polly](#) in the *Amazon Polly Developer Guide*.

Amazon Connect service quotas

All service quotas can be adjusted/increased unless otherwise noted.

Your AWS account has default quotas, formerly referred to as limits, for each AWS service.

To request a quota increase, see [Requesting a quota increase](#) in the *Service Quotas User Guide*. If the quota is not yet available in Service Quotas, use the [Amazon Connect service quotas increase form](#). You must be signed in to your AWS account to access the form.

Contents

- [Important things to know](#)
- [Amazon Connect quotas](#)
- [Amazon Connect AppIntegrations service quotas](#)
- [Amazon Q in Connect service quotas](#)
- [Amazon Connect Cases service quotas](#)
- [Contact Lens service quotas](#)
- [Amazon Connect Customer Profiles service quotas](#)
- [Amazon Connect Outbound campaigns service quotas](#)
- [Amazon Connect Voice ID service quotas](#)
- [How contacts are counted](#)
- [Amazon Connect feature specifications](#)
- [Countries you can call by default](#)
- [API throttling quotas](#)

Important things to know

- You must create your instance before you can request a service quota increase.

- We review each request for a quota increase. For smaller increase requests, we can approve in hours. Larger increase requests take time to review, process, approve, and deploy. Depending on your specific implementation, your resource, and the size of quota that you want, a request can take up to 3 weeks. An extra-large worldwide increase can potentially take months. If you're increasing your quotas as part of a larger project, keep this information in mind and plan accordingly.
- Use the same form to submit a request to port your US phone number from your current carrier to Amazon Connect. For more information about porting phone numbers, see [Port your current phone number to Amazon Connect](#).
- The quotas apply per [AWS Region](#). You can have multiple Amazon Connect instances in each Region. It's possible to raise quotas for all instances in a Region.
- Default quota values in this documentation are specifically for new accounts. Because quota defaults have been adjusted over time, the default and applied quota values for your account might be lower than the default values described in this topic.
- Not all quotas can be adjusted.
- There are two types of quota adjustability: account level and resource-level.
 - Account level quotas, when adjusted, apply to all Amazon Connect instances in this account and Region. For example, the maximum transactions per second (TPS) limits for a specific API.
 - Resource level quotas, when adjusted, only apply to resources within a specific Amazon Connect instance. For example, the maximum number of users per instance. Resource level quotas cannot be adjusted at the account level.

 **Important**

You need AWS CLI version 2.13.20 or higher to view and manage resource-level quotas such as **Phone numbers per instance** for Amazon Connect.

Amazon Connect quotas

Name	Default	Adjustable	Adjustability
AWS Lambda functions per instance	50	Yes	Resource Level
Agent status per instance	50	No	Not Adjustable
Amazon Connect instances per account	2	Yes	Account Level
Amazon Lex bots per instance	70	No	Resource Level
Amazon Lex V2 bot aliases per instance	100	Yes	Resource Level
Concurrent active calls per instance	10 For more information, see the section called "How contacts are counted" .	Yes	Resource Level
Concurrent active chats per instance	500 This includes chats that are waiting and SMS. If the customer has initiated a chat and has gone silent for hours, this idle chat is counted against the quota. To avoid having idle chats count against your quota, we recommend using persistent chats .	Yes	Resource Level

Name	Default	Adjustable	Adjustability
	If this quota is exceeded, the API call fails with a quota exceeded error.		
Concurrent active tasks per instance	2500 concurrent active tasks All tasks that have not yet ended are considered active and are counted as concurrent tasks: tasks that are being routed in flows, waiting in a queue for an agent, being handled by agents, or being run in After Contact Work (ACW).	Yes	Resource Level
Flows per instance	100	Yes	Resource Level
Hours of operation per instance	100	Yes	Resource Level
Maximum duration that a task can be scheduled in future	6 days	No	Not Adjustable
Maximum number of reschedules allowed for a task scheduled for a future time	20	No	Not Adjustable
Modules per instance	200	No	Not Adjustable

Name	Default	Adjustable	Adjustability
Phone numbers per instance	5 It's possible to get an error message that "You've reached the limit of Phone Numbers," even if it's the first time you've claimed a phone number. All the issues that cause this error message require help from AWS Support to resolve.	Yes	Resource Level
Predefined attributes per instance	25	Yes	Resource Level
Proficiencies per agent	10	Yes	Resource Level
Prompts per instance	500	Yes	Resource Level
Queues per instance	100	Yes	Resource Level
Queues per routing profile per instance	50 This quota refers to number of queue/channel combinations per routing profile. For example, in the following image there are two queues, but there are three queue-channel combinations: Escalation queue Voice, Escalation queue Chat, and BasicQueue Voice. This counts three towards the service limit of 50.	Yes	Resource Level

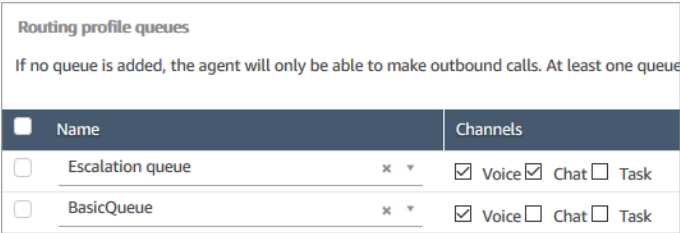

Name	Default	Adjustable	Adjustability
Quick connects per instance	100	Yes	Resource Level
Rate of API requests	See Amazon Connect API throttling quotas .	Yes	Account Level
Reports per instance	<p>2000</p> <p>Personal saved reports count towards the reports per instance. For example, if one of your supervisors saves a report every day, it will count towards your overall number of saved reports per instance.</p> <p>As a best practice, we recommend you implement policies so reports don't pile up.</p>	Yes	Resource Level
Routing profiles per instance	500	Yes	Resource Level
Scheduled reports per instance	100	Yes	Resource Level
Security profiles per instance	100	Yes	Resource Level
Task templates per instance	50	No	Not Adjustable

Name	Default	Adjustable	Adjustability
Task template customized fields per instance	50	No	Not Adjustable
Theme detection reports generated within 30 minutes per instance	6	No	Resource Level
User hierarchy groups per instance	500 This quota applies to the total number of hierarchy groups you have, across all levels. There is no feature limit for how many hierarchy groups you can have for each level. For example, one level could have 500 hierarchy groups, which would reach the quota for your instance.	Yes	Resource Level
Users per instance	500 For example, 500 users can be logged into Amazon Connect concurrently as agents and handling contacts.	Yes	Resource Level

Amazon Connect AppIntegrations service quotas

Name	Default	Adjustable
Data integration associations per data integration	10	Yes
Data integrations per Region	10	Yes
Event integration associations per event integration	10	Yes
Event integrations per Region	10	Yes
Application per region (third-party application)	25	No

Amazon Q in Connect service quotas

Item	Default quotas	Adjustable
Assistants	5	No
Knowledge bases	10	No
Assistant associations	1	No
Maximum size of a knowledge base	5GB per knowledge base	No
Quick responses per knowledge base	1,000	No

Item	Default quotas	Adjustable
Content per knowledge base	5,000 Examples of content are frequently asked questions (FAQs), wikis, articles, and step-by-step instructions for handling different customer issues.	No
Maximum size per document	1MB	No
RateLimit for all APIs	10TPS The rate limit for DeleteQuickResponse and SearchQuickResponses is 20TPS	No

Amazon Connect Cases service quotas

Name	Default	Adjustable
Cases domains per AWS account	5	Yes
Fields in a Cases domain	500	Yes
Field options per single-select field in the Cases domain	500	Yes
Layouts in a Cases domain	100	Yes

Name	Default	Adjustable
Templates in a Cases domain	100	Yes
Related items that can be attached to a case	200	Yes
Files that can be attached to a case	50	Yes
Case fields per case layout	100	Yes

Contact Lens service quotas

Name	Default	Adjustable
Concurrent real-time calls with analytics	50 100 for US East (N. Virginia)	Yes
Concurrent post-call analytics jobs	200 See Derive Concurrent post-call analytics jobs based on your Amazon Connect call volume.	Yes
Concurrent chat analytics jobs	200	Yes
Concurrent post-contact summary jobs (limit is shared between	10	Yes

Name	Default	Adjustable
all supported channels - voice, chat)		

Derive Concurrent post-call analytics jobs based on your Amazon Connect call volume

A post-call analytics job is kicked off after the completion of each contact with Contact Lens enabled. The time to complete a post-call analytics job can vary, but for planning purposes, you can estimate that it usually takes about 40% of the call length. If you choose 40% for your estimate, to calculate concurrent post-call analytics jobs, you would use the following formula:

$$(\text{average call duration in minutes}) * (0.4) * (\text{calls per hour}) / (60)$$

The following table shows some examples of what the approximate number of concurrent post call jobs would be if you assume the time to complete the analysis is 40%.

Average call duration (in minutes)	Calls per hour*	Approximate Concurrent post-call jobs
5	1000	33
10	500	33
10	1000	67
10	3000	200

*For the example calculations in the preceding table, we assume a fairly uniform distribution of calls during the hour. If you have more complex traffic patterns, [contact AWS Support](#) with details about your anticipated traffic pattern.

Amazon Connect Customer Profiles service quotas

Name	Default	Adjustable	Description
Amazon Connect Customer Profiles domain count	Each supported Region: 100	Yes	The maximum number of Amazon Connect Customer Profiles domains you can create in this account in the current AWS Region.
Keys per object type	Each supported Region: 10	Yes	The maximum number of keys that can be defined per object type in the current AWS Region.
Maximum expiration in days	Each supported Region: 1,098	Yes	The maximum expiration, in days, that can be defined for an object or profile in the current AWS Region.
Maximum number of calculated attributes per domain	Each supported Region: 50	No	The maximum number of calculated attributes per domain in the current AWS Region.
Maximum number of event stream per domain	Each supported Region: 1	No	The maximum number of event stream per domain in the current AWS Region.
Maximum number of integrations	Each supported Region: 50	Yes	The maximum number of integrations per domain in the current AWS Region.

Name	Default	Adjustable	Description
Maximum size of all objects for a profile	Each supported Region: 51,200 Kilobytes	Yes	The total size of a profile, including all of its related objects, in the current AWS Region.
Object and profile maximum size	Each supported Region: 250 Kilobytes	No	The maximum size of a single profile or profile object in the current AWS Region.
Object types per domain	Each supported Region: 100	Yes	The maximum number of object types you can define per domain in the current AWS Region.
Objects per profile	Each supported Region: 1,000	Yes	The maximum number of objects that can be attached to a single profile in the current AWS Region.

Amazon Connect Outbound campaigns service quotas

Name	Default	Adjustable	Adjustability
Campaigns	25 This is the maximum number of campaigns that an AWS account can configure.	Yes	Resource Level

Amazon Connect Voice ID service quotas

Item	Default quotas
Domains	3 This quota applies per account.
Concurrent active sessions per domain	50 See the following table for information about how to derive your Concurrent active sessions quota based on your Amazon Connect call volume.
Maximum number of fraudsters per watchlist	500
Maximum number of watchlists per domain	3, including the default watchlist of a domain
Maximum number of speakers per domain	100,000
Active Batch Speaker Enrollment Jobs per domain	1
Active Batch Fraudster Registration Jobs per domain	1
Speakers per Batch Speaker Enrollment Job	10,000
Fraudsters per Batch Fraudster Registration Job	500

Derive Concurrent active sessions based on your Amazon Connect call volume

Use the information in the following table to derive your quota for Voice ID **Concurrent active sessions per domain**. Base your quota on the number of voice calls handled by your Amazon Connect contact center where Voice ID is enabled.

Amazon Connect Voice Contacts (Calls)/Hour*	Voice ID Concurrent active sessions
1,000	50
5,000	250
10,000	500
20,000	1,000
50,000	2,500

*For the calculations in the preceding table, we assume a fairly uniform distribution of calls during the hour. If you have more complex traffic patterns, [contact AWS Support](#) with details about your anticipated traffic pattern.

How contacts are counted

The following contacts are counted in **Concurrent active calls per instance**:

- Handled by a flow
- Waiting in queue
- Handled by an agent
- Outbound call

The following contacts are not counted:

- Callbacks waiting in a callback queue are not counted until the callback is offered to an available agent.
- External transfers

If the quota for **Concurrent active calls per instance** is exceeded, contacts get a reorder tone (also known as a fast busy tone), which indicates that there is no available transmission path to the called number.

You can calculate your configured quota using CloudWatch metrics. For instructions, see [Use CloudWatch metrics to calculate concurrent call quota](#).

If you're only taking calls you can also determine your **Concurrent active calls per instance** quota by doing the following:

1. Navigate to the **Edit a queue** page: choose **Routing, Queues**, and choose a queue.
2. Choose **Set a limit across all channels**.
3. Enter an exceptionally large number in the **Maximum contacts in queue** box for the contact limit.

The resulting error message displays your quota as less than the sum of the following quotas combined: **Concurrent calls per instance + Concurrent active chats per instance + Concurrent active tasks per instance**.

For example, in the following image from the **Edit queues** page, you add 1 to the error message, to get **Concurrent calls per instance + Concurrent active chats per instance + Concurrent active tasks per instance** quota = 3010.

Maximum contacts in queue
Set the maximum contacts allowed to be in the queue at the same time.

Set a limit across all channels

Maximum contacts in queue
1000000

You cannot have more contacts in the queue than your total queued contacts per instance quota, which is currently 3009.

The quota for **Current active calls per instance + Concurrent active chats per instance + Current active tasks per instance**: 3009 + 1 = 3010

The error message shows 3009 because you must always set **Maximum contacts in queue** to a number that is at least 1 *less than* your combined quota (which is the default limit).

Amazon Connect feature specifications

Note

Feature specifications cannot be increased.

The following table lists Amazon Connect feature specifications.

Item	Feature Specification
Agent activity retention	24 months from the time the event occurred
File types supported for attachments to cases or chats	.csv, .doc, .docx, .heic, .jif, .jpeg, .jpg, .mov, .mp4, .pdf, .
Maximum file size for an attachment to a case or a chat	20MB
Maximum timeout for an attachment scanner	60 seconds
Maximum size of a real-time metrics report	200KB
When the Multi-Party Calls and Enhanced Monitoring for Voice capability is not enabled on your instance, the number of people who can listen in on the same agent call at the same time	<p>5</p> <p>For example, you can have a group of 5 people listen in to a call at the same time, and then a different group of 5 people listen in to a different call at the same time, and so on.</p> <p>The total number of participants on a call would look like this:</p> <ol style="list-style-type: none"> 1. Customer 2. Agent

Item	Feature Specification
	<ol style="list-style-type: none"> 3. Supervisor who can listen but not barge in the call 4. Supervisor who can listen but not barge in the call 5. Supervisor who can listen but not barge in the call 6. Supervisor who can listen but not barge in the call 7. Supervisor who can listen but not barge in the call
<p>When the Multi-Party Calls and Enhanced Monitoring for Voice capability is enabled on your instance, the number of people who can be on the same agent call at the same time</p>	<p>2</p> <p>There can be four participants in total:</p> <ol style="list-style-type: none"> 1. Customer 2. Agent 3. Supervisor who can barge in the call 4. Supervisor who can listen but not barge in the call
<p>Quick connects you can assign to a queue</p>	<p>700</p>
<p>Participants on a conference call</p>	<p>6</p> <p>The participants are the customer, agent, and others who can be agents or external third-parties.</p>
<p>Contact record retention</p>	<p>24 months from the time the associated contact was initiated.</p> <p>You can choose to stream contact records to Kinesis so you can manage retention and perform advanced analysis.</p>

Item	Feature Specification
Maximum size of the contact record attributes section	32KB
Maximum size of the returned data in a Lambda function	Less than 32KB of UTF-8 data
Limit on creating and deleting instances	<p>100 instances can be created or deleted in 30 days</p> <p>Amazon Connect enforces a limit on the total number of instances that you can create and delete in 30 days. If you exceed this limit, you will get an error message indicating there has been an excessive number of attempts at creating or deleting instances. You must wait 30 days before you can restart creating and deleting instances in your account.</p> <p>For example, if you create 80 instances and delete 20 over the course of 30 days, you must wait an additional 30 days before you can create or delete any more instances. If you create and delete the same instance 100 times in 30 days, the limit also applies.</p>
Searchable custom contact attributes	50
Replica instances (created by using the ReplicateInstance API)	5 per account
Traffic distribution groups	8 per replicated instance

Chat feature specifications

Item	Feature Specification
Attachments per chat conversation	35
Active chats per agent	10
Number of custom participants on a contact	1
Number of chat contacts that a supervisor can monitor concurrently	Depends on the number of concurrent chats limit set in the supervisor's routing profile
Number of people who can monitor the same agent chat at the same time regardless of whether the Barge and Enhanced Monitoring for Chat capability is enabled for an instance	<p>5</p> <p>For example, you can have a group of 5 people monitor a chat at the same time, and then a different group of 5 people monitor a different chat at the same time, and so on.</p> <p>The total number of participants on the chat would look like this:</p> <ol style="list-style-type: none"> 1. Customer 2. Agent 3. Supervisor who can monitor the chat but not barge in 4. Supervisor who can monitor the chat but not barge in 5. Supervisor who can monitor the chat but not barge in 6. Supervisor who can monitor the chat but not barge in 7. Supervisor who can monitor the chat but not barge in
Number of supervisors who can barge in on a chat between an agent and a customer when	1

Item	Feature Specification
the Barge and Enhanced Monitoring for Chat capability enabled for an instance	Only 1 supervisor can be in barged in mode for a given chat.
Number of calls that a supervisor can listen to at the same time	1
Total duration per chat	<p>Up to 7 days, including wait time</p> <ul style="list-style-type: none"> The default is 25 hours. You configure the chat duration using StartChatContact API and add the <code>ChatDurationInMinutes</code> parameter. Minimum configurable chat duration is 1 hour (60 minutes). Maximum configurable chat duration is 7 days (10,080 minutes).
Characters per chat message	1024
Open websocket connections per chat participant	5
Chat Amazon Lex bot integration timeout	<p>10 seconds</p> <p>The maximum time within which the Amazon Lex bot must respond to the chat customer's prompt.</p>
Past chat transcript file size. This applies to persistent chat .	5MB
Number of past contacts that can be traversed by Amazon Connect chat. This applies to persistent chat .	100
Communications widgets that can be created and customized per instance	20

Task feature specifications

Item	Feature Specification
Task templates per instance	50
Task template customized fields per instance	50
Maximum duration of a task	7 days
Maximum number of transfers for a task	11 transfers
Maximum number of linked tasks on an existing contact	11

Forecasting, capacity planning, and scheduling feature specifications

Item	Feature Specification
Agents per schedule generation run	800
Agents per staffing group	80
Capacity plans per instance	500
Capacity scenarios per instance	500
Capacity plan user data uploads per instance	500
Capacity plan override uploads per instance	5000
Concurrent uploads per instance	20
File size per upload of agent time off data	1GB
File size per upload of time off group allowance data	1GB The .csv file can cover up to 13 months.
File size per upload of capacity plan user data	1GB

Item	Feature Specification
File size per upload of capacity plan overrides	250MB
File size per upload of forecast overrides	250MB
File size per upload of historical actuals	1GB
Forecast groups per instance	500
Forecast override uploads per instance	500
Historical actuals uploads per instance	50
Queues per forecast group	200
Schedules per instance	600
Shift activities per instance	300
Shift activities per shift profile	10
Shift profiles per instance	1300
Staffing groups per forecast group	100
Staffing groups per instance	1300
Staffing groups per supervisor/manager	45
Supervisors/managers per staffing group	40

Integration association resource feature specifications

The following table lists feature specifications for the integration association resource. It lists how many of each type of integration association resource can be ingested.

Item	Feature Specification
Attachment scanner	1

Item	Feature Specification
Voice ID domain	1
Amazon Pinpoint app	1
Event	10 The event integration resource is used for task triggers.
Amazon Q in Connect assistant	1
Amazon Q in Connect knowledge base	10
Cases domain	1

Amazon Connect Contact Lens feature specifications

Item	Feature Specification
Custom vocabularies	20
Contact Lens rules for post-call	500
Contact Lens rules for post-chat	500
Contact Lens rules for real-time	500

Evaluation forms feature specifications

Item	Feature Specification
Maximum number of evaluation forms per instance	50
Historical versions are not counted, only form names are counted.	

Item	Feature Specification
Maximum number of versions per form	50
Maximum number of sections per form	100
Maximum number of questions per form	100
Maximum nesting level of sections	2 (sections can have sub-sections, but sub-sections cannot have sub-sub-sections)
Definition title length	1-128 characters
Section title length	1-128 characters
Question title length	1-350 characters
Section instructions length	up to 1024 characters
Number of answer options for single select questions	2-256 answer options
Answer option text length for single select questions	1-128 characters

Amazon Connect Rules feature specifications

The following table lists feature specifications for Amazon Connect Rules.

Item	Feature Specification
Conditions in a rule	20
Rules per event source type	500

Condition type	Number of entries or selections	Post-call	Post-chat	Real-time
Evaluation - Form score	20	N/A	N/A	N/A
Evaluation-Section score	20	N/A	N/A	N/A
Evaluation-Question score	20	N/A	N/A	N/A
Evaluation - Results available	20	N/A	N/A	N/A
Words or phrases - Exact match	100	Yes	Yes	Yes
Words or phrases - Semantic match	4	Yes	Yes	Not supported
Words or phrases - Pattern match	100	Yes	Yes	Yes
Queue condition	100	Yes	Yes	Yes
Agent condition	100	Yes	Yes	Yes
Custom attributes	5	Yes	Yes	Yes
Sentiment - Time period	5	Yes	Yes	Yes

Condition type	Number of entries or selections	Post-call	Post-chat	Real-time
Sentiment - Entire contact	5	Yes	Yes	Not supported
Interruptions	5	Yes	Yes	Not supported
Response time	4 hours	Not supported	Yes	Not supported
Non-talk time	5 hours	Yes	Not supported	Not supported

Countries you can call by default

The Region where your instance is created determines which countries you can call by default.

For a list of all the countries available for outbound calling, see [Amazon Connect pricing](#).

If you already have an instance, the countries that you are allowed to call may be different than those listed in the following sections because we have changed the service quotas over time.

Prefixes that are not allowed by default

UK mobile numbers with the following prefix are not allowed by default:

- +447

Before you can dial these UK mobile numbers, you must submit a service quota increase request.

Japan mobile numbers with the following prefixes are not allowed by default:

- +8170, 8180, and 8190

Before you can dial these Japan mobile numbers, you must submit a service quota increase request.

How to allow calling to additional countries

Use the following instructions to allow calling to additional countries, or to limit the countries that you can call from.

1. Choose [Account and billing](#) to go to the pre-populated form in the AWS Support console. You must be signed in to your AWS account to access the form.
2. For **Service**, *Connect (Number Management)* should be selected.
3. For **Category**, *Country Allowlisting for Outbound Calls* should be selected.
4. Select the required severity.
5. Choose **Next step: Additional information**
6. On the **Additional information** page:
 - a. Enter the subject.
 - b. Under **Description**, list which countries you want to allow calling to, or limit calling from.
7. Choose **Next step: Solve now or contact us**.
8. On the **Solve now or contact us** page:
 - Choose the **Contact us** tab and select your **Preferred contact language** and your preferred contact method.
9. Choose **Submit**.
10. The Amazon Connect team will review your ticket and get back to you.

Instances created in US East, US West, Canada (Central) and AWS GovCloud (US-West)

You can call the following countries by default:

- United States
- Canada
- Mexico
- Puerto Rico
- United Kingdom: See [Prefixes that are not allowed by default](#)

Instances created in Africa (Cape Town)

You can call the following countries by default:

- South Africa
- United Kingdom

- United States

Instances created in Asia Pacific (Seoul)

You can call the following countries by default:

- South Korea
- United Kingdom
- United States

Instances created in Asia Pacific (Singapore)

You can call the following countries by default:

- Singapore
- Australia
- Hong Kong
- United States
- United Kingdom: See [Prefixes that are not allowed by default](#)

Instances created in Asia Pacific (Sydney)

You can call the following countries by default:

- Australia
- New Zealand
- United States

Instances created in Asia Pacific (Tokyo)

You can call the following countries by default:

- Japan: See [Prefixes that are not allowed by default](#)
- Vietnam
- United States

Instances created in EU (Frankfurt) and EU (London)

You can call the following countries by default:

- United Kingdom: See [Prefixes that are not allowed by default](#)
- Italy
- France
- Ireland
- United States

API throttling quotas

Amazon Connect API throttling quotas

Amazon Connect throttling quotas are by account, and per Region, not by user and not by instance. For example:

- If different users from the same account make requests, they are sharing a throttle bucket.
- If multiple requests are sent from different instances from the same account, they are also sharing a throttle bucket.

When you use the [Amazon Connect Service API](#), all operations have a RateLimit of 2 requests per second and a BurstLimit of 5 requests per second, **with the following exceptions:**

Operation	Rate limit	Burst limit
For all Evaluations actions	1 request per second	
GetMetricData	5	8
* GetCurrentMetricData	5	8
StartContactStreaming	5	8
StartChatContact	5	8
StopContactStreaming	5	8

Operation	Rate limit	Burst limit
CreateParticipant	5	8
GetContactAttributes	10	15
UpdateContactAttributes	10	15
DescribeContact	10	15
StopContact	10	15
UpdateContact	10	15
ListContactReferences	10	15
BatchPutContact	10	15
TagContact	20	25
UntagContact	20	25
UpdateContactRoutingData	20	20

Important

*GetCurrentMetricData, as well as GetCurrentUserData and GetMetricDataV2, may incorrectly display 200 as their throttling quota in the Service Quotas console. We recommend you use the specified default quota as your limit or open a ticket.

Amazon Connect Cases API throttling quotas

API	Default TPS throttling limits
CreateCase, SearchCases, UpdateCase, AssociateContact, ListTemplates, CreateRelatedItem, SearchRelatedItems	10

API	Default TPS throttling limits
CreateField, ListFields, CreateDomain, GetDomain, CreateTemplate, BatchPutFieldOptions, CreateLayout, UpdateLayout, UpdateTemplate, UpdateField	5
BatchGetField	25
GetCase	15
GetTemplate, GetLayout	20
ListFieldOptions	15

Amazon Connect Contact Lens Service API throttling quotas

Amazon Connect Contact Lens throttling quotas are by account, not by user and not by instance. For example:

- If different users from the same account make requests, they are sharing a throttle bucket.
- If multiple requests are sent from different instances from the same account, they are also sharing a throttle bucket.

When you use the [Amazon Connect Contact Lens API](#), the number of requests per second is limited to the following:

- [ListRealtimeContactAnalysisSegments](#): a RateLimit of 1 request per second, and a BurstLimit of 2 requests per second.
- [ListRealtimeContactAnalysisSegmentsV2](#): a RateLimit of 2 request per second, and a BurstLimit of 5 requests per second.

Amazon Connect Customer Profiles API throttling quotas

API	Default TPS throttling limits
ListDomains	5

API	Default TPS throttling limits
GetDomain	5
CreateDomain	1
UpdateDomain	1
DeleteDomain	1
ListProfileObjectTypes	5
GetProfileObjectType	10
PutProfileObjectType	1
DeleteProfileObjectType	1
ListProfileObjectTypeTemplates	5
GetProfileObjectTypeTemplate	5
ListIntegrations	5
GetIntegration	5
PutIntegration	1
DeleteIntegration	1
ListIdentityResolutionJobs	5
GetIdentityResolutionJob	5
GetAutoMergingPreview	1
CreateEventStream	1
ListEventStreams	5
DeleteEventStream	5

API	Default TPS throttling limits
GetEventStream	5
CreateCalculatedAttributeDefinition	1
GetCalculatedAttributeDefinition	5
UpdateCalculatedAttributeDefinition	1
DeleteCalculatedAttributeDefinition	5
ListCalculatedAttributeDefinitions	5
CreateIntegrationWorkflow	5
DeleteWorkflow	5
ListWorkflows	5
GetWorkflow	5
GetWorkflowSteps	5
SearchProfiles	100
ListProfileObjects	100
GetMatches	100
GetSimilarProfiles	100
ListRuleBasedMatches	5
GetCalculatedAttributeForProfile	100
ListCalculatedAttributesForProfile	100
CreateProfile	100
UpdateProfile	100

API	Default TPS throttling limits
PutProfileObject	100
AddProfileKey	100
DeleteProfile	100
DeleteProfileObject	100
DeleteProfileKey	100
MergeProfiles	100
TagResource	5
UntagResource	5
ListTagsForResource	5
ListAccountIntegrations	100

Amazon Connect Outbound Campaigns Service API throttling quotas

Outbound campaigns throttling quotas are by account, and per Region, not by user and not by instance. For example:

- If different users from the same account make requests, they are sharing a throttle bucket.
- If multiple requests are sent from different instances from the same account, they are also sharing a throttle bucket.

When you use the [Amazon Connect Outbound Campaigns Service](#) API, the number of requests per second is limited to the following:

- The following APIs have a RateLimit of 1 requests per second, and a BurstLimit of 2 requests per second:
 - [CreateCampaign](#)
 - [DeleteCampaign](#)

- [PauseCampaign](#)
 - [ResumeCampaign](#)
 - [StartCampaign](#)
 - [StopCampaign](#)
 - [UpdateCampaignDialerConfig](#)
 - [UpdateCampaignName](#)
 - [UpdateCampaignOutboundCallConfig](#)
 - [ListTagsForResource](#)
 - [TagResource](#)
 - [UntagResource](#)
- The following APIs have a RateLimit of 5 requests per second, and a BurstLimit of 10 requests per second:
- [GetCampaignState](#)
 - [GetCampaignStateBatch](#)
 - [ListCampaigns](#)
- For [PutDialRequestBatch](#) API, the throttling quota is 10 request per second.
- For [DescribeCampaign](#) API, a RateLimit of 25 requests per second, and a BurstLimit of 35 requests per second.
- For all other operations, a RateLimit of 2 requests per second, and a BurstLimit of 5 requests per second.

Amazon Connect Participant Service API throttling quotas

For the Amazon Connect Participant Service, the quotas are by instance.

When you use the [Amazon Connect Participant Service API](#), the number of requests per second is limited to the following:

- [CompleteAttachmentUpload](#): a RateLimit of 2 requests per second, and a BurstLimit of 5 requests per second.
- [CreateParticipantConnection](#): a RateLimit of 6 requests per second, and a BurstLimit of 9 requests per second.

- [DisconnectParticipant](#): a RateLimit of 3 requests per second, and a BurstLimit of 5 requests per second.
- [GetAttachment](#): a RateLimit of 8 requests per second, and a BurstLimit of 12 requests per second.
- [GetTranscript](#): a RateLimit of 8 requests per second, and a BurstLimit of 12 requests per second.
- [SendEvent](#) and [SendMessage](#): a RateLimit of 10 requests per second, and a BurstLimit of 15 requests per second.
- [StartAttachmentUpload](#): a RateLimit of 2 requests per second, and a BurstLimit of 5 requests per second.

Amazon Connect Voice ID Service API throttling quotas

API	Default TPS throttling limits
EvaluateSession	60
Domain APIs: CreateDomain, DescribeDomain, UpdateDomain, DeleteDomain, ListDomains	2
Batch APIs: StartSpeakerEnrollmentJob, DescribeSpeakerEnrollmentJob, ListSpeakerEnrollmentJobs, StartFraudsterRegistrationJob, DescribeFraudsterRegistrationJob, ListFraudsterRegistrationJobs	
ListSpeakers	5
DescribeSpeaker, OptOutSpeaker, DeleteSpeaker, DescribeFraudster, DeleteFraudster	10
CreateIntegrationAssociation, DeleteIntegrationAssociation, ListIntegrationAssociation	2
TagResource, UntagResource, ListTagsForResource	2

Get started with Amazon Connect

Use these steps to set up your contact center.

1. [Create an Amazon Connect instance](#). Use an instance to contain all the resources and settings related to your contact center. You specify how you plan to manage user accounts, whether your contact center will accept incoming calls and make outbound calls, and review the location where data will be stored in your Amazon S3 bucket.
2. [Set up phone numbers to use the Amazon Connect service](#). If you're using voice, either claim a phone number that AWS provides, or port your current phone number to Amazon Connect. If you choose to port your numbers, we suggest claiming a number so you can test Amazon Connect and build your contact center while waiting for your numbers to be ported over.
3. [Set up routing](#). Create your queues and routing profiles, and set your hours of operation. In your routing profiles, specify the channels that agents should use: voice, chat, tasks, or all three. You also specify how many chats and tasks an agent can manage at the same time.
4. [Create Amazon Connect Flows](#). Establish a flow to define the customer experience with your contact center from start to finish. A single flow works for voice, chat, and tasks, which makes your design more efficient. When you build flows and configure the blocks, indicate how the flow should work for voice, chat, and tasks.
5. Add users, which are your managers and agents, and configure their settings. Assign a routing profile to each agent, specify whether they are using a softphone or desk phone, and set how long they have for **After contact work**. For instructions, see [Add users to Amazon Connect](#) and [Set up agents](#).
6. If you're using chat, we provide several tools to help you enable your customer-facing app to engage with Amazon Connect chat. For more information, see [Set up your customer's chat experience](#).

Next steps

There's a lot you can do to optimize your contact center. Here are a couple of additional steps that you may find useful:

1. [Set up recording behavior](#). Monitor live conversations and review past conversations. This is a way that managers can coach agents and help them improve. For voice conversations, set up recording in your flows. For chat conversations, set up recording at the instance level.

To learn how to monitor conversations, see [Set up live monitoring for voice and/or chat](#).

2. [Add an Amazon Lex bot to Amazon Connect](#). Use Amazon Lex in your contact center to reduce the load on your agents. For example, a bot can handle the initial interaction before the chat is routed to an agent, and also answer common questions for the customer.

Take a free online class

Check out the following free online classes:

- [Introduction to Amazon Connect and the Contact Control Panel \(CCP\)](#)
- [Amazon Connect: Introduction to the Administrative Interface](#)
- [Amazon Connect: Creating and Managing Amazon Connect Instances](#)
- [Amazon Connect: Implementing Chat in Amazon Connect](#)
- [Amazon Connect: Implementing Tasks in Amazon Connect](#)

Amazon Connect concepts

Amazon Connect enables you to create an **omnichannel contact center**: a contact center that provides a unified experience across multiple channels, such as voice, chat and SMS messaging, and tasks.

- You use the same routing profiles, queues, flows, metrics, and reports for all channels.
- Managers monitor all channels from one dashboard.
- Agents handle all customers from just one interface. If a customer interaction starts with chat and moves to voice, the agent handling the voice call has the complete chat transcript so context is preserved.

You can create highly personalized experiences for your customers using omnichannel communications, and separate the channels where needed. For example, you can dynamically offer chat and/or voice contact based on such factors as customer preference, estimated wait times, and agent skill.

This section explains concepts that will help you set up your Amazon Connect contact center, whether you use one channel or more.

Contents

- [Concepts: Telephony capabilities in Amazon Connect](#)
- [Concepts: Web and mobile messaging capabilities in Amazon Connect](#)
- [Concepts: Tasks in Amazon Connect](#)
- [Concepts: Pause and resume tasks](#)
- [Concepts: Routing profiles](#)
- [Concepts: Standard queues and agent queues](#)
- [Concepts: Queues priority and delay](#)
- [Concepts: Queue-based routing](#)
- [Concepts: Channels and concurrency](#)
- [Concepts: Amazon Connect Flows](#)

Concepts: Telephony capabilities in Amazon Connect

Important

Trying to contact Amazon for support? See [Amazon Customer Service](#) (Amazon orders and deliveries) or [AWS Support](#) (Amazon Web Services).

Amazon Connect provides a variety of choices to enable your company to make and receive telephone calls. One of the great advantages of Amazon Connect is AWS manages the telephony infrastructure for you: carrier connections, redundancy, and routing. And, it's designed to scale.

This topic explains the options that Amazon Connect provides for telephony, which helps you build a solution to meet your business requirements.

Contents

- [Telephony architecture](#)
- [Use cases for different configurations](#)

Telephony architecture

Amazon Connect provides capabilities to host both toll-free and direct dial numbers (DID) in all AWS Regions supported by Amazon Connect. You can use both types of numbers in a single

instance. A complete list of supported countries/regions and costs is located on the [Amazon Connect pricing](#) page.

AWS manages the connectivity to our network of carriers providing diverse connections to multiple carriers in each region supported by Amazon Connect. When Amazon Connect is deployed in a Region, we take advantage of the built-in redundancy of the AWS Availability Zone design to provide multiple carrier interfaces into multiple data centers. You can see how AWS manages the design of a Region [here](#).

In addition to the Amazon Connect service being spread across multiple Availability Zones, AWS also has multiple telephony providers. These providers have multiple links into the data centers in those Availability Zones. This ensures that if a single or even multiple links fail from a carrier, there are alternate routes available to ensure the service remains available.

To learn more about Amazon Connect architecture, see [Architectural guidance for Amazon Connect](#).

- **AWS manages toll-free numbers as a Responsible Organization**

These numbers are phone numbers with distinct prefix codes that can be dialed with no charge to the person placing the call. Such numbers allow callers to reach businesses and/or individuals out of the area without being charged a long-distance fee for the call.

In the United States, the [Federal Communications Commission](#) provides rules for obtaining and using toll-free numbers. In other countries, similar governing bodies ensure that such numbers are managed and distributed in accordance with local laws.

When you claim or port a US toll-free number into Amazon Connect, we register that number with [SOMOS](#). After the number is registered, we are able to select multiple carriers to provide BOTH route and carrier redundancy. This provides the highest level of availability, ensuring the number will remain available even in the event of a complete carrier outage. This level of service does come at an additional cost, as these numbers are a higher price than direct dial, but the service reliability and customer experience make this the most attractive option.

- **Locally formatted numbers**

Direct inward dialing (DID), also called direct dial-in (DDI) in Europe, is a telecommunication service offered by telephone companies to subscribers. DID numbers provide a locally formatted telephone number that can match the dialing pattern of a local subscriber. For example, in

Seattle, Washington, USA, the local dialing pattern is +1(206)-NXX-XXXX. The provider of the DID number would provide numbers with the +1(206) pattern to match local dialing.

In the United States, DID numbers are regulated by State Public Utilities commissions. DID numbers are managed by a single carrier. While they are portable, they can't be load balanced/managed across multiple carriers. This makes them less reliable than toll-free numbers.

DID numbers offer you the ability to present a local calling line identification when placing outbound calls, and a local presence to inbound callers. This can be very useful to increase the likelihood outbound and queued callback calls get answered by your customers. It can also show a customer that you are local to their area, and provide a cheaper inbound route than a long-distance call if you don't publish a toll-free number.

Because DID numbers are threaded to single carrier, Amazon Connect doesn't offer carrier redundancy for DID numbers. We do offer link redundancy across multiple Availability Zones, so in the event of a link failure that carrier still has facilities available in another location to deliver calls. DID numbers also have a capacity limitation on how many calls a single number can accommodate, and this number does vary by Region. It is important to work with your AWS account team to ensure you are properly enabled with the right type of DID numbers if you plan on using DID numbers as your primary inbound channel, and have an expectation of over 100 concurrent calls per number.

DID numbers are less expensive than toll-free numbers, but don't have the redundancy and broad geographical coverage of them. The ability to localize numbers may be an attractive option for your business.

Use cases for different configurations

Starting fresh with Amazon Connect

In this case, simply select new numbers using the claim a number process. For instructions, see [How to get a Connect phone number in your current country](#).

Migrating to Amazon Connect from another provider/platform

If you're migrating to Amazon Connect from other platform, we recommend starting with a proof of concept, and migrating to Amazon Connect over time.

- A best practice is to forward your existing numbers to a new number (or numbers) claimed in Amazon Connect until you are fully converted.

- After fully converting, use the [porting process](#) to bring your numbers into Amazon Connect.
- This gives you a fallback in case you have migration issues.

Maintaining two separate platforms

In some cases, you may have more than one Contact Center platform requiring telephony. Here's an overview of how to configure this:

- Choose which platform is the initial call-handling service, and forward to the other platform.
- If Amazon Connect is the primary call handling platform, you can port or claim numbers. You will design your flows to transfer calls to the other platform on a telephone number you will provide in the flow.
- If the external platform is the primary call handler, you will need to configure that platform to forward calls to a number you claim in Amazon Connect. Choose either a toll-free number, which will give you better redundancy and capacity at an increased cost, or a bank of DID numbers to terminate the call into Amazon Connect.
- For the use case, we recommend that you engage AWS Solution Architecture support to ensure your contact center is well-architected to achieve the best possible outcomes.

Concepts: Web and mobile messaging capabilities in Amazon Connect

Important

Trying to contact Amazon for support? See [Amazon Customer Service](#) (Amazon orders and deliveries) or [AWS Support](#) (Amazon Web Services).

Amazon Connect lets you build chat messaging features—mobile chat, web chat, SMS, and third-party messaging services— into your website and mobile apps. It enables your customers to start chatting with contact center agents from any of your business applications, web or mobile.

Interactions are asynchronous, enabling your customers to start a chat with an agent or Amazon Lex bot, step away from it, and then resume the conversation again. They can even switch devices and continue the chat.

Contents

- [Multiple channels, one experience](#)

- [Getting started](#)
- [Example chat scenario](#)
- [When do chats end?](#)
- [Pricing](#)
- [More information](#)

Multiple channels, one experience

Agents have a single user interface to help customers using voice, chat, and tasks. This reduces the number of tools that agents have to learn and the number of screens they have to interact with.

Chat activities integrate into your existing contact center flows and the automation that you built for voice. You build your flows once and reuse them across multiple channels.

Metrics collection and the dashboards you built automatically benefit from the unified metrics across multiple channels.

Getting started

To add chat messaging capabilities to your Amazon Connect contact center and allow your agents to engage in chats, perform the following steps:

- Chat is enabled at the instance level when [an Amazon S3 bucket is created for storing chat transcripts](#).
- [Add chat to your agent's routing profile](#).
- Optionally, you can set up chat subtypes such as SMS messaging. You procure an SMS-enabled phone number by using Amazon Pinpoint SMS, import it into Amazon Connect, and then assign it to your flows. For more information, see:
 - [Request an SMS-enabled phone number through Amazon Pinpoint SMS](#)
 - [Set up SMS messaging](#)

Agents can then begin accepting chats through the Contact Control Panel.

You can see real-time and historical metrics for the chat messaging channel (for example, arrival time, handle time) as part of their overall Chat channel metrics in the same reporting experience used for calls/chats/tasks in order to assess agent performance and productivity.

Amazon Connect provides several resources to help you add chat to your website. For more information, see [Set up your customer's chat experience](#).

Example chat scenario

A customer and agent are chatting. The customer stops responding to the agent. The agent asks "Are you there?" and doesn't get a reply. The agent leaves the chat. Now the chat is no longer associated with an agent. Your flow determines what happens next.

In this scenario, the customer eventually sends another message ("Hey, I'm back") and the chat resumes. Depending on the logic that you define in the flow, the chat can be assigned to the original agent, or a different agent or queue.

Here's how you build this scenario:

1. Create a disconnect flow. The following image shows the [Sample disconnect flow](#) in the flow designer. This flow includes the following connected blocks: **Play prompt**, **Wait** which branches to three **Play prompts** (for **Customer returned**, **Time expired**, and **Error**), then **Transfer to queue** and **Disconnect**.

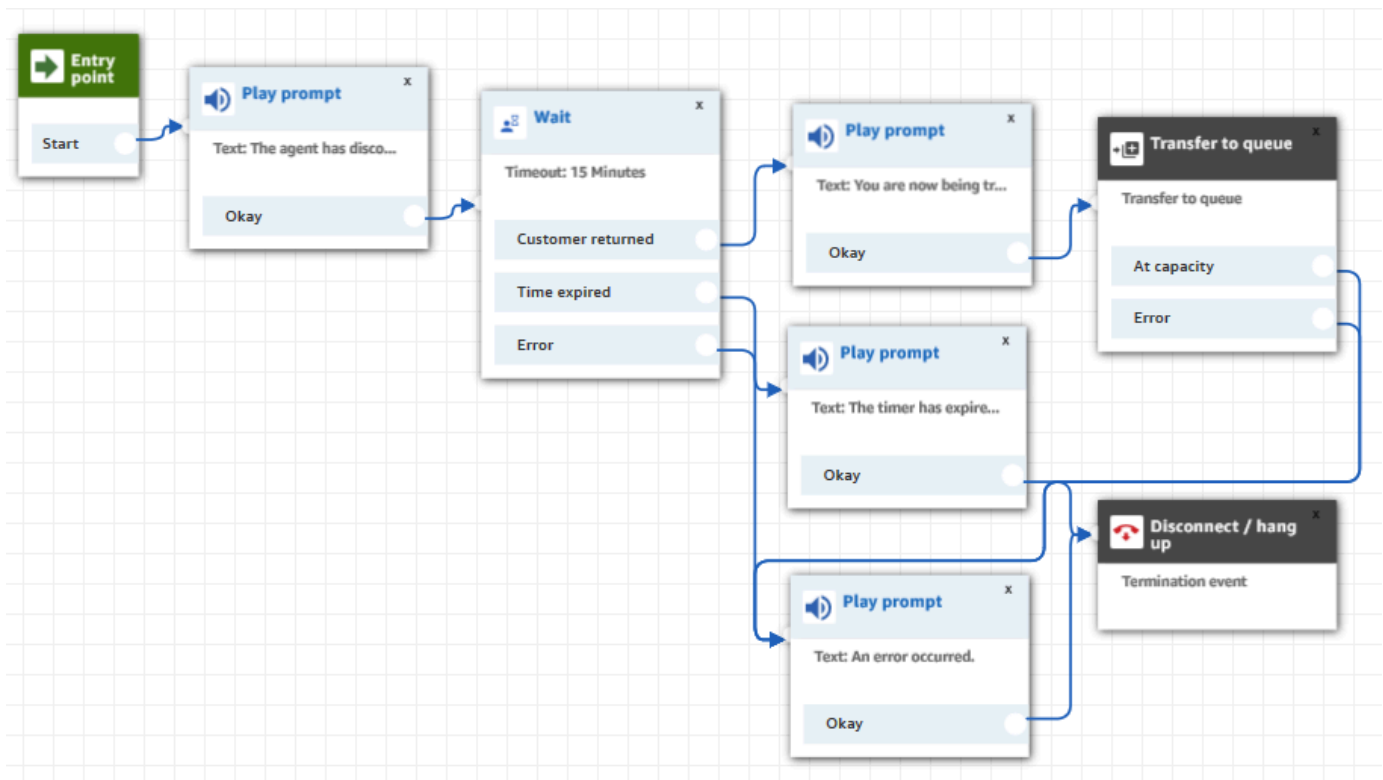

2. In the disconnect flow, add a [Wait](#) block. The Wait block has two branches:

- **Timeout:** Run this branch if the customer hasn't sent a message after a specified amount of time. The total duration of the chat, including multiple **Wait** blocks, cannot exceed 25 hours.

For example, for this branch you might just want to run a **Disconnect** block and end the chat.

- **Customer return:** Run this branch when the customer returns and sends a message. With this branch, you can route the customer to the previous agent, previous queue, or set a new working queue or agent.
3. In your inbound flow, add the [Set Disconnect Flow](#) block. Use it to specify that when the agent or Amazon Lex bot has disconnected from the chat and only the customer remains, the set disconnect flow should run.

In the following block, for example, we specified that the **Sample disconnect flow** should run.

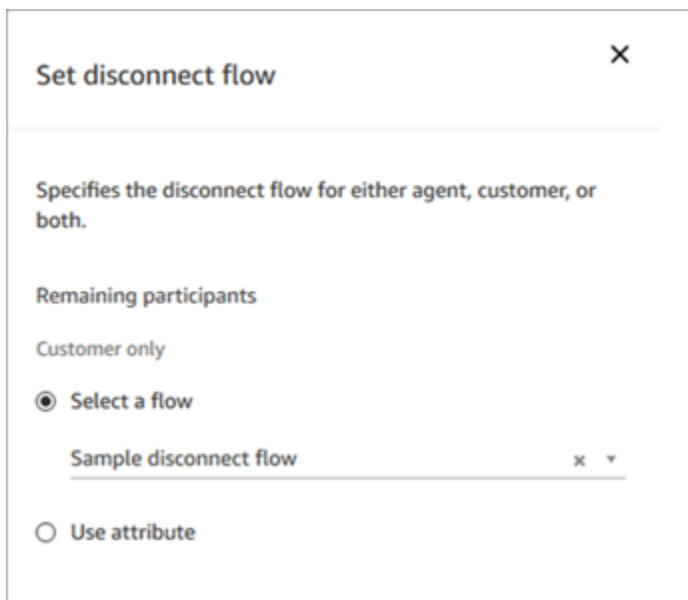

Set disconnect flow

Specifies the disconnect flow for either agent, customer, or both.

Remaining participants

Customer only

Select a flow

Sample disconnect flow

Use attribute

For an example that uses the **Set disconnect flow** block, see the [Sample inbound flow](#).

When do chats end?

By default, the duration for a chat conversation, including the time spent waiting when the customer isn't active, can't exceed 25 hours. However, you can change this default duration and instead configure a custom chat duration. You can configure a chat to last from a minimum of 1 hour (60 minutes) to up to 7 days (10,080 minutes). To configure a custom chat duration, call the [StartChatContact](#) API and add the `ChatDurationInMinutes` parameter.

During an ongoing chat session, there's no limit to the number of times a customer can leave and rejoin an existing ongoing chat session. To accomplish this, use the [Wait](#) block. For example, you might wait 12 hours for the customer to resume the chat before ending the chat session. If the customer tries to resume the chat after 12 hours, in the flow you can have an Amazon Lex bot ask if they're contacting you about the same issue or a different one.

By specifying a wait time that's significantly shorter than the chat duration, you help ensure that customers have a good experience. For instance, for a 25-hour duration chat, it's possible for the customer to resume a chat after 24 hours and 58 minutes, and then be cut off after two minutes because the conversation ends at the 25-hour limit.

Tip

If you're using Amazon Lex with chat, note that the default session timeout for an Amazon Lex session is 5 minutes. The total duration for a session can't exceed 24 hours. To change the session timeout, see [Setting the Session Timeout](#) in the *Amazon Lex Developer Guide*.

Pricing

Chat is charged on a per use basis. There are no required up-front payments, long-term commitments, or minimum monthly fees. You pay per chat message, independently of the number of agents or customers using it. Regional pricing may vary. For more information, see [Amazon Connect pricing](#).

More information

For more information about chat, see the following topics:

- [Test voice, chat, and task experiences](#)
- [How routing works with multiple channels](#)
- [Create a routing profile](#)
- [Amazon Connect Chat SDK and Sample Implementations](#)

Concepts: Tasks in Amazon Connect

Amazon Connect Tasks allows you to prioritize, assign, track, and even automate tasks across the disparate tools agents use to support customers. For example, using Tasks you can:

- Follow-up on customer issues recorded in a customer relationship management (CRM) solution such as Salesforce.
- Follow-up with a customer through a call.
- Complete actions in a business-specific system, such as processing a customer claim in an insurance application.

Currently, Amazon Connect Tasks can be used in compliance with [GDPR](#) and is approved for SOC, PCI, HITRUST, ISO, and HIPAA.

What is a task?

In a business a *task* is a unit of work that an agent must complete. This includes work that may have originated in external applications. In Amazon Connect this unit of work is a contact. It's routed, prioritized, assigned, and tracked just like a voice or chat contact. Everything that is applicable to a voice or chat contact is also applicable to a task contact.

Agents handle tasks in their Contact Control Panel (CCP), again just like any other contact. When assigned a task, agents see a notification with the description of the task, information associated with the tasks, and links to any applications that they might need to complete the task. The following image shows what an agent's CCP may look like when they manage tasks.

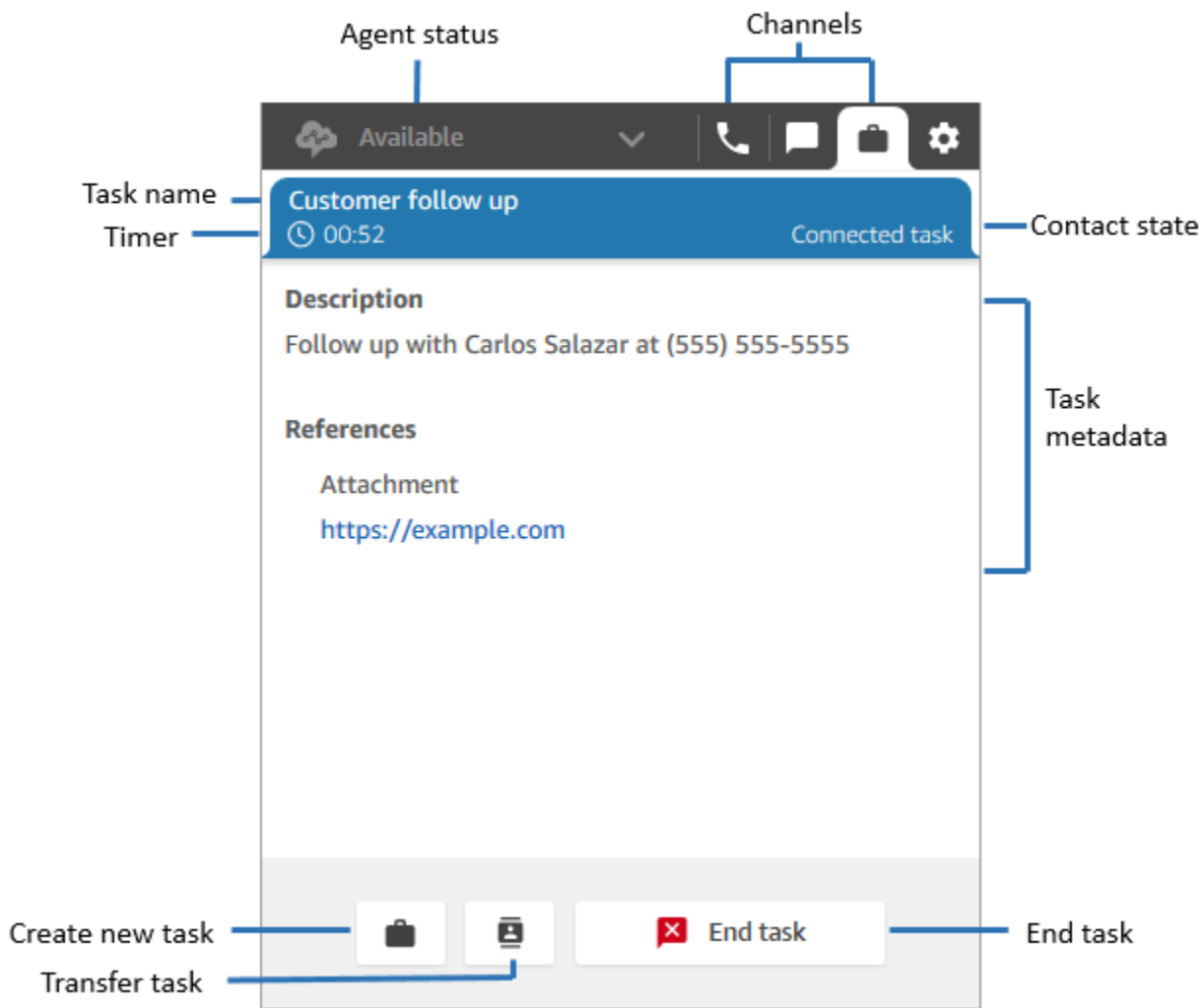

How to create tasks

Amazon Connect provides different ways for you to create tasks:

1. You can use pre-built connectors with CRM applications (for example, Salesforce and Zendesk) to automatically create tasks based on a set of pre-defined conditions, without any custom development.

For example, you can configure a rule in Amazon Connect to automatically create a task when a new case is created in Salesforce.

For more information, see [Set up applications for task creation](#) and [Create rules that generate tasks for third-party integrations](#).

2. You can integrate with your homegrown or business-specific applications to create tasks using Amazon Connect APIs.

For more information, see the [StartTaskContact](#) API.

3. You can add a [Create task](#) block to your flows. This block enables you to create and orchestrate tasks directly from flows based on customer input (DTMF input), and contact and tasks information.
4. You can enable your agents to create tasks from the Contact Control Panel (CCP) without you doing any development work.

For example, agents can create tasks to ensure follow up work is not forgotten, such as calling a customer back to provide a status update on their issue.

For more information, see [Test voice, chat, and task experiences](#).

For more information on getting started with tasks, see [Set up tasks](#).

Supported flow types

You can use tasks in the following flow types:

- Inbound flow
- Customer queue flow
- Agent whisper flow
- Transfer to queue flow
- Transfer to agent flow

Supported contact blocks

You can use tasks in the following flow blocks:

- Change routing priority/age
- Check contact attributes
- Check hours of operation
- Check queue status
- Check staffing
- Create task

- Disconnect / hang up
- Distribute by percentage
- End flow / resume
- Get queue metrics
- Invoke AWS Lambda function
- Loop
- Set contact attributes
- Set customer queue flow
- Set disconnect flow
- Set working queue
- Transfer to flow
- Transfer to queue
- Wait

Linked tasks

When using tasks with the [StartTaskContact](#) API, a new contact can be associated with an existing contact through `PreviousContactId` or `RelatedContactId`. This new contact contains a copy of the [contact attributes](#) from the linked contact.

The following code shows request syntax that includes `PreviousContactId` and `RelatedContactId`.

```
PUT /contact/task HTTP/1.1
Content-type: application/json

{
  "Attributes": {
    "string" : "string"
  },
  "ClientToken": "string",
  "ContactFlowId": "string",
  "Description": "string",
  "InstanceId": "string",
  "Name": "string",
  "PreviousContactId": "string",
```

```
"QuickConnectId": "string",
"References": {
  "string" : {
    "Type": "string",
    "Value": "string"
  }
},
"RelatedContactId": "string",
"ScheduledTime": number,
"TaskTemplateId": "string"
}
```

When you use `PreviousContactID` or `RelatedContactID` to create tasks, note the following:

- `PreviousContactID` - When contacts are linked using the `PreviousContactID`, updates that are made to contact attributes at any time in the chain will percolate through the entire chain.
- `RelatedContactID` - When contacts are linked using the `RelatedContactID`, updates that are made to contact attributes will percolate only to the contactID that is referenced in the [UpdateContactAttributes](#) API.

Note

You can specify only `PreviousContactID` or `RelatedContactID` in a request body, but not both. If you do specify both, Amazon Connect returns an `InvalidRequestException` error with a 400 status code.

For information about how `PreviousContactID` and `RelatedContactID` are modeled in contact records, see [ContactTraceRecord](#) in the contact records data model.

Agents can link tasks to outbound contacts

While agents are **actively working on a task**, the **Number pad** appears on the Contact Control Panel (CCP). If they make an outbound call using the Number pad, the call is automatically linked to the task. Amazon Connect links the task and outbound call by using the `relatedContactID` parameter.

The following image of the CCP shows the **Number pad** is available while the agent works on a task.

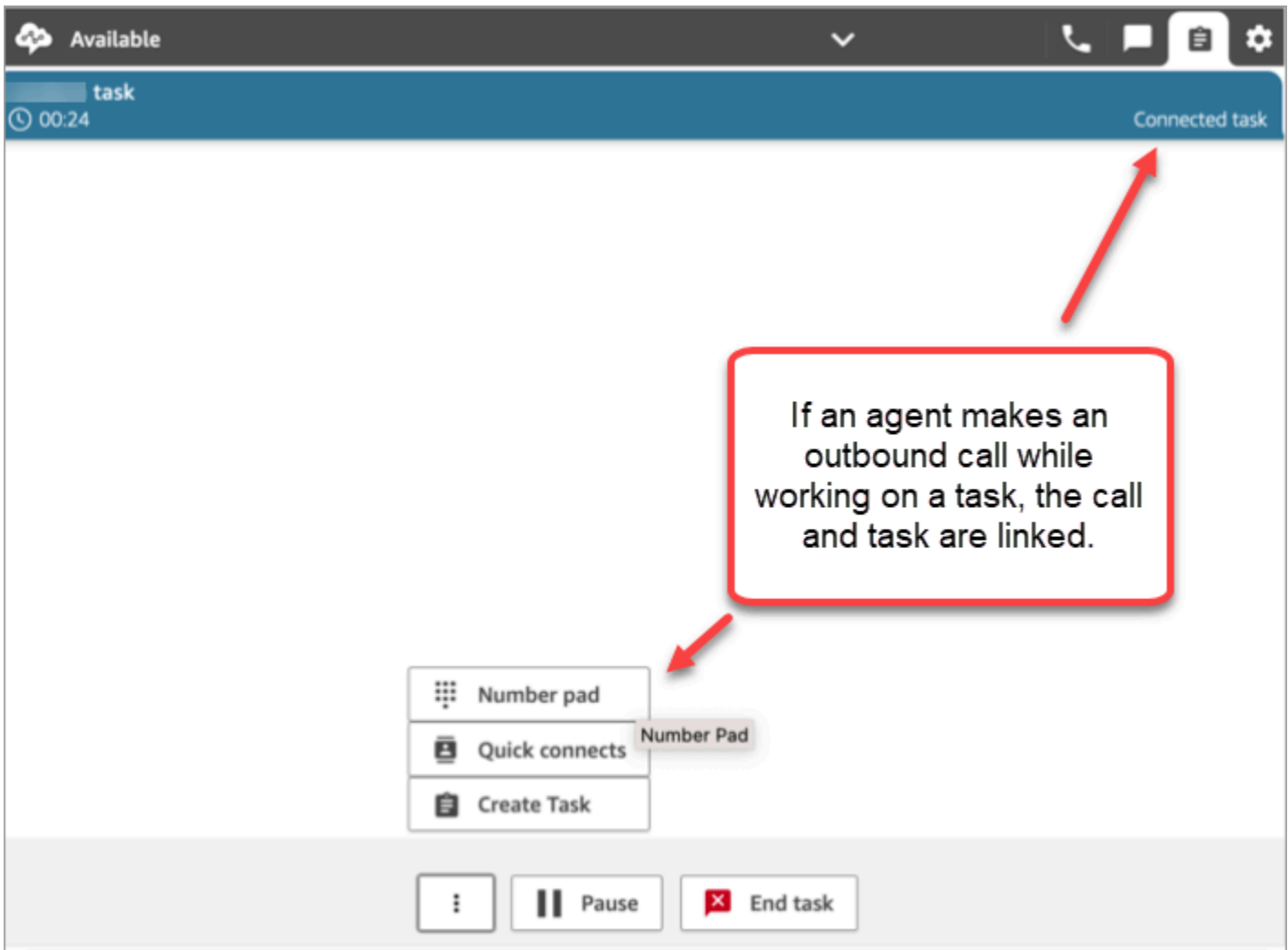

Link task to contact by using the Create task block

The Create task block enables you to automatically link the task to the current contact.

The following image of the Properties page of the Create task block shows the Link to contact option.

Creates a new task to run an assigned flow. [Info](#)

Create manually

Flow
Select a flow to run this task.

Set manually

Flow

Set dynamically

Name

Set manually

Name

Set dynamically

Set description

Set references

Schedule task

Task attributes
Define and store key-value pairs as contact attributes.

Destination key

Set manually

Value

Set dynamically

Add task attributes

Use template

Link to contact

Cancel Save

Using IAM? Add Task permissions

If your organization is using custom [IAM](#) policies to manage access to the Amazon Connect console, make sure users have the appropriate permissions to set up applications for task creation. For a list of required permissions, see [Tasks page](#).

Note

If your instance was created before October 2018, for information about how to configure your service-linked roles (SLR), see [For instances created before October 2018](#).

Track tasks in real-time and historical metrics reports

You can track the status of all tasks in real-time and historical metrics reports, just like you track contacts in other channels. For example, you can track:

- How long agents spent working on each task ([Agent on contact time](#)).
- The total time from when a task was created to when it was completed. ([Contact handle time](#)).

There are a few metrics that don't apply to tasks so you'll notice a value of 0 on the report for them:

Real-time metrics

- [Avg interaction and hold time](#)
- [Avg hold time](#)

Historical metrics

- [Agent interaction and hold time](#)
- [Agent interaction time](#)
- [Average agent interaction time](#)
- [Average customer hold time](#)

Manage tasks to custom service levels (SL)

While voice and chats may have short service level times based on seconds or minutes, you may have some tasks with service levels that are hours or days. You can create custom service level durations that are appropriate to each of your channels. For more information, see [real-time custom service levels](#) and [historical custom service levels](#).

When do tasks end?

The total duration of a task can be up to 7 days. A task ends when one of the following happens:

- An agent completes the task.
- A flow runs a [Disconnect / hang up](#) block, which ends the task.
- A task reaches the 7 day limit.
- You end the task using the [StopContact](#) API.

Search and review completed tasks

Use the [Contact search](#) page to search for and review completed tasks.

The following image is an example of what the **Contact Summary** and **References** look like in a contact record for a task.

Contact Record

Contact Summary

Contact Id	[REDACTED]
Name	Customer follow up
Description	Follow up with Carlos Salazar at (555) 555-5555
Channel	Task
Initiation Method	API
Start and end time	Nov 20, 20, 01:44:15 am - 02:00:55 am
Duration	00:16:40
Agent	Doe Jane
Queue	BasicQueue
Last Updated	Nov 20, 20, 02:02:08 am

References

Attachment	https://example.com
------------	---

The following data is appended to the contact record but not stored with it. The data is included in an export.

- Flow ID
- Potential attributes:
 - [ContactDetails](#)
 - Name: the name of the task
 - Description: the description of the task
 - [References](#): any links to forms or other sites

When task is scheduled for a future date and time, **Contact Summary** also displays **Scheduled time**.

More information

- [Amazon Connect feature specifications](#)
- [Accept a task](#)
- [Create a new task](#)
- [Transfer a task](#)

Concepts: Pause and resume tasks

You can pause and resume all tasks that aren't expired, disconnected, or scheduled for a later time. The benefit of pausing and resuming tasks is that it enables agents to free up an active slot so they can receive more critical tasks when their current task is stalled, for example, because of a missing approval or waiting on an external input.

You can also pause fully automated tasks to address force majeure events (natural disasters, infrastructure failures, invasions) that may require you to halt all business processes temporarily, and then resume them after the emergency has passed.

Contents

- [How paused and resumed tasks are queued](#)
- [How agents pause and resume tasks](#)
- [How many tasks an agent can pause](#)
- [When can a paused task be resumed?](#)
- [Programmatically pause and resume tasks](#)
- [Configure a flow to pause and resume tasks](#)
- [New events in the contact event stream and agent event stream](#)
- [Pause and resume task events in contact records](#)
- [Metrics](#)

How paused and resumed tasks are queued

- All paused tasks that are in queue and not yet assigned to an agent are dequeued. This way they don't consume the queue limits for your instance and instead allow other more critical contacts to be assigned to agents.

- After the task is resumed, it is re-queued and the flow continues running per your configuration.
- When you design a flow to resume unassigned, paused tasks that are dequeued, be sure to add a [Transfer to queue](#) block to the flow to queue the task after resuming. Otherwise, the task will stay in a de-queued state.

How agents pause and resume tasks

Agents can pause a task from their Contact Control Panel (CCP) or agent workspace by using the **Pause** button. To update the task, the agent must choose **Resume**. The only actions the agent can take on a task that is in the Paused state are to end it or transfer it.

The following image shows the **Pause** button on the CCP.

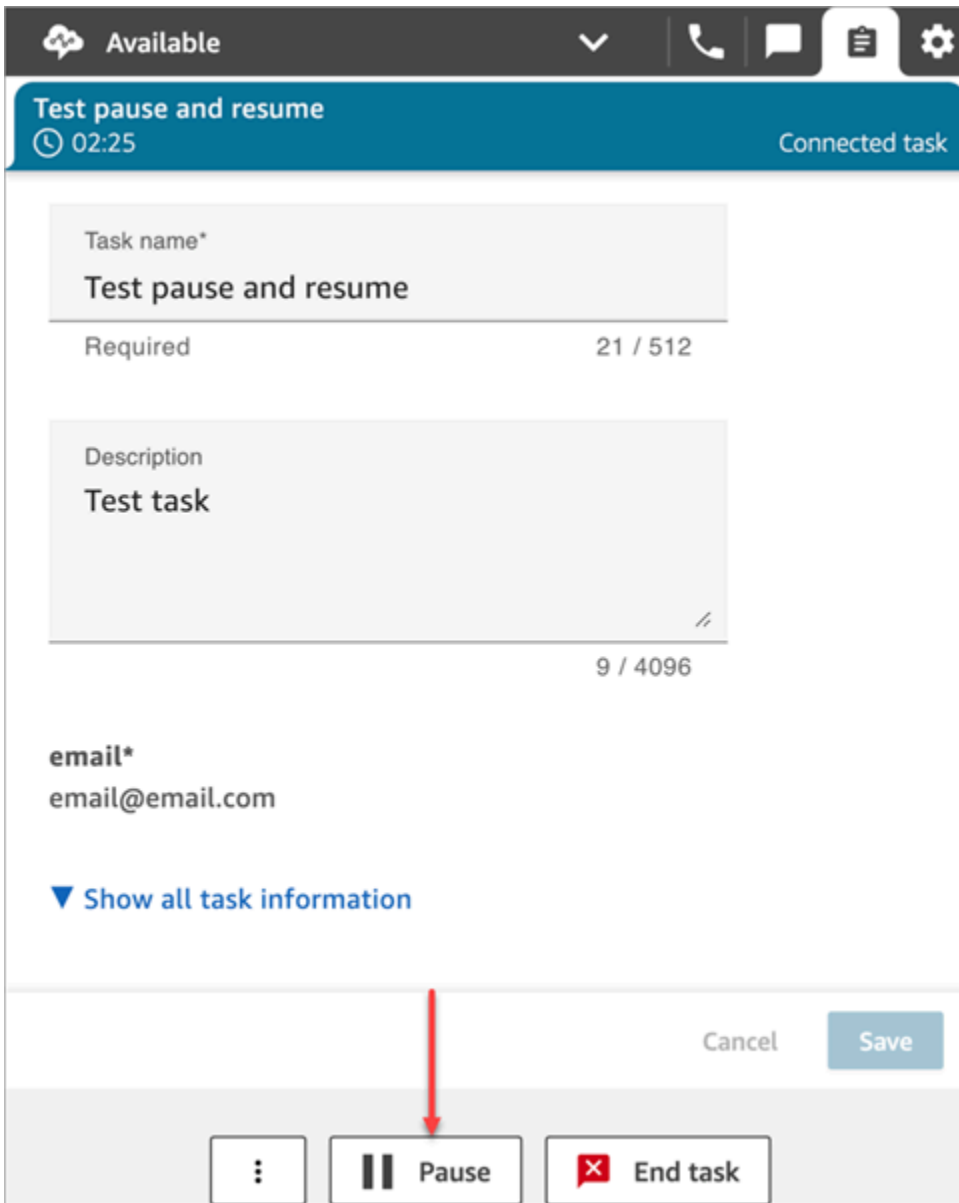

The following image shows the **Pause** button on the agent workspace.

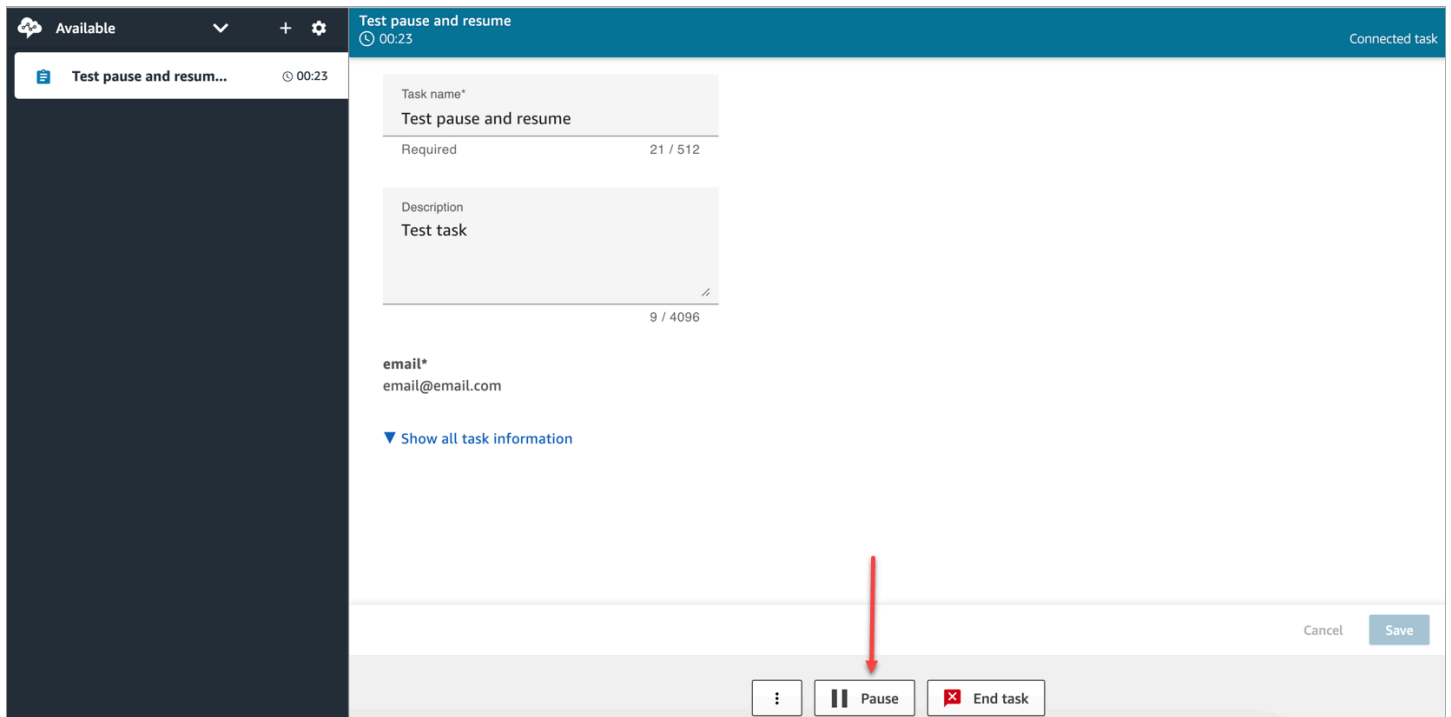

After an agent pauses or resumes a task, a banner is displayed that notifies them of the current status of the task. The following image of the CCP shows the Pause banner.

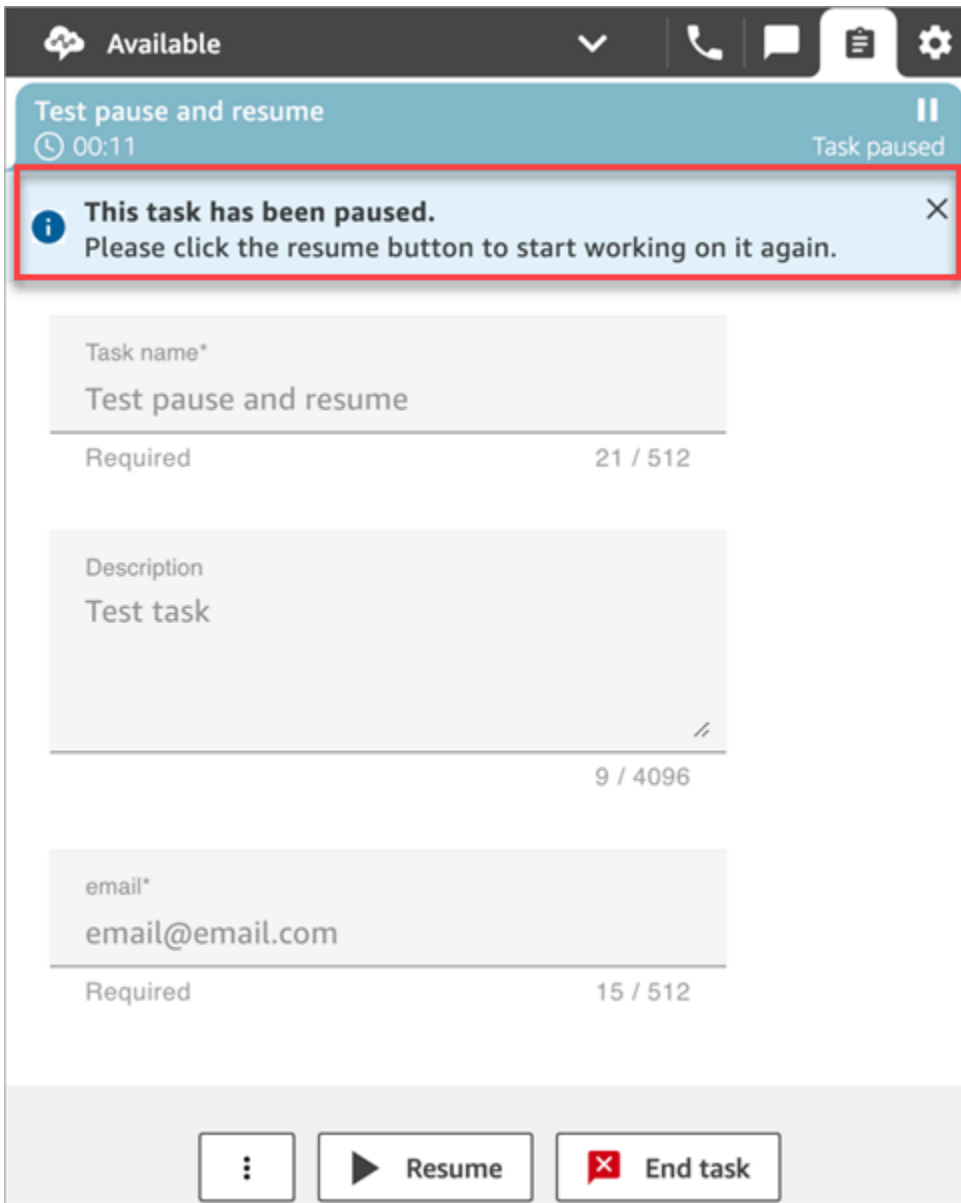

The following image of the agent workspace shows the Resume banner.

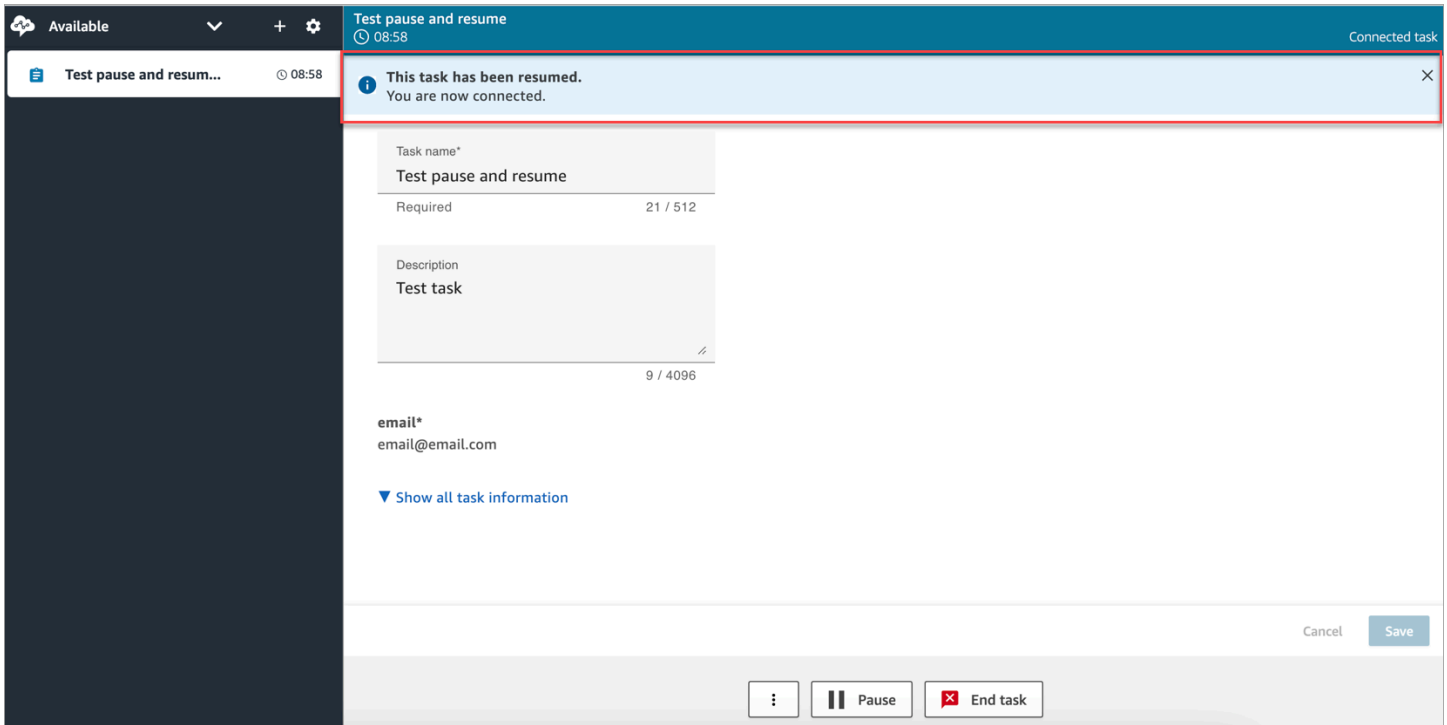

When an agent has multiple tasks open and they pause any one of them, the icon updates in the task list to notify them of the state of the task. The following image shows an example of a Paused icon.

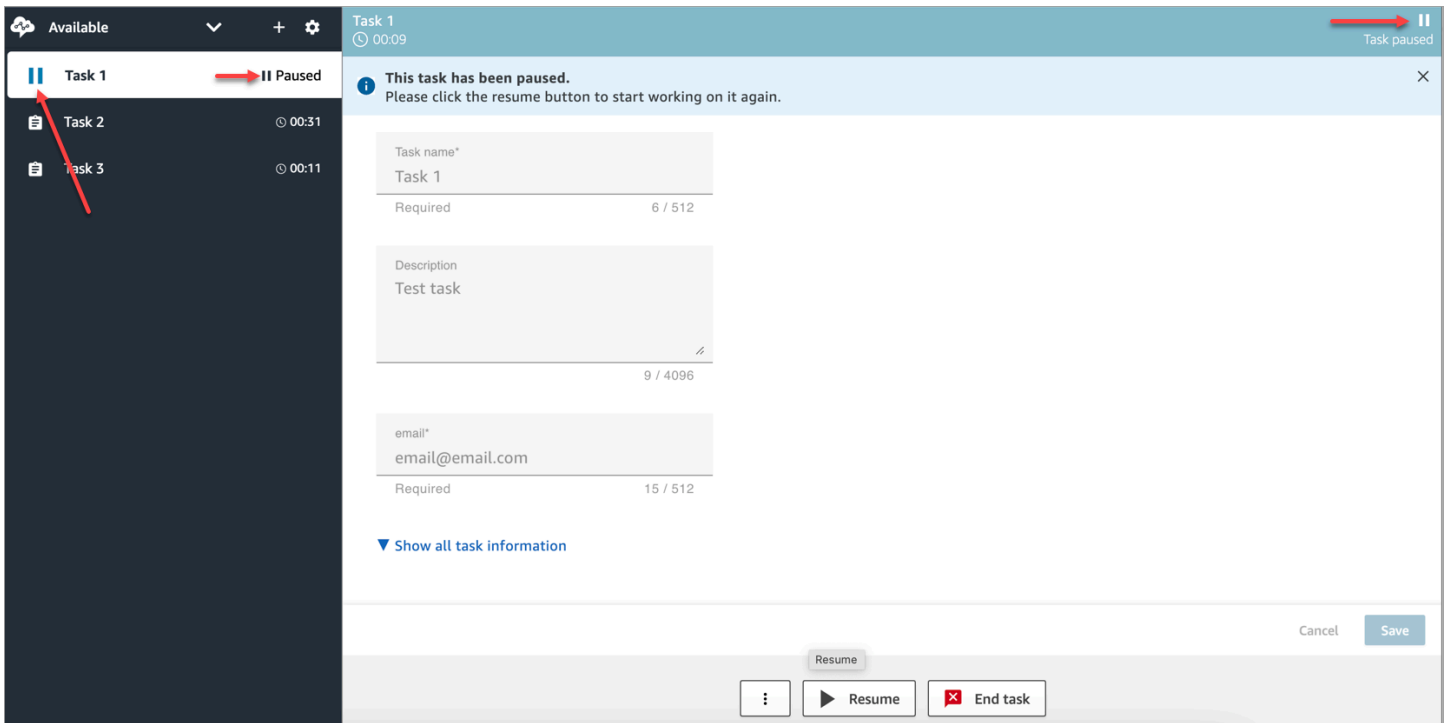

How many tasks an agent can pause

An agent can pause the same number of tasks as the **Maximum tasks per agent** setting in their [routing profile](#).

For example, an agent has a **Maximum tasks per agent** setting to handle 5 active tasks simultaneously. This means they can pause up to 5 tasks, which allows them to free up their active slots to take in new more critical tasks. However, it also means that agents can have twice the number of tasks in their workspace at any point in time. In our example, this agent can have 10 tasks in their workspace: 5 paused and 5 active.

When can a paused task be resumed?

A paused task can be resumed at any time. As a result, it's possible for an agent to work temporarily on twice their concurrency limit of tasks.

For example, an agent has 10 tasks in their workspace: 5 paused and 5 active. They resume all of their paused tasks simultaneously. Now they have 10 active tasks. No new tasks are routed to them until the number of active tasks is lower than the **Maximum tasks per agent** limit in their routing profile.

Programmatically pause and resume tasks

You can pause and resume tasks programmatically by using the [PauseContact](#) and [ResumeContact](#) APIs.

When pausing and resuming a task, a corresponding flow can be configured to run at the pause and resume events. For example:

- You may want to design a flow to automatically resume Paused tasks after a set period of time for agent lunch breaks.
- You may want to create a resume flow to update attributes on the task that may have changed while the task was Paused.

Configure a flow to pause and resume tasks

Configure a [Set event flow](#) block to pause and resume tasks. The following image shows the **Properties** page of a **Set event flow** block configured to pause a flow.

Block Type
✕

⚡ Set event flow

Block Name

Enter a block name

0 / 50

Specify a flow to run when a contact event or interaction occurs, such as an agent accepting or disconnecting from a call or placing a customer on hold [Learn more](#)

Select event

Select an event hook
▼

Flow at contact pause

Select a flow

Set manually

Select a flow
▼

Pause Flow with wait block

Set dynamically

Following are a couple of scenarios you may want to configure in your flows:

- For flows that run at contact pause, configure them to notify supervisors when a task has been paused.
- When resuming a paused contact, configure the flow to update contact attributes to make sure that agents are always working on the latest version of attributes.

New events in the contact event stream and agent event stream

When tasks are paused and resumed, new events are generated for PAUSED and RESUMED in the contact event stream and agent event stream.

The following image shows an example of a PAUSED event in the contact event stream.

```
{EventId: <>,} for event detail : {"eventType":"PAUSED","contactId":"
<>","channel":"TASK","instanceArn":"arn:aws:connect:
<>","initiationMethod":"API","queueInfo":{"queueArn":"<>","enqueueTimestamp":"2023-
11-03T21:54:01.113Z","queueType":"STANDARD"},"initiationTimestamp":"2023-11-
03T21:53:12.184Z","scheduledTimestamp":"2023-11-
03T21:54:00.000Z","connectedToSystemTimestamp":"2023-11-
03T21:54:00.741Z","lastPausedTimestamp":"2023-11-
03T21:54:14.997Z","totalPauseCount":1,"tags":{"aws:connect:instanceId":"
<>"},"segmentAttributes":{"connect:Subtype":{"valueString":"connect:Task"}}}{EventId:
<>,} for event detail : {"eventType":"RESUMED","contactId":"
<>","channel":"TASK","instanceArn":"<>","initiationMethod":"API","queueInfo":
{"queueArn":"<>","enqueueTimestamp":"2023-11-
03T22:20:10.837Z","queueType":"STANDARD"},"initiationTimestamp":"2023-11-
03T22:20:09.961Z","connectedToSystemTimestamp":"2023-11-
03T22:20:10.285Z","lastPausedTimestamp":"2023-11-
03T22:20:22.975Z","lastResumedTimestamp":"2023-11-
03T22:20:28.980Z","totalPauseCount":1,"tags":{"aws:connect:instanceId":"
<>"},"segmentAttributes":{"connect:Subtype":{"valueString":"connect:Task"}}}
```

The following image shows an example of a RESUMED event in the contact event stream.

```
{EventId: <>,} for event detail : {"eventType":"RESUMED","contactId":"
<>","channel":"TASK","instanceArn":"<>","initiationMethod":"API","queueInfo":
{"queueArn":"<>","enqueueTimestamp":"2023-11-
03T22:20:10.837Z","queueType":"STANDARD"},"initiationTimestamp":"2023-11-
03T22:20:09.961Z","connectedToSystemTimestamp":"2023-11-
03T22:20:10.285Z","lastPausedTimestamp":"2023-11-
03T22:20:22.975Z","lastResumedTimestamp":"2023-11-
03T22:20:28.980Z","totalPauseCount":1,"tags":{"aws:connect:instanceId":"
<>"},"segmentAttributes":{"connect:Subtype":{"valueString":"connect:Task"}}}
```

The following image shows an example of PAUSED tasks in the agent event stream.

```

{
  "agentARN=<>,
  "instanceARN=<>,
  eventId=<>,
  "previousAgentSnapshot=(agentStatus=<name=Available",
  <>,
  "type=ROUTABLE",
  "startTimestamp=2023-10-11T17": "43":32.245Z>,
  "nextAgentStatus=<>",
  "contacts="[
    (contactId=<>,
    "state=PAUSED",
    "initialContactId=null",
    "channel=TASK",
    "channel=TASK",
    "connectedToAgentTimestamp=INBOUND",
    "stateStartTimestamp=2023-10-11T17": "44":23.262Z,
    "queueTimestamp=null)"
  ])",
  "currentAgentSnapshot=(agentStatus=<name=Available",
  "arn=arn"<>,
  "type=ROUTABLE",
  "startTimestamp=2023-10-11T17": "43":32.245Z>,
  "nextAgentStatus=<>",
  "contacts="[
    (contactId=<>,
    "state=PAUSED",
    "initialContactId=null",
    "channel=TASK",
    "channel=TASK",
    "connectedToAgentTimestamp=INBOUND",
    "stateStartTimestamp=2023-10-11T17": "44":23.637Z,
    "queueTimestamp=null)"
  ])",
  "eventType=STATE_CHANGE",
  version=2017-10-01,
  "eventTimestamp=2023-10-11T17": "44":23.639Z
}

```

Pause and resume task events in contact records

The following events are captured in the [ContactTraceRecord](#) section of the contact records data model. You can use the [DescribeContact](#) API to return task events.

Name in contact record	Name returned by DescribeContact API		
TotalPauseDurationInSeconds	TOTAL_PAUSED_TIME		
TotalPauseCount	TOTAL_NUMBER_OF_PAUSES		
LastPauseTimestamp	LAST_PAUSED_TIMESTAMP		
LastResumedTimestamp	LAST_RESUMED_TIMESTAMP		

The following values are available in near real time when you use the [DescribeContact](#) API or view the **Contact details** page for an in progress contact.

- TotalPauseCount
- LastPausedTimestamp
- LastResumedTimestamp

A completed contact has TotalPauseDurationInSeconds.

Metrics

The following metrics display active, paused, and resumed time.

Real-time metrics	Description
[UI] Agent/Routing Profiles/Queue → Performance → Average Active Time	SUM(active_time)/Number of contacts
[UI] Agent/Routing Profiles/Queue → Performance → Average Agent Pause Time	SUM(agent_pause_time)/Number of contacts that were paused
[UI] Agent → Contacts → Contact State	Paused state of a task contact

Historical Metrics	Description
[UI] Agent → Agent activity audit → Support "PAUSED" state	Display paused state when the contact for an agent is in Paused state
[GetMetricDataV2] Query Average of AGENT_PAUSE_TIME for a queue/routing profile/task	SUM(total_agent_pause_time) for all contacts that were paused from queue/routing profile/TaskAVG = SUM(total_agent_pause_time)/ number of paused contacts for queue/RP/Tasks
[GetMetricDataV2] Query Average of ACTIVE_TIME for a queue/routing profile	SUM(total_handle_time - total_agent_pause_time) for all contacts of queue/routing profile/tasks AVG = SUM(total_handle_time - total_agent_pause_time) / total number of contacts for queue/routing profile/tasks

Contact details page	Description
<p>[UI] Contact Search → Contact Details → Contact Summary → Last Paused Time</p>	Last Paused Time
<p>[UI] Contact Search → Contact Details → Contact Summary → Last Resumed Time</p>	Last Resumed Time
<p>[UI] Contact Search → Contact Details → Contact Summary → Number of Pauses</p>	Total number of Pauses including when the contact was not connected.
<p>[UI] Contact Search → Contact Details → Contact Summary → Total Pause Duration</p>	Total Pause duration includes before and after the agent was connected.

Real-time Metrics page

The following image of the **Real-time Metrics** page shows the task contact state as **Paused**.

The screenshot shows the 'Real-time Metrics' page with a table of agent performance. The table has columns for Agent Login, Channels, Agent (Activity, Next activity, Duration, Agent Hierarchy, Routing Profile, Capacity), Contacts (Active, Availability, Contact State, Duration, Queue), and Performance (Avg ACW). A red arrow points to the 'Task' row for agent 'njnku', where the 'Contact State' is 'Paused'.

Agent Login	Channels	Agent					Contacts					Performance	
		Activity	Next activity	Duration	Agent Hierarchy	Routing Profile	Capacity	Active	Availability	Contact State	Duration		Queue
njnku	All channels	On contact	-	00:00:09	level2	Basic Routing Profile	3	1	3	-	-	-	-
	Voice						1	0	1	-	-	-	-
	Chat total						3	0	3	-	-	-	-
	Task total						2	1	2	-	-	-	-
	Task							-	-	Paused	00:00:09	BasicQueue	-

The following image of the **Real-time Metrics** page shows **Avg Active Time, AHT and Avg Agent Pause Time**.

Real-time Metrics Share your feedback

Last Update: Nov 7, 2023, 10:14:30 AM || ↻ Actions Save report

Updates have been made by your admin which may change your view below. Contact your admin to learn more.

Agents ✎ Time range: trailing previous 2 hours ⚙ ✕

Agent Login	Channels	Performance											
		Rate	Duration	Queue	Avg ACW	Agent non-response	Handled in	Handled out	AHT	Occupancy	Average active time	Average agent pause time	Avg API connecting time
njnku	All channels	-	-	-	-	-	-	-	-	8.55%	-	-	-
	Voice	-	-	-	-	-	-	-	-	-	-	-	-
	Chat total	-	-	-	-	0	-	-	-	-	-	-	00:00:00
	Task total	-	-	-	00:00:02	0	0	0	00:00:40	-	00:00:20	00:00:19	00:00:00

Rows per page 10 1-1 of 1

Note: Only queues for which there was activity during the report time range are included in the report. Queues without any activity are not included in the displayed report.

Agent Activity Audit report

The following image of the **Agent Activity Audit report** shows the Paused status when a contact is paused by the agent.

Agent Login [Redacted] . x ▾		
Date 2023-11-07 [Calendar Icon]	Time Zone Etc/UTC ▾	
Generate Report		
Time	Status	Event Data
Nov 07, 2023 12:17:35 am	Offline	-
Nov 07, 2023 06:09:21 pm	Available	Queues: [Redacted], BasicQueue
Nov 07, 2023 06:09:34 pm	Connecting	Conversation Type: Task Contact ID: 8c892103- [Redacted]
Nov 07, 2023 06:09:37 pm	Connected	Conversation Type: Task Contact ID: 8c892103- [Redacted]
Nov 07, 2023 06:09:38 pm	Busy	Conversation Type: Task Contact ID: 8c892103- [Redacted]
Nov 07, 2023 06:09:52 pm	Paused	Conversation Type: Task Contact ID: 8c892103- [Redacted]
Nov 07, 2023 06:10:12 pm	Busy	Conversation Type: Task Contact ID: 8c892103- [Redacted]
Nov 07, 2023 06:10:15 pm	Wrap Up	Conversation Type: Task Contact ID: 8c892103- [Redacted]
Nov 07, 2023 06:10:18 pm	Available	Queues: njnku, BasicQueue

Concepts: Routing profiles

A routing profile determines what types of contacts an agent can receive and the routing priority.

- Each agent is assigned to one routing profile.
- A routing profile can have multiple agents assigned to it.

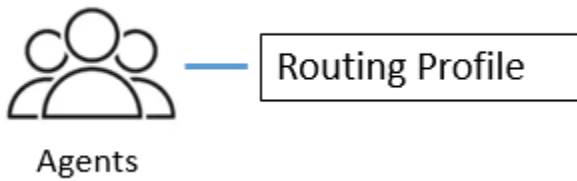

Amazon Connect uses routing profiles to allow you to manage your contact center at scale. To quickly change what a group of agents does, you only need to make an update in one place: the routing profile.

Default routing profile: Basic routing profile

Amazon Connect includes a default routing profile named **Basic routing profile**. Along with the [default flows](#) and default queue (named **BasicQueue**), it powers your contact center so you don't need to do any customization. This is what enables you to get started quickly.

Routing Profiles Link Queues and Agents

When you create a routing profile, you specify:

- The channels the agents will support.
- The queues of customers that the agents will handle. You can use a single queue to handle all incoming contacts, or you can set up multiple queues. Queues are linked to agents through a routing profile.
- Priority and delay of the queues.

The following image shows a graphic of a group of agents mapped to a routing profile. The routing profile specifies multiple channels and queues for the agents.



Agents

Routing Profile

- Channels: Voice, Chat, Task
- Queues
 - Queue 1: Voice, Chat
 - Queue 2: Chat
 - Queue 3: Task

Concepts: Standard queues and agent queues

There are two types of queues:

- **Standard queues:** This is where contacts wait before they are routed to and accepted by agents.
- **Agent queues:** These queues are created automatically when you add an agent to your contact center.

Contacts are only routed to agent queues when explicitly sent there as part of a flow. For example, you might route contacts to a specific agent who's responsible for certain customer issues, such as billing or premium support. Or you might use agent queues to route to an agent's voice-mail.

Contacts waiting in agent queues are higher priority than contacts waiting in standard queues. Contacts in agent queues have the highest priority and zero delay:

- **Highest priority:** If there's another contact in the basic queue, Amazon Connect chooses to give the agent the contact from the agent queue first.
- **Zero delay:** If the agent is available, the contact immediately gets routed to them.

Queues in metrics reports

In a [real-time metrics report](#), you can monitor how many contacts are in standard queues and agent queues. The following image shows a sample real-time metrics Queues report where an Agents table and Agent queues table have been added. It shows:

- **BasicQueue**, which is a standard queue. It shows one agent (John) is online.
- **Agents** table, which shows the agent John has set his CCP to **Available** and is ready to take contacts. A supervisor can change an agent's status from here. For example, set to **Offline**.
- **Agent queues** table, which shows John's agent queue. It shows John is online and can take contact from this queue, too.

Real-time metrics

Last Update: Jan 31, 2020 10:45:3

Queues

Time range: trailing prev

Queues	Agents						Contacts	
	Online	On contact	NPT	ACW	Error	Available	Availability	Active
BasicQueue	1	0	0	0	1	0	0	

Rows per page:

Note: Only queues for which there was activity during the report time range are included in the report. Queues without any activity are not included in the displayed r

Agents

Time range: trailir

Agent Login	Channels	Agent	Routing Profile	Capacity	
		Activity			
John	All channels	Available	-	Basic Routing Profile	2
	Voice				
	Chat total				

Rows per page:

Note: Only agents for which there was activity during the report time range are included in the report. Agents without any activity are not included in the displayed r

Agent queues

Time range: trailing prev

Queues	Agents						Contacts	
	Online	On contact	NPT	ACW	Error	Available	Availability	Active
John	1	0	0	0	0	0	0	

Rows per page:

Note: Only queues for which there was activity during the report time range are included in the report. Queues without any activity are not included in the displayed r

New table

When an agent gets a contact from a standard queue, the contact never appears in the agent queue. It just goes directly to the agent.

In a [historical metrics report](#), by default agent queues don't appear in a Queues table. To show them, choose the **Settings** icon, then choose **Show agent queues**.

Table Settings ×

Interval & Time range Groupings **Filters** Metrics

Queues that match these filters will be displayed on the table

Show agent queues

Queue

- Agent queues**
- Routing profile
- Agent hierarchy
- Phone number

Agent queues

Show metrics only for contacts handled in these queues:

Q Search ▾

- John (John Doe)
- Jane (Jane Doe)

Tip

The metrics APIs don't support agent queues.

Default queue: BasicQueue

Amazon Connect includes a default queue named **BasicQueue**. Along with the [default flows](#) and default routing profile (named **Basic routing profile**), it powers your contact center so you don't need to do any customization. This is what enables you to get started quickly.

Concepts: Queues priority and delay

Priority and delay are powerful features that allow you to load balance contacts among groups of agents.

Example 1: Different priority but same delay

For example, one group of agents is assigned to a Sales routing profile. Since their primary job is sales, the Sales queue is Priority 1 and Delay is 0. But they can help with Support too, so that queue is Priority 2 and Delay is 0. This shown in the following table:

Queue	Priority	Delay (in seconds)
Sales	1	0
Support	2	0

If there are no contacts in the Sales queue, then the agents will be presented with contacts from the Support queue.

Example 2: Same priority but different delay

Say you set the Support queue to Priority 1 and Delay of 30 seconds, as shown in the following table:

Queue	Priority	Delay (in seconds)
Sales	1	0
Support	1	30

These agents will always get contacts from the Sales queue first because the delay is 0. However, when a contact in the **Support** queue ages past 30 seconds, it will also be treated as priority 1. The agents will then be presented with the contact from the **Support** queue.

Example 3: Different Priorities and Delays

Here's a more complicated example for a Support routing profile:

Queue	Priority	Delay (in seconds)
Tier 1 Support	1	0

Queue	Priority	Delay (in seconds)
Tier 2 Support	1	0
Tier 3 Support	2	20
Tier 4 Support	3	80

This routing profile prioritizes the Tier 1 Support and Tier 2 Support queues equally because each is priority 1.

- Agents may take contacts from the Tier 3 Support queue when:
 - Customers for Tier 3 Support are waiting for 20 seconds or longer.
 - And no contacts are in the Tier 1 Support or Tier 2 Support queues.
- Agents may take contacts from the Tier 4 Support queue when:
 - Customers in the Tier 4 Support queue have been waiting 80 seconds or longer.
 - And no contacts are in the Tier 1 Support, Tier 2 Support or Tier 3 Support queues.

Priority takes precedence. (You might think that agents take contacts from Tier 4 Support when contacts are in Tier 1 Support, Tier 2 Support, or Tier 3 Support and waiting 20 seconds or longer, but that's not right.)

Example 4: Same Priority and Delay

In this example a routing profile has only two queues, and they have the same priority and delay:

Queue	Priority	Delay (in seconds)
Sales	1	0
Support	1	0

For this routing profile, the oldest contact is routed first. It goes to the agent who has been idle for the longest time.

For instructions on how to set priority and delay for a routing profile, see [Create a routing profile](#).

Concepts: Queue-based routing

In your business, you might want to route customers to specific agents based on certain criteria, such as the skill of the agent. This is called queue-based routing, also known as skills-based routing.

For example, an airline might have some agents who handle reservations for English-speaking customers, others who handle Spanish-speaking customers, and a third group that handles both types of customers, but only over the phone.

The following illustration shows you can:

- Assign the same routing profile to multiple agents.
- Assign multiple queues to a routing profile.
- Assign a queue to multiple routing profiles.

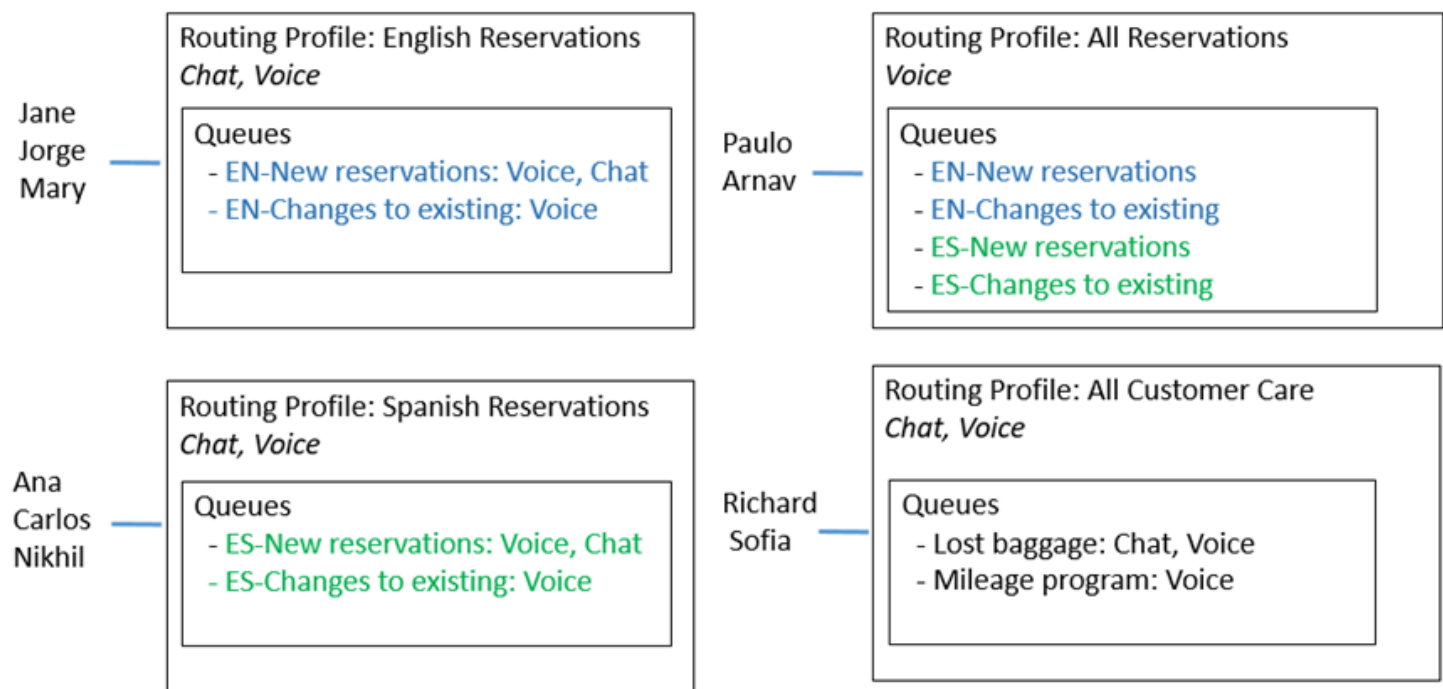

For an overview of the steps to set up queue-based routing, see [Set up queue-based routing](#).

Concepts: Channels and concurrency

Agents can handle voice, chat, and tasks in Amazon Connect. When you set up a routing profile to handle multiple channels, you have two options:

- Option 1: Set up agents so they can handle contacts while already on another channel. This is called *cross-channel concurrency*.
- Option 2: Set up agents so they can be offered voice or chat or tasks if they are fully idle, depending on what is in queue. When you choose this option, after the agent starts work on contacts from one channel they will no longer be offered contacts from any other channels.

When using cross-channel concurrency, Amazon Connect checks which contact to offer the agent as follows:

1. It checks what contacts/channels the agent is currently handling.
2. Based on what channels they are currently handling, and the cross-channel configuration in the agent's routing profile, it determines whether the agent can be routed the next contact.
3. Amazon Connect prioritizes the longest waiting contact if Priority and Delay are equal. Even though it's evaluating multiple channels at the same time, First-In First-Out is still respected.

For a detailed example of how Amazon Connect routes contacts when cross-channel concurrency is set up, see [Example of how a contact is routed with cross-channel concurrency](#).

To learn more about what the agent experiences in the Contact Control Panel when handling multiple chats, see [How to use the CCP to manage chats](#).

Concepts: Amazon Connect Flows

A *flow* defines how a customer experiences your contact center from start to finish. At the most basic level, flows enable you to customize your IVR (interactive voice response) system.

For example, you can give customers a set of menu options and route customers to agents based on what they enter on their phone. Although with Amazon Connect, flows are significantly more powerful than that: you can create dynamic, personalized flows that interact with other AWS services.

Default flows

When you create an instance and claim a number, you automatically have a working contact center in just 5 minutes. This is because Amazon Connect includes a set of default flows that have already been published. It uses them to power your contact center.

When you customize your contact center and create new flows, you're replacing the default flows with your own.

For example, say you create a flow that includes putting the customer on hold.

- You can create a prompt to play while the customer is on hold, such as "Do your holiday shopping early this year. We're offering free shipping in November." And then play some music.
- If you don't create a prompt, Amazon Connect will play the **Default customer hold** flow automatically.

To see the list of default flows in the Amazon Connect console, go to **Routing, Flows**. They all start with **Default** in their name.

For a list of all the default flows and what they do, see [Default flows](#).

Flow designer

To customize your contact center, you use the flow designer. It's a drag-and-drop interface that allows you to customize your contact center without any coding.

Flow blocks

Flow blocks are the building blocks of your flows. Each block is designed for a specific function a business might want in a contact center.

You configure a flow block by accessing its **Properties** page, as shown in the following GIF. After you drag the block onto the flow designer, click or tab the name of the block to access its properties page.

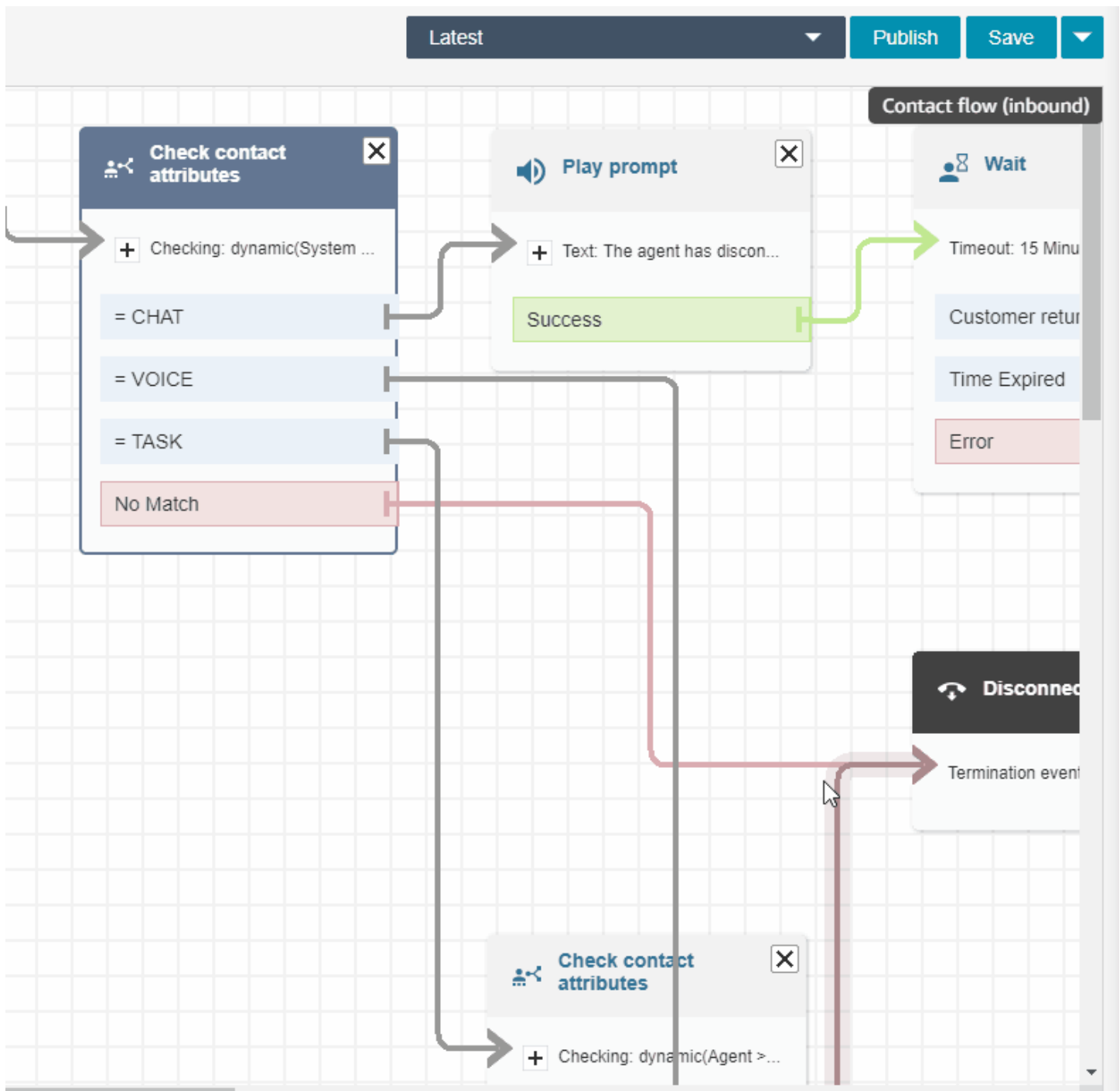

For a list of the available flow blocks and descriptions about what they do, see [Flow block definitions](#).

Sample flows

To see how to put flow blocks together to create different flows, see [Sample flows](#).

Best practices for Amazon Connect

This list of best practices can help you get the maximum benefit from Amazon Connect. These best practices are for flows, Lambda, chat, Amazon Lex, and the Contact Control Panel (CCP).

We also recommend reviewing [Security Best Practices for Amazon Connect](#).

Flows

- Use consistent attribute naming conventions across all AWS services. Use camel case for yourAttributeNames to avoid confusion when passing and referencing variables.
- Use standard naming conventions for attribute names. Don't use spaces or special characters that could impact downstream reporting processes such as AWS Glue crawlers.
- Create modular flows. Make the flows as small as possible, and then combine modular flows into an end-to-end contact experience. This helps to keep your flows manageable, and you won't require numerous regression testing cycles.
- When you set **User Defined** or **External** values in dynamic attribute fields, use only alphanumeric characters (A-Z, 0–9) and periods. No other characters are allowed.
- Ensure all error branches are routed to a block that effectively handles the error or terminates the contact.
- Use a **Set logging behavior** block to enable or disable logging for segments of the flow where sensitive information is collected and can't be stored in CloudWatch.
- Use **Set recording behavior** block in your flow to disable and enable recordings according to your use case. Keep in mind that Amazon Connect records conversations with agents only. It doesn't record IVR interactions.
- Ensure that attributes used in the flow are set and referenced correctly. If there are periods prepended to the attribute names, you are likely using JSONPath (\$) format while also selecting a variable type from the pick list. For example, using:
 - **Save text as attribute** and value \$.External.variableName works as expected.
 - Set dynamically and value variableName works as expected.
 - **Set dynamically** and \$.External.variableName results in a prepended period.
- Before transferring a call to agent and putting that call in a queue, ensure that **Check hours of operation** and **Check staffing** blocks are used. They verify that the call is within working hours and that agents are staffed to service.

- Ensure that callbacks are offered before and after queue transfer by using **Check queue status** blocks. Include a condition for **Queue capacity** that is greater than X, where X is a number representing your expected queue capacity.
 - If queue capacity exceeds the expected capacity, use a **Get Customer Input** block to offer a callback. This retains the caller's position in the queue and calls them back when an agent is available.
 - In the **Set callback number** block, choose the number to be used to call the customer back in the CCP. Use **System** and **Customer Number** or a new number, collected by a **Store Customer Input** block, using **System** and **Stored customer input**.
 - Finally, add a **Transfer to queue** block. Configure it to **Transfer to callback queue** and configure the callback options to fit your specific use case.
- Use a **Loop prompts** block in your Customer queue flow to interrupt with a queued callback and external transfer option at regular intervals.
- Ensure that all countries referenced in external transfers or used for outbound dialing are added to the service quota for your account/instance.
- Ensure that all numbers referenced in external transfers are in E.164 format. Drop the national trunk prefix that you use when calling locally. This prefix would be the leading 0 for most of Europe, 1 for the US. The prefix is replaced by the country code. For example, the UK mobile number **07911 123456** in E.164 format is **+44 7911 123456 (tel:+447911123456)**.
- Ensure that there are no infinite loops in the flow logic. Also ensure that for each call, the flow connects the caller to an agent, bot, or transferred externally for further assistance.

Lambda

- Amazon Connect limits the duration of a sequence of Lambda functions to 20 seconds. It times out with an error message when the total execution time exceeds this threshold. Because customers hear silence while a Lambda function runs, we recommend adding a **Play prompt** block between functions to keep them engaged during the long interaction.

By breaking up a chain of Lambda functions with the **Play prompt** block, you can invoke multiple functions that last longer than the 20 second threshold.

Chat and Amazon Lex

- You can use the same bot for both the voice and chat channels. However, you may want the bot to respond differently based on the channel. For example, you want to return SSML for voice so a number is read as a phone number, but you want to return normal text to chat. You can do this by passing the **Channel** attribute. For instructions, see [How to use the same bot for voice and chat](#).
- For voice, some words are best spelled phonetically to get the correct pronunciation, such as last names. If this is the case with your scenario, include it in the design of your bot. Or, you can keep the voice and chat bots separate.
- Tell agents about the bot. When a contact is connected to the agent, the agent sees the entire transcript in their window. The transcript includes text from both the customer and the bot.

Contact Control Panel

- If your agents use Google Chrome 71 to Chrome 75, and they use chat or tasks, add the CCP URL to the allowlist in the agent's Chrome settings. Otherwise, they won't hear the audio indicator notifying them that there's an incoming chat or task.

For instructions, see this [Google Chrome Help article](#).

Tutorials: An introduction to Amazon Connect

The tutorials in this section are provided to help you start using Amazon Connect. They show you how to set up your first instance, and test a sample voice and chat experience. Next, they show you how to set up an IT Help Desk contact center that uses the features in Amazon Lex.

These tutorials are suitable for both knowledge workers and developers.

Prerequisite

- An AWS account. If you don't already have one, create an account at: aws.amazon.com.

Print the tutorials

If you want to print the tutorials, choose the PDF icon at the top of any page, as shown in the following image.

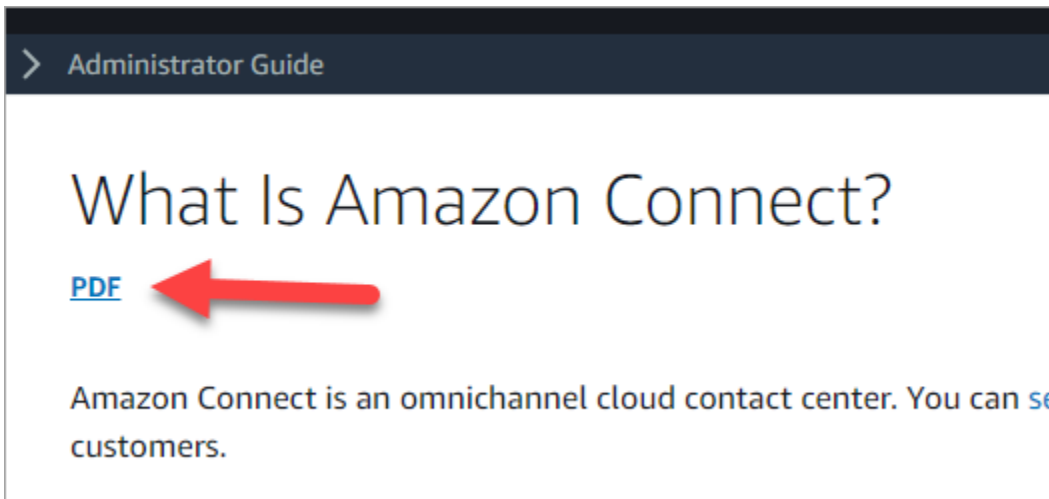

A PDF version of the documentation opens. Press **Ctrl+Home** to return to the beginning of the PDF, then scroll down to the table of contents. Choose which pages to print.

Contents

- [Tutorial 1: Set up your Amazon Connect instance](#)
- [Tutorial 2: Test the sample voice and chat experience](#)
- [Tutorial 3: Create an IT help desk](#)

Tutorial 1: Set up your Amazon Connect instance

You can have multiple instances of Amazon Connect. Each instance contains all the resources related to your contact center, such as phone numbers, agent accounts, and queues.

In this tutorial, you open Amazon Connect, create an instance of Amazon Connect, and claim a phone number that you can use for testing.

Contents

- [Step 1: Launch Amazon Connect](#)
- [Step 2: Create an instance](#)
- [Step 3: Claim a phone number](#)

Step 1: Launch Amazon Connect

This step walks you through finding Amazon Connect in the AWS console, and opening the Amazon Connect console.

1. Log in to the [AWS Management Console](https://console.aws.amazon.com/console) (<https://console.aws.amazon.com/console>) using your AWS account.
2. In the AWS Management Console, at the top of the page, choose the **Services** drop-down menu.

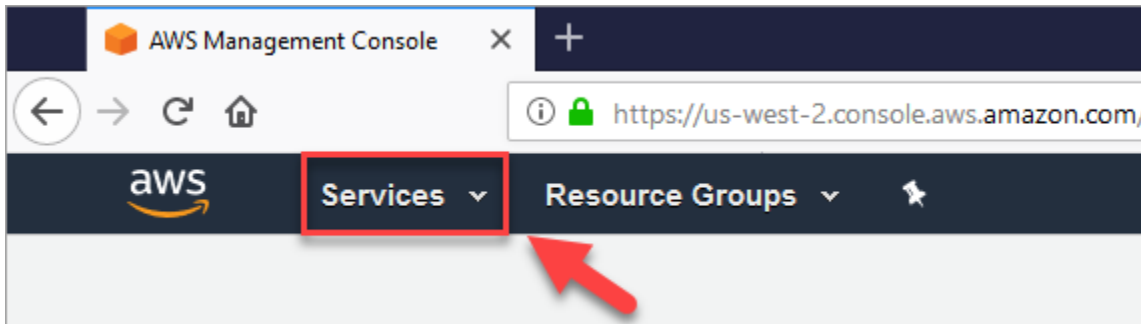

3. In the search box, type **Amazon Connect**.

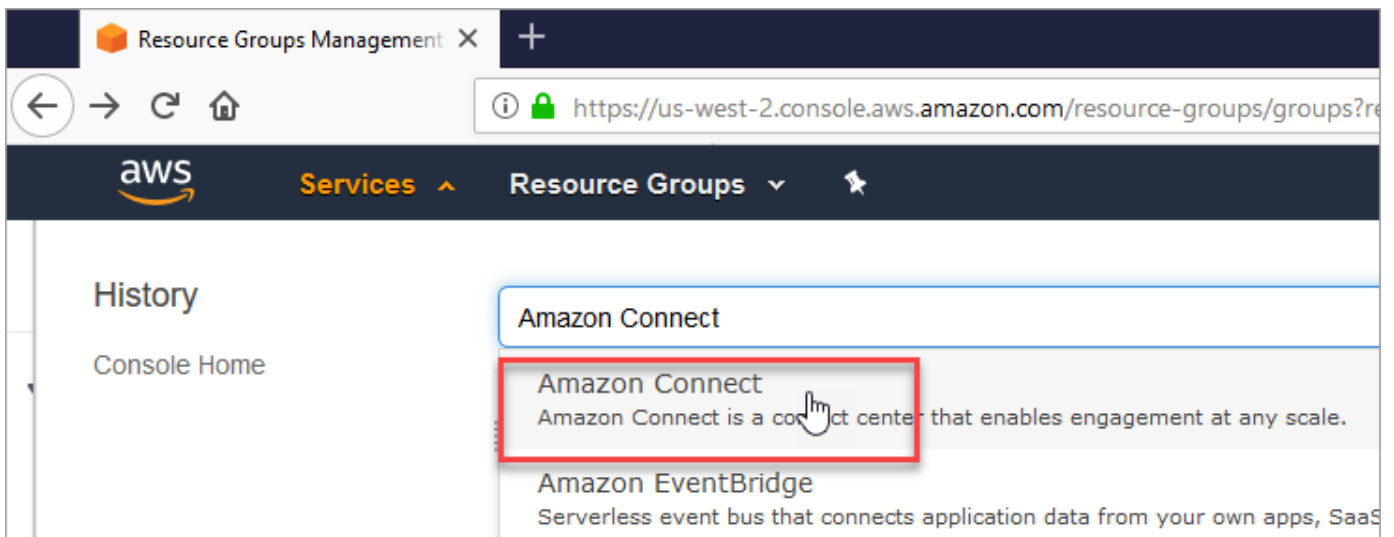

4. Choose **Amazon Connect**.

If this is the first time you've been to the Amazon Connect console, you'll see the following Welcome page.

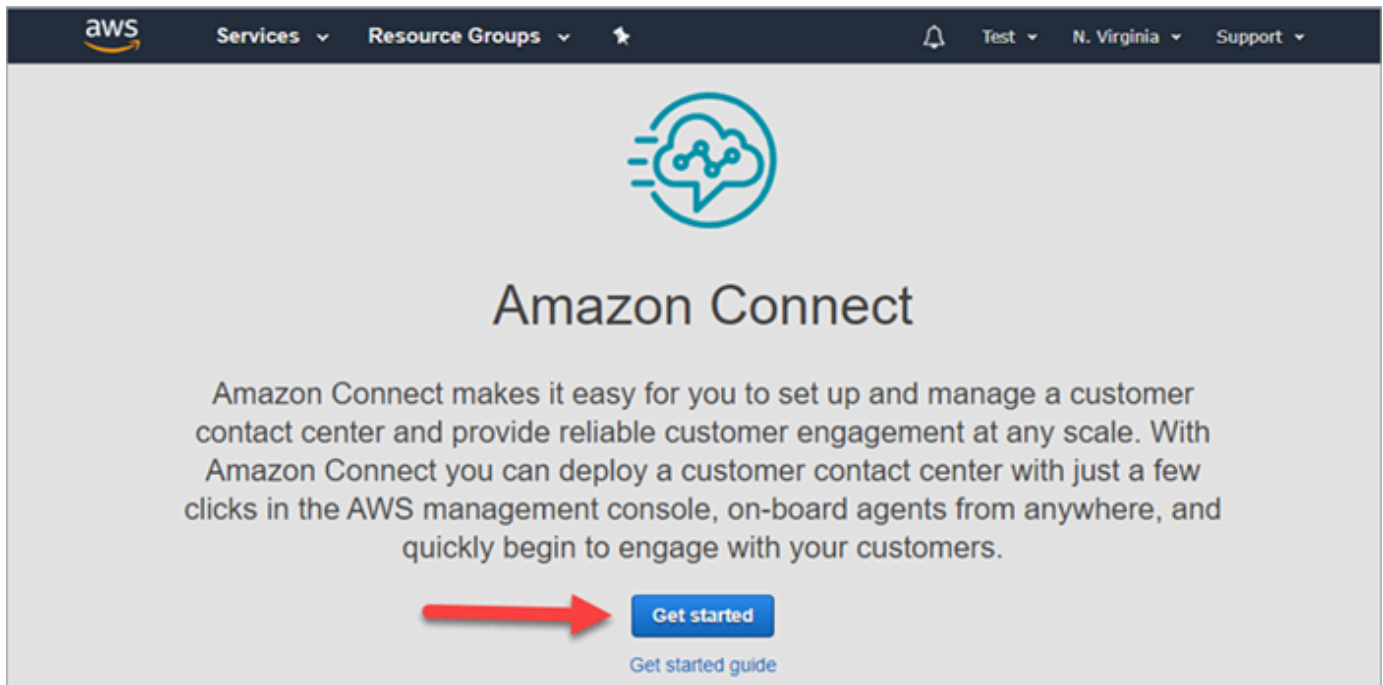

5. Choose **Get started**.

Congratulations! You found and accessed Amazon Connect. You can use these same steps to search for and launch any AWS service.

Go to [Step 2: Create an instance](#).

Step 2: Create an instance

1. On the **Amazon Connect virtual contact center instances** page, choose **Add an instance**.
2. On the **Set identity** page, in the **Access URL** box, type a unique name for your instance. For example, the following image shows **mytest10089** as a name. Choose a different name for your instance. Then choose **Next**.

Amazon Connect > Create Amazon Connect instance

Step 1
Set identity

Step 2
Add administrator

Step 3
Set telephony

Step 4
Data storage

Step 5
Review and create

Set identity

Identity management

- Store users in Amazon Connect**
Create and manage users in Amazon Connect. You cannot share users with other applications.
- Link to an existing directory**
Amazon Connect uses an existing directory. You create users in the directory, and then add and configure them in Amazon Connect. You can only associate a directory with only one Amazon Connect instance. [Learn more](#)
- SAML 2.0-based authentication**
AWS supports identity federation with Security Assertion Markup Language (SAML 2.0). This feature enables single sign-on (SSO) so users can log into the AWS Management Console or call the AWS APIs without you having to create an IAM user for everyone in your organization. [Learn more](#)

Access URL
Create a custom URL. Use this URL to log into this instance of Amazon Connect.

https:// mytest10089 .my.dev.us-west-2.nonprod.connect.aws.a2z.com

Choose a different name for your instance.

Cancel **Next**

3. On the **Add administrator** page, add a new administrator account for Amazon Connect. Use this account to log in to your instance later using the unique access URL. Choose **Next**.

Amazon Connect > Create Amazon Connect instance

Step 1
Set identity

Step 2
Add administrator

Step 3
Set telephony

Step 4
Data storage

Step 5
Review and create

Add administrator

Add administrator

Administrator - optional

Specify an administrator
Specify an administrator for this instance of Amazon Connect. The administrator will have full permissions to access all of Amazon Connect.

No administrator

First name: Jane

Last name: Doe

Username: **a** janedoe

Password: **b** ●●●●●●

Password (verify): ●●●●●●

Email: [Redacted]

Cancel Previous Next

- a. The user name will be your Amazon Connect login. It's case sensitive.
 - b. The password must be between 8-64 characters, and must contain at least one uppercase letter, one lowercase letter, and one number.
4. On the **Set telephony** page, accept the default settings to allow incoming and outgoing calls. Choose **Next**.

Amazon Connect > Create Amazon Connect instance

Step 1
Set identity

Step 2
Add administrator

Step 3
Set telephony

Step 4
Data storage

Step 5
Review and create

Set telephony

Telephony Options

Choose whether your contact center allows inbound calls, outbound calls, or both.

- Allow incoming calls
- Allow outgoing calls

Cancel Previous **Next**

5. On the **Data storage** page, accept the default settings and choose **Next**.

Amazon Connect > Create Amazon Connect instance

Step 1
Set identity

Step 2
Add administrator

Step 3
Set telephony

Step 4
Data storage

Step 5
Review and create

Data storage

▼ Data storage

Call recordings, scheduled reports, and chat transcripts are stored in a S3 bucket that is created for you when you create an Amazon Connect instance. The stored data is encrypted by the AWS Key Management Service using a key specific to your Amazon Connect instance. Contact flow logs are stored in Amazon CloudWatch Logs in a log group created for you.

Amazon Connect permissions

By choosing Next, you are granting Amazon Connect permission to:

- Read and write to your S3 bucket.
- Read and write CloudWatch Logs.
- Encrypt your data.

Connect data
Your Connect data will be stored in this S3 bucket:

amazon-connect-.../connect/mytest Copy

Contact flow logs
Your contact flow logs will be stored here in CloudWatch:

/aws/connect/mytest Copy

Enable Customer Profiles
Customer Profiles uses your customer data, including Connect contact history, to identify and help personalize contact flows and your agent's interactions with contacts. You can further customize your Customer Profile domain later, including adding more data sources and changing data encryption settings. [Learn more](#)

Customize data storage (advanced)

Cancel Previous **Next**

6. On the **Review and create** page, choose **Create instance**.

Amazon Connect > Create Amazon Connect instance

Step 1
Set identity

Step 2
Add administrator

Step 3
Set telephony

Step 4
Data storage

Step 5
Review and create

Review and create

Identity management Edit

Storing users within Amazon Connect
<https://mytest10089.my.dev.us-west-2.nonprod.connect.aws.a2z.com>

Add administrator Edit

First name Jane	Last name Doe
Username janedoe	
Password *****	Password (verify) *****
Email dfaiigel@amazon.com	

Telephony Options Edit

Allow incoming calls Your contact center can handle incoming calls.	Allow outgoing calls Your contact center can make outbound calls. You can set which users can place outbound calls in user permissions.
---	--

Data storage

Data Encrypted data will be stored here: amazon-connect-350b684a8bd5/connect/mytest10089	Contact flow logs Contact flow logs are stored here: /aws/connect/mytest10089
---	--



Cancel Previous Create instance

7. After the instance is created, choose **Get started**.

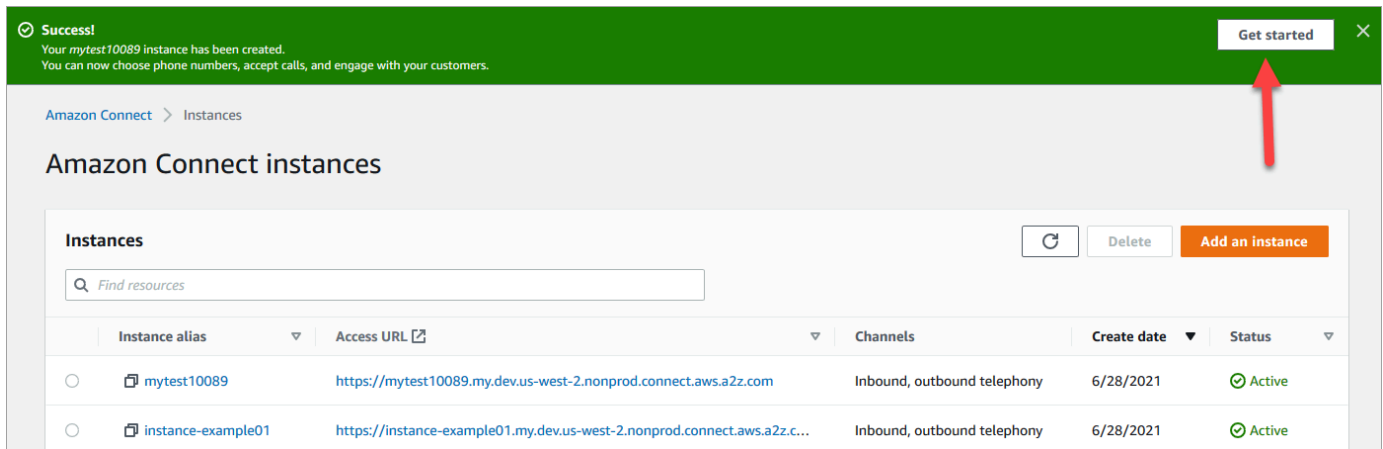

Success! Your `mytest10089` instance has been created. You can now choose phone numbers, accept calls, and engage with your customers.

Amazon Connect > Instances

Amazon Connect instances

Instances Refresh Delete Add an instance

Find resources

	Instance alias	Access URL	Channels	Create date	Status
<input type="radio"/>	mytest10089	https://mytest10089.my.dev.us-west-2.nonprod.connect.aws.a2z.com	Inbound, outbound telephony	6/28/2021	Active
<input type="radio"/>	instance-example01	https://instance-example01.my.dev.us-west-2.nonprod.connect.aws.a2z.c...	Inbound, outbound telephony	6/28/2021	Active

A red arrow points to the 'Get started' button in the top right corner of the success message banner.

- On the **Welcome to Amazon Connect** page, choose **Skip for now**.

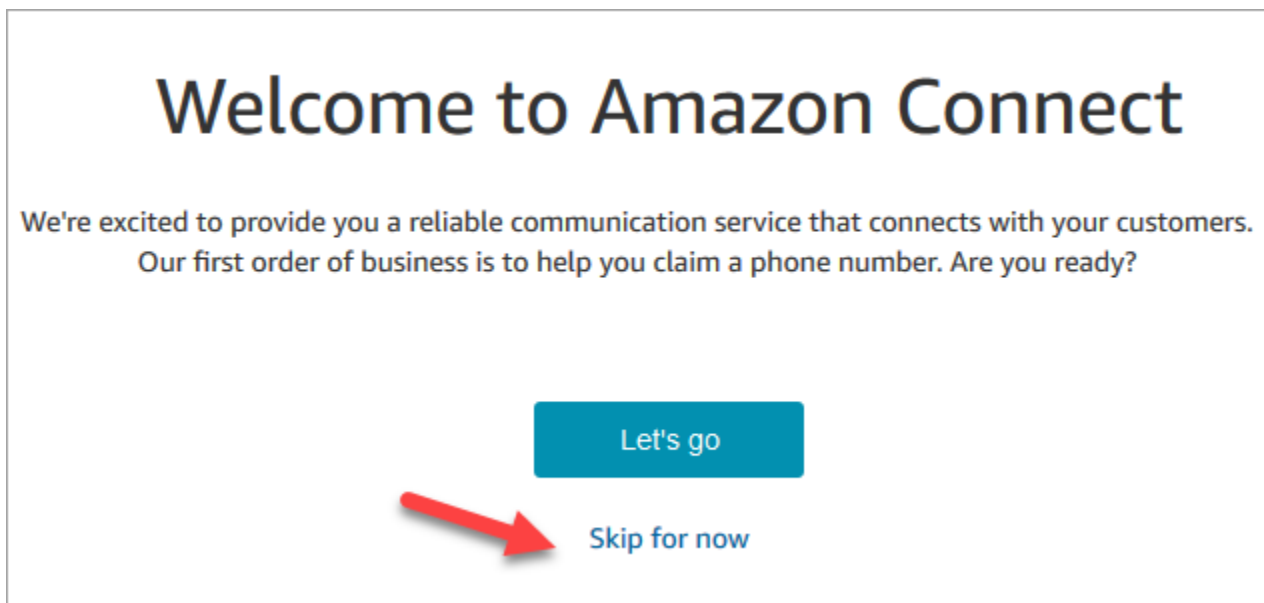

Welcome to Amazon Connect

We're excited to provide you a reliable communication service that connects with your customers. Our first order of business is to help you claim a phone number. Are you ready?

[Let's go](#)

[Skip for now](#)

A red arrow points to the 'Skip for now' link.

- You're now on the Amazon Connect dashboard. Your instance name (also called an **alias**) displays in the URL. On the left is the navigation menu.

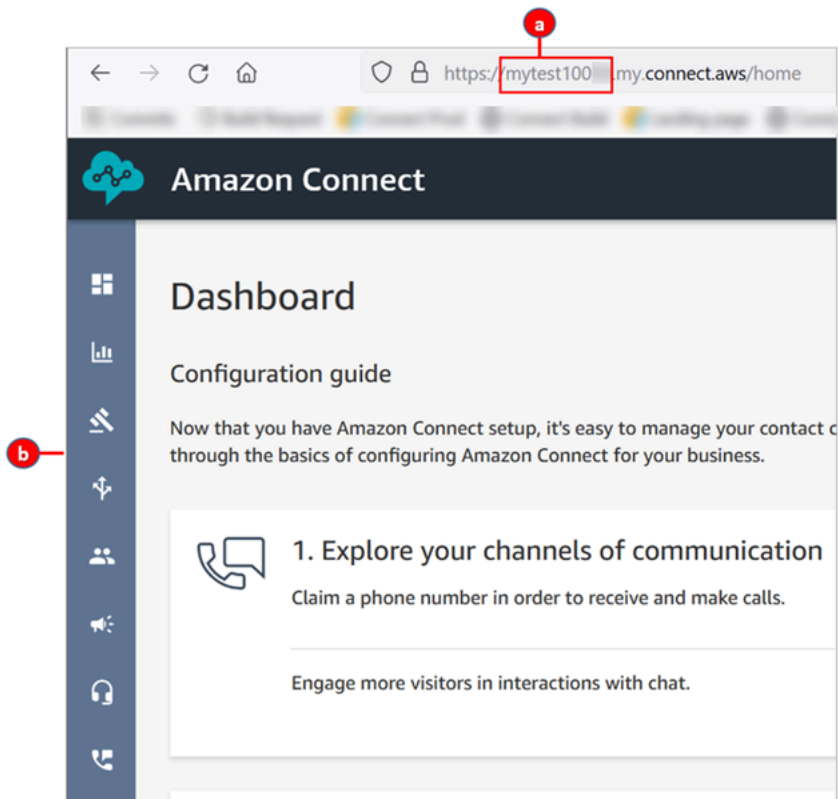

- a. Your instance alias is located in the first part of the URL.
- b. The navigation menu.

Congratulations! You set up your instance and now you're on the Amazon Connect dashboard. Go to [Step 3: Claim a phone number](#).

Step 3: Claim a phone number

In this step, you set up a phone number so that you can experiment with Amazon Connect.

1. On the Amazon Connect navigation menu, choose **Channels, Phone numbers**.

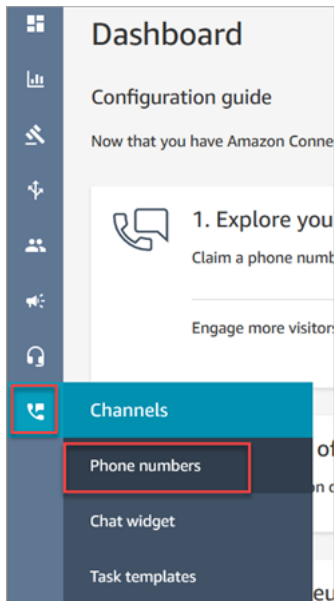

2. On the right side of the **Manage Phone numbers** page, choose **Claim a number**.

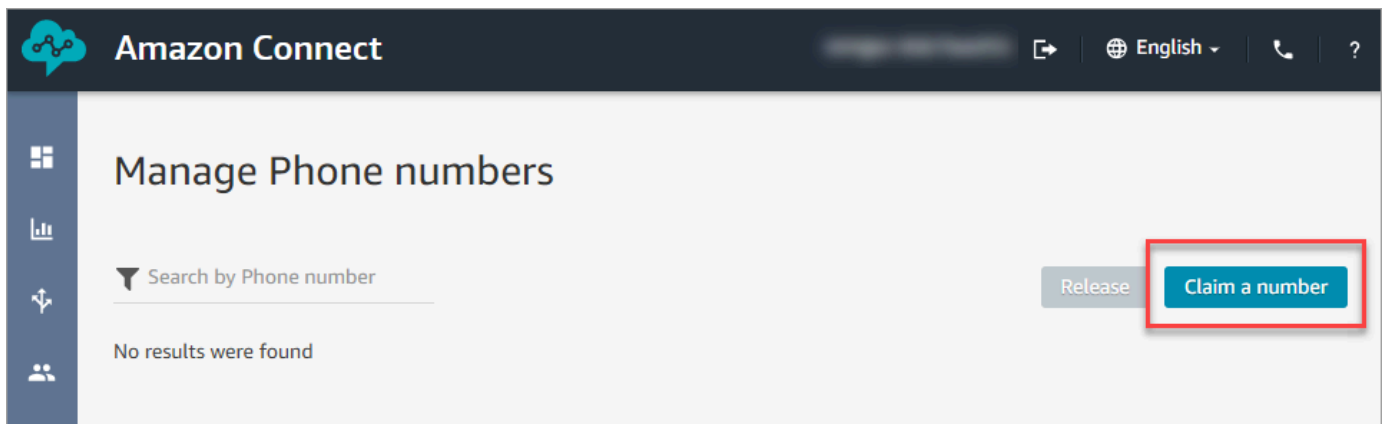

3. Select the **DID (Direct Inward Dialing)** tab. Use the drop-down arrow to choose your country/region. If you're in the US, you can specify the area code you want for your number, and only available numbers with that area code will be displayed. When numbers are returned, choose one.

Claim Phone number

Toll free **DID (Direct Inward Dialing)**

Country +1 Prefix (optional) 425

+1 425- [blurred]

+1 425- [blurred]

+1 425- [blurred]

4. Write down the phone number. You call it later in this tutorial.
5. In the **Description** box, type this note: **this number is for testing**.

Description

this number is for testing

224 of 250 characters remaining.

Contact flow / IVR

Sample inbound flow (first contact experience)

Save Cancel

6. In the **Flow / IVR** box, choose the drop-down arrow, and then choose **Sample inbound flow (first contact experience)**.
7. Choose **Save**.

Congratulations! You set up your instance and claimed a phone number. Now you're ready to experience how chat and voice work in Amazon Connect. Go to [Tutorial 2: Test the sample voice and chat experience](#).

Tutorial 2: Test the sample voice and chat experience

To better understand what the voice and chat experiences are like for your agents and customers, you can test them without doing any development.

This tutorial shows you how to access and use the [Contact Control Panel \(CCP\)](#). The CCP is a web page that agents use to accept and manage voice and chat contacts.

Prerequisites

This tutorial is part of a series. If you performed Tutorial 1, you're ready to go. If not, here's what you need:

- An AWS account
- A configured Amazon Connect instance
- An Amazon Connect administrative account
- A claimed phone number

Contents

- [Step 1: Handle a voice contact](#)
- [Step 2: Use the CCP to handle a chat contact](#)

Step 1: Handle a voice contact

1. On the Amazon Connect navigation menu, choose **Dashboard**.

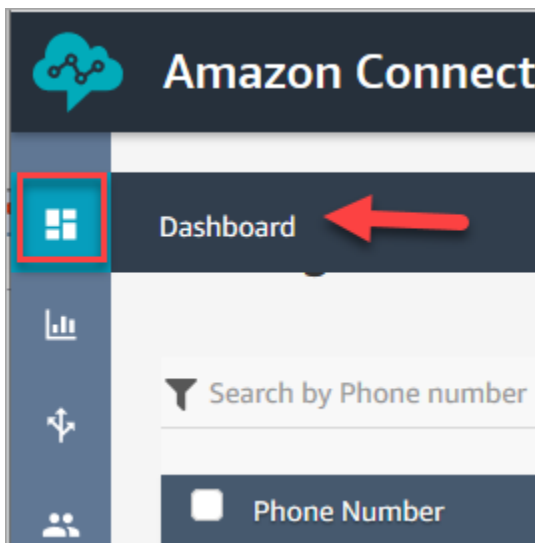

2. On the **Dashboard** page, choose **Test chat**.

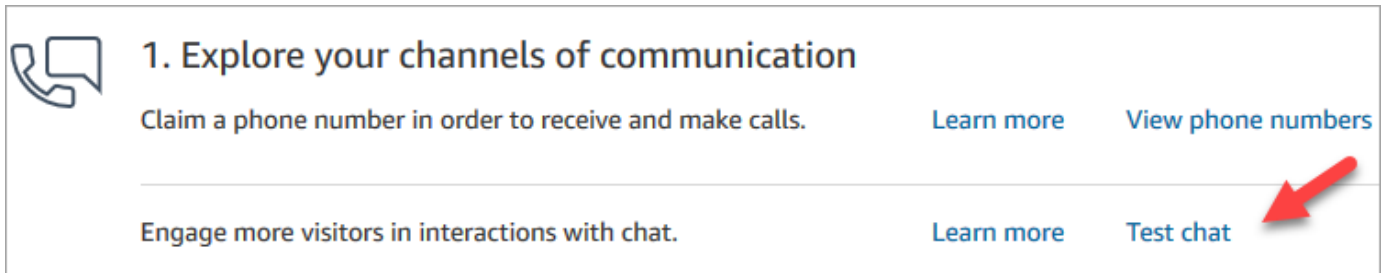

3. On the **Test Chat** page, choose **Activate Contact Control Panel**.

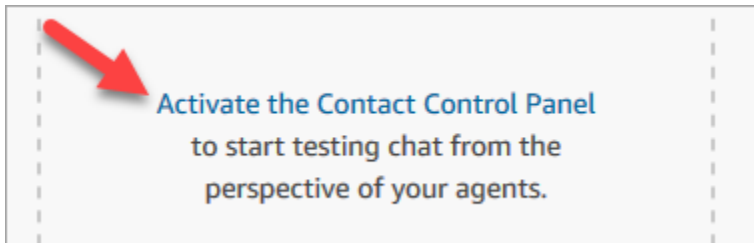

4. If your browser prompts you to grant microphone access, choose **Allow**.

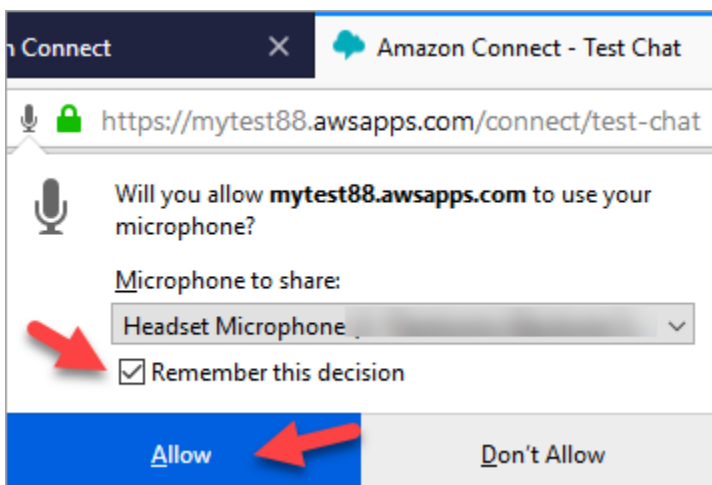

5. If your browser prompts you to allow notifications, choose **Allow**.

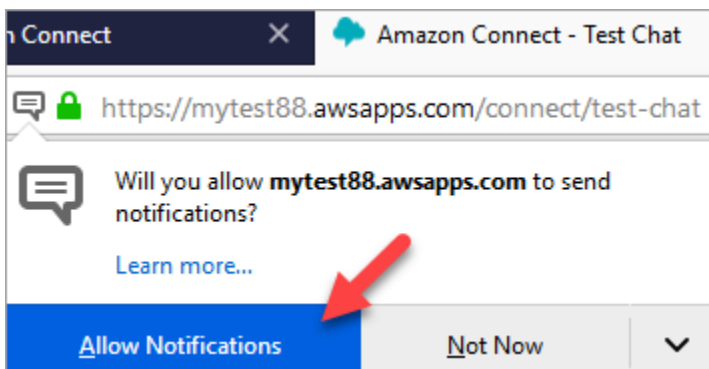

6. In the test CCP, set your status to **Available**.

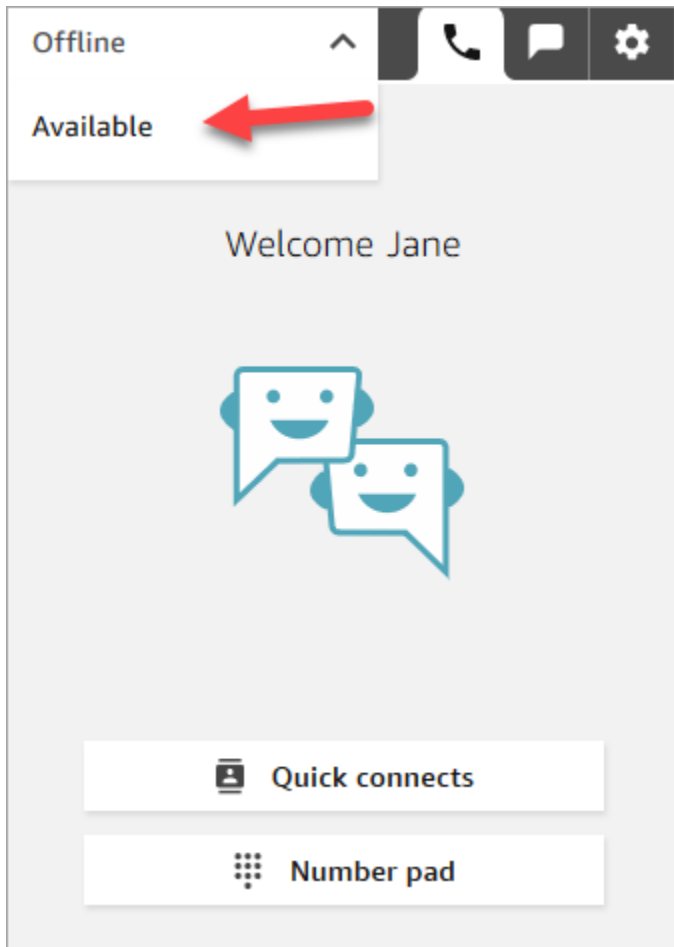

7. Use your mobile phone to call the phone number that you claimed earlier. If you didn't write down the number, you can find it by going to **Channels, Phone numbers**.
8. When your call is joined to Amazon Connect you'll hear "Press 1 to be put in queue for an agent, 2 to ...". This is the [Sample inbound flow](#) that Amazon Connect runs by default. You're going to change this later in the tutorial.
9. You can play around with the different options in the Sample inbound flow. To connect to an agent, press **1, 1, 1**.
10. In the CCP, choose **Accept call**.

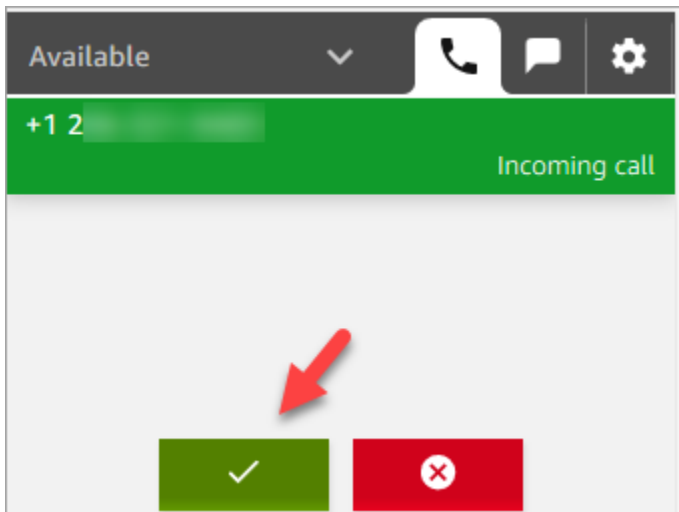

11. You'll see what the CCP looks like when an agent is connected to a customer.

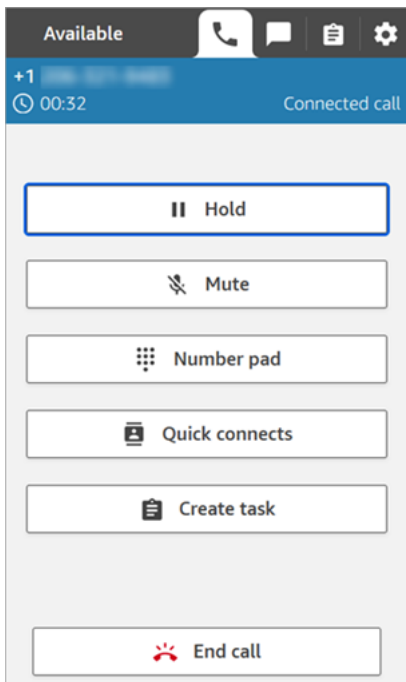

12. Choose **End call**.

Now the contact is in the After Contact Work (ACW) state. This is when the agent might enter some notes about the contact.

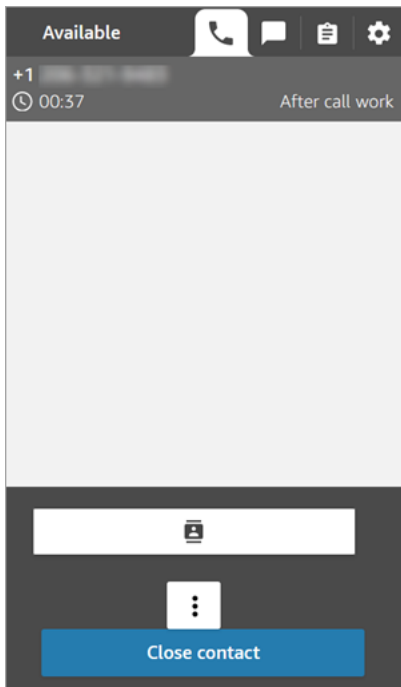

13. Choose **Close contact**. This frees the agent to take another incoming contact.

Well done! You've handled your first voice contact!

Tip

As an administrator, you can launch the CCP from anywhere on the Amazon Connect console by choosing the phone icon on the top of the page.

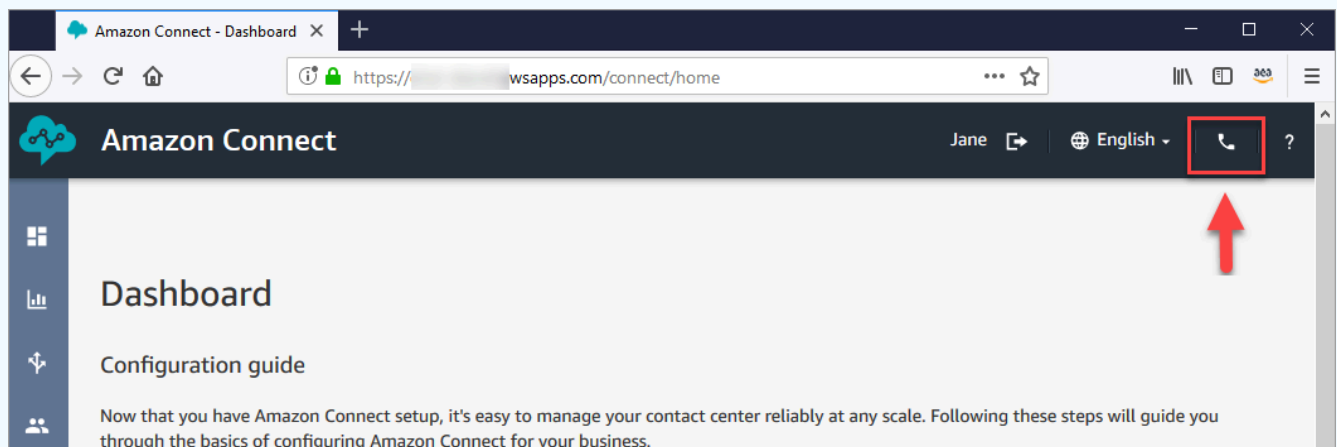

Next step

Go to [Step 2: Use the CCP to handle a chat contact](#) to experience how to handle a chat contact.

Step 2: Use the CCP to handle a chat contact

In Step 1, you used the Contact Control Panel (CCP) to manage a voice contact. In this step, you experience how to use the CCP to manage a chat contact.

1. This procedure assumes you've completed [Step 1: Handle a voice contact](#). If you haven't, please do so now.
2. On the **Test chat** page, choose the chat bubble to start a chat.

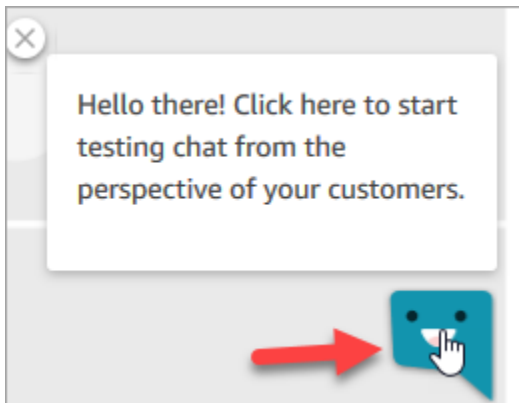

3. The Sample inbound flow automatically transfers to you a queue. However, you can type a message as the customer and the agent receives it. For example, *I need help resetting my password*.

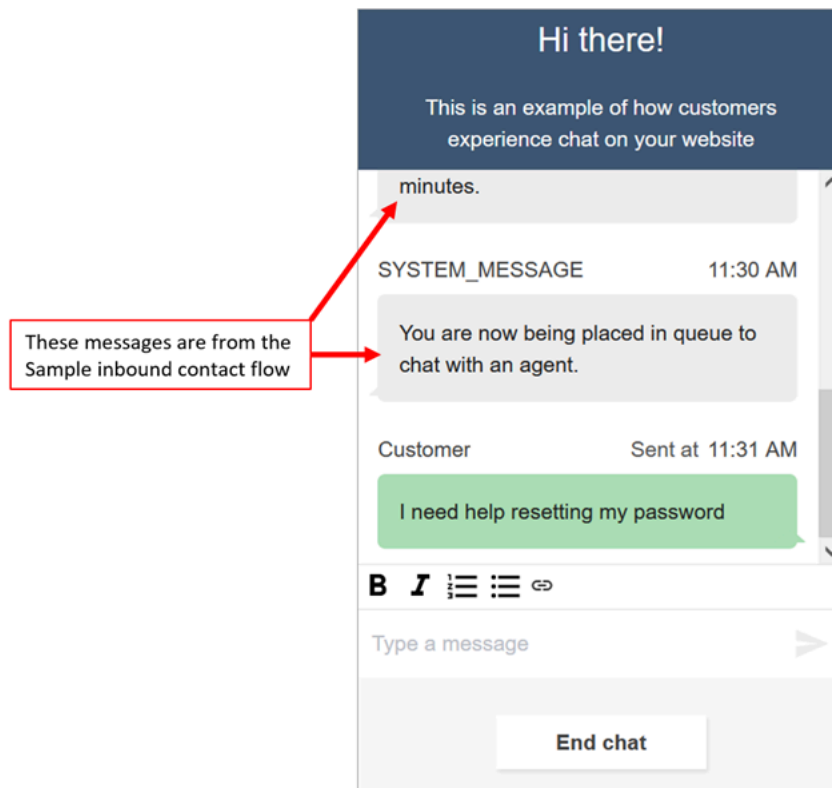

4. In the CCP, accept the incoming chat.

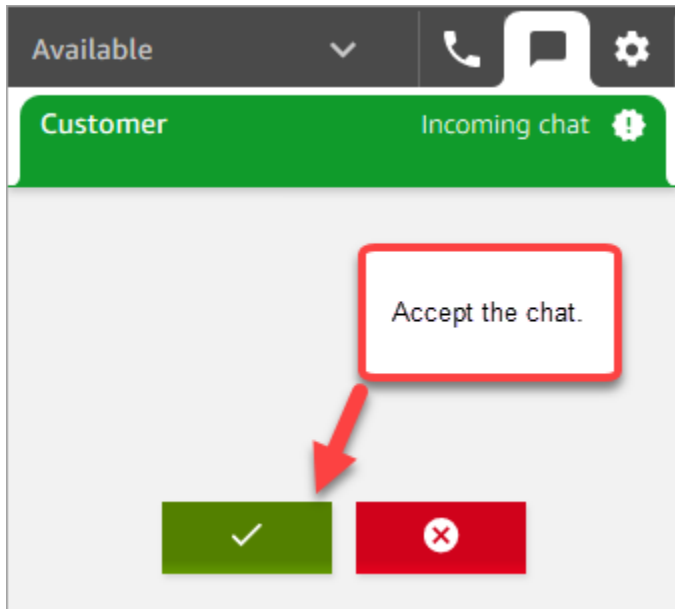

5. Use the CCP to send chat messages to the customer.

6. When you're done chatting, choose **End chat**. Then in the CCP, choose **Close contact**.

Congratulations! You've experienced what it's like to chat using Amazon Connect.

Next, try [Tutorial 3](#) to set up an IT Help Desk. It shows you how to set up routing, create a flow, and then test the custom voice and chat experience. Go to [Tutorial 3: Create an IT help desk](#).

Tutorial 3: Create an IT help desk

This tutorial shows you how to create an IT Help Desk. It shows how to create an Amazon Lex bot that finds out why the customer is calling. You next create a flow to use the customer's input to route them to the right queue.

Prerequisite

This tutorial is part of a series. If you performed Tutorial 1, you're ready to go. If not, here's what you need:

- An AWS account
- A configured Amazon Connect instance
- An Amazon Connect administrative account
- A claimed phone number

Contents

- [Step 1: Create an Amazon Lex bot](#)
- [Step 2: Add permissions to Amazon Lex bot](#)
- [Step 3: Set up routing](#)
- [Step 4: Create a flow](#)
- [Step 5: Assign the contact flow to the phone number](#)
- [Step 6: Test a custom voice and chat experience](#)

Step 1: Create an Amazon Lex bot

Bots provide an efficient way to offload repetitive tasks from your agents. This tutorial shows how to use the bot to find out why customers are calling the IT Help Desk. Later, we use the customer's response to route them to the right queue.

In previous tutorials, you used the Amazon Connect console. In this tutorial to set up a bot, you use the Amazon Lex console.

This step has five parts to it.

Contents

- [Part 1: Create an Amazon Lex bot](#)
- [Part 2: Add intents to your Amazon Lex bot](#)
- [Part 3: Build and test the Amazon Lex bot](#)

Part 1: Create an Amazon Lex bot

This step assumes it's the first time you've opened the Amazon Lex console. If you've created a Amazon Lex bot before, your steps differ slightly from the ones in this section.

1. Choose the following link to open the Amazon Lex console, or enter the URL in your web browser: <https://console.aws.amazon.com/lex/>.
2. If this is the first time you've created Amazon Lex bot, choose **Get Started**. Otherwise, you're already in the Amazon Lex dashboard.

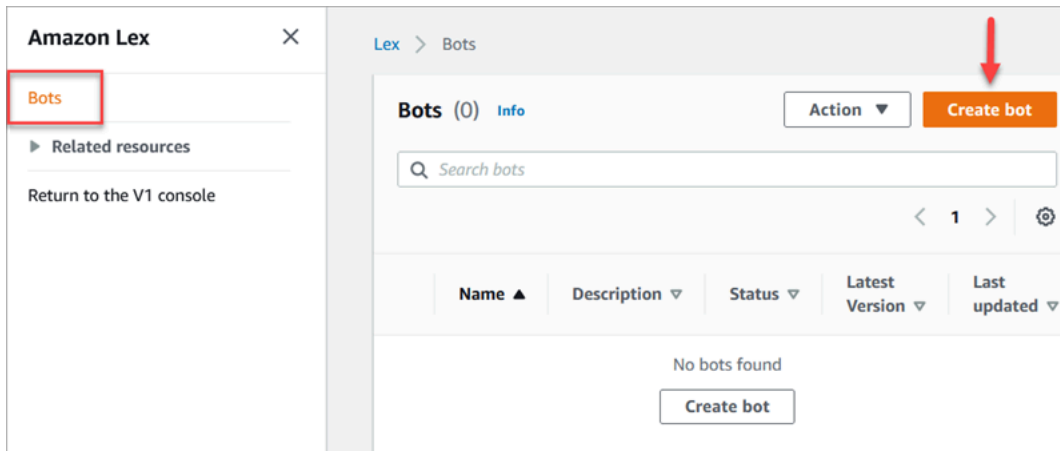

3. Choose **Create a blank bot**.

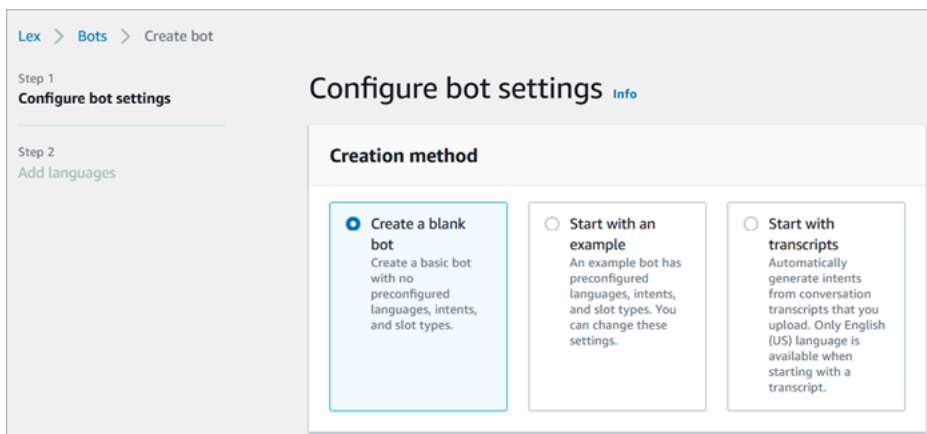

4. Enter the following information:

- **Bot name** — For this tutorial, name the bot **HelpDesk**.

Bot configuration

Bot name

Maximum 100 characters. Valid characters: A-Z, a-z, 0-9, -, _

Description - optional

This description appears on bot list page. It can help you identify the purpose of your bot.

Maximum 200 characters.

- **IAM permissions:** Choose **Create a role with basic Amazon Lex permissions**.

- **COPPA**— Choose whether the bot is subject to the [Children's Online Privacy Protection Act](#).
 - **Idle session timeout**— Choose how long the bot should wait to get input from a caller before ending the session.
5. Choose **Next**.
 6. On the **Add language to bot** page, choose the language and voice for your bot to use when speaking to callers. The default voice for Amazon Connect is Joanna.

7. Choose **Done**.

Go to [Part 2: Add intents to your Amazon Lex bot](#).

Part 2: Add intents to your Amazon Lex bot

An intent is the action the user wants to perform. In this part, add two intents to the bot. Each intent represents a reason that users call the Help Desk: password reset and network issues.

1. In the Amazon Lex console, in the **Intent details** section, enter **PasswordReset** as the name of your intent.

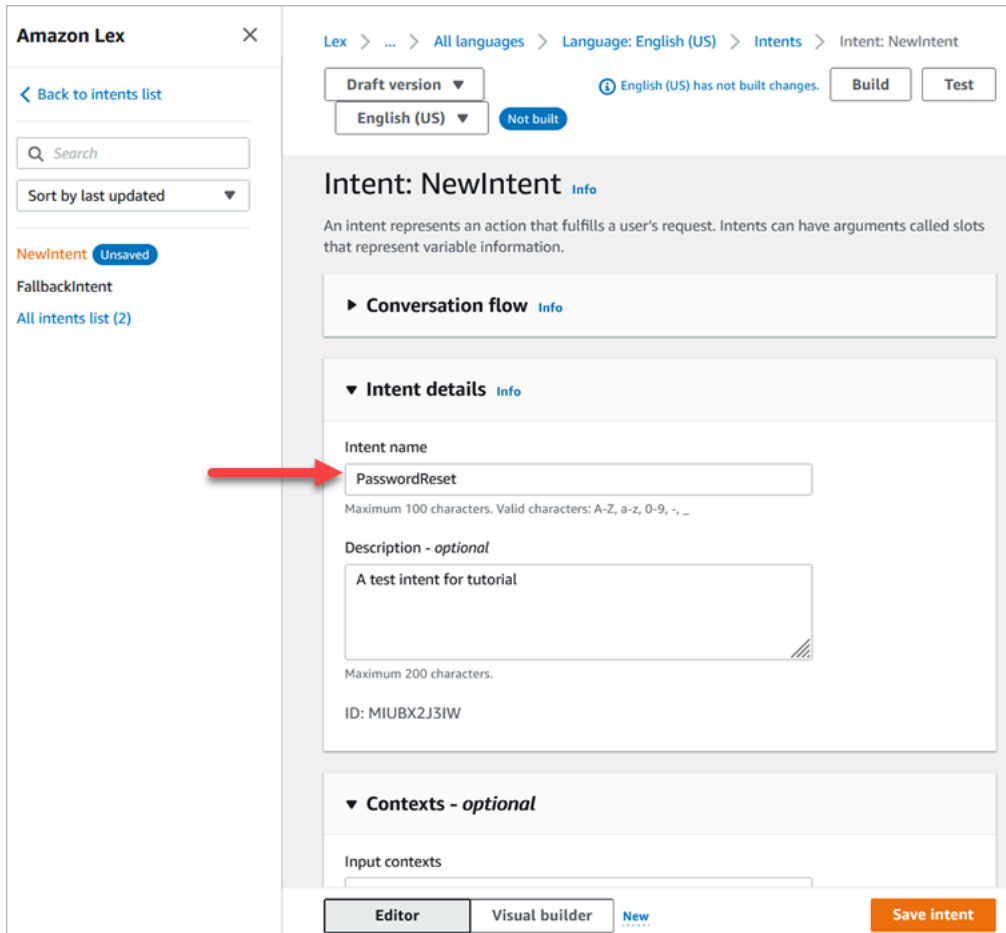

The screenshot shows the Amazon Lex console interface. On the left is a sidebar with 'Amazon Lex' and a list of intents including 'NewIntent' (marked as 'Unsaved'), 'FallbackIntent', and 'All intents list (2)'. The main content area shows the 'Intent: NewIntent' details page. At the top, there are navigation breadcrumbs, a 'Draft version' dropdown, a language selector set to 'English (US)', and 'Build' and 'Test' buttons. Below this is a 'Not built' status. The 'Intent details' section is expanded, showing the 'Intent name' field with the value 'PasswordReset' (highlighted by a red arrow), a description field with the text 'A test intent for tutorial', and an ID field with the value 'MIUBX2J3IW'. At the bottom, there are tabs for 'Editor' and 'Visual builder', and a 'Save intent' button.

2. Scroll to the **Sample utterances** section.

Sample utterances (2) [Info](#)

Representative phrases that you expect a user to speak or type to invoke this intent. Amazon Lex extrapolates based on the sample utterances to interpret any user input that may vary from the samples. The priority order of the sample utterances is not used to determine intent classification output.

Q Filter Sort by added (ascending) ▼

Preview Plain Text

I forgot my password

reset my password

I want to book a flight Add utterance

Maximum 250 characters.

3. Type **I forgot my password**, and then choose **Add utterance**. Then add **reset my password** and choose **Add utterance** again.
4. Choose **Save intent**.
5. On the left navigation menu, choose **All intents list**.
6. On the left navigation menu, choose **Back to intents list**.

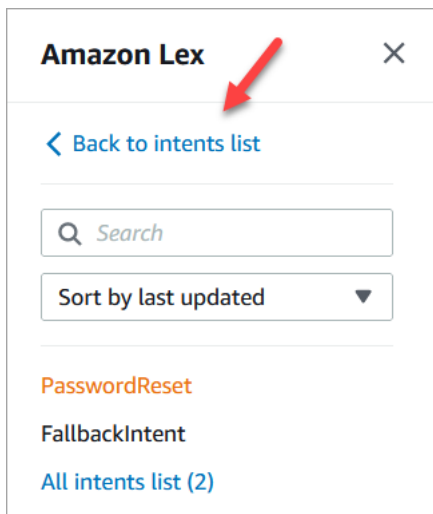

7. Choose **Add intent**, **Add empty intent**, and assign the name **NetworkIssue**. Scroll down the page and add the following sample utterances:

- **I can't access the internet**
- **my email is down**

When you're done, go to [Part 3: Build and test the Amazon Lex bot](#).

Part 3: Build and test the Amazon Lex bot

Build and test your bot to make sure that it works as intended before you publish it.

1. In the Amazon Lex console, choose **Build**. The build may take a minute or two.

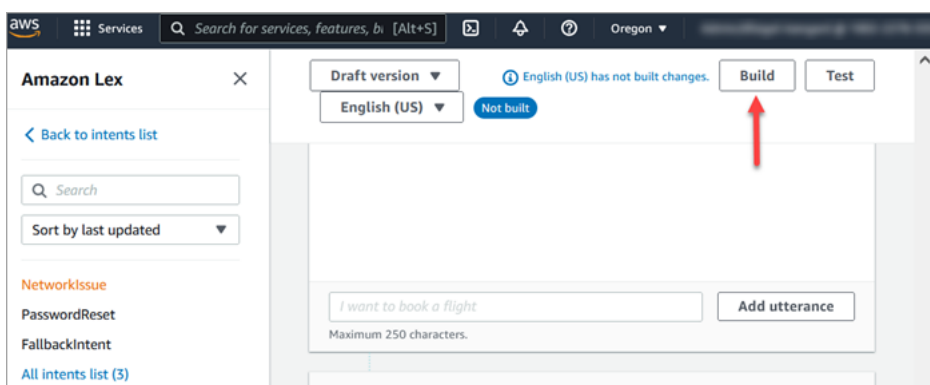

2. When it's finished building, choose **Test**.

3. Test the **PasswordReset** intent. In the **Test Draft version** pane, type **I forgot my password**, and press **Enter**.

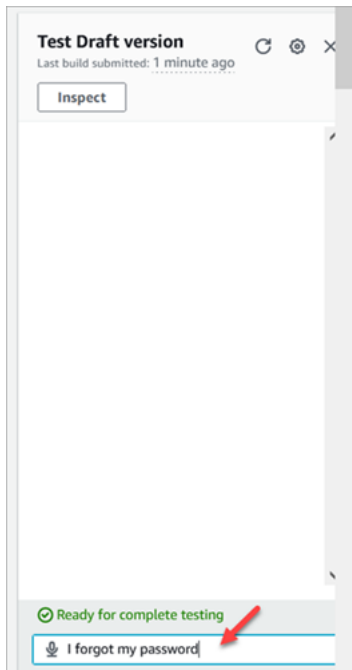

4. The verification looks like what's shown in the following image.

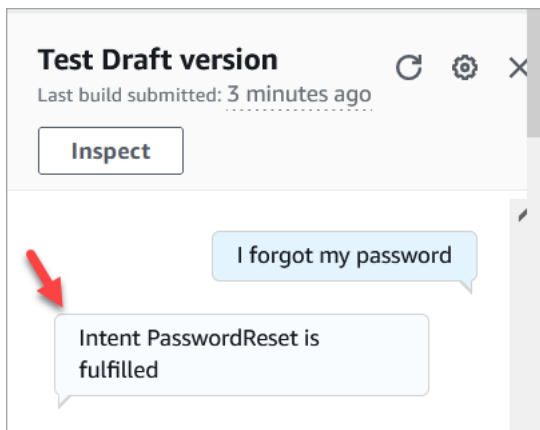

5. To confirm that the **NetworkIssue** intent is working, type **my email is down**. The verification looks like what's shown in the following image.

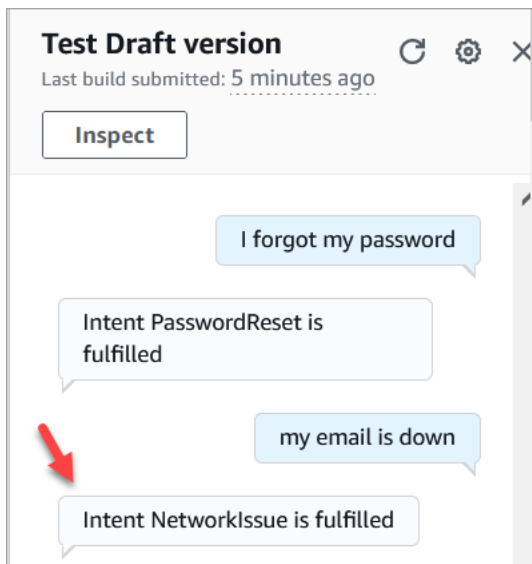

Go to [Step 2: Add permissions to Amazon Lex bot](#).

Step 2: Add permissions to Amazon Lex bot

To use a bot in your flow, add it to your Amazon Connect instance.

1. Open the [Amazon Connect console \(https://console.aws.amazon.com/connect/\)](https://console.aws.amazon.com/connect/).
2. Choose the name of the instance that you created.

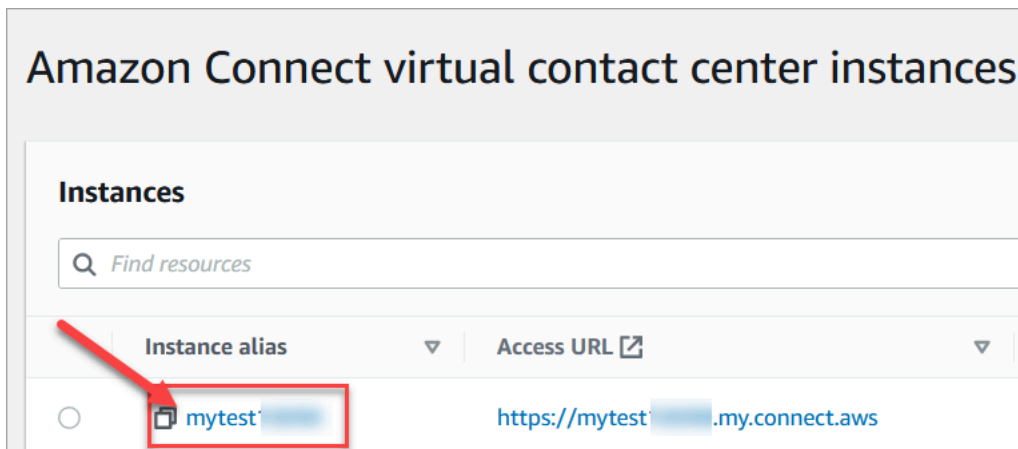

3. Do not log in on the name page (this method of logging in is for emergency access only). Rather, choose **Flows**.

The screenshot shows the Amazon Connect console interface. On the left is a navigation sidebar with the following items: Amazon Connect (with a close icon), Instances, Third-party applications (with a 'New' link), Overview (highlighted in blue), Channels and communications (with a dropdown arrow), Tasks, Telephony, Applications (with a dropdown arrow), Amazon Q, Analytics tools, Cases, Customer Profiles, Forecasting, capacity planning, and scheduling (with a 'New' link), Voice ID, Approved origins, Data storage, Data streaming, and Flows. At the bottom of the sidebar is a 'Documentation' link with an external icon.

The main content area is titled 'Account overview' and contains three sections:

- Access information:** Shows the Access URL as `https://[redacted].my.connect.aws` with an external link icon.
- Distribution settings:** Shows the Instance ARN as `arn:aws:connect:us-west-2:[redacted]:insta` with a copy icon, and the Directory as `[redacted]`.
- Tags:** A section header with a right-pointing triangle icon and a description: 'Tags are key-value pairs that you can add to AWS resour'.

4. Under **Amazon Lex**, use the drop-down arrow to choose **HelpDesk**. Under **Alias**, choose **TestBotAlias**, and then choose **+ Add Lex Bot**, and then choose **Add Amazon Lex Bot**.

Amazon Lex

Integrate Amazon Lex bots into your contact flows to take advantage of the same speech recognition and natural language understanding technology that powers Alexa. By adding Lex bots, you are granting Amazon Connect permission to interact with them [Create a new Lex bot](#)

Region: Bot:

Alias:

Amazon Lex bot

5. When you're done, choose Amazon Connect to navigate back to instances page.

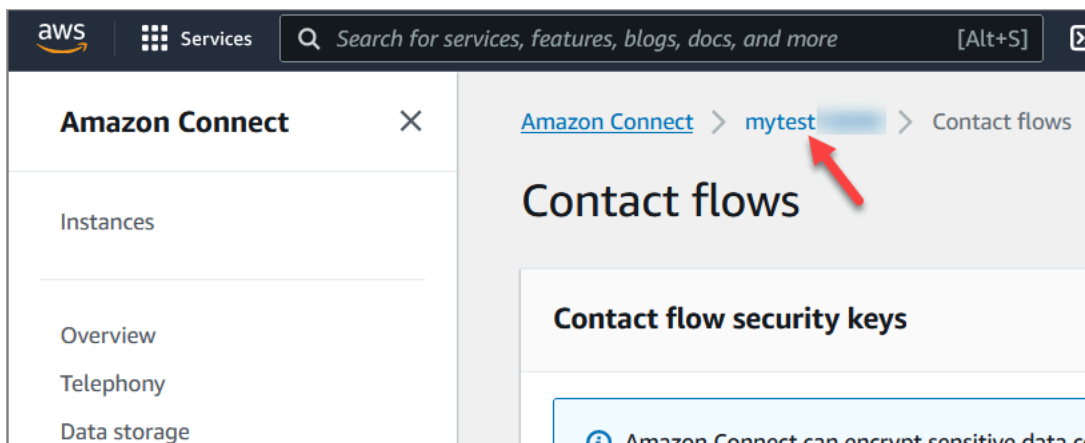

6. Choose the access URL of your instance.

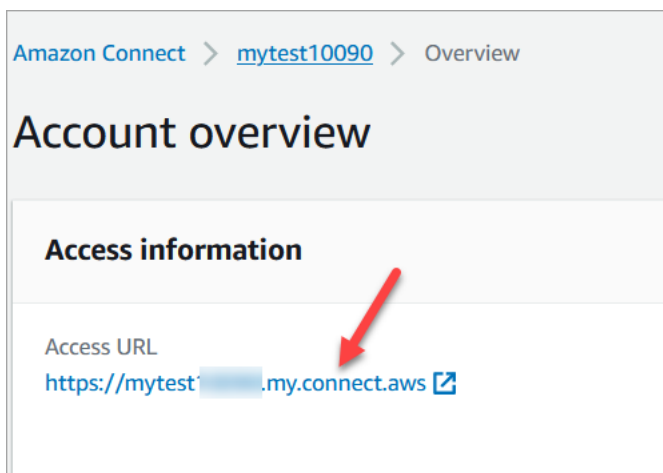

The **Access URL** takes you back to the Amazon Connect dashboard.

Step 3: Set up routing

In this step, you start at the Amazon Connect console for your instance. This step shows how to set up your queues, create a routing profile, and then assign your user account to the profile.

1. On the navigation menu, go to **Routing, Queues**.

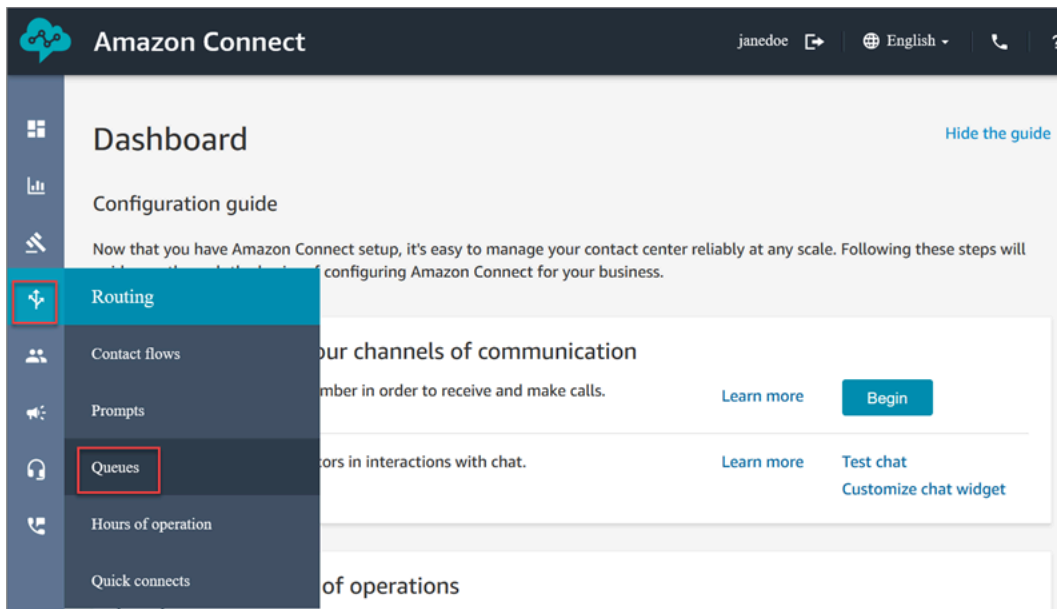

2. Choose **Add queue**.

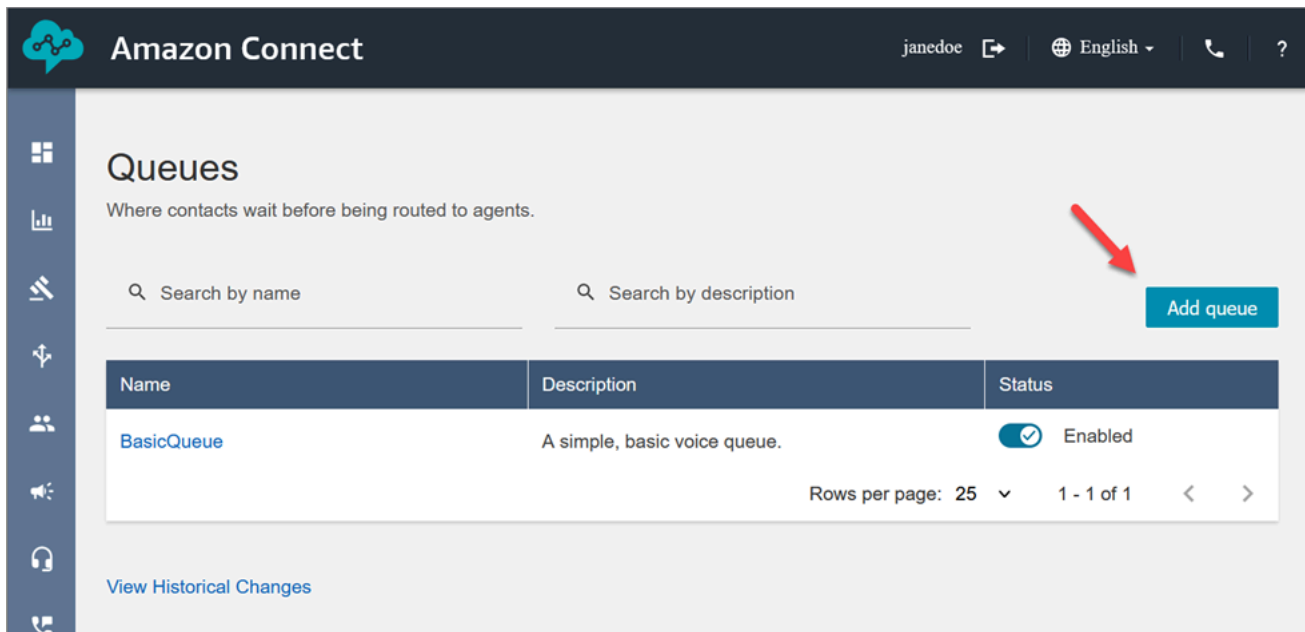

3. Complete the **Add queue** page, as shown in the following image, to add a queue named **PasswordReset**. When done, choose **Save**.

Queues > Add queue

Add queue

Queue Details

Name	Description
<input type="text" value="PasswordReset"/> Required 13 / 127	<input type="text" value="Help customers reset their password"/>

Hours of operation

Set the hours of operation and timezone for a queue. [Learn more.](#)

<input type="text" value="Search hours of operation"/> <input type="button" value="X"/> <input type="button" value="v"/>
<input type="text" value="Basic Hours"/> Required

The following image shows the **Settings** section of the **Add queue** page. Add your default caller ID name and outbound caller ID number.

Settings

Outbound caller configuration

Set the default caller ID name that will display to customers. [Learn more.](#)

Default caller ID name	Outbound caller ID number	Outbound whisper flow
<input type="text" value="Callback ID name"/> <input type="text" value="Example Corp"/> 12 / 255	<input type="text" value="Search for phone numbers"/> <input type="text" value="+1 503-922-7089"/> <input type="button" value="X"/> <input type="button" value="v"/>	<input type="text" value="Search for contact flow"/>

For the purposes of this tutorial, leave the following empty: Outbound whisper flow, Quick connect, and Maximum contact in queue.

4. Add a queue named **NetworkIssue**. Complete the **Add queue** page like you did for the **PasswordReset** queue.

When done, you'll have three queues.

Queues

Where contacts wait before being routed to agents.

Search by name Search by description [Add queue](#)

Name	Description	Status
BasicQueue	A simple, basic voice queue.	<input checked="" type="checkbox"/> Enabled
NetworkIssue	Help customers with their network issues	<input checked="" type="checkbox"/> Enabled
PasswordReset	Help customers reset their password	<input checked="" type="checkbox"/> Enabled

Rows per page: 25 1 - 3 of 3 < >

[View Historical Changes](#)

5. On the navigation menu, go to **Users, Routing Profiles**.

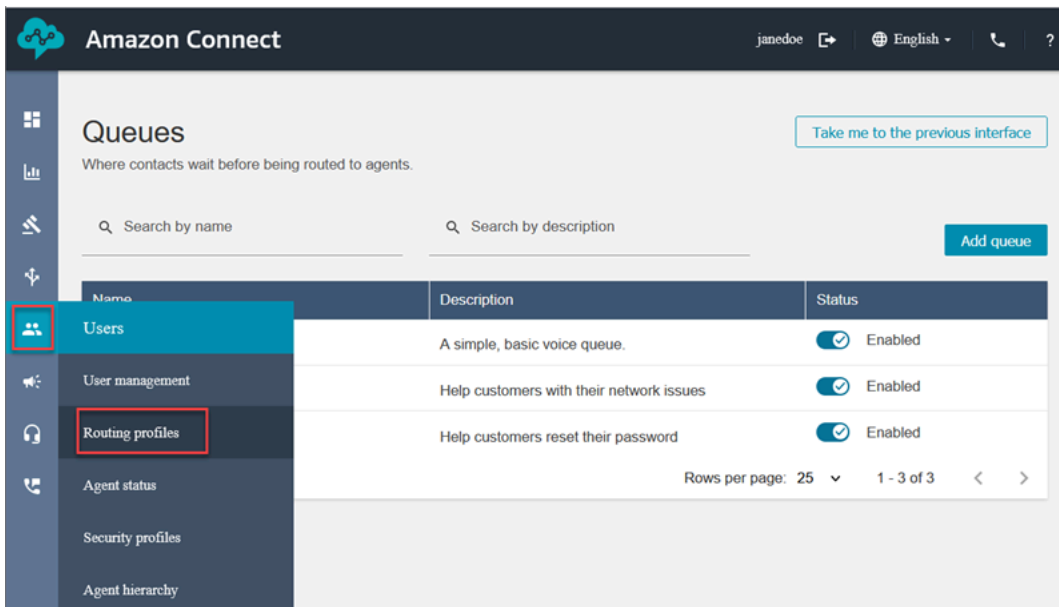

Amazon Connect janedoe English ?

Queues

Where contacts wait before being routed to agents.

Search by name Search by description [Add queue](#)

Name	Description	Status
BasicQueue	A simple, basic voice queue.	<input checked="" type="checkbox"/> Enabled
NetworkIssue	Help customers with their network issues	<input checked="" type="checkbox"/> Enabled
PasswordReset	Help customers reset their password	<input checked="" type="checkbox"/> Enabled

Rows per page: 25 1 - 3 of 3 < >

[Take me to the previous interface](#)

- [Users](#)
- [User management](#)
- [Routing profiles](#)
- [Agent status](#)
- [Security profiles](#)
- [Agent hierarchy](#)

6. Choose **Add routing profile**.

The screenshot shows the Amazon Connect interface for managing routing profiles. At the top, the user is logged in as 'janedoe' and the language is set to 'English'. The main heading is 'Routing profiles' with a sub-heading: 'Use routing profiles to route specific types of contacts to agents with specific skill sets. [Learn more](#)'. Below the heading are two search filters: 'Search by name' and 'Search by description'. A red box highlights the 'Add routing profile' button in the top right corner. Below the filters is a table with the following data:

Name	Description	Number of associated queues	Number of agents staffed
Basic Routing Profile	A simple routing profile.	1	1

At the bottom of the table, it says 'Rows per page: 25' and '1 - 1 of 1'. There are also navigation arrows. Below the table is a link: 'View historical changes'.

- Assign a name to the new profile (for example, **Test routing profile**). Enter a description, select **Voice, Chat**, and set **Maximum chats** to **1**.

The screenshot shows the 'Routing profile details' page for the 'Test routing profile'. The 'Name' field is 'Test routing profile' (Required, 20 / 127 characters) and the 'Description' is 'Help customers with their IT issues' (Required). Below this is the 'Settings' section, titled 'Set channels and concurrency'. It specifies that this setting determines which channels agents use in the CCP. Below this, there are two checked checkboxes: 'Voice' and 'Chat'. At the bottom, there is a dropdown menu for 'Maximum chats per agent (Maximum of 10)' set to '1' (Required).

- In the **Queues** section, use the drop-down arrow to search for the queues you just created. Choose **NetworkIssue**, select **Voice** and **Chat**. Choose **Add Queue**.

The screenshot shows the 'Queues' section. At the top, there are 'Delete Queue' and 'Add Queue' buttons. Below this is a table with the following data:

Name	Channels	Priority	Delay (seconds)	Delete
NetworkIssue	<input checked="" type="checkbox"/> Voice <input checked="" type="checkbox"/> Chat <input type="checkbox"/> Task	Priority	Delay (seconds)	

A red arrow points to the 'Add Queue' button.

9. Add the **PasswordReset** queue. Select **Voice** and **Chat**, and then choose **Save**.
10. Under **Default outbound queue**, use the drop-down arrow to choose **BasicQueue**.

Queues

Toggle these settings on and off to manage all queues that have been added to this profile - more information on copy. [Learn more](#) [Delete Queue](#) [Add Queue](#)

<input type="checkbox"/>	Name	Channels	Priority	Delay (seconds)	Delete
<input type="checkbox"/>	BasicQueue	<input checked="" type="checkbox"/> Voice <input checked="" type="checkbox"/> Chat <input type="checkbox"/> Task	1	0	
<input type="checkbox"/>	NetworkIssue	<input checked="" type="checkbox"/> Voice <input checked="" type="checkbox"/> Chat <input type="checkbox"/> Task	1	0	
<input type="checkbox"/>	PasswordReset	<input checked="" type="checkbox"/> Voice <input checked="" type="checkbox"/> Chat <input type="checkbox"/> Task	1	0	

Default outbound queue

Choose a queue to be associated with outbound calls placed by the agents.

Search for outbound queues

BasicQueue

11. When done, scroll to the top of the page, and choose **Save** to save the profile.
12. On the navigation menu, go to **Users, User management**.

Routing profiles

Use routing profiles to route specific types of contacts to

Search by name

Users

User management

Routing profiles

Agent status

Security profiles

Agent hierarchy

13. On the **User management** page, select your login name.
14. On the **Edit** page, in the **Settings** section, in the **Routing profile** dropdown menu, choose the routing profile you created, for example, **Test routing profile**. Choose **Save**.

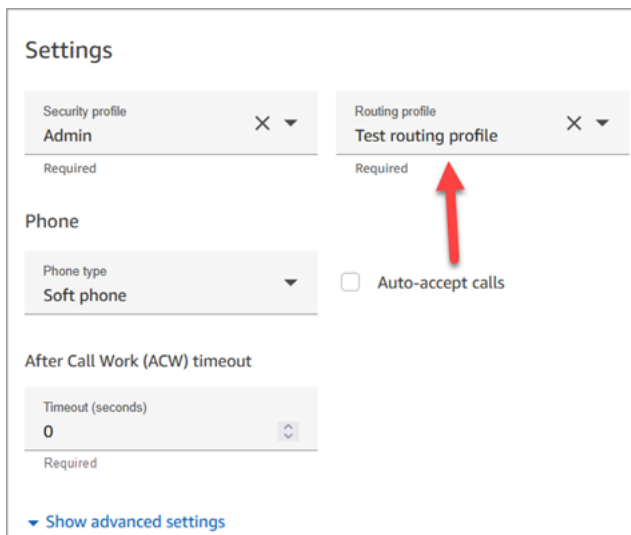

Settings

Security profile: Admin

Routing profile: Test routing profile

Required

Phone

Phone type: Soft phone

Auto-accept calls:

After Call Work (ACW) timeout

Timeout (seconds): 0

Required

Show advanced settings

Routing is all set up and ready to go.

Step 4: Create a flow

Although Amazon Connect comes with a set of [built-in flows](#), you can create your own flows to determine how a customer experiences your contact center. The flows contain the prompts that customers hear or see, and they transfer them to the right queue or agent, among other things.

In this step, create a flow that's specific to the IT Help Desk experience that you're creating.

1. On the Amazon Connect navigation menu, go to **Routing, Flows**.

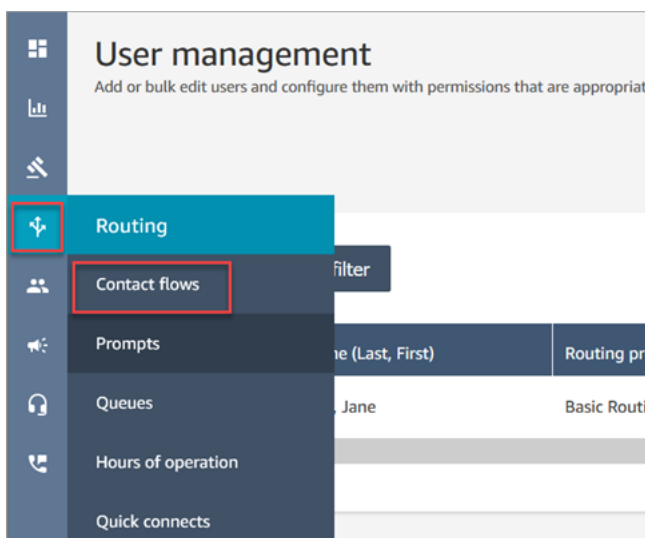

2. Choose **Create flow**.

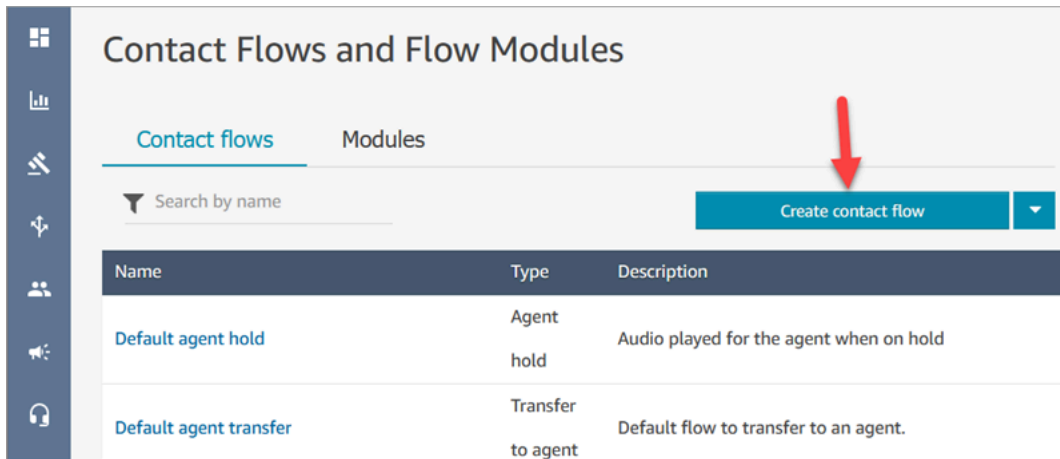

- The flow designer opens. Enter a name for the flow, such as **Test flow**.

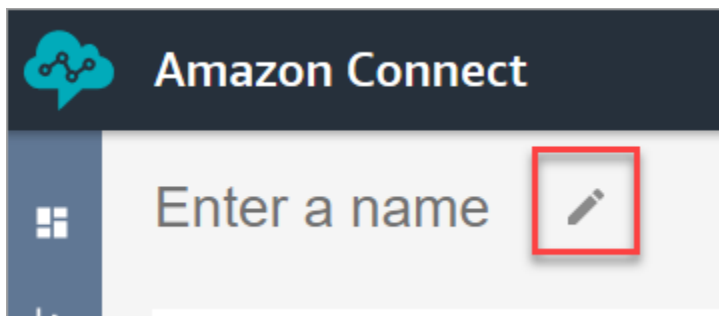

- Use the search box to search for the following block, and drag them onto the grid: [Set logging behavior](#), [Set voice](#), and [Play prompt](#).

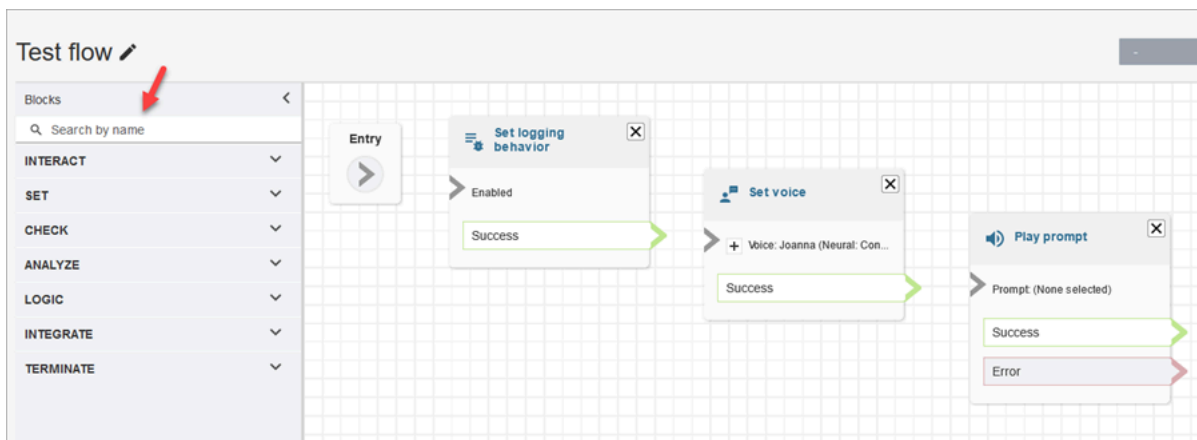

- Use your mouse to drag an arrow from the **Entry** block to the **Set logging behavior** block.

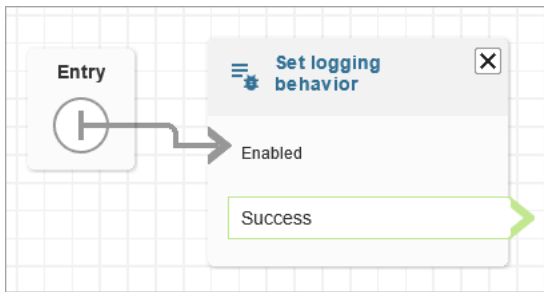

6. Connect the remaining blocks, as shown in the following image.

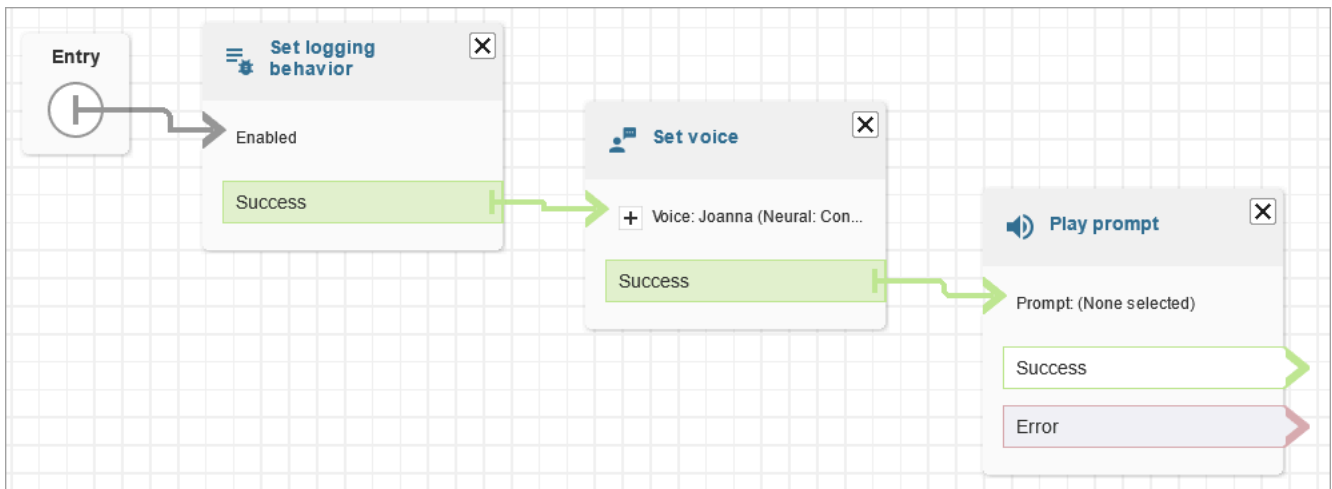

7. Choose the **Play prompt** title to open its properties page.

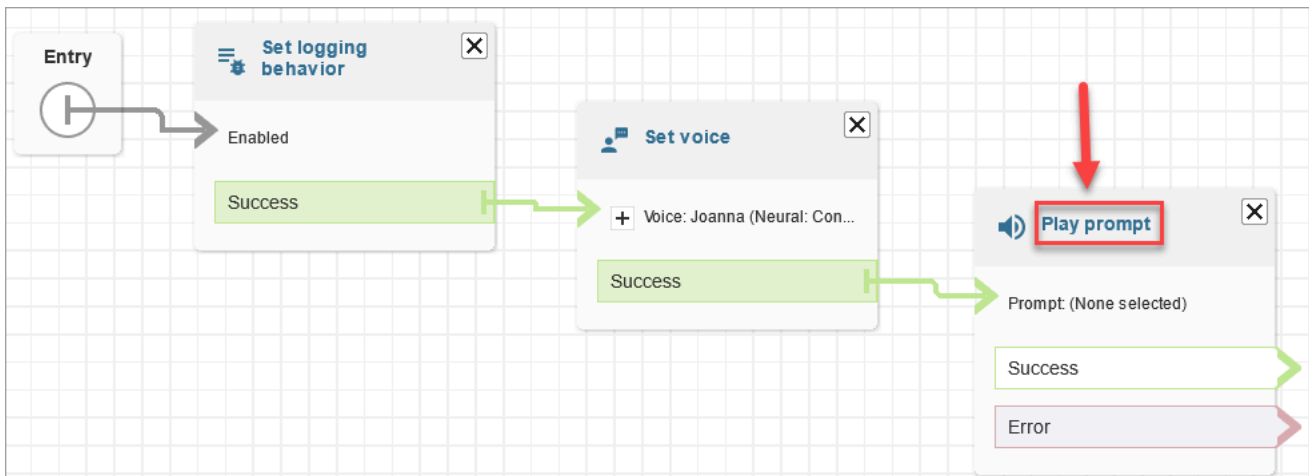

8. Configure the **Play prompt** block, as shown in the following image, and then choose **Save**. Choose **Text-to-speech or chat text**, choose **Set manually**, enter *Welcome to the IT Help desk*.

Play prompt ✕

Delivers an audio or chat message. [Info](#)

Select from the prompt library (audio)
 Specify an audio file from an S3 bucket
 Text-to-speech or chat text

Set manually

Enter text to be spoken

Welcome to the IT Help desk.

Set dynamically

Interpret as
Text ▼

9. Add a [Get customer input](#) block and connect to the **Play prompt** block.

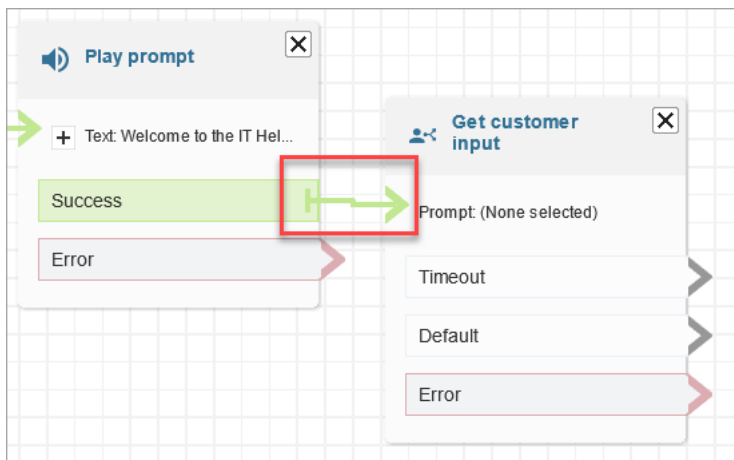

10. Choose the title of the [Get customer input](#) block to open the properties page.

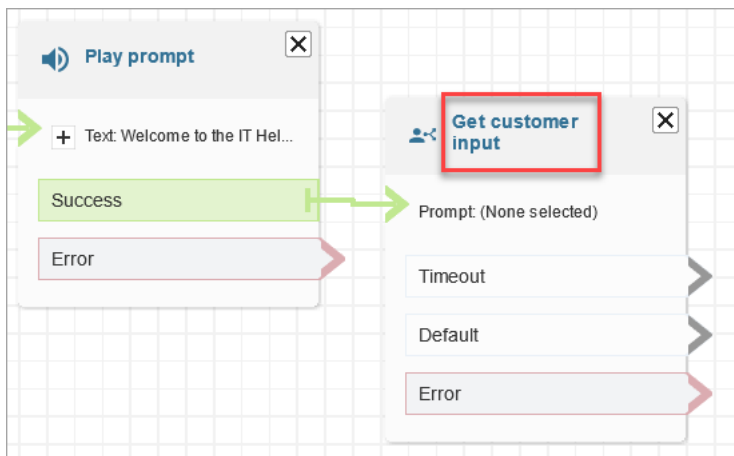

11. Configure the **Get customer input** block, as shown in the following images. Choose **Text-to-speech or chat text**, **Set manually**, and enter *How can I help* in the text box. Set the **Interpret as** dropdown box to **Text**.

Get customer input ×

Delivers an audio or chat message to solicit customer input. Based on response, the contact flow branches. [Info](#)

Select from the prompt library (audio)

Specify an audio file from an S3 bucket

Text-to-speech or chat text

Set manually

Enter text to be spoken
How can I help?

Set dynamically

Interpret as
Text ▼

The following image shows the Amazon Lex tab. Choose the name of your Amazon Lex bot from the dropdown list. For **Alias** enter **\$LATEST**.

DTMF Amazon Lex

Plays an audio prompt and branches based on DTMF or Amazon Lex intents. The audio prompt is interruptible when using DTMF.

Lex bot

Name

HelpDesk () × ▼

Alias

\$LATEST

12. While still in the **Get customer input** block, choose **Add an intent**.

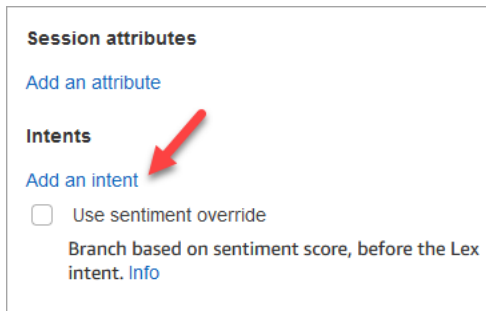

13. Enter the names of the intents that you created in the Amazon Lex bot, such as PasswordReset and NetworkIssue. They are case sensitive!

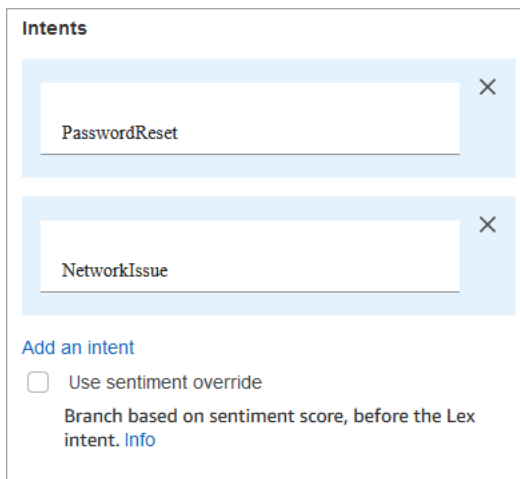

14. Choose **Save**.
15. Add a **Play prompt** block and connect it to the **PasswordReset** branch.
16. Choose the **Play prompt** title to open its properties page. Configure the **Play prompt** block with the message *We're putting you in a queue to help you with password reset*. Choose **Save**.
17. Add a second **Play prompt** block and connect it to the **NetworkIssue** branch.
18. Choose the **Play prompt** title to open its properties page. Configure the **Play prompt** block with the message *We're putting you in a queue to help you with your network issues*. Choose **Save**.
19. Add a [Disconnect / hang up](#) block to the grid. Connect the **Default** and **Error** branches to it.
20. Add a [Set working queue](#) block to the grid. Connect the **Play prompt** block for PasswordReset.

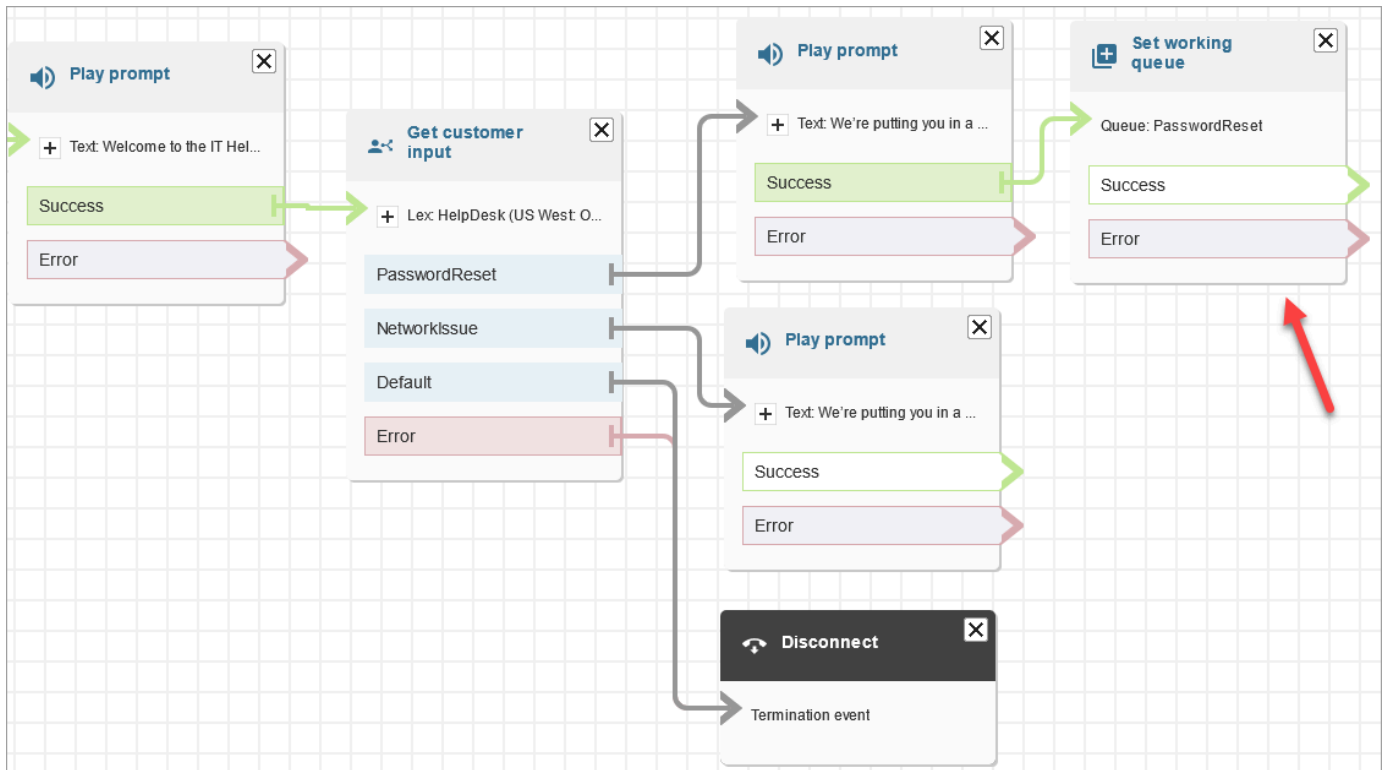

21. Choose the **Set working queue** title to open its properties page. Configure the **Set working queue** block by using the drop-down arrow to choose the **PasswordReset** queue. Choose **Save**

Set working queue ✕

Specify the queue that the contact will be transferred to.

Select a queue to perform actions on, such as transferring a contact to it or retrieving metrics about it. [Info](#)

By queue
 Set manually
 Set dynamically
 By agent

Search for queue

PasswordReset

▼

22. Add a **Set working queue** block for NetworkIssue, and configure it with the NetworkIssue queue.

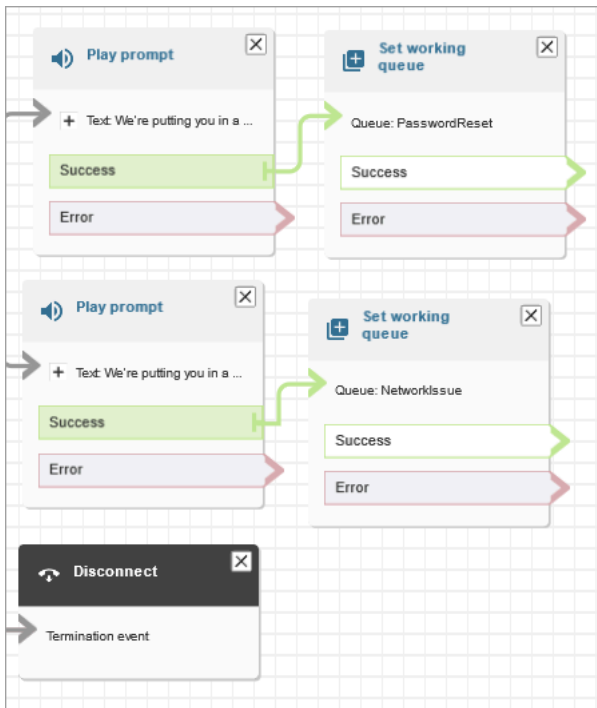

23. Drag two **Transfer to queue** blocks (from the **Terminate/Transfer** group) onto the grid.
24. Connect each of the **Set working queue** blocks to a **Transfer to queue** block.
25. Drag another **Disconnect/hang up** block onto the grid. Connect all of the remaining **Error** and **At capacity** branches to it.
26. The completed flow looks similar to the following image.

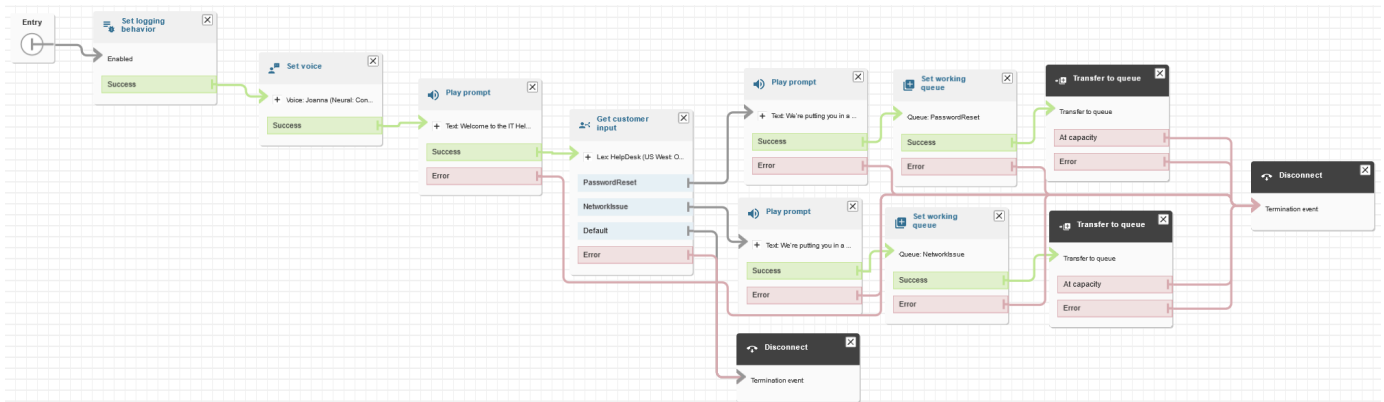

27. Choose **Save**, and then choose **Publish**.

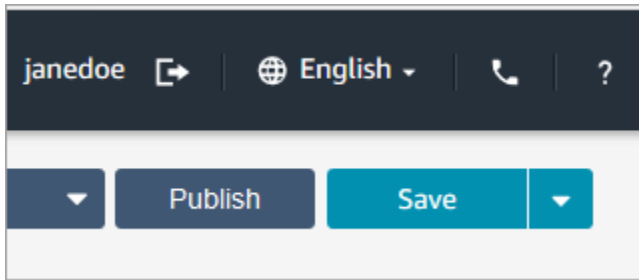
**i Tip**

Any blocks that aren't connected or configured correctly generate an error. If this happens, double-check that all branches are connected.

28. When the flow publishes, it displays the message that it saved successfully.

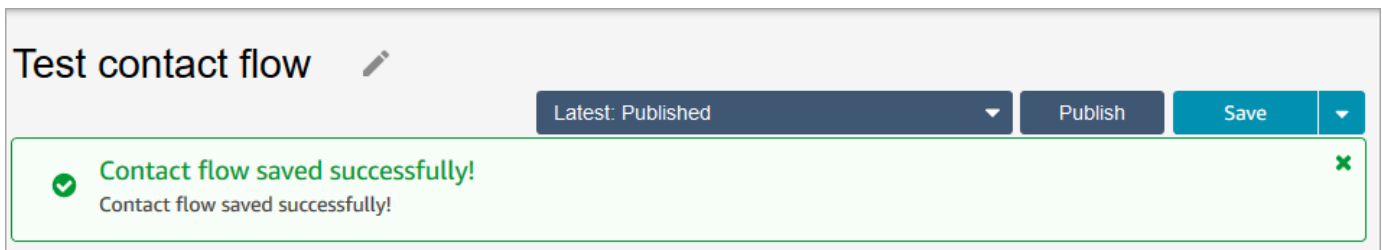

If the flow doesn't save, double-check that all the branches are connected to blocks. That's the most common reason flows don't publish.

Step 5: Assign the contact flow to the phone number

1. On the navigation menu, go to **Channels, Phone Numbers**.
2. On the **Manage Phone numbers** page, choose your phone number.



3. Use the drop-down box to choose the flow you just created, and then choose **Save**.

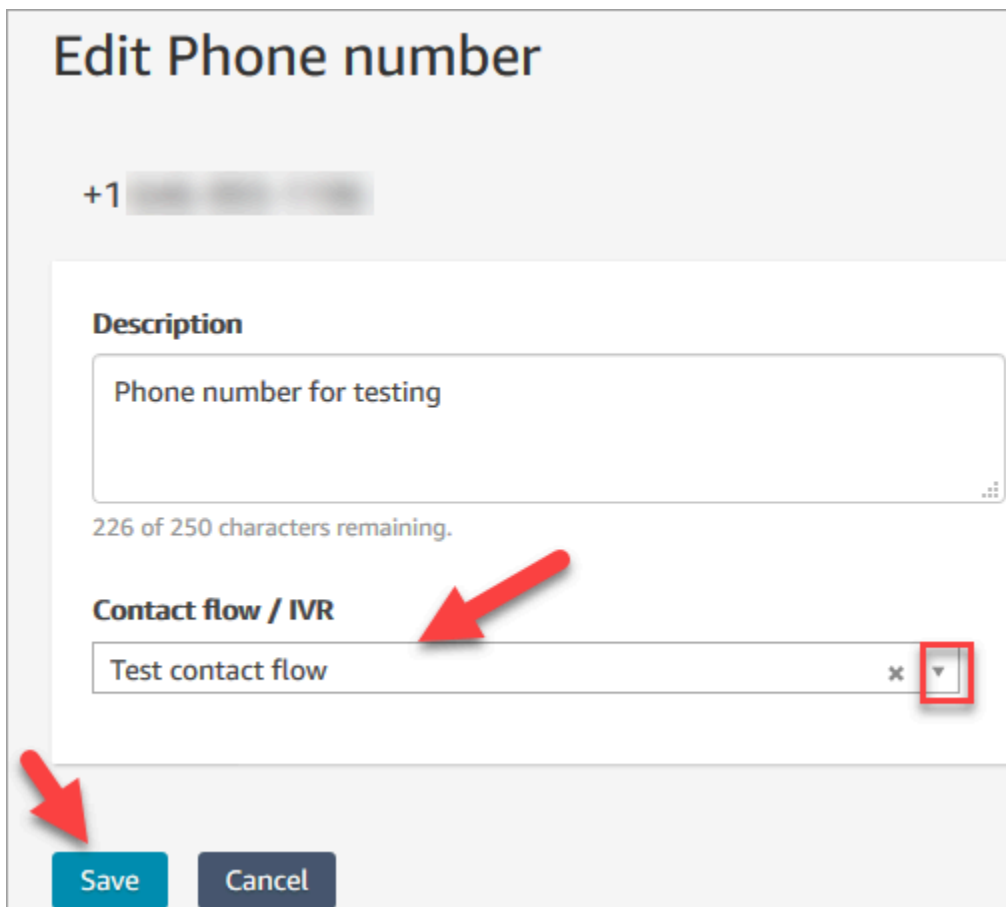

Everything is all set up! Now you're ready to test your IT Help Desk. Continue on to [Step 6: Test a custom voice and chat experience](#).

Step 6: Test a custom voice and chat experience

You're ready to try out the Amazon Lex bot, routing, and flow. The first step is to tell Amazon Connect which flow you want to test.

1. On the navigation menu, go to the **Dashboard** and choose **Test chat**.
2. Choose **Test Settings**.

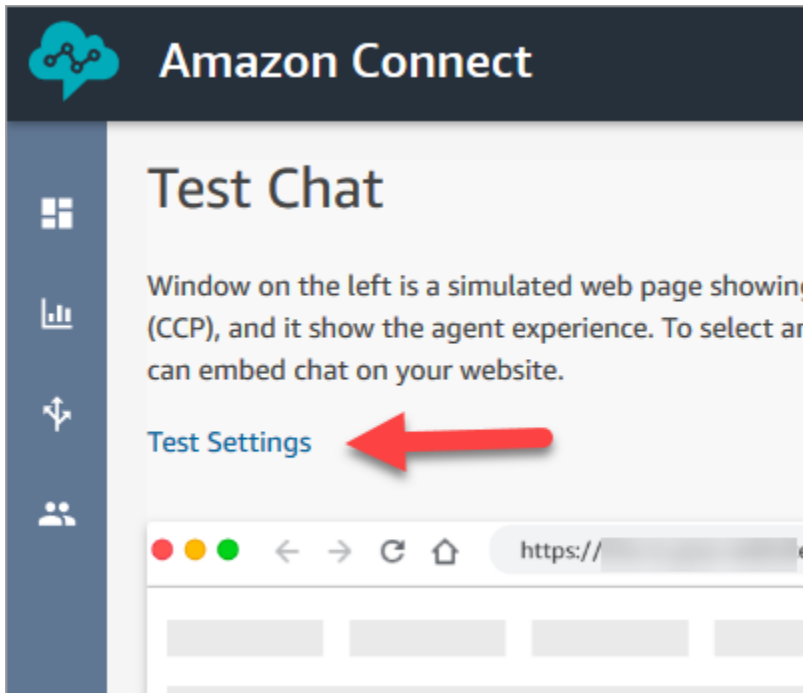

3. Use the drop-down box to choose the flow you created, for example, **Test flow**. Choose **Apply**.

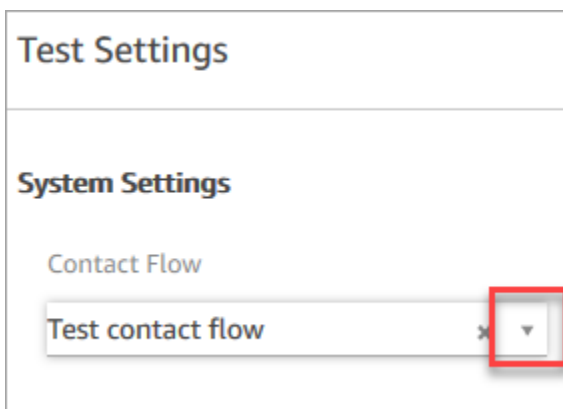

Test a custom chat experience

1. If needed, choose the chat bubble to start a chat.

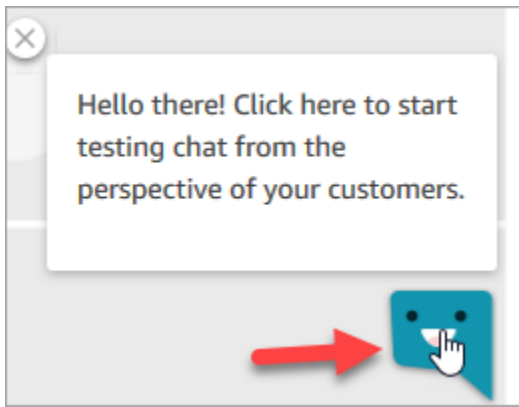

2. Amazon Connect automatically detects a contact and runs the flow that you created. It displays messages from the flow.

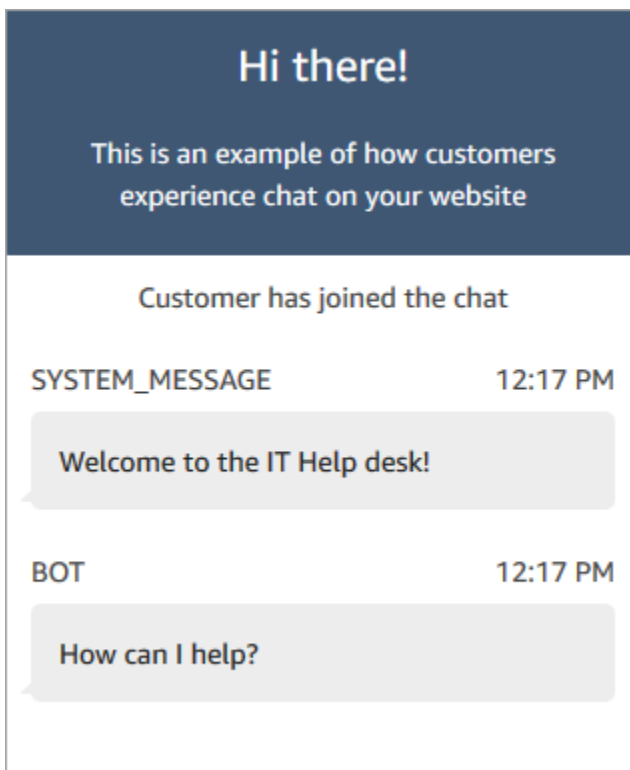

3. Enter that you need help resetting a password. Then accept the incoming chat. The following image shows you what the chat and agent interfaces look like when you're trying them.

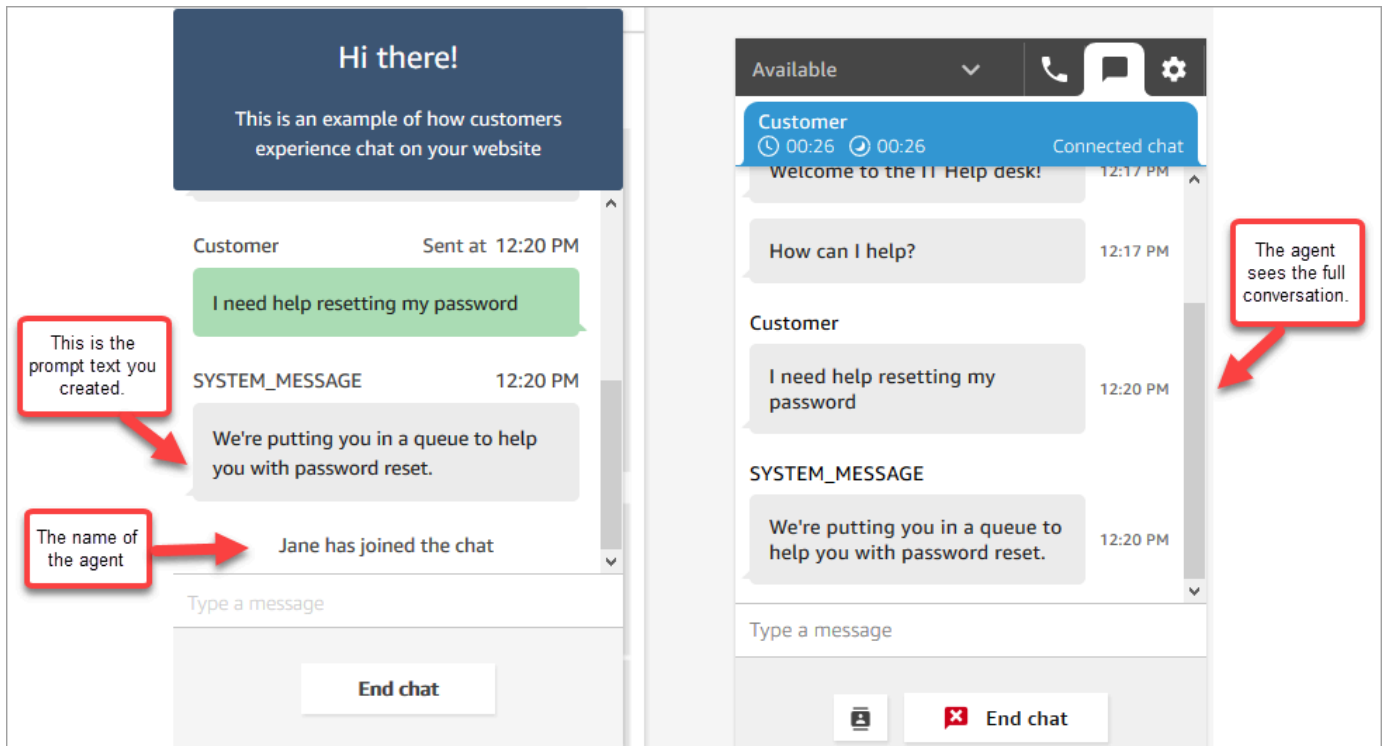

4. In the customer pane on the right, choose **End chat** to close the chat window.
5. In the test CCP, choose **Close contact** to end the After Contact Work (ACW).

Test a custom voice experience

1. If the test chat window is still open, choose **End chat** to close it. Then you can try the voice experience.
2. Call your phone number.
3. When prompted, say *I'm having trouble accessing the internet*. You should hear the message that you're being transferred to the NetworkIssue queue.

i Tip

After you're transferred, you'll hear this message:

Thank you for calling. Your call is very important to us and will be answered in the order it was received.

This message is generated by a [default flow](#) named [Default customer queue](#).

4. Switch to the test CCP and accept the incoming call.

5. After you accept the call, but before you're connected to the customer, you'll hear an inbound whisper stating what queue the contact is in, for example, NetworkIssue. This helps you know what the customer is calling about.

The inbound whisper is generated by a [default flow](#) named [Default agent whisper](#).

6. When done, end the call.
7. In the CCP, choose **Clear contact** to end After Contact Work (ACW).

Congratulations! You built and tested an omnichannel IT Help Desk that leverages Amazon Lex and offers customers both chat and voice.

Tip

If you don't want to keep the phone number that you claimed for testing, you can release it back to inventory. For instructions, see [Release a phone number from Amazon Connect back to inventory](#).

Ensure call quality: Design your contact center for low latency

Note

As of July 2023 we have simplified requirements to claim phone numbers that are located in countries outside of the AWS Region where your Amazon Connect instance is located. The process has been simplified to remove the need for the opt-in approval. Instead we provide best practice design guidance. This makes it easier for you to use an Amazon Connect instance that is created in the US-East Region, for example, and then request numbers in Japan. Or, if your instance is created in Asia Pacific (Singapore), you don't need to contact AWS Support to claim phone numbers based in Europe or US Regions. We continue to extend the support of Amazon Connect so you can claim phone numbers in the countries you need, wherever you need them.

If you are configuring your Amazon Connect instance to support phone numbers outside of your country's home AWS Region, we recommend the following best practices.

1. Anchor either your phone numbers or agents in the same AWS Region where they are geographically located. For example, if your agents are located in a US Region, your Amazon Connect instance should be created in an AWS Region in the US, too. Or, if your phone numbers are in an EU country, your Amazon Connect instance should be created in an EU AWS Region, too.
 - a. If both your phone numbers **and** agents are located in an AWS Region that is different from the one where your Amazon Connect instance is created, call latency is extended above 500ms for network latency (WebRTC RTT). This latency may result in call quality issues.
2. Calculate your latency before setting up your Amazon Connect contact center in production. Perform the following steps on a test environment:
 - a. Use the [Amazon Connect Endpoint Test Utility](#) to check latency.
 - b. Calculate the latency for routing telephony from the country to the AWS Region using internet-based, external tools, such as [WonderNetwork](#).
 - c. For calls with the best call quality, we recommend configurations with less than 500ms of latency end-to-end.
 - d. You may determine that call quality is acceptable at up to 900ms of latency for both network and telephony latency. (900ms is a sum of 500ms network latency and 400ms carrier latency.) However, if you note a call-quality issue that can be due to latency, and other potential causes are ruled out (for example, neither packet loss nor jitter are detected), we recommend configuring your Amazon Connect instance or telephony for a lower latency. For example, create your Amazon Connect instance in the same Region as your telephony or agents.

 **Important**

When call latency is greater than 900ms for both network and telephony latency, it leads to a significant delay between agents and customers.

3. Check that latency matches your design.

After you claim a number you can immediately call it to hear what the experience will be like for your customers. Amazon Connect uses the [default flows](#) to power your initial experience.

To test a customized flow, [assign a phone number](#) to it and then call that number.

Architectural guidance for Amazon Connect

This topic provides guidance and best practices for designing and building reliable, secure, efficient, and cost-effective systems for your Amazon Connect contact center workloads. Using this guidance can help you build stable and efficient workloads, allowing you to focus on innovation, reduce costs, and improve your customer's experience.

This content is intended for chief technology officers (CTOs), architects, developers, and operations team members.

Contents

- [Amazon Connect workload layers](#)
- [Scenario and deployment approaches](#)
- [Operational Excellence](#)
- [Security: Design principles for developing a secure contact center](#)
- [Reliability](#)
- [Performance efficiency](#)
- [Cost optimization](#)

Amazon Connect workload layers

You can separate Amazon Connect workloads into the following layers: telephony, Amazon Connect interface/API, flows/IVR, agent workstation, and metric and reporting.

Telephony

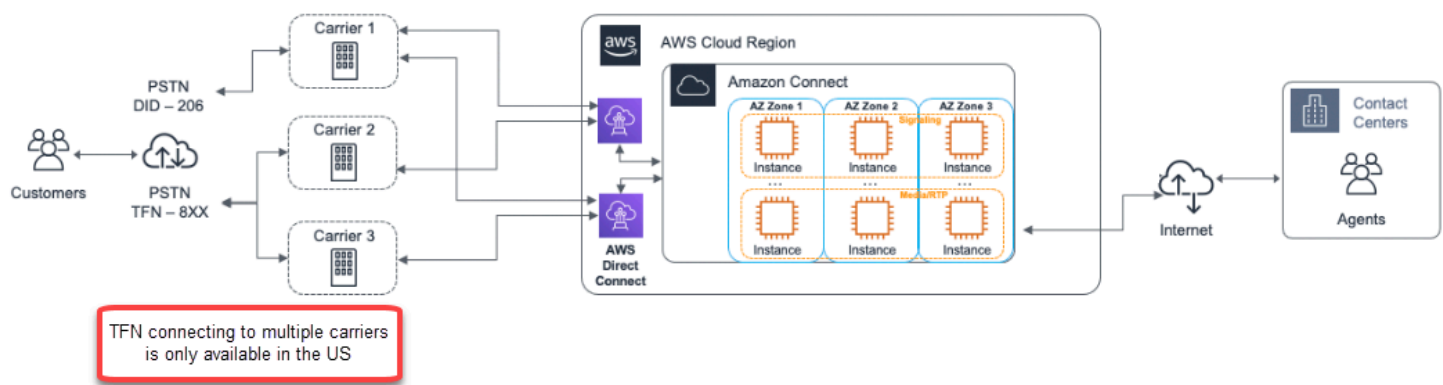

⚠ Important

TFN connecting to multiple carriers is only available in the US.

Amazon Connect is integrated with multiple telephony providers with redundant dedicated network paths to three or more Availability Zones in every Region where the service is offered today. Capacity, platform resiliency, and scaling are handled as part of the managed service, allowing you to efficiently ramp from 10 to 10,000+ agents without worrying about the management or configuration of underlying platform and telephony infrastructure. Workloads are load balanced across a fleet of telephony media servers, allowing new updates and features to be delivered to you with no downtime required for maintenance or upgrades. If a particular component, data center, or an entire Availability Zone experiences failure, the affected endpoint is taken out of rotation, allowing you to continue to provide a consistent quality experience for your customers.

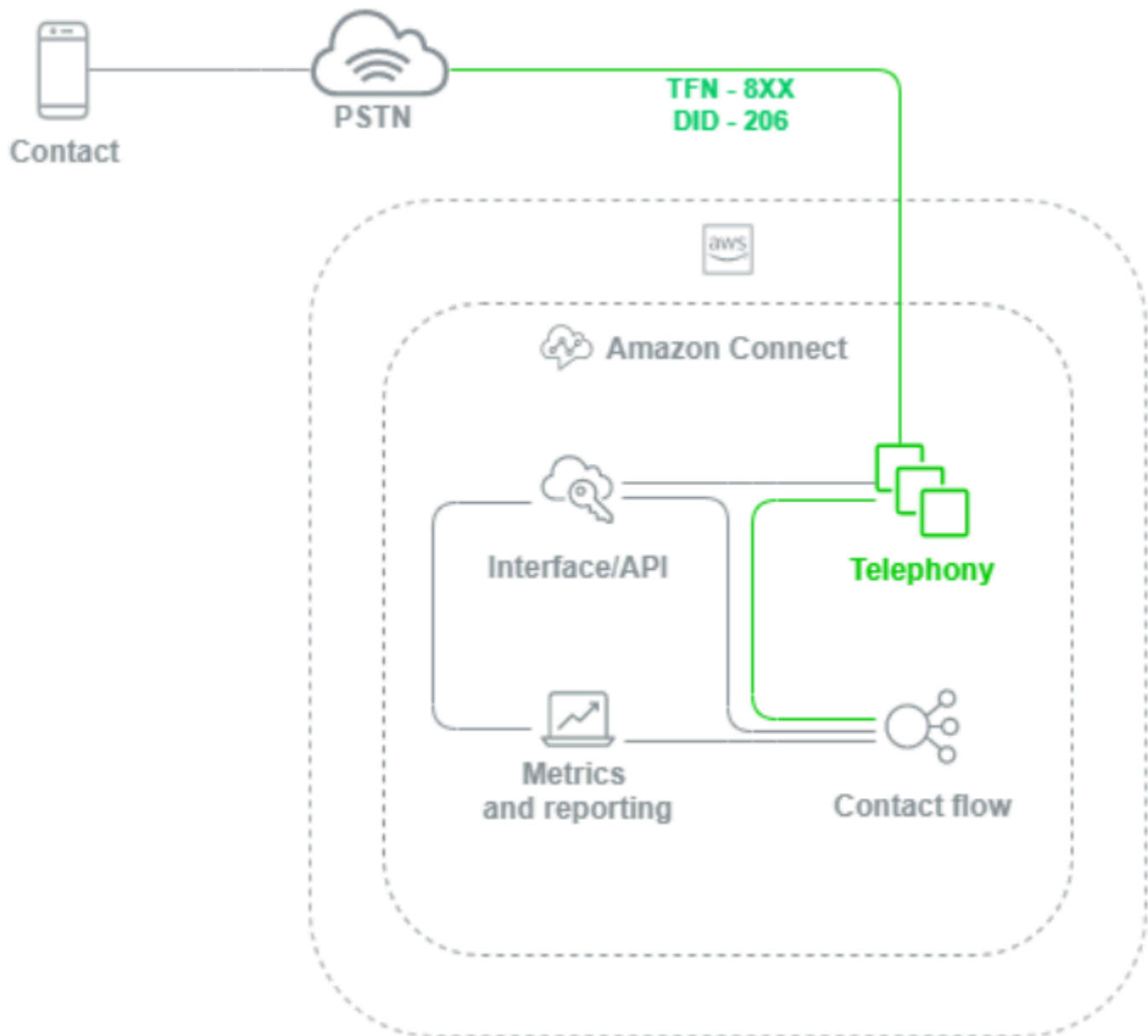

When a voice call is placed to an Amazon Connect instance, the telephony layer is responsible for controlling the endpoint that your customer calls into through their carrier, across the PSTN and into Amazon Connect. This layer represents the audio path established between Amazon Connect and the customer. Through the Amazon Connect interface layer, you can configure things like outbound caller ID, assign flow/IVRs to phone numbers, enable live media streaming, enable call recording, and the ability to claim phone numbers without any prior traditional telephony knowledge or experience. Additionally, when migrating workloads to Amazon Connect, you have the option to port your existing phone numbers by opening a support case in your AWS Management Console. You can also forward your existing phone numbers to numbers that you've claimed in your Amazon Connect instance until you are fully migrated.

Amazon Connect Interface/API

The Amazon Connect interface layer is the access point that your agents and contact center supervisors and administrators will use to access Amazon Connect components like reporting and metrics, user configuration, call recordings, and the Contact Control Panel (CCP). This is also the layer responsible for:

- Single Sign-On (SSO) integration user authentication
- Custom desktop applications created using the [Amazon Connect Streams](#) API that may provide additional functionality and/or integrate with existing Customer Relationship Management (CRM) systems including the [Amazon Connect Salesforce CTI Adapter](#).
- Amazon Connect contact-facing chat interface
- Chat web server hosting the Amazon Connect Chat API
- Any Amazon API Gateway endpoints and corresponding AWS Lambda functions necessary to route chat contacts to Amazon Connect.

Anything your agents, managers, supervisors, or contacts use to access, configure, or manage Amazon Connect components from a web browser or API is considered the Amazon Connect interface layer.

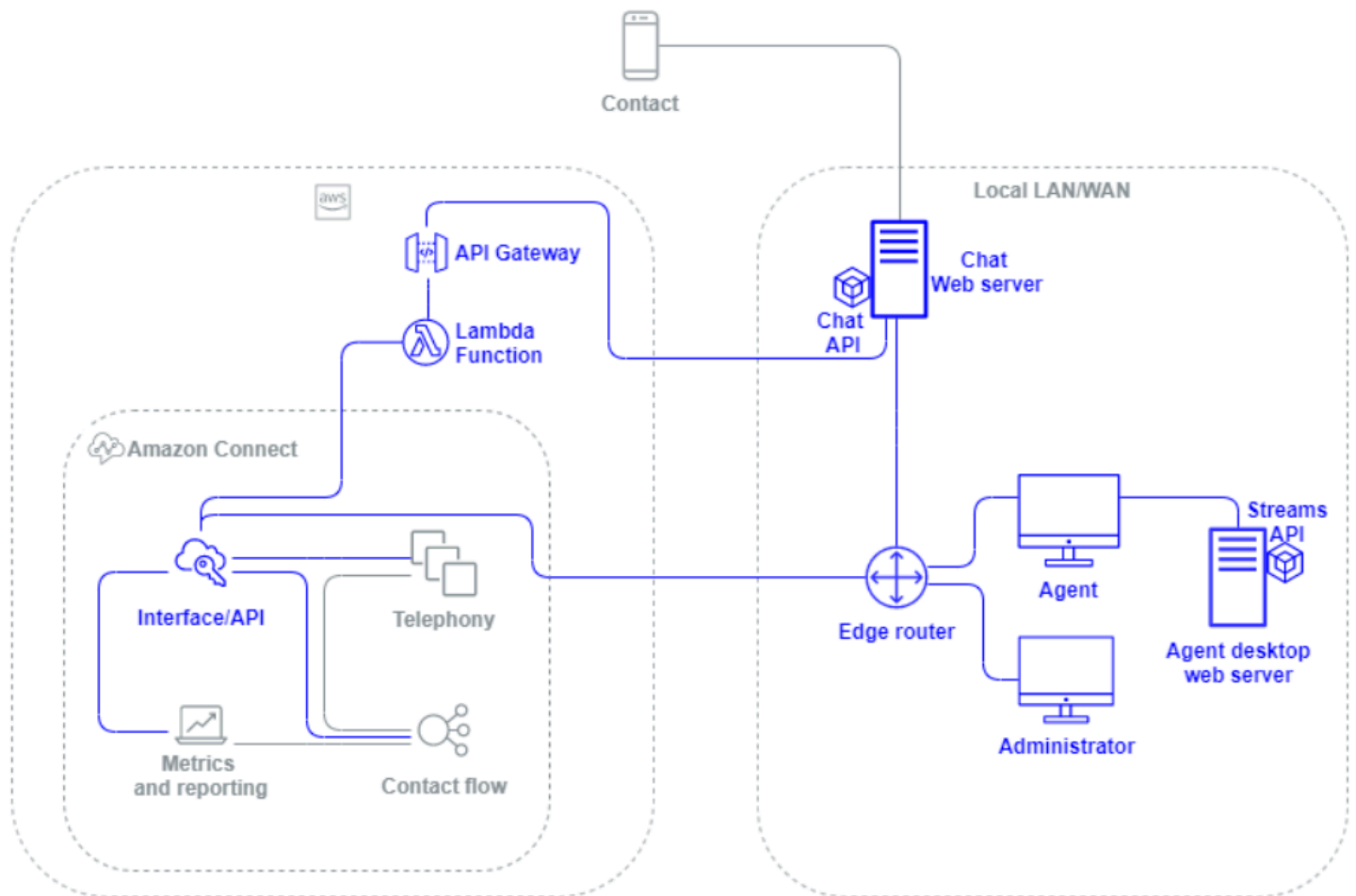

Flow / IVR

The Flow/IVR layer is the primary architectural vehicle for Amazon Connect and serves as the point of entry and first line of communication with customers reaching out to your contact center. After a customer contacts your Amazon Connect instance, a flow controls the interaction between Amazon Connect, the contact, and the agent, allowing you to:

- Dynamically invoke AWS Lambda functions to make API calls.
- Send real-time IVR and voice data to third-party endpoints through Amazon Kinesis.
- Access resources inside your VPC and behind your VPN.
- Call other AWS services like Amazon Pinpoint to send SMS messages from the IVR.
- Perform data dips to database like Amazon DynamoDB to service your contacts.
- Call Amazon Lex directly from the flow to invoke a Lex bot for Natural Language Understanding (NLU) and Automatic Speech Recognition (ASR).

- Play dynamic and natural Text-to-Speech through Amazon Polly, and use SSML and Neural Text-to-Speech (NTTS) to achieve the most natural and human-like text-to-speech voices possible.

Flows enable you to dynamically prompt contacts, collect and store contact attributes, and route appropriately. You can assign a flow to multiple phone numbers, and manage and configure it through Amazon Connect.

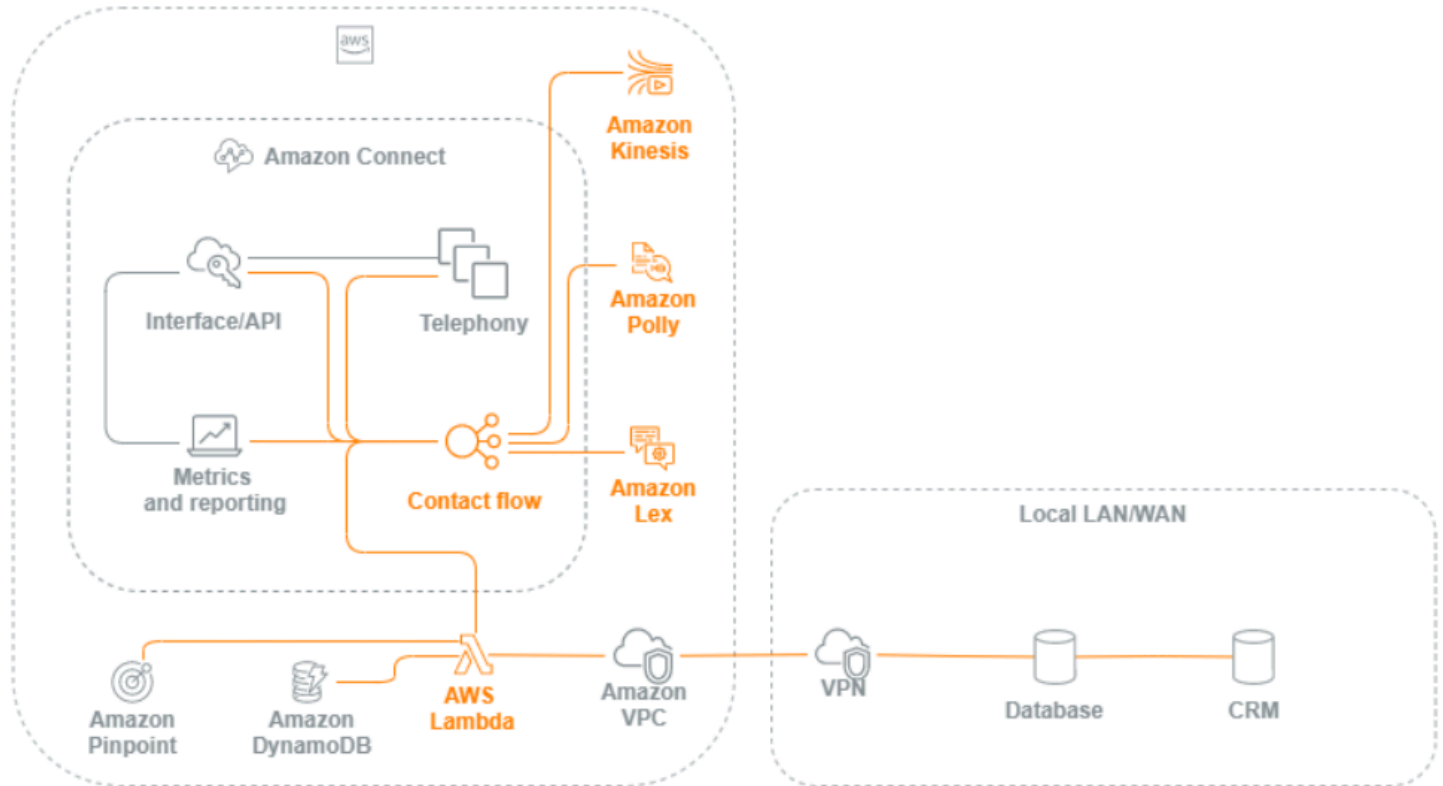

Agent workstation

The agent workstation layer is not managed by AWS. It consists of any physical equipment and third-party technologies, services, and endpoints that facilitate your agent's voice, data, and access the Amazon Connect interface layer. Components in the agent workstation layer include:

- The Contact Control Panel (CCP) agent hardware
- Network path
- Agent headset or handset
- VDI environment
- Operating system and web browser
- Endpoint security

- All networking components and infrastructure
- Internet Service Provider (ISP) or AWS Direct Connect dedicated network path to AWS.
- All other aspects of your agent's operating environment including power, facilities, security, and ambient noise.

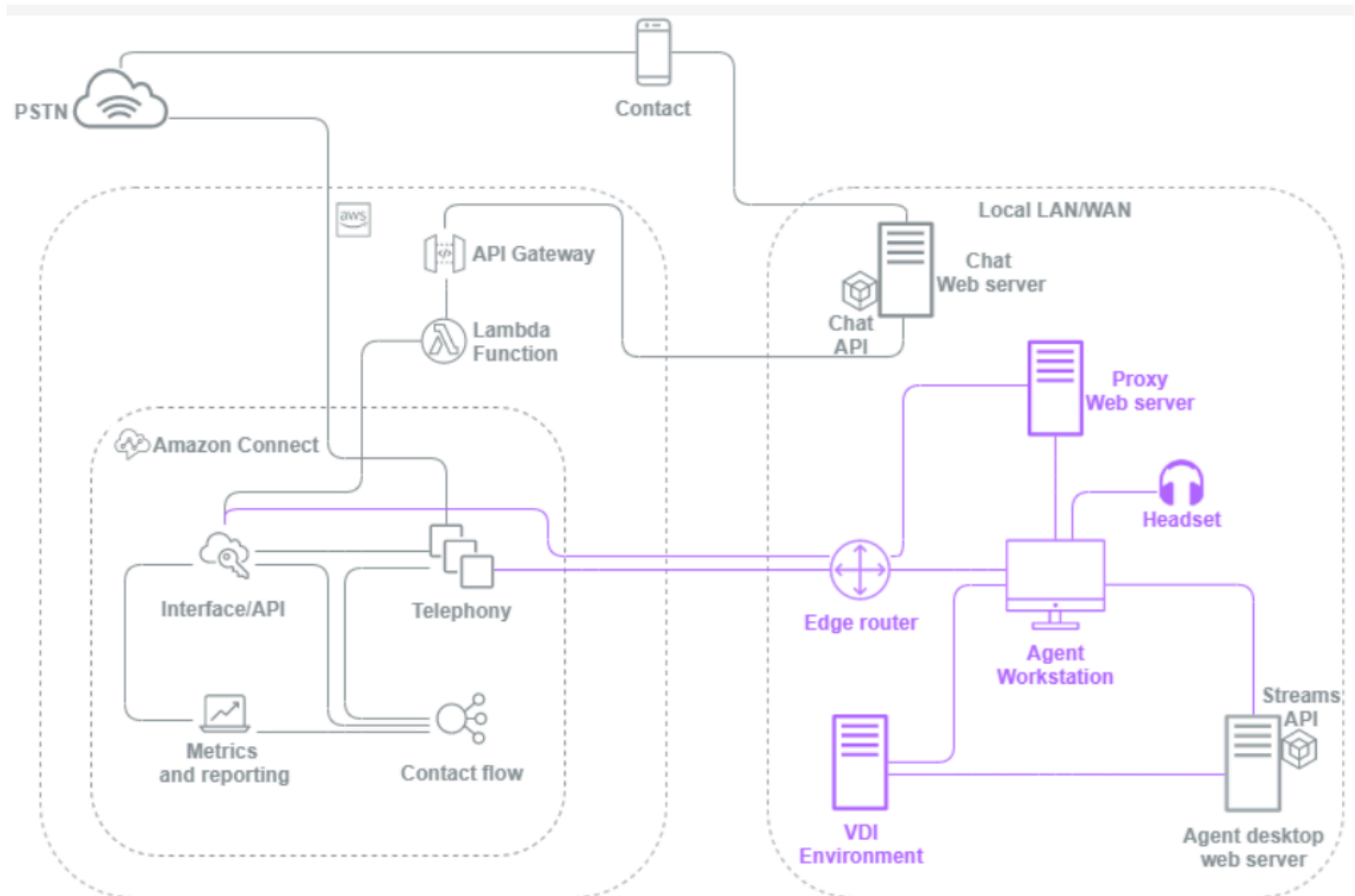

Metric and reporting

The metric and reporting layer includes the components responsible for delivering, consuming, monitoring, alerting, or processing real-time and historical metrics for your agents, contacts, and contact center. This includes all native and third-party components responsible for facilitating the processing, transmission, storage, retrieval, and visualization of real-time or historical contact center metrics, activity audit, and monitoring data. For example:

- Call recordings and scheduled reports stored in Amazon Simple Storage Service (Amazon S3).

- Contact records that you can export to AWS database services like Amazon Redshift or your own on-premises data warehouse with Amazon Kinesis.
- Real-time dashboards you create with Amazon OpenSearch Service and Kibana.
- Amazon CloudWatch metrics generated that you can use to set alarms based on static thresholds, set up Amazon SNS notifications to alert to your administrators and supervisors, or launch AWS Lambda functions in response to the event.

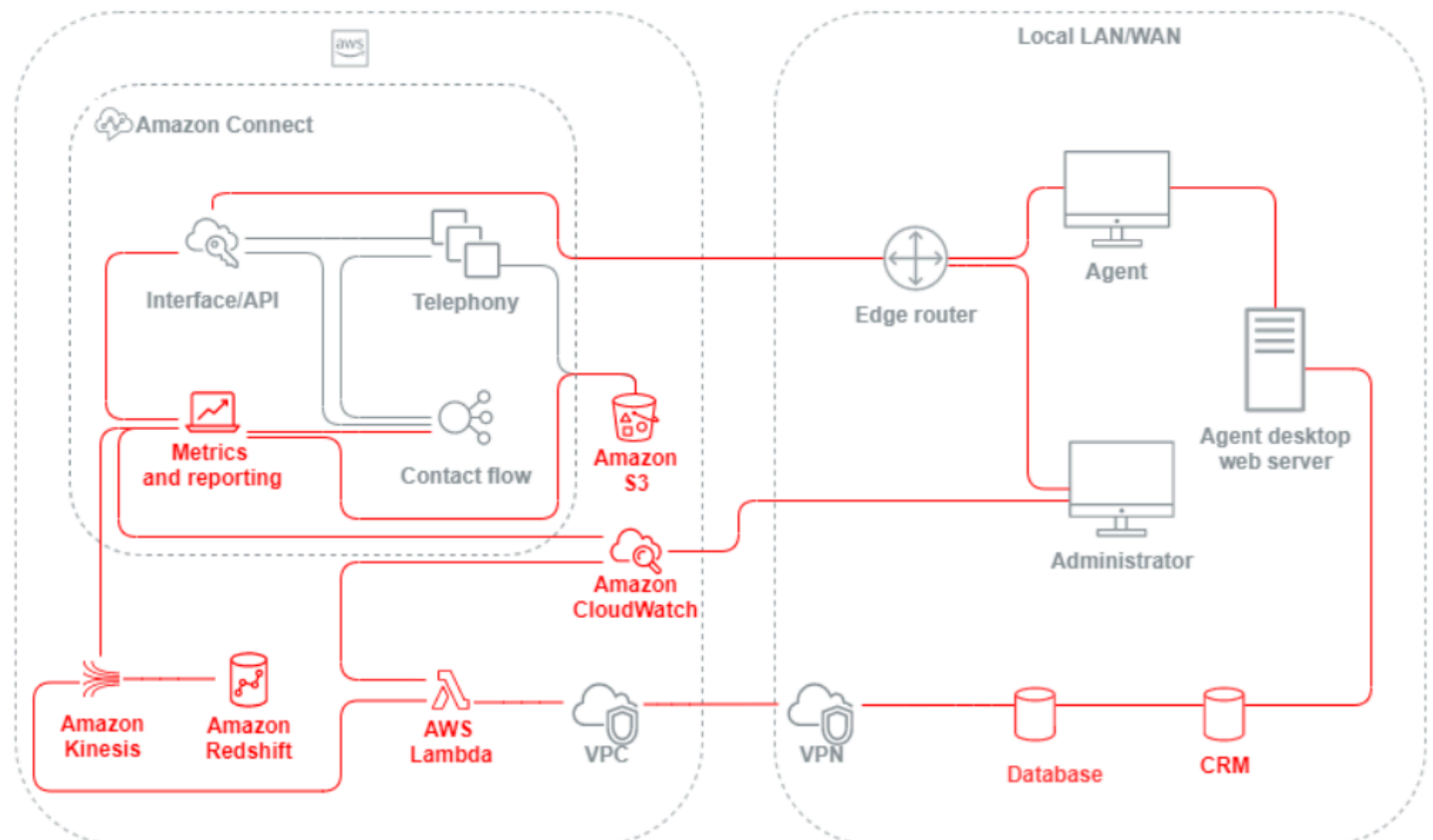

Scenario and deployment approaches

Amazon Connect offers self-service configuration and enables dynamic, personal, and natural customer engagement at any scale with a variety of migration and integration options. In this section, we explain the following scenarios and deployment approaches to consider when designing a workload for Amazon Connect:

- Traditional contact center
- Inbound
- Outbound

- Hybrid contact center
- Legacy contact center migration
- Virtual desktop infrastructure (VDI)

Traditional contact center

The traditional contact center requires a significant telephony, media, networking, database, and compute infrastructure footprint that can span multiple vendors and data center locations to service contacts. Each individual solution and vendor have unique hardware, software, networking, and architectural requirements that have to be met while resolving versioning, compatibility, and licensing conflicts.

It is common to have separate vendors and infrastructure requirements for local and remote agent hardware and VPN connectivity, Text-To-Speech (TTS), Automatic Call Distribution (ACD), Interactive Voice Response (IVR), voice audio and data, physical desk phones, voice recording, voice transcriptions, chat, reporting, database, Computer Telephony Integration (CTI), Automatic Speech Recognition (ASR), and Natural Language Understanding (NLP). Your contact center architecture and infrastructure becomes more complicated when you consider multi-stage development, quality assurance, and test environments.

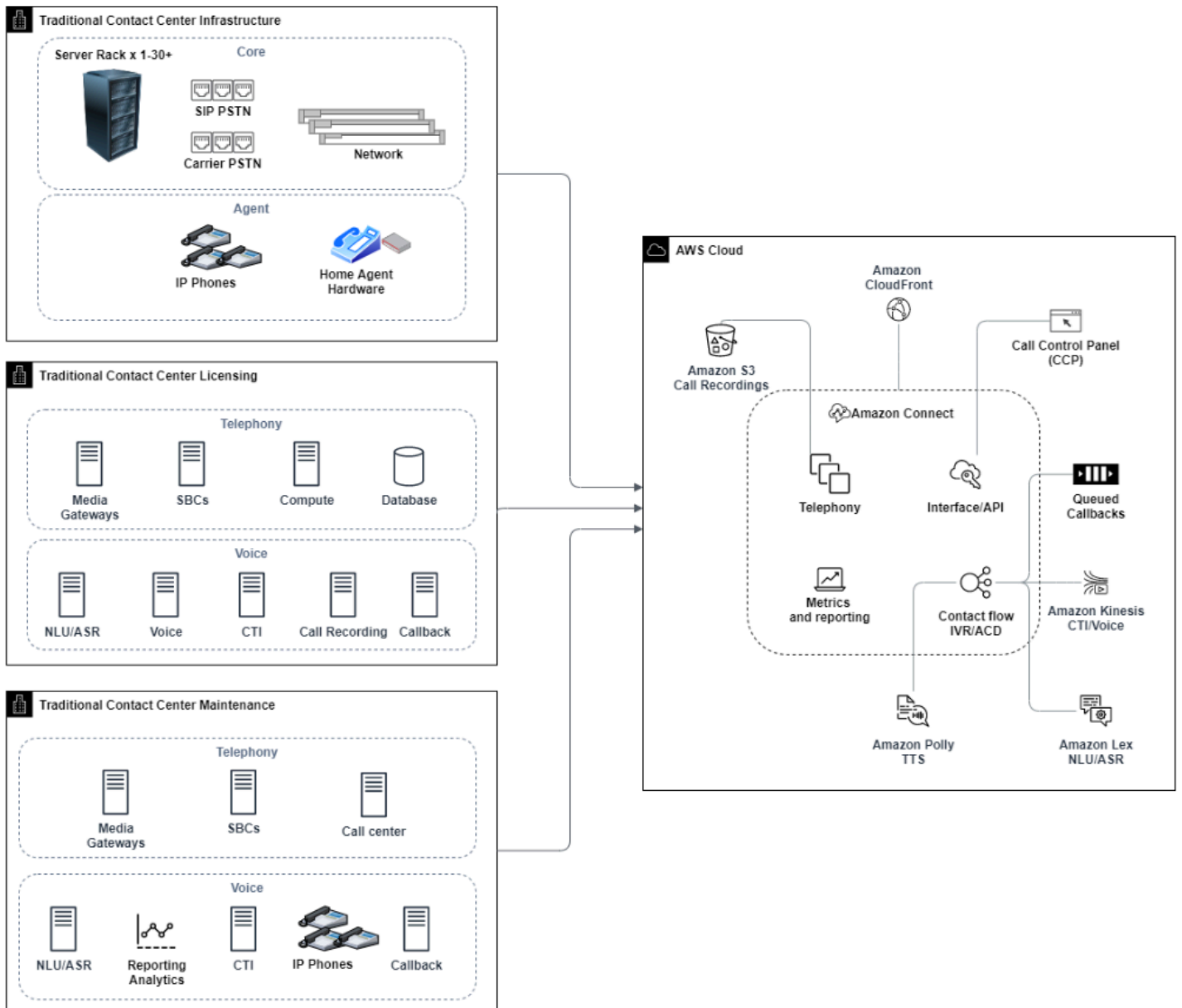

A typical Amazon Connect deployment solves or reduces many of the challenges associated with versioning, compatibility, licensing, contact center telephony infrastructure, and maintenance. It gives you the flexibility to create instances in new locations in minutes and migrate components individually, or in parallel, to best meet your individual business objectives. You can use flows for your IVR/ACD, have voice and data delivered through a supported web browser to your agent’s softphone, port your existing phone numbers, redirect softphone audio to an existing desk phone, invoke an Amazon Lex bot natively within your flow for ASR and NLP, and use the same flow for chat and voice. You can use Amazon Contact Lens to automatically generate voice transcriptions, perform key word identification and sentiment analysis, and categorize contacts. For agent CTI

data and real-time voice streaming, you can use Amazon Connect Agent Event Streams and Kinesis Video Streams. You can also create multi-stage development, quality assurance, and test environments at no additional cost and only pay for what you use.

Inbound

Inbound is a contact center term used to describe a communication request initiated by a contact to the center. Contacts can reach your Amazon Connect instance for inbound self-service or to speak with a live agent in a variety of ways, including voice and chat. Voice contacts go through the PSTN and are routed to the Amazon Connect Instance telephony entry point through the phone number claimed in your instance. You can reserve a phone number with Amazon Connect directly, port your existing phone number, or forward voice contacts to Amazon Connect. Amazon Connect can provide local and toll-free numbers in all Regions where the service is supported.

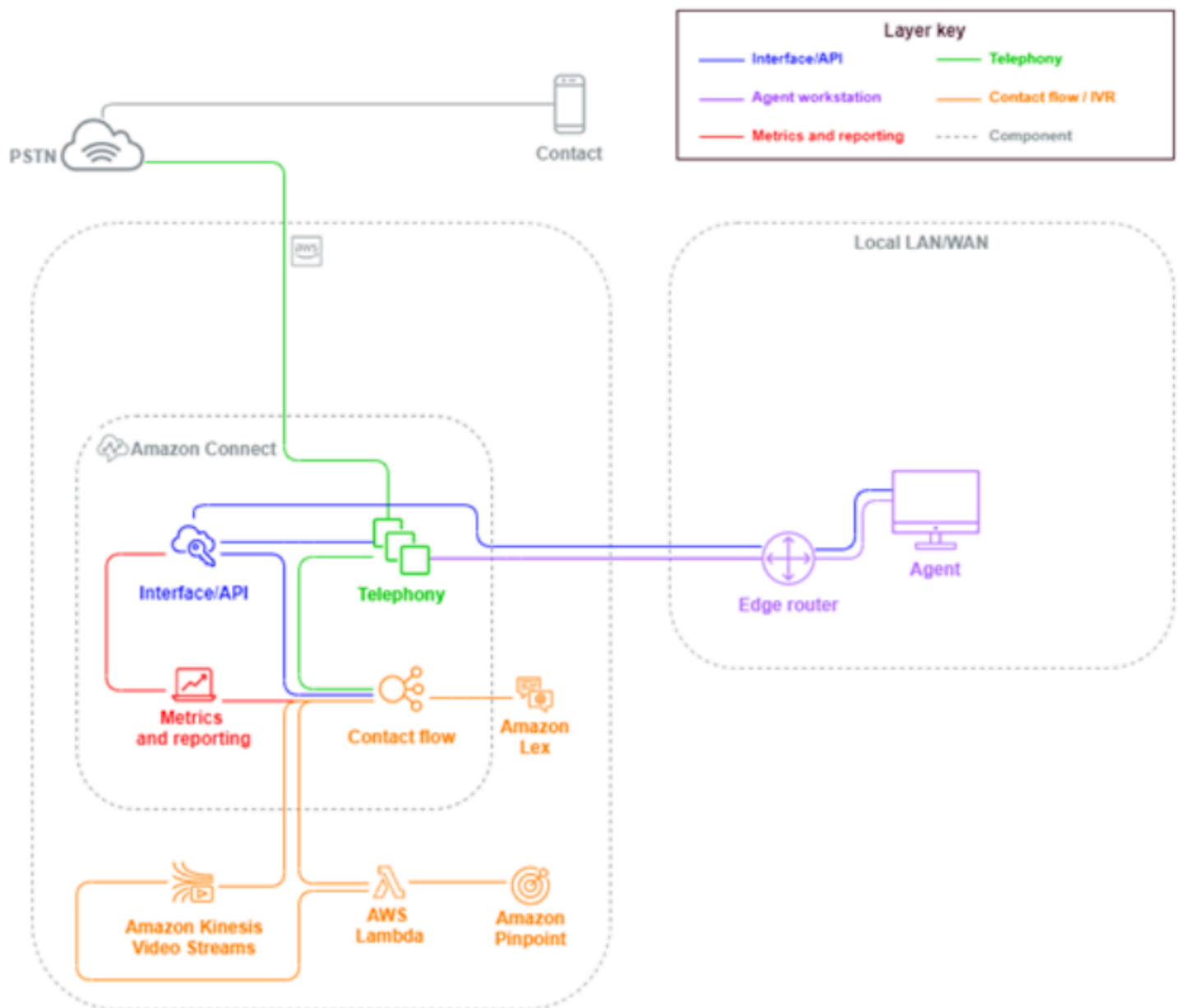

When a phone call is placed to a number claimed in or ported to your Amazon Connect instance, the flow associated with the called number will be invoked. You can define the flow using flow blocks that can be configured with no coding knowledge required. The flow determines how the contact should be processed and routed, optionally prompting the contact for additional information to assist in routing decisions, storing those attributes to the contact details, and, if necessary, routing that contact to an agent with all of the call details and transcripts gathered along the way. Through the flow, you can invoke AWS Lambda functions to query customer information, call other AWS services like Amazon Pinpoint to send SMS text messages, and use native AWS service integrations including Amazon Lex for NLU/NLP and Kinesis Video Streams for real-time streaming of voice calls.

If an inbound contact needs to reach an agent, the contact is put into a queue and routed to an agent when they change their status to Available, according to your routing configuration. When the available agent's contact is accepted manually or through auto-accept configuration, Amazon Connect connects the contact with the agent.

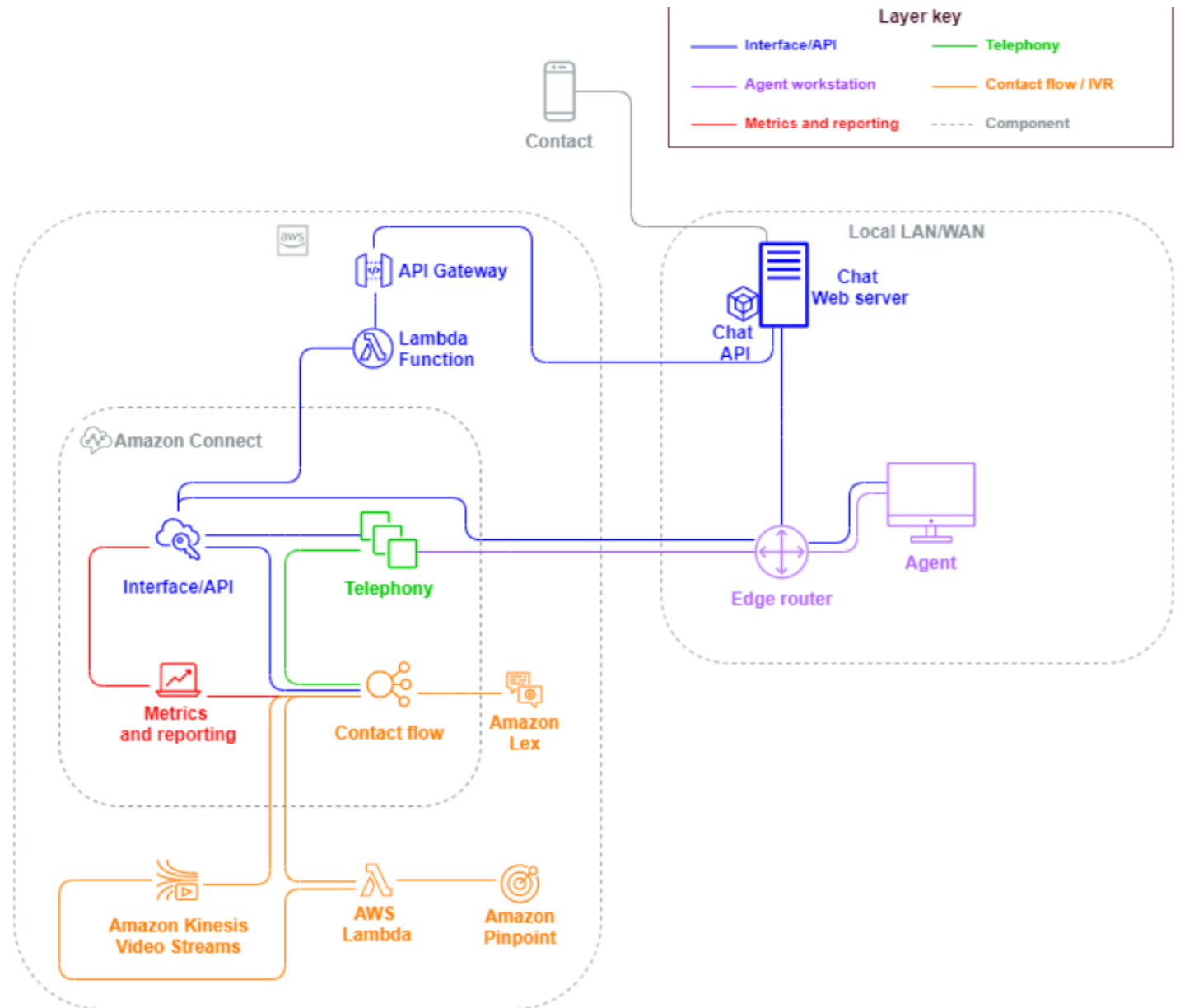

When an inbound contact comes from a browser or mobile app request for a chat session, the request is routed to a web service or Amazon API Gateway endpoint that calls the Amazon Connect chat API to invoke the flow configured in your request. You can use the same flows for chat and voice, where the experience is managed and routed dynamically, based on the logic defined in the flow.

Outbound

Amazon Connect allows you the ability to programmatically make outbound contact attempts to local and international endpoints, reduce agent set-up time between contacts, and improve agent productivity. By using the [Amazon Connect Streams](#) API and [StartOutboundVoiceContact](#), you can develop your own outbound solution or take advantage of existing partner integrations that work with your CRM data to create dynamic, personalized experiences for your contacts and empowering your agents with the tools and resources they need to service those contacts.

Outbound campaigns are typically driven by contact data exported from CRMs and separated into contact lists. Those contacts are prioritized and either delivered to the agents to initiate after a period of preview or programmatically contacted using the Amazon Connect Outbound API, driven by your flow logic, and connecting to agents as needed. Typical outbound contact center use cases include fraud and service alerts, collections, and appointment confirmations.

Hybrid

If you have requirements to transfer contacts between Amazon Connect and legacy contact center technologies, you can use a Hybrid model architecture to pass contact data with the transfer. For example, a sales business unit on a legacy contact center platform may need to transfer a call to the service business unit that's been migrated to Amazon Connect. Without a Hybrid architecture, call details will be lost and may require the contact to repeat information. This could increase handle times and may result in contact calling again for the same purpose.

Hybrid architectures require you to claim as many phone numbers as your expected maximum concurrent contacts and an intermediary state database accessible by both Amazon Connect and your legacy contact center platform. When a transfer is required to the other platform, you will use one of these phone numbers as a unique identifier, flag it as in-use in your intermediary database, insert your contact details, and use that number as your ANI or DNIS when you transfer the contact. When the contact is received by the other contact center platform, you will query the intermediary database for the contact details based on the unique ANI or DNIS you used. Hybrid architectures are typically used as an interim migration step because of the additional cost and complexity associated.

IVR-only

You may choose to use Amazon Connect to drive the contact's IVR experience while your agent population remains on your legacy contact center platform. With this approach, you can use

Amazon Connect flows to drive self-service and routing logic, and, if necessary, transfer the contact to the target agent or agent queue on your legacy contact center platform.

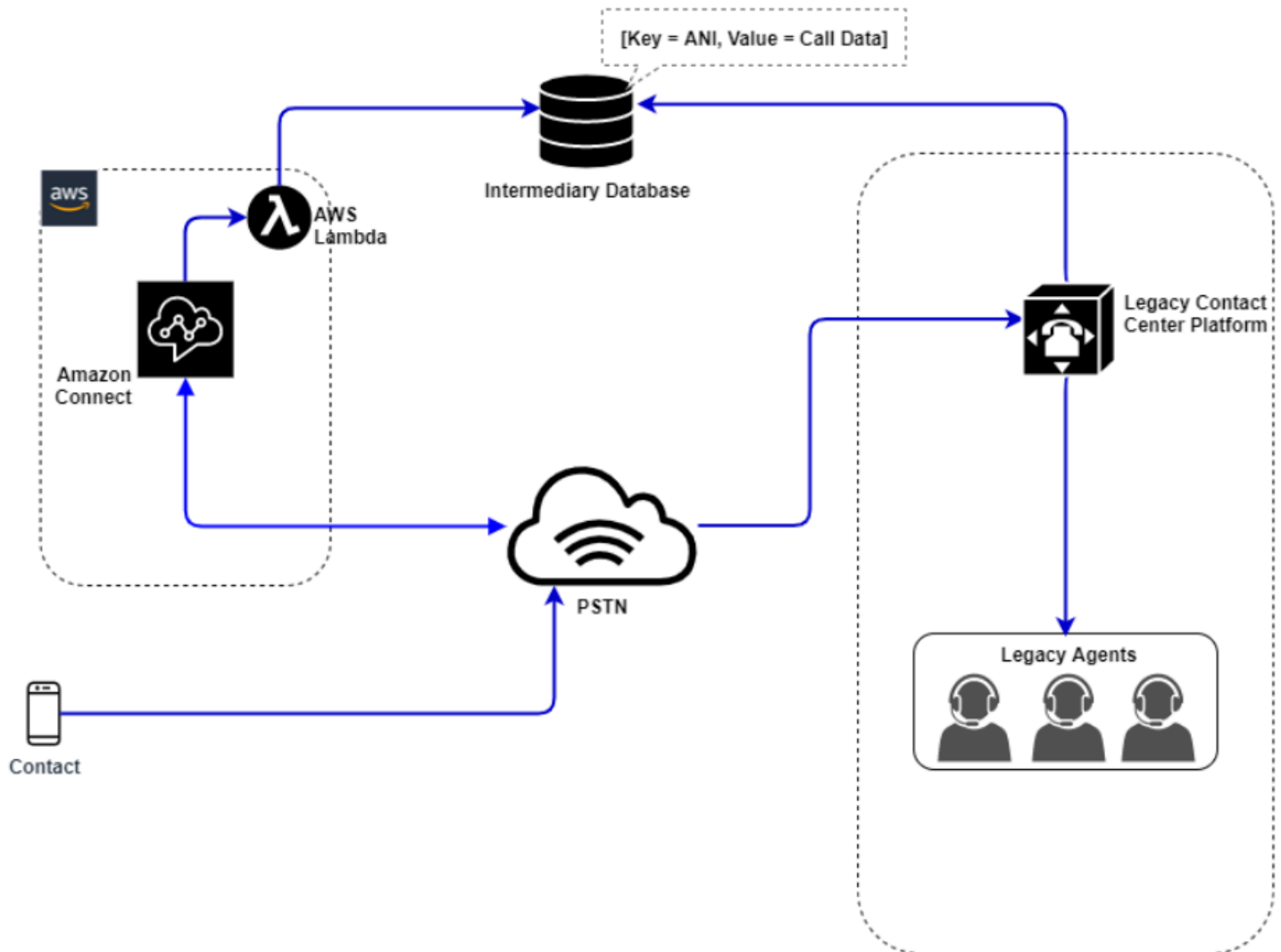

In this diagram, the contact dials a phone number claimed in your Amazon Connect instance for service. If they need to be transferred to an agent on your legacy contact center platform, an AWS Lambda function is invoked to query an available unique phone number, flag it as in-use, and write relevant contact details to an intermediary database. The contact is then transferred to the legacy contact center platform with the phone number returned from the Lambda function. The legacy contact center will then perform a query on the intermediary database for the contact details, route accordingly, and reset the contact data in the intermediary database, allowing the phone number to be used again.

Agent-only

With this approach, your legacy contact center IVR drives the contact's IVR self-serve and routing logic, and, if necessary, transfers the contact to Amazon Connect to route to your agent population.

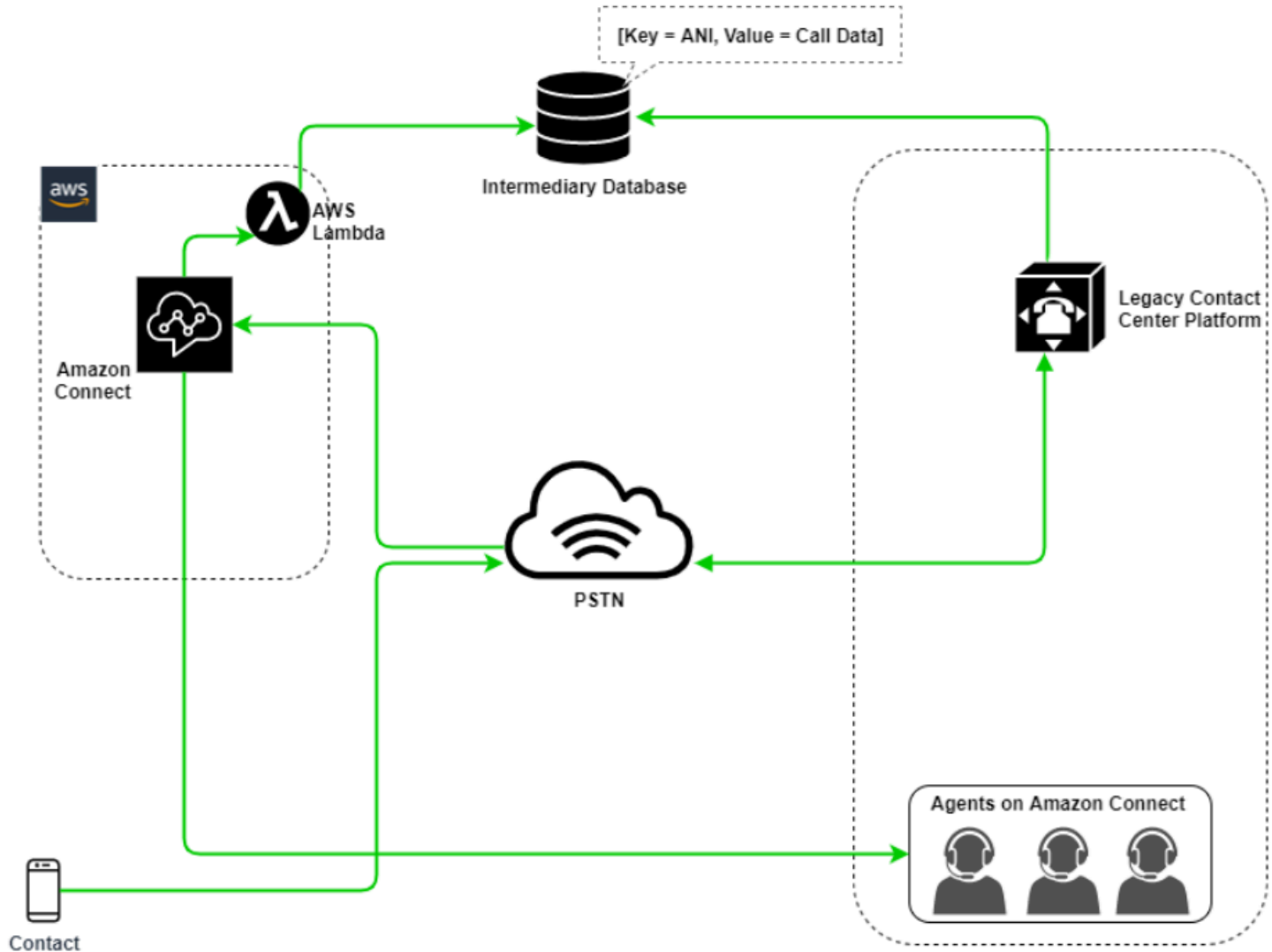

In this diagram, the contact dials a phone number claimed with your legacy contact center platform. If they need to be transferred to an agent on Amazon Connect, the legacy contact center platform will query an available unique phone number, flag it as in-use, and write relevant contact details to an intermediary database. The contact will then be transferred to Amazon Connect with the phone number returned by the legacy contact center's query. Amazon Connect will then query the contact details from the intermediary database using AWS Lambda, route accordingly, and reset the contact data in the intermediary database, allowing the phone number to be used again.

Mixed

In this scenario, you may have your IVR and agents operating in parallel on Amazon Connect and your legacy contact center platform to allow for site, agent group, or line-of-business migrations.

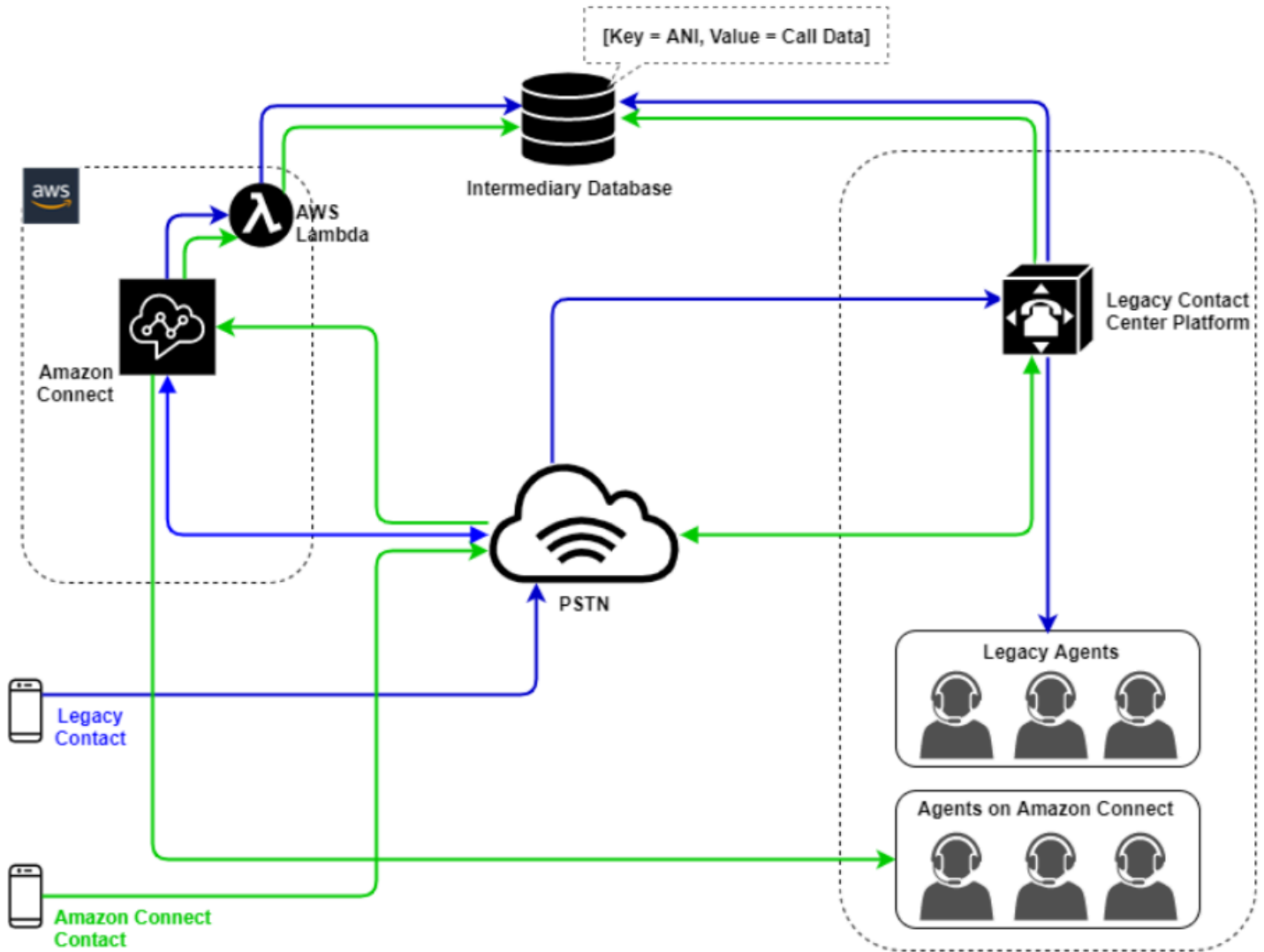

Legacy contact center migration

When you are evaluating Amazon Connect for new or existing workloads, there are several strategies you can consider. For situations that require contact details to be included when contacts are transferred between Amazon Connect and your legacy contact center solution, a Hybrid model architecture will be required until the migration is complete. The approaches described in this section allow you to move specific lines of business in phases, manage training and support, and mitigate risks associated with change.

New workload

You may decrease risk associated with changes to existing business units and increase flexibility and digital innovation potential by adopting a net new workload on Amazon Connect. Net new workloads that do not require the Hybrid model architecture are less complex, are not affected by change in business process or agent routine, and have a faster time to market. Adopting a net new workload allows you to take advantage of usage-based, pay-as-you-go pricing. Your contact center resources are available to create a new experience for their end users, test and implement it to evaluate the platform, gain confidence, and build the skills and operational mechanisms to prepare for larger migration across existing workloads.

IVR First

You may choose to use Amazon Connect to drive the contact's IVR experience while your agent population remains on your legacy contact center platform. With this approach, you can use Amazon Connect Flows to drive self-service and routing logic, and, if necessary, transfer the contact to the target agent or agent queue on your legacy contact center platform.

IVR Last

With this approach, your legacy contact center IVR drives the contact's IVR self-serve and routing logic, and, if necessary, transfers the contact to Amazon Connect to route to your agent population.

Line of business segmentation

If your lines of business have separate IVRs or don't require contact transfers to legacy contact center platforms, you may want to consider a line of business migration approach. For example, selecting your service desk for internal support as your first line of business to migrate. After migrating your service desk IVR and agent population to Amazon Connect, you may choose to forward your existing contact to Amazon Connect, porting the endpoint after testing and business validation is completed.

Site or agent group segmentation

If your contact center has a global footprint, services contacts from multiple countries, or is managed independently by a respective geography or location, you may want to consider a migration approach based on a physical site or geography of agents. Each agent population and/or geography can have its own unique requirements and considerations that may not apply globally.

Approaching your migration this way will allow each site or agent group to gain the skills they need to continue to operate independently before moving onto the next.

Virtual desktop infrastructure (VDI)

While you can use the Amazon Connect Contact Control Panel (CCP) within Virtual Desktop Infrastructure (VDI) environments, it will add another layer of complexity to your solution that warrants separate POC efforts and performance testing to optimize. The configuration/support/optimization is best handled by your VDI support team and the following deployment models are the most commonly implemented.

VDI client with local browser access

You can build a custom CCP with the [Amazon Connect Streams](#) API by creating a CCP with no media for call signaling. This way, the media is handled on the local desktop using standard CCP, and the signaling and call controls are handled on the remote connection with the CCP with no media. The following diagram describes that approach:

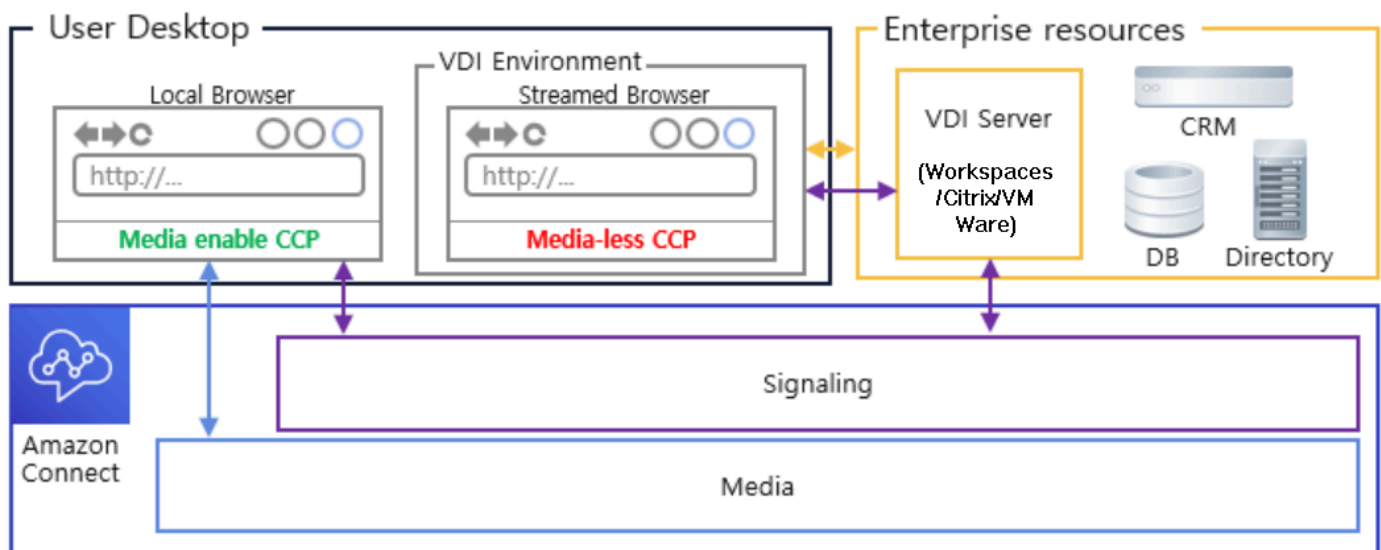

Citrix VDI with Amazon Connect audio optimization

If you use Citrix Virtual Desktop Infrastructure (VDI) environment, you can build a custom CCP with the Amazon Connect RTC JavaScript library which integrates with Citrix United Communications SDK (ucsdk) and automatically redirects the media from your local desktop to Amazon Connect. This enables your agents to use Citrix VDI client applications, such as Citrix Workspaces, to connect to their custom agent applications or custom CCPs. This removes the need to develop and

manage a separate agent application, like dual-CCPs, for audio media redirection for their Citrix environments. The following diagram describes that approach:

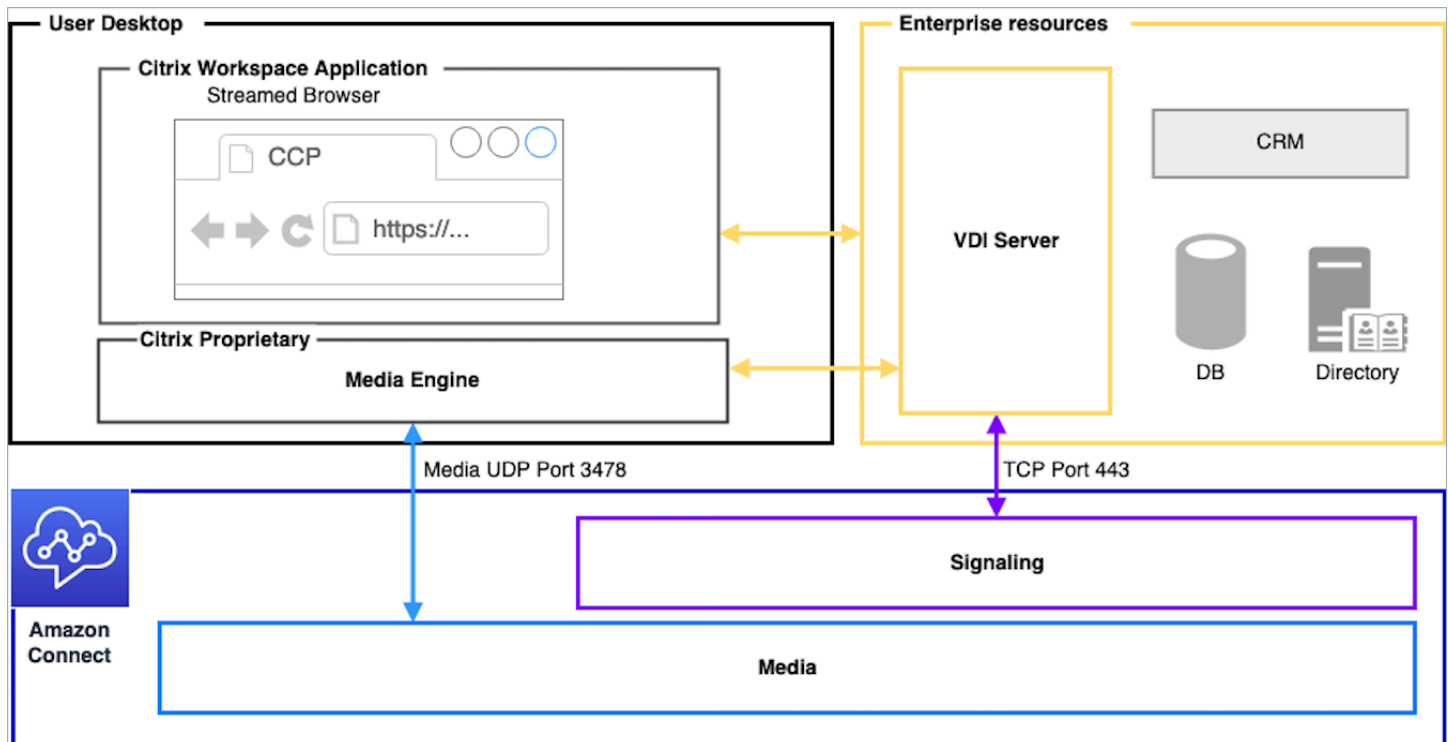

Note

This solution requires you to allow WebRTC signaling traffic between your VDI server and Amazon Connect, and the media connection between the agent's desktop and Amazon Connect. For more information, see the [Set up your network](#) documentation.

VDI client without local browser access

Sometimes the VDI client does not have access to a local browser. In this scenario, you can create a single CCP instance with media run from the VDI server allowing access to enterprise resources. For this deployment model UDP audio is usually enabled on the VDI OS. This deployment model requires extensive testing to calibrate the different VDI server parameters to optimize quality of experience:

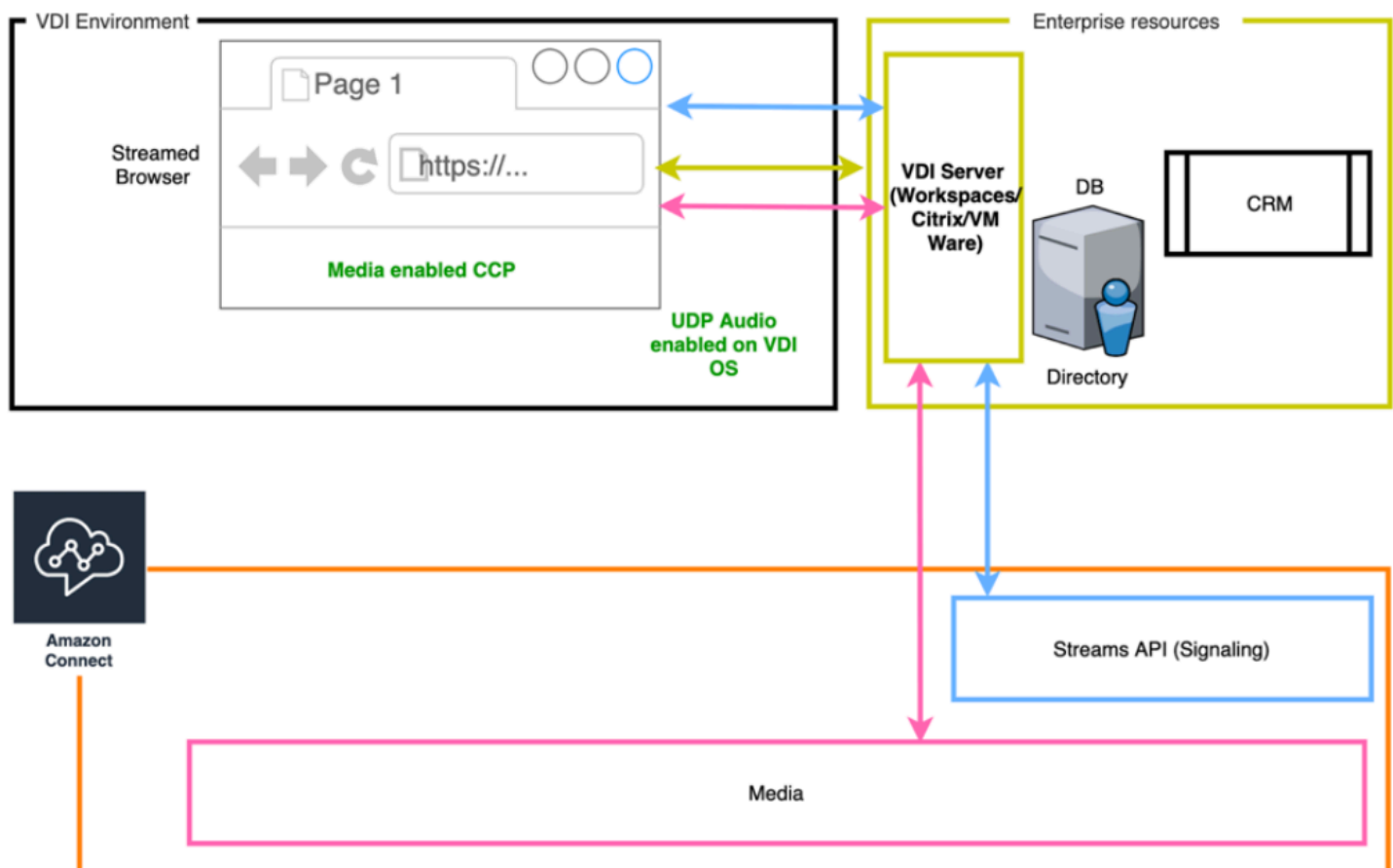

Operational Excellence

Operational excellence includes the ability to run and monitor systems to deliver business value and continually improve supporting processes and procedures. This section consists of design principles, best practices, and questions surrounding the operational excellence of Amazon Connect workloads.

Prepare

Consider the following areas to prepare for an Amazon Connect workload.

AWS account

With AWS Organizations, you can set up multiple AWS accounts for each level of your development, staging, and quality assurance environments. This allows you to centrally govern your environment as you grow and scale your workloads on AWS. Whether you are a growing startup or a large enterprise, Organizations helps you to centrally manage billing; control access,

compliance, and security; and share resources across your AWS accounts. This is the starting point for consuming AWS services along with a cloud adoption framework.

Region selection

Amazon Connect Region selection is contingent upon data governance requirements, use case, services available in each Region, telephony costs in each region, and latency in relation to your agents, contacts, and external transfer endpoint geography.

Telephony

- **Phone number porting** Open a porting request as far in advance of your pending go-live date as possible.

When porting phone numbers for critical workloads, include all requirements and use case information in your claim/port number several months before the go-live date. This includes requests for live cutover support, communication prior, during, and after cutover, monitoring, and anything else specific to your use case.

For detailed information about porting your numbers, see [Port your current phone number to Amazon Connect](#).

- **Carrier diversity** In the US, you should use Amazon Connect telephony services for US toll-free numbers, allowing you to route toll-free traffic across multiple suppliers in an active-active fashion at no additional charge. In situations where you are forwarding inbound traffic to an Amazon Connect phone number, you should request redundant DID or Toll-Free numbers across multiple telephony providers. If you are claiming or porting multiple DID or Toll-Free numbers outside of the US, you should request that those numbers be claimed or ported to a variety of telephony providers for increased resiliency.
- **International toll-free and high-concurrency DIDs** If you are using an existing toll-free national service to redirect inbound traffic to DIDs, you should request DID phone numbers across multiple telephony providers. A general recommendation for this configuration is 100 sessions per-DID and your AWS Solutions Architect can help with capacity calculations and setup.
- **Testing** Thoroughly test all use case scenarios, preferably using the same or similar environment as your agents and customers. Ensure that you test several inbound and outbound scenarios for quality of experience, Caller ID functionality, and measure latency to ensure it falls within acceptable range for your use case. Any deviations from your target agent and customer environments need to be measured and accounted for. For more information, including use case

testing instructions and criteria, see [Troubleshooting Issues when using the Contact Control Panel \(CCP\)](#).

Agent workstation

The Amazon Connect Call Control Panel (CCP) has specific network and hardware requirements that must be met to ensure the highest quality of service for your agents and contacts:

- Set Up Your Network for CCP use and ensure that your agent hardware meets minimum requirements.
- Ensure that you have used the Amazon Connect Check Amazon Connectivity Tool on the same network segment as your agents to verify that your network and environment is configured correctly for CCP use.
- Calculate PSTN latency for use cases that require agents and contacts to be in geographically distant locations
- Review the [Troubleshooting Issues when using the Contact Control Panel \(CCP\)](#) section to create runbooks and playbooks for your agents and supervisors to follow should they encounter issues.
- Set up monitoring for your agent workstations and consider partner solutions for call quality monitoring. Your goal with monitoring your agent workstations should be the ability to identify the source of any potential network and resource contention. For example, consider a typical agent's softphone network connection path to Amazon Connect:

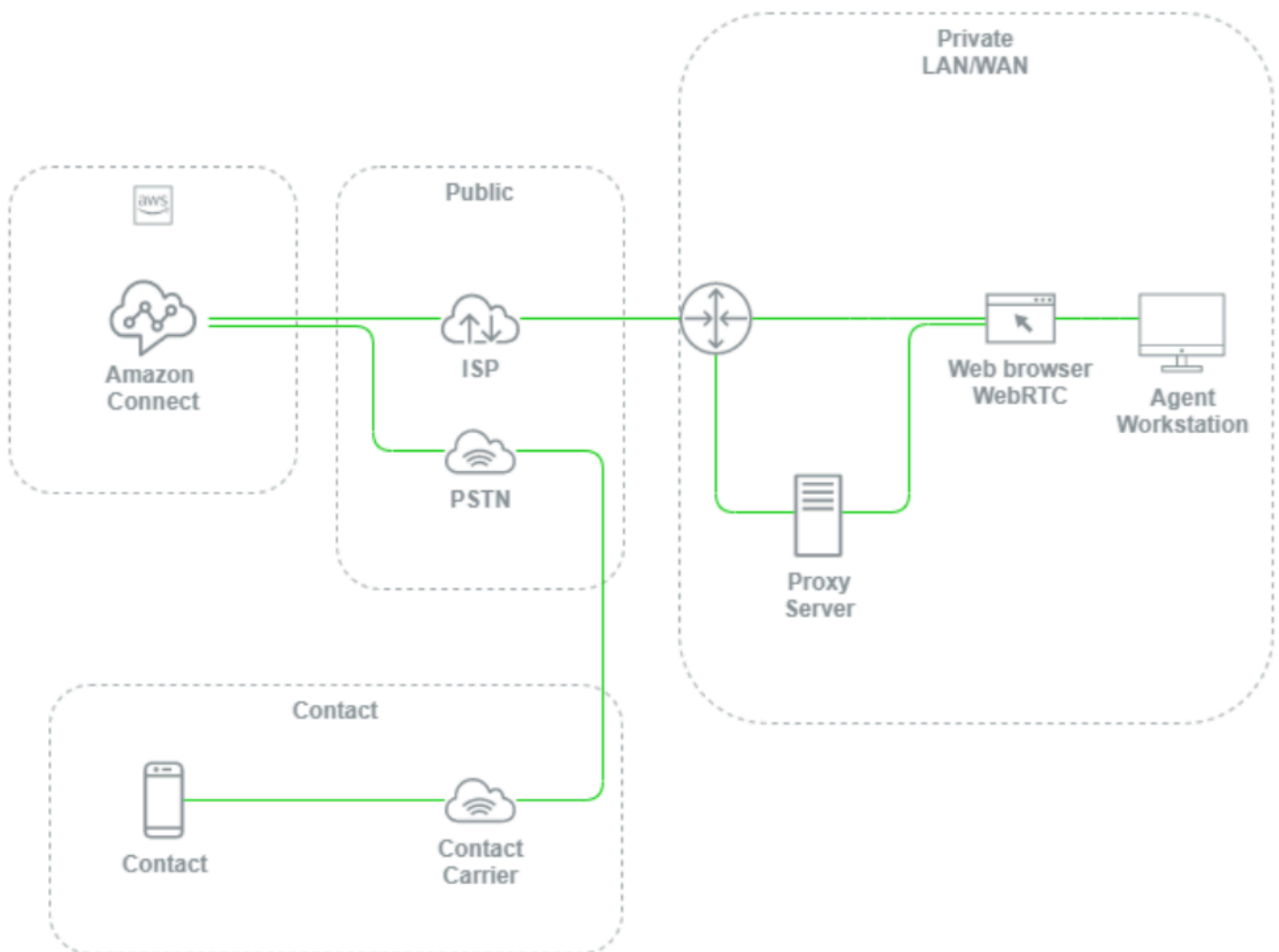

Without setting up monitoring at the local LAN/WAN, path to AWS, and agent workstation levels, it's difficult and often impossible to determine if a voice quality issue is originating from your agent's workstation, their private LAN/WAN, ISP, AWS, or the contact itself. Setting up logging and alerting mechanisms proactively is critical in determining root cause and optimizing your environment for voice quality.

Configure your existing directory

If you are already using an AWS Directory Service directory to manage users, you can use the same directory to manage user accounts in Amazon Connect. This must be decided and configured when you create your Amazon Connect instance. You cannot change the identity option you select after you create the instance. For example, if you decide to change the directory you selected to enable

Single Sign On (SSO) for your instance, you can delete the instance and create a new one. When you delete an instance, you lose all configuration settings and metrics data for it

Service Quotas

Review the default service quotas for each service involved in your workload as well as the default service quotas for Amazon Connect and request increases where applicable. When requesting an increase for Amazon Connect, be sure to use expected values without additional padding for fluctuations. Fluctuations are considered automatically when you make your request.

AWS Enterprise support

AWS Enterprise Support is recommended for business and/or mission-critical workloads on AWS. Both Enterprise Support and Well-Architected Review with an AWS Solutions Architect are required to qualify for the Amazon Connect Service Level Agreement.

AWS well-architected review

Before any migration or implementation to Amazon Connect, follow our best practices by using the AWS Well-Architected Framework, Operational Excellence. The Framework provides a consistent approach for you to evaluate architectures and implement designs that will scale over time based on five pillars — operational excellence, security, reliability, performance efficiency, and cost optimization. We also recommend using AWS Enterprise Support for business and mission-critical workloads in AWS. Both Enterprise Support and Well-Architected Review with your AWS Solutions Architect are required to qualify for the Amazon Connect Service Level Agreement.

Operate

Consider the following areas to operate an Amazon Connect workload.

Logging and monitoring

See [Monitoring your instance using CloudWatch](#) and [Logging Amazon Connect API calls with AWS CloudTrail](#).

Contact attributes

Amazon Connect allows you to dynamically set and reference contact attributes within flows to create dynamic and personalized experiences for your contacts, create powerful self-service applications, data-driven IVRs, integrations with other AWS services, simplify phone number

management, and allows for custom real-time and historical reporting and analytics. The following are Best practices and considerations you can follow to reduce complexity, prevent data loss, and ensure a consistent quality of experience for your contacts.

Note the following considerations:

- **Data size** – To prevent truncation, the size limitation for contact attributes you can set in a Set contact attributes block varies depending on the charset, encoding, and language used. While this is generally enough data to play a short story for a contact, it is possible to exceed this limit, truncating any attributes set over the 32KB.
- **Data sensitivity** – Note if any attributes being set, queried, and referenced are sensitive or fall under any regulatory guidelines and ensure that the data is being treated appropriately for your use case.
- **Data persistence** – Any attributes set using the Set contact attributes block will be included in the contact record for your contact and available for screen pop to any custom agent desktop using the Streams API. Any time the attribute is referenced within your flow and logging is enabled for the flow, the name and value of the attribute will be logged to Amazon CloudWatch.

Best practices

- **Monitor usage** – As you implement new functionality, onboard new business units, and iterate on existing flows, look up your current attribute usage in contact search, copy the attributes to a text editor, add the new attributes, and ensure that you do not exceed the 32KB size limitation. Be sure to account for variable length fields like firstName and lastName and ensure that, even when the maximum space is used in a field, that you are still below the 32KB limitation.
- **Clean-up** – If data persistence isn't required, you can set an attribute with the same name and a blank value to prevent the data from being stored to the contact record or passed in a screen pop to an agent using the [Amazon Connect Streams](#) API while freeing up the bytes that data would have otherwise used in the contact record.
- **Sensitive data** – Use the **Store customer input** block to collect sensitive DTMF input from your contacts and use envelope encryption to protect both the raw data and the data keys used to encrypt them. Store sensitive data in a separate database where persistence is required, use the **Set logging behavior** flow block to disable logging whenever sensitive information is referenced, and remove, clean up, or obfuscate sensitive data using the **Set contact attributes** block Clean-up method outlined previously. For more information, see [Compliance validation in Amazon Connect](#).

Telephony

In the US, use toll-free phone numbers wherever possible to load balance across multiple carriers for additional route and carrier redundancy. This also helps to decrease time to resolution when compared to DID phone numbers, which must be managed by a single carrier. In situations where you use DIDs, load balance across numbers from multiple carriers, when possible, to increase reliability. Make sure that you handle all error paths in your flow appropriately, and implement the best practices, requirements, and recommendations located in [Troubleshooting Issues when using the Contact Control Panel \(CCP\)](#).

If you're forwarding your existing telephony provider's phone numbers to Amazon Connect, ensure that the process to change the forward destination to an alternative DID/toll-free number or otherwise remove the forward is defined and well-understood by your operations team. Ensure that you have Runbooks and Playbooks specifically for production readiness assessments, phone number porting and forwarding processes, and troubleshooting audio issues that could arise when transferring calls from your existing telephony provider. You also want a repeatable process that your operations team can follow to determine if the source of these audio issues is Amazon Connect or your existing telephony provider.

Amazon Connect APIs

Amazon Connect throttling quotas are by account, and not instance. You should consider the following best practices when working with Amazon Connect APIs:

Implement a caching/queuing solution

To decrease API data query overhead and avoid throttling, you can use an intermediary database like Amazon DynamoDB to store API call results rather than calling the API from all endpoints interested in the API data. For example, the following diagram represents the use of the Amazon Connect metric API from multiple sources that need to consume this information:

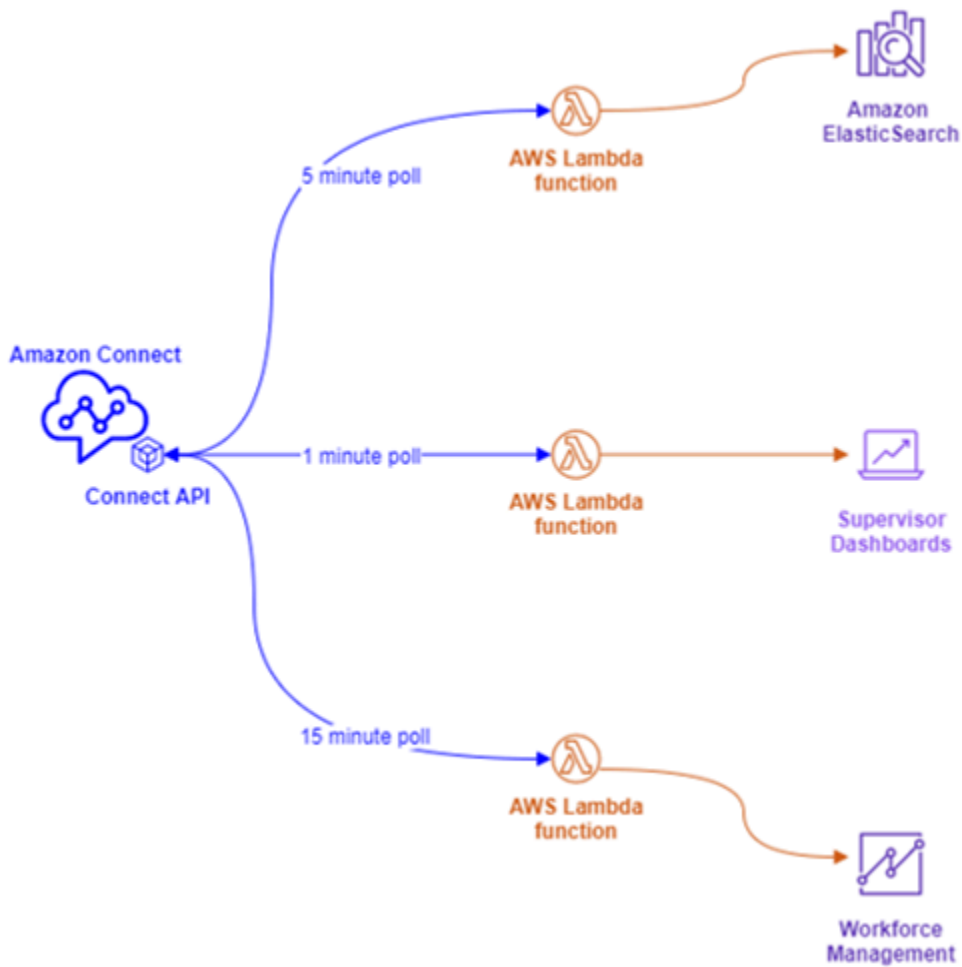

Rather than having separate AWS Lambda functions, each with their own polling requirements, you can have a single AWS Lambda function write all interesting data to Amazon DynamoDB. Rather than having each endpoint go to the API directly to retrieve the data, they point to DynamoDB, as illustrated in the following diagram:

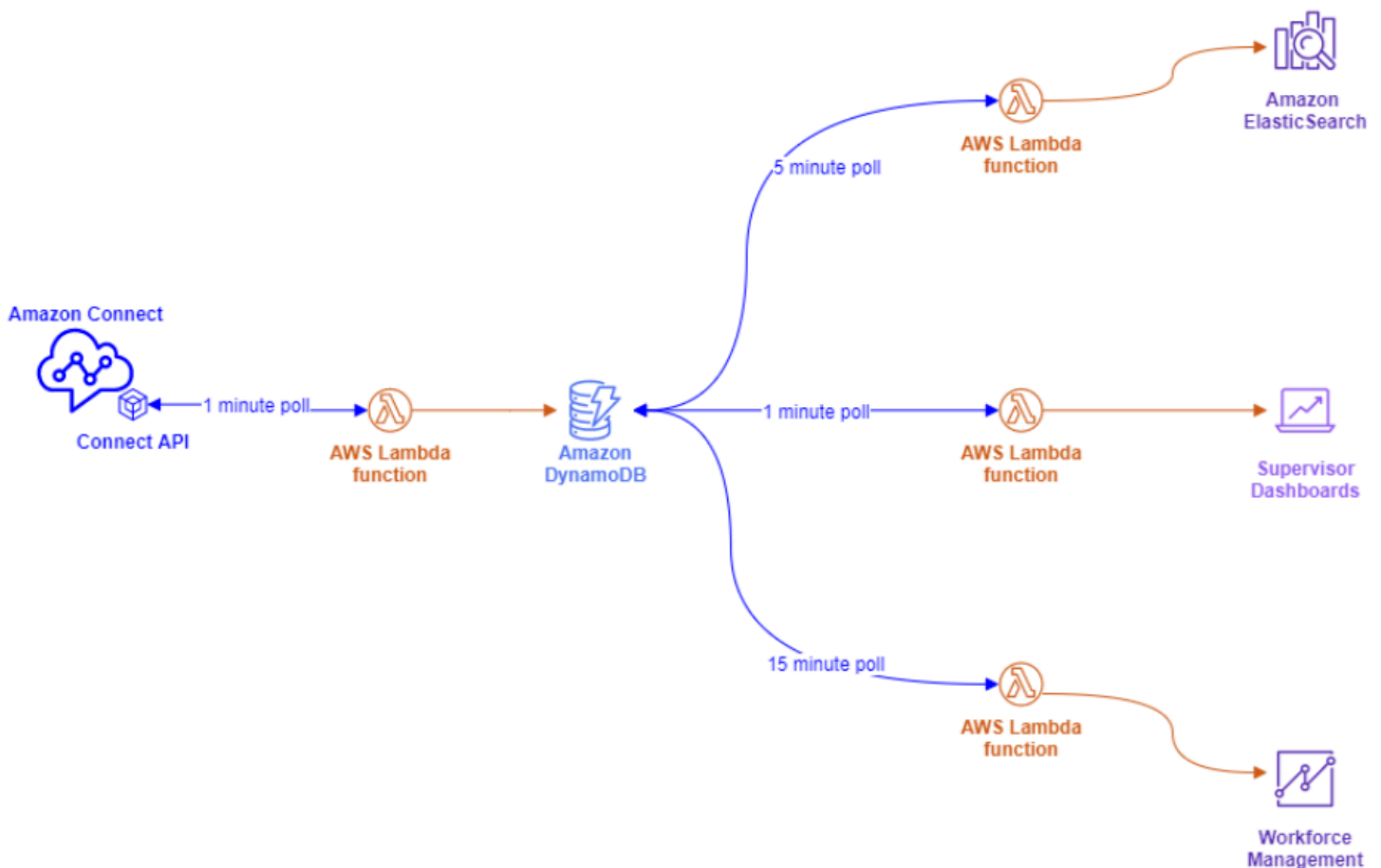

This architecture allows you to change polling intervals and add endpoints, as needed, without worrying about exceeding service quotas, giving you the ability to scale to however many concurrent connections your database solution supports. You can use this same concept with querying any real-time data feeds from Amazon Connect. For situations where you need to perform an API action, like an Outbound API call, you can use this same concept in combination with Amazon Simple Queue Service to queue API requests Using AWS Lambda with SQS.

Exponential back off and retry strategies

You can run into situations where API throttling limits get exceeded. This can happen when the API calls fail and are retried repeatedly or made directly from multiple concurrent endpoints without a caching or queuing solution implemented. To avoid exceeding your service quotas and impacting downstream processes, you should consider using exponential back off and retry strategies within your AWS Lambda functions in combination with caching and queueing.

Change management

Two of the primary drivers for moving workloads to the Amazon Connect are flexibility and speed to market. To ensure operational excellence without sacrificing agility, follow these best practices:

- **Modular flows:** Flows in Amazon Connect are similar to modern application building where smaller, purpose-built components allow for more flexibility, control, and ease of management when compared to monolithic alternatives. You can make your flows small and re-usable, combining the modular flows into an end-to-end experience with **Transfer to flow** blocks. This approach allows you to reduce risk during change implementation, allow you to test single, smaller changes rather than regression testing the entire experience, and will make it easier to identify and address issues with your flows during testing.
- **Repositories:** Back up all versions of all flows to a repository of your choice using contact flow Import/Export as part of your change management process.
- **Distribute by percentage:** To reduce risk encountered during change management and experiment with new experiences for your contacts, you can use the **Distribute by percentage** block to route a subset of your traffic to new flows while leaving the other traffic on the original experience.
- **Measuring results:** Data driven decision making is key to successfully driving meaningful changes for your business. Having a key metric to measure your changes against is absolutely necessary. For all changes you're making, you need to plan for how you will measure success. For example, if you're implementing self-service functionality for your contacts, what percentage of contacts do you expect to self-serve to consider the workload successful or what other metrics are you measuring to determine success?
- **Rollbacks:** Ensure that there is a clear, well-defined, and well-understood process to back out any changes to the previous state, specific to the change performed. For example, if you publish a new flow version, ensure that the change instructions include documentation on how to roll back to the previous flow version.

Routing profiles

Understanding how priority, delay, and overflow routing work within Amazon Connect is critical to maximizing agent productivity, reducing contact wait times, and ensuring the best quality of experience for your contacts.

Routing in Amazon Connect

Contact routing in Amazon Connect is done through a collection of queues and routing configurations called a routing profile. A queue is equivalent to a skill or proficiency that agent needs to possess to service contacts for that queue. A routing profile can be viewed a set of skills that you can match to your contact's needs

Within your flow, you can prompt for additional information and, if they need to reach an agent, you can use the flow configuration to place them in the appropriate queue. In the following example, Savings, Checking, and Loans are individual queues or skills and the three routing profiles are unique skillsets, or groups of skills:

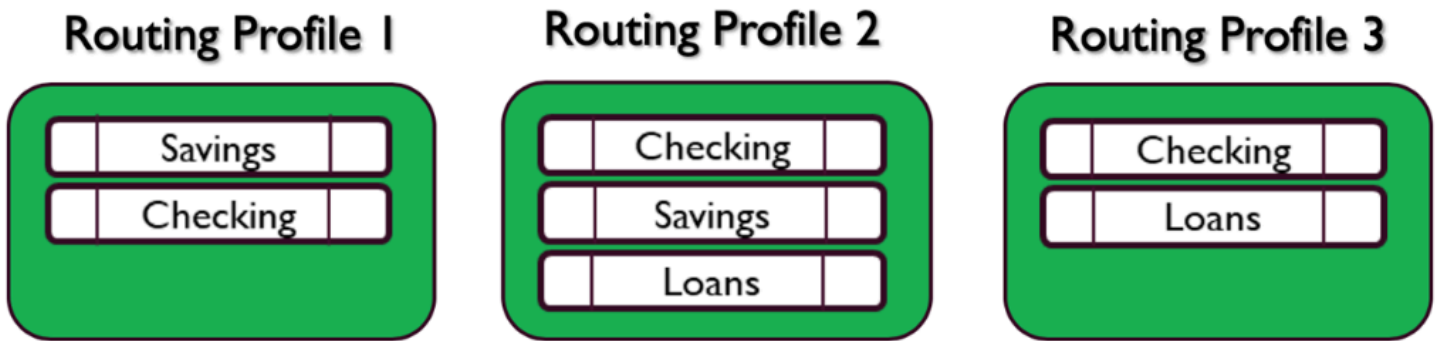

Each agent is assigned to only one routing profile based on their skillset, and many agents with similar skillset can share the same routing profile:

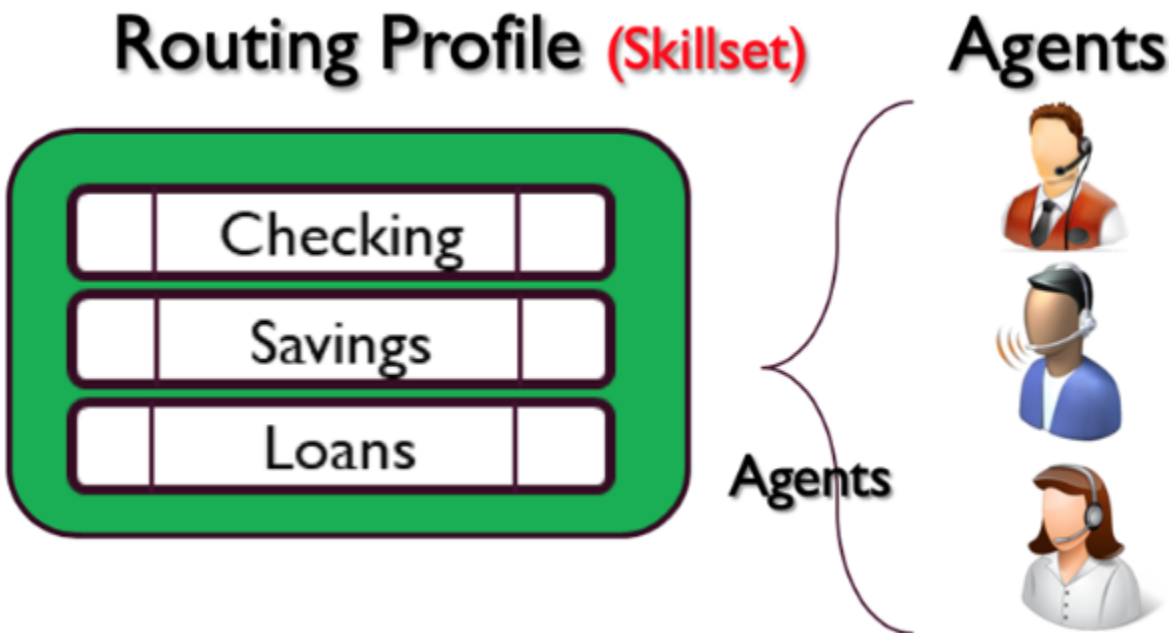

Each phone number or chat endpoint will be associated with one flow. The flow executes its logic, which may involve prompting the customer for information, to determine the contact’s needs, and eventually routes the contact into an appropriate queue. The following diagram depicts how routing profile, queue, and flow work together to service a contact:

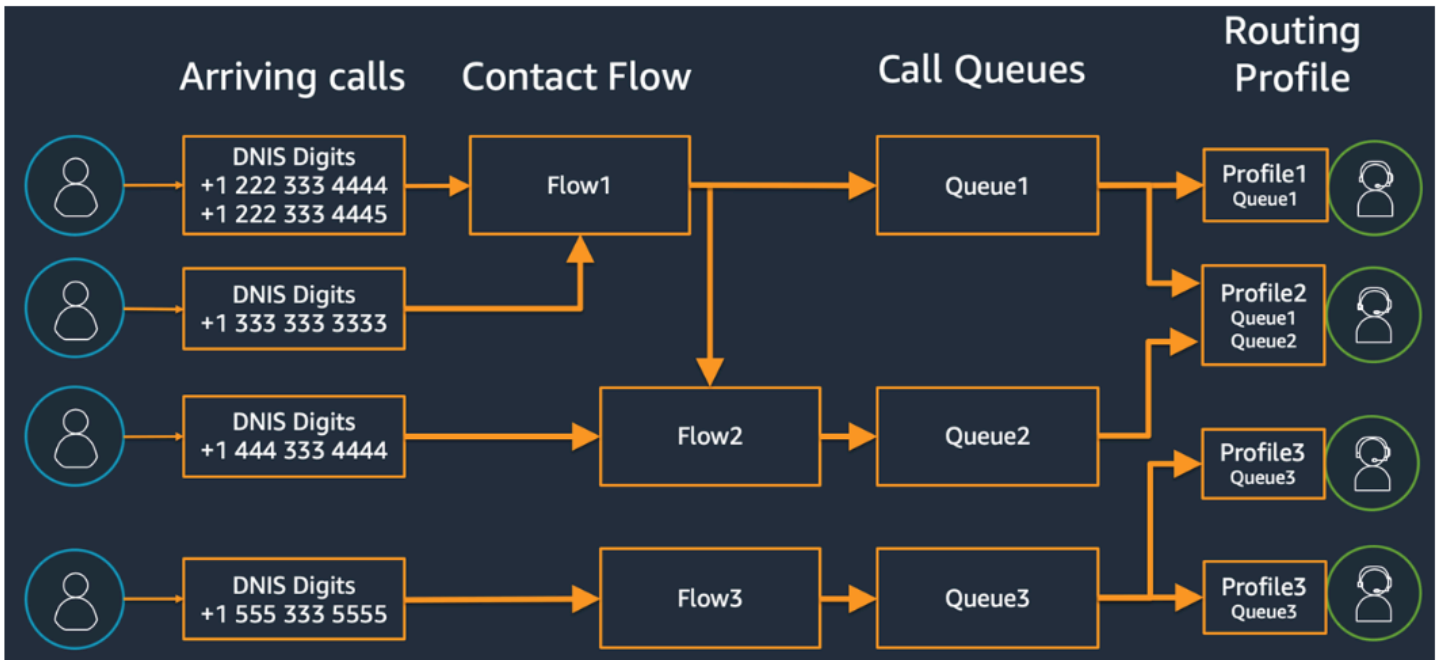

To illustrate how you might determine various queues, routing profiles, and agent assignments to the routing profiles, consider the following table:

Agent	Checking	Savings	Loans	Mortgages	Investments
John D.	✓	✓			
Sam J.	✓	✓			
Debbie E.	✓	✓			
Charles T.	✓	✓			
Jane D.	✓	✓	✓		
Connie E.	✓	✓	✓		
Steve L.	✓	✓	✓		
Chris A.	✓	✓	✓		
Joyce C.			✓		
Brian M.			✓		
Caleb S.				✓	✓
Travis F.				✓	✓
Robbie H.	✓	✓	✓		



On the top row, you've identified your skills or queues. In the left column, you have your list of agents, and in the middle, you've checked the skills supported by each of the agents. You can sort the matrix grouped by the common set of skill requirements across our agent population. This helps identify the routing profiles as one marked in the green box (which consists of two queues), which you can assign agents to. As a result of this exercise, you have identified four routing profiles, and assign your 13 agents to them accordingly.

Based on the previous table, an incoming call from a contact needing the Savings skill could be served by three groups of agents in the three routing profiles 1, 2, and 4 as depicted in the following diagram:

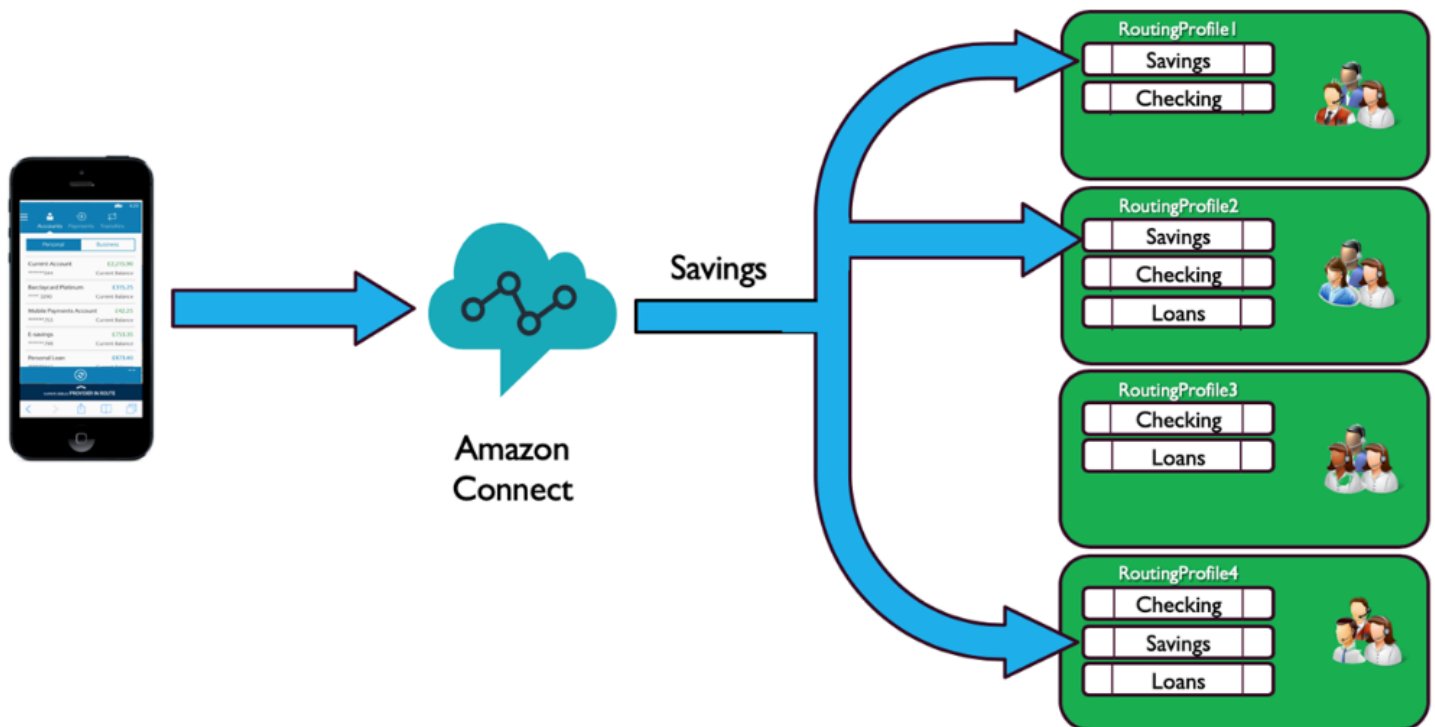

Priority and delay

Using the combination of priority and delay in different Routing Profiles, you can create flexible routing strategies.

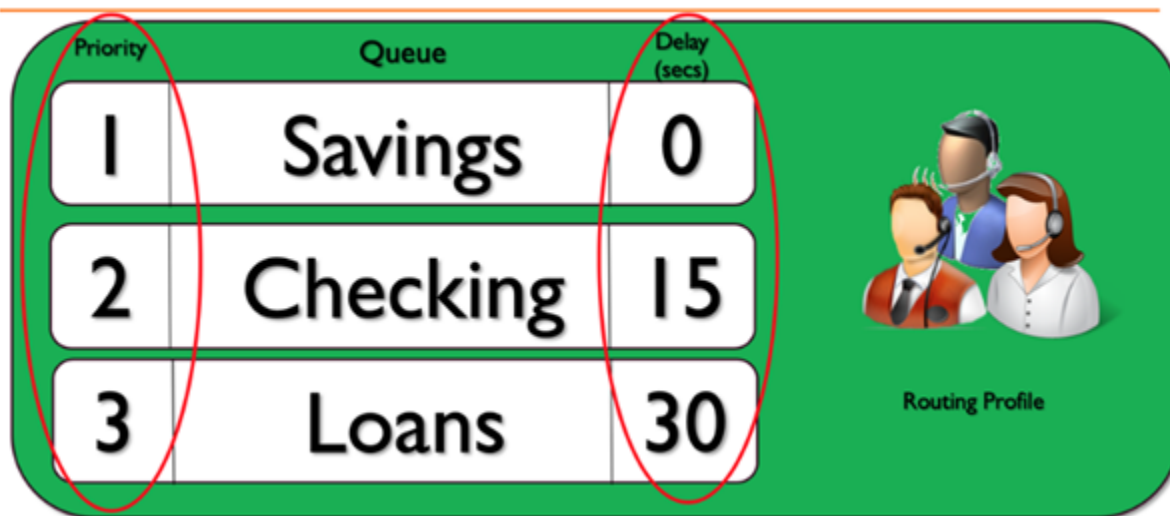

The preceding routing profile example shows a set of queues, and their respective priority and delay. The lower the number, the higher the priority. All higher priority calls must be processed before a lower priority call will be processed. This is a difference from systems that will eventually process lower priority of calls based upon a weighting factor.

You can also add a delay to each of the queues within each of the routing profiles. Any call coming into the queue will be held for the specified period of delay assigned to the designated queue. The call will be held for the delay period, even when agents are available. You might use this in situations where you have a group of agents who are reserved to help you meet your Service Level Agreements (SLAs), but are otherwise assigned to other tasks or queues. If a call doesn't get answered within a specified period of time, these agents would become eligible to receive a call from the designated queue. For example, consider the following diagram:

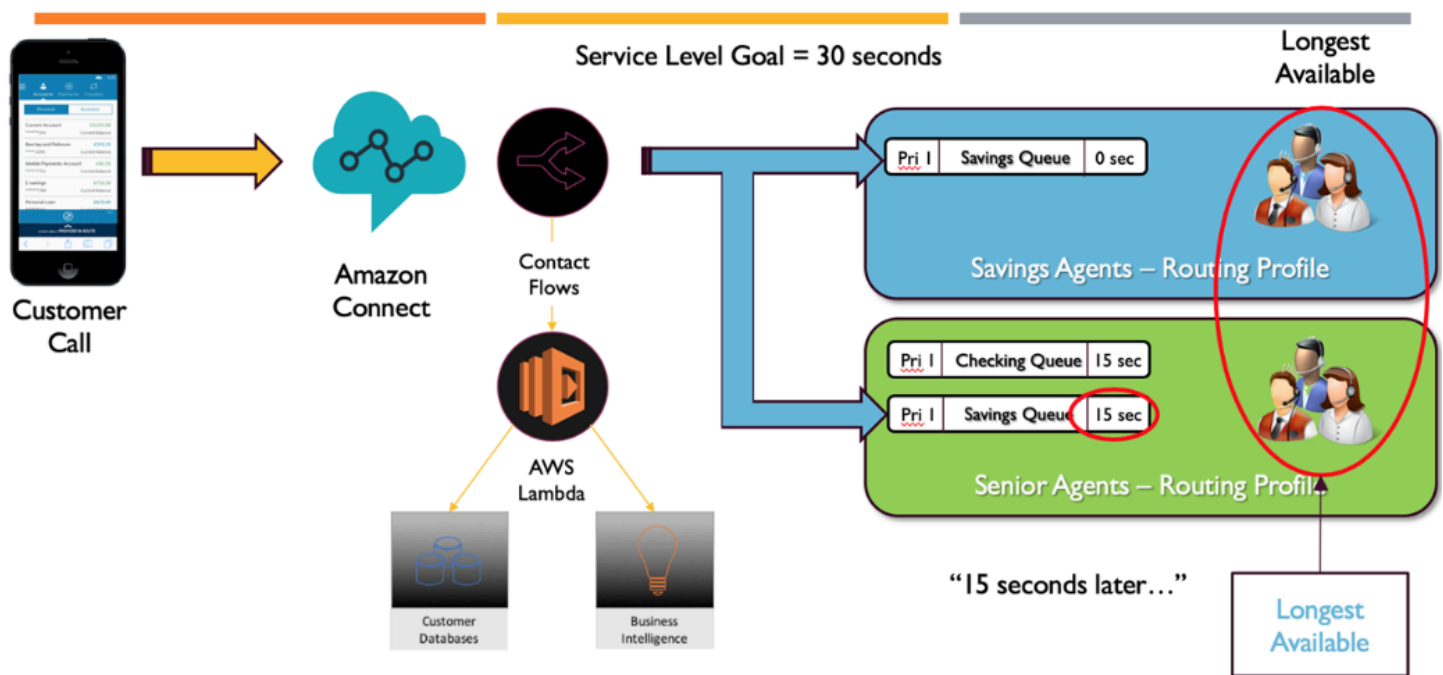

This diagram shows an SLA of 30 seconds. A call comes in for the Savings queue. The Savings queue immediately looks for an agent in the "Savings" routing profile due to the configuration of 0 delay in the profile for the queue. Because of the configuration of 15 delay for Senior Agents, they will not be eligible to receive the Savings contact for 15 seconds. After 15 seconds elapses, the contact becomes available for a Senior Level agent and Amazon Connect looks for the Longest Available across both routing profiles.

Path to service

When you are designing customer experiences in Amazon Connect, plan to ensure a path to service. There are many planned and unplanned events that can impact the customer experience as they traverse through Amazon Connect Flows. The following sample customer experience shows some suggested checks to ensure a consistent quality experience for your contacts:

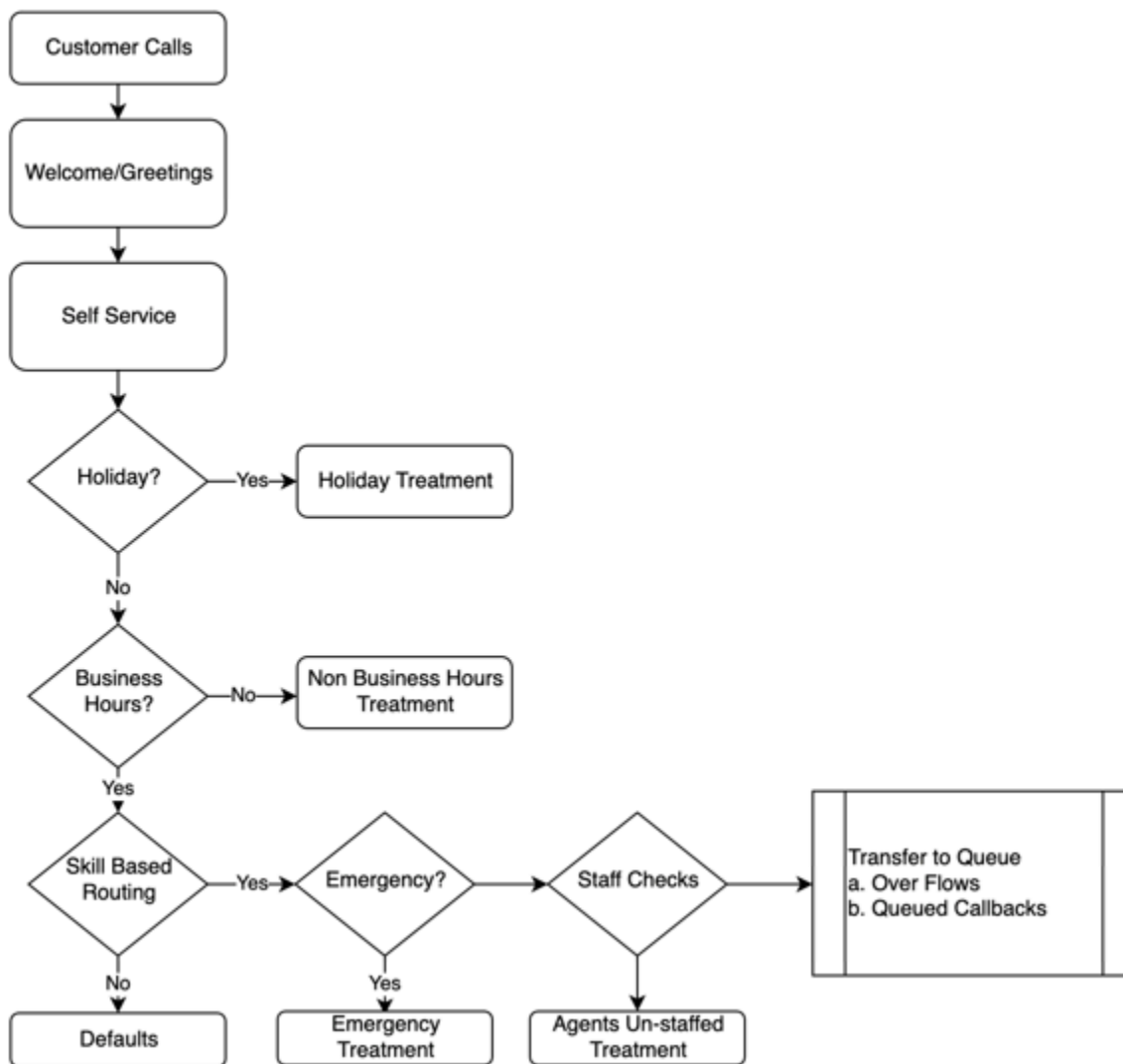

This sample customer experience takes into account planned events such as Holidays and Business hours as well as unplanned events, like agents not staffed during business hours. With this logic, you can also account for emergency situations, such as contact center closures because of inclement weather or service disruptions. Consider the following concepts as illustrated in the diagram:

- **Self-service:** In a typical IVR, you can include any greetings and disclaimer messages such as call recording announcements upfront, which can be followed by self-service options. Self-service brings cost and performance optimizations for your contact center and enables your organization to serve customers 24x7, regardless of holidays, business hours, or availability of agents. Always include a path to service in case customers are unable to self-serve and need human assistance. For example, if you are using Amazon Lex bots for self-service, you can make use of fallback intents to escalate conversations for human assistance.

- **Holidays:** Many enterprise customers have a central repository that holds corporate holidays. You can use an AWS Lambda function to data dip into that repository and offer holiday treatment to customers. Additionally, you can also store corporate holidays in DynamoDB along with a custom message for each holiday. For example, if your enterprise observes December 25 as Christmas, you could have a holiday prompt or Text to Speech, "We are currently closed for Christmas. Please call back on December 26 when our normal business hours will resume."

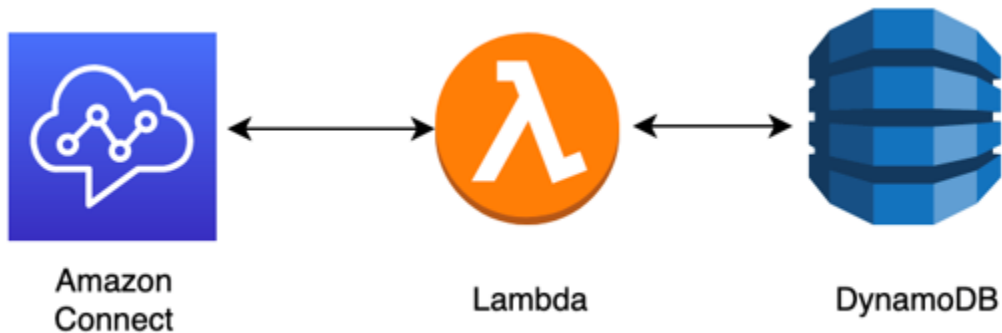

- **Business hours:** After holidays have been verified, you can check for business hours and, if outside of business hours, you can change the experience dynamically for your contacts. If the contact occurs during business hours, you can identify customer intent for calls and map to certain queues in your contact center, increasing the likelihood of getting to the correct agent, and decreasing the amount of time it takes your contact to reach service. It is highly recommended to map defaults as customers could be calling for a reason you haven't accounted for yet or may respond in a way you don't expect.
- **Emergency messages:** After you have identified customer intent for call, it is suggested to implement an emergency check treatment. In the event of an emergency situation that impacts your contact center, you can store an emergency True/False flag in an intermediary database like DynamoDB. To allow your supervisors and administrators to set this flag dynamically, with no code, you can build a separate IVR that authenticates your Amazon Connect administrators based upon ANI and PIN number verification for internal use only. In the event of emergency, your supervisors can call into that dedicated line from their phones and after authentication set the Emergency flag to true for scenarios such as contact center closure due to inclement weather or ISP outage at the physical location of contact center.
- **Emergency message API:** You can also consider building an AWS API gateway with AWS Lambda function at the back end to set the Emergency flag to true/false securely in the database. Your supervisors can securely access that API through web to toggle disaster mode or dynamically toggle it in response to an external event. In your Amazon Connect instance, every contact that comes in through the flow will use AWS Lambda to check for that emergency flag and, in case of disaster mode, you can dynamically make announcements and provide a customer with a path

to service. This will further ensure business continuity and mitigate the impact of situations like these from affecting your customers.

- **Check agent staffing:** Before transferring to the queue in your flow, you can check agent staffing to ensure that an agent is logged in to service the contact. For example, you may have an agent busy servicing another contact that might become available in the next five minutes, or you may not have anyone logged into the system at all. During these instances, you will prefer a different customer experience rather than making them wait in the queue for an agent to become available.
- **Route to service:** When you transfer the call to the queue, you can offer queued callbacks, queue overflows, or tiered routing using Amazon Connect routing profiles to offer a consistent, high-quality experience for your callers that meet your Service Level requirements.

Resources

Documentation

- [DevOps and AWS](#)
- [Amazon Connect Service API Documentation](#)

Blog

- [How to handle unexpected contact spikes with Amazon Connect](#)

Video

- [DevOps at Amazon](#)

Security: Design principles for developing a secure contact center

Security includes the ability to protect information, systems, and assets while delivering business value through risk assessments and mitigation strategies. This section provides an overview of design principles, best practices, and questions surrounding security for Amazon Connect workloads.

Amazon Connect Security Journey

After you've made the decision to move your workload to Amazon Connect, in addition to reviewing [Security in Amazon Connect](#) and [Security Best Practices for Amazon Connect](#), follow these guidelines and steps to understand and implement your security requirements relative to the following core security areas:



Understanding the AWS Security Model

When you move computer systems and data to the cloud, security responsibilities become shared between you and AWS. AWS is responsible for securing the underlying infrastructure that supports the cloud, and you're responsible for anything you put on the cloud or connect to the cloud.

AWS Shared Responsibility Model

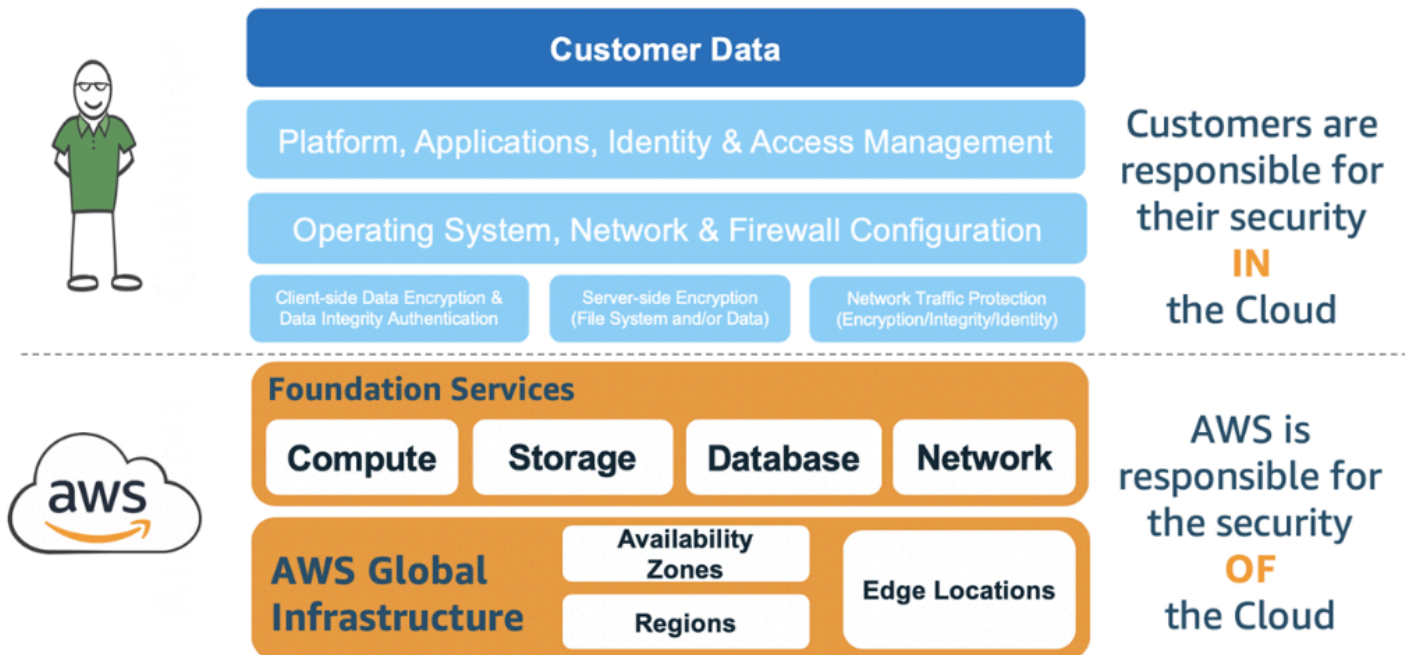

Which AWS services you use will determine how much configuration work you have to perform as part of your security responsibilities. When you use Amazon Connect, the shared model reflects AWS and customer responsibilities at a high-level, as shown in the following diagram.

AWS Shared Responsibility Model for Amazon Connect

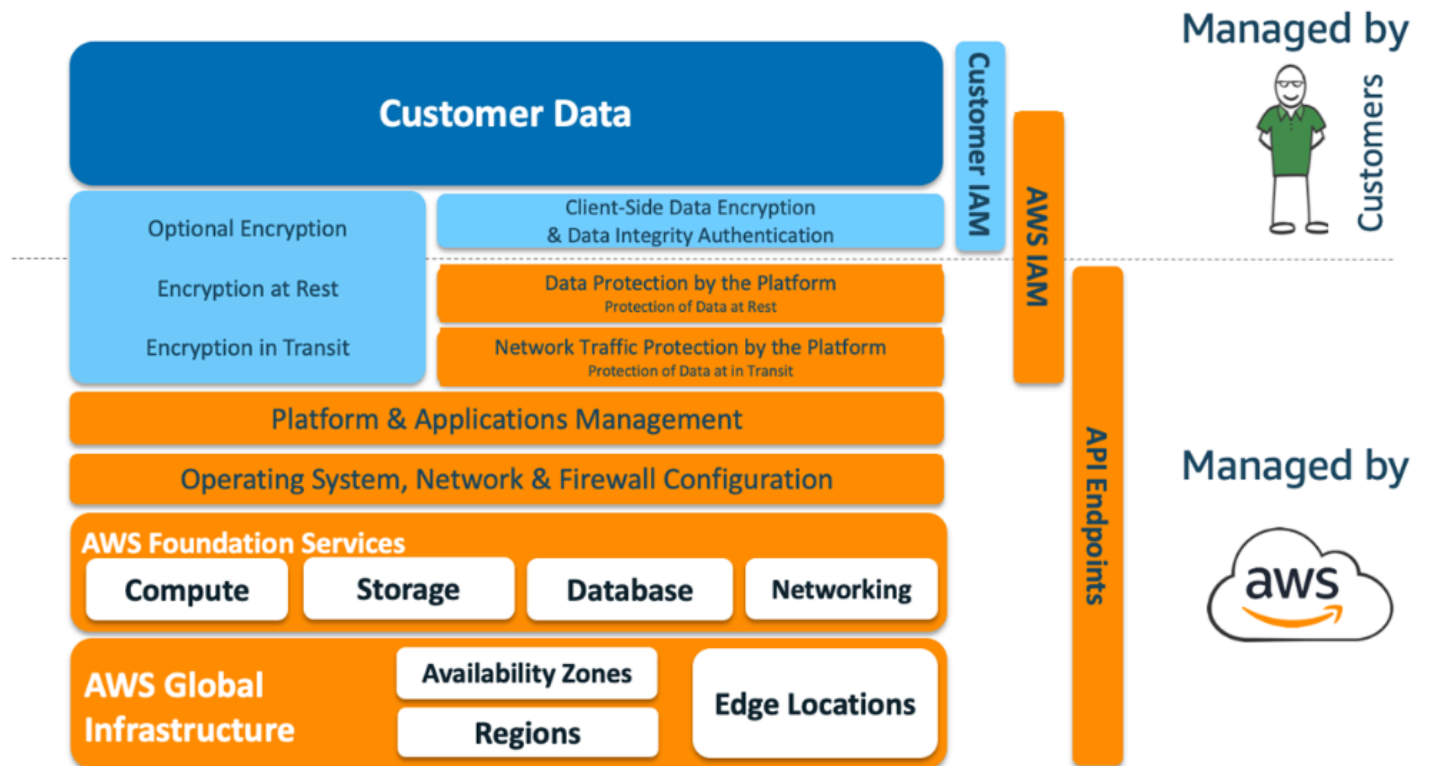

Compliance Foundations

Third-party auditors assess the security and compliance of Amazon Connect as part of multiple AWS compliance programs. These include [SOC](#), [PCI](#), [HIPAA](#), [C5 \(Frankfurt\)](#), and [HITRUST CSF](#).

For a list of AWS services in scope of specific compliance programs, see [AWS Services in Scope by Compliance Program](#). For general information, see [AWS Services Compliance Programs](#).

Region selection

Region selection to host the Amazon Connect instance depends on data sovereignty restrictions and where the contacts and agents are based. After that decision is made, review network requirements for Amazon Connect and ports and protocols that you need to allow. Additionally, to reduce the blast radius use the domain allow list or allowed IP address ranges for your Amazon Connect instance.

For more information, see [Set up your network](#).

AWS services integration

We recommend reviewing each AWS service in your solution against the security requirements of your organization. See the following resources:

- [Security in AWS Lambda](#)
- [Security and Compliance in DynamoDB](#)
- [Security in Amazon Lex](#)

Data Security in Amazon Connect

During your security journey, your security teams may require a deeper understanding of how data is handled in Amazon Connect. See the following resources:

- [Detailed network paths for Amazon Connect](#)
- [Infrastructure security in Amazon Connect](#)
- [Compliance validation in Amazon Connect](#)

Workload diagram

Review your workload diagram and architect an optimum solution on AWS. This includes analyzing and deciding which additional AWS services should be included in your solution and any third-party and on-premises applications that need to be integrated.

AWS Identity and Access Management (IAM)

Types of Amazon Connect Personas

There are four types of Amazon Connect personas, based on the activities being performed.

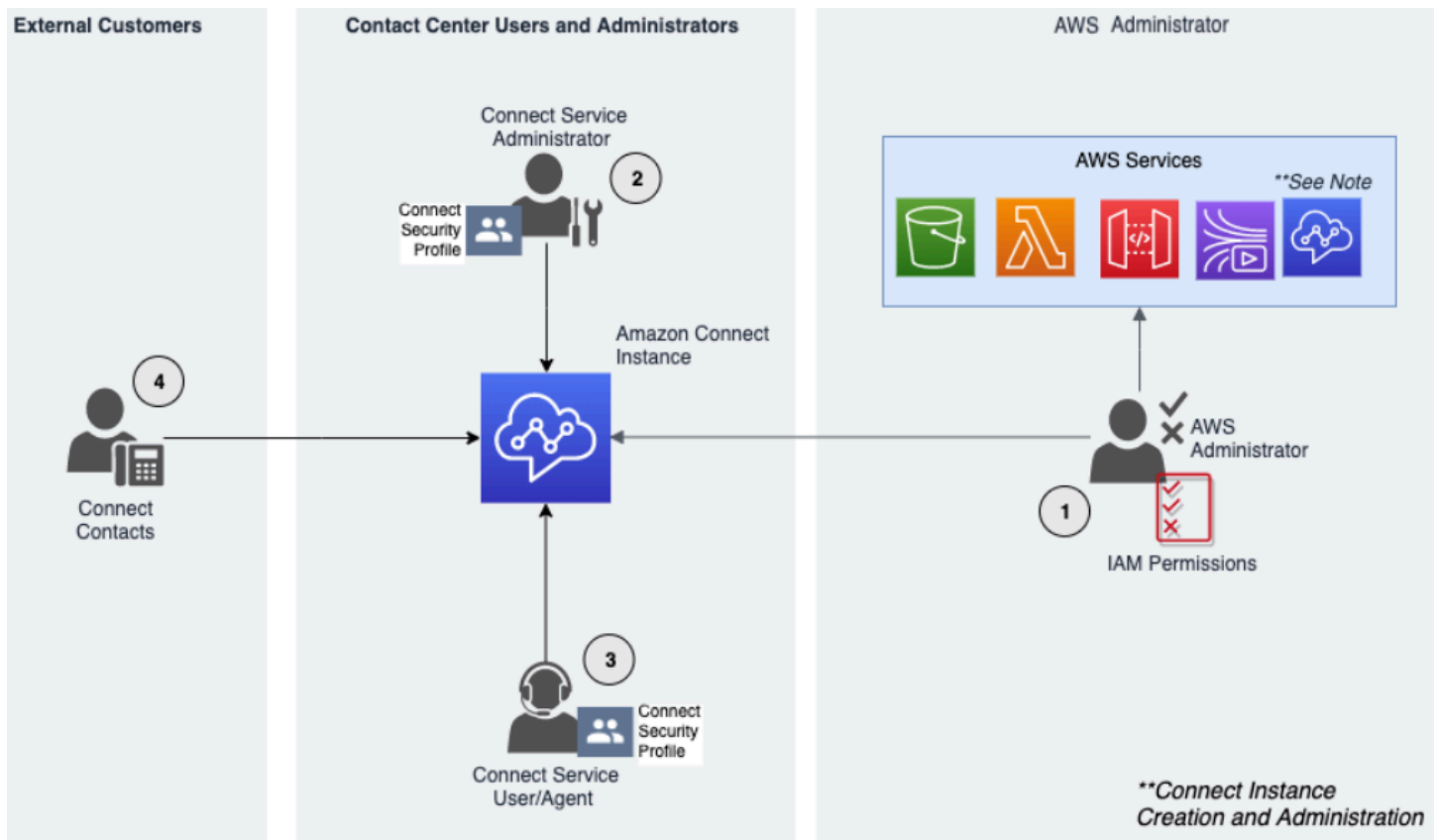

1. AWS administrator – AWS administrators create or modify Amazon Connect resources and may also delegate administrative access to other principals by using the AWS Identity and Access Management (IAM) service. The scope of this persona is focused on creating and administering your Amazon Connect instance.
2. Amazon Connect administrator – Service administrators determine which Amazon Connect features and resources employees should access within the Amazon Connect admin website. The service administrator assigns security profiles to determine who can access the Amazon Connect admin website and what tasks they can perform. The scope of this persona is focused on creating and administering your Amazon Connect contact center.
3. Amazon Connect agent – Agents interact with Amazon Connect to perform their job duties. Service users may be contact center agents or supervisors.
4. Amazon Connect Service contact – The customer who interacts with your Amazon Connect contact center.

IAM Administrator Best Practices

IAM Administrative access should be limited to approved personnel within your organization. IAM administrators should also understand what IAM features are available to use with Amazon Connect. For IAM best practices, see [Security best practices in IAM](#) in the *IAM User Guide*. Also see [Amazon Connect identity-based policy examples](#).

Amazon Connect Service Administrator Best Practices

Service administrators are responsible for managing Amazon Connect users, including adding users to Amazon Connect give them their credentials, and assign the appropriate permissions so they can access the features needed to do their job. Administrators should start with a minimum set of permissions and grant additional permissions as necessary.

[Security profiles](#) help you manage who can access the Amazon Connect dashboard and Contact Control Panel, and who can perform specific tasks. Review the granular permissions granted within the default security profiles available natively. Custom security profiles can be set up to meet specific requirements. For example, a power agent who can take calls but also has access to reports. After this is finalized, users should be assigned to the correct security profiles.

Multi-Factor Authentication

For extra security, we recommend that you require multi-factor authentication (MFA) for all IAM users in your account. MFA can be [set up through AWS IAM](#) or your SAML 2.0 identity provider, or Radius server, if that's more applicable for your use case. After MFA is set up, a third text box becomes visible on the Amazon Connect login page to provide the second factor.

Identity Federation

In addition to storing users in Amazon Connect, you can [enable single sign-on \(SSO\) to Amazon Connect](#) by using identity federation. Federation is a recommended practice to allow for employee lifecycle events to be reflected in Amazon Connect when they are made in the source identity provider.

Access to Integrated Applications

Steps within your flows may need credentials to access information in external applications and systems. To provide credentials to access other AWS services in a secure way, use IAM roles. An IAM role is an entity that has its own set of permissions, but that isn't a user or group. Roles also don't have their own permanent set of credentials and are automatically rotated.

Credentials such as API keys should be stored outside of your flow application code, where they can be retrieved programmatically. To accomplish this, you can use AWS Secrets Manager or an existing third-party solution. Secrets Manager enables you to replace hardcoded credentials in your code, including passwords, with an API call to Secrets Manager to retrieve the secret programmatically.

Detective controls

Logging and monitoring are important for the availability, reliability and, performance of contact center. You should log relevant information from Amazon Connect Flows to Amazon CloudWatch and build alerts and notifications based on the same.

You should define log retention requirements and lifecycle policies early on, and plan to move log files to cost-efficient storage locations as soon as practical. Amazon Connect public APIs log to AWS CloudTrail. You should review and automate actions set up based on CloudTrail logs.

Amazon S3 is the best choice for long-term retention and archiving of log data, especially for organizations with compliance programs that require log data to be auditable in its native format. After log data is in an S3 bucket, define lifecycle rules to automatically enforce retention policies and move these objects to other, cost-effective storage classes, such as Amazon S3 Standard - Infrequent Access (Standard - IA) or Amazon S3 Glacier.

The AWS cloud provides flexible infrastructure and tools to support both sophisticated in cooperation with offerings and self-managed centralized-logging solutions. This includes solutions such as Amazon OpenSearch Service and Amazon CloudWatch Logs.

Fraud detection and prevention for incoming contacts can be implemented by customizing Amazon Connect Flows per the customer requirements. As an example, customers can check incoming contacts against previous contact activity in DynamoDB, and then take action, such as disconnecting a contact because they are a blocked contact.

Infrastructure protection

Although there is no infrastructure to manage in Amazon Connect, there could be scenarios where your Amazon Connect instance needs to interact with other components or applications deployed in infrastructure residing on-premises. Consequently, it is important to ensure that networking boundaries are considered under this assumption. Review and implement specific Amazon Connect infrastructure security considerations. Also, review contact center agent and supervisor desktops or VDI solutions for security considerations.

You can configure a Lambda function to connect to private subnets in a virtual private cloud (VPC) in your account. Use Amazon Virtual Private Cloud to create a private network for resources such as databases, cache instances, or internal services. Amazon Connect your function to the VPC to access private resources during execution.

Data protection

Customers should analyze the data traversing through and interacting with the contact center solution.

- Third party and external data
- On-premises data in hybrid Amazon Connect architectures

After analyzing the scope of the data, data classifications should be performed paying attention to identifying sensitive data. Amazon Connect conforms to the AWS shared responsibility model. [Data protection in Amazon Connect](#) includes best practices like using MFA and TLS and the use of other AWS services, including Amazon Macie.

Amazon Connect [handles variety of data related to contact centers](#). This includes phone call media, call recordings, chat transcripts, contact metadata as well as flows, routing profiles and queues. Amazon Connect handles data at rest by segregating data by account ID and instance ID. All data exchanged with Amazon Connect is protected in transit between the user's web browser and Amazon Connect using open standard TLS encryption.

You can specify AWS KMS keys to be used for encryption including bring your own key (BYOK). Additionally, you can use key management options within Amazon S3.

Protecting Data Using Client-Side Encryption

Your use case may require encryption of sensitive data that is collected by flows. For example, to gather appropriate personal information to customize the customer experience when they interact with your IVR. To do this you can use public-key cryptography with the [AWS Encryption SDK](#). The AWS Encryption SDK is a client-side encryption library designed to make it efficient for everyone to encrypt and decrypt data using open standards and best practices.

Input validation

Perform input validation to ensure that only properly formed data is entering the flow. This should happen as early as possible in the flow. For example, when prompting a customer to say or enter a telephone number, they may or may not include the country code.

Amazon Connect security vectors

Amazon Connect security can be divided into three logical layers as illustrated in the following diagram:

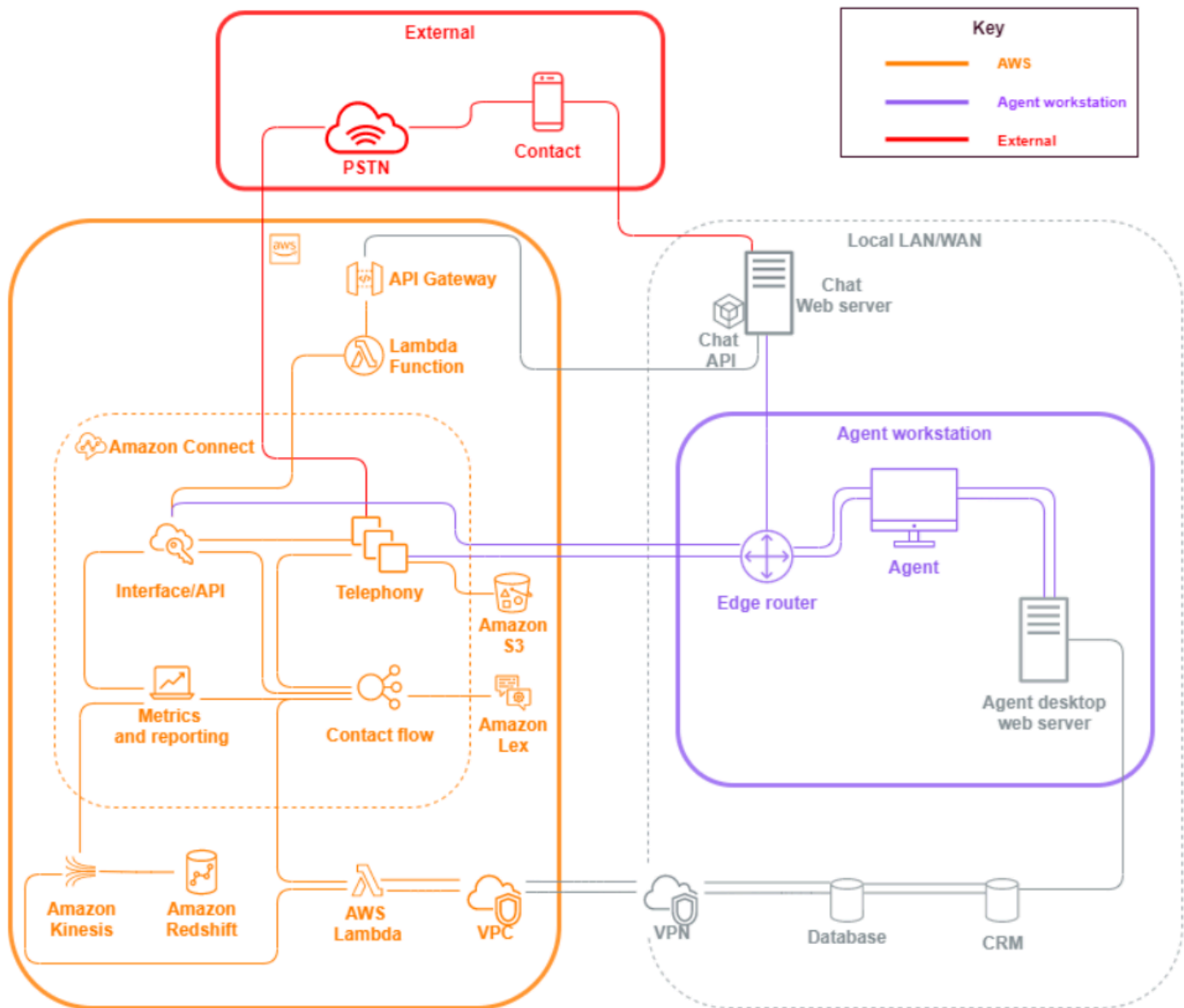

1. **Agent workstation.** The agent workstation layer is not managed by AWS and consists of any physical equipment and third-party technologies, services, and endpoints that facilitate your agent's voice, data, and access the Amazon Connect interface layer.

Follow your security best practices for this layer with special attention to the following:

- Plan identity management keeping in mind best practices noted in [Security Best Practices for Amazon Connect](#).

- Mitigate insider threat and compliance risk associated with workloads that handle sensitive information, by creating a secure IVR solution that enables you to bypass agent access to sensitive information. By encrypting contact input in your flows, you're able to capture information securely without exposing it to your agents, their workstations, or their operating environments. For more information, see [Encrypt customer input](#).
 - You are responsible for maintaining the allowlist of AWS IP addresses, ports, and protocols needed to use Amazon Connect.
2. **AWS:** The AWS layer includes Amazon Connect and AWS integrations including AWS Lambda, Amazon DynamoDB, Amazon API Gateway, Amazon S3, and other services. Follow the security pillar guidelines for AWS services, with special attention to the following:
- Plan identity management, keeping in mind best practices noted in [Security Best Practices for Amazon Connect](#).
 - Integrations with other AWS services: Identify each AWS service in the use case as well as any third-party integration points applicable for this use case.
 - Amazon Connect can integrate with AWS Lambda functions that run inside of a customer VPC through the [VPC endpoints for Lambda](#).
3. **External:** The External layer includes contact points including chat, click-to-call endpoints, and the PSTN for voice calls, integrations you may have with legacy contact center solutions in a Hybrid contact center architecture, and integrations you may have with other third-party solutions. Any entry point or exit point for a third party in your workload is considered the external layer.

This layer also covers integrations customers may have with other third-party solutions and applications such as CRM systems, work force management (WFM), and reporting and visualization tools and applications, such as Tableau and Kibana. You should consider the following areas when securing the external layer:

- You can [create contact filters for repeat and fraudulent contacts](#) using AWS Lambda to write contact details to DynamoDB from within your flow, including ANI, IP address for click-to-dial and chat endpoints, and any other identifying information to track how many contact requests occur during a given period of time. This approach allows you to query and add contacts to deny lists, automatically disconnecting them if they exceed reasonable levels.
- ANI Fraud detection solutions using [Amazon Connect telephony metadata](#) and [partner solutions](#) can be used to protect against caller ID spoofing.

- [Amazon Connect Voice ID](#) and other voice biometric partner solutions can be used to enhance and streamline the authentication process. Active voice biometric authentication allows contacts the option to speak specific phrases and use those for voice signature authentication. Passive voice biometrics allow contacts to register their unique voiceprint and use their voiceprint to authenticate with any voice input that meets sufficient length requirements for authentication.
- Maintain the [application integration](#) section in the Amazon Connect console for adding any third-party application or integration points to your allowlist, and remove unused endpoints.
- Send only the data necessary to meet minimum requirements to external systems that handle sensitive data. For example, if you have only one business unit using your call recording analytics solution, you can set an AWS Lambda trigger in your S3 bucket to process contact records, check for the business unit's specific queues in the contact record data, and if it is a queue that belongs to the unit, send only that call recording to the external solution. With this approach, you only send the data necessary and avoid the cost and overhead associated with processing unnecessary recordings.

For an integration that enables Amazon Connect to communicate with Amazon Kinesis and Amazon Redshift to enable the streaming of contact records, see [Amazon Connect integration: Data streaming](#).

Resources

Documentation

- [AWS Cloud Security](#)
- [Security in Amazon Connect](#)
- [IAM Best Practices](#)
- [AWS Compliance](#)
- [AWS Security blog](#)

Articles

- [Security Pillar](#)
- [Introduction to AWS Security](#)
- [AWS Security Best Practices](#)

Videos

- [AWS Security State of the Union](#)
- [AWS Compliance - The Shared Responsibility Model](#)

Reliability

Reliability includes the ability of a system to recover from infrastructure or service disruptions, dynamically acquire computing resources to meet demand, and mitigate disruptions such as misconfigurations or transient network issues. As resiliency is handled as part of the service, there are no reliability practices unique to Amazon Connect beyond of what is covered in [Operational Excellence](#). You can find prescriptive guidance on implementation in the [Reliability Pillar](#) whitepaper.

Resources

Documentation

- [AWS Service quotas](#)
- [Resilience in Amazon Connect](#)
- [Amazon CloudWatch](#)

Whitepaper

- [Reliability Pillar](#)

Video

- [Embracing Failure: Fault-Injection and Service Reliability](#)

Product

- [Trusted advisor](#): An online tool that provides you real-time guidance to help you provision your resources following AWS best practices.

Performance efficiency

Performance efficiency includes the ability to use computing resources efficiently to meet system requirements, and to maintain that efficiency as demand changes and technologies evolve. This section provides an overview of design principles, best practices, and questions surrounding performance efficiency for Amazon Connect workloads. You can find prescriptive guidance on implementation in the [Performance Efficiency Pillar](#) whitepaper.

Architectural design

There are two fundamental architectural design principles to consider when designing experiences for the contact center:

- Reductionism is a philosophical tenet stating that by analyzing a system to its ultimate component parts, you can unravel it at deeper levels.
- Holism, in contrast, states that by considering the whole picture one gets a deeper and more complete view of a situation than by analyzing it into its component parts

The reductionist approach focuses on each individual component (IVR, ACD, Speech Recognition) on its own and often results in a disjointed customer experience that, when evaluated individually, may meet performance requirements for the use case. However, when evaluated end-to-end, can result in decreased quality of experience for your contacts while funneling development efforts into operational silos. This approach complicates regression testing, increases time to market, and limits the development of cross-discipline operational resources critical to the success of your contact center.

A holistic view of the contact center is shown in the following diagram:

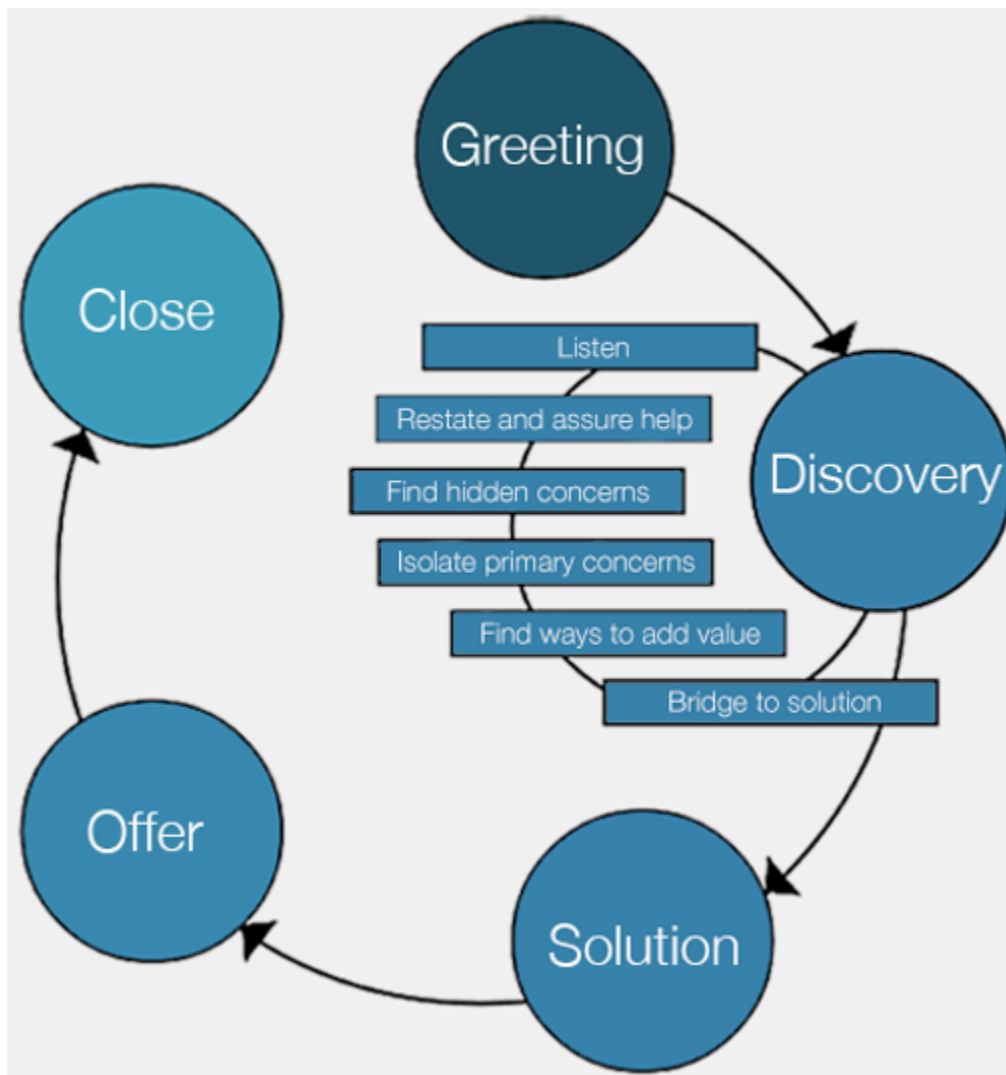

The holistic approach results focus on a more complete and cohesive experience for customers, and not which technology will provide which part of that experience.

Let the customer and what they want define and guide your efforts. The experiences that you create for your contacts should not be static or an end state, but should serve as a starting point that should be iterated on continuously based on customer feedback. The regular collection and review of operational and tuning data surrounding how your contacts are interacting and navigating throughout their journey should drive that iteration. Your goal should be dynamic and personalized experiences for contacts reaching your company. This can be accomplished through dynamic data-driven contact design and routing, resulting in an experience that conforms to your contact and their individual needs.

You can start with the default experience, building out your flows, but refactoring your single flow into two to enable future segmentation:

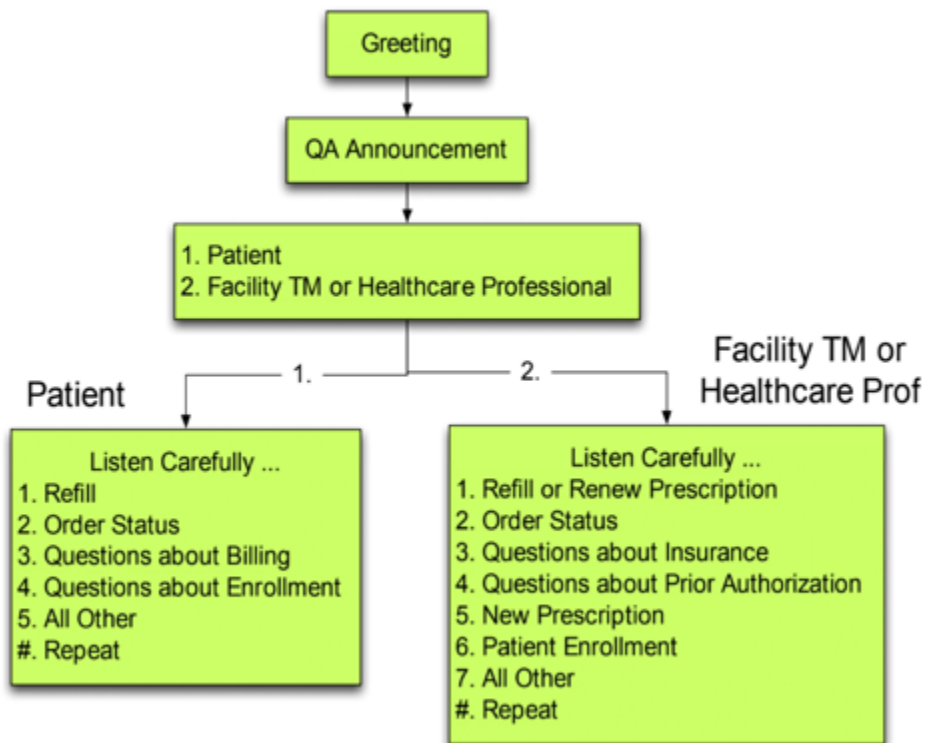

In your next iteration, identify additional experiences that you need to plan for and build routing and, if necessary, flows for each. For example, you may want to play different prompts for a contact that is past due on their bill or that may have tried to contact multiple times for the same purpose. With this approach, you are working towards personalized, dynamic experiences that are pertinent to your contacts and why they are contacting you. In addition to improving the quality of experience for your contacts and decreasing handle times, you're encouraging contact self-service by providing a more intelligent and flexible experience. Your next iteration may look like the following illustration:

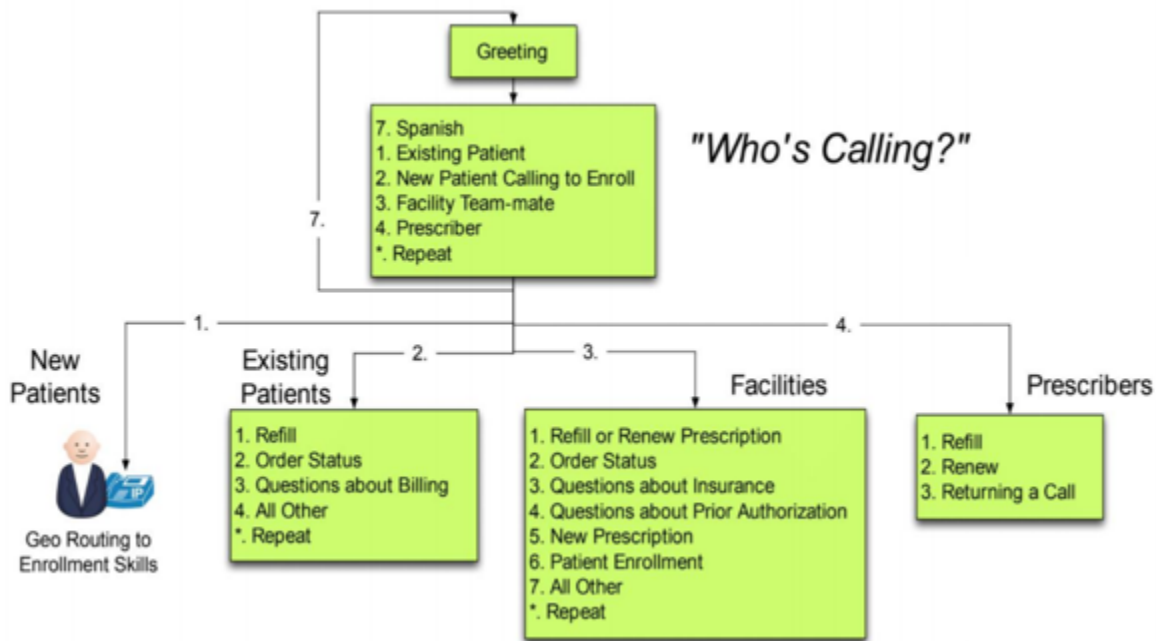

Flow design

A flow defines the customer experience with your contact center from start to finish. Your flow configuration can have a direct impact on performance, operational efficiency, and ease of maintenance.

Many Large businesses support multiple phone numbers, business units, prompts, queues, and other Amazon Connect resources. While it is possible to have unique flows for each phone number and line of business, it can lead to a one-to-one mapping of phone numbers and flows. This results in unnecessary service quota requests and a large number of flows to support and maintain. A one-to-one mapping of DNIS and Flow implementation is illustrated in the following figure:

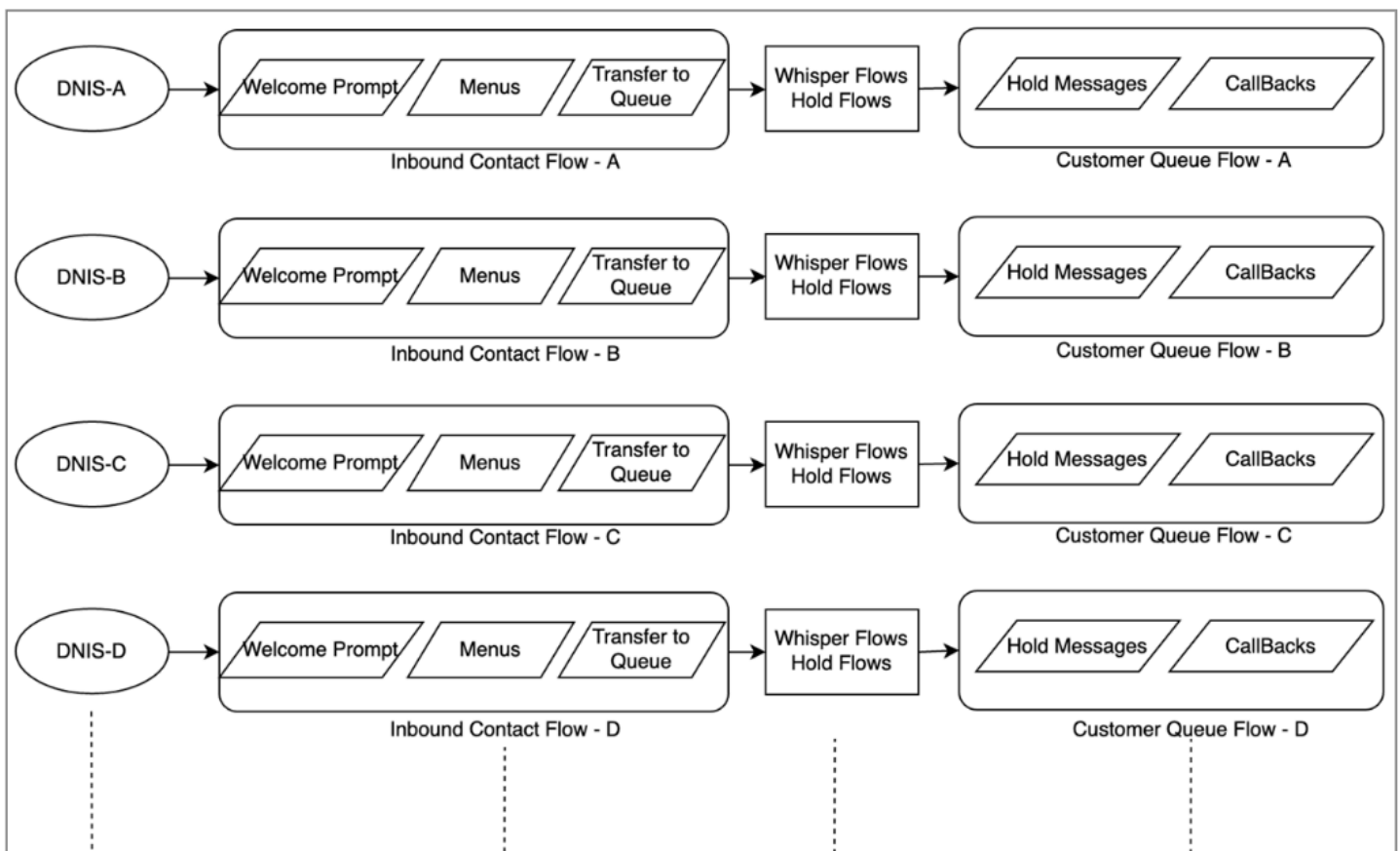

Alternatively, you should consider an approach that results in Multiple DNIS to one or few flows by using the dynamic nature of Amazon Connect Flows. With this approach, you can store configuration information like Prompts, Queues, Business Hours, Whisper Prompts/Flows, Queues, Queue Treatments and Hold Messages etc., in NoSQL Database DynamoDB. In Amazon Connect, you can associate multiple phone numbers to the same flow and use the Lambda function to look up configurations for that phone number. This allows you to dynamically define the contact's experience based on the attributes returned from DynamoDB.

For example, you can play prompts or use Text-to-Speech (TTS) to greet callers based upon the lookups in DynamoDB or associate queues using dynamic attributes supported in flow blocks. The result with this approach is a flow implementation that is efficient to build, maintain, and support:

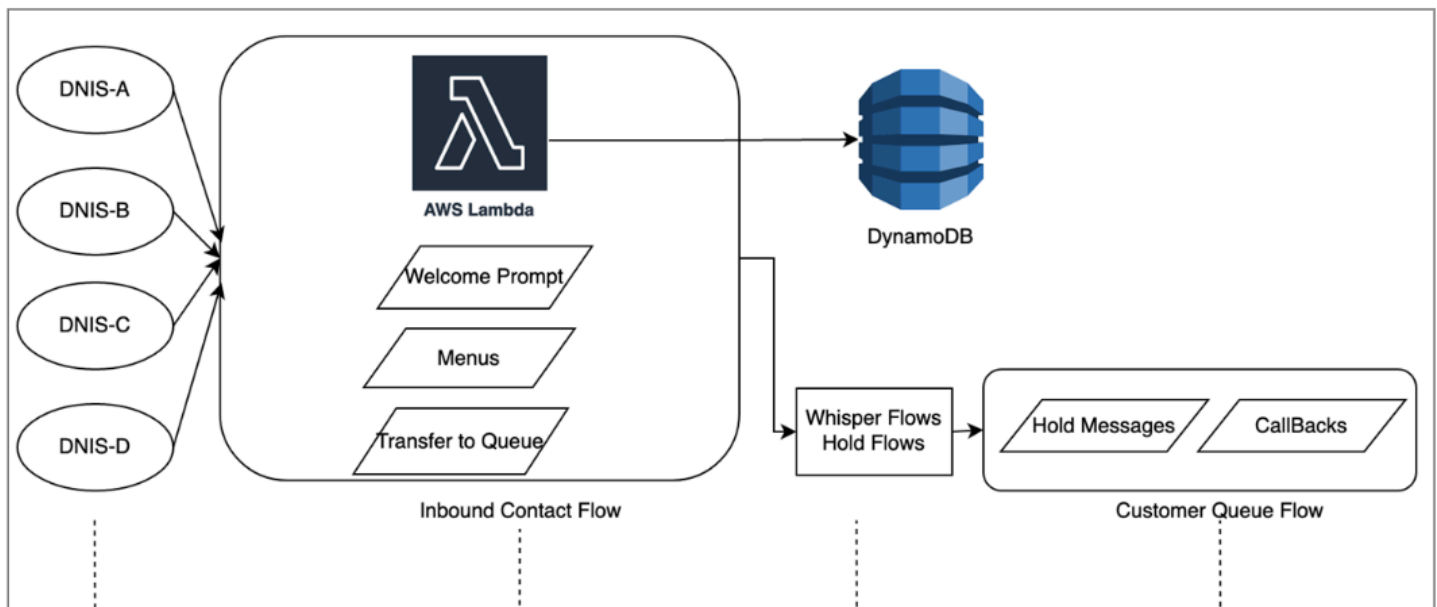

Load testing

If you need to run load or scale testing, you can employ third-party or partner solutions to run load tests, or develop your own custom solution using the Amazon Connect [StartOutboundVoiceContact](#) API to generate calls combined with browser automation scripts to simulate agent behavior. Before performing load tests, review and follow the [Amazon Connect Load Testing Policy](#).

Agent enablement

Amazon Connect provides a readily available browser-based Contact Control Panel (CCP) for agents to interact with customer contacts. Your agents use the CCP to accept contacts, chat with contacts, transfer them to other agents, put them on hold, and perform other key tasks. You can realize significant performance efficiency through the creation of custom agent desktop solutions using the [Amazon Connect Streams](#) API. Consider using the Streams API to increase performance efficiency in the following areas:

- CRM integration - The Streams API allows you to embed the CCP in your CRM application, create your own interface, or integrate with other AWS services and partner solutions to provide your agents with the tools and resources they need to service your contacts. With a custom desktop, like the Amazon Connect and [Salesforce integration](#), your agents can get a comprehensive view of customer and contact in a single interface without managing multiple screens and interfaces.

- **Authentication** - You can configure SAML for identity management in Amazon Connect and use IAM Identity Center (SSO) to allow your agents to use the same credentials they use to access your other systems and avoid the need to enter them multiple times.
- **Agent automation** - In addition to streamlining your agent experience, you can automate common, repeatable tasks. For example, automatically creating cases or pre-filling webforms and offering a screen pop with relevant information when a contact is offered. This can reduce handle times and improve the quality of experience for your agents and contacts.
- **Enhanced capabilities** - You can also enhance/extend the CCP functionality to include real-time [Transcriptions, Translations, Suggested Actions and Knowledge base integrations](#). Integrating enhanced capabilities with your agent desktop will allow skilled agents to service contacts more efficiently and unskilled agents to provide service when skilled agents aren't available. For example, you can use this approach to automatically translate a chat contact for unskilled agent that doesn't know the language. When your agent replies, you can automatically translate the text to the contact's language, allowing for real-time bilingual communication.

Using other AWS services

This section discusses AWS services that you can use to improve performance, identify areas of opportunity, and gain valuable insights into your contact data.

AWS Lambda

You can use AWS Lambda in your Amazon Connect Flows to perform data dips for customer information, send SMS text messages, and with other services like Amazon S3 to automatically distribute scheduled reports. For more information, see [Best Practices for Working with AWS Lambda functions](#).

AWS Direct Connect

AWS Direct Connect is a cloud service solution that makes it more efficient to establish a dedicated network connection from your premises to AWS. It provides a durable, consistent connection rather than relying on your ISP to dynamically route requests to AWS resources. It allows you to configure your edge router to redirect AWS traffic across dedicated fiber rather than traversing the public WAN and establish private connectivity between AWS and your data center, office, or colocation environment. In many cases, this can reduce your network costs, increase bandwidth throughput, and provide a more consistent network experience than Internet-based connections.

While AWS Direct Connect does not solve issues specific to private LAN/WAN traversal to your edge router, it can help solve for latency and connectivity issues between your edge router and AWS resources. It can also solve for latency and poor call quality between your edge router and AWS resources.

Depending on your VDI environment, you may not be able to take advantage of AWS Direct Connect as it requires you to configure your edge router to redirect AWS traffic across dedicated fiber rather than traversing the public WAN. If the VDI environment is hosted outside of your local DXC-enabled network, you may not be able to take full advantage of AWS Direct Connect.

Do not use AWS Direct Connect for "QoS" or "increased security." AWS Direct Connect can cause performance degradation in cases where the latency from the agent workstation is higher than the ISP's path to the Amazon Connect instance. AWS Direct Connect does not offer additional security when compared to an ISP as Amazon Connect voice and data is already encrypted.

Amazon Polly

Amazon Connect offers a native integration with Amazon Polly, allowing you to play dynamic and natural Text-to-Speech (TTS), use Speech Synthesis Markup Language (SSML), and take advantage of Neural Text-to-Speech (NTTS) to achieve the most natural and human-like text-to-speech voices possible.

Amazon Lex

Your contact's path to service can be a challenging experience that doesn't always meet up to their expectations. Your contacts may wait on hold, repeat information, need to be transferred, and ultimately, spend too much time getting what they need. AI is playing a role in improving this customer experience in call centers to include engagement through chatbots — intelligent, natural language virtual assistants. These chatbots are able to recognize human speech and understand the caller's intent without requiring the caller to speak in specific phrases. Contacts can perform tasks such as changing a password, requesting a balance on an account, or scheduling an appointment without ever speaking to an agent.

Amazon Lex is a service that allows you to create intelligent conversational chatbots. It lets you turn your Amazon Connect contact center flows into natural conversations that provide personalized experiences for your callers. Using the same technology that powers Amazon Alexa, an Amazon Lex chatbot can be attached to your Amazon Connect Flow to recognize the intent of your caller, ask follow-up questions, and provide answers. Amazon Lex maintains context and manages the dialogue, dynamically adjusting the responses based on the conversation, so your

contact center can perform common tasks for callers, to address many customer inquiries through self-service interactions. Additionally, Amazon Lex chatbots support an optimal (8 kHz) telephony audio sampling rate, to provide increased speech recognition accuracy and fidelity for your contact center voice interactions.

Building an effective Amazon Lex bot requires providing simple and realistic utterances as training sets to the bot, periodically reviewing your bot's performance, updating your utterance set, and modifying the bot based on such a review. For more information, see the following resources:

- [Monitoring in Amazon Lex](#)
- [Building Better bots using Amazon Lex](#)

Amazon Kinesis

For situations where you need to gain additional insight from your contact metrics and real-time data from Amazon Connect, you can:

- Export your contact record data to Amazon Redshift using Amazon Kinesis.
- Use Amazon Kinesis video stream (KVS) and AWS Lambda to transcribe call recordings or voice contacts in real-time using Amazon Transcribe and send the resulting text to Amazon Comprehend for sentiment analysis.
- Leverage the [Amazon Connect Agent Event Kinesis Stream](#) for real-time agent CTI and schedule adherence data.

Amazon OpenSearch Service and Kibana

Using Amazon OpenSearch Service and Kibana to process real-time Amazon Connect data gives you a flexible way to query and visualize real-time and historical Amazon Connect data beyond native reporting capabilities.

Amazon Connect Contact Lens

Contact Lens for Amazon Connect is a set of machine learning (ML) capabilities integrated into Amazon Connect that allow contact center supervisors to better understand the sentiment, trends, and compliance risks of customer conversations to effectively train agents, replicate successful interactions, and identify crucial company and product feedback. Contact Lens for Amazon Connect transcribes contact center calls to create a fully searchable archive and surface valuable customer insights.

Resources

Documentation

- [Best practices design patterns: optimizing Amazon S3 performance](#)
- [Amazon EBS volume performance on Linux instances](#)

Whitepaper

- [Performance Efficiency Pillar](#)

Video

- [AWS re:Invent 2016: Scaling Up to Your First 10 Million Users \(ARC201\)](#)
- [AWS re:Invent 2017: Deep Dive on Amazon EC2 Instances](#)

Cost optimization

Cost Optimization includes the ability to run systems to deliver business value at the lowest price point. This section provides an overview of design principles, best practices, and questions surrounding cost optimization for Amazon Connect workloads. You can find prescriptive guidance on implementation in the Cost Optimization Pillar whitepaper.

There are five areas to consider for cost optimization for Amazon Connect workloads.

Region selection

Amazon Connect Region selection is one of the first decision customers make when adopting Amazon Connect for their contact center workloads. While latency and voice quality are important aspects to Region selection, you should evaluate Region selection from a cost perspective as well. Telephony pricing for Claimed Phone Numbers Per Day and Per Minute Inbound Usage can be different for countries depending upon the AWS Region in which you select to instantiate your Amazon Connect Instance. You can find telephony price for each Region at [Amazon Connect Pricing](#) page.

Callbacks

You can provide a callback in your flow for callers during high call volume periods or long wait times. You can use callbacks to reduce cost and improve the quality of experience for your contacts.

When your contact opts-in for the callback, Amazon Connect will retain the position in the queue and allow the caller to disconnect. When an agent becomes available to service your contact, Amazon Connect will place an outbound call to the number configured to connect the contact to your agent. A sample callback flow is included in every instance at creation. You can also use AWS Lambda and Amazon DynamoDB to prevent duplicate callback requests.

Storage

With Amazon Connect, you can configure your instance and flows to store call recordings and chat transcripts of caller's interactions for compliance, quality monitoring, and training purposes. Voice contacts are not recorded unless an agent is connected to the caller. If multiple agents are connected, each will have an associated call recording or transcript. Amazon Connect stores voice recordings in Amazon S3 according to your Amazon S3 Lifecycle policy configuration. With the call recordings stored in Amazon S3, you can use Amazon S3 tiers of storage to manage retention and optimize cost. For example, you can transition objects using Amazon S3 Lifecycle to move call recordings and transcripts over three months old to S3 Glacier to reduce storage cost.

Self-service

Amazon Connect's pay-as-you-go pricing model can result in lower costs as compared to traditional licensing-based contact centers. However, the traditional contact center infrastructure that spans automatic call distribution (ACD) systems, IVR, telephony and work force management (WFM) systems plays a proportionately small contribution to the overall cost of contact center operations. The largest contributor to the cost of the contact center often comes from human capital and the real estate required to provide an operating environment for your agents. Amazon Connect Flows can be used natively with Amazon Lex for NLU, NLP, and ASR and Amazon Polly for lifelike Text-to-Speech (TTS) to build highly engaging user experiences and natural conversational interactions across voice and text. By using an Amazon Lex chatbot in your Amazon Connect call center, callers can perform tasks such as changing a password, requesting a balance on an account, or scheduling an appointment, without needing to speak to an agent. These self-service options result in better customer experience and lowers your cost per contact.

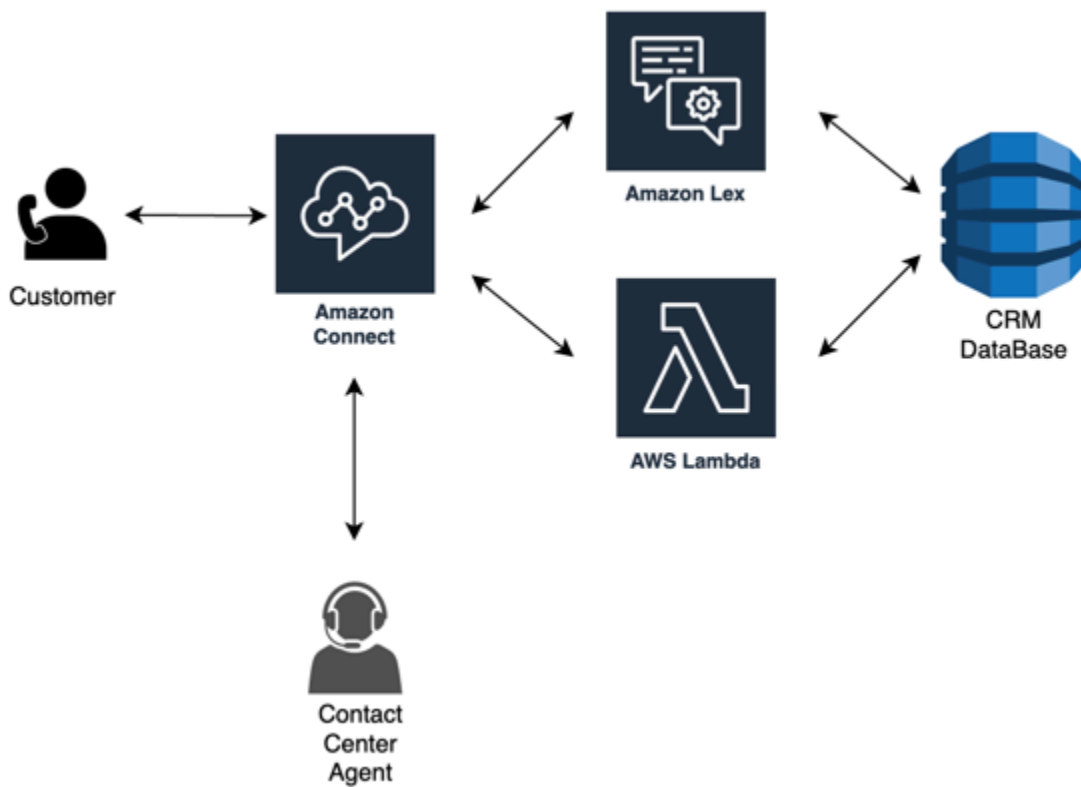

Click-to-call

You can use click-to-call in Amazon Connect to initiate a voice call using the [StartOutboundVoiceContact](#) API for authentication through web or mobile application to reduce call handle times and improve the quality of experience. With this approach, you're able to offer your contact the ability to bypass IVR authentication, pass contextual information like URLs, recent web/mobile activity, and user data to your flows to create dynamic, personalized experiences. For example, a contact browsing your website to purchase an item or member of a financial institution who is already authenticated in the mobile app and wants to speak with an agent about a recent transaction.

Redirect voice contacts to chat

With Amazon Connect, you can allow agents to handle multiple chat conversations simultaneously where they would only be able to handle one voice conversation. When you don't have a voice agent available, you can send an SMS text message to your customer to offer a link to chat with an agent right away.

Resources

Documentation

- [Analyzing Your Costs with Cost Explorer](#)
- [AWS Cloud Economics Center](#)
- [What are AWS Cost and Usage Reports](#)

Whitepaper

- [Cost Optimization Pillar](#)

Plan your identity management in Amazon Connect

Before you [set up your Amazon Connect instance](#), you should decide how you want to manage your Amazon Connect users. A user is anyone who needs an Amazon Connect account: agents, call center managers, analysts, and more.

You cannot change the option you select for identity management after you create an instance. Instead, you must delete the instance and create a new one. However, if you delete an instance, you lose its configuration settings and metrics data.

When you create your instance, you can choose from one of the following identity management solutions:

- **Store users with Amazon Connect**—Choose this option if you want to create and manage user accounts within Amazon Connect.

When you manage users in Amazon Connect, the user name and password for each user is specific to Amazon Connect. Users must remember a separate user name and password to log in to Amazon Connect.

- **Link to an existing directory**—Choose this option to use an existing Active Directory. Users will log in to Amazon Connect using their corporate credentials.

If you choose this option, the directory must be associated with your account, set up in AWS Directory Service, and be active in the same Region in which you create your instance. If you plan to choose this option, you should prepare your directory before you create your Amazon Connect instance. For more information, see [Use an existing directory for identity management](#).

- **SAML 2.0-based authentication**—Choose this option if you want to use your existing network identity provider to federate users with Amazon Connect. Users can only log in to Amazon Connect by using the link configured through your identity provider. If you plan to choose

this option, you should configure your environment for SAML before you create your Amazon Connect instance. For more information, see [Configure SAML with IAM for Amazon Connect](#).

Use an existing directory for identity management

If you are already using a AWS Directory Service directory to manage users, you can use the same directory to manage user accounts in Amazon Connect. You can also create a new directory in AWS Directory Service to use for Amazon Connect. The directory you choose must be associated with your AWS account, and must be active in the AWS Region in which you create your instance. You can associate an AWS Directory Service directory with only one Amazon Connect instance at a time. To use the directory with a different instance, you must delete the instance with which it is already associated.

The following AWS Directory Service directories are supported in Amazon Connect:

- [Microsoft Active Directory](#)—AWS Directory Service lets you run Microsoft Active Directory as a managed service.
- [Active Directory Connector](#)—AD Connector is a directory gateway you can use to redirect directory requests to your on-premises Microsoft Active Directory.
- [Simple Active Directory](#)—Simple AD is a standalone managed directory that is powered by a Samba 4 Active Directory compatible server.

You cannot change the identity option you select after you create the instance. If you decide to change the directory you selected, you can delete the instance and create a new one. When you delete an instance, you lose all configuration settings and metrics data for it.

There is no additional charge for using an existing or a proprietary directory in Amazon Connect. For information about the costs associated with using AWS Directory Service, see [AWS Directory Service Pricing Overview](#).

The following limitations apply to all new directories created using AWS Directory Service:

- Directories can only have alphanumeric names. Only the '.' character can be used.
- Directories cannot be unbound from an Amazon Connect instance after they have been associated.
- Only one directory can be added to an Amazon Connect instance.
- Directories cannot be shared across multiple Amazon Connect instances.

Configure SAML with IAM for Amazon Connect

Amazon Connect supports identity federation by configuring Security Assertion Markup Language (SAML) 2.0 with AWS IAM to enable web-based single sign-on (SSO) from your organization to your Amazon Connect instance. This allows your users to sign in to a portal in your organization hosted by a SAML 2.0 compatible identity provider (IdP) and log in to an Amazon Connect instance with a single sign-on experience without having to provide separate credentials for Amazon Connect.

Important notes

Before you begin, note the following:

- These instructions do not apply to Amazon Connect Global Resiliency deployments. For information that applies to Amazon Connect Global Resiliency, see [Integrate your identity provider \(IdP\) with an Amazon Connect Global Resiliency SAML sign in endpoint](#).
- Choosing SAML 2.0-based authentication as the identity management method for your Amazon Connect instance requires the configuration of [AWS Identity and Access Management federation](#).
- The user name in Amazon Connect must match the RoleSessionName SAML attribute specified in the SAML response returned by the identity provider.
- Amazon Connect does not support reverse federation. That is, you can't login directly into Amazon Connect. If you tried, you'd get a *Session Expired* message. The authentication should be done from the Identity Provider (IdP) and not the Service Provider (SP) (Amazon Connect).
- Most identity providers by default use the global AWS sign-in endpoint as the Application Consumer Service (ACS), which is hosted in US East (N. Virginia). We recommend overriding this value to use the regional endpoint that matches the AWS Region where your instance was created.
- All Amazon Connect usernames are case sensitive, even when using SAML.
- If you have old Amazon Connect instances that were set up with SAML and you need to update your Amazon Connect domain, see [Personal settings](#).

Overview of using SAML with Amazon Connect

The following diagram shows the order in which steps take place for SAML requests to authenticate users and federate with Amazon Connect. It is not a flow diagram for a threat model.

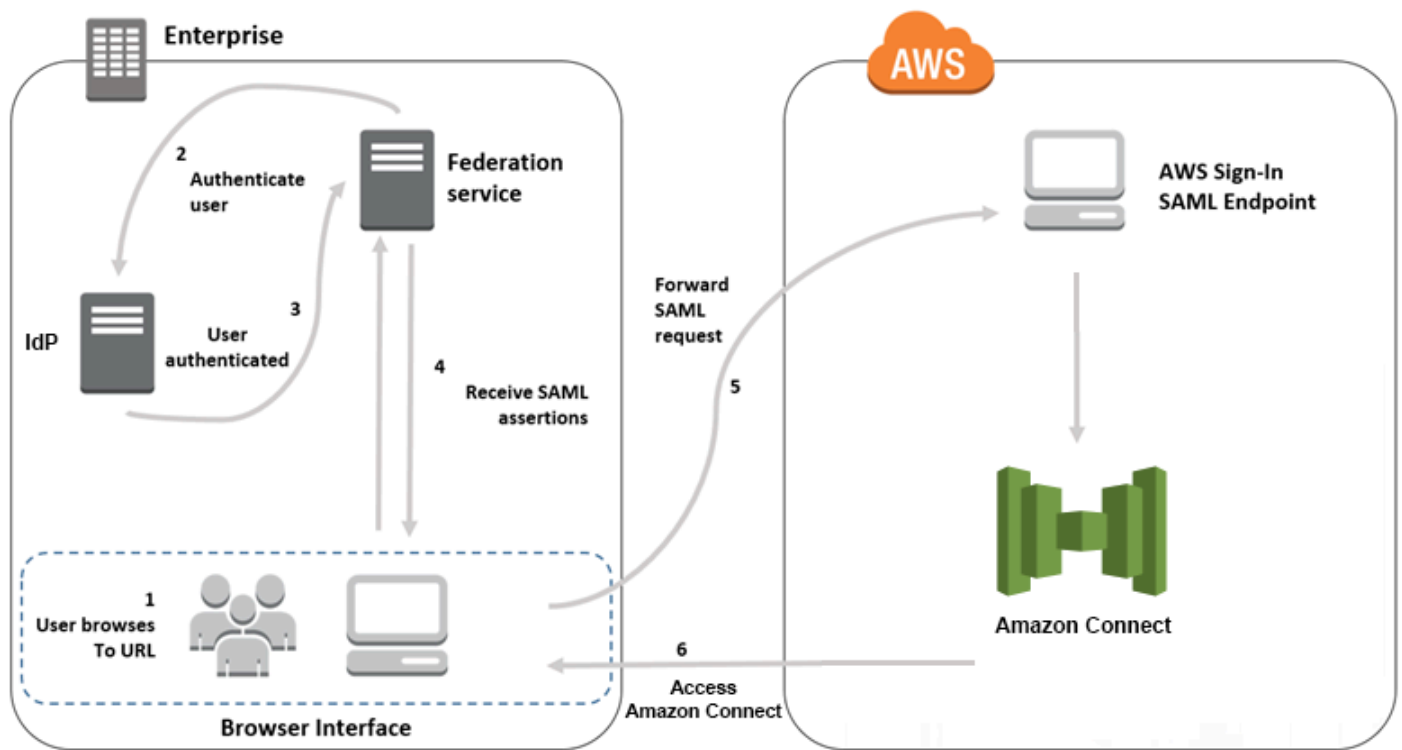

SAML requests go through the following steps:

1. The user browses to an internal portal that includes a link to log in to Amazon Connect. The link is defined in the identity provider.
2. The federation service requests authentication from the organization's identity store.
3. The identity store authenticates the user and returns the authentication response to the federation service.
4. When authentication is successful, the federation service posts the SAML assertion to the user's browser.
5. The user's browser posts the SAML assertion to the AWS sign in SAML endpoint (<https://signin.aws.amazon.com/saml>). AWS sign in receives the SAML request, processes the request, authenticates the user, and initiates a browser redirect to the Amazon Connect endpoint with the authentication token.
6. Using the authentication token from AWS, Amazon Connect authorizes the user and opens Amazon Connect in their browser.

Enabling SAML-based authentication for Amazon Connect

The following steps are required to enable and configure SAML authentication for use with your Amazon Connect instance:

1. Create an Amazon Connect instance and select SAML 2.0-based authentication for identity management.
2. Enable SAML federation between your identity provider and AWS.
3. Add Amazon Connect users to your Amazon Connect instance. Log in to your instance using the administrator account created when you created your instance. Go to the **User Management** page and add users.

⚠ Important

- For a list of allowed characters in user names, see the documentation for the Username property in the [CreateUser](#) action.
- Due to the association of an Amazon Connect user and an AWS IAM Role, the user name must match exactly the RoleSessionName as configured with your AWS IAM federation integration, which typically ends up being the user name in your directory. The format of the username should match the intersection of the format conditions of the [RoleSessionName](#) and an [Amazon Connect user](#), as shown in the following diagram:



4. Configure your identity provider for the SAML assertions, authentication response, and relay state. Users log in to your identity provider. When successful, they are redirected to your Amazon Connect instance. The IAM role is used to federate with AWS, which allows access to Amazon Connect.

Select SAML 2.0-based authentication during instance creation

When you are creating your Amazon Connect instance, select the SAML 2.0-based authentication option for identity management. On the second step, when you create the administrator for the instance, the user name that you specify must exactly match a user name in your existing network directory. There is no option to specify a password for the administrator because passwords are managed through your existing directory. The administrator is created in Amazon Connect and assigned the **Admin** security profile.

You can log in to your Amazon Connect instance, through your IdP, using the administrator account to add additional users.

Enable SAML federation between your identity provider and AWS

To enable SAML-based authentication for Amazon Connect, you must create an identity provider in the IAM console. For more information, see [Enabling SAML 2.0 Federated Users to Access the AWS Management Console](#).

The process to create an identity provider for AWS is the same for Amazon Connect. Step 6 in the above flow diagram shows the client is sent to your Amazon Connect instance instead of the AWS Management Console.

The steps necessary to enable SAML federation with AWS include:

1. Create a SAML provider in AWS. For more information, see [Creating SAML Identity Providers](#).
2. Create an IAM role for SAML 2.0 federation with the AWS Management Console. Create only one role for federation (only one role is needed and used for federation). The IAM role determines which permissions the users that log in through your identity provider have in AWS. In this case, the permissions are for accessing Amazon Connect. You can control the permissions to features of Amazon Connect by using security profiles in Amazon Connect. For more information, see [Creating a Role for SAML 2.0 Federation \(Console\)](#).

In step 5, choose **Allow programmatic and AWS Management Console access**. Create the trust policy described in the topic in the procedure *To prepare to create a role for SAML 2.0 federation*. Then create a policy to assign permissions to your Amazon Connect instance. Permissions start on step 9 of the *To create a role for SAML-based federation* procedure.

To create a policy for assigning permissions to the IAM role for SAML federation

1. On the **Attach permissions policy** page, choose **Create policy**.

2. On the **Create policy** page, choose **JSON**.
3. Copy one of the following example policies and paste it into the JSON policy editor, replacing any existing text. You can use either policy to enable SAML federation, or customize them for your specific requirements.

Use this policy to enable federation for all users in a specific Amazon Connect instance. For SAML-based authentication, replace the value for the Resource to the ARN for the instance that you created:

```
{
  "Version": "2012-10-17",
  "Statement": [
    {
      "Sid": "Statement1",
      "Effect": "Allow",
      "Action": "connect:GetFederationToken",
      "Resource": [
        "arn:aws:connect:us-
east-1:361814831152:instance/2fb42df9-78a2-2e74-d572-c8af67ed289b/user/
${aws:userid}"
      ]
    }
  ]
}
```

Use this policy to enable federation to a specific Amazon Connect instances. Replace the value for the `connect:InstanceId` to the instance ID for your instance.

```
{
  "Version": "2012-10-17",
  "Statement": [
    {
      "Sid": "Statement2",
      "Effect": "Allow",
      "Action": "connect:GetFederationToken",
      "Resource": "*",
      "Condition": {
        "StringEquals": {
          "connect:InstanceId": "2fb42df9-78a2-2e74-d572-c8af67ed289b"
        }
      }
    }
  ]
}
```

```

    }
  ]
}

```

Use this policy to enable federation for multiple instances. Note the brackets around the listed instance IDs.

```

{
  "Version": "2012-10-17",
  "Statement": [
    {
      "Sid": "Statement2",
      "Effect": "Allow",
      "Action": "connect:GetFederationToken",
      "Resource": "*",
      "Condition": {
        "StringEquals": {
          "connect:InstanceId": [
            "2fb42df9-78a2-2e74-d572-c8af67ed289b",
            "1234567-78a2-2e74-d572-c8af67ed289b"
          ]
        }
      }
    }
  ]
}

```

4. After you create the policy, choose **Next: Review**. Then return to step 10 in the *To create a role for SAML-based federation* procedure in the [Creating a Role for SAML 2.0 Federation \(Console\)](#) topic.
3. Configure your network as a SAML provider for AWS. For more information, see [Enabling SAML 2.0 Federated Users to Access the AWS Management Console](#).
4. Configure SAML Assertions for the Authentication Response. For more information, [Configuring SAML Assertions for the Authentication Response](#).
5. For Amazon Connect, leave the **Application Start URL** blank.
6. Override the Application Consumer Service (ACS) URL in your identity provider to use the regional endpoint that coincides with the AWS Region of your Amazon Connect instance. For more information, see [Configure the identity provider to use regional SAML endpoints](#).
7. Configure the relay state of your identity provider to point to your Amazon Connect instance. The URL to use for the relay state is comprised as follows:

`https://region-id.console.aws.amazon.com/connect/federate/instance-id`

Replace the *region-id* with the Region name where you created your Amazon Connect instance, such as us-east-1 for US East (N. Virginia). Replace the *instance-id* with the instance ID for your instance.

For a GovCloud instance, the URL is **`https://console.amazonaws-us-gov.com/`**:

- `https://console.amazonaws-us-gov.com/connect/federate/instance-id`

Note

You can find the instance ID for your instance by choosing the instance alias in the Amazon Connect console. The instance ID is the set of numbers and letters after '/' instance' in the **Instance ARN** displayed on the **Overview** page. For example, the instance ID in the following Instance ARN is `178c75e4-b3de-4839-a6aa-e321ab3f3770`.
`arn:aws:connect:us-east-1:450725743157:instance/178c75e4-b3de-4839-a6aa-e321ab3f3770`

Configure the identity provider to use regional SAML endpoints

To provide the best availability we recommend using the regional SAML endpoint that coincides with your Amazon Connect instance instead of the default global endpoint.

The following steps are IdP agnostic; they work for any SAML IdP (for example, Okta, Ping, OneLogin, Shibboleth, ADFS, AzureAD, and more).

1. Update (or override) the Assertion Consumer Service (ACS) URL. There are two ways you can do this:
 - **Option 1:** Download the AWS SAML metadata and update the Location attribute to the Region of your choice. Load this new version of the AWS SAML metadata into your IdP.

Following is an example of a revision:

```
<AssertionConsumerService index="1" isDefault="true"
Binding="urn:oasis:names:tc:SAML:2.0:bindings:HTTP-POST"
Location="https://region-id.signin.aws.amazon.com/saml"/>
```

- **Option 2:** Override the AssertionConsumerService (ACS) URL in your IdP. For IdPs like Okta that provide prebaked AWS integrations, you can override the ACS URL in the AWS admin console. Use the same format to override to a Region of your choice (for example, `https://region-id.signin.aws.amazon.com/saml`).
2. Update the associated role trust policy:
 - a. This step needs to be done for every role in every account that trusts the given identity provider.
 - b. Edit the trust relationship, and replace the singular SAML : aud condition with a multivalued condition. For example:
 - Default: "SAML : aud": "https://signin.aws.amazon.com/saml".
 - With modifications: "SAML : aud": ["https://signin.aws.amazon.com/saml", "https://*region-id*.signin.aws.amazon.com/saml"]
 - c. Make these changes to the trust relationships in advance. They should not be done as part of a plan during an incident.
 3. Configure a relay state for the Region-specific console page.
 - a. If you don't do this final step, there's no guarantee that the Region-specific SAML sign in process will forward the user to the console sign in page within the same Region. This step is most varied per identity provider, but there are a blogs (for example, [How to Use SAML to Automatically Direct Federated Users to a Specific AWS Management Console Page](#)) that show the use of relay state to achieve deep linking.
 - b. Using the technique/parameters appropriate for your IdP, set the relay state to the console endpoint that matches (for example, `https://region-id.console.aws.amazon.com/connect/federate/instance-id`).

Note

- Ensure that STS is not disabled in your additional Regions.
- Ensure no SCPs are preventing STS actions in your additional Regions.

Use a destination in your relay state URL

When you configure the relay state for your identity provider, you can use the destination argument in the URL to navigate users to a specific page in your Amazon Connect instance. For example, use a link to open the CCP directly when an agent logs in. The user must be assigned a security profile that grants access to that page in the instance. For example, to send agents to the CCP, use a URL similar to the following for the relay state. You must use [URL encoding](#) for the destination value used in the URL:

- `https://us-east-1.console.aws.amazon.com/connect/federate/instance-id?destination=%2Fccp-v2%2Fchat&new_domain=true`

Another example of a valid URL is:

- `https://us-east-1.console.aws.amazon.com/connect/federate/instance-id?destination=%2Fagent-app-v2`

For a GovCloud instance, the URL is <https://console.amazonaws-us-gov.com/>. So the address would be:

- `https://console.amazonaws-us-gov.com/connect/federate/instance-id?destination=%2Fccp-v2%2Fchat&new_domain=true`

If you want to configure the destination argument to a URL outside of the Amazon Connect instance, such as your own custom website, first add that external domain to the account's approved origins. For example, perform the steps in the following order:

1. In the Amazon Connect console add `https://your-custom-website.com` to your approved origins. For instructions, see [Use an allowlist for integrated applications](#).
2. In your identity provider configure your relay state to `https://your-region.console.aws.amazon.com/connect/federate/instance-id?destination=https%3A%2F%2Fyour-custom-website.com`
3. When your agents log in they are taken directly to `https://your-custom-website.com`.

Add users to your Amazon Connect instance

Add users to your connect instance, making sure that the user names exactly match the users names in your existing directory. If the names do not match, users can log in to the identity provider, but not to Amazon Connect because no user account with that user name exists in Amazon Connect. You can add users manually on the **User management** page, or you can bulk upload users with the CSV template. After you add the users to Amazon Connect, you can assign security profiles and other user settings.

When a user logs in to the identity provider, but no account with the same user name is found in Amazon Connect, the following **Access denied** message is displayed.

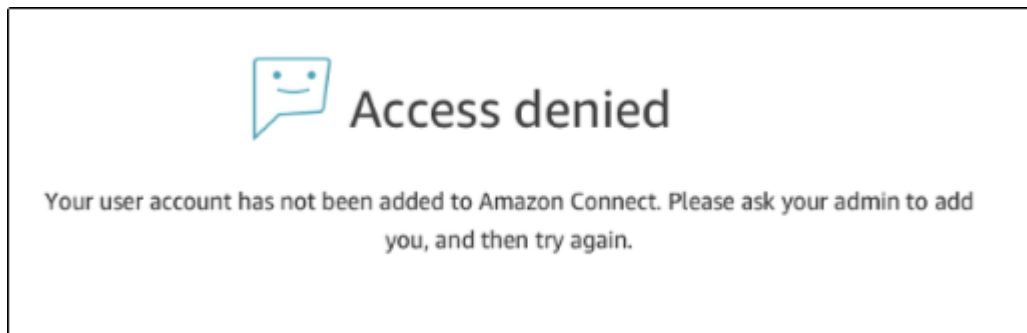

Bulk upload users with the template

You can import your users by adding them to a CSV file. You can then import the CSV file to your instance, which adds all users in the file. If you add users by uploading a CSV file, make sure that you use the template for SAML users. You can find on the **User management** page in Amazon Connect. A different template is used for SAML-based authentication. If you previously downloaded the template, you should download the version available on the **User management** page after you set up your instance with SAML-based authentication. The template should not include a column for email or password.

SAML user logging in and session duration

When you use SAML in Amazon Connect, users must log in to Amazon Connect through your identity provider (IdP). Your IdP is configured to integrate with AWS. After authentication, a token for their session is created. The user is then redirected to your Amazon Connect instance and automatically logged in to Amazon Connect using single sign-on.

As a best practice, you should also define a process for your Amazon Connect users to log out when they are finished using Amazon Connect. They should log out from both Amazon Connect and your

identity provider. If they do not, the next person that logs in to the same computer can log in to Amazon Connect without a password since the token for the previous sessions is still valid for the duration of the session. It's valid for 12 hours.

About session expiration

Amazon Connect sessions expire 12 hours after a user logs in. After 12 hours, users are automatically logged out, even if they are currently on a call. If your agents stay logged in for more than 12 hours, they need to refresh the session token before it expires. To create a new session, agents need to log out of Amazon Connect and your IdP and then log in again. This resets the session timer set on the token so that agents are not logged out during an active contact with a customer. When a session expires while a user is logged in, the following message is displayed. To use Amazon Connect again, the user needs to log in to your identity provider.



Session expired

Your session has expired. Please log in again to continue. Sessions expire after 12 hours.

Note

If you see the **Session expired** message while logging in, you probably just need to refresh the session token. Go to your identity provider and log in. Refresh the Amazon Connect page. If you still get this message, contact your IT team.

Troubleshoot SAML with Amazon Connect

This article explains how to troubleshoot and resolve some of the most common issues customers encounter when using SAML with Amazon Connect.

If you're troubleshooting your integration with other identity providers such as Okta, PingIdentify, Azure AD, and more, see [Amazon Connect SSO Setup Workshop](#).

Error Message: Access Denied. Your account has been authenticated, but has not been onboarded to this application.

Access denied

Your account has been authenticated, but has not been onboarded to this application. Contact your Administrator to onboard to Amazon Connect and try again.

What does this mean?

This error means that the user has successfully authenticated using SAML into the AWS SAML login endpoint. However, the user could not be matched/found inside Amazon Connect. This usually indicates one of the following:

- The username in Amazon Connect doesn't match the RoleSessionName SAML attribute specified in the SAML response returned by the identity provider.
- The user doesn't exist in Amazon Connect.
- The user has two separate profiles assigned to them with SSO.

Resolution

Use the following steps to check the RoleSessionName SAML attribute specified in the SAML response returned by the identity provider, and then retrieve and compare with the login name in Amazon Connect.

1. Perform a HAR capture (**HTTP AR**chive) for the end-to-end login process. This captures the network requests from the browser side. Save the HAR file with your preferred file name, for example, **saml.har**.

For instructions, see [How do I create a HAR file from my browser for an AWS Support case?](#)

2. Use a text editor to find the SAMLResponse in the HAR file. Or, run the following commands:

```
$ grep -o "SAMLResponse=.*&" azuresaml.har | sed -E 's/SAMLResponse=(.*)&/\1/' > samlresponse.txt
```

- This searches for the SAMLresponse in the HAR file and saves it to a **samlresponse.txt** file.
- The response is URL encoded and the contents are Base64 encoded.

3. Decode the URL response and then decode the Base64 contents using a third-party tool or a simple script. For example:

```
$ cat samlresponse.txt | python3 -c "import sys; from urllib.parse
import unquote; print(unquote(sys.stdin.read()));" | base64 --decode >
samlresponsedecoded.txt
```

This script uses a simple python command to decode the SAMLResponse from its original URL encoded format. Then it decodes the response from Base64 and outputs the SAML Response in plain text format.

4. Check the decoded response for the needed attribute. For example, the following image shows how to check RoleSessionName:

```
$ export username=`grep -Eo 'RoleSessionName.*?</AttributeValue>'
samlresponsedecoded.txt | sed -E 's/.*<AttributeValue>(.*?)</AttributeValue>/\1/'`
```

5. Check whether the username returned in from the previous step exists as a user in your Amazon Connect instance:

```
$ aws connect list-users --instance-id [INSTANCE_ID] | grep $username
```

- If the final grep does not return a result then this means that the user does not exist in your Amazon Connect instance or it has been created with a different case/capitalization.
- If your Amazon Connect instance has many users, the response from the ListUsers API call maybe paginated. Use the NextToken returned by the API to fetch the rest of the users. For more information, see [ListUsers](#).

Example SAML Response

Following is an image from a sample SAML Response. In this case, the identity provider (IdP) is Azure Active Directory (Azure AD).

```

name"><AttributeValue>jane-doe@examplecorp.com</AttributeValue></Attribute><Attribute
Name="https://aws.amazon.com/SAML/Attributes/Role"><AttributeValue>arn:aws:iam::111111111111
:role/AzureAD_Role,arn:aws:iam::111111111111:saml-
provider/AzureAD_Connect_Admin</AttributeValue></Attribute><Attribute
Name="https://aws.amazon.com/SAML/Attributes/RoleSessionName"><AttributeValue>jane.doe@ex
amplecorp.com</AttributeValue></Attribute><Attribute
Name="https://aws.amazon.com/SAML/Attributes/SessionDuration"><AttributeValue>900</AttributeV
alue></Attribute></AttributeStatement><AuthnStatement AuthnInstant="2020-03-17T04:31:42.838Z"
SessionIndex="_aaaaaaaa-bbbb-cccc-dddd-
eeeeeeeeeeee"><AuthnContext><AuthnContextClassRef>urn:oasis:names:tc:SAML:2.0:ac:classes:Passw
ord</AuthnContextClassRef></AuthnContext></AuthnStatement></Assertion></samlp:Response>

```

This is the returned
RoleSessionName

Error Message: Access denied, Please contact your AWS account administrator for assistance.

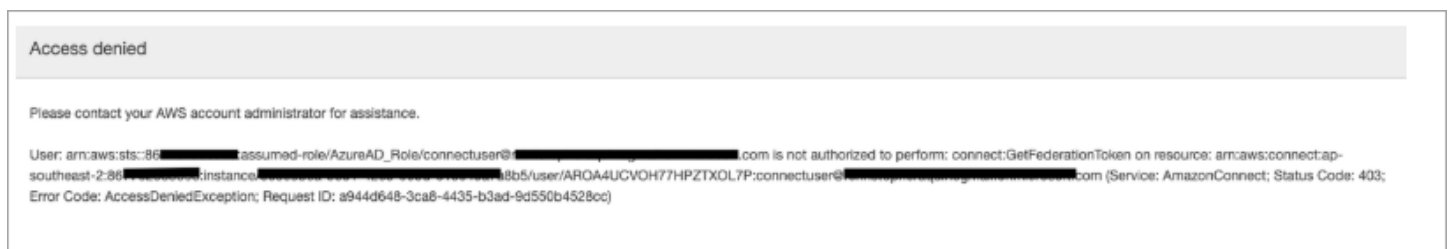

What does this mean?

The role that the user has assumed has successfully authenticated using SAML. However, the role doesn't have permission to call the `GetFederationToken` API for Amazon Connect. This call is required so the user can log in to your Amazon Connect instance using SAML.

Resolution

1. Attach a policy that has the permissions for `connect:GetFederationToken` to the role found in the error message. Following is a sample policy:

```

{
  "Version": "2012-10-17",
  "Statement": [{
    "Sid": "Statement1",
    "Effect": "Allow",
    "Action": "connect:GetFederationToken",
    "Resource": [
      "arn:aws:connect:ap-southeast-2:xxxxxxxxxxxx:instance/aaaaaaaa-bbbb-
      cccc-dddd-eeeeeeeeeeee/user/${aws:userid}"
    ]
  }]
}

```

```
]
}
```

2. Use the IAM console to attach the policy. Or, use the `attach-role-policy` API, for example:

```
$ aws iam attach-role-policy --role-name [ASSUMED_ROLE] --policy_arn
[POLICY_WITH_GETFEDERATIONTOKEN]
```

Error Message: Session Expired

If you see the **Session expired** message while logging in, you probably just need to refresh the session token. Go to your identity provider and log in. Refresh the Amazon Connect page. If you still get this message, contact your IT team.

Additional resources for Amazon Connect

In addition to using the contents of this guide, you can learn more about Amazon Connect by using the following resources.

Resources

- [Amazon Connect API Reference](#)
- [Amazon Connect Participant Service API Reference](#)
- [Amazon AppIntegrations Service API Reference](#)
- [Contact Lens for Amazon Connect API Reference](#)
- [Amazon Connect Customer Profiles API](#)
- [Amazon Connect Voice ID API Reference](#)
- [Amazon Q in Connect API Reference](#)
- [Amazon Connect Streams](#)
- [Amazon Connect Chat UI Examples](#)

Amazon Connect API Reference

The [Amazon Connect API Reference](#) describes the API actions that are used to set up and manage your contact center.

Amazon Connect Participant Service API Reference

The [Amazon Connect Participant Service API Reference](#) describes the API actions that are used to manage chat participants, such as agents and customers.

Amazon AppIntegrations Service API Reference

The [Amazon AppIntegrations Service API Reference](#) describes the API actions that you can use to configure connections to external applications.

Contact Lens for Amazon Connect API Reference

The [Amazon Connect Contact Lens API Reference](#) describes the API actions that you can use to access an up-to-date transcript, along with all the associated conversation characteristics while a call is still in progress. This helps to reduce the need for agents to write detailed call summaries and enables a seamless handoff from one agent to another during a call transfer.

Amazon Connect Customer Profiles API

The [Amazon Connect Customer Profiles API Reference](#) describes the API actions that you can use to manage domains and profiles.

Amazon Connect Voice ID API Reference

The [Amazon Connect Voice ID API Reference](#) describes the API actions that provide real-time caller authentication and fraud screening.

Amazon Q in Connect API Reference

The [Amazon Q in Connect API Reference](#) describes the API actions that deliver information to agents to help them solve customer issues.

Amazon Connect Streams

The [Amazon Connect Streams](#) documentation describes how to integrate your existing web applications with Amazon Connect. Streams gives you the power to embed the Contact Control Panel (CCP) UI components into your page, and/or handle agent and contact state events directly giving you the power to control agent and contact state through an object oriented event driven

interface. You can use the built in interface or build your own from scratch: Streams gives you the power to choose.

Amazon Connect Chat UI Examples

The [Amazon Connect Chat SDK and Sample Implementations](#) provides examples of how to enable your app to engage with Amazon Connect chat.

Get administrative support for Amazon Connect

If you are an administrator and need to contact support for Amazon Connect, choose one of the following options:

- If you have an AWS Support account, go to [Support Center](#) and submit a ticket.
- Otherwise, open the [AWS Management Console](#) and choose **Amazon Connect, Support, Create case**.

It's helpful to provide the following information:

- Your contact center instance ID/ARN. To find your instance ARN, see [Find your Amazon Connect instance ID/ARN](#).
- Your region.
- A detailed description of the issue.

Set up your contact center

Amazon Connect enables you to create a virtual contact center in the AWS cloud. To get started, create a virtual contact center instance. For more information, see [Get started with Amazon Connect](#).

After you create an instance, you can edit its settings, such as telephony, data storage, and data streaming. After that, you can assign your contact center a phone number or import your own phone number. You can add agents to your contact center, and assign them permissions appropriate to their roles. You can set up a single queue for incoming contacts, or set up multiple queues so that you can route contacts to agents with specific skills.

A key part of setting up your contact center is to define how your customers experience it. You do this by creating flows.

Finally, you'll need to provide your agents access to the Contact Control Panel (CCP), which they will use to interact with contacts.

Contents

- [Create an Amazon Connect instance](#)
- [Test voice, chat, and task experiences](#)
- [Set up phone numbers to use the Amazon Connect service](#)
- [Set up outbound calling](#)
- [Set up Amazon Connect outbound campaigns](#)
- [Manage users in Amazon Connect](#)
- [Set up routing](#)
- [Set up agents](#)
- [Set up tasks](#)
- [Set up in-app, web, and video calling capabilities](#)
- [Set up your customer's chat experience](#)
- [Set up SMS messaging](#)
- [Upgrade to the latest CCP](#)
- [Provide agents with access to the Contact Control Panel](#)

- [Embed a custom Contact Control Panel \(CCP\)](#)

Create an Amazon Connect instance

The first step in setting up your Amazon Connect contact center is to create a virtual contact center instance. Each instance contains all the resources and settings related to your contact center.

Things to know before you begin

- When you sign up for Amazon Web Services (AWS), your AWS account is automatically signed up for all services in AWS, including Amazon Connect. You are charged only for the services that you use. To create an AWS account, see [How do I create and activate an AWS account?](#)
- To allow a user to create an instance, ensure that they have the permissions granted by the `AmazonConnect_FullAccess` policy.
- For a list of the minimum IAM permissions required to create an instance, see [Required permissions for using custom IAM policies to manage access to the Amazon Connect admin website](#).
- Amazon Connect is not available to customers in India using Amazon Web Services through Amazon Internet Services Pvt. Ltd (AISPL). You will receive an error message if you try to create an instance in Amazon Connect.
- When you create an instance, you must decide how you want to manage users. **You can't change the identity management option after you create the instance.** For more information, see [Plan your identity management in Amazon Connect](#).

Step 1: Set identity

Permissions to access Amazon Connect features and resource are assigned to user accounts within Amazon Connect. When you create an instance, you must decide how you want to manage users. You can't change the identity management option after you create the instance. For more information, see [Plan your identity management in Amazon Connect](#).

To configure identity management for your instance

1. Open the Amazon Connect console at <https://console.aws.amazon.com/connect/>.
2. Choose **Get started**. If you have previously created an instance, choose **Add an instance** instead.

3. Choose one of the following options:
 - **Store users in Amazon Connect** - Use Amazon Connect to create and manage user accounts. You cannot share users with other applications.
 - **Link to an existing directory** - Use an AWS Directory Service directory to manage your users. You can use each directory with one Amazon Connect instance at a time.
 - **SAML 2.0-based authentication** - Use an existing identity provider (IdP) to federate users with Amazon Connect.
4. If you chose **Store users within Amazon Connect** or **SAML 2.0-based authentication**, provide the left-most label for **Access URL**. This label must be unique across all Amazon Connect instances in all Regions. You can't change the access URL after you create your instance.
5. If you chose **Link to an existing directory**, select the AWS Directory Service directory for **Directory**. The directory name is used as the left-most label for **Access URL**.
6. Choose **Next**.

Step 2: Add administrator

After you specify the user name of the administrator for the Amazon Connect instance, a user account is created in Amazon Connect and the user is assigned the **Admin** security profile.

To specify the administrator for your instance (Optional)

1. Do one of the following, based on the option that you chose in the previous step:
 - If you chose **Store users within Amazon Connect**, select **Specify an administrator**, and provide a name, password, and email address for the user account in Amazon Connect.
 - If you chose **Link to an existing directory**, for **Username**, type the name of an existing user in the AWS Directory Service directory. The password for this user is managed through the directory.
 - If you chose **SAML 2.0-based authentication**, select **Add a new admin** and provide a name for the user account in Amazon Connect. The password for this user is managed through the IdP.
2. You can also select **No administrator** if an administrator is not needed for your instance.
3. (Optional) Add tags to your instance. For more information see [Tagging an Amazon Connect instance](#).
4. Choose **Next**.

Step 3: Set telephony

Use the options in this section to choose whether you want your agents to receive calls from customers, make outbound calls, and hear early media audio.

Early media

When early media audio is enabled, for outbound calls your agents can hear pre-connection audio such as busy signals, failure-to-connect errors, or other informational messages provided by telephony providers.

Note

The early media feature is not supported for transfers that are dialed through the [Transfer to phone number](#) block in flows.

By default, early media is enabled for you. Note the following exception:

- Your instance was created before April 17, 2020, and you weren't enrolled in the preview program. You need to enable early media audio. For instructions, see [Update telephony options](#).

To configure telephony options for your instance

1. To allow inbound calls to your contact center, choose **Allow incoming calls**.
2. To enable outbound calling from your contact center, choose **Allow outgoing calls**.
3. To enable multi-party calls, choose **Enable up to six parties on a call**.
4. Choose **Next**.

Step 4: Data storage

Note

Amazon Connect does not support Amazon S3 Object Lock in compliance mode to store objects using a write-once-read-many (WORM) model.

When you create an instance, by default we create an Amazon S3 bucket. Data, such as reports and recordings of conversations, is encrypted using AWS Key Management Service, and then stored in the Amazon S3 bucket.

This bucket and key are used for both recordings of conversations and exported reports. Alternatively, you can specify separate buckets and keys for recordings of conversations and exported reports. For instructions, see [Update instance settings](#).

By default, Amazon Connect creates buckets for storing call recordings, chat transcripts, exported reports, and flow logs.

- When a bucket is created to store call recordings, call recording is enabled at the instance level. The next step for setting up this functionality is to [set up recording behavior in a contact flow](#).
- When a bucket is created to store chat transcripts, chat transcription is enabled at the instance level. Now all chat transcripts will be stored. Only if you want to monitor chat conversations do you need to [set up recording behavior in a contact flow](#).
- Live media streaming is not enabled by default.
- Screen recording is not enabled by default. For more information, see [Enable screen recording](#).

By default, Amazon Connect creates a Customer Profiles domain, which stores profiles that combine customer contact history with customer information such as account number, address, billing address, and birth date. Data is encrypted using AWS Key Management Service. You can configure Customer Profiles to use your own customer managed key after your instance is set up. For more information, see [Create a KMS key to be used by Customer Profiles to encrypt data \(required\)](#).

Review and copy the location of the S3 bucket, flow logs, and whether you want to enable Customer Profiles.

1. If desired, copy the location of the S3 bucket where your data encryption is stored, and the location of the flow logs in CloudWatch.
2. Choose **Next**.

Step 5: Review and create

To create your instance

1. Review the configuration choices. Remember that you cannot change the identity management options after you create the instance.
2. (Optional) To change any of the configuration options, choose **Edit**.
3. (Optional) Add tags to your instance. For more information see [Tagging an Amazon Connect instance](#).
4. Choose **Create instance**.
5. (Optional) To continue configuring your instance, choose **Get started** and then choose **Let's go**. If you prefer, you can access your instance and configure it later on. For more information, see [Next steps](#).

If you chose to manage your users directly within Amazon Connect or through an AWS Directory Service directory, you can access the instance using its access URL. If you chose to manage your users through SAML-based authentication, you can access the instance using the IdP.

Next steps

After you create an instance, you can assign your contact center a phone number or import your own phone number. For more information, see [Set up phone numbers to use the Amazon Connect service](#).

Create a dev (Sandbox) or test (QA) instance

You might want to create multiple contact center instances, for example, one as a Sandbox for development, another for QA, and a third for Production.

Each instance functions only within the AWS Region in which you create it.

Important

Most entities in Amazon Connect can be (re)created and replicated among instances using the Amazon Connect API. While doing that keep the following limitations in mind:

- Service quotas are specific to each instance.

- Some supporting services, such as User Directory, can be linked to only one Amazon Connect instance at a time.
- Any additional external and Region-specific limitations.

For more information, see [Can I migrate my Amazon Connect instance from a test environment to a production environment?](#)

To create another instance

1. In the AWS Management Console, choose **Amazon Connect**.
2. Choose **Add an instance**.
3. Complete the steps on the Amazon Connect resource configuration page. For instructions see [Create an Amazon Connect instance](#).

Find your Amazon Connect instance ID/ARN

When you open a support ticket, you may be asked to provide your Amazon Connect instance ID (also called the ARN). Use the following steps to find it.

1. Open the Amazon Connect console at <https://console.aws.amazon.com/connect/>.
2. On the instances page, choose the instance alias. The instance alias is also your **instance name**, which appears in your Amazon Connect URL. The following image shows the **Amazon Connect virtual contact center instances** page, with a box around the instance alias.

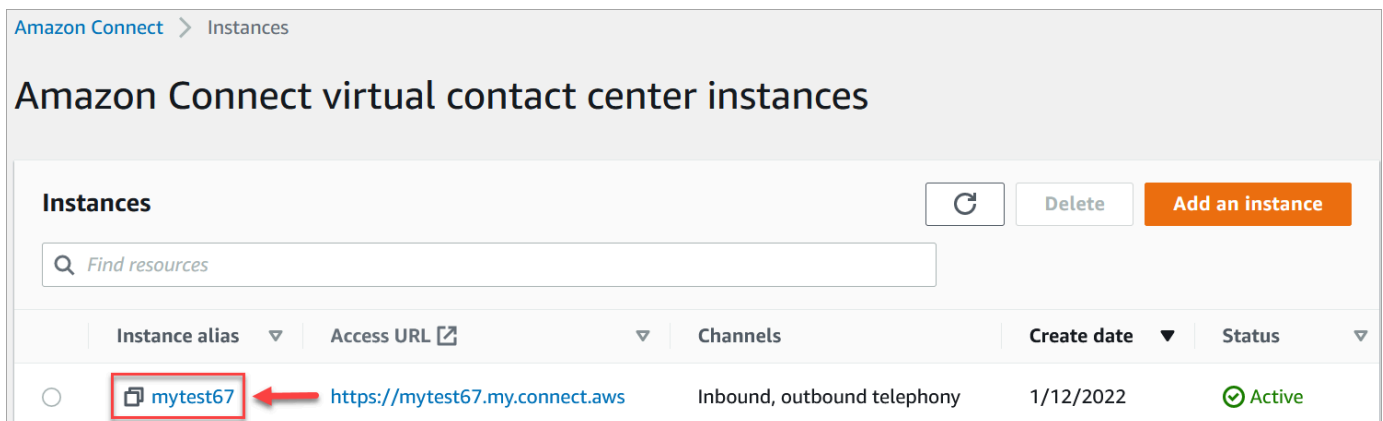

On the **Account overview** page, in the **Distribution settings** section, you can see the full instance ARN.

Distribution settings

Instance ARN

 `arn:aws:connect:us-west-2: [REDACTED]:instance/6eac61e7-22cc-460e-83eb-[REDACTED]92`

Directory
mytest67

The information after **instance/** is the instance ID.

Distribution settings

Instance ARN

 `arn:aws:connect:us-west-2: [REDACTED]:instance/6eac61e7-22cc-460e-83eb-[REDACTED]92`

Directory
mytest67



Find your Amazon Connect instance name

1. Open the Amazon Connect console at <https://console.aws.amazon.com/connect/>.
2. On the instances page, the instance name appears in the **Instance Alias** column. This instance name appears in the URL you use to access Amazon Connect.

Amazon Connect > Instances

Amazon Connect virtual contact center instances

Instances Refresh Delete Add an instance

Instance alias	Access URL	Channels	Create date	Status
 mytest67	https://mytest67.my.connect.aws	Inbound, outbound telephony	1/12/2022	Active



Update instance settings

To update the instance settings:

1. Open the Amazon Connect console at <https://console.aws.amazon.com/connect/>.
2. On the instances page, choose the instance alias. The instance alias is also your **instance name**, which appears in your Amazon Connect URL. The following image shows the **Amazon Connect virtual contact center instances** page, with a box around the instance alias.

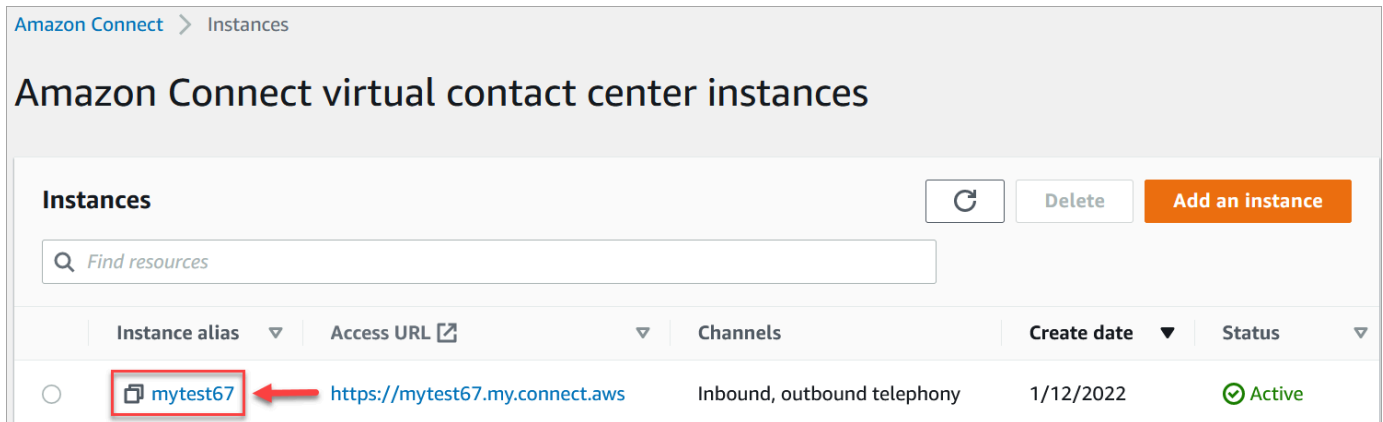

3. Complete the following procedures.

Update telephony options

1. In the navigation pane, choose **Telephony**.
2. To enable customers to call into your contact center, choose **Receive inbound calls with Amazon Connect**.
3. To enable outbound calling from your contact center, choose **Make outbound calls with Amazon Connect**.
4. To enable outbound campaigns, choose **Enable outbound campaigns**.
5. By enabling early media audio, your agents can hear pre-connection audio such as busy signals, failure-to-connect errors, or other informational messages from telephony providers, when making outbound calls. Choose **Enable early media**.

Note

The early media feature is not supported for transfers that are dialed through the [Transfer to phone number](#) block in flows.

6. By default, you can have three participants on a call (for example, two agents and a customer, or an agent, a customer, and an external party). To enable multi-party calls with more participants, choose **Enable up to six parties on a call**. This feature is only available in CCPv2.
7. Choose **Enable Multi-Party Calls and Enhanced Monitoring**. This setting is required to use the barge capabilities.

To enable barge for chats, you must also choose **Enable Barge and Enhanced Monitoring for Chat**.

For more information, see [Barge live voice and chat conversations](#).

8. Choose **Save**.

Update data storage

- In the navigation pane, choose **Data storage**. Choose the following:
 - **Call recordings**: Choose **Edit**, specify the bucket and KMS key for recordings of voice conversations, and then choose **Save**.

When this bucket is created, call recording is enabled at the instance level. The next step for setting up this functionality is to [set up recording behavior in a flow](#).

- **Chat transcripts**: Choose **Edit**, specify the bucket and KMS key for recordings (transcripts) of chat conversations, and then choose **Save**.

When this bucket is created, chat transcripts are enabled at the instance level. Now all chat transcripts will be stored here.

- **Live media streaming**: Choose **Edit** to enable live media streaming, choose **Edit**. For more information, see [Set up live media streaming of customer audio](#).
- **Exported reports**: Choose **Edit**, specify the bucket and KMS key for exported reports, and then choose **Save**.
- **Attachments**: Choose **Edit**, then **Enable Attachments sharing** to enable file sharing for both agents and customers. For more information about this option and additional steps, see [Enable attachments to share files using chat and upload files to cases](#).
- **Contact evaluations**: Choose **Edit**, specify the bucket and KMS key for performance evaluations, and then choose **Save**.

When this bucket is created, evaluations are enabled at the instance level. The next step for setting up this feature is to [create an evaluation form](#).

- **Screen recordings:** Choose **Edit**, specify the bucket and KMS key for recordings of agent screens, and then choose **Save**.

When this bucket is created, screen recording is enabled at the instance level. The next step for setting up this functionality is to download and install the agent app, and then enable screen recording in the Set recording and analytics behavior block. For more information, see [Enable screen recording](#).

Update data streaming options

1. In the navigation pane, choose **Data streaming**.
2. Choose **Enable data streaming**. For more information, see [Enable data streaming for your instance](#).
3. For **Contact records**, do one of the following:
 - Choose **Kinesis Firehose** and select an existing delivery stream, or choose **Create a new Kinesis Firehose** to open the Kinesis Firehose console and create the delivery stream.
 - Choose **Kinesis Stream** and select an existing stream, or choose **Create a new Kinesis Firehose** to open the Kinesis console and create the stream.
4. For **Agent Events**, select an existing Kinesis stream or choose **Create a new Kinesis Stream** to open the Kinesis console and create the stream.
5. Choose **Save**.

Update analytics tools options

1. In the navigation pane, choose **Analytics tools**.
2. Choose **Enable Contact Lens**. For more information, see [Analyze conversations using conversational analytics](#).
3. Choose **Save**.

Update flow settings

1. In the navigation pane, choose **Flows**.

2. (Optional) To add a signing key for use in flows, choose **Add key**. For more information, see [Encrypt customer input](#).
3. (Optional) To integrate with Amazon Lex, select a Lex bot. For more information, see [Add an Amazon Lex bot to Amazon Connect](#).
4. (Optional) To integrate with AWS Lambda, select a Lambda function. For more information, see [Invoke AWS Lambda functions](#).
5. (Optional) To enable flow logs, choose **Enable flow logs**. For more information, see [Track events as customers interact with flows](#).
6. (Optional) To use the best available voice from Amazon Polly, choose **Use the best available voice**. For more information, see [Amazon Polly best sounding voice](#).
7. (Optional) Use the voices available in Amazon Polly.

Enable attachments to share files using chat and upload files to cases

You can allow customers and agents to share files using chat, and allow agents to upload files to cases. After you complete the steps in this topic, an attachment icon automatically appears in your agent's Contact Control Panel so they can share attachments on chats.

For a list of supported file types, see [Amazon Connect feature specifications](#).

If you are not using the hosted communications widget, you need to update your customer-facing chat interfaces to support attachment sharing.

Using a custom chat application? Check out the APIs we've added to support attachment sharing: [StartAttachmentUpload](#), [CompleteAttachmentUpload](#), and [GetAttachment](#).

Using a custom agent application? Check out the attached file APIs: [StartAttachedFileUpload](#), [CompleteAttachedFileUpload](#), and [GetAttachedFile](#), [BatchGetAttachedFileMetadata](#), and [DeleteAttachedFile](#).

Step 1: Enable attachments

1. Open the Amazon Connect console at <https://console.aws.amazon.com/connect/>.
2. On the instances page, choose the instance alias. The instance alias is also your **instance name**, which appears in your Amazon Connect URL. The following image shows the **Amazon Connect virtual contact center instances** page, with a box around the instance alias.

Amazon Connect > Instances

Amazon Connect virtual contact center instances

Instances Refresh Delete Add an instance

Find resources

Instance alias	Access URL	Channels	Create date	Status
<input type="radio"/> mytest67	https://mytest67.my.connect.aws	Inbound, outbound telephony	1/12/2022	Active

3. On the **Data storage** page, under the **Attachments**, choose **Edit**, select **Enable Attachments sharing**, and then choose **Save**.

Storage options appear, similar to the following image.

Attachments

Enable Attachments sharing

Attachments

Create a new S3 bucket (recommended) Select an existing S3 bucket

Name

Path prefix

Encryption

Enable encryption
Encryption options for Attachments

Cancel Save

4. You can change the Amazon S3 bucket location where attachments are stored. By default, your existing Amazon Connect bucket is used, with a new prefix for attachments.

 **Note**

Currently, Amazon Connect doesn't support S3 buckets with [Object Lock](#) enabled.

The attachments feature leverages two Amazon S3 locations: a staging location and a final location.

Note the following about the staging location:

- The staging location is used as part of a business validation flow. Amazon Connect uses it to validate the file size and type before it is available for download by using the `GetAttachedFile` or `GetAttachment` APIs.
- The staging prefix is created by Amazon Connect based on the bucket path you have selected. Specifically, it includes the S3 prefix for where you are saving files, with **staging** appended to it.
- We recommend that you change the data retention policy for the staging prefix to one day. This way you won't be charged for storing the staging files. For instructions, see [How do I create a lifecycle rule for an S3 bucket?](#) in the *Amazon S3 User Guide*.

 **Warning**

- Only change the lifecycle for the **file staging location**. If you accidentally change the lifecycle for the entire Amazon S3 bucket, all transcripts and attachments will be deleted.
- S3 objects are **permanently deleted** if S3 bucket versioning is not enabled.

Step 2: Configure a CORS policy on your attachments bucket

To allow customers and agents to upload and download files, update your cross-origin resource sharing (CORS) policy to allow PUT and GET requests for the Amazon S3 bucket you are using for attachments. This is more secure than enabling public read/write on your Amazon S3 bucket, which we don't recommend.

To configure CORS on the attachments bucket

1. Find the name of the Amazon S3 bucket for storing attachments:
 - a. Open the Amazon Connect console at <https://console.aws.amazon.com/connect/>.
 - b. In the Amazon Connect console, choose **Data storage**, and locate the Amazon S3 bucket name.
2. Open the Amazon S3 console at <https://console.aws.amazon.com/s3/>.
3. In the Amazon S3 console, select your Amazon S3 bucket.
4. Choose the **Permissions** tab, and then scroll down to the **Cross-origin resource sharing (CORS)** section.
5. Add a CORS policy that has one of the following rules on your attachments bucket. For example CORS policies, see [Cross-origin resource sharing: Use-case scenarios](#) in the *Amazon S3 Developer Guide*.
 - Option 1: List the endpoints from where attachments will be sent and received, such as the name of your business web site. This rule allows cross-origin PUT and GET requests from your website (for example, <http://www.example1.com>).

Your CORS policy may look similar to the following example:

```
[
  {
    "AllowedMethods": [
      "PUT",
      "GET"
    ],
    "AllowedOrigins": [
      "http://www.example1.com",
      "http://www.example2.com"
    ],
    "AllowedHeaders": [
      "*"
    ]
  }
]
```

- Option 2: Add the * wildcard to AllowedOrigin. This rule allows cross-origin PUT and GET requests from all origins, so you don't have to list your endpoints.

Your CORS policy may look similar to the following example:

```
[
  {
    "AllowedMethods": [
      "PUT",
      "GET"
    ],
    "AllowedOrigins": [
      "*"
    ],
    "AllowedHeaders": [
      "*"
    ]
  }
]
```

Step 3 (Optional): Integrate with the APIs to enhance your custom UIs

If you are skipping the out-of-the-box Chat UI or Agent workspace, you can use the Amazon Connect Participant attachments APIs, or Amazon Connect attached files APIs to build your own UIs and provide attachments support for Cases and Chats. For the general steps in working with both sets of APIs, see [Working with attachments](#).

Next step

We recommend enabling attachment scanning to meet compliance requirements or security policies that your organization may have in place for file sharing. For more information, see [Set up attachment scanning](#).

Attachments not appearing?

If your agents report problems receiving and sending attachments in chat messages, see [Internal firewall prevents access to chat or case attachments](#).

Set up attachment scanning

Note

This topic is for developers who are familiar with Lambda. If you're new to Lambda, see [Getting started with Lambda](#) in the *AWS Lambda Developer's Guide*.

You can configure Amazon Connect to scan attachments that are sent during a chat or uploaded to a case. You can scan attachments by using your preferred scanning application. For example, you can scan attachments for malware before they are approved to be shared between participants of a chat.

To enable attachment scanning you perform two steps:

- [Configure a Lambda function that calls your preferred scanning application.](#)
- [Add the scanner to your Amazon Connect instance.](#)

Step 1: Create a Lambda function that handles scanning

Create a Lambda function, using any runtime, and configure it. This function must be in the same AWS Region and account as your Amazon Connect instance.

For every attachment uploaded through Amazon Connect a request is sent with information about the attachment.

Following is an example JSON request for scanning:

```
{
  "Version": "1.0",
  "InstanceId": "your instance ID",
  "File": {
    "FileId": "your file ID",
    "FileCreationTime": 1689291663582,
    "FileName": "example.txt",
    "FileSizeInBytes": 10,
    "FileLocation": {
      "S3Location": {
        "Key": "connect/your-instance/Attachments/chat/2023/07/13/your file ID_20230713T23:41_UTC.txt",

```

```
        "Bucket": "connect-example",
        "Arn": "arn:aws:s3:::connect-example/connect/your-instance/Attachments/
chat/2023/07/13/your file ID_20230713T23:41_UTC.txt"
    }
}
}
```

Required response

```
{
  "Status": "APPROVED" | "REJECTED"
}
```

Invocation retry policy

If your Lambda invocation gets throttled, the request is retried. It is also retried if a general service failure (500 error) happens. When a synchronous invocation returns an error, Amazon Connect retries up to 3 times, for a maximum of 60 seconds. At that point, the attachment is marked rejected.

For more information about how Lambda retries, see [Error handling and automatic retries in AWS Lambda](#).

Rejection behavior

Amazon Connect marks the attachment REJECTED and automatically deletes attachment files in S3 from both staging and final locations when one of the following occurs:

- Your Lambda scanner returns a status of REJECTED.
- Amazon Connect is unable to parse the response from the Lambda scanner.
- Amazon Connect is unable to invoke the Lambda function.

Step 2: Add an attachment scanner to your Amazon Connect instance

After you create a Lambda for attachment scanning, you need to add the Lambda to your Amazon Connect instance. Perform the following steps to add the Lambda.

1. Open the Amazon Connect console at <https://console.aws.amazon.com/connect/>.

- On the instances page, choose the instance alias. The instance alias is also your **instance name**, which appears in your Amazon Connect URL. The following image shows the **Amazon Connect virtual contact center instances** page, with a box around the instance alias.

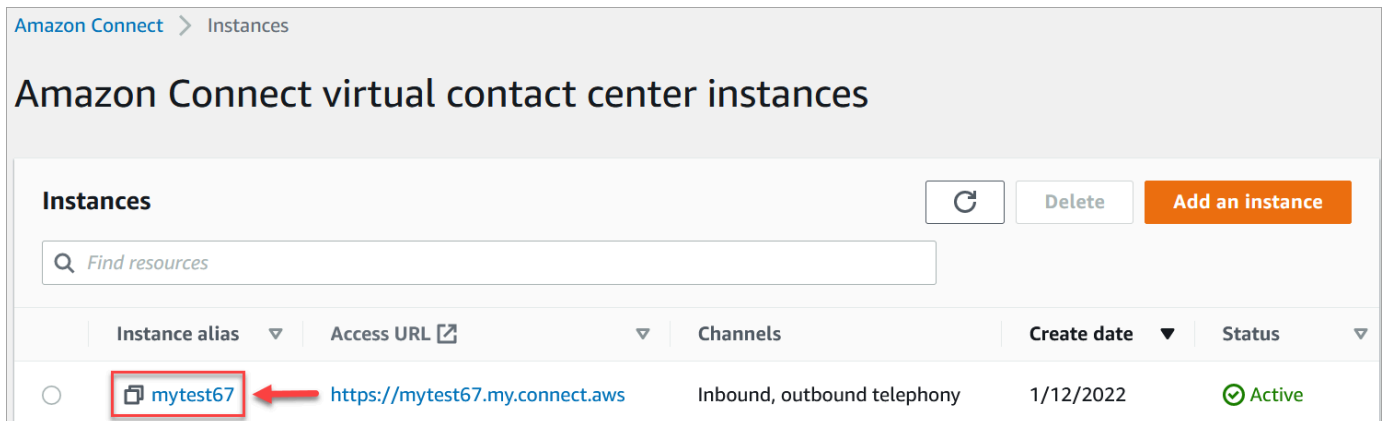

- In the navigation pane, choose **Data storage**.
- On the **Data storage** page, in the **Attachments** section, choose **Edit**, and then select **Enable attachments scanning**, as shown in the following image.

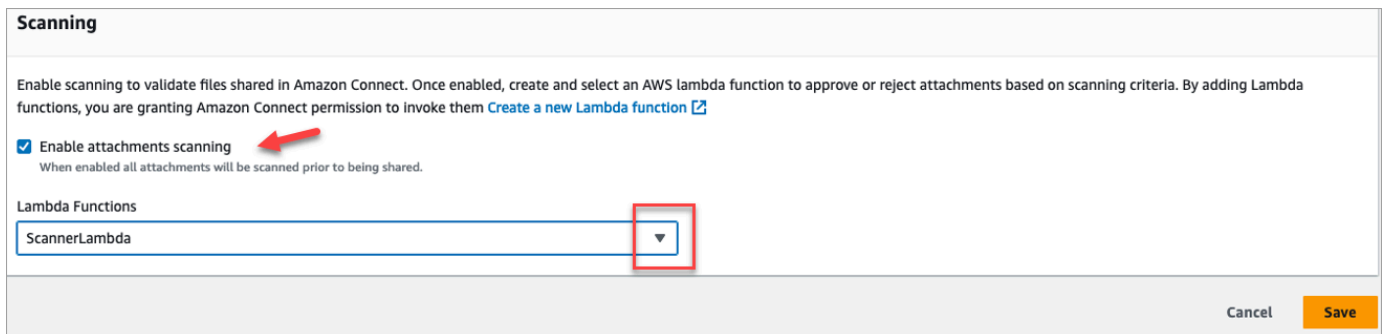

- Use the **Lambda Functions** drop-down box to select the Lambda function that you added in [Step 1: Create a Lambda function that handles scanning](#).
- Choose **Save**. Attachment scanning is now enabled for your Amazon Connect instance.

Enable data streaming for your instance

You can export contact records and agent events from Amazon Connect and perform real-time analysis on contacts. Data streaming sends data to Amazon Kinesis.

To enable data streaming for your instance

- Open the Amazon Connect console at <https://console.aws.amazon.com/connect/>.

- On the instances page, choose the instance alias. The instance alias is also your **instance name**, which appears in your Amazon Connect URL. The following image shows the **Amazon Connect virtual contact center instances** page, with a box around the instance alias.

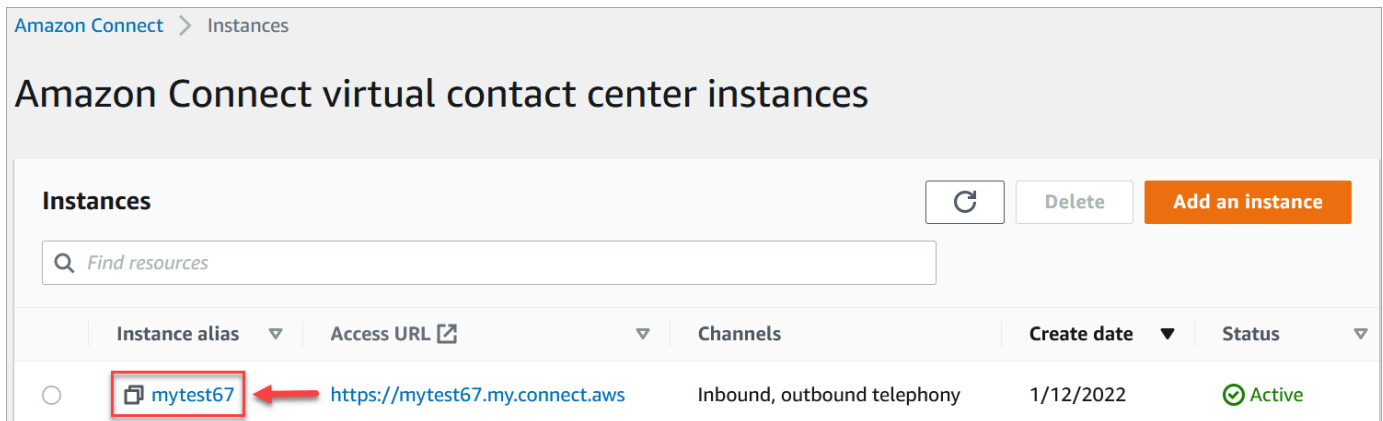

- In the navigation pane, choose **Data streaming**.
- Choose **Enable data streaming**.
- For **Contact records**, do one of the following:
 - Choose **Kinesis Firehose** and select an existing delivery stream, or choose **Create a new Kinesis firehose** to open the Kinesis Firehose console and create the delivery stream. For more information, see [Creating an Amazon Data Firehose Delivery Stream](#).
 - Choose **Kinesis Stream** and select an existing stream, or choose **Create a Kinesis stream** to open the Kinesis console and create the stream. For more information, see [Creating and Managing Streams](#).
- For **Agent Events**, select an existing Kinesis stream or choose **Create a new Kinesis stream** to open the Kinesis console and create the stream.
- Choose **Save**.

Use server-side encryption for the Kinesis stream

Amazon Connect supports streaming to Amazon Kinesis Data Streams and Firehose streams that have server-side encryption with a [customer managed key](#) enabled. For a general overview of this feature, see [What Is Server-Side Encryption for Kinesis Data Streams?](#)

To stream to Kinesis Data Streams, you need to grant your Amazon Connect instance permission to use a customer managed key. For details on the permissions needed for KMS keys, see [Permissions to Use User-Generated KMS Master Keys](#). (Amazon Connect acts as the Kinesis stream producer that is described in that topic.)

When Amazon Connect puts records into your Kinesis Data Streams, it uses the service-linked role of the instance for authorization. This role needs permission to use the KMS key that encrypts the data stream. To assign permissions to the role, perform the following steps to update the [key policy](#) of that KMS key.

Note

To avoid missing data, update the permission of the KMS key before using a KMS key with Amazon Connect streaming.

Step 1: Obtain the ARN for the service-linked role of your Amazon Connect instance

You can use the Amazon Connect console or the AWS CLI to obtain the ARN.

Use the Amazon Connect console to obtain the ARN

1. Open the Amazon Connect console at <https://console.aws.amazon.com/connect/>.
2. On the instances page, choose the instance name, as shown in the following image.

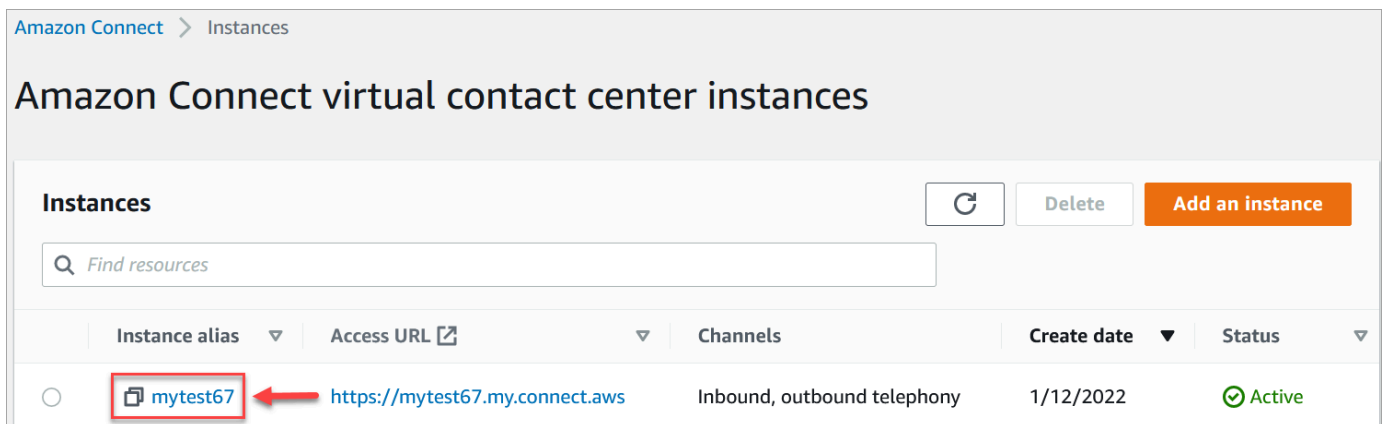

3. On the **Account overview** page, in the **Distribution settings** section, the service-linked role is displayed.

4. Choose the copy icon to copy the role ARN to your clipboard, and save that ARN. You're going to use it in [Step 2: Construct a policy statement](#).

Use the AWS CLI to obtain the ARN

1. Run the following command:

```
aws connect describe-instance --instance-id your_instance_id
```

2. Save the ServiceRole value from the CLI output.

Step 2: Construct a policy statement

Construct a policy statement that gives permission to the ARN of the Amazon Connect service-link role to generate data keys. The following code shows a sample policy.

```
{
  "Sid": "Allow use of the key for Amazon Connect streaming",
  "Effect": "Allow",
  "Principal": {
    "AWS": "the ARN of the Amazon Connect service-linked role"
  },
  "Action": "kms:GenerateDataKey",
  "Resource": "*"
}
```

Add this statement to the KMS key policy by using your preferred mechanism, such as the AWS Key Management Service console, the AWS CLI, or the AWS CDK.

Emergency admin login

As a best practice, users assigned to the Amazon Connect **Admin** security profile should always use their Amazon Connect instance URL to login:

- Log in to the Amazon Connect admin website at [https://*instance name*.my.connect.aws/](https://instance_name.my.connect.aws/).

This method ensures the appropriate levels security.

However, if there's an emergency, you can log in from the Amazon Connect console using your AWS account credentials. For example, you may need to login in this way in the following situations:

- You forgot your Amazon Connect administrator password and no other Amazon Connect administrators are around to reset it.
- Someone deleted the Amazon Connect **Admin** security profile by mistake.

To login for emergency access

1. Make sure you have your AWS account credentials at hand and that you have the [required permissions](#).
2. Open the Amazon Connect console at <https://console.aws.amazon.com/connect/>.
3. If prompted to login, enter your AWS account credentials.
4. Choose the name of the instance from the **Instance alias** column.

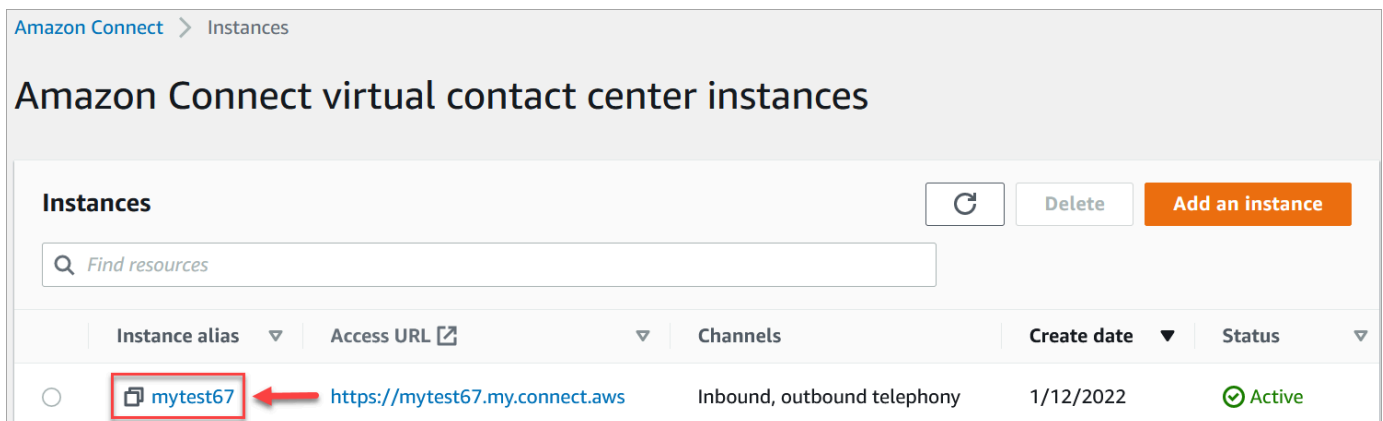

The screenshot shows the Amazon Connect console interface. At the top, it says "Amazon Connect > Instances". Below that is the heading "Amazon Connect virtual contact center instances". There are three buttons: "Refresh", "Delete", and "Add an instance". A search bar contains "Find resources". Below the search bar is a table with columns: "Instance alias", "Access URL", "Channels", "Create date", and "Status". The first row in the table has an instance alias of "mytest67" (highlighted with a red box and a red arrow), an Access URL of "https://mytest67.my.connect.aws", Channels of "Inbound, outbound telephony", a Create date of "1/12/2022", and a Status of "Active".

Instance alias	Access URL	Channels	Create date	Status
mytest67	https://mytest67.my.connect.aws	Inbound, outbound telephony	1/12/2022	Active

5. In the navigation pane, choose **Overview**.

6. Choose **Log in for emergency access**.

You aren't prompted for your credentials because you are federated in from the AWS console.

Important

For daily usage, we strongly recommend always using your instance URL to login. The procedure provided in this article should only be used for emergency access when using the instance URL is not an option.

To log out

To log out of your instance, go to the title bar at the top of the screen and select the icon with the arrow (**Log out**) that appears next to your user name.

Delete your Amazon Connect instance

If you no longer need your Amazon Connect instance, you can delete it. Here's what happens when you delete it:

- Its claimed phone number is released back to inventory.
- When customers call the phone number that you've released, they'll get a message that it's not a working phone number.

Important

You can't restore a deleted Amazon Connect instance or access its settings, data, metrics, and reports.

Delete your instance

You must have the appropriate AWS permissions to delete an Amazon Connect. If your organization is using IAM, see [Required permissions for using custom IAM policies to manage access to the Amazon Connect admin website](#).

1. Open the Amazon Connect console at <https://console.aws.amazon.com/connect/>.

2. Select the radio button for the instance.
3. Choose **Delete**. If you don't see the **Delete** button, you don't have permissions to delete instances. Contact your AWS administrator for help.

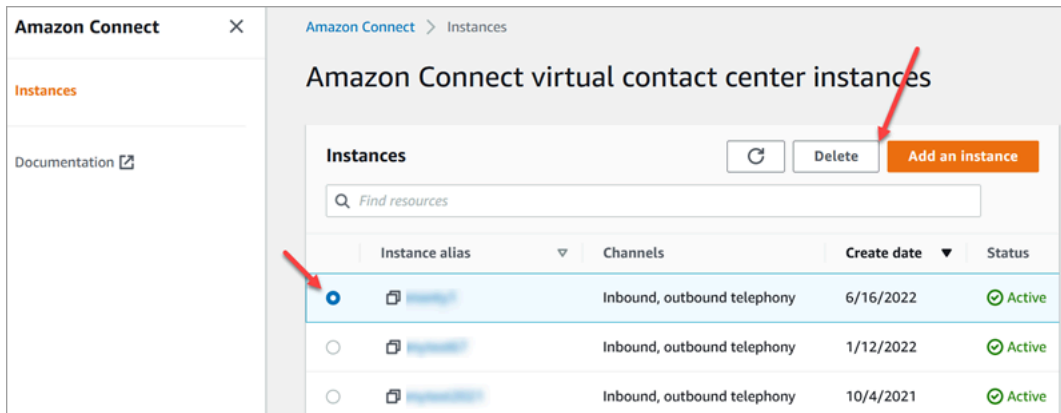

4. When prompted, enter the name of the instance and then choose **Delete**.

i Tip

We recommend checking your CloudWatch log groups related to the Amazon Connect instance, and deleting them if they are no longer needed. For more information, see [Delete a CloudWatch Logs log group using an AWS SDK](#).

Error message: "Region Unsupported. Amazon Connect is not available in [Region]"

If you get this error message, it means that you selected a Region in the AWS Management Console that is not the Region in which you created the Amazon Connect instance, and Amazon Connect isn't available in that Region.

To switch Regions and delete your Amazon Connect instance

1. From the navigation bar, open the Region selector. Select the Region in which you created the Amazon Connect instance.

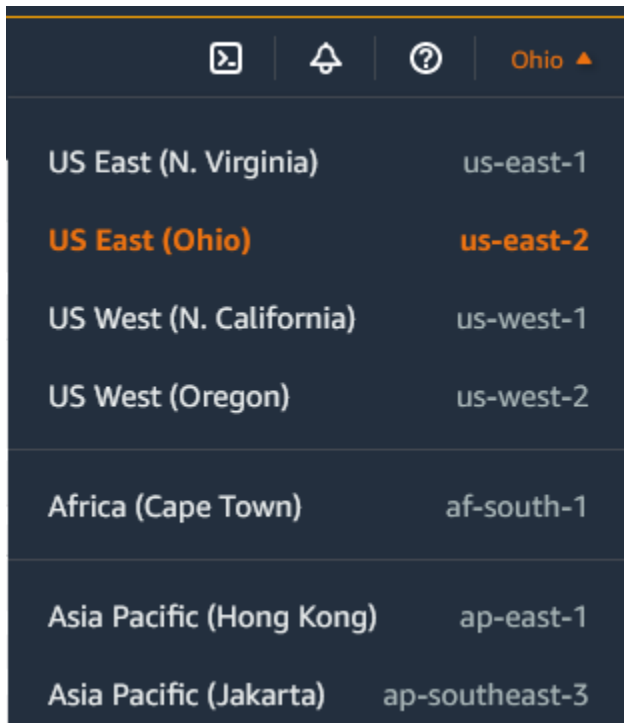

2. From the navigation bar, choose **Amazon Connect** from the list of services to open the Amazon Connect console. If you don't see the instance, keep selecting from the supported Regions until you find your instance.
3. Select the radio button for the instance.
4. Choose **Delete**. If you don't see the **Delete** button, you don't have permissions to delete instances. Contact your AWS administrator for help.
5. When prompted, enter the name of the instance and then choose **Delete**.

Tagging an Amazon Connect instance

Instance Tagging provides the ability for you to tag Amazon Connect instances and build tailored authorization through tag-based access control (TBAC). To help you manage your Amazon Connect instances, you can assign your own metadata in the form of tags to the instance. If you have multiple Amazon Connect instances in a single AWS account, each serving different functions or catering to specific lines of business, using tags can help you better organize and apply tag-based access control (TBAC) policies to these instances for improved management and control.

[AWS Tags](#) serve as a useful tool for organizing your AWS resources. They consist of key-value pairs that help you categorize resources based on criteria like purpose, owner, or environment. This

enables you to identify and manage your resources. Amazon Connect, allows you to add tags to your instances directly from the AWS console, or by utilizing public APIs.

Tagging Amazon Connect instances at creation

1. Open the Amazon Connect console at <https://console.aws.amazon.com/connect/>.
2. Choose **Add an instance**.

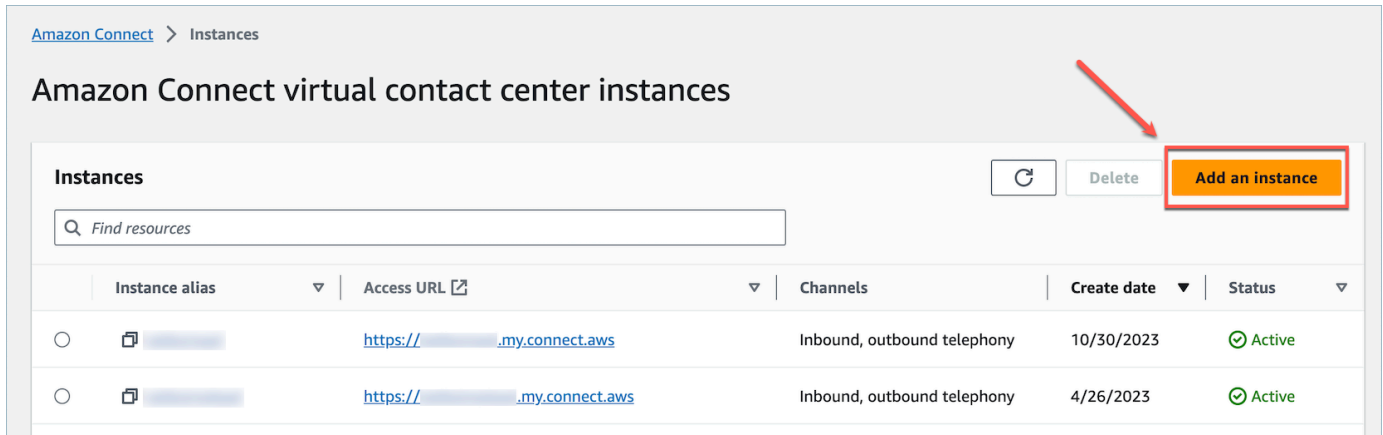

The screenshot shows the Amazon Connect console's 'Instances' page. At the top, there's a breadcrumb 'Amazon Connect > Instances' and a title 'Amazon Connect virtual contact center instances'. Below the title is a search bar with the placeholder 'Find resources'. To the right of the search bar are three buttons: a refresh button, a 'Delete' button, and an 'Add an instance' button. The 'Add an instance' button is highlighted with a red box and a red arrow points to it. Below the buttons is a table with columns: Instance alias, Access URL, Channels, Create date, and Status. There are two rows of instance data, both with 'Active' status.

3. Under **Set identity**, select the type of **Identity management** that you would like to use, enter a customer **Access URL**, and choose **Next**.

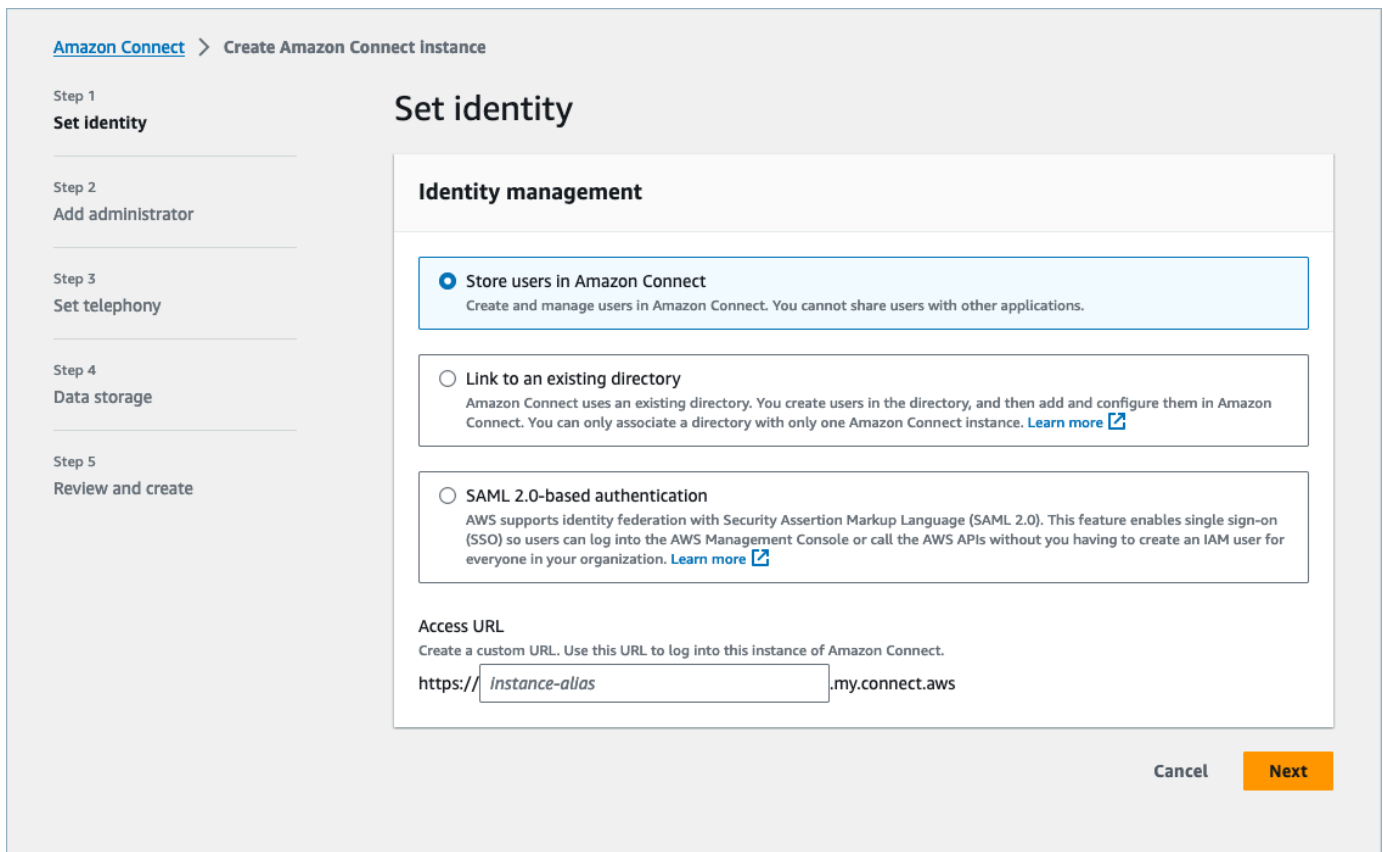

The screenshot shows the 'Set identity' step of the 'Create Amazon Connect Instance' wizard. On the left, there's a sidebar with five steps: Step 1 (Set identity), Step 2 (Add administrator), Step 3 (Set telephony), Step 4 (Data storage), and Step 5 (Review and create). The main content area is titled 'Set identity' and contains three options for 'Identity management':

- Store users in Amazon Connect**: Create and manage users in Amazon Connect. You cannot share users with other applications.
- Link to an existing directory**: Amazon Connect uses an existing directory. You create users in the directory, and then add and configure them in Amazon Connect. You can only associate a directory with only one Amazon Connect instance. [Learn more](#)
- SAML 2.0-based authentication**: AWS supports identity federation with Security Assertion Markup Language (SAML 2.0). This feature enables single sign-on (SSO) so users can log into the AWS Management Console or call the AWS APIs without you having to create an IAM user for everyone in your organization. [Learn more](#)

Below the options is the 'Access URL' section, which says 'Create a custom URL. Use this URL to log into this instance of Amazon Connect.' and shows a text input field with the value 'https:// instance-alias .my.connect.aws'. At the bottom right, there are 'Cancel' and 'Next' buttons.

- Under the **Add administrator** section, you can choose the **Add new tag** option if you would like to add tags to your instance.

Amazon Connect > Create Amazon Connect instance

Step 1
[Set identity](#)

Step 2
Add administrator

Step 3
Set telephony

Step 4
Data storage

Step 5
Review and create

Add administrator

Add administrator

Administrator - optional

Specify an administrator
Specify an administrator for this instance of Amazon Connect. The administrator will have full permissions to access all of Amazon Connect.

No administrator

▼ Tags - optional
Tags are key-value pairs that you can add to AWS resources to help identify, organize and search for resources.

Key	Value	
Env	Prod	Remove

Add new tag
You can add up to 49 more tags.

Cancel Previous **Next**

- Enter a Key and Value pair and choose **Next**.
- Once you have made your desired configurations under the **Set telephony** and **Data storage** steps, review your configurations and choose **Create instance**.

▼ Tags Edit

Key	Value
Env	Prod

Add new tag
You can add up to 49 more tags.

Cancel Previous **Create instance**

- Once the instance has been created, navigate to the **Account overview** page of the instance and the tags that you added will appear in the **Tags** section.

Account overview

Access information

Access URL
[https://\[redacted\].my.connect.aws](https://[redacted].my.connect.aws)

Emergency access
[Log in for emergency access](#)

Warning: Use this login method only for emergencies. Do not use for your day-to-day operations.

Distribution settings

Instance ARN
[arn:aws:connect:us-west-2:\[redacted\]:instance/\[redacted\]](#)

Service-linked role
[AWSServiceRoleForAmazonConnect_\[redacted\]](#)
[Learn more](#)

Directory
 [redacted]

Tags

Tags are key-value pairs that you can add to AWS resources to help identify, organize and search for resources.

Key	Value	
<input type="text" value="Env"/>	<input type="text" value="Prod"/>	<input type="button" value="Remove"/>

You can add up to 49 more tags.

Tagging an existing Amazon Connect instance

1. Open the Amazon Connect console at <https://console.aws.amazon.com/connect/>.
2. Select an existing instance that you would like to add tags too.

[Amazon Connect](#) > Instances

Amazon Connect virtual contact center instances

Instances

	Instance alias	Access URL	Channels	Create date	Status
<input type="radio"/>	[redacted]	https://[redacted].my.connect.aws	Inbound, outbound telephony	10/30/2023	Active
<input type="radio"/>	[redacted]	https://[redacted].my.connect.aws	Inbound, outbound telephony	4/26/2023	Active

3. On the **Account overview**, choose **Add new tag**.

The screenshot shows the 'Account overview' page. It is divided into three main sections: 'Access information', 'Distribution settings', and 'Tags'. The 'Access information' section includes an 'Access URL' field with a value like 'https://[redacted].my.connect.aws' and an 'Emergency access' section with a 'Log in for emergency access' link and a warning box. The 'Distribution settings' section includes an 'Instance ARN' field with a value like 'arn:aws:connect:us-west-2:[redacted]:instance/[redacted]' and a 'Service-linked role' field with a value like 'AWSServiceRoleForAmazonConnect_[redacted]'. The 'Tags' section is expanded, showing a description of tags, a message that no tags are currently associated with the instance, an 'Add new tag' button, and a 'Save' button.

4. Enter a Key and Value pair and choose **Next**. You can add up to 50 tags on a single instance.

The screenshot shows the 'Tags' section of the 'Account overview' page. It includes a description of tags, a table for adding key-value pairs, and an 'Add new tag' button. The table has two columns: 'Key' and 'Value'. The 'Key' column contains the text 'Env' and the 'Value' column contains the text 'Prod'. There is a 'Remove' button to the right of the 'Value' field. Below the table is an 'Add new tag' button and a message that says 'You can add up to 49 more tags.' A 'Save' button is located at the bottom right of the section.

5. Choose **Save** to add your tags to your instance.

▼ Tags
Tags are key-value pairs that you can add to AWS resources to help identify, organize and search for resources.

Successfully edited tags. ✕

Key	Value	
Env	Prod	Remove

Add new tag

You can add up to 49 more tags.

Save

Tagging an Amazon Connect instance using the API

To tag Amazon Connect instances using the public APIs, see [TagResource](#) and [UntagResource](#).

Sample IAM policies for scenarios with and without instance tags

For TBAC on instances, you can define IAM policies based on instance tags and assign them to IAM roles to control access to specific instances. The following are sample scenarios and sample IAM policies for how to use conditions on tags or conditions on resource IDs.

Scenario 1: Controlling access to a specific instance through an IAM role using tags associated with the instance. The following policy allows access only instances which are tagged with key:Environment and value:Dev.

```
{
  "Version": "2012-10-17",
  "Statement": [
    {
      "Effect": "Allow",
      "Action": "*",
      "Resource": "*"
    },
    {
      "Effect": "Deny",
      "Action": "connect:DescribeInstance",
      "Resource": "*",
      "Condition": {
        "StringNotEquals": {
          "aws:ResourceTag/Environment": [
```

```

        "Dev"
      ]
    }
  }
]
}

```

Scenario 2: Controlling access to a specific instance and all resources within the instance without using tags.

```

{
  "Version": "2012-10-17",
  "Statement": [
    {
      "Sid": "VisualEditor0",
      "Effect": "Allow",
      "Action": "connect:*",
      "Resource": "*",
      "Condition": {
        "ForAnyValue:StringEquals": {
          "connect:InstanceId": [
            "868722ed-3b3b-42b0-a639-b11052ab2851", //Allowing all connect
actions on these instances
            "f28afebb-613a-4f88-bc09-00becc6e171f"
          ]
        }
      }
    },
    {
      "Sid": "VisualEditor1",
      "Effect": "Deny",
      "Action": "connect:*",
      "Resource": "*",
      "Condition": {
        "ForAnyValue:StringEquals": {
          "connect:InstanceId": "dd57837f-d4c0-49f3-88bd-b37a1fe7bd75" //
Denying all connect actions on these instances
        }
      }
    }
  ]
}

```

```
}
```

Additional information about instance tagging

Replicating instances: When you create a [replica of your existing Amazon Connect instance](#) to another region using the [ReplicateInstance](#) API, tags from the source instance will not be automatically tagged to the newly replicated instance. You will have to tag the replicated instance manually.

Tag inheritance: When you tag an Amazon Connect instance, all underlying resources in Amazon Connect, such as routing profiles, queues, will not inherit the instance tags. To learn how to control granular access to specific resources in Amazon Connect, see how to configure more granular access by using [tag-based access control](#).

Set up granular billing for a detailed view of your Amazon Connect usage

By default bills for Amazon Connect channels (voice calls, chat, and tasks) are summarized at the AWS account level by usage type. For example:

- Voice calls - by outbound (telephony) / inbound (telephony) / service minutes
- Chat – by messages
- Task - by units

To obtain a more detailed view of your bill and usage, you can add cost allocation tags (key:value pairs) to contacts, and then use the tags to aggregate and analyze the data in the AWS Billing and Cost Management console.

- Amazon Connect automatically adds the following system-defined tags to each contact:
 - **aws:connect:instanceId:** This represents the ID of the Amazon Connect instance. If you have multiple instances under multiple AWS accounts for each line-of-business, you can view usage bills aggregated against different instances.
 - **(aws:connect:systemEndpoint):** This represents the your contact center number (the endpoint) that the customer reaches (inbound) or is reached from (outbound).

This AWS generated tag helps if you have multiple phone numbers used within your contact center. It enables you to group the costs associated against different phone numbers. For

example, group inbound phone numbers for incoming calls, and group outbound numbers that are used for making outbound calls.

- **aws:connect:transferredFromEndpoint:** This represents the outbound caller ID that the call was transferred from. You can see the third-party transfer call's usage bills aggregated against the telephone numbers that the calls were transferred from. Currently, this AWS generated tag is only added to contacts for third-party external transfer calls.
- You can add up to 6 user-defined tags. For example, department, cost center, or business unit. Use these tags to organize your AWS bill to reflect your own cost structure.

The following image shows two user-defined tags on the **Contact details** page: CostCenter and Department. It also shows two system-defined tags: instance ID and the contact center phone number (aws:connect:systemEndpoint).

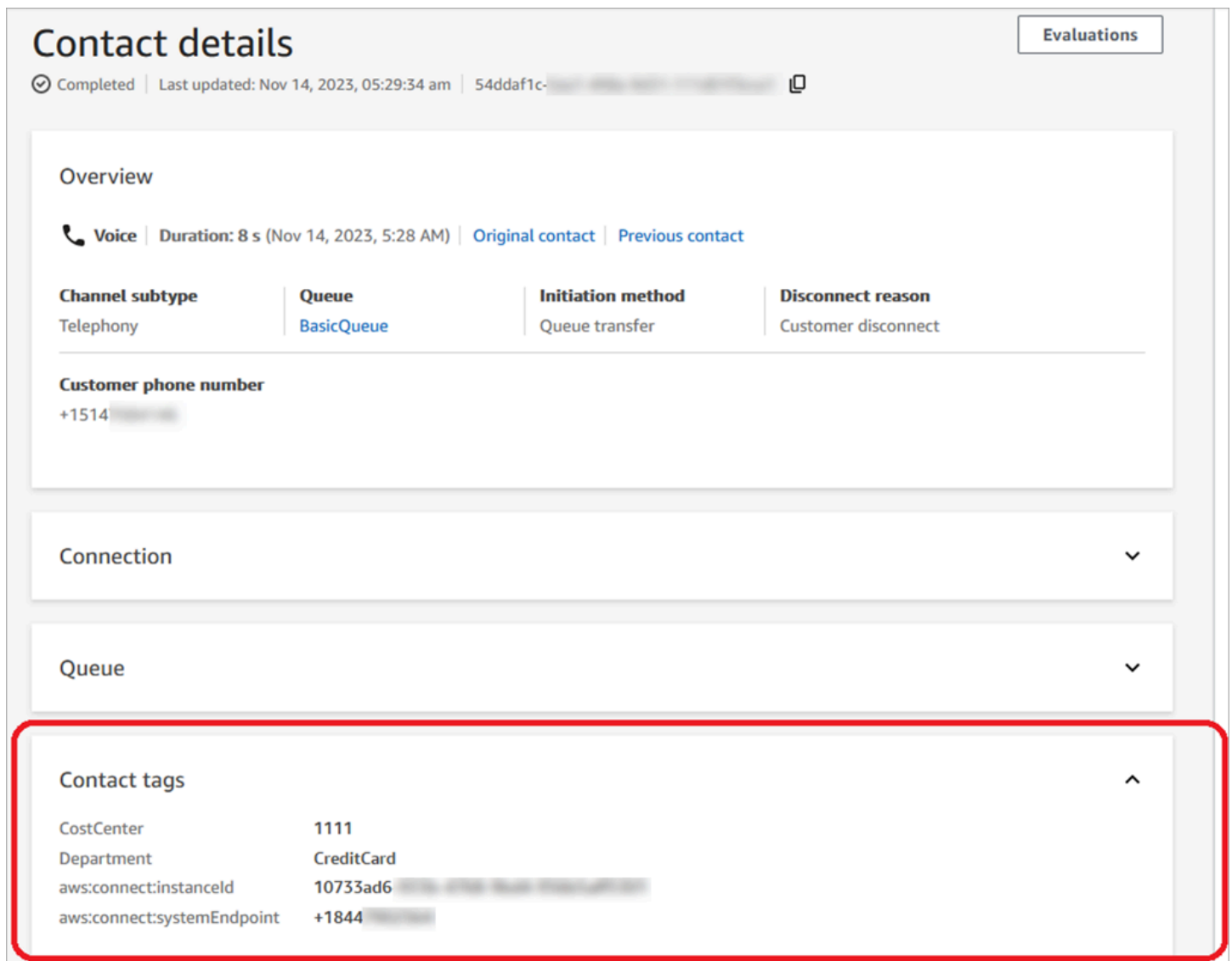

This topic explains how to add tags to contacts, activate the cost allocation tags, and view them in the AWS Billing dashboard.

Contents

- [Things to know about user-defined tags](#)
- [Step 1: Add user-defined tags to contacts](#)
- [Step 2: Activate cost allocation tags in the AWS Billing console](#)
- [Step 3: View cost and usage trends using cost allocation tags](#)
- [\(Optional\) Step 4: Enable Cost and Usage reports in the AWS Billing and Cost Management console](#)
- [More reporting options](#)

Things to know about user-defined tags

- Amazon Connect automatically applies user-defined tags to new contact segments for scenarios like transfers or contact re-hydration (for example, persistent chat, and tasks related to contacts).
- Use the [DescribeContact](#) API to list the tags on a contact.
- You can remove and/or overwrite the tags by using the [Contact tags](#) block or the [TagContact](#) and [UntagContact](#) APIs.
- By using the [TagContact](#) and [UntagContact](#) APIs, you can update user-defined tags for a contact up to 3 hours after the contact was disconnected. However, any future updates on the contact tags are not reflected in the billing system. For example, you make a change to the value of a tag within 3 hours after the contact was disconnected. The AWS Billing console will show the old value of the tag, but the S3 bucket and contact record have the new value.
- After you add tags to Amazon Connect, they are available across all contact interfaces: contact records, contact events, and the **Contact details** page. You can also access them by using the \$.Tags JSONPath Reference, and by using [Amazon Connect Streams](#).
- You cannot use tags as filters on the **Contact search** page. In addition, they cannot be included in any of the analytics or reporting pages.
- Contact tags only function as cost allocations tags. You cannot use them for tag-based access controls on contacts.

Step 1: Add user-defined tags to contacts

To add user-defined tags like Department and Cost Center to contacts, you have two options:

- Use the [TagContact](#) API.
- Add a [Contact tags](#) block to your flow.

The following image shows an example of a **Properties** page of a **Contact tags** block that is configured with a tag named **Department**. Its value is set manually to **Finance**.

Block Type ✕

Contact tags

Block Name

Enter a block name

0 / 50

Add or remove tags (key-value pairs) on the contact. [Learn more](#)

Select tag action

Tag ▼

i A contact can have up to 6 user defined tags. Both key and value of a tag must only contain Unicode letters, digits, white space and any of: `_.!/=+@-`

Enter tag key-value pairs to be applied on the contact

Enter tag key ✕

Department

Set manually

Enter tag value

Finance

Set dynamically

[Add another tag](#)

⚠ Important

Do not store personally identifiable information (PII) or other confidential or sensitive information in tags. We use contact tags to provide you with billing services. Tags are not intended to be used for private or sensitive data.

Step 2: Activate cost allocation tags in the AWS Billing console**💡 Tip**

It takes up to 24 hours for the tags to activate.

To enable AWS billing applications to organize your billing information according to resources with the same tag key values (either for system-defined and user-defined contact tags), you must activate the tags. Perform the following steps.

1. Open the AWS Billing console at <https://console.aws.amazon.com/billing/>.
2. In the left navigation menu, choose **Cost Allocation Tags**.
3. Select the system-defined and user-defined tags, and then choose **Activate**. It can take up to 24 hours for tags to activate.

The following image shows an example tag on the **Cost allocation tags** page.

The screenshot displays the AWS Billing console interface for Cost Allocation Tags. On the left, the navigation menu includes sections like 'Billing and Cost Management', 'Billing and Payments', 'Cost Analysis', 'Cost Organization', and 'Budgets and Planning'. The 'Cost Allocation Tags' option is selected and highlighted with a red arrow. The main content area shows the 'Cost allocation tags' page, which is divided into 'User-defined cost allocation tags' and 'AWS generated cost allocation tags'. The 'User-defined cost allocation tags' section shows a table with one tag: 'AmazonConnectEnabled'. The tag's status is 'Inactive', and it was last used in 'December 2023'. A red arrow points to the 'Activate' button above the table.

Step 3: View cost and usage trends using cost allocation tags

You can view the month-over-month trends at the granular level by using cost allocation tags.

1. Open the AWS Billing console at <https://console.aws.amazon.com/billing/>.
2. In the left navigation, choose **AWS Cost Explorer**.
3. On the **Cost Explorer** page, choose **Tags**, and then select the tags you want to view, for example, department or inbound telephone number.

The following image of AWS Cost Explorer shows a sample report where **department** is a filtered cost allocation tag.

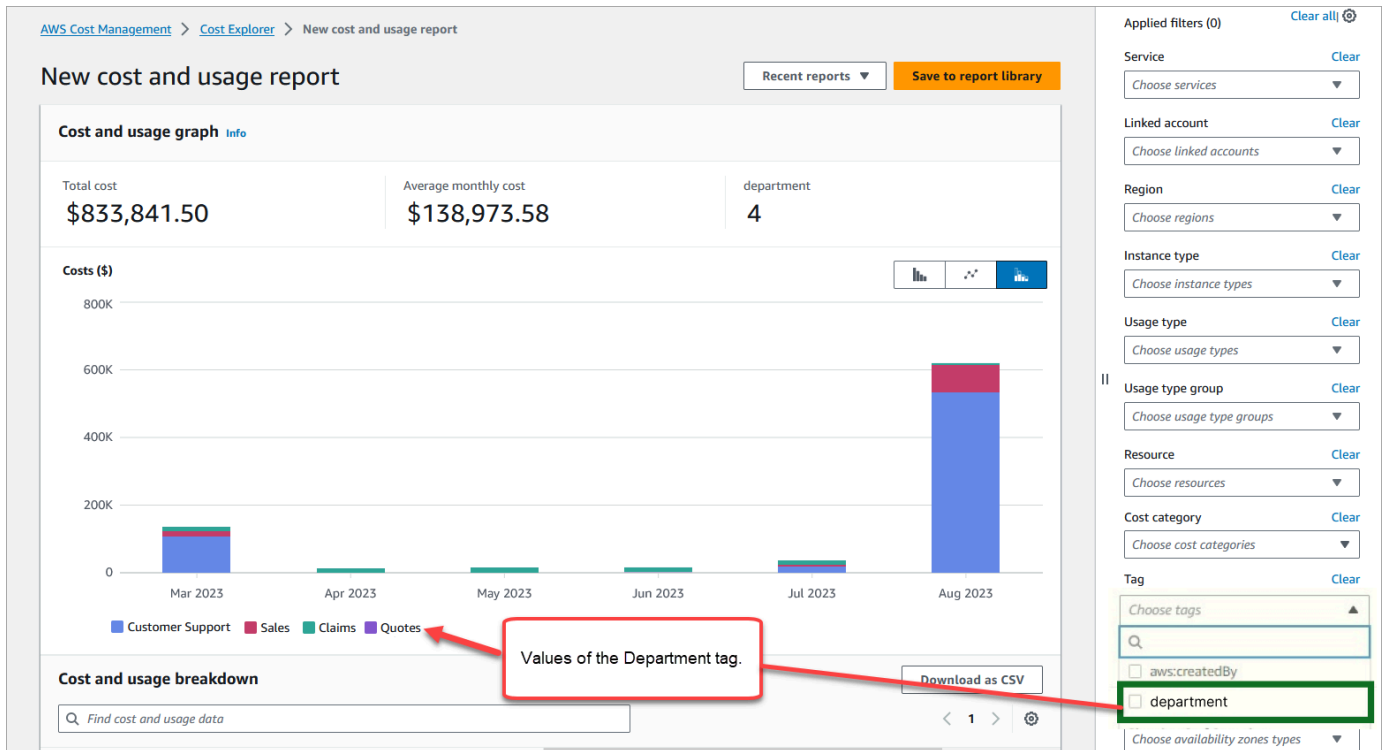

If you use the AWS account level bill summary to view the service level cost breakdown in the AWS Billing dashboard, you won't see any changes on the dashboard after implementing contact tags. The following image shows an example AWS Billing dashboard.

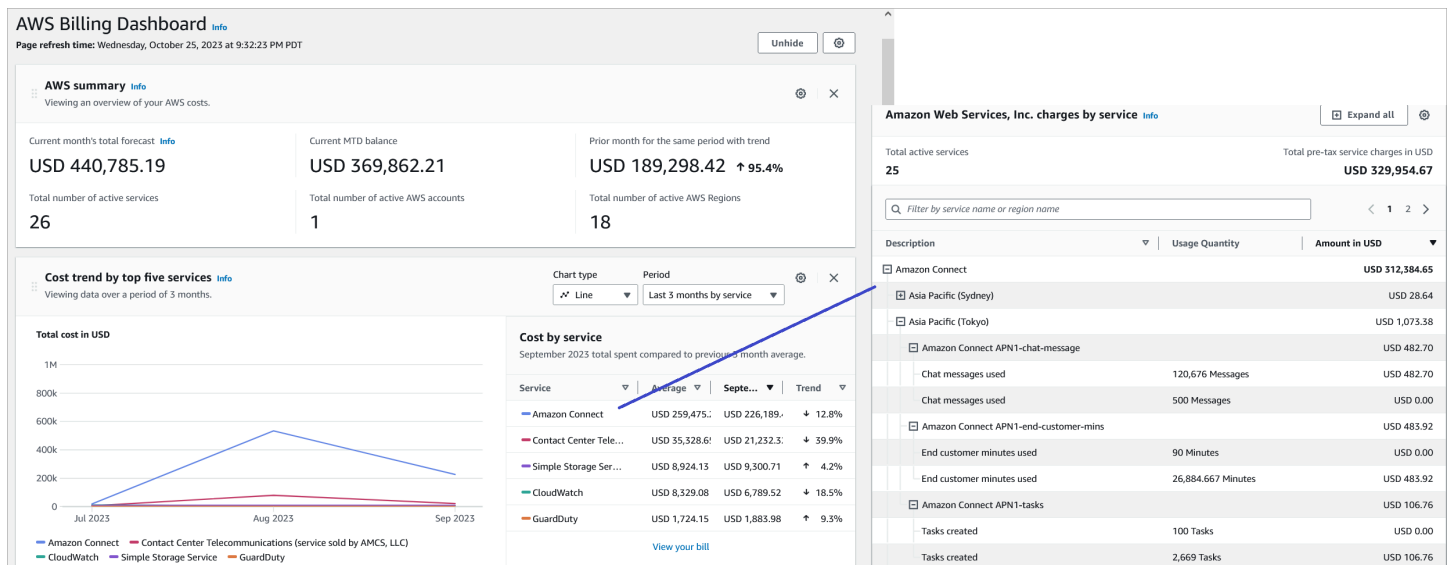

For more information about using AWS Cost Explorer, see [Analyzing your costs with AWS Cost Explorer](#) in the *AWS Cost Management User Guide*.

(Optional) Step 4: Enable Cost and Usage reports in the AWS Billing and Cost Management console

You can enable AWS Cost and Usage reports on the AWS Billing and Cost Management console, and configure your S3 bucket to export data to along with time granularity for reports (hourly, daily, monthly). After you set this up, you will receive reports with tags in additional columns. By default reports are aggregated by usage-type and tags.

For instructions, see [Creating Cost and Usage Reports](#) in the *AWS Data Exports User Guide*.

The following image shows what a Cost and Usage report looks like with columns for system and user-defined tags.

Total usage Amount			System-defined Tags		User-defined Tags	
lineltem/ProductCode	lineltem/UsageType	lineltem/UsageAmount	aws:connect:systemEndpoint	aws:connect:instanceId	CostCenter	Department
AmazonConnect	APN1-tasks	358.6293583		10733ad6.....aff5301	1111	CreditCard
AmazonConnect	APN1-end-customer-mins	60.571675	xxxxx1432	10733ad6.....aff5301	2222	CreditCard
AmazonConnect	APN1-end-customer-mins	10.7	xxxxx1432	10733ad6.....aff5301	2222	DebitCard
AmazonConnect	APN1-end-customer-mins	31.35	xxxxx1432	10733ad6.....aff5301	4444	Insurance
AmazonConnect	APN1-end-customer-mins	50.51666667	xxxxx1432	10733ad6.....aff5301	4444	Insurance
AmazonConnect	APN1-end-customer-mins	41.26666667	xxxxx1432	10733ad6.....aff5301	3333	PersonalBanking
ContactCenterTelecomm	APN1-US-did-inbound-mins	5	xxxxx1432	10733ad6.....aff5301	2222	CreditCard
ContactCenterTelecomm	APN1-US-did-inbound-mins	93.57681667	xxxxx1432	10733ad6.....aff5301	1111	CreditCard
ContactCenterTelecomm	APN1-US-did-inbound-mins	37.2142	xxxxx1432	10733ad6.....aff5301	2222	DebitCard
ContactCenterTelecomm	APN1-US-did-inbound-mins	4	xxxxx1432	10733ad6.....aff5301	4444	Insurance
ContactCenterTelecomm	APN1-US-did-inbound-mins	13	xxxxx1432	10733ad6.....aff5301	3333	PersonalBanking
AmazonConnect	APN1-end-customer-mins	10.43333333	xxxxx3932	10733ad6.....aff5301	1111	CreditCard
ContactCenterTelecomm	APN1-US-tollfree-inbound-mins	1	xxxxx3932	10733ad6.....aff5301	1111	CreditCard

The following image shows what a cost and usage report looks like without system or user-defined tags.

Total usage Amount		
lineltem/ProductCode	lineltem/UsageType	lineltem/UsageAmount
AmazonConnect	APN1-tasks	358.6293583
AmazonConnect	APN1-end-customer-mins	4
AmazonConnect	APN1-end-customer-mins	200.8383417
ContactCenterTelecomm	APN1-US-did-inbound-mins	152.7910167
ContactCenterTelecomm	APN1-US-tollfree-inbound-mins	1

More reporting options

Another option is to view usage data for each contact. You can enable contact resource IDs to appear on your cost and usage reports in the AWS Billing and Cost Management console. After choosing this option, you will receive detailed reports in your S3 buckets, and the data will be categorized by each contact resource ID. You can use the reports for analysis by third-party applications.

Note

Including resource IDs creates individual line items for each of your resources. This might increase the size of your Cost and Usage Reports files significantly, based on your AWS usage.

The following image shows where you enable **Include resource IDs** on the AWS Billing console.

The screenshot shows the 'Set delivery options' page in the AWS Billing console. The page is divided into several sections:

- Report name:** A text input field containing 'July2023'. Below it, a note states: 'Report name must be unique, not include spaces, and contain only alphanumeric and characters ! - _ * {}'.
- Report content:** A section with a description: 'AWS Cost and Usage Reports track your AWS usage and provide estimated charges associated with your account. Each report contains line items for each unique combination of AWS products, usage type, and operation that you use in your AWS account.'
 - Default content:** A list of checkboxes, all of which are checked:
 - Account identifiers
 - Invoice and Bill Information
 - Usage amount and unit
 - Rates and cost
 - Product attributes (instance type, operating system, and region)
 - Pricing attributes (offer types and lease lengths)
 - Reservation identifiers and related details (for Reserved Instances only)
 - Additional content:**
 - Include resource IDs**: When resources are created, AWS assigns each resource a unique resource ID. Including individual resource IDs in your report can significantly increase the file size.
 - Split cost allocation data**: Include detailed cost and usage for shared resources (only available for Amazon ECS). These resources are primarily used for cost allocation and aren't available in billing or invoice reports. Including these resources introduces new rows and columns in the Cost and Usage Report and might increase file size.
- Report data processing settings:**
 - Data refresh settings:**
 - Refresh automatically**: AWS updates the report in your bucket at least once a day. When a report refreshes, a new report is uploaded to...
- Report delivery options:**
 - SS path prefix - required:** A text input field containing 'myS3PathPrefix'.
 - Report data time granularity:** Radio buttons for 'Hourly' (selected), 'Daily', and 'Monthly'.
 - Report versioning:**
 - Create new report version**: Delivering new report versions can improve audibility of billing data over time.
 - Overwrite existing report**: Overwriting reports can save on Amazon S3 storage costs.
 - Report data integration:**
 - Amazon Athena
 - Amazon Redshift
 - Amazon QuickSight
 - Compression type:** A dropdown menu set to 'GZIP'. Below it, the file format is 'text/csv'.

The following image shows a sample cost and usage report when **Include resource IDs** is enabled.

		Total usage Amount	358.6293583	System-defined Tags		User-defined Tags	
lineItem/ProductCode	lineItem/UsageType	ResourceID (Contact ID)	lineItem/UsageAmount	aws:connect:customer ConnectedEndpoint	aws:connect:instanceId aws:connect:instanceId	CostCenter	Department
AmazonConnect	APN1-tasks	27d0b		1	10733ad6.....aff5301	1111	CreditCard
AmazonConnect	APN1-end-customer-mins	ded9f	0.433333333	1240995	10733ad6.....aff5301	1111	CreditCard
AmazonConnect	APN1-end-customer-mins	09a6c	0.45	1240995	10733ad6.....aff5301	1111	CreditCard
AmazonConnect	APN1-end-customer-mins	0b4d4	1.116666667	1240995	10733ad6.....aff5301	1111	CreditCard
AmazonConnect	APN1-end-customer-mins	1291e	0.5	1240995	10733ad6.....aff5301	1111	CreditCard
AmazonConnect	APN1-end-customer-mins	25804	0.416666667	1240995	10733ad6.....aff5301	1111	CreditCard
AmazonConnect	APN1-end-customer-mins	2dbc7	0.2	1240995	10733ad6.....aff5301	1111	CreditCard
AmazonConnect	APN1-end-customer-mins	cbb2f	1.15	1240995	10733ad6.....aff5301	1111	CreditCard
AmazonConnect	APN1-end-customer-mins	d89cc	0.266666667	1240995	10733ad6.....aff5301	1111	CreditCard
AmazonConnect	APN1-end-customer-mins	b9f5f	0.85	1240995	10733ad6.....aff5301	2222	DebitCard
AmazonConnect	APN1-end-customer-mins	cc4cf	0.5	1240995	10733ad6.....aff5301	2222	DebitCard
AmazonConnect	APN1-end-customer-mins	ea435	0.516666667	1240995	10733ad6.....aff5301	4444	Insurance
AmazonConnect	APN1-end-customer-mins	6574e	0.5	1240995	10733ad6.....aff5301	3333	PersonalBanking
AmazonConnect	APN1-end-customer-mins	9c4a2	0.383333333	1240995	10733ad6.....aff5301	3333	PersonalBanking
AmazonConnect	APN1-end-customer-mins	9cd39	0.383333333	1240995	10733ad6.....aff5301	3333	PersonalBanking
ContactCenterTelecomm	APN1-US-did-inbound-mins	ded9f	1	1240995	10733ad6.....aff5301	1111	CreditCard
ContactCenterTelecomm	APN1-US-did-inbound-mins	09a6c	1	1240995	10733ad6.....aff5301	1111	CreditCard
ContactCenterTelecomm	APN1-US-did-inbound-mins	1291e	1	1240995	10733ad6.....aff5301	1111	CreditCard
ContactCenterTelecomm	APN1-US-did-inbound-mins	b9f5f	1	1240995	10733ad6.....aff5301	2222	DebitCard
ContactCenterTelecomm	APN1-US-did-inbound-mins	cc4cf	1	1240995	10733ad6.....aff5301	2222	DebitCard
ContactCenterTelecomm	APN1-US-did-inbound-mins	ea435	1	1240995	10733ad6.....aff5301	4444	Insurance
ContactCenterTelecomm	APN1-US-did-inbound-mins	6574e	1	1240995	10733ad6.....aff5301	3333	PersonalBanking
ContactCenterTelecomm	APN1-US-did-inbound-mins	9c4a2	1	1240995	10733ad6.....aff5301	3333	PersonalBanking
ContactCenterTelecomm	APN1-US-did-inbound-mins	9cd39	1	1240995	10733ad6.....aff5301	3333	PersonalBanking
AmazonConnect	APN1-end-customer-mins	26c80	0.488341667	1240995	10733ad6.....aff5301	1111	CreditCard
AmazonConnect	APN1-end-customer-mins	590cd	0.5	1240995	10733ad6.....aff5301	1111	CreditCard
AmazonConnect	APN1-end-customer-mins	64385	0.166666667	1240995	10733ad6.....aff5301	1111	CreditCard
AmazonConnect	APN1-end-customer-mins	7100c	0.166666667	1833823	10733ad6.....aff5301	1111	CreditCard
AmazonConnect	APN1-end-customer-mins	72cc2	0.266666667	1833823	10733ad6.....aff5301	1111	CreditCard
AmazonConnect	APN1-end-customer-mins	8388c	0.466666667	1240995	10733ad6.....aff5301	1111	CreditCard
AmazonConnect	APN1-end-customer-mins	bc948	1.116666667	1240995	10733ad6.....aff5301	1111	CreditCard

For instructions for this option, see [Creating Cost and Usage Reports](#) in the *AWS Data Exports User Guide*.

Test voice, chat, and task experiences

To learn what the voice, chat, and task experiences are like for your agents and customers, you can test them without doing any development.

Test voice

At the basic level, after you claim a number you can immediately call it to hear what the experience will be like for your customers. Amazon Connect uses the [default flows](#) to power your initial experience.

To test a customized flow, [assign a phone number](#) to it and then call that number.

Tip

Call latency significantly impacts the quality of your customer's experience. For guidance about designing your contact center for optimal call quality and then testing latency, see [Ensure call quality: Design your contact center for low latency](#).

Test chat

Amazon Connect includes a simulated web page that shows how your customers can interact with you, and a Contact Control Panel (CCP) that shows the agent experience. Here's how to test chat:

1. On the navigation menu, choose **Dashboard**, as shown in the following image.

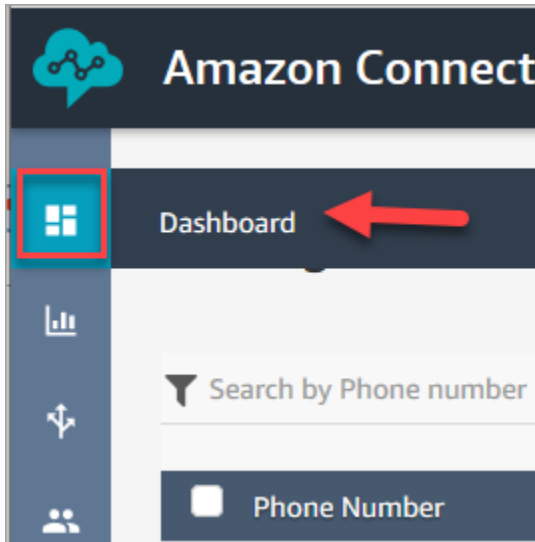

2. Choose **Test chat**.

If you don't see the option to test chat, click [here](#).

3. On the **Test Chat** page, choose **Test Settings**.
4. Under **System Settings**, choose the flow you want to test with chat, and then click **Apply**. By default, it runs the [Sample inbound flow](#).

Tip

If you want to test a chat and use contact attributes, note that the key and value pair must be enclosed in quotes, as shown in the following image:

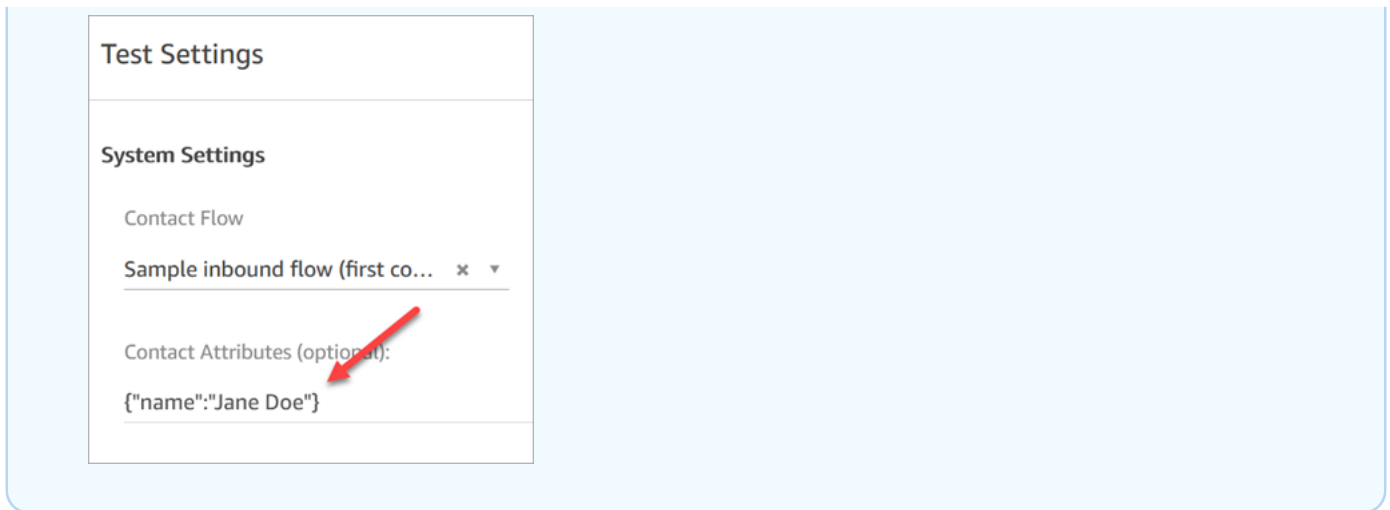

5. In the chat window, click the icon as shown in the following image.

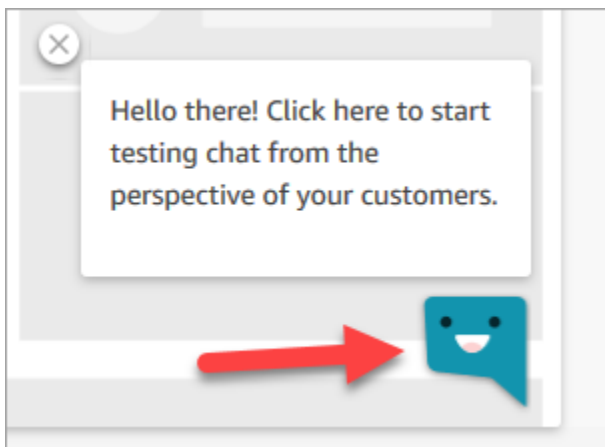

6. Type a message similar to what one of your customers might type. In the agent window, type a reply.
7. To see what it's like for an agent to handle multiple chat conversations, copy the dashboard URL into another browser window, and start another chat. The chat goes to the same instance of the CCP that you already have open.

Tip

The test environment uses the BasicQueue and Basic Routing Profile. The Basic Routing Profile is set up for 2 chats. If you want to test what it's like to have more than two chats, change the Basic Routing Profile to 5 chats. For instructions, see [Create a routing profile](#).

To learn more about what the agent experiences when managing chat conversations, see [How to use the CCP to manage chats](#).

Test tasks

The first step in testing the task experience is to create a quick connect for the queue you want to assign the example tasks to.

Step 1: Create a quick connect

1. On the navigation menu, choose **Routing, Quick connects, Add a new**.
2. Enter a name for the quick connect. For example, if you want to assign the test task to yourself, enter your name (for example, **Jane Doe**).
3. Under **Type**, use the dropdown list to choose **Queue**.
4. Under **Destination**, use the dropdown list to choose a queue you set up for yourself (assuming you want to assign the test task to yourself).
5. Under **flow**, choose **Default queue transfer**.
6. Under **Description**, enter something like **Test quick connect**.
7. Choose **Save**. The completed quick connect looks similar to the quick connect in the following image.

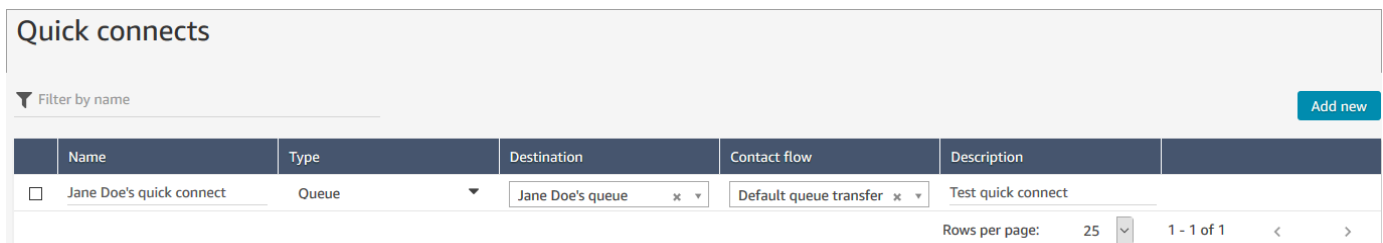

The screenshot shows a table titled 'Quick connects' with a search filter 'Filter by name' and an 'Add new' button. The table has the following columns: Name, Type, Destination, Contact flow, and Description. A single row is visible with the following data:

Name	Type	Destination	Contact flow	Description
<input type="checkbox"/> Jane Doe's quick connect	Queue	Jane Doe's queue	Default queue transfer	Test quick connect

At the bottom right of the table, there is a 'Rows per page' dropdown set to 25, and a pagination indicator showing '1 - 1 of 1'.

Step 2: Make the quick connect visible in the CCP by assigning it to a queue

1. After you create the quick connect, go to **Routing, Queues** and then choose the appropriate queue for the contact to be routed to.
2. On the **Edit queue** page, in the **Quick connects** box, search for the quick connect you created. For example, it might have your name. The following image shows the quick connect for Jane Doe.

Edit queue

Name
Jane Doe's queue

Description
Jane Doe's queue
234 of 250 characters remaining.

[Show additional queue information](#)

Quick connects (optional)



Quick connects available to this queue

3. Select the quick connect and then choose **Save**.

Step 3: Assign the queue to the agent's routing profile

1. Go to **Users, Routing profiles** and choose the agent's routing profile.
2. Under **Set channels and concurrency** choose **Tasks**.
3. Add the agent's queue to the routing profile, and choose **Task** for the channel.

If the agent can receive transfers through other channels, select them as well.

4. Choose **Save**.

Step 4: Test tasks

1. Open the CCP. Select the **Task** tab, and then choose **Create task**. The following image shows there are two ways to choose **Create task**: choose the task icon in the top right corner, or choose the **Create task** button at the bottom of the CCP page.

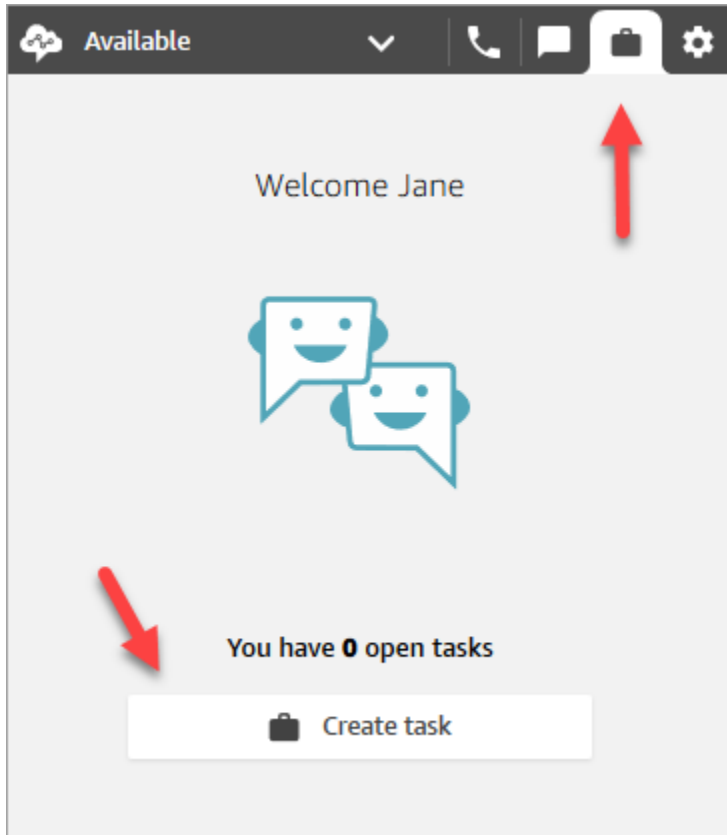

Or, if you're testing the chat experience, for example, you can choose the **Task** icon, as shown in the following image.

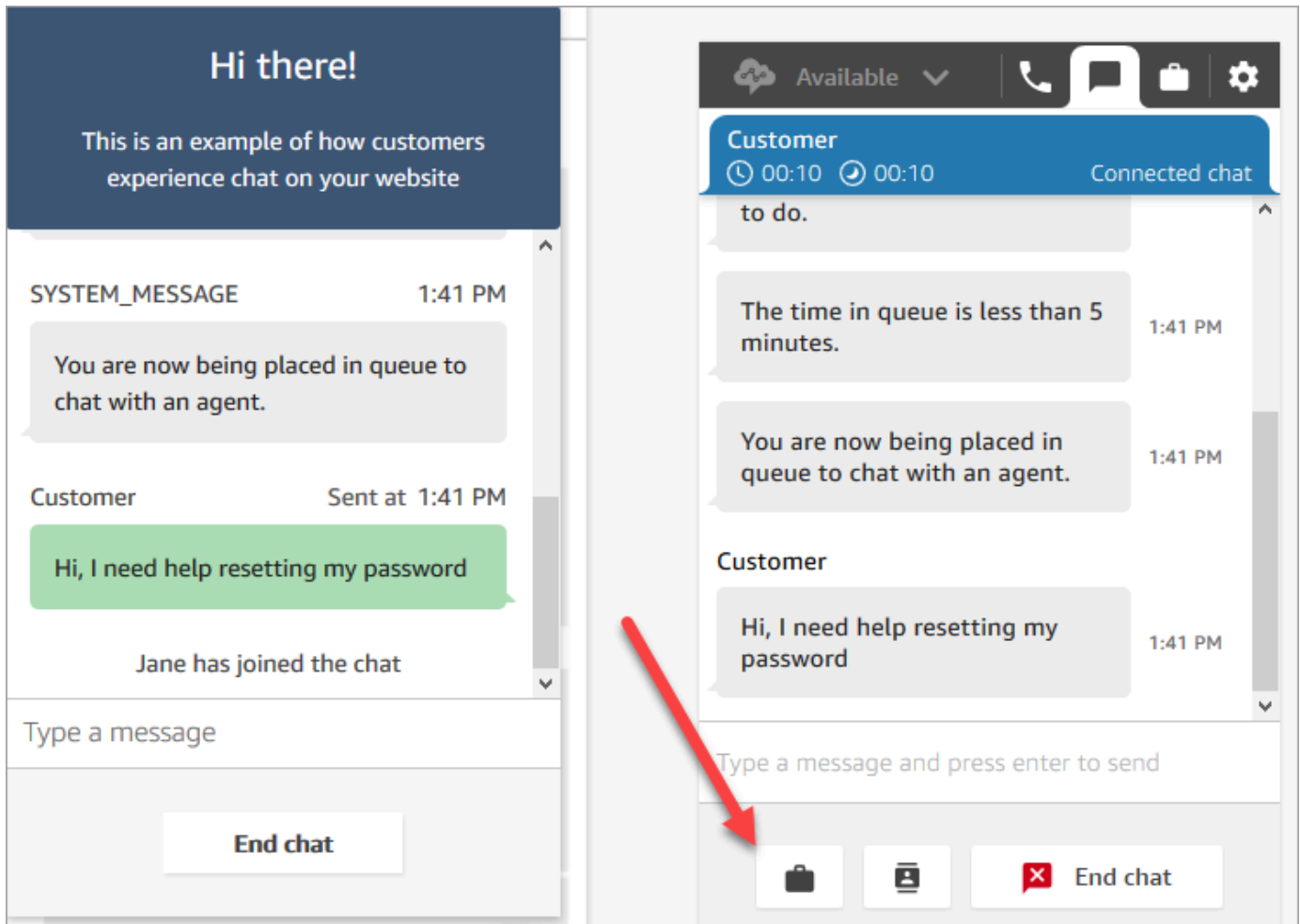

2. Complete the **Create task** page. When you choose **Assign to**, you can assign only a task to someone or a queue that has quick connect.

To create a scheduled task for the future, use the **Scheduled date/time** box to choose a future date and time. You can schedule a task up to six days in future.

Choose **Create**.

The screenshot shows a 'Create task' dialog box. At the top, it says 'Available' with a status icon. The dialog has a close button (X) in the top right corner. The fields are as follows:

- Task name:** Customer follow up (18 / 150 characters)
- Description (Optional):** Follow up with Carlos Salazar at (555) 555-5555 (47 / 4096 characters)
- References:** A section with a close button (X) containing:
 - Reference name:** Attachment
 - Link:** https://example.com
- Add reference:** A blue link.
- Assign to:** Jane Doe's quick connect (dropdown menu)
- Scheduled date / time (Optional):** A field with a calendar icon for the date and a dropdown for the time (currently set to AM). A red arrow points to this field.
- Time zone:** Select time zone (dropdown menu)
- Buttons:** Cancel and Create (blue) at the bottom right. A red arrow points to the Create button.

3. If you chose yourself, the task will be routed to you. The following image of the CCP shows what it looks like when a task arrives. Choose **Accept task**.

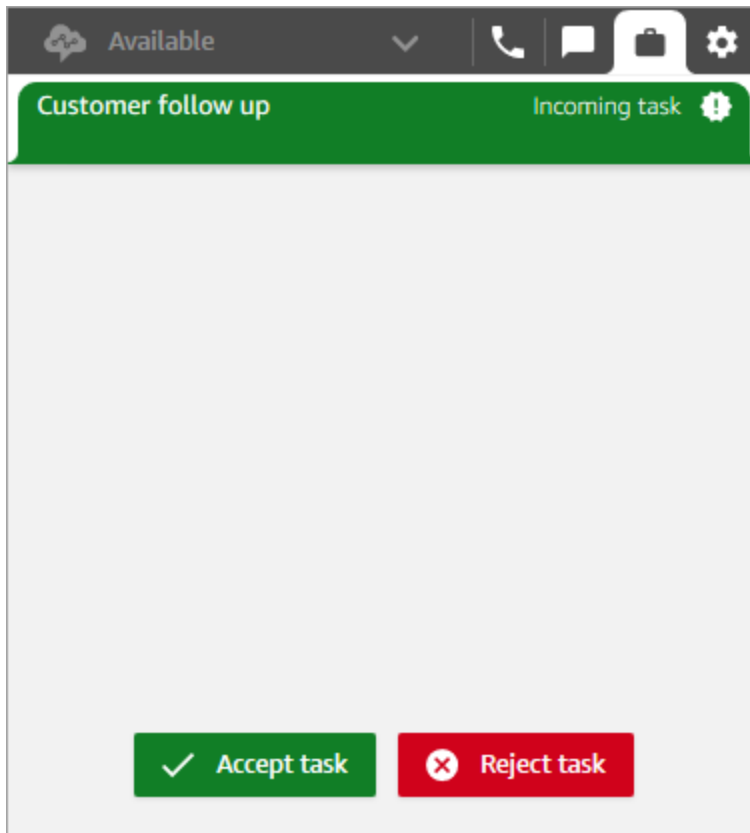

4. Review the task. When you're done with the task, choose **End task** when done.

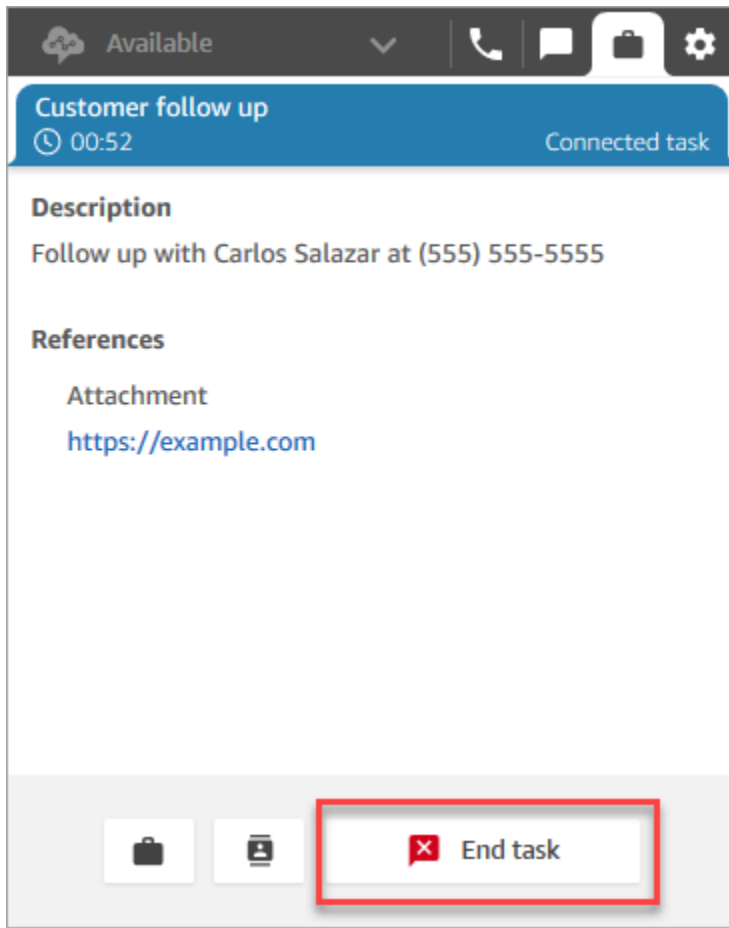

View metrics for the test experiences

When you're testing the voice, chat, and task experiences, you may also want to explore metrics.

1. On the left navigation menu, choose **Analytics and optimization, Real-time metrics, Queues**.
2. You can review the real-time metrics as you test the different channels.
3. To view metrics by channel in a real-time metrics report, go to **Settings, Groupings, Queues grouped by channels, Apply**. Your report will look similar to the following image.

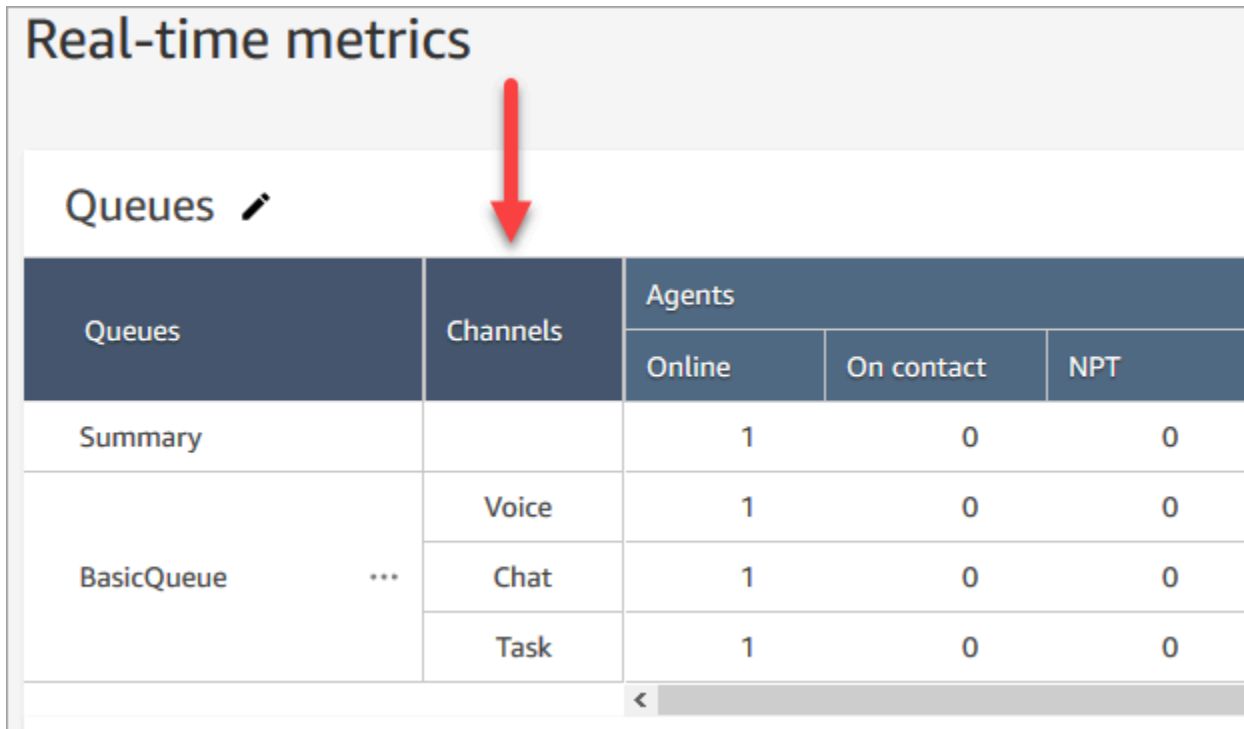

Real-time metrics

Queues 

Queues	Channels	Agents		
		Online	On contact	NPT
Summary		1	0	0
BasicQueue ...	Voice	1	0	0
	Chat	1	0	0
	Task	1	0	0

Set up phone numbers to use the Amazon Connect service

After you create an Amazon Connect instance, you can get a phone number to use for your contact center. You can use this phone number to place a test call in to your contact center to confirm that it is working correctly. You can also use it in your production environment.

- For pricing information about claimed phone numbers, see [Amazon Connect pricing](#).
- For a list of the telephony capabilities that Amazon Connect provides, see the [Amazon Connect Telecoms Country Coverage Guide](#).

If you want to keep a phone number you already have, you can port the phone number and use it with Amazon Connect. After a phone number is ported to Amazon Connect, it appears in the list of available phone numbers for you to assign to flows.

Contents

- [Port your current phone number to Amazon Connect](#)
- [Claim and manage your numbers](#)
- [Use caller identification to personalize customer interaction](#)
- [Map third-party numbers to your Amazon Connect account](#)

- [UIFN service - Inbound only](#)
- [Region requirements for ordering and porting phone numbers](#)

Port your current phone number to Amazon Connect

You can port your existing phone numbers to your Amazon Connect contact center.

Contents

- [Things to know before porting a phone number to Amazon Connect](#)
- [Things to know about South Korean numbers, regulations, and porting](#)
- [Porting your phone numbers](#)
- [After the porting process completes](#)

Things to know before porting a phone number to Amazon Connect

The topics in this section explain which numbers can be ported, how long it takes, and what fees you might incur.

Contents

- [What is phone number porting?](#)
- [How much does number porting cost?](#)
- [Can my number be ported to Amazon Connect?](#)
- [How long does it take to port numbers?](#)
- [Can I cancel a porting that is already scheduled?](#)
- [When do I cancel my current telecom service?](#)

What is phone number porting?

Porting a phone number is the process of moving a phone number from one telephony service provider, or carrier, to another. Many businesses and organizations already have a phone number that is advertised to their customers, so changing this number would be disruptive.

If you port a phone number from your current carrier to Amazon Connect, you can keep using the same phone number for your contact center. This helps to eliminate the need to update your business contact information.

Downtime and service disruption during the porting process

The porting process requires the losing carrier to remove your number from their systems, the winning carrier to add your number to their systems, and for number routing to be updated. Most porting activities complete within 15-30 minutes, with possible call disruptions. To ensure that they have engineers available to troubleshoot issues, most losing carriers complete porting actions only during normal business hours. Carriers typically communicate a two-hour porting window to resolve any issues that could arise.

For detailed information about available porting dates and times, see [Region requirements for ordering and porting phone numbers](#) for your country or region.

What happens to a number after it is ported

As long as you continue to pay for the phone number, and do not release it from your Amazon Connect instance, it stays assigned to your account, and you are billed accordingly.

To release a phone number, follow the steps in [Release a phone number from Amazon Connect back to inventory](#).

When a phone number is released from your Amazon Connect instance:

- You will no longer be charged for it.
- You cannot reclaim the phone number.
- Amazon Connect reserves the right to allow it to be claimed by another customer.

If you move your contact center away from Amazon Connect, and want to port your phone number away from Amazon Connect, see [Port phone numbers away from Amazon Connect](#).

How much does number porting cost?

Amazon Connect does not charge fees for porting numbers. Your existing carrier may have fees associated with the disconnection and early termination of your service.

After a phone number is ported to Amazon Connect, standard pricing applies for [Amazon Connect service usage and associated telephony rates](#).

Can my number be ported to Amazon Connect?

Not all phone numbers can be ported. The ability to port a specific phone number depends on several factors. For example:

- The regulations in the country or region of the phone number.
- Agreements between the losing and winning carriers.
- The type of phone number being ported.
- Your service contract with your current service provider.

To find out if a phone number that you currently own—whether local, mobile, or toll-free—can be ported to Amazon Connect:

1. See if your country or region supports number porting: [Region requirements for ordering and porting phone numbers](#).
2. Then get started by [submitting an Amazon Connect support ticket for number verification](#).

Porting numbers purchased from other contact center providers

In most cases, you can port numbers that were purchased from other contact center providers. Confirm with your current contact center provider who holds the assignment to the number, and work with them to ensure the correct information is provided in the Letter of Authorization (LOA).

Port short phone numbers

Because of Telecom regulations in various countries or regions, the short phone number will need to be evaluated on a case-by-case basis. To verify if your phone number can be ported to Amazon Connect, [submit an Amazon Connect support ticket](#).

Port a number to one EU Region only

The Amazon Connect Regions of EU-CENTRAL-1 and EU-WEST-2 are symmetrical European Regions that offer the same carrier coverage for telephony. If a phone number cannot be ported to an instance in one of these Regions, then it cannot be ported to an instance in the other.

If you had a phone number ported into the EU-CENTRAL-1 or EU-WEST-2 Regions, and want to move it to the other Region, [submit an Amazon Connect support ticket](#) for assistance.

The same is true for the North America Regions of US-EAST-1 and US-WEST-2.

Port a subset of numbers from a block

If you have a block of numbers, in some instances Amazon Connect can port a subset or portion of your phone numbers. In other cases, it is required by the carrier to port full block of phone numbers.

If you want to port only a subset of the phone numbers you currently own to Amazon Connect, [submit an Amazon Connect support ticket](#) to verify whether the phone numbers can be ported. We will verify the actions that can be completed and assist you with next steps.

 **Note**

If you port only a subset of the phone numbers, you will still be liable for the remaining phone numbers with the original carrier and any associated fees.

If your intent is to release the remaining phone numbers not being ported to Amazon Connect, we recommend waiting until the requested porting has been completed to avoid any disruptions to service.

Letter of compromise

Before porting phone numbers, some customers ask for a letter of compromise stating that they will be allowed to move their phone numbers from Amazon Connect to another service, if their contact center moves. Because of Telecom regulations in various countries, the phone number will need to be evaluated on a case-by-case basis. To verify that your phone number can be ported to Amazon Connect, [submit a ticket to Amazon Connect support](#).

How long does it take to port numbers?

 **Important**

Open a porting request as far in advance of your pending go-live date as possible.

The amount of time that it takes to port numbers depends on the country, complexity of the request, the type and quantity of numbers being ported, and your current carrier. Telecom carriers also may implement porting block days because of holidays and network maintenance. Because of this, Amazon Connect requires porting requests to be open several months before pending go-live dates.

For a list of countries and their portability windows, see [Region requirements for ordering and porting phone numbers](#).

Inside the US and Canada

Phone numbers in the US or Canada typically take between two to four weeks to port, after phone number portability has been verified, and all required documents are correctly submitted to the carrier.

Outside the US and Canada

Phone numbers outside the US and Canada require between two to six months to complete the full porting process. This includes:

- Time for you to submit all the documents to AWS Support.
- Time for the Amazon Connect service provider to verify whether they can port all of the phone numbers that you have requested.
- Time for the losing provider to verify the provided documents.

After all documents are verified by the losing provider, the losing provider and the Amazon Connect service provider will schedule a mutually agreed date to port the numbers to Amazon Connect.

What affects porting timelines?

Porting timelines can be negatively impacted when incorrect information is provided on the required Letter of Authorization (LOA). This causes the LOA to be rejected and resets the porting timelines.

Port many numbers over multiple countries or carriers

Complex porting requests have their own timelines. The timelines discussed elsewhere in this topic do not apply to complex porting requests.

Complex porting requests for more than 10 distinct number ranges or 10 distinct locations are considered a project and require advanced coordination with your AWS Account team. If you are a Business or Enterprise customer, engage your Amazon Connect Solutions Architect (SA) or Technical Account Manager (TAM) for assistance in planning your number porting.

To help make the process as smooth as possible, gather the following information before submitting a porting request:

- Your most recent telephony bill from the carriers that currently service the numbers to be ported.

- The country specific documentation required; see [Region requirements for ordering and porting phone numbers](#).
- The contact information for a central point of contact who can act on behalf of your organization in support of the porting requests.

Can I choose the port date?

Important

The Amazon Connect service team supports porting phone numbers FROM 9am Monday in Sydney NSW, Australia Time, TO 5pm Friday in Seattle, WA, USA time.

Depending on the country and carriers involved, you may be able to choose the porting date and time. In most cases, however, the losing carrier picks the date and time and communicates it to Amazon Connect based on their schedule.

If you have a specific date and time you want to request, provide the information in your support case. We will work with our carrier to determine if they can support the requested date and time.

Note

Most carriers only support porting activity during their normal business hours. For detailed information about available porting dates and times for your country, see [Region requirements for ordering and porting phone numbers](#).

Can I cancel a porting that is already scheduled?

Important

If you need to cancel or reschedule your porting, let us know immediately.

Depending on the country of service, after a mutually agreed date and time has been provided it can be difficult to cancel.

Because of the coordination required between carriers, Amazon Connect support requires a minimum of 5 business days notice to cancel or reschedule a porting request, if the number has not already been ported. If you need to cancel or reschedule your porting, let us know immediately.

You cannot cancel a port after it has been moved to the RespOrg (Responsible Organization). The port is complete. For this situation, see [Revert to original carrier after porting](#).

If a porting is successfully cancelled, timelines for the port schedule are reset and the carriers will need to identify another mutually agreed date and time. This will impact the overall timeline for porting your numbers.

Note

Please be advised that sometimes a porting request cannot be cancelled because of process automation, but Amazon Connect support will make every attempt possible to stop the request.

When do I cancel my current telecom service?

Do not cancel your existing telecom service until your phone numbers have been ported and confirmed working in Amazon Connect.

Canceling your existing telecom service before your number is ported releases your phone number assignment, and may result in you losing the number.

Things to know about South Korean numbers, regulations, and porting

Rules for South Korea differ from those in other countries. To help with requirements in South Korea, here are some helpful hints.

- When planning your Amazon Connect project in South Korea one of the most important things you will need to do is plan and request information up front. To port numbers in South Korea, you may need to complete and submit more than 5 forms and you may need to engage with the local regulatory authority before approvals are granted to port numbers.
- All geographic numbers (that is, other than toll-free, national, representative, or 070 VOIP) must be in place on a physical termination for a minimum of 6 months before they can be ported into Amazon Connect. However, if a number has been in place for a minimum of 3 months, you can port it by filing a special request with the Korean Ministry of Telecommunications; upon

approval, the porting process can begin. Amazon Connect can provide you with the forms, but you must complete and submit them to the regulator directly.

- All geographic, representative, or toll-free numbers (GRTFN) are assigned a 070 VOIP number to which the GRTFN terminates and which are associated with the GRTFN at the carrier. Do not remove this 070 number from your Amazon Connect instance until the related GFTN number is removed. If you do, all inbound and outbound calls will fail.
- Representative numbers (RN) have minimum session billing requirements based on the "attractiveness" of the RN, as determined by the carrier. Representative numbers have different costs depending on the scale of the number. Based on the size of the representative number you order, the service will have from 2 channels to 500 channels minimum to be charged for. This is managed by adding a minimum number of numbers to the account, equal to the number of channels needed. These are shown on the [Amazon Connect pricing](#) page as the shared cost service at \$0.5433 per day of usage for the system. These additional shared cost number DIDs do not have the ability to be assigned call flows, and outbound calls from them will fail. If you disconnect RNs, be sure to also remove their associated Special Numbers to avoid future billing. Removal or reduction of Special Number DIDs without removal of the underlying RN is a violation of Amazon Connect Terms of Service.

Porting your phone numbers

Porting phone numbers from your existing carrier to Amazon Connect is a multi-step process. It's important to get started several months in advance of your scheduled go-live date, and have all of your documentation in order.

Contents

- [How to port your numbers to Amazon Connect](#)
- [Documentation requirements for porting numbers](#)
- [How to verify flows before numbers are ported](#)

How to port your numbers to Amazon Connect

The following steps are for a typical porting request. This process requires timely communication to make progress. If you take longer than 30 days to respond to requests for information, your porting request may be cancelled, rescheduled, or restarted from the beginning.

Documentation requirements: For a list of country-specific requirements for porting numbers, see [Region requirements for ordering and porting phone numbers](#).

Step 1: Create an Amazon Connect support case

1. Choose [Account and billing](#) to access a pre-populated form in the AWS Support console. You must be signed in to your AWS account to access the form.
2. For **Service**, *Connect (Number Management)* should be selected, as shown in the following image.

How can we help?

Choose the related issue for your case. [Looking for service quota increases?](#)

Account and billing
Assistance for your account, such as billing, pricing, and reserved instances.

Technical
Support for service-related technical issues, such as Amazon EC2, Amazon S3 and more.

Service
Connect (Number Management) ▼

Category
Number Porting North America (USA/Canada/Mexico) ▼

Severity [Info](#)
General question ▼

Cancel **Next step: Additional information**

3. For **Category**, choose *Number Porting North America (US/Canada/Mexico)* or *Number Porting Non-North America*.
4. Select the required severity.
5. Choose **Next step: Additional information**
6. On the **Additional information** page:
 - a. Enter the subject.

- b. Under **Description**, include as much information as possible about your request, including phone number(s) to be ported, your current carrier, and the contact information for the person authorized to make changes to your current phone service. If you don't know all of these details, you can leave information out.

⚠ Important

Do not attach any documents that contain personal information. After we review your case, we'll send you a link to our secured storage (Amazon S3) so you can submit required documents. This is described in [Step 3: Submit the required documents by using a link we provide to you](#).

7. Choose **Next step: Solve now or contact us**.
8. On the **Solve now or contact us** page:
 - Choose the **Contact us** tab and select your **Preferred contact language** and your preferred contact method.
9. Choose **Submit**.
10. The Amazon Connect team will review your ticket and get back to you.

Step 2: Complete Letter of Authorization (LOA)

If the phone number qualifies for porting, the Amazon Connect team will provide you a Letter of Authorization (LOA) to be completed by you. Complete all mandatory fields and sign the LOA.

Along with the LOA, Telecom regulations in many countries require additional documents to register a number, such as proof of business, proof of address, and proof of ID. For a list of country-specific requirements for porting numbers, see [Region requirements for ordering and porting phone numbers](#).

How to complete an LOA

All portings require the completion of a Letter of Authorization (LOA). The LOA authorizes your current carrier to release your number and allow it to be ported.

- If you are porting multiple numbers from different carriers and countries, submit separate tickets for each set of phone numbers to be ported from different carriers and different countries to streamline communications, tracking, and the LOA process.

- A separate LOA is required for numbers from each losing carrier.

To complete an LOA, provide the following information:

- The numbers to port.
- Information about your current carrier, such as their business name and contact information.
- Contact information for the person authorized to make changes to your phone service. The name, address, and information you provide on the LOA must match the information on file with your current carrier exactly. To help ensure the porting process goes smoothly, include a copy of the Customer Service Record (CSR) or latest phone bill from your carrier. This will have your name, address, and related telephone numbers on it. Check that the information on your LOA matches your CSR **exactly**.
- If you have any questions regarding specific details about your current service, consult with your current carrier to ensure the data is accurate. This will minimize the risk that the LOA is rejected.

Important

Your LOA form must meet the following criteria:

- It must be legible: clearly written or typed.
- It must list your company name, the company address, and contact name. This information must match what is on the current carrier's CSR.
- It must include a true signature. Most carriers will reject an electronic or printed signature.
- It must be dated within the last 15 days.
- If you also want to port toll-free numbers, it must include them as well. Up to 10 toll-free numbers can be listed on the LOA. If you are requesting more than 10 phone numbers be ported, a spreadsheet is required to be attached. Specify "See Attached" on the LOA where the phone numbers would be listed.
- It must include only those telephony numbers that belong to the same current carrier and in the same country. If you have multiple current carriers and countries, you will need to submit multiple LOAs.

To further minimize the risk of having your LOA rejected, see [Common reasons why carriers reject an LOA](#).

Step 3: Submit the required documents by using a link we provide to you

After the Amazon Connect team says you can port phone numbers, you need to submit any required documents. The following steps explain how.

Note

AWS Support provides a secure Amazon S3 link for uploading all requested documents. Do not proceed until you receive the link.

To submit required documents

1. Open the Amazon Connect console at <https://console.aws.amazon.com/connect/>.
2. Sign in to your AWS account, then open the Amazon S3 upload link generated specifically for your account.

Note

The link expires after ten days. It is generated specifically for the account that created the case. The link requires an authorized user from the account to perform the upload.

3. Choose **Add Files**, then select the documents required for your request.
4. Expand the Permissions section, and choose **Specify individual ACL permissions**.
5. At the end of the **Access control list (ACL)** section, choose **Add grantee**, then paste the key provided by AWS Support into the **Grantee** box.
6. Under **Objects**, choose the **Read** checkbox, then choose Upload.

After you provide the Letter of Authorization (LOA) and any other required documents, Amazon Connect team confirms with your existing phone carrier that the information on the LOA is correct. If the information provided on the LOA does not match the information that your phone carrier has on file, Amazon Connect team contacts you to update the information provided on the LOA.

Step 4: The porting request goes to the Amazon Connect carrier

After you have submitted all required documentation, the Amazon Connect team submits the porting request on your behalf to the winning carrier.

- The losing and winning carrier follow an industry standard process to validate the contents of the LOA and submitted documentation.
- If the LOA contains discrepancies, it will be rejected and you will need to fix the discrepancies and submit a new LOA.
- After the carriers successfully validate the LOA, they will either confirm your requested date or provide an available date for the actual porting. This is known as the "mutually agreed date."

Note

Most carriers require that portings are completed during normal business hours. For country-specific business hours, see [Region requirements for ordering and porting phone numbers](#).

Step 5: Assign the phone number to the flow, request service quota increases

About 3-4 days before the mutually agreed date and time, the Amazon Connect support team loads the phone number that will be ported into the instance ARN you have provided, and then notifies you. Now it's time for you to perform the following steps:

1. [Associate the phone number to the desired flow](#) so the phone number will be ready to receive phone calls after the porting is completed. If you require assistance assigning multiple phone numbers to flows, let us know in your support request.

Important

If you do not assign the phone number to the flow, calls will not arrive successfully to your Amazon Connect contact center.

2. [Submit a service quota request](#) at least five days in advance of the mutually agreed date for any changes to your service quotas required to support your use case. For example, you may need to increase the number of concurrent calls per instance, or enable countries for outbound calling.

Step 6: Checklist of activities on your porting date

The action of porting a number can be disruptive: the process involves updating the routing of phone numbers between carriers across a country or Region, including carriers not involved in the actual porting. In rare cases it can take several hours before all routes across all Telecom carriers are fully updated.

Steps you perform to minimize disruption to your phone services

On the mutually agreed port date, perform the following steps:

- Double-check that the activities listed in [Step 5](#) have been completed:
 1. Verify that you have assigned the number being ported into your Amazon Connect instance to the appropriate contact flow.
 2. Verify that any required service quota increases or changes for your Amazon Connect instance were implemented. For example, increase the number of concurrent calls per instance, or enable countries for outbound calling.
- Monitor call traffic from your existing contact center to confirm that incoming traffic has stopped.
- Place test calls to your Amazon Connect instance to verify calls are being routed to the correct flows.
- Ensure agents are logged in to the Contact Control Panel (CCP) and can answer calls as they are received.
- Monitor call traffic to your Amazon Connect instance to confirm that you are receiving the expected levels of traffic.

Steps the Amazon Connect team performs to ensure a smooth transition

1. After the Amazon Connect team receives confirmation that the porting has been completed, we will perform final testing to confirm that the porting was successful and the phone number is receiving calls to Amazon Connect.
2. After we have completed our testing, we will notify you and ask you to verify the successful completion of the porting.

Documentation requirements for porting numbers

The Letter of Authorization (LOA) is an industry standard document type used by carriers to authorize the transfer of a phone number from one carrier to another. In many cases, the LOA is specific to the country or region, carrier, or porting relationship between the losing and winning carriers.

If your number can be ported, the Amazon Connect team will provide you with the following:

- An LOA form appropriate for the situation.
- A link to a secure Amazon S3 storage so you can upload the LOA and any other required documents.

For more information, see [How to complete an LOA](#).

Additionally, regulations in some countries require a local business address and specific documentation to use a phone number. For country specific requirements, see [Region requirements for ordering and porting phone numbers](#). If this is required, we will ask for this information to be submitted with the completed LOA.

Common reasons why carriers reject an LOA

There are four common reasons that an LOA may be initially rejected by the losing carrier:

- Unsatisfactory business relationship

This usually means that you have an unpaid balance or the carrier charges a port away fee. After you pay the bill or fee to your carrier, we will resubmit the port request.

- Name or address mismatch

The information you submitted on your Letter of Authorization (LOA) is different from what's on file with your carrier in their Customer Service Record (CSR). To fix this, contact your existing carrier to update your CSR information, obtain the correct CSR information, or both. Let us know when they update your information and we will resubmit the port request. Or, send us a new LOA with the correct information as provided by your existing carrier.

- Number cannot be ported

We will work with all Amazon Connect carriers in a Region to support the porting of your numbers. In some cases, however, specific numbers may not be portable because of regulatory

restrictions or carrier limitations. In these situations, consider claiming a new number from Amazon Connect.

- **Missing information**

One or more fields have been left blank on the LOA. This may include a missing signature, phone number, address information, or other requested information. Review all LOAs before submitting them to ensure that you have filled out all requested data. After the LOA is updated with all the required information, we will resubmit the port request.

How to verify flows before numbers are ported

We recommend that you test your call flows before the mutually agreed date and time of porting. If you would like to test your call flows, we recommend that you claim a direct inward dial (DID) or toll-free phone number available within Amazon Connect and assign it to the call flow for testing.

When you are done testing, you can release the number from your instance so you will no longer be charged for it. For instructions, see [Release a phone number from Amazon Connect back to inventory](#).

Until you release the number, you are charged the daily rate associated with claiming a phone number and the per minute rate for telephony minutes used. For more information see the standard pricing for [Amazon Connect service usage and associated telephony rates](#).

After the porting process completes

After you have ported your numbers to Amazon Connect, use the topics in this section to troubleshoot issues, or to release numbers you no longer need after porting.

Contents

- [Not receiving calls on the ported number](#)
- [Release ported numbers that you no longer need](#)
- [Revert to original carrier after porting](#)
- [Port phone numbers away from Amazon Connect](#)

Not receiving calls on the ported number

After the scheduled porting window has completed, if you are not receiving phone calls on the ported phone number, update your support ticket. We will troubleshoot with our carrier to verify the porting status and identify the next steps to resolve issue.

Amazon Connect and our carriers make every effort to ensure number porting occurs with minimal downtime and without issues. In most cases, the losing carrier is responsible for initiating the number porting and releasing your number to the winning carrier.

In rare situations, a number routing issue can occur, resulting in calls not arriving to Amazon Connect from the carrier.

Release ported numbers that you no longer need

You do not have to keep phone numbers assigned to your Amazon Connect instance.

When a phone number is released from your Amazon Connect instance:

- You will no longer be charged for it.
- You cannot reclaim the phone number.
- Amazon Connect reserves the right to allow it to be claimed by another customer.

To release a phone number

1. Log in to Amazon Connect admin website with an Admin account or a user account that has **Phone numbers - Release** security profile permission.
2. On the navigation menu, choose **Channels, Phone numbers**. This option appears only if you have the **Phone numbers - View** permission in your security profile.
3. Choose the phone number you want to release, and then choose **Release**. This option appears only if you have the **Phone numbers - Release** permission in your security profile.

If the phone number is associated with a flow, that flow will be deactivated until another number is associated with it.

When customers call the phone number you have released, they will get a message that it is not a working phone number.

Revert to original carrier after porting

To complete the porting, the losing and gaining carriers both make configuration changes to pass the phone number ownership. After the porting is complete, the gaining carrier has sole control of the phone number.

To move the phone number again, you must complete a new LOA and any required documentation.

Port phone numbers away from Amazon Connect

1. Choose [Account and billing](#) to go to the pre-populated form in the AWS Support console. You must be signed in to your AWS account to access the form.
2. For **Service**, *Connect (Number Management)* should be selected.
3. For **Category**, *Phone Number Port Out* should be selected.
4. Select the required severity.
5. Choose **Next step: Additional information**
6. On the **Additional information** page:
 - a. Enter the subject.
 - b. Under **Description**:
 - i. Let us know you're porting away.
 - ii. The name of your Amazon Connect instance and the numbers you are porting away.
 - iii. The name of your new carrier.
7. Choose **Next step: Solve now or contact us**.
8. On the **Solve now or contact us** page:
 - Choose the **Contact us** tab and select your **Preferred contact language** and your preferred contact method.
9. Choose **Submit**.
10. The Amazon Connect team will review your ticket and get back to you.

Here's what happens next:

1. AWS Support contacts you, indicating that you should begin the process with the winning carrier.

2. The winning carrier will request that you provide them with following information:
 - Proof of ownership of the numbers you want to port away. Provide them with screenshots of the Amazon Connect instance with the phone numbers you want to port away, and screenshots of your AWS bill.
 - Usually the winning carrier will require a LOA (Letter of Authorization) that you need to complete. It's important that you provide the correct contact details from your AWS bill.
3. The winning carrier will send the request to AWS Support.
4. AWS Support will verify that the request from the winning carrier matches the information we have about who owns those numbers. If all details match **exactly**, we will approve the request.

Important

Verifying the authenticity of the winning carrier's port-out request is critical for the security of your phone number. If the contact details are not correct (for example, there's a name mismatch), your port-out request may be rejected, causing delays and requiring you to resubmit your request.

5. The winning carrier will complete the port-out request on the date and time that you establish with them. Work with the winning carrier to complete the remainder of the port-out process to ensure a seamless transition.

Claim and manage your numbers

The topics in this section explain how to claim an Amazon Connect phone number, list phone numbers claimed to your instance, move a phone number across Amazon Connect instances, and release a phone number.

Contents

- [How to get a Connect phone number in your current country](#)
- [Request an SMS-enabled phone number through Amazon Pinpoint SMS](#)
- [Claim a phone number you already own in another country](#)
- [List the phone numbers claimed to your Amazon Connect instance](#)
- [Claim phone numbers for Amazon Connect in the Asia Pacific \(Tokyo\) Region](#)
- [Request numbers, international numbers, or termination points](#)

- [Move a phone number across instances](#)
- [Release a phone number from Amazon Connect back to inventory](#)

How to get a Connect phone number in your current country

To place or receive calls in your Amazon Connect instance, you need to claim a DID or toll-free phone number. If you did not claim a phone number when you created your Amazon Connect instance, follow these steps to claim one now.

Claim a number for your contact center

1. Log in to Amazon Connect admin website with an Admin account, or an account assigned to a security profile that has **Phone numbers - Claim** permissions.
2. On the navigation menu, choose **Channels, Phone numbers**.
3. Choose **Claim a number**. You can choose a toll-free number or a Direct Inward Dialing (DID) number. If you're in the US, you can specify the area code you want for your number, and only available numbers with that area code will be displayed. When numbers are returned, choose one.

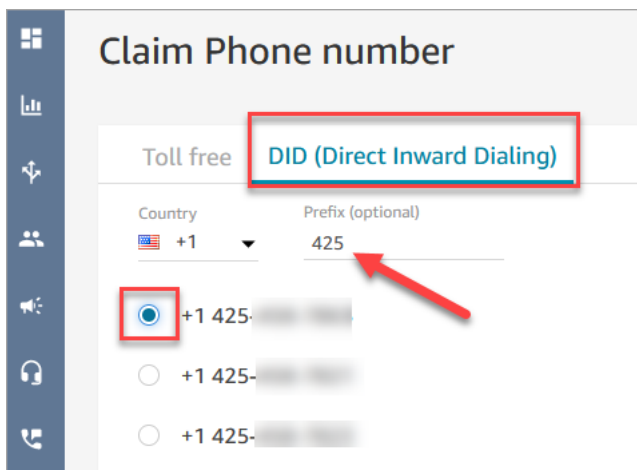

Note

Create a case by choosing the [Account and billing](#) option for these situations:

- If you select a country or region, but no numbers display, you can request additional numbers for the country or region.
- If you want to request a specific area code or prefix that you don't see listed, we'll try to accommodate your request.

The following image shows the **Account and billing** option on the **Create a case** page of the **Support Center** console.

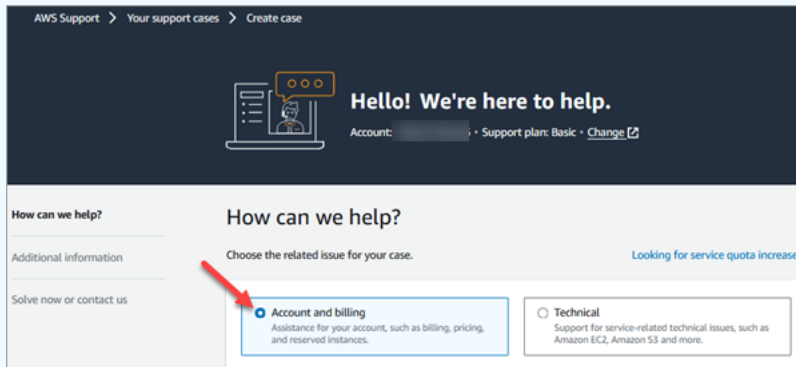

4. Enter a description for the number and, if required, attach it to a contact flow in **Flow / IVR**.
5. Choose **Save**.
6. Repeat this process until you have claimed all your required phone numbers.
7. After you claim your numbers, [associate them with your flow\(s\)](#). A flow defines the customer experience with your contact center from start to finish.

How many phone numbers you can claim

There is a service quota for how many phone numbers you can have in each instance. For the default service quota, see [Amazon Connect service quotas](#). If you reach your quota, but want a different phone number, you can release one of your previously claimed numbers. You cannot claim the same phone number after releasing it.

If you need more phone numbers, you can request a service quota increase using the [Amazon Connect service quota increase form](#).

Avoid being blocked from claiming or releasing too many numbers

If you plan to claim and release numbers frequently, contact us for a service quota exception. Otherwise, it's possible you will be blocked from claiming and releasing any more numbers until up to 180 days past the oldest number released has expired.

By default you can claim and release up to 200% of your maximum number of active phone numbers. If you claim and release phone numbers using the UI or API during a rolling 180 day cycle that exceeds 200% of your phone number service level quota, you will be blocked from claiming any more numbers until 180 days past the oldest number released has expired.

For example, if you already have 99 claimed numbers and a service level quota of 99 phone numbers, and in any 180 day period you release 99, claim 99, and then release 99, you will have exceeded the 200% limit. At that point you are blocked from claiming any more numbers until you open an AWS support ticket.

API instructions for claiming phone numbers

To claim a phone number programmatically:

1. Use the [SearchAvailablePhoneNumbers](#) API to search for available phone numbers that you can claim to your Amazon Connect instance.
2. Use [ClaimPhoneNumber](#) API to claim the phone number.

Claiming a number by using the [ClaimPhoneNumber](#) API puts the number in one of the following three states: CLAIMED, IN_PROGRESS, FAILED.

3. Run the [DescribePhoneNumber](#) API to determine the status of your number claiming process.
 - CLAIMED means the previous [ClaimPhoneNumber](#) or [UpdatePhoneNumber](#) operation succeeded.
 - IN_PROGRESS means a [ClaimPhoneNumber](#) or [UpdatePhoneNumber](#) operation is still in progress and has not yet completed. You can call [DescribePhoneNumber](#) at a later time to verify if the previous operation has completed.
 - FAILED indicates that the previous [ClaimPhoneNumber](#) or [UpdatePhoneNumber](#) operation has failed. It will include a message indicating the failure reason. A common reason for a failure may be that the TargetArn value you are claiming or updating a phone number to has reached its limit of total claimed numbers. If you received a FAILED status from a ClaimPhoneNumber API call, you have one day to retry claiming the phone number before the number is released back to the inventory for other customers to claim.

Note

You will not be billed for the phone number during the 1-day period if number claiming fails.

"You've reached the limit of Phone Numbers. To increase the limit, contact support."

Even if it's the first time you've claimed a phone number, it's possible to get this error message when you attempt to claim a number. All the issues that cause this error message require help from AWS Support to resolve.

Contact AWS Support and they will provide assistance.

If you have a **Basic** plan, perform the following steps to contact AWS Support for this issue:

1. In the AWS console, choose **AWS Support Center**.
2. Choose **Create case**.
3. Choose **Looking for service limit increases?**, as shown in the following image.

Account: [redacted] • Support plan: Basic • [Change](#)

How can we help?

Choose the related issue for your case.

Account and billing Technical

[Looking for service limit increases?](#)

Cancel **Next step: Additional information**

4. On the **Create case** page, choose **Service limit increase**. In the **Limit type dropdown** box, choose Amazon Connect.
5. Complete the rest of the form, describing the issue and how to contact you. Choose **Submit**.
6. We'll contact you to help with your request.

Request an SMS-enabled phone number through Amazon Pinpoint SMS

Important

Some countries require phone numbers and sender IDs to be registered for use in the country. It can take up to 15 business days to process a registration request after it is submitted. We strongly recommend you begin this process early. For more information about registering, see [Registrations](#).

Using Amazon Pinpoint SMS, you can request new SMS-enabled phone numbers or reuse existing SMS-enabled phone numbers for use in Amazon Connect. You can request short codes, 10-digit long codes (10DLC), and toll-free numbers. These are also known as Origination Identities (OIDs).

For instructions about procuring a number for SMS messaging, see [Requesting a phone number](#) in the *Amazon Pinpoint SMS User Guide*.

Best practices for requesting SMS numbers

- Each type of OID has a different registration process and the leasing costs vary. Review the pricing here: [Amazon Pinpoint SMS pricing](#).
- When deciding what type of phone number to request, we recommend considering your throughput needs. SMS messages are delivered in 140-byte sections known as [message parts](#). Your throughput rate is the number of message parts that you can send each second.
 - **1–3 message parts per second:** Use a toll-free number. We recommend using a 10DLC number or short code if your throughput needs will exceed these limits as you expand your use cases. These number types provide plenty of room for growth, but also cost more and currently take longer to obtain than a toll-free number. For more information about requesting a toll-free number in Amazon Pinpoint, see [Requesting a phone number](#).
 - **10–75 message parts per second:** Use a 10DLC number. You can also use a short code, which would provide additional room for growth, but would also cost more. For more information, see [Requesting dedicated long codes for SMS messaging with Amazon Pinpoint SMS](#).
 - **100 message parts per second or more:** Use a short code. When you create your request in the AWS Support Center Console, specify the throughput rate that you want your short code to support.

By default US short codes support 100 message parts per second, but the throughput rate can be increased beyond that rate for an additional monthly fee. For more information, see [Requesting short codes for SMS messaging with Amazon Pinpoint SMS](#).

- Request at least one of the above OIDs as a TRANSACTIONAL number from Amazon Pinpoint.
- Be sure to provide all of the information requested during the registration process. There are no exceptions to the questions being asked.

Important

Providing incomplete or inaccurate information will increase the registration time. Your registration will need to be edited and returned to be reviewed again.

Registration for all types of OIDs in the US are managed by a third-party registrar. Amazon does not review applications.

- Toll-free phone number registration requires the least amount of time to procure.
- Review the [10DLC registration process](#) explained in the *Amazon Pinpoint SMS User Guide*.

Claim a phone number you already own in another country

Let's say your business is located in Germany. You also have agents in Japan to serve customers who live there, and you need a Japanese phone number for that contact center. To claim a phone number that you already own in another country, use the following steps to create a support case.

To claim a number that you don't already own in another country or Region, see [Request numbers, international numbers, or termination points](#).

1. Go to [Create case](#).
2. Choose **Service limit increase**.
3. In **Limit type** select **Amazon Connect**.
4. In **Use case description**, provide the address of your business that's located in the other country.
5. In **Contact options**, choose whether we should contact you by email or phone.
6. Choose **Submit**.

We'll contact you to help with your request.

List the phone numbers claimed to your Amazon Connect instance

You can list the phone numbers claimed to your Amazon Connect instance by using the Amazon Connect console, or by using the [ListPhoneNumbersV2](#) API.

To list phone numbers by using the Amazon Connect console

1. Log in to the Amazon Connect admin website at https://instance_name.my.connect.aws/.
2. On the navigation menu, choose **Channels, Phone numbers**.

The list of phone numbers claimed to your Amazon Connect instance is displayed.

Claim phone numbers for Amazon Connect in the Asia Pacific (Tokyo) Region

To claim a phone number for an Amazon Connect instance you create in the Asia Pacific (Tokyo) Region, open an AWS support case and provide documentation that your business is located in Japan.

Important

You must provide three pieces of required documentation. For a list of acceptable identification, see [Japan \(JP\)](#), in the [Region requirements for ordering and porting phone numbers](#) topic.

You cannot claim numbers for personal use, only for business use.

Amazon Connect supports claiming the following phone numbers for instances created in the Asia Pacific (Tokyo) Region.

- **Direct Inward Dialing (DID) numbers**—DID numbers are also referred to as local numbers.
 - 050 prefix numbers.
 - 03 prefix for numbers in Tokyo. Amazon Connect does not offer phone numbers for other cities in Japan at this time.
- **Toll Free numbers**
 - 0120 prefix numbers.
 - 0800 prefix numbers.

Note

When you claim a toll free phone number for Amazon Connect, there is no corresponding DID number with a 03 prefix also assigned, as with other toll free numbers in Japan. If you need to use a DID number, you can claim one in Amazon Connect.

Request numbers, international numbers, or termination points**Important**

To purchase and own a phone number, country or region regulations often require:

- A local office address.
- Specific identification documents.

For identification requirements by country, see [Region requirements for ordering and porting phone numbers](#).

In most countries it takes 2-6 weeks for us to fulfill your request. In some cases it can take up to 60 days. If you need a number by a certain date, let us know in your AWS Support case.

Note

Amazon does not provide the following:

- Premium rate or higher cost services
- Vanity numbers such as 1-888-555-0000 or an exact number

If you want these services we recommend you contract with specialist providers. For premium rate services you can route calls into Amazon Connect DIDs following local country regulations. For vanity numbers, after you've purchased them you can move these numbers across to Amazon Connect by porting them.

To request international phone numbers that require documentation, or numbers not available within a specific region, create an AWS Support case. In the support case, you must specify exactly how many numbers you want for each country.

Submit an Amazon Connect support ticket to verify if your phone number can be ported to Amazon Connect.

1. Choose [Account and billing](#) to access a pre-populated form in the AWS Support console. You must be signed in to your AWS account to access the form.
2. For **Service**, *Connect (Number Management)* should be selected.
3. For **Category**, *Special Phone Number Request* should be selected.
4. Select the required severity.
5. Choose **Next step: Additional information**
6. On the **Additional information** page:
 - a. Enter the subject.
 - b. Under **Description**, include as much information as possible about your request, If you don't know all of these details, you can leave information out.
7. Choose **Next step: Solve now or contact us**.
8. On the **Solve now or contact us** page:
 - Choose the **Contact us** tab and select your **Preferred contact language** and your preferred contact method.
9. Choose **Submit**.
10. The Amazon Connect team will review your ticket and get back to you.

After your request is approved, the exact number of requested phone numbers appear in your Amazon Connect console for you to claim. You won't have access to all available numbers in that country.

Requirements for Custom Termination Points

In the Asia Pacific (Sydney) Region, you can request Custom Termination Points.

The term "Custom Termination Points" means custom Tier 1 telephony destinations for customer calls to Amazon Connect configured as local phone numbers. In using Custom Termination Points, you understand and agree that you:

1. Have a current toll-free national service that allows you to set Custom Termination Points as a destination for customer phone calls.
2. Cannot port or move Custom Termination Points to a different telephony provider once assigned by Amazon Connect.
3. Will be billed at the standard daily rate for claimed Australian phone numbers and DID inbound usage fees.
4. You are responsible for adding the Custom Termination Points in your existing toll-free national service.

Move a phone number across instances

You can move your claimed phone number from one instance or traffic distribution group to another instance or traffic distribution group in the same AWS Region.

Moving a number by using the [UpdatePhoneNumber](#) API puts the number in one of the following three states. You can run the [DescribePhoneNumber](#) API to determine the status of your number moving process.

- IN_PROGRESS means a [UpdatePhoneNumber](#) operation is still in progress and has not yet completed. You can call [DescribePhoneNumber](#) to verify if the previous operation has completed.
- CLAIMED means the previous [UpdatePhoneNumber](#) operation succeeded and the phone number is not available to be claimed by other customers.
- FAILED indicates that the previous [UpdatePhoneNumber](#) operation has failed. It also includes a message that indicates the reason for the failure.

Release a phone number from Amazon Connect back to inventory

If you want a different phone number, or have extra numbers that you aren't using, you can release them back to inventory. You can do this using the Amazon Connect console, or programmatically by using the [ReleasePhoneNumber](#) API.

When a phone number is released from your Amazon Connect instance:

- You will no longer be charged for it.
- You cannot reclaim the phone number.
- Amazon Connect reserves the right to allow it to be claimed by another customer.

Tip

If you want to close your Amazon Connect account, do these steps for all of your phone numbers. This will ensure you aren't billed if people erroneously call numbers that you've claimed, and initiate your flows. You may also want to [delete your instances](#).

To release a phone number

1. Log in to Amazon Connect admin website with an Admin account or a user account that has **Phone numbers - Release** security profile permission.
2. On the navigation menu, choose **Channels, Phone numbers**. This option appears only if you have the **Phone numbers - View** permission in your security profile.
3. Choose the phone number you want to release, and then choose **Release**. This option appears only if you have the **Phone numbers - Release** permission in your security profile.

If the phone number is associated with a flow, that flow will be deactivated until another number is associated with it.

When customers call the phone number you have released, they will get a message that it is not a working phone number.

To use the ReleasePhoneNumber API

- Releasing a number by using the [ReleasePhoneNumber](#) API puts the number in a cool down period for up to 180 days. The phone number cannot be searched for or claimed until after the cool down period ends.

Note

You will not be billed for the phone number during the 180-day cool down period.

Avoid being blocked from claiming or releasing too many numbers

If you plan to claim and release numbers frequently, contact us for a service quota exception. Otherwise, it's possible you will be blocked from claiming and releasing any more numbers until up to 180 days past the oldest number released has expired.

By default you can claim and release up to 200% of your maximum number of active phone numbers. If you claim and release phone numbers using the UI or API during a rolling 180 day cycle that exceeds 200% of your phone number service level quota, you will be blocked from claiming any more numbers until 180 days past the oldest number released has expired.

For example, if you already have 99 claimed numbers and a service level quota of 99 phone numbers, and in any 180 day period you release 99, claim 99, and then release 99, you will have exceeded the 200% limit. At that point you are blocked from claiming any more numbers until you open an AWS support ticket.

Use caller identification to personalize customer interaction

You can provide a personalized experience for your customers by using metadata attributes that provide information related to call origination. For example, you can look up a customer's contact ID, and welcome them with a personalized greeting.

Important

Features that are provided by Amazon Connect or third parties may rely on call data for identifying inbound callers for personalizing customer interaction or detecting fraud and may be subject to additional terms and conditions. Network-related call data that is not displayed to call recipients may not be used for any purpose other than fraud detection.

Use telephony call metadata attributes

The following table lists the available telephony call metadata attributes. For information about using attributes, see [Use Amazon Connect contact attributes](#).

Attribute	Description	Type	JSONPath Reference
P-Charge-Info	The party responsible for the charges associated with the call.	System	\$.Media.Sip.Headers.P-Charge-Info
From	The identity of the end user associated with the request.	System	\$.Media.Sip.Headers.From

Attribute	Description	Type	JSONPath Reference
To	Information about the called party or the recipient of the request.	System	\$.Media.Sip.Headers.To
ISUP-OLI	Originating Line Indicator (OLI). Shows the type of line placing call (for example, PSTN, 800 service call, wireless/cellular PCS, payphone).	System	\$.Media.Sip.Headers.ISUP-OLI
JIP	Jurisdiction Indication Parameter (JIP). Indicates geographic location of caller/switch. Example value: 212555	System	\$.Media.Sip.Headers.JIP
Hop-Counter	Hop Counter. Example value: 0	System	\$.Media.Sip.Headers.Hop-Counter
Originating-Switch	Originating Switch. Example value: 710	System	\$.Media.Sip.Headers.Originating-Switch
Originating-Trunk	Originating Trunk. Example value: 0235	System	\$.Media.Sip.Headers.Originating-Trunk

Attribute	Description	Type	JSONPath Reference
Call-Forwarding-Indicator	<p>Call Forwarding Indicators (for example, Diversion header). Indicates domestic or international origin of call.</p> <p>Example value: sip:+15555555555@public-vip.us2.telphony-provider.com;reason=unconditional</p>	System	\$.Media.Sip.Headers.Call-Forwarding-Indicator
Calling-Party-Address	<p>Calling Party Address (number). NPAC dip shows true line type and native geographic switch.</p> <p>Example value: 15555555555;noa=4</p>	System	\$.Media.Sip.Headers.Calling-Party-Address
Called-Party-Address	<p>Called Party Address (number).</p> <p>Example value: 15555555555;noa=4</p>	System	\$.Media.Sip.Headers.Called-Party-Address

Troubleshoot issues

The availability of telephony metadata is not consistent across all telephony providers and may not be available in all cases.

Before opening an AWS Support case:

- If you are missing data on all calls required by a third-party Amazon Connect Ready service, check that you followed the service configuration guide provided by the third party.

If you need to open a AWS Support case, provide the following information:

- **Service = Amazon Connect**
- **Quota = 3rd-Party Number Mapping**
- **Case description box:**
 - State that you have confirmed you have a phone number with the required setup.
 - Enter the name of your Amazon Connect Ready service provider
 - Describe the telecoms metadata issue you are encountering.

The following images show an example case and where you enter this information.

The screenshot displays the AWS Support Center interface for creating a 'Service quota increase' case. The breadcrumb trail at the top reads: [AWS Support](#) > [Your support cases](#) > [Create case](#) > [Service quota increase](#). The main heading is 'Service quota increase'. Below this, there are three dropdown menus: 'Service' (set to 'Amazon Connect'), 'Severity' (set to 'General question'), and 'Region' (set to 'US West (Oregon)'). A 'Quota' dropdown menu is also present, set to '3rd Party Number Mapping'. A blue information box contains the text: 'To request additional service quota increases for the same service, choose a different service, create a separate service quota increase request.' The sidebar on the left includes sections for 'Account number', 'Support plan: Basic', 'Your support cases', and 'AWS Knowledge resources'. Red arrows point to the 'Amazon Connect' service dropdown, the 'US West (Oregon)' region dropdown, and the '3rd Party Number Mapping' quota dropdown.

Case description
<p>Use case description</p> <p>Do not share any sensitive information in case correspondences, such as credentials, credit cards, signed URLs, or personally identifiable information. Find more information here.</p>
<p>[Confirm that you have a phone number with the the required setup from a third party.]</p> <p>[Enter the name of your Amazon Connect Ready service provider]</p> <p>[Describe the telecoms metadata issue you are encountering.]</p>

- If you're getting partial data on a percent of calls as part of normal service calls: Note that data is not available on all calls.

Certain fields, such as ISUP-OLI, are only present based on specific routes through networks. It's not possible to guarantee data will be available for all calls.

Map third-party numbers to your Amazon Connect account

In some countries you may need to obtain a third-party phone number that is hosted directly by a carrier in that country instead of being hosted by Amazon Connect. The carrier is interconnected with Amazon Connect and provides billing services. In these situations you need to open a ticket to AWS Support to map your AWS account ID and Amazon Connect instance to the phone number.

To map third-party numbers to your account

1. If you have an AWS Support account, go to [Support Center](#) and submit a case.

Otherwise, open the [AWS Management Console](#) and choose **Support, Create case, Looking for service quota increases?**

2. In your case, add your **Contact Center Instance ARN**.

Limit type
Amazon Connect

Severity [Info](#)
The severity levels available are determined by your support subscription.
General question

Contact Center Instance ARN - *optional*
Provide this information to help us resolve your case faster

Requests

To request additional limit increases for the same limit type, choose **Add another request**.

Request 1

Region
US East (Northern Virginia)

Limit
3rd Party Number Mapping

New limit value

3. Specify your **Region**, and choose **3rd Party Number Mapping**.
4. In the **Use case description** box, add the name of your Partner, and the numbers you want to load and their respective phone number types (DID or toll free).
5. Choose a **Contact option** and then **Submit**.

UIFN service - Inbound only

A Universal International Freephone number (UIFN) is a unique **inbound only** freephone number that can be used throughout the world. It provides toll-free calling from international locations to your contact center.

Amazon Connect supports UIFN in more than [60 countries](#) that are registered with the International Telecommunications Union, an organization that supports the administration of the UIFN service.

Note

Amazon Connect allows you to enable UIFNs in as many countries as you need, however, it requires a minimum of 5 countries.

A UIFN is composed of a 3-digit country code for a global service application, such as **800**, and an 8-digit Global Subscriber Number (GSN). This results in an 11-digit fixed format.

For example, your UIFN could be +800 12345678, where 12345678 is your number.

Due to the special nature of UIFN, attempting to call a UIFN from Amazon Connect in a "loopback mode" is not supported. UIFNs are designed to be called from end phone configurations in the country's public telephone network.

How to get a UIFN

To request a UIFN within a specific AWS Region, create an AWS Support case. In the support case, provide the following information.

- Choose the countries you want to enable from the [list of available countries](#).
- The Amazon Connect instance(s) associated with the new UIFN numbers. Amazon Connect can support routing numbers to multiple Regions, such as Australia to the Asia Pacific (Sydney) Region, United States to a US Region, or if desired to a single global instance.
- The required ID verification for your country. Most countries subscribe to [standard ID verification requirements](#) for ordering UIFN numbers. However, we recommend checking [Region requirements for ordering and porting phone numbers](#) for your country to be sure.

For number portability, after you open a case, Amazon will provide you with *Service Provider Change Authorization and Designation of Agency* document.

Amazon Connect can route UIFNs to multiple AWS Regions. For example, if a UIFN is enabled for Australia, it can be routed to your Amazon Connect instance that is located in the Asia Pacific (Sydney) Region. If a UIFN is enabled for **more** countries, each country can be routed to your Amazon Connect instance, which may be in any supported AWS Region.

The following image shows the body of a sample UIFN request submitted to AWS Support. This request is for two UIFNs. The first is for a UIFN that is enabled for Argentina, Brazil, and Colombia, and connected to an Amazon Connect instance in the US West (Oregon) Region. The second request is for a UIFN that is enabled for Japan, Australia, and New Zealand and connected to an Amazon Connect instance located in the Asia Pacific (Singapore) Region.

New UIFN number request

```
arn:aws:connect:us-west-2:your_AWS_accountID:instance/your_instance_ARN
```

Argentina

Brazil

Colombia

```
arn:aws:connect:ap-southeast-1:your_AWS_accountID:instance/your_instance_ARN
```

Japan

Australia

New Zealand

⚠ Important

UIFN is an inbound-only service. Before opening a ticket to request a UIFN:

1. Ensure you understand that this number cannot be used for outbound.
2. Check the National reachability of the country in the following section.

Full National reachability means the UIFN reaches all local (in-country) networks. UIFNs in some countries have limited reachability and will only work with specific carriers/networks where you need to use different codes to dial the number (for example, Japan).

Countries that support UIFNs

Country	How to dial a UIFN and Reachability	How many days it takes a UIFN to be set up
Argentina	00-800-XXXX-XXXX National reachability: all fixed networks	10-15
Australia	0011-800-XXXX-XXXX National reachability: full	10-60
Austria	00-800-XXXX-XXXX	10-15

Country	How to dial a UIFN and Reachability	How many days it takes a UIFN to be set up
	National reachability: full	
Belgium	00-800-XXXX-XXXX National reachability: full	10
Brazil	0021-800-XXXX-XXXX National reachability: full	20-30
Bulgaria	00-800-XXXX-XXXX National reachability: full	10-15
Canada	011-800-XXXX-XXXX National reachability: full	20-30
China	00-800-XXXX-XXXX National reachability: China telecom fixed and mobile networks National reachability: China Unicom fixed network	20-30
Colombia	1-800-XXXX-XXXX National reachability: full	10-30
Costa Rica	00-800-XXXX-XXXX National reachability: full	10-30
Croatia	00-800-XXXX-XXXX National reachability: all fixed; T-Mobile network	20-30

Country	How to dial a UIFN and Reachability	How many days it takes a UIFN to be set up
Czech Republic	00-800-XXXX-XXXX National reachability: full	20-30
Denmark	00-800-XXXX-XXXX National reachability: full	10-15
Estonia	00-800-XXXX-XXXX National reachability: full	10-15
France	00-800-XXXX-XXXX National reachability: full, including Monaco	10-15
French Guiana	00-800-XXXX-XXXX National reachability: full	15-25
Germany	00-800-XXXX-XXXX National reachability: full	10-15
Greece	00-800-XXXX-XXXX National reachability: all fixed; Cosmotel mobile network	10-15
Guadeloupe	00-800-XXXX-XXXX National reachability: full	15-25
Hong Kong	006-800-XXXX-XXXX National reachability: full	10-15

Country	How to dial a UIFN and Reachability	How many days it takes a UIFN to be set up
Hungary	00-800-XXXX-XXXX National reachability: full	10-15
Iceland	00-800-XXXX-XXXX National reachability: all fixed; Iceland Telecom, IMC, Vodafone mobile networks.	20-30
Israel	00-800-XXXX-XXXX	10-15
Italy	00-800-XXXX-XXXX National reachability: all fixed networks, including Vatican and San Marino	10-15
Japan	<ul style="list-style-type: none"> 010-800-XXXX-XXXX National reachability: full <ul style="list-style-type: none"> KDDI: 001-010-800-XXXX-XXXX SoftBank: 0061-010-800-XXXX-XXXX 	20-50
Latvia	00-800-XXXX-XXXX	10-15
Lithuania	00-800-XXXX-XXXX National reachability: full	10-30
Luxembourg	00-800-XXXX-XXXX National reachability: full	10-30

Country	How to dial a UIFN and Reachability	How many days it takes a UIFN to be set up
Macao	00-800-XXXX-XXXX National reachability: full	10-15
Macedonia	00-800-XXXX-XXXX National reachability: MakTel fixed, T-Mobile network	10-15
Malta	00-800-XXXX-XXXX National reachability: Fixed networks, Vanilla, Go Mobile, and MALTA Mobile. Note that coverage includes Malta, Gozo, and Comino Island.	10-15
Martinique	00-800-XXXX-XXXX National reachability: full	40-60
Mayotte	00-800-XXXX-XXXX National reachability: full	15-25
Monaco	00-800-XXXX-XXXX National reachability: full	10-15
Netherlands	00-800-XXXX-XXXX National reachability: full	20-30
New Zealand	00-800-XXXX-XXXX National reachability: full	20-30

Country	How to dial a UIFN and Reachability	How many days it takes a UIFN to be set up
Peru	<p>00-800-XXXX-XXXX</p> <p>National reachability: America Moviles, Nextel, Telefonica Moviles, TESAM, Globalstar networks.</p> <p>Mobile reachability: Telefonica del Peru F&M network guaranteed only. Other networks are not guaranteed.</p>	20-30
Philippines	<p>00-800-XXXX-XXXX</p> <p>National reachability: all fixed networks</p>	10-15
Portugal	<p>00-800-XXXX-XXXX</p> <p>National reachability: full</p>	15-25
Reunion	<p>00-800-XXXX-XXXX</p> <p>National reachability: full</p>	10-15
Romania	<p>00-800-XXXX-XXXX</p> <p>National reachability: Orange fixed and mobile network, Rodasy fixed and mobile network, Romtelekom fixed and mobile network, Cosmote mobile network</p>	10-15
Saint Pierre And Miquelon	<p>00-800-XXXX-XXXX</p> <p>National reachability: full</p>	10-15

Country	How to dial a UIFN and Reachability	How many days it takes a UIFN to be set up
Singapore	001 800 XXXX XXXX The subscriber's mobile must subscribe to 001 dialing routes with their service subscriber	20-30
Slovakia	00-800-XXXX-XXXX National reachability: full	10-30
Slovenia	00-800-XXXX-XXXX National reachability: full	10-30
South Africa	00-800-XXXX-XXXX National reachability: full	10-30
South Korea	002-800-XXXX-XXXX	20-30
Spain	00-800-XXXX-XXXX National reachability: full Concurrent calls: 100 consecutive calls	10-15
Switzerland	00-800-XXXX-XXXX National reachability: full	10-15
Taiwan	00-800-XXXX-XXXX National reachability: full	10-15
Thailand	001-800-XXXX-XXXX National reachability: full	10-15

Country	How to dial a UIFN and Reachability	How many days it takes a UIFN to be set up
United Kingdom	00-800-XXXX-XXXX National reachability: full	15-30
Uruguay	00-800-XXXX-XXXX National reachability: full	10-15

Region requirements for ordering and porting phone numbers

Country or region regulations often require a local office address and specific identification documents to purchase and own a phone number. The address that you provide can be the business or personal address where the phone numbers are used.

For a list of the telephony capabilities that Amazon Connect provides, see the [Amazon Connect Telecoms Country Coverage Guide](#).

Following is a list of ID Requirements by country or region. When you [request an international number](#), we'll work with you to submit your documents.

Important

- Addresses that can be claimed without presence, such as PO Box addresses, are not valid in any country.
- After your numbers are ordered or ported, the exact number of requested phone numbers appear on the **Manage Phone numbers** page in the Amazon Connect admin website for you to [manage](#). You won't have access to all available numbers in that country.

Anguilla (AI)

For ordering phone numbers

Supported Regions	Type of Number	Are there ID requirements?	Acceptable Identification
US East (N. Virginia) US West (Oregon)	Local telephone numbers:	Yes	<p>An order form is required. Use the form that is provided to you when you make the request. Provide the following information:</p> <ul style="list-style-type: none"> Your name and address A description of the service for which the number(s) will be used <p>A global address is acceptable.</p>

Number portability

Porting of specific number ranges is supported. Create an AWS Support ticket to verify the portability of your number(s).

Antigua and Barbuda (AG)

For ordering phone numbers

Supported Regions	Type of Number	Are there ID requirements?	Acceptable Identification
US East (N. Virginia)	Local telephone numbers: +1 268	Yes	File orders in writing. Use the form that is provided

Supported Regions	Type of Number	Are there ID requirements?	Acceptable Identification
US West (Oregon)			<p>to you when you make the request. Provide the following information:</p> <ul style="list-style-type: none"> Your name and address A description of the service for which the number(s) will be used

Number portability

Porting of specific number ranges is supported. Create an AWS Support ticket to verify the portability of your number(s).

Argentina (AR)

For ordering phone numbers

Supported Regions	Type of Number	Are there ID requirements?	Acceptable Identification
US East (N. Virginia)	Local telephone numbers:	No	
US West (Oregon)	Toll-free prefixes: +54 800	No	
	Shared-Cost prefixes: +54 810	No	

Number portability

Supported Regions	Portability windows	Required Documents
US East (N. Virginia) US West (Oregon)	Monday-Friday 2AM-4AM or 10AM-12PM or 3PM-5PM UTC-3 Buenos Aires time	<ol style="list-style-type: none"> 1. Last invoice 2. Letter of Authorization (LOA): When you request porting services, we will provide you with a country-specific LOA template and explain how to complete it. 3. Argentinian AFIP (Federal Tax Agency) extract, as proof of CUIT (Clave Única de Identificación Tributaria - Unique Tax Payer ID) 4. Scanned copy of the Power of Attorney assigning the signatory sufficient attributes that allow them to request the portability, or Company Statute where the signatory appears with such attributes 5. Scanned copy of the DNI (National Identity Card) of the signatory with power of attorney
US East (N. Virginia) US West (Oregon) Africa (Cape Town) Asia Pacific (Singapore)	Preset UIFN times only	Service Provider Change Authorization and Designation of Agency provided by Amazon

Supported Regions	Portability windows	Required Documents
Asia Pacific (Seoul)		
Asia Pacific (Sydney)		
Asia Pacific (Tokyo)		
Europe (Frankfurt)		
Europe (London)		

Australia (AU)

For UIFN numbers, supports standard [Regions and requirements](#).

For ordering phone numbers

Supported Regions	Type of Number	Are there ID requirements?	Acceptable Identification
All	Local telephone numbers:	Yes	Your business address, a contact name, and phone number. An address in Australia is required
	Toll-free prefixes: +61 1300, +61 1800	No	Your business address, a contact name, and phone number. A global address is acceptable.

Number portability

Supported Regions	Portability windows	Required Documents
Focused on: Asia Pacific (Seoul) Asia Pacific (Singapore) Asia Pacific (Sydney) Asia Pacific (Tokyo)	Monday-Friday 8 AM -12 PM AEST	<ol style="list-style-type: none"> Last invoice Letter of Authorization (LOA): When you request porting services, we will provide you with a country-specific LOA template and explain how to complete it. Documents required for the Type of Number, as listed in the previous table for ordering phone numbers

Austria (AT)

For UIFN numbers, supports standard [Regions and requirements](#).

For ordering phone numbers

Supported Regions	Type of Number	Are there ID requirements?	Acceptable Identification
All	Local telephone numbers:	Yes	Proof of telecom services at your address, which must match the city code requested. Valid forms of proof (must be issued in the past 6 months): <ul style="list-style-type: none"> Invoice from a network operator for another phone number, at your address

Supported Regions	Type of Number	Are there ID requirements?	Acceptable Identification
			<ul style="list-style-type: none"> • Invoice from an internet services provider for internet access with fix IP address, at your address
	National prefixes: +43 720	Yes	<p>Proof of telecom services at your address, which must be within the country. Valid forms of proof (must be issued in the past 6 months):</p> <ul style="list-style-type: none"> • Invoice from a network operator for another phone number, at your address • Invoice from an internet services provider for internet access with fix IP address, at your address
	Toll-free prefixes: +43 800	Yes	Your business name, address, and a copy of the business registration (global).A global address is acceptable.

Number portability

Supported Regions	Portability windows	Required Documents
Focused on: US East (N. Virginia) US West (Oregon) Europe (Frankfurt) Europe (London)	Monday-Friday 10 AM to 12 PM CET	<ol style="list-style-type: none"> Last invoice Letter of Authorization (LOA): When you request porting services, we will provide you with a country-specific LOA template and explain how to complete it. Documents required for the Type of Number, as listed in the previous table for ordering phone numbers

Belgium (BE)

For UIFN numbers, supports standard [Regions and requirements](#).

For ordering phone numbers

Supported Regions	Type of Number	Are there ID requirements?	Acceptable Identification
All	Local telephone numbers:	Yes	Your business address. It must be a local address corresponding to the area code of the telephone number(s).
	Mobile prefixes: +32 46	No	
	Toll-free prefixes: +32 800	No	

Number portability

Supported Regions	Portability windows	Required Documents
Focused on: US East (N. Virginia) US West (Oregon) Europe (Frankfurt) Europe (London)	Monday-Friday 10 AM to 12 PM CET	<ol style="list-style-type: none"> 1. Last invoice 2. Letter of Authorization (LOA): When you request porting services, we will provide you with a country-specific LOA template and explain how to complete it. 3. Mandatory to provide service address for the numbers 4. Documents required for the Type of Number, as listed in the previous table for ordering phone numbers

Note

Ordering and porting of +32 78 national numbers is not supported.

Bahamas (BS)

For ordering phone numbers

Supported Regions	Type of Number	Are there ID requirements?	Acceptable Identification
US East (N. Virginia) US West (Oregon)	Local telephone numbers: +1 242	Yes	An order form is required. Use the form that is provided to you when you make the request. Provide the following information:

Supported Regions	Type of Number	Are there ID requirements?	Acceptable Identification
			<ul style="list-style-type: none"> Your name and address A description of the service for which the number(s) will be used <p>A global address is acceptable.</p>

Number portability

Porting of specific number ranges is supported. Create an AWS Support ticket to verify the portability of your number(s).

Barbados (BB)

For ordering phone numbers

Supported Regions	Type of Number	Are there ID requirements?	Acceptable Identification
US East (N. Virginia)	Local telephone numbers: +1 246	Yes	<p>An order form is required. Use the form that is provided to you when you make the request. Provide the following information:</p> <ul style="list-style-type: none"> Your name and address A description of the service for which the number(s) will be used
US West (Oregon)			

Supported Regions	Type of Number	Are there ID requirements?	Acceptable Identification
-------------------	----------------	----------------------------	---------------------------

A global address is acceptable.

Number portability

Porting of specific number ranges is supported. Create an AWS Support ticket to verify the portability of your number(s).

Bolivia (BO)

For ordering phone numbers

Supported Regions	Type of Number	Are there ID requirements?	Acceptable Identification
-------------------	----------------	----------------------------	---------------------------

US East (N. Virginia)	National prefixes: +591 50	No	
-----------------------	----------------------------	----	--

US West (Oregon)			
------------------	--	--	--

Number portability

Porting is not supported.

Bonaire (BQ)

For ordering phone numbers

Supported Regions	Type of Number	Are there ID requirements?	Acceptable Identification
-------------------	----------------	----------------------------	---------------------------

US East (N. Virginia)	Local telephone numbers: +599 7	Yes	
-----------------------	---------------------------------	-----	--

An order form is required. Use the form that is provided to you when you make the

Supported Regions	Type of Number	Are there ID requirements?	Acceptable Identification
US West (Oregon)			<p>request. Provide the following information:</p> <ul style="list-style-type: none"> Your name and address A description of the service for which the number(s) will be used <p>A global address is acceptable.</p>

Number portability

Porting of specific number ranges is supported. Create an AWS Support ticket to verify the portability of your number(s).

Brazil (BR)

For UIFN numbers, supports standard [Regions and requirements](#).

For ordering phone numbers

Supported Regions	Type of Number	Are there ID requirements?	How to access
US East (N. Virginia)	Local telephone numbers:	Yes. Local Brazilian presence is required.	To obtain numbers in Brazil:
US West (Oregon)	Toll-free prefixes:	<ul style="list-style-type: none"> CNPJ (National Registration Number of Legal Entities in Brazil) Local company name matching the CNPJ 	<ol style="list-style-type: none"> Open an AWS Support ticket. An AWS Support representative will contact you. They will put you in

Supported Regions	Type of Number	Are there ID requirements?	How to access
			<p>contact with our local telephony provider to provide you with an in Country-Specific Agreement.</p> <p>After you have your numbers from our carrier, perform the steps explained in Map third-party numbers to your Amazon Connect account to add your numbers to your Amazon Connect instance.</p>

Number portability

Supported Regions	Type of Number	Are there ID requirements?	How to access
US East (N. Virginia)	Local telephone numbers:	Yes. Local Brazilian presence is required.	<ul style="list-style-type: none"> If you currently have local numbers in Amazon Connect: <ol style="list-style-type: none"> Coordinate with the telephony provider that we have contracted with for your number porting. Open an AWS Support ticket to have your ported
US West (Oregon)	Toll-free prefixes:	<ul style="list-style-type: none"> CNPJ (National Registration Number of Legal Entities in Brazil) Local company name matching the CNPJ 	

Supported Regions	Type of Number	Are there ID requirements?	How to access
			<p>numbers added to your Amazon Connect instance.</p> <div data-bbox="1206 430 1510 1171" style="border: 1px solid #f08080; border-radius: 10px; padding: 10px; margin: 10px 0;"> <p>⚠ Important</p> <p>We recommend opening the AWS Support ticket at least 5 days before your scheduled porting date with the telephony provider.</p> </div> <ul style="list-style-type: none"> <li data-bbox="1138 1192 1507 1843">• If you are in the process of porting numbers and do not yet have local numbers in Brazil associated with your Amazon Connect instance, follow the steps outlined above for ordering numbers. This includes opening a ticket with AWS Support to initiate the process.

Brunei (BN)

For ordering phone numbers

Supported Regions	Type of Number	Are there ID requirements?	Acceptable Identification
Europe (Frankfurt)	Toll-free prefixes:	Yes	<p>An order form is required. Use the form that is provided to you when you make the request. Provide the following information:</p> <ul style="list-style-type: none"> Your name and address A description of the service for which the number(s) will be used <p>A global address is acceptable.</p>
Europe (London)			

Number portability

Porting is not supported.

Canada (CA)

For UIFN numbers, supports standard [Regions and requirements](#).

For ordering phone numbers

Supported Regions	Type of Number	Are there ID requirements?	Acceptable Identification
US East (N. Virginia)	Local telephone numbers:	No	

Supported Regions	Type of Number	Are there ID requirements?	Acceptable Identification
US West (Oregon)	Toll-free prefixes:	No	
Canada (Central)			
Europe (Frankfurt)			
Europe (London)			
AWS GovCloud (US-West)			

Number portability

Supported Regions	Portability windows	Required Documents
US East (N. Virginia)	Monday-Friday 7 AM to 5 PM CST	<ol style="list-style-type: none"> Last invoice Letter of Authorization (LOA): When you request porting services, we will provide you with a country-specific LOA template and explain how to complete it.
US West (Oregon)		
Canada (Central)		
Europe (Frankfurt)		
Europe (London)		
AWS GovCloud (US-West)		

Chile (CL)

For ordering phone numbers

Supported Regions	Type of Number	Are there ID requirements?	Acceptable Identification
US East (N. Virginia)	Local telephone numbers:	No	
US West (Oregon)	Toll-free prefixes:	No	

Number portability

Supported Regions	Portability windows	Required Documents
US East (N. Virginia) US West (Oregon)	Monday-Friday 9 PM to 3 AM PST	<ol style="list-style-type: none"> 1. Last invoice 2. Letter of Authorization (LOA): When you request porting services, we will provide you with a country-specific LOA template and explain how to complete it. 3. Copy of legal representative's photo ID 4. Copy of local business registration

China (CN)

For ordering phone numbers

Supported Regions	Type of Number	Are there ID requirements?	Acceptable Identification
US East (N. Virginia)	UIFN	Yes	Your business name, address and service usage description. A global address is acceptable.
US West (Oregon)			
Africa (Cape Town)			
Asia Pacific (Singapore)			
Asia Pacific (Seoul)			
Asia Pacific (Sydney)			
Asia Pacific (Tokyo)			
Europe (Frankfurt)			
Europe (London)			

Number portability

Supported Regions	Portability windows	Required Documents
US East (N. Virginia)	Preset UIFN times only	Service Provider Change Authorization and Designation of Agency provided by Amazon
US West (Oregon)		
Africa (Cape Town)		
Asia Pacific (Singapore)		
Asia Pacific (Seoul)		
Asia Pacific (Sydney)		
Asia Pacific (Tokyo)		
Europe (Frankfurt)		
Europe (London)		

Colombia (CO)

For UIFN numbers, supports standard [Regions and requirements](#).

For ordering phone numbers

Supported Regions	Type of Number	Are there ID requirements?	Acceptable Identification
US East (N. Virginia)	Local telephone numbers:	No	
US West (Oregon)	Toll-free prefixes: +57 800	No	

Number portability

Supported Regions	Portability windows	Required Documents
Not supported	N/A	N/A

Costa Rica (CR)

For UIFN numbers, supports standard [Regions and requirements](#).

For ordering phone numbers

Supported Regions	Type of Number	Are there ID requirements?	Acceptable Identification
US East (N. Virginia)	Local telephone numbers:	No	
US West (Oregon)	Toll-free prefixes: +506 800	No	

Number portability

Supported Regions	Portability windows	Required Documents
Not supported	N/A	N/A

Croatia (HR)

For UIFN numbers, supports standard [Regions and requirements](#).

Curaçao (CW)

For ordering phone numbers

Supported Regions	Type of Number	Are there ID requirements?	Acceptable Identification
US East (N. Virginia) US West (Oregon)	Local telephone numbers: +599 9	Yes	<p>An order form is required. Use the form that is provided to you when you make the request. Provide the following information:</p> <ul style="list-style-type: none"> Your name and address A description of the service for which the number(s) will be used <p>A global address is acceptable.</p>

Number portability

Porting of specific number ranges is supported. Create an AWS Support ticket to verify the portability of your number(s).

Cyprus (CY)

For ordering phone numbers

Supported Regions	Type of Number	Are there ID requirements?	Acceptable Identification
Europe (Frankfurt) Europe (London)	Local telephone numbers:	Yes	Your business address. It must be a local address corresponding to the area code of the telephone number(s).
	Toll-free prefixes: + 357 800	No	

Number portability

Supported Regions	Portability windows	Required Documents
Europe (Frankfurt) Europe (London)	Monday-Friday 10 AM to 12 PM CET	<ol style="list-style-type: none"> 1. Last invoice 2. Letter of Authorization (LOA): When you request porting services, we will provide you with a country-specific LOA template and explain how to complete it. 3. Copy of Certificate of Directors and Secretary of the Company 4. Copy of Certificate of Incorporation

Supported Regions	Portability windows	Required Documents
		5. Copy of legal representative's photo ID

Czech Republic (CZ)

For ordering phone numbers

Supported Regions	Type of Number	Are there ID requirements?	Acceptable Identification
US East (N. Virginia)	Local telephone numbers:	Yes	Your business address. It must be a local address corresponding to the area code of the telephone number(s).
US West (Oregon)			
Canada (Central)	Toll-free prefixes: +420 800	Yes	Your business name and address. A global address is acceptable.
Europe (Frankfurt)	National prefixes: +995 70	No	
Europe (London)			
	Local telephone numbers: (Tbilisi)	Yes	Your business address. It must be a local address corresponding to the area code of the telephone number(s). You must provide proof of the address.

Number portability

Supported Regions	Portability windows	Required Documents
US East (N. Virginia)	Monday-Friday 3 PM to 4 PM CET	<ol style="list-style-type: none"> 1. Last invoice 2. Letter of Authorization (LOA): When you request porting services, we will provide you with a country-specific LOA template and explain how to complete it. 3. Business registration. 4. Documents required per Type of Number as listed in the previous table for ordering numbers
US West (Oregon)		
Europe (Frankfurt)		
Europe (London)		

Denmark (DK)

For UIFN numbers, supports standard [Regions and requirements](#).

For ordering phone numbers

Supported Regions	Type of Number	Are there ID requirements?	Acceptable Identification
All	Local telephone numbers:	Yes	Your business name, address, and service description. A global address is acceptable.
	Mobile prefixes: +45 9x	No	
	Toll-free prefixes: +45 808	Yes	Your business name, address, and service description. A global address is acceptable.

Number portability

Supported Regions	Portability windows	Required Documents
Focused on: US East (N. Virginia) US West (Oregon) Europe (Frankfurt) Europe (London)	Monday-Friday 10 AM to 12 PM CET	<ol style="list-style-type: none"> Last invoice Letter of Authorization (LOA): When you request porting services, we will provide you with a country-specific LOA template and explain how to complete it. Documents required per Type of Number as listed in the previous table for ordering numbers

Dominican Republic (DOM)

For ordering phone numbers

Supported Regions	Type of Number	Are there ID requirements?	Acceptable Identification
US East (N. Virginia)	Local telephone numbers:	No	N/A
US West (Oregon)	Toll-free prefixes: +1 8xx	No	NA

Number portability

Supported Regions	Portability windows	Required Documents
US East (N. Virginia)	Monday-Friday 10:00PM to 04:00AM PST	1. Letter of Authorization (LOA) signed: When you request porting

Supported Regions	Portability windows	Required Documents
US West (Oregon)		<p>services, we will provide you with a country-specific LOA template and explain how to complete it</p> <ol style="list-style-type: none"> Only Local Address accepted Copy of the ID or passport of an authorized representative who signs the LOA Copy of Local Commercial Registry Number known as RNC / "Número de Registro Mercantil".

Ecuador (ECU)

For ordering phone numbers

Supported Regions	Type of Number	Are there ID requirements?	Acceptable Identification
US East (N. Virginia)	Local telephone numbers:	No	N/A
US West (Oregon)	Toll-free prefixes: +593-180000XXXX	No	N/A

Number portability

Supported Regions	Portability windows	Required Documents
Not supported	N/A	N/A

El Salvador (SV)

For ordering phone numbers

Supported Regions	Type of Number	Are there ID requirements?	Acceptable Identification
US East (N. Virginia) US West (Oregon)	Local telephone numbers:	Yes	<p>Businesses must provide their name, address, and RUC/ TaxID number, along with a copy of the business registration and a proof of address.</p> <p>Valid proofs of address include: third-party issued bank statements, utility bills (all issued in the previous 6 months); government documents (issued in the previous year).</p> <p>A local address is required.</p>
	Toll-free prefixes:	Yes	<p>Businesses must provide a copy of business registration and a proof of address.</p> <p>Valid proofs of address include: third-party issued bank statements, utility bills (all issued in the previous 6 months); government documents</p>

Supported Regions	Type of Number	Are there ID requirements?	Acceptable Identification
			(issued in the previous year).

Number portability

Supported Regions	Portability windows	Required Documents
US East (N. Virginia) US West (Oregon)	Monday-Friday 03:00AM to 05:00AM CST	<ol style="list-style-type: none"> 1. Letter of Authorization (LOA) Portability Form. When you request porting services, we will provide you with a country-specific LOA template and explain how to complete it. 2. Copy of Local Business Registration with local representative(s) information. 3. Local ID "Documento Unico de Identidad (DUI)" from local representative. 4. Tax Number registration (Número de Identificación Tributaria). 5. Valid proofs of address include, for example, utility bills issued in the previous three months.

Estonia (EE)

For ordering phone numbers

For UIFN numbers, supports standard [Regions and requirements](#).

Supported Regions	Type of Number	Are there ID requirements?	Acceptable Identification
Europe (Frankfurt)	Toll-free prefixes: +372 800	No	
Europe (London)	National prefixes: +372	Yes	Your business address. A copy of the ID/business registration. A global address is acceptable.

Number portability

Supported Regions	Portability windows	Required Documents
Europe (Frankfurt) Europe (London)	Monday-Friday 10 AM to 12 PM CET	<ol style="list-style-type: none"> 1. Last invoice 2. Letter of Authorization (LOA): When you request porting services, we will provide you with a country-specific LOA template and explain how to complete it. 3. LOA template has to include a local address. 4. If this is a company, a business number is required.

Finland (FI)

For ordering phone numbers

Supported Regions	Type of Number	Are there ID requirements?	Acceptable Identification
US East (N. Virginia)	Local telephone numbers:	Yes	Your residence or business address. Both must be a local address corresponding to the area code of the telephone number(s).
US West (Oregon)			
Canada (Central)			
Europe (Frankfurt)	Toll-free prefixes: +358 800	No	
Europe (London)	National prefixes: +358 75	No	

Number portability

Supported Regions	Portability windows	Required Documents
US East (N. Virginia)	Monday-Friday 10 AM to 12 PM CET	<ol style="list-style-type: none"> Last invoice Letter of Authorization (LOA): When you request porting services, we will provide you with a country-specific LOA template and explain how to complete it. Documents required for the Type of Number, as listed in the previous table for ordering phone numbers
US West (Oregon)		
Europe (Frankfurt)		
Europe (London)		

France (FR)

For UIFN numbers, supports standard [Regions and requirements](#).

For ordering phone numbers

Supported Regions	Type of Number	Are there ID requirements?	Acceptable Identification
US East (N. Virginia)	Local geographic telephone numbers: +33 1, +33 2, +33 3, +33 4, +33 5	Yes	A business address in France is required.
US West (Oregon)			You must provide a copy of the business registration (KBIS or INSEE extract issued in the past 3 months), listing the provided address in France as main business address.
Canada (Central)			
Europe (Frankfurt)			
Europe (London)			National multipurpose numbers: +33 9 7890
	National verified multipurpose numbers (to be used as caller ID by automated calling services): +33 9 4847	Yes	A business address in France is required. You must provide a copy of the business registration (KBIS or INSEE extract issued in the past 3

Supported Regions	Type of Number	Are there ID requirements?	Acceptable Identification
			months), listing the provided address in France as main business address.
	National multipurpose numbers to be used for communications with a technical platform: +33 9 3937	Yes	A business address in France is required. You must provide a copy of the business registration (KBIS or INSEE extract issued in the past 3 months), listing the provided address in France as main business address.
	Toll-free prefixes: +33 801	Yes	A business address in the European Union is required, as well as a contact phone number.

Number portability

Supported Regions	Portability windows	Required Documents
US East	Monday-Friday 10 AM to 12 PM CET	<ol style="list-style-type: none"> Last invoice Letter of Authorization (LOA): When you request porting services, we will provide you with a country-specific LOA template and explain how to complete it.
US West		
EU (Frankfurt)		
EU (London)		

Supported Regions	Portability windows	Required Documents
		<p>3. Documents required per Type of Number as listed in the previous table for ordering numbers.</p> <p>4. It is mandatory to provide RIO code from the losing carrier, or at least the SIRET. You can obtain the SIRET by contacting your existing telecom carrier.</p> <p>Number portability is supported for all toll-free prefixes from +33 800 to +33 805, geographic prefixes from +33 1 to +33 5, and national multipurpose prefixes +33 9.</p>

French Guiana (GF)

For ordering phone numbers

Supported Regions	Type of Number	Are there ID requirements?	Acceptable Identification
US East (N. Virginia)	UIFN	Yes	Your business name, address and service usage description.
US West (Oregon)			A global address is acceptable.
Africa (Cape Town)			

Supported Regions	Type of Number	Are there ID requirements?	Acceptable Identification
Asia Pacific (Singapore)			
Asia Pacific (Seoul)			
Asia Pacific (Sydney)			
Asia Pacific (Tokyo)			
Europe (Frankfurt)			
Europe (London)			

Number portability

Supported Regions	Portability windows	Required Documents
US East (N. Virginia)	Preset UIFN times only	Service Provider Change Authorization and Designation of Agency provided by Amazon
US West (Oregon)		
Africa (Cape Town)		
Asia Pacific (Singapore)		

Supported Regions	Portability windows	Required Documents
Asia Pacific (Seoul)		
Asia Pacific (Sydney)		
Asia Pacific (Tokyo)		
Europe (Frankfurt)		
Europe (London)		

Georgia (GE)

For ordering phone numbers

Supported Regions	Type of Number	Are there ID requirements?	Acceptable Identification
Europe (Frankfurt)	National prefixes: +995 70	No	
Europe (London)	Local telephone numbers: (Tibilisi)	Yes	Your business address. It must be in the relevant geographic zone as the number. You must provide proof of the address.

Number portability

Supported Regions	Portability windows	Required Documents
Not supported	N/A	N/A

Germany (DE)

For UIFN numbers, supports standard [Regions and requirements](#).

For ordering phone numbers

Supported Regions	Type of Number	Are there ID requirements?	Acceptable Identification
US East (N. Virginia)	Local telephone numbers:	Yes	Local address in Germany is required. The address dictates where the geographic number must be sited. Businesses must provide a copy of the business registration document (issued in the past 6 months) as proof of address.
US West (Oregon)			
Canada (Central)			
Europe (Frankfurt)			
Europe (London)			
	Toll-free prefixes: +49 800	Yes	Your business address outside of Germany. You

Supported Regions	Type of Number	Are there ID requirements?	Acceptable Identification
			<p>must provide a copy of the business registration, which serves as proof of company registration and proof of address. If the business registration document does not show an address, a utility bill (issued in the past 6 months) is also required in addition, as proof for the submitted address. No P.O. boxes allowed.</p> <p>For numbers to be answered inside of Germany, a special process applies. You must obtain the number directly from the local regulator and then port it to Amazon Connect. Details about the process are provided when you make the request.</p>

Number portability

Supported Regions	Portability windows	Required Documents
US East (N. Virginia)	Monday-Friday 10 AM to 12 PM CET	1. Last invoice

Supported Regions	Portability windows	Required Documents
US West (Oregon)		<ol style="list-style-type: none"> 2. Letter of Authorization (LOA): When you request porting services, we will provide you with a country-specific LOA template and explain how to complete it. 3. For business ports, end user stamp is mandatory on the LOA. 4. If the number to be ported is an extended line, the main line must be ported. 5. Documents required for the Type of Number, as listed in the previous table for ordering phone numbers. Toll-free numbers can be ported only if you have the number ownership certificate from the regulator.
Europe (Frankfurt)		
Europe (London)		

Greece (GR)

For UIFN numbers, supports standard [Regions and requirements](#).

For ordering phone numbers

Supported Regions	Type of Number	Are there ID requirements?	Acceptable Identification
US East (N. Virginia)	Local telephone numbers:	Yes	Your business address. It must be a local address corresponding to the area code of the telephone number(s).
US West (Oregon)			

Supported Regions	Type of Number	Are there ID requirements?	Acceptable Identification
Canada (Central)	Toll-free prefixes: +30 800	No	
Europe (Frankfurt)			
Europe (London)			

Number portability

Supported Regions	Portability windows	Required Documents
US East (N. Virginia)	Monday-Friday 10 AM to 12 PM CET	<ol style="list-style-type: none"> Last invoice Letter of Authorization (LOA): When you request porting services, we will provide you with a country-specific LOA template and explain how to complete it. Company registration certificate Copy of LOA signatory's photo ID/Passport Documents required for the Type of Number, as listed in the previous table for ordering phone numbers
US West (Oregon)		
Europe (Frankfurt)		
Europe (London)		

Guatemala (GT)

For ordering phone numbers

Supported Regions	Type of Number	Are there ID requirements?	Acceptable Identification	Restrictions
US East (N. Virginia)	Local telephone numbers:	No		
US West (Oregon)				

Number portability

Porting is not supported.

Guadeloupe (GP)

For ordering phone numbers

Supported Regions	Type of Number	Are there ID requirements?	Acceptable Identification
US East (N. Virginia)	UIFN	Yes	Your business name, address and service usage description. A global address is acceptable.
US West (Oregon)			
Africa (Cape Town)			
Asia Pacific (Singapore)			

Supported Regions	Type of Number	Are there ID requirements?	Acceptable Identification
Asia Pacific (Seoul)			
Asia Pacific (Sydney)			
Asia Pacific (Tokyo)			
Europe (Frankfurt)			
Europe (London)			

Number portability

Supported Regions	Portability windows	Required Documents
US East (N. Virginia)	Preset UIFN times only	Service Provider Change Authorization and Designation of Agency provided by Amazon
US West (Oregon)		
Africa (Cape Town)		
Asia Pacific (Singapore)		
Asia Pacific (Seoul)		

Supported Regions	Portability windows	Required Documents
Asia Pacific (Sydney)		
Asia Pacific (Tokyo)		
Europe (Frankfurt)		
Europe (London)		

Honduras (HN)

For ordering phone numbers

Supported Regions	Type of Number	Are there ID requirements?	Acceptable Identification	Restrictions
US East (N. Virginia)	National DID:	No		
US West (Oregon)	Toll-free prefixes: +504 800	No		

Number portability

Porting is not supported.

Hong Kong (HK)

For UIFN numbers, supports standard [Regions and requirements](#).

For ordering phone numbers

Supported Regions	Type of Number	Are there ID requirements?	Acceptable Identification
Asia Pacific (Seoul)	Local telephone numbers:	Yes	Your address and proof of address.
Asia Pacific (Singapore)			A global address is acceptable.
Asia Pacific (Sydney)	National prefixes: +852 58	Yes	Your address and proof of address.
Asia Pacific (Tokyo)			A global address is acceptable.
	Toll-free prefixes: +852 800	Yes	<p>Businesses must provide a copy of business registration which serves as proof of company registration and proof of address.</p> <p>A global address is acceptable.</p>

Number portability

Supported Regions	Portability windows	Required Documents
Asia Pacific (Singapore)	N/A	<ol style="list-style-type: none"> Last invoice. Letter of Authorization (LOA): When you request porting services, we will provide you with a country-specific LOA template and explain how to complete it.
Asia Pacific (Sydney)		

Supported Regions	Portability windows	Required Documents
Asia Pacific (Tokyo)		3. Documents required for the Type of Number, as listed in the previous table for ordering phone numbers.

Hungary (HU)

For UIFN numbers, supports standard [Regions and requirements](#).

For ordering phone numbers

Supported Regions	Type of Number	Are there ID requirements?	Acceptable Identification
Europe (Frankfurt)	Local telephone numbers:	Yes	Your business address. It must be a local address corresponding to the area code of the telephone number(s). You must provide a copy of the business registration document (issued in the past 6 months) as proof of address. A copy of the ID or passport of an authorized representative is also required.
Europe (London)			
	Toll-free prefixes: +36 800	No	

Number portability

Supported Regions	Portability windows	Required Documents
Europe (Frankfurt)	Monday-Friday 10 AM to 12 PM CET	<ol style="list-style-type: none"> 1. Last invoice: must be within the last 6 months 2. Letter of Authorization (LOA): When you request porting services, we will provide you with a country-specific LOA template and explain how to complete it. 3. Documents required for the Type of Number, as listed in the previous table for ordering phone numbers
Europe (London)		

Iceland (IS)

For UIFN numbers, supports standard [Regions and requirements](#).

For ordering phone numbers

Supported Regions	Type of Number	Are there ID requirements?	Acceptable Identification
Europe (Frankfurt)	Local telephone numbers:	No	
Europe (London)	Toll-free prefixes:	No	

Number portability

Porting is not supported.

Indonesia (ID)

For ordering phone numbers

Supported Regions	Type of Number	Are there ID requirements?	Acceptable Identification
Asia Pacific (Seoul)	Local telephone numbers:	No	
Asia Pacific (Singapore)	Mobile prefixes: +62 855	Yes	Proof of business address, a copy of the ID or passport of an authorized representative, and the business registration. You must also provide a description of how you plan to use the numbers.
Asia Pacific (Sydney)			
Asia Pacific (Tokyo)			
	Toll-free prefixes: +62 800	No	

Number portability

Supported Regions	Portability windows	Required Documents
Not supported	N/A	N/A

Ireland (IE)

For ordering phone numbers

Supported Regions	Type of Number	Are there ID requirements?	Acceptable Identification
US East (N. Virginia)	Local telephone numbers:	Yes	Your business address. It must be a local address corresponding to the area code of the telephone number(s). You must provide proof of the address.
US West (Oregon)			
Canada (Central)			
Europe (Frankfurt)	Toll-free prefixes: +353 1800	No	
Europe (London)			

Number portability

Supported Regions	Portability windows	Required Documents
US East (N. Virginia)	Monday-Friday 10 AM to 12 PM CET	<ol style="list-style-type: none"> Last invoice Letter of Authorization (LOA): When you request porting services, we will provide you with a country-specific LOA template and explain how to complete it. It is mandatory to provide the main telephone number on the account.
US West (Oregon)		
Europe (Frankfurt)		
Europe (London)		

Supported Regions	Portability windows	Required Documents
		<ol style="list-style-type: none"> 4. It is mandatory to provide a Wholesale Account number. 5. Type of the line mandatory on the LOA. 6. Documents required for the Type of Number, as listed in the previous table for ordering phone numbers

Israel (IL)

For ordering phone numbers

Supported Regions	Type of Number	Are there ID requirements?	Acceptable Identification
US East (N. Virginia)	UIFN	Yes	Your business name, address and service usage description. A global address is acceptable.
US West (Oregon)			
Africa (Cape Town)			
Asia Pacific (Singapore)			
Asia Pacific (Seoul)			
Asia Pacific (Sydney)			

Supported Regions	Type of Number	Are there ID requirements?	Acceptable Identification
Asia Pacific (Tokyo)			
Europe (Frankfurt)			
Europe (London)			

Number portability

Supported Regions	Portability windows	Required Documents
US East (N. Virginia)	Preset UIFN times only	Service Provider Change Authorization and Designation of Agency provided by Amazon
US West (Oregon)		
Africa (Cape Town)		
Asia Pacific (Singapore)		
Asia Pacific (Seoul)		
Asia Pacific (Sydney)		
Asia Pacific (Tokyo)		

Supported Regions	Portability windows	Required Documents
Europe (Frankfurt)		
Europe (London)		

Italy (IT)

For UIFN numbers, supports standard [Regions and requirements](#).

For ordering phone numbers

Supported Regions	Type of Number	Are there ID requirements?	Acceptable Identification
US East (N. Virginia)	Local telephone numbers:	Yes	Your business name, address, and VAT number. You must provide proof of the address along with a copy of the business registration (extracted within the last 6 months).
US West (Oregon)			
Africa (Cape Town)			
Canada (Central)			
Europe (Frankfurt)			
Europe (London)			

Supported Regions	Type of Number	Are there ID requirements?	Acceptable Identification
			<p>name of the representative must appear on the business registration.</p> <p>A local address in Italy is required.</p>
	Toll-free prefixes: +39 800	Yes	<p>Your business name, address, and VAT number.</p> <p>You must provide the following details of an authorized representative: name and address, birth location and data, and nationality and tax code. Also provide proof of the authorized representative's identity, which can be a copy of an ID or passport.</p> <p>A business address in the European Union is required.</p>

Number portability

Supported Regions	Portability windows	Required Documents
US East (N. Virginia)	For local numbers: Monday-Friday 6AM to 9AM CET	1. Last invoice

Supported Regions	Portability windows	Required Documents
US West (Oregon)	For toll-free numbers: Monday-Friday 6AM-4PM CET	<ol style="list-style-type: none"> Letter of Authorization (LOA): When you request porting services, we will provide you with a country-specific LOA template and explain how to complete it. Migration code of the requested number is mandatory. Obtain this code from the losing carrier. Documents required for the Type of Number, as listed in the previous table for ordering phone numbers
Europe (Frankfurt)		
Europe (London)		

Jamaica (JM)

For ordering phone numbers

Supported Regions	Type of Number	Are there ID requirements?	Acceptable Identification
US East (N. Virginia)	Local telephone numbers:	Yes	<p>An order form is required. Use the form that is provided to you when you make the request. Provide the following information:</p> <ul style="list-style-type: none"> Your name and address A description of the service for which the number(s) will be used
US West (Oregon)			

Supported Regions	Type of Number	Are there ID requirements?	Acceptable Identification
			A global address is acceptable.

Number portability

Porting of specific number ranges is supported. Create an AWS Support ticket to verify the portability of your number(s).

Japan (JP)

For UIFN numbers, supports standard [Regions and requirements](#).

For ordering phone numbers

Supported Regions	Type of Number	Are there ID requirements?	Acceptable Identification
Asia Pacific (Seoul)	Local telephone numbers:	Yes	Businesses must provide 3 pieces of documentation: <ul style="list-style-type: none"> • Company registration documents (must be issued in the past 6 months). These documents must show: <ul style="list-style-type: none"> • The business address is in the city corresponding to the requested area code of the number. • The authorized representative of the business.
Asia Pacific (Singapore)			
Asia Pacific (Sydney)			
Asia Pacific (Tokyo)			

Supported Regions	Type of Number	Are there ID requirements?	Acceptable Identification
			<ul style="list-style-type: none"> • A copy of the personal ID or passport of the business's authorized representative. The person must be registered on the Company Registration Documents. Valid personal ID can be government-issued IDs or passports. • Proof of address for the business (must be issued in the past 6 months). Valid proofs of address include: third-party issued bank statements, public utility bills; government documents; or IDs listing the submitted address, such as government-issued IDs, passports, and business registration. <p>Copies of these documents should be made into a single ZIP file.</p>

Supported Regions	Type of Number	Are there ID requirements?	Acceptable Identification
	Toll-free prefixes: +81 120, +81 800	Yes	<p>Businesses must provide the following documentation:</p> <ul style="list-style-type: none"> • Company registration documents (must be issued in the past 6 months). These documents must show: <ul style="list-style-type: none"> • The business address. A global address is acceptable. • The authorized representative of the business. • A copy of the personal ID or passport of the business's authorized representative. The person must be registered on the Company Registration Documents. Valid personal ID can be government-issued IDs and passports. <p>Copies of these documents should be made into a single ZIP file.</p>

Number portability

Supported Regions	Portability windows	Required Documents
Asia Pacific (Tokyo)		<ol style="list-style-type: none"> 1. Last invoice 2. Letter of Authorization (LOA): When you request porting services, we will provide you with a country-specific LOA template and explain how to complete it. 3. Documents required per Type of Number as listed in the previous table for ordering numbers <p>Submit an AWS Support ticket to verify the portability of your number(s).</p>

Latvia (LV)

For UIFN numbers, supports standard [Regions and requirements](#).

For ordering phone numbers

Supported Regions	Type of Number	Are there ID requirements?	Acceptable Identification
Europe (Frankfurt)	Toll-free prefixes: +371 80	Yes	Businesses must provide a copy of the business registration, along with proof of address within Latvia (issued in the past 6 months). Valid forms of proof:
Europe (London)			

Supported Regions	Type of Number	Are there ID requirements?	Acceptable Identification
			<ul style="list-style-type: none"> • Business Registration • Third-party issued bank statement • Public utility bill showing regular use • Lease Agreement • Government documents
	National prefixes: +371 6	Yes	<p>Businesses must provide proof of address within Latvia (issued in the past 6 months).</p> <p>Valid forms of proof:</p> <ul style="list-style-type: none"> • Business Registration • Third-party issued bank statement • Public utility bill showing regular use • Lease Agreement • Government documents

Number portability

Supported Regions	Portability windows	Required Documents
Europe (Frankfurt)	Monday-Friday 10 AM to 12 PM CET	1. Last invoice

Supported Regions	Portability windows	Required Documents
Europe (London)		<ol style="list-style-type: none"> Letter of Authorization (LOA): When you request porting services, we will provide you with a country-specific LOA template and explain how to complete it. Documents required for the Type of Number, as listed in the previous table for ordering phone numbers

Lithuania (LT)

For UIFN numbers, supports standard [Regions and requirements](#).

For ordering phone numbers

Supported Regions	Type of Number	Are there ID requirements?	Acceptable Identification
Europe (Frankfurt)	Local telephone numbers:	Yes	Your business address. It must be a local address corresponding to the area code of the telephone number(s).
Europe (London)	Toll-free prefixes: +370 800	Yes	Your business address in the country.

Number portability

Supported Regions	Portability windows	Required Documents
Europe (Frankfurt) Europe (London)	Monday-Friday 10 AM to 12 PM CET	<ol style="list-style-type: none"> 1. Last invoice 2. Letter of Authorization (LOA): When you request porting services, we will provide you with a country-specific LOA template and explain how to complete it. 3. VAT number and local address is needed on the LOA. 4. Documents required for the Type of Number, as listed in the previous table for ordering phone numbers

Luxembourg (LU)

For UIFN numbers, supports standard [Regions and requirements](#).

For ordering phone numbers

Supported Regions	Type of Number	Are there ID requirements?	Acceptable Identification
Europe (Frankfurt) Europe (London)	Local telephone numbers: +352 27	Yes	<p>Your residence or business address. It must be a local address corresponding to the area code of the telephone number(s).</p> <p>A contact phone number.</p>

Supported Regions	Type of Number	Are there ID requirements?	Acceptable Identification
	National prefixes:	Yes	An address in Luxembourg is required. Businesses must provide a copy of the business registration. A contact phone number.
	Toll-free prefixes: +352 800	Yes	Your business name and address. A global address is acceptable. A contact phone number.

Number portability

Supported Regions	Portability windows	Required Documents
Europe (Frankfurt) Europe (London)	Monday-Friday 10 AM to 12 PM CET	<ol style="list-style-type: none"> 1. Last invoice 2. Letter of Authorization (LOA): When you request porting services, we will provide you with a country-specific LOA template and explain how to complete it. 3. You must provide the account number from the Main Losing Carrier to which the requested DID is assigned. 4. Documents required for the Type of Number, as listed in the previous table for ordering phone numbers

Macao (MO)

For ordering phone numbers

Supported Regions	Type of Number	Are there ID requirements?	Acceptable Identification
US East (N. Virginia)	UIFN	Yes	Your business name, address and service usage description. A global address is acceptable.
US West (Oregon)			
Africa (Cape Town)			
Asia Pacific (Singapore)			
Asia Pacific (Seoul)			
Asia Pacific (Sydney)			
Asia Pacific (Tokyo)			
Europe (Frankfurt)			
Europe (London)			

Number portability

Supported Regions	Portability windows	Required Documents
US East (N. Virginia)	Preset UIFN times only	Service Provider Change Authorization and Designation of Agency provided by Amazon
US West (Oregon)		
Africa (Cape Town)		
Asia Pacific (Singapore)		
Asia Pacific (Seoul)		
Asia Pacific (Sydney)		
Asia Pacific (Tokyo)		
Europe (Frankfurt)		
Europe (London)		

Macedonia (MK)

For ordering phone numbers

Supported Regions	Type of Number	Are there ID requirements?	Acceptable Identification
US East (N. Virginia)	UIFN	Yes	Your business name, address and service usage description. A global address is acceptable.
US West (Oregon)			
Africa (Cape Town)			
Asia Pacific (Singapore)			
Asia Pacific (Seoul)			
Asia Pacific (Sydney)			
Asia Pacific (Tokyo)			
Europe (Frankfurt)			
Europe (London)			

Number portability

Supported Regions	Portability windows	Required Documents
US East (N. Virginia)	Preset UIFN times only	Service Provider Change Authorization and Designation of Agency provided by Amazon
US West (Oregon)		
Africa (Cape Town)		
Asia Pacific (Singapore)		
Asia Pacific (Seoul)		
Asia Pacific (Sydney)		
Asia Pacific (Tokyo)		
Europe (Frankfurt)		
Europe (London)		

Malaysia (MY)

For ordering phone numbers

Supported Regions	Type of Number	Are there ID requirements?	Acceptable Identification
Asia Pacific (Seoul)	Local telephone numbers	Yes	<ol style="list-style-type: none"> 1. Your business address. It must be a local address corresponding to the area code of the telephone number(s). 2. Business Registration Documentation. Numbers can only be assigned to global companies, that are not owned by a Malaysian entity, and that have a branch or local office established in Malaysia, with proof of registration in the country. 3. An order form, which must include a name, address, contact person and a phone number. Use the form that is provided to you when you make the request.
Asia Pacific (Singapore)			
Asia Pacific (Sydney)			
Asia Pacific (Tokyo)			
	Toll-free prefixes: +60 1800	Yes	Business Registration Documentation. Your business address.

Supported Regions	Type of Number	Are there ID requirements?	Acceptable Identification
			A global address is acceptable.

Number portability

Supported Regions	Portability windows	Required Documents
Not supported	N/A	N/A

Malta (MT)

For ordering phone numbers

Supported Regions	Type of Number	Are there ID requirements?	Acceptable Identification
US East (N. Virginia)	UIFN	Yes	Your business name, address and service usage description. A global address is acceptable.
US West (Oregon)			
Africa (Cape Town)			
Asia Pacific (Singapore)			
Asia Pacific (Seoul)			

Supported Regions	Type of Number	Are there ID requirements?	Acceptable Identification
Asia Pacific (Sydney)			
Asia Pacific (Tokyo)			
Europe (Frankfurt)			
Europe (London)			

Number portability

Supported Regions	Portability windows	Required Documents
US East (N. Virginia)	Preset UIFN times only	Service Provider Change Authorization and Designation of Agency provided by Amazon
US West (Oregon)		
Africa (Cape Town)		
Asia Pacific (Singapore)		
Asia Pacific (Seoul)		
Asia Pacific (Sydney)		

Supported Regions	Portability windows	Required Documents
Asia Pacific (Tokyo)		
Europe (Frankfurt)		
Europe (London)		

Martinique (MQ)

For ordering phone numbers

Supported Regions	Type of Number	Are there ID requirements?	Acceptable Identification
US East (N. Virginia)	UIFN	Yes	Your business name, address and service usage description. A global address is acceptable.
US West (Oregon)			
Africa (Cape Town)			
Asia Pacific (Singapore)			
Asia Pacific (Seoul)			
Asia Pacific (Sydney)			

Supported Regions	Type of Number	Are there ID requirements?	Acceptable Identification
Asia Pacific (Tokyo)			
Europe (Frankfurt)			
Europe (London)			

Number portability

Supported Regions	Portability windows	Required Documents
US East (N. Virginia)	Preset UIFN times only	Service Provider Change Authorization and Designation of Agency provided by Amazon
US West (Oregon)		
Africa (Cape Town)		
Asia Pacific (Singapore)		
Asia Pacific (Seoul)		
Asia Pacific (Sydney)		
Asia Pacific (Tokyo)		

Supported Regions	Portability windows	Required Documents
Europe (Frankfurt)		
Europe (London)		

Mayotte (YT)

For ordering phone numbers

Supported Regions	Type of Number	Are there ID requirements?	Acceptable Identification
US East (N. Virginia)	UIFN	Yes	Your business name, address and service usage description. A global address is acceptable.
US West (Oregon)			
Africa (Cape Town)			
Asia Pacific (Singapore)			
Asia Pacific (Seoul)			
Asia Pacific (Sydney)			
Asia Pacific (Tokyo)			

Supported Regions	Type of Number	Are there ID requirements?	Acceptable Identification
Europe (Frankfurt)			
Europe (London)			

Number portability

Supported Regions	Portability windows	Required Documents
US East (N. Virginia)	Preset UIFN times only	Service Provider Change Authorization and Designation of Agency provided by Amazon
US West (Oregon)		
Africa (Cape Town)		
Asia Pacific (Singapore)		
Asia Pacific (Seoul)		
Asia Pacific (Sydney)		
Asia Pacific (Tokyo)		
Europe (Frankfurt)		
Europe (London)		

Mexico (MX)

For ordering phone numbers

Supported Regions	Type of Number	Are there ID requirements?	Acceptable Identification
US East (N. Virginia)	Local telephone numbers:	No	
US West (Oregon)	Toll-free prefixes: +52 800	No	

Number portability

Supported Regions	Portability windows	Required Documents
US East (N. Virginia) US West (Oregon)	Monday-Friday 10 AM to 12 PM CET or 2 PM to 4 PM CET	<ol style="list-style-type: none"> 1. Last invoice 2. Letter of Authorization (LOA): When you request porting services, we will provide you with a country-specific LOA template and explain how to complete it. 3. Copy of a representative's photo ID 4. Copy of local business registration

Monaco (MC)

For ordering phone numbers

Supported Regions	Type of Number	Are there ID requirements?	Acceptable Identification
US East (N. Virginia)	UIFN	Yes	Your business name, address and service usage description. A global address is acceptable.
US West (Oregon)			
Africa (Cape Town)			
Asia Pacific (Singapore)			
Asia Pacific (Seoul)			
Asia Pacific (Sydney)			
Asia Pacific (Tokyo)			
Europe (Frankfurt)			
Europe (London)			

Number portability

Supported Regions	Portability windows	Required Documents
US East (N. Virginia)	Preset UIFN times only	Service Provider Change Authorization and Designation of Agency provided by Amazon
US West (Oregon)		
Africa (Cape Town)		
Asia Pacific (Singapore)		
Asia Pacific (Seoul)		
Asia Pacific (Sydney)		
Asia Pacific (Tokyo)		
Europe (Frankfurt)		
Europe (London)		

New Zealand (NZ)

For UIFN numbers, supports standard [Regions and requirements](#).

For ordering phone numbers

Supported Regions	Type of Number	Are there ID requirements?	Acceptable Identification
Asia Pacific (Seoul)	Local telephone numbers:	No	
Asia Pacific (Singapore)	Toll-free prefixes: +64 800	No	
Asia Pacific (Sydney)			
Asia Pacific (Tokyo)			
>			

Number portability

Supported Regions	Portability windows	Required Documents
Asia Pacific (Seoul)	Monday-Friday 7 AM to 11 AM NZST	1. Last invoice
Asia Pacific (Singapore)		2. Letter of Authorization (LOA): When you request porting services, we will provide you with a country-specific LOA template and explain how to complete it.
Asia Pacific (Sydney)		3. Wholesale account number of the phone number from the current carrier.
Asia Pacific (Tokyo)		

Netherlands (NL)

For UIFN numbers, supports standard [Regions and requirements](#).

For ordering phone numbers

Supported Regions	Type of Number	Are there ID requirements?	Acceptable Identification
US East (N. Virginia) US West (Oregon)	Local telephone numbers:	Yes	Your business address. It must be a local address corresponding to the area code of the telephone number(s).
Canada (Central) Europe (Frankfurt) Europe (London)	Toll-free prefixes: +31 800	Yes	<p>An order form is required. Use the form that is provided to you when you make the request. Provide the following information:</p> <ul style="list-style-type: none"> Your name and address. A description of the service for which the number will be used. <p>A global address is acceptable.</p> <p>Estimated lead time from order to activation is 6 weeks.</p>
	National prefixes: +31 85	Yes	Your business address in the country.

Number portability

Supported Regions	Portability windows	Required Documents
US East (N. Virginia)	Monday-Friday 10 AM to 12 PM CET	<ol style="list-style-type: none"> 1. Last invoice 2. Letter of Authorization (LOA): When you request porting services, we will provide you with a country-specific LOA template and explain how to complete it. 3. Documents required for the Type of Number, as listed in the previous table for ordering phone numbers
US West (Oregon)		
Europe (Frankfurt)		
Europe (London)		

Nicaragua (NI)

For ordering phone numbers

Supported Regions	Type of Number	Are there ID requirements?	Acceptable Identification
US East (N. Virginia)	Mobile prefixes: +505 (7)	No	N/A
US West (Oregon)			

Norway (NO)

For ordering phone numbers

Supported Regions	Type of Number	Are there ID requirements?	Acceptable Identification
US East (N. Virginia)	Local telephone numbers:	Yes	Your business address in Norway, street code, municipality code, and company organization number.
US West (Oregon)			
Canada (Central)			
Europe (Frankfurt)	Toll-free prefixes: +47 800	Yes	Your business address in Norway, street code, municipality code, and company organization number. Norwegian business registration as proof of address.
Europe (London)			
	National prefixes: +47 81	Yes	Your business address in Norway, street code, municipality code, and company organization number. Norwegian business registration as proof of address.

Numbers are available to businesses only, not individuals. The DID type is Landline, instead of Geographic. This is because all formerly geographic numbers are now classified as landline, and do not have a geographic zone.

Number portability

Supported Regions	Portability windows	Required Documents
US East (N. Virginia)	Monday-Friday 10 AM to 12 PM CET	<ol style="list-style-type: none"> Last invoice Letter of Authorization (LOA): When you request porting services, we will provide you with a country-specific LOA template and explain how to complete it. Documents required for the Type of Number, as listed in the previous table for ordering phone numbers
US West (Oregon)		
Europe (Frankfurt)		
Europe (London)		

Panama (PA)

For ordering phone numbers

Supported Regions	Type of Number	Are there ID requirements?	Acceptable Identification
US East (N. Virginia)	Local telephone numbers:	No	
US West (Oregon)	Toll-free prefixes: +507 800	Yes	<p>Your business address.</p> <p>You can have a maximum of 5 Panama toll-free numbers per business name.</p>

Number portability

Supported Regions	Portability windows	Required Documents
US East (N. Virginia) US West (Oregon)	Monday-Friday 12 AM to 2 AM PST	<p>For porting local numbers:</p> <ol style="list-style-type: none"> 1. Last invoice and proof of payment 2. Letter of Authorization (LOA): When you request porting services, we will provide you with a country-specific LOA template and explain how to complete it. 3. Copy of legal representative's photo ID 4. Copy of local business registration <p>For porting toll-free numbers:</p> <ol style="list-style-type: none"> 1. Transfer Request 2. Proof of contract termination with the current provider, with a defined disconnection date within at least 14 days. 3. Documents required for the Type of Number, as listed in the previous table for ordering phone numbers.

Peru (PE)

For UIFN numbers, supports standard [Regions and requirements](#).

For ordering phone numbers

Supported Regions	Type of Number	Are there ID requirements?	Acceptable Identification
US East (N. Virginia)	Local telephone numbers:	No	
US West (Oregon)	Toll-free prefixes: +51800	No	

Number portability

Supported Regions	Portability windows	Required Documents
US East (N. Virginia) US West (Oregon)	Monday-Friday 10 PM to 4 AM PST	<ol style="list-style-type: none"> 1. Last invoice 2. Letter of Authorization (LOA): When you request porting services, we will provide you with a country-specific LOA template and explain how to complete it. 3. Copy of legal representative's photo ID 4. Copy of local business registration

Philippines (PH)

For ordering phone numbers

Supported Regions	Type of Number	Are there ID requirements?	Acceptable Identification
US East (N. Virginia)	UIFN	Yes	Your business name, address and service

Supported Regions	Type of Number	Are there ID requirements?	Acceptable Identification
US West (Oregon)			usage description. A global address is acceptable.
Africa (Cape Town)			
Asia Pacific (Singapore)			
Asia Pacific (Seoul)			
Asia Pacific (Sydney)			
Asia Pacific (Tokyo)			
Europe (Frankfurt)			
Europe (London)			

Number portability

Supported Regions	Portability windows	Required Documents
US East (N. Virginia)	Preset UIFN times only	Service Provider Change Authorization and Designation of Agency provided by Amazon
US West (Oregon)		

Supported Regions	Portability windows	Required Documents
Africa (Cape Town)		
Asia Pacific (Singapore)		
Asia Pacific (Seoul)		
Asia Pacific (Sydney)		
Asia Pacific (Tokyo)		
Europe (Frankfurt)		
Europe (London)		

Poland (PL)

For ordering phone numbers

Supported Regions	Type of Number	Are there ID requirements?	Acceptable Identification
US East (N. Virginia)	Local telephone numbers:	Yes	Your business address and a copy of a business registration.
US West (Oregon)			A local address corresponding to the area code of the telephone number(s) is required.
Canada (Central)			

Supported Regions	Type of Number	Are there ID requirements?	Acceptable Identification
Europe (Frankfurt) Europe (London)	Mobile prefixes: +48 73	Yes	Your business name, address and registration number, and a copy of the ID or passport of an authorized representative. A global address is acceptable.
	Toll-free prefixes: +48 800	No	

Number portability

Number portability is not available for toll-free and mobile numbers.

Supported Regions	Portability windows	Required Documents
US East (N. Virginia) US West (Oregon) Europe (Frankfurt) Europe (London)	Monday-Friday 12 AM CET	<ol style="list-style-type: none"> 1. Last invoice 2. Letter of Authorization (LOA): When you request porting services, we will provide you with a country-specific LOA template and explain how to complete it. 3. Documents required for the Type of Number, as listed in the previous table for ordering phone numbers

Portugal (PT)

For UIFN numbers, supports standard [Regions and requirements](#).

For ordering phone numbers

Supported Regions	Type of Number	Are there ID requirements?	Acceptable Identification
US East (N. Virginia)	Local telephone numbers:	Yes	Your business address. It must be a local address corresponding to the area code of the telephone number(s).
US West (Oregon)			
Canada (Central)			
Europe (Frankfurt)			
Europe (London)			
	National prefixes: +351 30	Yes	Your business address in Portugal. You must also submit the required proof of Telecom services being provided at the address.
	Toll-free prefixes: +351 800	Yes	Your business address, your tax ID, and a copy of the business registration. A business address in the European Union is required.

Number portability

Supported Regions	Portability windows	Required Documents
US East (N. Virginia) US West (Oregon) Europe (Frankfurt) Europe (London)	Monday-Friday 10 AM to 12 PM CET	<ol style="list-style-type: none"> 1. Last invoice 2. Letter of Authorization (LOA): When you request porting services, we will provide you with a country-specific LOA template and explain how to complete it. 3. CVP (Código de Validação de Portabilidade) of the requested number is mandatory. Obtain this code from the losing carrier. 4. Copy of legal representative's photo ID 5. Business registration (Certidão de Registo Comercial) 6. Documents required per Type of Number as listed in the previous table for ordering numbers

Puerto Rico (PR)

For ordering phone numbers

Supported Regions	Type of Number	Are there ID requirements?	Acceptable Identification
US East (N. Virginia)	Local telephone numbers: +1 787, +1 939	No	
US West (Oregon)	Toll-free prefixes: +1 800	No	

Supported Regions	Type of Number	Are there ID requirements?	Acceptable Identification
Canada (Central)			

Number portability

Supported Regions	Portability windows	Required Documents
US East (N. Virginia) US West (Oregon)	Monday-Friday 10 AM to 12 PM PST	<ol style="list-style-type: none"> Last invoice Letter of Authorization (LOA): When you request porting services, we will provide you with a country-specific LOA template and explain how to complete it.

Reunion (RE)

For ordering phone numbers

Supported Regions	Type of Number	Are there ID requirements?	Acceptable Identification
US East (N. Virginia) US West (Oregon) Africa (Cape Town)	UIFN	Yes	Your business name, address and service usage description. A global address is acceptable.

Supported Regions	Type of Number	Are there ID requirements?	Acceptable Identification
Asia Pacific (Singapore)			
Asia Pacific (Seoul)			
Asia Pacific (Sydney)			
Asia Pacific (Tokyo)			
Europe (Frankfurt)			
Europe (London)			

Number portability

Supported Regions	Portability windows	Required Documents
US East (N. Virginia)	Preset UIFN times only	Service Provider Change Authorization and Designation of Agency provided by Amazon
US West (Oregon)		
Africa (Cape Town)		
Asia Pacific (Singapore)		

Supported Regions	Portability windows	Required Documents
Asia Pacific (Seoul)		
Asia Pacific (Sydney)		
Asia Pacific (Tokyo)		
Europe (Frankfurt)		
Europe (London)		

Romania (RO)

For UIFN numbers, supports standard [Regions and requirements](#).

For ordering phone numbers

Supported Regions	Type of Number	Are there ID requirements?	Acceptable Identification
Europe (Frankfurt)	Local telephone numbers:	Yes	Your address and proof of address. It must be a local address corresponding to the area code of the telephone number(s).
Europe (London)	National prefixes: +40 376	No	

Number portability

Supported Regions	Portability windows	Required Documents
Europe (Frankfurt) Europe (London)	Monday-Friday 10 AM to 12 PM PST	<ol style="list-style-type: none"> 1. Last invoice 2. Letter of Authorization (LOA): When you request porting services, we will provide you with a country-specific LOA template and explain how to complete it. 3. Documents required for the Type of Number, as listed in the previous table for ordering phone numbers

Saba (BQ)

For ordering phone numbers

Supported Regions	Type of Number	Are there ID requirements?	Acceptable Identification
US East (N. Virginia) US West (Oregon)	Local telephone numbers: +599 4	Yes	<p>An order form is required. Use the form that is provided to you when you make the request. Provide the following information:</p> <ul style="list-style-type: none"> • Your name and address • A description of the service for which the number(s) will be used

Supported Regions	Type of Number	Are there ID requirements?	Acceptable Identification
-------------------	----------------	----------------------------	---------------------------

A global address is acceptable.

Number portability

Porting of specific number ranges is supported. Create an AWS Support ticket to verify the portability of your number(s).

Saint Pierre and Miquelon (PM)

For ordering phone numbers

Supported Regions	Type of Number	Are there ID requirements?	Acceptable Identification
US East (N. Virginia)	UIFN	Yes	Your business name, address and service usage description. A global address is acceptable.
US West (Oregon)			
Africa (Cape Town)			
Asia Pacific (Singapore)			
Asia Pacific (Seoul)			
Asia Pacific (Sydney)			

Supported Regions	Type of Number	Are there ID requirements?	Acceptable Identification
Asia Pacific (Tokyo)			
Europe (Frankfurt)			
Europe (London)			

Number portability

Supported Regions	Portability windows	Required Documents
US East (N. Virginia)	Preset UIFN times only	Service Provider Change Authorization and Designation of Agency provided by Amazon
US West (Oregon)		
Africa (Cape Town)		
Asia Pacific (Singapore)		
Asia Pacific (Seoul)		
Asia Pacific (Sydney)		
Asia Pacific (Tokyo)		

Supported Regions	Portability windows	Required Documents
Europe (Frankfurt)		
Europe (London)		

Serbia (RS)

For ordering phone numbers

Supported Regions	Type of Number	Are there ID requirements?	Acceptable Identification
Europe (Frankfurt)	Local telephone numbers:	Yes	Your business name, address and service usage description. A global address is acceptable.
Europe (London)	Toll-free prefixes:	No	

Number portability

Supported Regions	Portability windows	Required Documents
Not supported	N/A	N/A

Saint Lucia (LC)

For ordering phone numbers

Supported Regions	Type of Number	Are there ID requirements?	Acceptable Identification
US East (N. Virginia) US West (Oregon)	Local telephone numbers:	Yes	<p>An order form is required. Use the form that is provided to you when you make the request. Provide the following information:</p> <ul style="list-style-type: none"> Your name and address A description of the service for which the number(s) will be used <p>A global address is acceptable.</p>

Number portability

Porting of specific number ranges is supported. Create an AWS Support ticket to verify the portability of your number(s).

Saint Martin (MF)

For ordering phone numbers

Supported Regions	Type of Number	Are there ID requirements?	Acceptable Identification
US East (N. Virginia)	Local telephone numbers: +1 758	Yes	An order form is required. Use the form

Supported Regions	Type of Number	Are there ID requirements?	Acceptable Identification
US West (Oregon)			<p>that is provided to you when you make the request. Provide the following information:</p> <ul style="list-style-type: none"> Your name and address A description of the service for which the number(s) will be used <p>A global address is acceptable.</p>

Number portability

Porting of specific number ranges is supported. Create an AWS Support ticket to verify the portability of your number(s).

Singapore (SG)

For UIFN numbers, supports standard [Regions and requirements](#).

For ordering phone numbers

Supported Regions	Type of Number	Are there ID requirements?	Acceptable Identification
Asia Pacific (Seoul)	National prefixes: +65 31 and +65 6	Yes	Address required in country.
Asia Pacific (Singapore)			Documents required for company: Company registration documents

Supported Regions	Type of Number	Are there ID requirements?	Acceptable Identification
Asia Pacific (Sydney)	Toll-free prefixes: +65 800	Yes	Your business address.
Asia Pacific (Tokyo)			A global address is acceptable.

Number portability

Number portability is not available for toll-free numbers.

Supported Regions	Portability windows	Required Documents
Asia Pacific (Singapore)	NA	<ol style="list-style-type: none"> Last invoice Letter of Authorization (LOA): When you request porting services, we will provide you with a country-specific LOA template and explain how to complete it. List of Port in Numbers

Porting-out is only possible for contiguous number blocks of 10 numbers (...0 to ...9) due to market practice.

Sint Eustatius (BQ)

For ordering phone numbers

Supported Regions	Type of Number	Are there ID requirements?	Acceptable Identification
US East (N. Virginia)	Local telephone numbers: +599 3	Yes	An order form is required. Use the form

Supported Regions	Type of Number	Are there ID requirements?	Acceptable Identification
US West (Oregon)			<p>that is provided to you when you make the request. Provide the following information:</p> <ul style="list-style-type: none"> Your name and address A description of the service for which the number(s) will be used <p>A global address is acceptable.</p>

Number portability

Porting of specific number ranges is supported. Create an AWS Support ticket to verify the portability of your number(s).

Sint Maarten (SX)

For ordering phone numbers

Supported Regions	Type of Number	Are there ID requirements?	Acceptable Identification
US East (N. Virginia)	Local telephone numbers: +1 721	Yes	<p>An order form is required. Use the form that is provided to you when you make the request. Provide the following information:</p> <ul style="list-style-type: none"> Your name and address
US West (Oregon)			

Supported Regions	Type of Number	Are there ID requirements?	Acceptable Identification
			<ul style="list-style-type: none"> A description of the service for which the number(s) will be used <p>A global address is acceptable.</p>

Number portability

Porting of specific number ranges is supported. Create an AWS Support ticket to verify the portability of your number(s).

Slovakia (SK)

For UIFN numbers, supports standard [Regions and requirements](#).

For ordering phone numbers

Supported Regions	Type of Number	Are there ID requirements?	Acceptable Identification
US East (N. Virginia)	Local telephone numbers:	Yes	Your business address. It must be a local address corresponding to the area code of the telephone number(s).
US West (Oregon)			
Canada (Central)	Toll-free prefixes: +421 800	No	
Europe (Frankfurt)			
Europe (London)			

Number portability

Supported Regions	Portability windows	Required Documents
US East (N. Virginia)	Monday-Friday 10 AM to 12 PM CET	<ol style="list-style-type: none"> 1. Last invoice 2. Letter of Authorization (LOA): When you request porting services, we will provide you with a country-specific LOA template and explain how to complete it. 3. Documents required for the Type of Number, as listed in the previous table for ordering phone numbers
US West (Oregon)		
Europe (Frankfurt)		
Europe (London)		

Slovenia (SI)

For UIFN numbers, supports standard [Regions and requirements](#).

For ordering phone numbers

Supported Regions	Type of Number	Are there ID requirements?	Acceptable Identification
Europe (Frankfurt) Europe (London)	Local telephone numbers:	Yes	Your business address. It must be a local address corresponding to the area code of the telephone number(s).
	Toll-free prefixes: +386 80	No	
	National prefixes: +386 82	Yes	An address in Slovenia is required.

Number portability

Supported Regions	Portability windows	Required Documents
Europe (Frankfurt) Europe (London)	Monday-Friday 10 AM to 12 PM CET	<ol style="list-style-type: none"> 1. Last invoice 2. Letter of Authorization (LOA): When you request porting services, we will provide you with a country-specific LOA template and explain how to complete it. 3. Documents required for the Type of Number, as listed in the previous table for ordering phone numbers

South Africa (ZA)

For UIFN numbers, supports standard [Regions and requirements](#).

For ordering phone numbers

Supported Regions	Type of Number	Are there ID requirements?	Acceptable Identification
Africa (Cape Town)	Local numbers:	Yes	Your business address. It must be a local address corresponding to the area code of the telephone number(s). Your Tax ID.
	Mobile numbers:	Yes	Your business address in South Africa and proof of address such as one of the following documents: :

Supported Regions	Type of Number	Are there ID requirements?	Acceptable Identification
			<ul style="list-style-type: none"> Excerpt from the commercial register showing the South Africa address Utility bill Tax notice Rent receipt Title deed
	Toll-free prefixes: +27 80	Yes	Your business address in South Africa, along with your tax ID, and a service description.
	Shared-Cost prefixes: +27 860, +27 861	Yes	Your business address in South Africa, along with your tax ID, and a service description.

Number portability

Supported Regions	Portability windows	Required Documents
Africa (Cape Town)	Monday - Friday 5 PM – 6 PM GMT+2 (SAST)	<ol style="list-style-type: none"> Last invoice. Letter of Authorization (LOA): When you request porting services, we will provide you with a country-specific LOA template and explain how to complete it. Documents required for the Type of Number, as listed in the

Supported Regions	Portability windows	Required Documents
		previous table for ordering phone numbers.

South Korea (KR)

Note

Ordering and porting numbers in South Korea takes longer than most other countries because of extra steps related to Regulator review, and because the many of the steps must be performed in Korean. For more information about ordering and porting numbers in South Korea, see [Things to know about South Korean numbers, regulations, and porting](#).

For UIFN numbers, supports standard [Regions and requirements](#).

For ordering phone numbers

Supported Regions	Type of Number	Are there ID requirements?	Acceptable Identification
Asia Pacific (Seoul)	VoIP prefixes numbers: +82 70	Yes	<p>Local customers should provide a copy of their business (tax office) registration certificate, which is issued by local tax authorities and shows the company's registered address.</p> <p>Submit an AWS Support ticket to verify the documents for new number(s) ordering.</p>

Supported Regions	Type of Number	Are there ID requirements?	Acceptable Identification
	Representative numbers: +82 15, +82 16	Yes	<p>Representative number order form is required. Use the form that is provided to you when you make the request. Along with this form, the following documents are required:</p> <ul style="list-style-type: none">Local customers should provide a copy of their business (tax office) registration certificate, which is issued by local tax authorities and shows the company's registered address. <p>Submit an AWS Support ticket to verify the documents for new number(s) ordering.</p>

Supported Regions	Type of Number	Are there ID requirements?	Acceptable Identification
	Toll-free prefixes: +82 308	Yes	<p>Your business address in South Korea.</p> <p>Local customers should provide a copy of their business (tax office) registration certificate, which is issued by local tax authorities and shows the company's registered address.</p> <p>Submit an AWS Support ticket to verify the documents for new number(s) ordering.</p> <p>Submit an AWS Support ticket to order a new number.</p>

Supported Regions	Type of Number	Are there ID requirements?	Acceptable Identification
	Geographic Prefixes: +822	Yes (via Porting)	<p>Same as for VOIP numbers, but the provided business registration document should reference a physical location associated with +822 (Seoul) zone.</p> <p>But if new local numbers are needed due to the Korean regulations requiring new local numbers to be physically installed as legacy services, we recommend you pre-plan migrations and ensure that you request numbers with existing providers that have a minimum of 6 months of physical installation of the number.</p> <p>Amazon Connect can support migration of a large number of DIDs, and can port numbers older than 6 months directly to Amazon Connect.</p>

Number portability

Supported Regions	Type of number	Portability windows	Required documents
Asia Pacific (Seoul)	Geographic Prefixes: +82 2 (any +82 number other than +821, +825, +827, +82308)	Monday-Friday 10 AM to 12 PM CET	<p>New SIP Order Form and SIP Port Form for the existing number(s). Use the forms that are provided to you when you make the request. Documents must be signed by a company employee whose month and year of birth are noted, and the company stamp must be applied. Along with these forms the following documents are required:</p> <ol style="list-style-type: none"> 1. Korean Business Certificate within 6 months. The certificate must match the geographic zone 2. Personal ID for person signing the form 3. Certificate of Seal Impression <p>Submit an AWS Support ticket to verify the portability of your number(s).</p>

Supported Regions	Type of number	Portability windows	Required documents
	National Prefixes: +82 50	Monday-Friday 10 AM to 12 PM CET	<p>New SIP Order Form and SIP Port Form for the existing number(s) . Use the forms that are provided to you when you make the request. Documents must be signed by a company employee whose month and year of birth are noted, and the company stamp must be applied. Along with these forms the following documents are required:</p> <ol style="list-style-type: none"> 1. Korean Business Certificate within 6 months. The certificate must match the geographic zone 2. Personal ID for person signing the form 3. Certificate of Seal Impression <p>Submit an AWS Support ticket to verify the portability of your number(s).</p>

Supported Regions	Type of number	Portability windows	Required documents
	Representative numbers: +82 15, +82 16	Monday-Friday 10 AM to 12 PM CET	<p>RN/TFN change form is required. Use the form that is provided to you when you make the request. Along with this form the following documents are required:</p> <ol style="list-style-type: none"> 1. Copy of the company certified registration within 6 months <p>Submit an AWS Support ticket to verify the portability of your number(s).</p>
	Toll-free prefixes: +82 308	Monday-Friday 10 AM to 12 PM CET	<p>RN/TFN change form required. Use the form that is provided to you when you make the request. Along with this form the following documents are required:</p> <ol style="list-style-type: none"> 1. Copy of the company certified registration within 6 months <p>Submit an AWS Support ticket to verify the documents for new number(s) ordering.</p>

Supported Regions	Type of number	Portability windows	Required documents
	VoIP prefixes numbers: +82 70	Monday-Friday 10 AM to 12 PM CET	<p>Effectively, callforward to another +8270 is possible.</p> <p>New SIP Order Form and SIP Port Form for the existing number(s) . Use the forms that are provided to you when you make the request. Documents must be signed by a company employee whose month and year of birth are noted, and the company stamp must be applied. Along with these forms the following documents are required:</p> <ol style="list-style-type: none"> 1. Korean Business Certificate within 6 months. The certificate must match the geographic zone. 2. Personal ID for person signing the form. 3. Certificate of Seal Impression <p>Submit an AWS Support ticket to verify the</p>

Supported Regions	Type of number	Portability windows	Required documents
-------------------	----------------	---------------------	--------------------

portability of your number(s).

Spain (ES)

For UIFN numbers, supports standard [Regions and requirements](#).

For ordering phone numbers

Supported Regions	Type of Number	Are there ID requirements?	Acceptable Identification
US East (N. Virginia)	Local telephone numbers:	Yes	Your business address in Spain in the relevant geographic zone, and your tax ID (CIF). A copy of the business registration and a proof of address.
US West (Oregon)			
Canada (Central)			
Europe (Frankfurt)	Toll-free prefixes: +34 900	No	
Europe (London)	National prefixes: +34 902	Yes	Your business address in Spain. A copy of the business registration and a proof of address.

Number portability

Supported Regions	Portability windows	Required Documents
US East (N. Virginia)	Monday-Friday 10 AM to 12 PM CET	1. Last invoice
US West (Oregon)		2. Letter of Authorization (LOA): When you request porting services, we will provide you with a country-specific LOA template and explain how to complete it.
Europe (Frankfurt)		3. CIF/NIF (VAT number)
Europe (London)		4. Documents required for the Type of Number, as listed in the previous table for ordering phone numbers

Sweden (SE)

For ordering phone numbers

Supported Regions	Type of Number	Are there ID requirements?	Acceptable Identification
US East (N. Virginia)	Local telephone numbers:	Yes	Your business address in Sweden, your VAT number, and a copy of the business registration.
US West (Oregon)			
Canada (Central)	National prefixes: +46 77 and +46 10	Yes	Your business address in Sweden, your VAT number, and a copy of the business registration.
Europe (Frankfurt)	Mobile prefixes: +46 766	No	

Supported Regions	Type of Number	Are there ID requirements?	Acceptable Identification
Europe (London)	Toll-free prefixes: +46 20	Yes	Your business address in the European Union, your VAT number, and a copy of the business registration.

Number portability

Number portability is not available for +46 77 numbers.

Supported Regions	Portability windows	Required Documents
US East (N. Virginia) US West (Oregon) Europe (Frankfurt) Europe (London)	Monday-Friday 10 AM to 12 PM CET	<ol style="list-style-type: none"> 1. Last invoice 2. Letter of Authorization (LOA): When you request porting services, we will provide you with a country-specific LOA template and explain how to complete it. 3. Your tax number has to be provided. A Swedish organization number usually contains 12 digits, starting with 16 if it is from a company, or 19 or 20 if it's personal. 4. Documents required for the Type of Number, as listed in the previous table for ordering phone numbers

Switzerland (CH)

For UIFN numbers, supports standard [Regions and requirements](#).

For ordering phone numbers

Supported Regions	Type of Number	Are there ID requirements?	Acceptable Identification
US East (N. Virginia)	Local telephone numbers:	Yes	Your business address in the country. A copy of the ID/business registration and a proof of address.
US West (Oregon)			
Canada (Central)	Toll-free prefixes: +41 800	Yes	Your business address and a copy of business registration. A global address is acceptable.
Europe (Frankfurt)			
Europe (London)			

Number portability

Supported Regions	Portability windows	Required Documents
US East (N. Virginia)	Monday-Friday 10 AM to 12 PM CET	<ol style="list-style-type: none"> Last invoice Letter of Authorization (LOA): When you request porting services, we will provide you with a country-specific LOA template and explain how to complete it. Documents required for the Type of Number, as listed in the
US West (Oregon)		
Europe (Frankfurt)		
Europe (London)		

Supported Regions	Portability windows	Required Documents
		<p>previous table for ordering phone numbers</p> <ol style="list-style-type: none"> 4. Proof of address 5. Company registration

Taiwan (TW)

For ordering phone numbers

Supported Regions	Type of Number	Are there ID requirements?	Acceptable Identification
US East (N. Virginia)	UIFN	Yes	Your business name, address and service usage description. A global address is acceptable.
US West (Oregon)			
Africa (Cape Town)			
Asia Pacific (Singapore)			
Asia Pacific (Seoul)			
Asia Pacific (Sydney)			
Asia Pacific (Tokyo)			

Supported Regions	Type of Number	Are there ID requirements?	Acceptable Identification
Europe (Frankfurt)			
Europe (London)			

Number portability

Supported Regions	Portability windows	Required Documents
US East (N. Virginia)	Preset UIFN times only	Service Provider Change Authorization and Designation of Agency provided by Amazon
US West (Oregon)		
Africa (Cape Town)		
Asia Pacific (Singapore)		
Asia Pacific (Seoul)		
Asia Pacific (Sydney)		
Asia Pacific (Tokyo)		
Europe (Frankfurt)		
Europe (London)		

Thailand (TH)

For UIFN numbers, supports standard [Regions and requirements](#).

For ordering phone numbers

Supported Regions	Type of Number	Are there ID requirements?	Acceptable Identification	Restrictions
Asia Pacific (Seoul)	Local telephone numbers:	Yes	For business address inside Thailand: Business must provide a copy of the ID of a company authorized representative and company certificate. For business address outside of Thailand: Proof of business address and proof of ID, such as the business registration. Also, a copy of the ID or passport of an authorized representative.	International caller ID is not guaranteed.
Asia Pacific (Singapore)				
Asia Pacific (Sydney)				
Asia Pacific (Tokyo)				
	Toll-free prefixes: +66 1800	Yes	Proof of business address and proof of ID, such as the business registration. Also, a copy of the ID or passport	

Supported Regions	Type of Number	Are there ID requirements?	Acceptable Identification	Restrictions
			<p>of an authorized representative.</p> <p>The address cannot be in Thailand.</p>	

Number portability

Supported Regions	Portability windows	Required Documents
Not supported	N/A	N/A

Trinidad and Tobago (TT)

For ordering phone numbers

Supported Regions	Type of Number	Are there ID requirements?	Acceptable Identification
US East (N. Virginia)	Local telephone numbers: +1 868	Yes	<p>An order form is required. Use the form that is provided to you when you make the request. Provide the following information:</p> <ul style="list-style-type: none"> Your name and address A description of the service for which the number(s) will be used
US West (Oregon)			

Supported Regions	Type of Number	Are there ID requirements?	Acceptable Identification
			A global address is acceptable.

Number portability

Porting of specific number ranges is supported. Create an AWS Support ticket to verify the portability of your number(s).

Turks and Caicos (TC)

For ordering phone numbers

Supported Regions	Type of Number	Are there ID requirements?	Acceptable Identification
US East (N. Virginia)	Local telephone numbers: +1 649	Yes	<p>An order form is required. Use the form that is provided to you when you make the request. Provide the following information:</p> <ul style="list-style-type: none"> Your name and address A description of the service for which the number(s) will be used <p>A global address is acceptable.</p>
US West (Oregon)			

Number portability

Porting of specific number ranges is supported. Create an AWS Support ticket to verify the portability of your number(s).

Uganda (UG)

For ordering phone numbers

Supported Regions	Type of Number	Are there ID requirements?	Acceptable Identification
Africa (Cape Town)	Local telephone numbers:	Yes	<p>Businesses must provide a copy of business registration containing a proof of address.</p> <p>Valid proofs of address include: third-party issued bank statements, utility bills (all issued in the previous 6 months); government documents (issued in the previous year).</p> <p>The business address must be inside of Uganda.</p>
	Toll-free prefixes	No	

Number portability

Supported Regions	Portability windows	Required Documents
Not supported	N/A	N/A

United Kingdom (GB)

For UIFN numbers, supports standard [Regions and requirements](#).

For ordering phone numbers

Supported Regions	Type of Number	Are there ID requirements?	Acceptable Identification
US East (N. Virginia)	Local telephone numbers: +44 1, +44 2	No	
US West (Oregon)	Mobile prefixes: +44 7	No	
Asia Pacific (Seoul)	Toll-free prefixes: +44 800, +44 808	No	
Asia Pacific (Singapore)	National prefixes: +44 33, +44 84	No	
Asia Pacific (Sydney)			
Asia Pacific (Tokyo)			
Canada (Central)			
Europe (Frankfurt)			
Europe (London)			

Number portability

Supported Regions	Portability windows	Required Documents
US East (N. Virginia)	For local (geographic) numbers: Monday-Friday 9AM to 11AM GMT	<ol style="list-style-type: none"> Last invoice Site address in the UK for local numbers. Letter of Authorization (LOA): When you request porting services, we will provide you with a country-specific LOA template and explain how to complete it. <p>When porting +44 300 numbers, additional documents might be required to prove you are a public sector or non-profit body.</p>
US West (Oregon)	For non-geographic (national, toll-free) numbers: Monday-Friday 0AM to 4AM GMT	
Asia Pacific (Seoul)		
Asia Pacific (Singapore)		
Asia Pacific (Sydney)		
Asia Pacific (Tokyo)		
Europe (Frankfurt)		
Europe (London)		

United States (US)

For ordering phone numbers

Supported Regions	Type of Number	Are there ID requirements?	Acceptable Identification
US East (N. Virginia)	Local telephone numbers:	No	
	Toll-free prefixes:	No	

Supported Regions	Type of Number	Are there ID requirements?	Acceptable Identification
US West (Oregon)			
Asia Pacific (Seoul)			
Asia Pacific (Singapore)			
Asia Pacific (Sydney)			
Asia Pacific (Tokyo)			
Canada (Central)			
Europe (Frankfurt)			
Europe (London)			

Number portability

Supported Regions	Portability windows	Required Documents
US East (N. Virginia)	Monday-Friday 7 AM to 5PM CST	<ol style="list-style-type: none"> Last invoice Letter of Authorization (LOA): When you request porting services, we will provide you with
US West (Oregon)		

Supported Regions	Portability windows	Required Documents
Asia Pacific (Seoul)		a country-specific LOA template and explain how to complete it.
Asia Pacific (Singapore)		
Asia Pacific (Sydney)		
Asia Pacific (Tokyo)		
Europe (Frankfurt)		
Europe (London)		

Uruguay (UY)

For ordering phone numbers

Supported Regions	Type of Number	Are there ID requirements?	Acceptable Identification
US East (N. Virginia)	UIFN	Yes	Your business name, address and service usage description. A global address is acceptable.
US West (Oregon)			
Africa (Cape Town)			

Supported Regions	Type of Number	Are there ID requirements?	Acceptable Identification
Asia Pacific (Singapore)			
Asia Pacific (Seoul)			
Asia Pacific (Sydney)			
Asia Pacific (Tokyo)			
Europe (Frankfurt)			
Europe (London)			

Number portability

Supported Regions	Portability windows	Required Documents
US East (N. Virginia)	Preset UIFN times only	Service Provider Change Authorization and Designation of Agency provided by Amazon
US West (Oregon)		
Africa (Cape Town)		
Asia Pacific (Singapore)		

Supported Regions	Portability windows	Required Documents
Asia Pacific (Seoul)		
Asia Pacific (Sydney)		
Asia Pacific (Tokyo)		
Europe (Frankfurt)		
Europe (London)		

Venezuela (VE)

For ordering phone numbers

Supported Regions	Type of Number	Are there ID requirements?	Acceptable Identification
US East (N. Virginia)	Local telephone numbers	No	Not applicable
	Toll-free prefixes	No	Not applicable
US West (Oregon)			

Number portability

Porting is not supported.

Vietnam (VN)

For ordering phone numbers

Supported Regions	Type of Number	Are there ID requirements?	Acceptable Identification
Asia Pacific (Singapore)	Local telephone numbers:	No	
Asia Pacific (Sydney) Asia Pacific (Tokyo)	Toll-free prefixes:	yes	<p>Businesses must provide a copy of business registration containing a proof of address.</p> <p>Valid proofs of address include: third-party issued bank statements, utility bills (all issued in the previous 6 months); government documents (issued in the previous year).</p> <p>The business address must be outside Vietnam.</p>

Coverage Limitations

- Local : All major networks except minority three networks FPT, CMC and Gtel.
- TFN : National reachability only from: VNPT fixed network, Vinaphone Mobile, and SPT network.

Number portability

Supported Regions	Portability windows	Required Documents
Not supported	N/A	N/A

UIFN requirements

For ordering phone numbers

Supported Regions	Type of Number	Are there ID requirements?	Acceptable Identification
US East (N. Virginia)	UIFN	Yes	Your business name, address and service usage description. A global address is acceptable.
US West (Oregon)			
Africa (Cape Town)			
Asia Pacific (Singapore)			
Asia Pacific (Seoul)			
Asia Pacific (Sydney)			
Asia Pacific (Tokyo)			
Europe (Frankfurt)			

Supported Regions	Type of Number	Are there ID requirements?	Acceptable Identification
-------------------	----------------	----------------------------	---------------------------

Europe
(London)

Number portability

Supported Regions	Portability windows	Required Documents
US East (N. Virginia)	Preset UIFN times only	Service Provider Change Authorization and Designation of Agency provided by Amazon
US West (Oregon)		
Africa (Cape Town)		
Asia Pacific (Singapore)		
Asia Pacific (Seoul)		
Asia Pacific (Sydney)		
Asia Pacific (Tokyo)		
Europe (Frankfurt)		
Europe (London)		

Set up outbound calling

You can send outbound calls to customers for a variety of reasons, such as appointment reminders, subscription renewals, and debt collection. Amazon Connect provides both normal and outbound campaign capabilities. For more information about campaigns, see [Set up Amazon Connect outbound campaigns](#) in this guide.

Contents

- [Set up outbound caller ID](#)
- [Set up US emergency calling in Amazon Connect](#)
- [Enable outbound calls](#)
- [Outbound calling restrictions](#)
- [Optimize your reputation for outbound calling](#)

Set up outbound caller ID

This topic explains how to set up your outbound caller ID name and number.

Contents

- [Outbound parameters: Set in queue](#)
- [How to set the caller ID number dynamically](#)
- [Use E.164 format for international phone numbers](#)
- [How to specify a custom caller ID number using a block](#)
- [CNAM](#)
- [How to avoid labels like "spam" and "telemarketer"](#)

Outbound parameters: Set in queue

You set the outbound caller ID name (such as the name of your company) and caller ID number in the queue settings. To edit queue settings, on the navigation menu choose **Routing, Queues**, and then choose the queue you want to edit.

The following image shows an **Edit queue** page with an arrow pointing to the **Outbound caller ID name** and **Outbound caller ID number**.

Edit queue

Cancel **Save**

Name
Escalation queue

Description
Network issues
236 of 250 characters remaining.
[Show additional queue information](#)

Hours of operation
Basic Hours x ▾

Outbound caller ID name
Example Corp
The name that will show up on the customer's phone

Outbound caller ID number
+1 [REDACTED] x ▾

Outbound whisper flow (optional)
Search for contact flow ▾

Maximum contacts in queue (optional)
 Set a limit
9
Note: queued callbacks may exceed this limit

Outbound caller ID name

The **Outbound caller ID name** is set to the value that is passed from the SIP header. For example, Alice<sip:alice@example.com>.

Important

Amazon Connect runs on a SIP-only infrastructure through our carrier partners. However, the caller ID name can be delivered to your customers only if the call path across the public telephony network is all on SIP. Because your customers are on many different networks outside of what Amazon Connect controls, the caller ID name is not guaranteed to be delivered to your customers. Depending on the country this will be up to 75% effective. To guarantee your caller ID name is delivered to customers, see [Optimize your reputation for outbound calling](#) for information about achieving it by using partner solutions.

Outbound caller ID number

Only phone numbers that you've [claimed](#) or [ported to Amazon Connect](#) can be used as your caller ID number. Outbound calls without proper identification may be blocked in certain countries such as UK and Australia.

To use an external phone number as your outbound caller ID number, contact AWS Support to see if it's possible. The phone number needs to be in a [country we support](#) for custom caller ID and you'll need to provide [proof of ownership](#).

1. Choose [Account and billing](#) to access a pre-populated form in the AWS Support console. You must be signed in to your AWS account to access the form.
2. For **Service**, *Connect (Number Management)* should be selected.
3. For **Category**, *Custom Outbound Called ID* should be selected.
4. Select the required severity.
5. Choose **Next step: Additional information**
6. On the **Additional information** page:
 - a. Enter the subject.
 - b. Under **Description**, include as much information as possible about your request, If you don't know all of these details, you can leave information out.
7. Choose **Next step: Solve now or contact us**.
8. On the **Solve now or contact us** page:
 - Choose the **Contact us** tab and select your **Preferred contact language** and your preferred contact method.
9. Choose **Submit**.
10. The Amazon Connect team will review your ticket and get back to you.

You can set the caller ID number as follows:

- **[Call phone number](#) block**: Use this block in an [Outbound whisper flow](#) to initiate an outbound call to a customer and, optionally, specify a custom caller ID number that is displayed to call recipients.

This block is useful when you have multiple telephone numbers used to make outbound calls, but want to consistently display the same company phone number for the caller ID for calls made from your contact center.

You can also use this block with the [Set contact attributes](#) block to set the callback number dynamically. For example, you can display a certain caller ID number based on the customer's account type.

- **Queue:** If no caller ID number is specified in the [Call phone number](#) block, then the caller ID in the queue settings is used.

Important

- Telecom regulations in various countries limit the telephone numbers that you can use to make outbound calls. If you set up a number and you can't make outbound calls, check the [Amazon Connect Telecoms Country Coverage Guide](#) and [Region requirements for ordering and porting phone numbers](#) to ensure that you have correct type of number.
- Telecom regulations in certain countries require the carrier to identify the caller and block unidentifiable outbound calls. Make sure you set the Caller ID in your configurations to avoid call failures.

Toll-free numbers for caller ID

Toll-free numbers for outbound communications have a number of limitations. For example, using a toll-free number to dial other toll-free numbers in the United States can result in the number being filtered, blocked, or not properly routed to the destination by carriers. Toll-free numbers may be terminated at a higher than expected rate. If you know you need to call toll-free numbers in the United States you must use DIDs to guarantee call delivery.

If you use toll-free numbers outside of the US, refer to the [Amazon Connect Telecoms Country Coverage Guide](#) to see which countries support toll-free numbers as outbound. For example, for Australia the **National Outbound** column indicates that toll-free numbers are not supported.

⚠ Important

Toll-free products are designed to be national products and used within a country. We do not guarantee international reachability of any of these services, as access to the numbers is controlled by a caller's network access.

How to set the caller ID number dynamically

Use an attribute in the [Call phone number](#) block to set the caller ID number dynamically during the flow.

The attribute can be one you define in the [Set contact attributes](#) block in the flow. Or, it can be an external attribute returned from an AWS Lambda function.

The value of the attribute must be a phone number from your instance in [E.164](#) format.

- If the number is not in E.164 format, the number from the queue associated with the [Outbound whisper flow](#) is used for the caller ID number.
- If no number is set for the outbound caller ID number for the queue, the call attempt will fail.

For more information about setting the caller ID dynamically, see this AWS Support Knowledge Center article: [How can I set my Amazon Connect outbound caller ID dynamically based on country?](#)

Use E.164 format for international phone numbers

Amazon Connect requires phone numbers in [E.164](#) format.

To express a US phone number in E.164 format, add the '+' prefix and the country code in front of the number. For example, for a US number:

- +1-800-555-1212

In the UK and many other countries internationally, local dialing requires the addition of a 0 in front of the subscriber number. However, to use E.164 formatting, this 0 must be removed. A number such as 020 718 xxxxx in the UK would be formatted as +44 20 718 xxxxx. When you place calls from the CCP using Amazon Connect the CCP provides the correct formatting for numbers automatically.

⚠ Important

Phone numbers that are not formatted in E.164 will not work. They will also result in a breach of [Amazon Connect Service Terms and conditions](#) for acceptable use which may result in your service being suspended.

How to specify a custom caller ID number using a [Call phone number](#) block

1. On the left navigation menu, choose **Routing, Flows**.
2. Choose the down arrow next to **Create flow**, and then choose **Create outbound whisper flow**.
3. Add a [Call phone number](#) block to the flow, and connect the **Entry point** block to it.

The [Call phone number](#) block must be placed before a **Play prompt** block if one is included in your flow.

4. Select the [Call phone number](#) block, and then select **Caller ID number to display**.
5. Do one of the following:
 - To use a number from your instance, choose **Select a number from your instance**, and then search for or select the number to use from the drop-down.
 - Choose **Use attribute** to use a contact attribute to provide the value for the caller ID number. You can use either a **User Defined** attribute you create using a [Set contact attributes](#) block, or an **External** attribute returned from an AWS Lambda function. The value of any attribute you use must be a phone number claimed for your instance and be in E.164 format. If the number used from an attribute is not in E.164 format, the number set for the **Outbound caller ID number** for the queue is used.

⚠ Important

- The value of any attribute you use must be a phone number claimed for your instance. The number must be in E.164 format. If the number used from an attribute is not in E.164 format, calls may be terminated by the destination networks.
- It is your responsibility to ensure the numbers you are using are legally permissible. Certain numbers, such as +44870 numbers in the UK, are not legally permissible. You must ensure you're not using them.

6. Add any additional blocks to complete your flow, and connect the **Success** branch of the [Call phone number](#) block to the next block in the flow.

There is no error branch for the block. If a call is not successfully initiated, the flow ends and the agent is placed in an **AfterContactWork** (ACW) state.

CNAM

As part of changes within the US Public Telephone network and a move to alternative reputation mechanisms described in [Optimize your reputation for outbound calling](#), as of March 31, 2023, Amazon Connect no longer sets CNAM configurations.

We conducted research between January and March 2023, that showed CNAM was seen by fewer than 7% of users. This is due to changes within support for mobile providers and due to the migration to app-based reputation mechanisms.

All existing CNAM configurations set up before March 2023, are still in place. We will continue to focus on supporting modern replacement mechanisms added to our marketplace, for example, [First Orion](#) and Neustar.

How to avoid labels like "spam" and "telemarketer"

See the recommended steps in [Optimize your reputation for outbound calling](#).

Set up US emergency calling in Amazon Connect

By default 911 is enabled for all users in the following North America Regions: US East (N. Virginia), US West (Oregon), and AWS GovCloud (US-West). If an agent calls 911, the call is routed through to emergency services.

Amazon Connect only supports direct calls from the agent CCP to 911. It does not support call transfers to 911, or dialing 911 while on a call.

What is Enhanced 911 (E911)? E911 enables location information to be sent to 911 dispatch when a 911 call is placed.

There are two steps to set up E911:

- [Get and store an agent's validated physical address](#)
- [Retrieve an agent's address when they call 911](#)

Place 911 calls from your Test Environment

⚠ Important

Calling 911 for a non-emergency situation carries a penalty of \$100 per occurrence. To help you avoid penalties, we have set up 933 so you can test this capability. Calls placed from an Amazon Connect Contact Control Panel (CCP) to 933 have an audio playback message confirming:

- The number the call originated from.
- The physical address that was sent along with the call.

For more information about calling 911, see this [FAQ](#) about the national 911 program.

Get and store an agent's validated physical address

The first step in setting up E911 for your Amazon Connect instance is to get and store the agent's validated physical address. The following illustration shows the process for storing addresses.

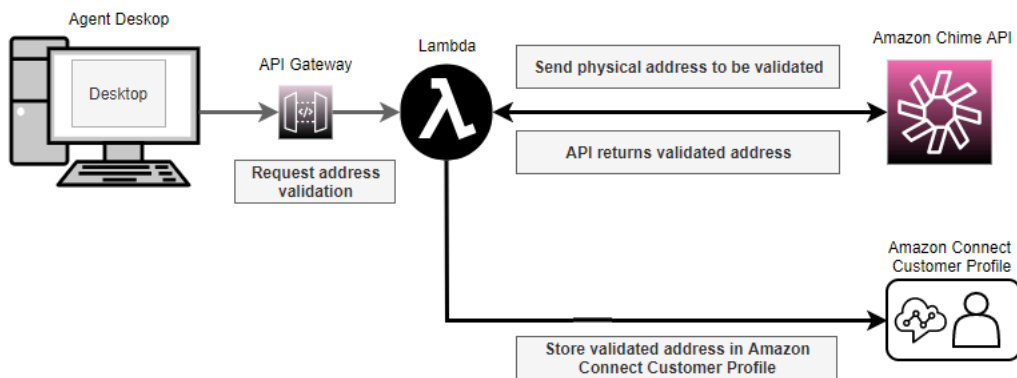

1. Since agents may be working from different locations (for example, office building, home, or coffee shop), it's critical that the most recently validated address is passed along with the emergency outbound call.
 - a. Store a validated address when you first set up an agent on Amazon Connect, based on the agent's usual location.
 - b. Prompt the agent to update their address at the start of their shift to help ensure that the emergency outbound call has their latest address.
 - c. Check addresses against a database of valid street addresses (Master Street Address Guide).

2. Use the Amazon Chime API [ValidateE911Address](#). This API validates and returns the validated physical address.
3. Use the [CreateProfile](#) or [UpdateProfile](#) APIs to store the validated address in Amazon Connect Customer Profiles.

Note

We recommend using `CreateProfile` when it is required to add a validated address the first time. After that, use `UpdateProfile`.

Retrieve an agent's address when they call 911

To retrieve an agent's validated address from the Amazon Connect, create an outbound whisper flow that calls a Lambda function. Code the Lambda function to retrieve the address from the agent's customer profile, as shown in the following illustration:

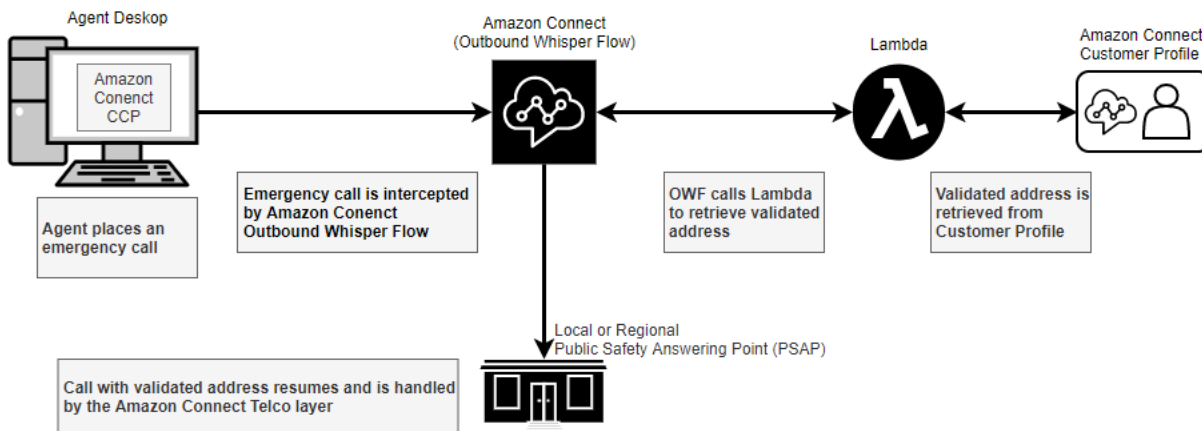

1. Create an AWS Lambda function that uses the [SearchProfiles](#) API to retrieve the physical address for a given agent from Customer Profiles.
2. [Create an outbound whisper flow that relays this physical address as part of the emergency out dial.](#)
3. [Add a task that sends notifications when an E911 call is placed.](#)

Create an outbound whisper flow that relays the physical address

For outbound voice calls within Amazon Connect, an [outbound whisper flow](#) usually specifies the whisper to be played to customer. However, in this case you need to configure an [outbound whisper flow](#) to do the following:

1. Inspect the outbound call string from an agent.
2. If the string equals **911** (or **933** in a test environment), then retrieve the agent's stored location/physical address from Customer Profiles by using a Lambda function to call the [SearchProfiles](#) API .
3. Attach the physical address to a contact attribute and proceed with the 911 (or 933) outbound call.

The following illustration shows an example [outbound whisper flow](#). It is configured to inspect the outbound call string from an agent, and retrieve the stored physical address for that agent by using a Lambda function. It includes the following blocks in sequence: [Invoke AWS Lambda function](#), [Set contact attributes](#), and [Call phone number](#).

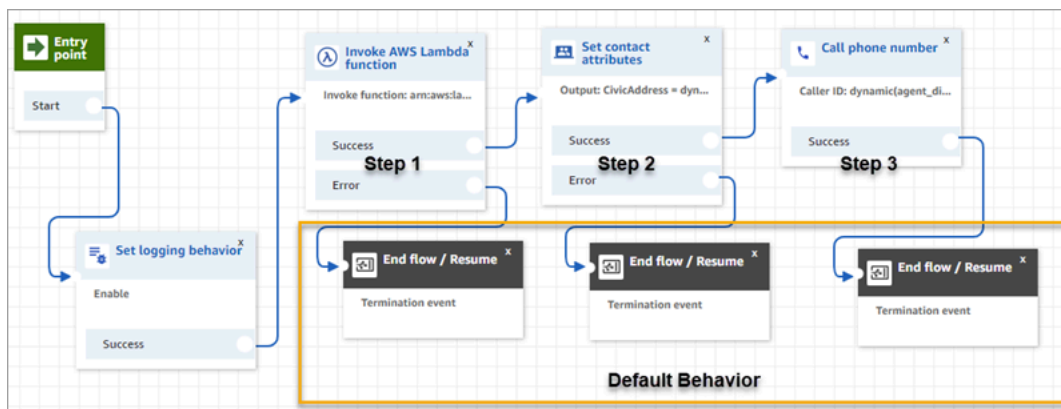

- Step 1: Call a Lambda function that retrieves the location for an agent (Input parameter = Agent User Name). The following image shows how to configure an [Invoke AWS Lambda function](#) block is so the agent **username** is passed to the Lambda function.

- Step 2: Attach the location received to a contact attribute (see [Format a physical address for E911](#) for the required format).
- Step 3: Update the call origination to the agent's phone number and continue with the outbound call.

Note

The origination number is the caller ID that is passed along with the 911 outbound call. If the origination phone number supports inbound calls, emergency responders will be able to call back the agent in case the initial phone call was disconnected.

- The 911 call is specific to United States. As a result, the origination phone number must be a valid US phone number.

For example, when an agent places an outbound call, if an invalid US phone number is passed to the carrier network, the carrier can reject the call. To avoid this situation, if the agent uses an invalid number from Amazon Connect, Amazon Connect defaults to the Caller ID that is assigned to the queue in the agent's routing profile.

- The capability does not place any other rules on this number. For example, the origination number can be the phone number of the security front desk.

Add a task that sends notifications when an E911 call is placed

When an agent calls 911 it is important to notify in real time the appropriate people in your organization, such as corporate security or a human resources administrator, that someone from the contact center has placed an E911 call. To do this, create an Amazon Connect task in the [outbound whisper flow](#). Then add custom notification logic to the task.

The following image shows an example of a [Create task](#) block in an [outbound whisper flow](#). It is located after the **Set contact attributes** block and before the **Call phone number** block.

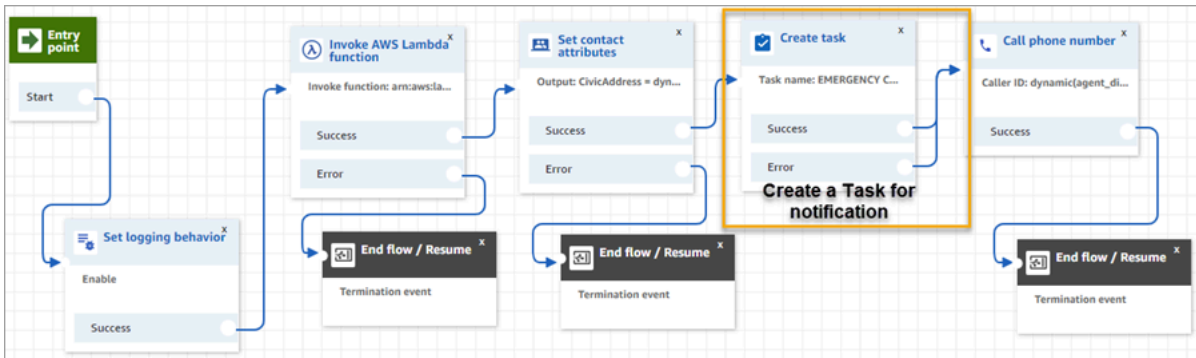

The following image shows the **Properties** page for a [Create task](#) block. It is configured to notify corporate security that an agent from the contact center has placed an E911 call.

Create task
✕

Creates a new task to run an assigned flow. [Learn more](#)

Flow
Select a flow to run this task

Set manually
05252022-SuperEscalat... x ▾

Use attribute

Name

Set manually
EMERGENCY CALL PLACED

Use attribute

Set description
 Set manually
\$Agent.UserName placed an emergency call.

Use attribute

Set references

Format a physical address for E911

This topic explains how to format a physical address so it can be passed to Amazon Connect.

E911 outbound calls require a physical address to be passed to Amazon Connect as a JSON string with keys and values that represent the various fields in the address. For example, consider the following US address:

- 2121 7th Ave, Seattle, WA, 98121, USA

The address must be attached as a JSON string against the key `CivicAddress`, as shown in the following example. Every address field is attached to a specific coded key.

`CivicAddress`:

```
{ "country": "USA", "RD": "7th", "A3": "Seattle", "PC": "98121", "HNO": "2121", "STS": "Ave"
```

The following illustration shows how an example input address maps to [PSAP](#) address keys:

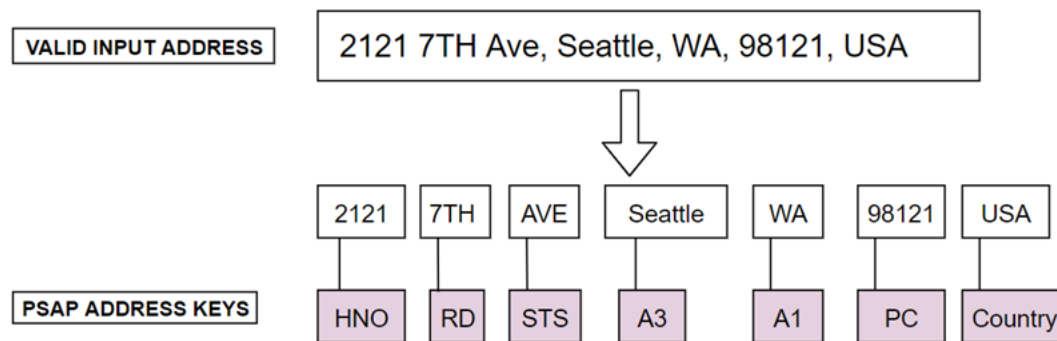

The following table shows a complete list of keys.

Attribute name	Description	Example	Required	Character limit	Recommended character limit
country	The country is identified by the two-letter ISO 3166 code.	US	Required	2	
A1	National subdivisions (state, region,	NY	Required	2	

Attribute name	Description	Example	Required	Character limit	Recommended character limit
	province, prefecture)				
A3	City, township, shi (JP)	New York	Required	32	
PRD	Leading street direction	N, W	Required only if applicable to address	2	
POD	Trailing street suffix	SW	Required only if applicable to address	2	
STS	Street suffix	Avenue, Platz	Required only if applicable to address	5	
HNO	House number (numeric part only)	2121	Required	10	
HNS	House number suffix	A, 1/2	Required only if applicable to address	4	
LOC	Additional location information	Room 543	Optional	60	20 or less

Attribute name	Description	Example	Required	Character limit	Recommended character limit
NAM	Name (residence, business or office occupant)	Example Corp	Optional	32	
PC	Postal code	10027	Required	5	
RD	Primary road or street	Broadway	Required	40	

Note

It is your responsibility to validate the address against a standard repository such as the Master Street Address Guide (MSAG).

Programming notes

Currently it isn't possible to pass a JSON structure as an `Attribute` to Amazon Connect. Therefore, the location retrieved by the Lambda function needs to be converted to a JSON string before it is passed to Amazon Connect. For example, using the Python programming language, if the location retrieved is stored in a JSON structure `json_agent_location` then it can be passed to Amazon Connect (from the Lambda function) as follows:

```
return { , 'CivicAddress': json.dumps(json_agent_location)
, 'agent_did_number': '+1555551212' }
```

For an address such as the following example:

- 2121 7th Ave, Seattle, WA, 98121, USA

The key-value pair:

```
CivicAddress: {"country": "USA", "RD": "7th", "A3": "Seattle", "PC": "98121", "HNO": "2121", "STS": "Ave", "A1": "WA"}
```

And the corresponding JSON string that is actually passed to Amazon Connect:

```
CivicAddress: {"country": "USA", "RD": "7th", "A3": "Seattle", "PC": "98121", "HNO": "2121", "STS": "Ave", "A1": "WA"}
```

Note

Using `json.dumps` adds an escape character `\` to each quotation mark (`"`).

Enable outbound calls

Before your agents can make outbound calls to customers, you need to set up your Amazon Connect instance for outbound communications.

1. Open the Amazon Connect console at <https://console.aws.amazon.com/connect/>.
2. On the instances page, choose the instance alias. The instance alias is also your **instance name**, which appears in your Amazon Connect URL. The following image shows the **Amazon Connect virtual contact center instances** page, with a box around the instance alias.

Instance alias	Access URL	Channels	Create date	Status
mytest67	https://mytest67.my.connect.aws	Inbound, outbound telephony	1/12/2022	Active

3. In the navigation pane, choose **Telephony under Channels and communications**.
4. To enable outbound calling from your contact center, choose **Make outbound calls with Amazon Connect**.
5. To enable outbound campaigns, choose **Enable outbound campaigns**.

6. By enabling early media audio, your agents can hear pre-connection audio such as busy signals, failure-to-connect errors, or other informational messages from telephony providers, when making outbound calls. Choose **Enable early media**.
7. Choose **Save**.
8. Ensure agents have the **Contact Control Panel (CCP) - Make outbound calls** permission in their security profile. For instructions, see [Assign a security profile to a user](#).

Note

For a list of countries you can call **by default** based on the Region of your instance, see [Countries you can call by default](#).

For a list of all countries available for outbound calls based on the Region of your instance, see [Amazon Connect pricing](#). If a country is not available in your dropdown menu, open a ticket to add it to your allowlist.

Outbound calling restrictions

This topic explains restrictions that are in place for outbound calling with Amazon Connect.

Contents

- [Use of toll-free numbers outside the country of origin](#)
- [Use of UIFN numbers for outbound dialing](#)
- [Redirection of calls](#)
- [International calling restrictions](#)

Use of toll-free numbers outside the country of origin

Amazon Connect does not support the use of toll-free numbers for international calling. International calls from toll-free numbers can be flagged as spam by downstream providers, resulting in negative reputation scores. They can also generate unexpected fees for call recipients.

Use of UIFN numbers for outbound dialing

UIFN numbers are designed to be used for inbound calls only. They cannot be used for outbound calling. If you attempt to use UIFN for outbound calling, the calls will be blocked.

Redirection of calls

If you are using Amazon Connect to redirect calls: If you are receiving calls with Anonymous (withheld CLI), you must use an Amazon Connect number for the transfer. See [Set up outbound caller ID](#).

International calling restrictions

Amazon Connect has several restrictions on international calling. These are based on requirements in the following specific jurisdictions.

South Africa

South African mobile numbers available under the DID option are designed to be national-only services and are not supported for international calling.

Taiwan

Taiwan DID's are set up to be in-country only services and are not internationally reachable.

China

Chinese carriers are increasingly blocking international routes into China unilaterally. Amazon Connect has taken steps to continue to support our existing customers but require that all customers comply with additional requirements for continued use. Starting October 14, 2023 all customers approved to call China are required to follow these conditions.

Eligibility criteria

- **Unsupported use cases**
 - Short calls and alerting (less than 15 seconds).
 - High volume of calls, especially when done over a short period of time, using the same outbound caller ID (more than 5 calls per minute).
 - Any form of cold calling.
 - Any calls to invalid phone numbers. All numbers called must be validated as accurate.
 - Repeated calls using the same FROM / TO numbers.
 - Attempts to call China FROM any number that has not been pre-approved.
- **Supported use cases**

- Direct calls to known business entities. For example, calling a hotel or IT support function.
- Calling users who attempted to engage with your business. For example, university placement schemes or product purchases.

Data required for setup

To request the ability to call Chinese telephone numbers (+86), perform the following steps:

- You must provide an exact list of telephony numbers you will use to phone China.
 - The number must be a DID provided by Amazon Connect. No other number is acceptable.
 - The number cannot be a DID provided by Hong Kong, Macau, Taiwan, China, or Singapore.

Note

The above list may change at any time.

- Any number used to call Chinese telephone numbers must be able to be called back. You must also implement a call back message that clearly states the name of the company that is associated with the phone number.
- You must provide a detailed description of your use case, and confirm that you meet the [eligibility criteria](#) described in this topic.

Consequences for violating the calling criteria for China

Amazon Connect has a zero tolerance policy for calling into China. Amazon will suspend your use of Amazon Connect if you use the service for any of the restricted use cases identified in this topic. It is essential that the administrators of your Amazon Connect service focus on ensuring the members of your organization are aware of these restrictions, as ignorance of the rules is not an acceptable reason for breach.

Service assurance

In the event of further incidents where Chinese carriers block major international routes without prior warning and impact the ability to call China, the exemptions in the [Amazon Connect Service Level Agreement](#) will take effect.

Optimize your reputation for outbound calling

In the contact center industry one of the most difficult tasks is understanding why customers don't answer calls when you dial out. Is the customer deliberately not answering, or are they busy on a work call or answering the door? For contact centers it's impossible to know but there are things you can do about it.

This topic provides recommended steps you can take to improve your call answer rates for outbound calling.

Step 1: Know your customer's preferred contact method

One of the biggest mistakes that contact centers make is not knowing whether the customer wants to be contacted by telephone call. When the customer engaged with you, did you check whether they want to be reached by phone, e-mail, or text?

Businesses with multi-channel engagement outperform 70% on average compared to business without multi-channel engagement.

Step 2: Brand your calls

By using call branding solutions, you can provide enhanced call displays that include your business name, logos, reason for the call, and your service. Branding your calls increases the call answer rate by 30%.

Amazon Connect partners with solutions providers like [First Orion](#) and Neustar to offer branded calling services.

Step 3: Select caller IDs that mean something to your customer

Not every contact center is the same. What works for some might not work for others. But there are correlations in how successful outbound campaigns are based on your caller ID. Following are a few suggestions to try creating meaningful caller IDs:

- **Area localization.** Use a caller ID in the same area as the prospect.
- **City localization.** Use a caller ID in the same city as the prospect.
- **Recognizable golden toll free number** such as 0800 123 0000.
- **Mobile numbers.** Where countries permit this, it may be possible to use a virtual mobile number to dial out from a contact center. For a list of countries where Amazon Connect supports mobile numbers, see [Region requirements for ordering and porting phone numbers](#).

Step 4: Make sure your campaign is calling valid numbers

Many businesses don't have a process to ensure that customer details are up to date. With people being more mobile than ever, it's essential for businesses to keep updated contact information. If customers are not answering your calls, we recommend using Amazon Pinpoint to [validate your phone numbers](#). It may be the customer is no longer at the phone number you are calling.

Step 5: Make outbound calls at optimal times

Another strategy for outbound call campaigns is making sure that calls are placed at the best times. It is critical to never harass your customers or prospects—no one wants to be contacted multiple times by the same company. Generally speaking, it is never a good idea to call before 10:00AM or after 5:00PM as people are at their busiest or need their quiet time. Customers should be called when it's a good for them, depending on their profile. This may mean that one customer should be called around noon, while another is more accessible in the afternoon.

In addition, there are regulations such as TCPA (in the US) and OFCOM (in the UK) that provide guidance on when not to call end customers. We strongly recommend that you abide by such regulations.

Step 6: Monitor the reputation of your caller IDs

We recommend monitoring the reputation of your caller ID through a service like [Free Caller Registry](#).

Even with the most legitimate outbound call campaigns, if you make enough calls, there will be people who will flag your caller ID as spam. This can manifest in two ways:

1. **Automatic blocking.** Block lists are implemented on a vendor-by-vendor basis. For example, when a certain threshold of reports is reached with application providers such as [Hiya.com](#) on Samsung devices, up to 20% of your prospects will become instantly unreachable.
2. **Complaints.** There are numerous websites where people complain about calls from specific caller IDs. A number of your prospects will search your caller ID online when you call them. If it has a bad reputation, they will be less likely to answer.

The fastest way to recover from a flagged caller ID is to switch to a new phone number. See the next step.

Step 7: Use multiple numbers as a callerID

Today, outbound contact centers typically embrace an intelligent, more efficient manner of dialing.

For example, one method is to use multiple phone numbers when placing outbound calls. Customers are more likely to answer a call if they feel that they are not being called repeatedly by the same number. In fact, using the same phone number repeatedly is a sure way to annoy customers and prospects who may feel they are being contacted too often.

Step 8: Engage with App Vendors

One of the most difficult issues with the industry as it currently stands is that a large number of vendors provide in-app services to block calls. If one of these in-app services marks your number as spam then you have to pay the premium fees to remove your number from their spam list.

Some of the third party vendors are joining in partnership to increase the call answer rate.

Step 9: Add messaging to your outreach strategy to let customers know who you are

It's inevitable that you'll end up with a list of unanswered calls that you weren't able to connect. There are a variety of creative ways to use SMS with prospects. Here are some ideas to increase answer rates with your prospects.

1. Send an SMS before calling, letting them know who you are and when you will be calling, optionally allowing them to reschedule to a more convenient time.
2. If the prospect doesn't answer, send an SMS to allow them to reschedule the call or request a call back.
3. Re-engage with prospects with promotional offers or discounts that resonates with your prospects.

Step 10: Validate your outbound calling strategy

By making data-driven decisions and continuously iterating, you'll have the best chance to deliver real business value. You should treat each change that you make to your outbound calling strategy as an experiment, and ensure you have the ability to measure and compare the effectiveness of the changes you are making.

One of the best things with Amazon Connect is the service is readily available to experiment. You can establish a baseline and then compare any changes to help you to assess how you can succeed.

Set up Amazon Connect outbound campaigns

This topic explains how to set up Amazon Connect outbound campaigns, a feature of Amazon Connect and formerly known as high-volume outbound communications.

Important

The phone numbers that outbound campaigns can call are based on the AWS Region where your Amazon Connect instance is created. For a list of AWS Regions and countries, see [Outbound campaigns](#) in the *Availability of Amazon Connect services by Region* topic.

Before you begin

You need a few things in order to use outbound campaigns:

- Make sure your Amazon Connect instance is [enabled for outbound calling](#).
- Create a dedicated outbound campaigns queue to handle any contacts that will be routed to agents as a result of the campaign.
- Assign the queue to the agent's routing profile.
- Create and publish a flow that includes a [Check call progress](#) block. This block enables you to branch based on whether a person or a machine answered a call, for example.

Create a AWS KMS key

When you enable outbound campaigns, you can provide your own [AWS KMS key](#). You create and manage these keys, and AWS KMS charges apply. You can also use an AWS owned key.

When using an API to enable or disable outbound campaigns, make sure the API user is either the administrator or has the following permissions: `kms:DescribeKey`, `kms:CreateGrant`, and `kms:RetireGrant` for the key.

Note

To switch the KMS key that is associated with outbound campaigns, first you need to disable outbound campaigns, and then re-enable it using a different AWS KMS key.

Configure outbound campaigns

1. Open the Amazon Connect console at <https://console.aws.amazon.com/connect/>.
2. On the instances page, choose the instance alias. The instance alias is also your **instance name**, which appears in your Amazon Connect URL. The following image shows the **Amazon Connect virtual contact center instances** page, with a box around the instance alias.

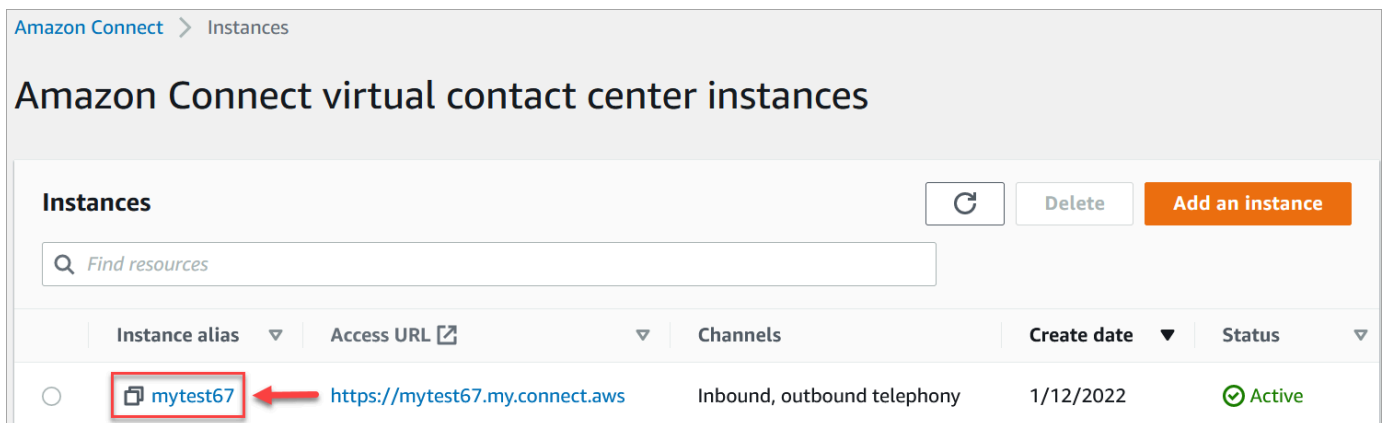

3. In the navigation pane, choose **Telephony**.
4. To enable outbound campaigns, choose **Enable outbound campaigns**. If you don't see this option, then check whether [outbound campaigns is available in your AWS Region](#).
5. Under **Encryption settings**, enter your own AWS KMS key or choose **Create an AWS KMS key**.

If you choose **Create an AWS KMS key**:

- A new tab in your browser opens for the Key Management Service (KMS) console. On the **Configure key** page, choose **Symmetric**, and then choose **Next**, as shown in the following image.

KMS > Customer managed keys > Create key

Step 1
Configure key

Step 2
Add labels

Step 3
Define key administrative permissions

Step 4
Define key usage permissions

Step 5
Review and edit key policy

Configure key

Key type [Help me choose](#)

Symmetric
A single encryption key that is used for both encrypt and decrypt operations

Asymmetric
A public and private key pair that can be used for encrypt/decrypt or sign/verify operations

▶ **Advanced options**

Cancel **Next**

- On the **Add labels** page, add a name and description for the key, and then choose **Next**.
- On the **Define key administrative permissions** page, choose **Next**.
- On the **Define key usage permissions** page, choose **Next**.
- On the **Review and edit key policy** page, choose **Finish**.

In the following example, the name of the key starts with **bc6fdd**:

KMS > Customer managed keys

Customer managed keys (1)

Q Filter keys by properties or tags

<input type="checkbox"/>	Aliases	Key ID	Status	Key type	Key spec	Key usage
<input type="checkbox"/>	AmazonQinConnect	9059f488-...	Enabled	Symmetric	SYMMETRIC_DEFAULT	Encrypt and decrypt

- Return to the tab in your browser for the Amazon Connect console, **Telephony** page. Click or tap in the **AWS KMS key** for the key you created to appear in a dropdown list. Choose the key you created.
6. Choose **Save**.
 7. It takes a few minutes for outbound campaigns to be enabled. When it's successfully enabled, you can create outbound campaigns in Amazon Connect for voice calls. If it does not enable, verify you have the required [IAM permissions](#).

Create an outbound campaign

Contact centers send outbound campaigns to customers for a variety of reasons, such as appointment reminders, telemarketing, subscription renewals, and debt collection. By using Amazon Pinpoint Journeys and Amazon Connect, you can create outbound campaigns for voice, SMS, and email.

There are two ways you can create an outbound campaign:

- Use Amazon Connect console and Amazon Pinpoint. This topic provides instructions.
- Use the Amazon Connect Outbound Campaigns API. For more information, see [Best practices for using PutDialRequestBatch for outbound campaign calling](#) in the *Amazon Connect Outbound Campaigns API Reference*.

Note

- You can't update the name of the outbound queue by using the API.
- When you create a campaign by using the API: For users to be able to view or edit a campaign at a later date by using the Amazon Connect user interface, you must add the instance ID as a tag.

How to create an outbound campaign

1. Log in to the Amazon Connect admin website at https://instance_name.my.connect.aws/.
2. On the left navigation menu, choose **Outbound campaigns**, and then choose **Create campaign**.
3. In the **Campaign details** section, specify the name, as shown in the following image.

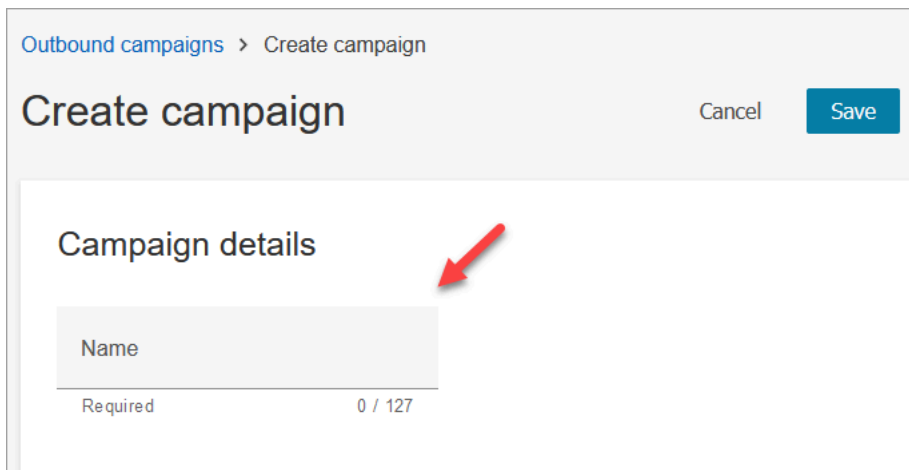

Outbound campaigns > Create campaign

Create campaign

Cancel Save

Campaign details

Name

Required 0 / 127

4. In the **Outbound configuration** section, select the published flow you created for outbound campaigns (a flow that includes a [Check call progress](#) block), as shown in the following image.

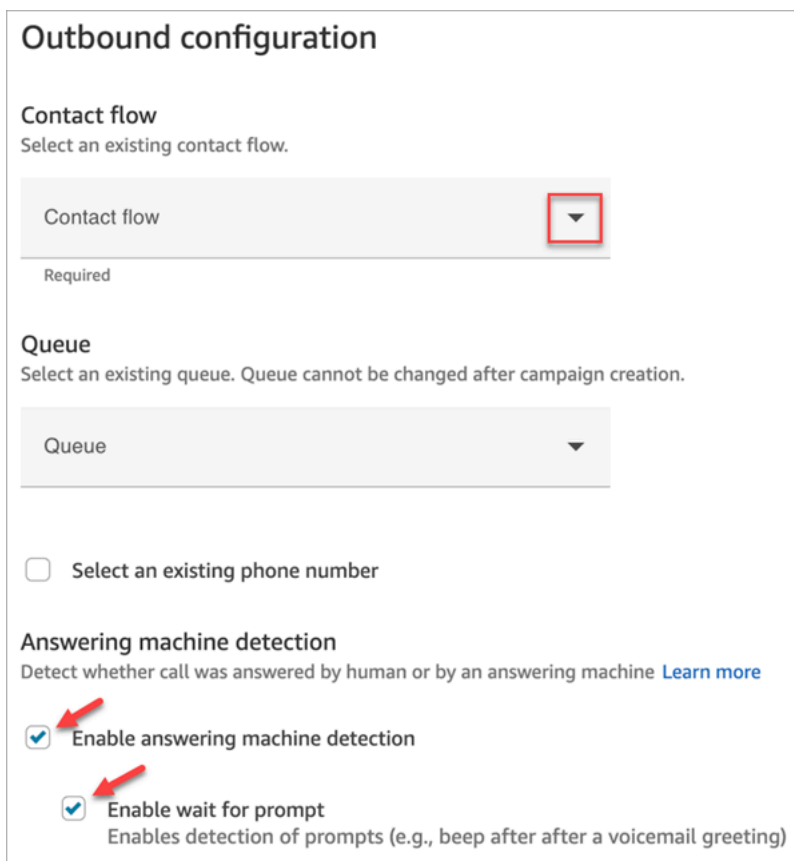

Outbound configuration

Contact flow

Select an existing contact flow.

Contact flow

Required

Queue

Select an existing queue. Queue cannot be changed after campaign creation.

Queue

Select an existing phone number

Answering machine detection

Detect whether call was answered by human or by an answering machine [Learn more](#)

Enable answering machine detection

Enable wait for prompt
Enables detection of prompts (e.g., beep after after a voicemail greeting)

5. If you plan on using Predictive or Progressive dialer types, specify a queue to associate with this campaign. A queue is required only for Predictive and Progressive dialer types.
6. Answering machine detection is enabled by default. If desired, you can choose to disable it.

Note

To reduce call connection latency between your customers and available agents we recommend disabling the use of answering machine detection.

If you disable answering machine detection, and if your flow includes the [Check call progress](#) block, the contact is routed down the Error branch.

If answering machine detection is enabled then this metric counts the number of calls answered by a human. If answering machine detection is disabled then this metric will include both calls answered by a human and calls answered by a machine. This is technically less accurate given that we can no longer differentiate whether a human or machine answered the call. For more information, see [Activity-Level Engagement Metrics](#) in the Amazon Pinpoint documentation.

Ensure **Enable wait for prompt** is selected. If it is not selected, the ML-powered call classifier won't listen for a voicemail prompt, and instead the next block in the flow will be triggered immediately.

7. Choose a phone number to be shown as caller ID when making outbound calls. The outbound phone number is specified for a queue.

Important

- You must use a phone number that has been ported to your Amazon Connect instance, or claimed from Amazon Connect.
- Telecom regulations in certain countries dictate use of phone numbers from specific carriers for outbound calling. For more information, see the [Amazon Connect Telecoms Country Coverage Guide](#) to learn more.

8. In the **Dialer type** section, choose a dialer type.

Dialer configuration

Dialer type
Select a dialer type. [Learn more](#)

Predictive
In this mode, pacing of calls is based on predicted agent availability and near-real time statistics. Use this mode for campaigns where maximizing agent talk time is the most important metric.

Progressive
In this mode, the dialer doesn't dial until the agent becomes available. Use this mode when reaching customers is more important than optimizing agent talk time.

Agentless
In this mode, the dialer has no need for agent availability to place calls. Use this mode for voice notifications.

Agent bandwidth allocation
This is a percentage of agents available in the queue that will be considered for a particular campaign at the time of dialing. [Learn more](#)

1-100%
55
Required

Dialing capacity
Allocates dialing capacity for this campaign between multiple active campaigns. [Learn more](#)

1-100%
100

9. If you're using a Predictive or Progressive dialer type, choose the **Agent bandwidth allocation**. This setting applies to Predictive and Progressive dialer types only. It doesn't apply to **Agentless** mode.
10. Choose **Dialing capacity**.
11. Open the Amazon Pinpoint console (<https://console.aws.amazon.com/pinpoint/>) and [Create a journey](#), using the name of the campaign that you created in Amazon Connect.
12. Associate this campaign to a customer journey on Amazon Pinpoint to start making high-volume outbound calls.

Campaign state

After a campaign is running, you can pause or stop it. You can also delete a campaign at any time.

Following is a description of each campaign state:

- **Created** – The campaign is created.
- **Running** – The campaign is running.
- **Paused** – The campaign is paused until it is resumed.
- **Stopped** – The campaign is stopped. You can't resume a campaign that is stopped.
- **Failed** – An error state caused the campaign to fail.

Disable outbound campaigns

Important

You must delete all existing campaigns before you can disable outbound campaigns.

1. Open the Amazon Connect console at <https://console.aws.amazon.com/connect/>.
2. On the instances page, choose the instance alias. The instance alias is also your **instance name**, which appears in your Amazon Connect URL. The following image shows the **Amazon Connect virtual contact center instances** page, with a box around the instance alias.

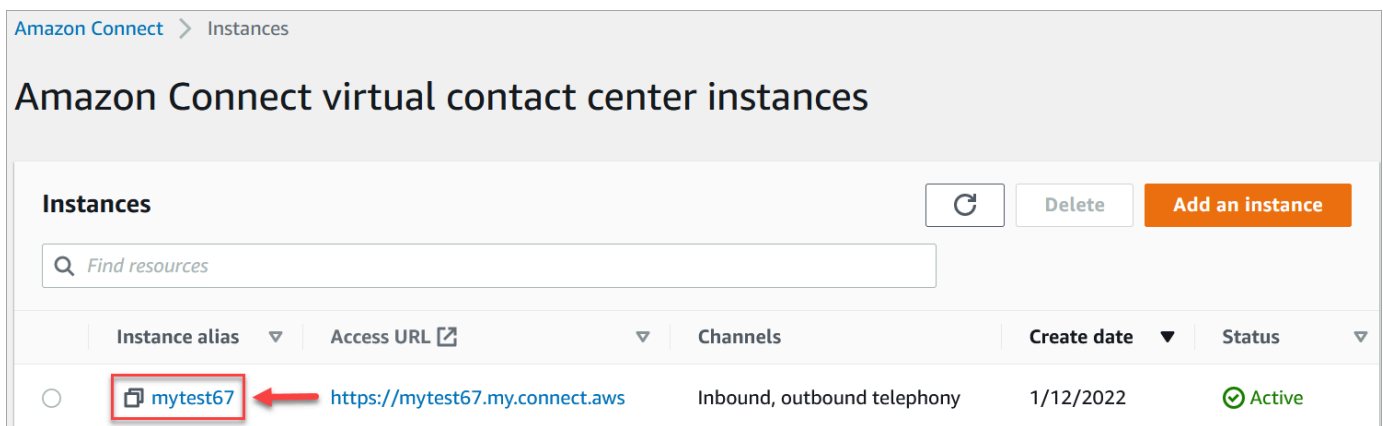

3. In the navigation pane, choose **Telephony under Channels and communications**.
4. To disable outbound campaigns, clear the **Enable outbound campaigns** checkbox.
5. Choose **Save**.

You can no longer create outbound campaigns.

Security profile permissions for outbound communications

To enable agents to make outbound calls, assign **Make outbound calls** permissions to the agent's security profile as shown in the following image:

Contact Control Panel (CCP) ⓘ	
Type	Access
Access Contact Control Panel	<input type="checkbox"/>
Make outbound calls	<input type="checkbox"/>

To enable call center managers to create outbound campaigns, assign the following permissions to their security profile:

- **Routing, Queues, View** permission
- **Outbound campaigns, Campaigns, View** permission
- **Channels and Flows, Flows, View** permission

For information about how to add more permissions to an existing security profile, see [Update security profiles](#).

By default, the **Admin** security profile already has permissions to perform all activities.

Best practices for outbound campaigns

The topics in this section explain best practices for outbound calling campaigns. These practices can increase agent productivity, help you comply with regulations, and help protect the integrity of your phone numbers.

ⓘ Note

Amazon Connect outbound campaigns work in concert with Amazon Pinpoint journeys. Journeys have their own best practices. The topics in this section describe some of those practices, but for more information, see [Tips and best practices for journeys](#), in the *Amazon Pinpoint User Guide*.

Contents

- [Choose the right campaign](#)
- [Agent staffing best practices](#)

- [Connection latency best practices](#)
- [Best practices for answering machine detection](#)
- [Journey best practices](#)
- [Schedule best practices](#)
- [Best practices for activity settings](#)
- [Do Not Call best practices](#)
- [Best practices for managing redials](#)

Choose the right campaign

Amazon Connect provides several types of dialing campaigns. The following sections describe each type so that you can implement the campaign that best meets your needs.

Contents

- [Predictive campaigns](#)
- [Progressive campaigns](#)
- [Agentless campaigns](#)

Predictive campaigns

When agent productivity, cost per calls, or contact center efficiency are critical metrics, use predictive dialers. Predictive dialers anticipate that many calls won't be answered. They counterbalance that by dialing as many phone numbers in a list as possible during an agent's shift by making predictions about agent availability.

The predictive algorithm calls ahead based on certain performance metrics. This means that calls can be connected before an agent becomes available, and a customer is connected to the next available agent. The predictive algorithm constantly analyzes, evaluates, and makes agent availability predictions in real-time so that agent productivity and efficiency can improve.

Progressive campaigns

When you need to reduce answer speeds, use progressive dialers. A progressive dialer dials the next phone number in a list after an agent completes the previous call. The dialer only makes as many outbound calls as there are agents available.

You can use integrated answering machine detection to help identify a live customer pickup or a voicemail, and customize your contact strategy accordingly. For example, if a person answers a call, you can present options for them to select. If a call goes to voicemail, you can leave a message.

You can also manage pacing by specifying dial capacity for each campaign. For example, you can send more voice notifications faster by setting a higher dial capacity for a given agentless campaign compared to other dialer campaigns.

Agentless campaigns

You use agentless campaigns to send high-volume personalized voice notifications, appointment reminders, or to enable self-service using the Interactive Voice Response (IVR) with no agents needed.

Agent staffing best practices

When call recipients answer a call and hear silence in return, they often hang up. For predictive campaigns, use the following best practices to help reduce that silence:

- Ensure that you have enough agents logged in to your call queue. For more information about staffing, see [Forecasting, capacity planning, and scheduling](#).
- Consider using Amazon Connect's machine learning services.
 - [Forecasting](#). Analyze and predict contact volume based on historical data. What will future demand—the contact volume and handle time—look like? Amazon Connect forecasting provides accurate and auto-generated forecasts that are automatically updated daily.
 - [Capacity planning](#). Predict how many agents your contact center will require. Optimize plans by scenarios, service level goals, and metrics, such as shrinkage.
 - [Scheduling](#). Generate agent schedules for day-to-day workloads that are flexible, and meet business and compliance requirements. Offer agents flexible schedules and work-life balance. How many agents are needed in each shift? Which agent works in which slot?

[Schedule adherence](#). Enable contact center supervisors to monitor schedule adherence and improve agent productivity. Schedule adherence metrics are available after the agent schedules are published.

Connection latency best practices

Successful outbound calling campaigns avoid silent calls, the period of silence after a person answers a call and before an agent comes on the line. Legal requirements to limit the number of silent or abandoned calls and keep the called party informed may also apply. You can configure Amazon Connect in different ways to reduce call connection delays.

Topics

- [Pinpoint segment attributes](#)
- [Outbound agent-staffed calling](#)
- [Outbound agentless calling](#)
- [Whisper and queue flow best practices](#)
- [User administration best practices](#)
- [Workstation and network best practices](#)
- [Testing best practices](#)

Pinpoint segment attributes

When creating an Amazon Pinpoint segment file, add the data (attributes) required for routing logic, custom greetings, or agent screen pop. Do not use Lambda functions in the flow to extract additional information, such as `EffectiveDate`, `Attributes.CampaignIdentifier`, or `User.UserId` prior to connecting to an agent.

H	I	J
EffectiveDate	Attributes.CampaignIdentifier	User.UserId
2021-06-29T09:31:49.764Z	PlatinumCreditCards	example-user-id-62
2021-06-29T09:31:49.764Z	PlatinumCreditCards	example-user-id-63

For more information, see [Supported attributes](#) in the *Amazon Pinpoint User Guide*.

Outbound agent-staffed calling

When using the [Check call progress](#) flow block:

- Call Answered branch - Remove all flow blocks between the [Check call progress](#) and [Transfer to queue](#) blocks. This minimizes delay between the dialed party saying hello, and the agent answer time.

- **Not Detected branch** - This branch should be treated in the same manner as a **Call Answered** with routing to a [Transfer to queue](#) block. This branch is used when the ML-model was not able to classify the answer type. Since this could be a voicemail or a live person, you can play a message before to the **Transfer to queue** block in the event that there is a voicemail answering a message can be left.

For example, "This is Example Corp. calling to confirm your appointment. We couldn't tell if you or your voicemail answered this call. Please stay on the line while we connect you with an agent."

Outbound agentless calling

Outbound campaigns often use custom greetings and self service functions. Do not use Lambda functions to get contact attributes. Instead, provide customer data (attributes) via the campaign segment. Use these attributes from the campaign segment to play custom greetings.

- **Example - Call Answered or Not Detected:** "Hello, \$.Attributes.FirstName. This is \$.Attributes CallerIdentity calling to confirm your upcoming appointment on \$.Attributes.AppointmentDate at \$.Attributes.AppointmentTime. If this is still a good time and date for you, just say, "Confirm". If you would like to use our self service system to modify your appointment, just say, "self service" or stay on the line and we will connect you with the next available agent."
- **Example - Voicemail with or without beep:** "Hello, \$.Attributes.FirstName. This is \$.Attributes CallerIdentity calling to confirm your upcoming appointment on \$.Attributes.AppointmentDate at \$.Attributes.AppointmentTime. If this is still a good time and date for you, we will see you then. If you would like to modify your appointment, please call us back at \$.SystemEndpoint.Address to reschedule your appointment"
- **Error branch** - Occasionally there could be an issue that causes a call to follow the Error branch. As a best practice, use a [Play prompt](#) block with a message that applies to the contact that was dialed, with instruction to "Please call us at \$.SystemEndpoint.Address to confirm or reschedule your appointment." Do this before the [Disconnect / hang up](#) block in case the call recipient answered, but an error occurred in the processing.

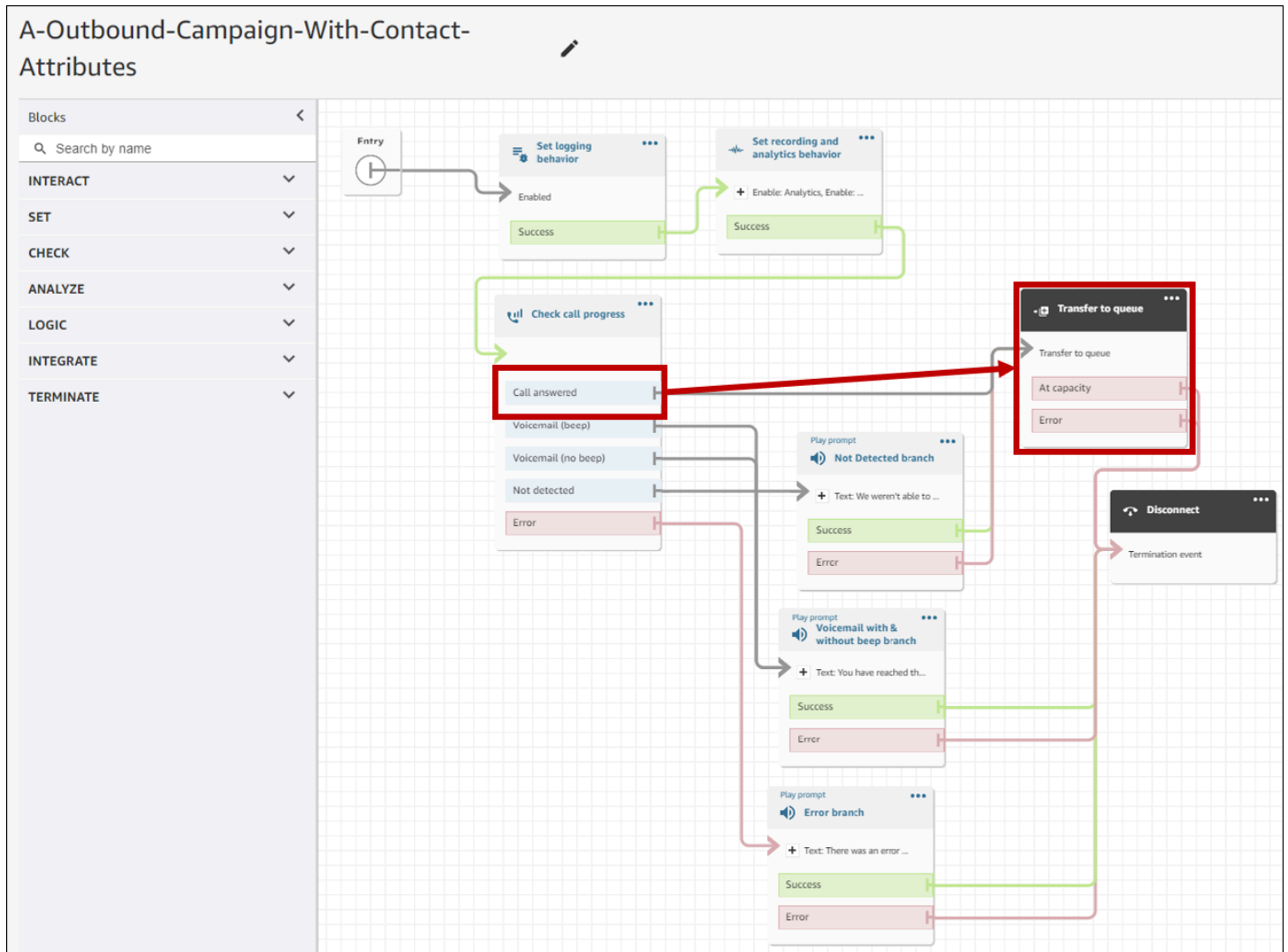

Whisper and queue flow best practices

- Remove the **Loop prompts** from the **Default customer queue** flow and replace them with **End flow / Resume**.

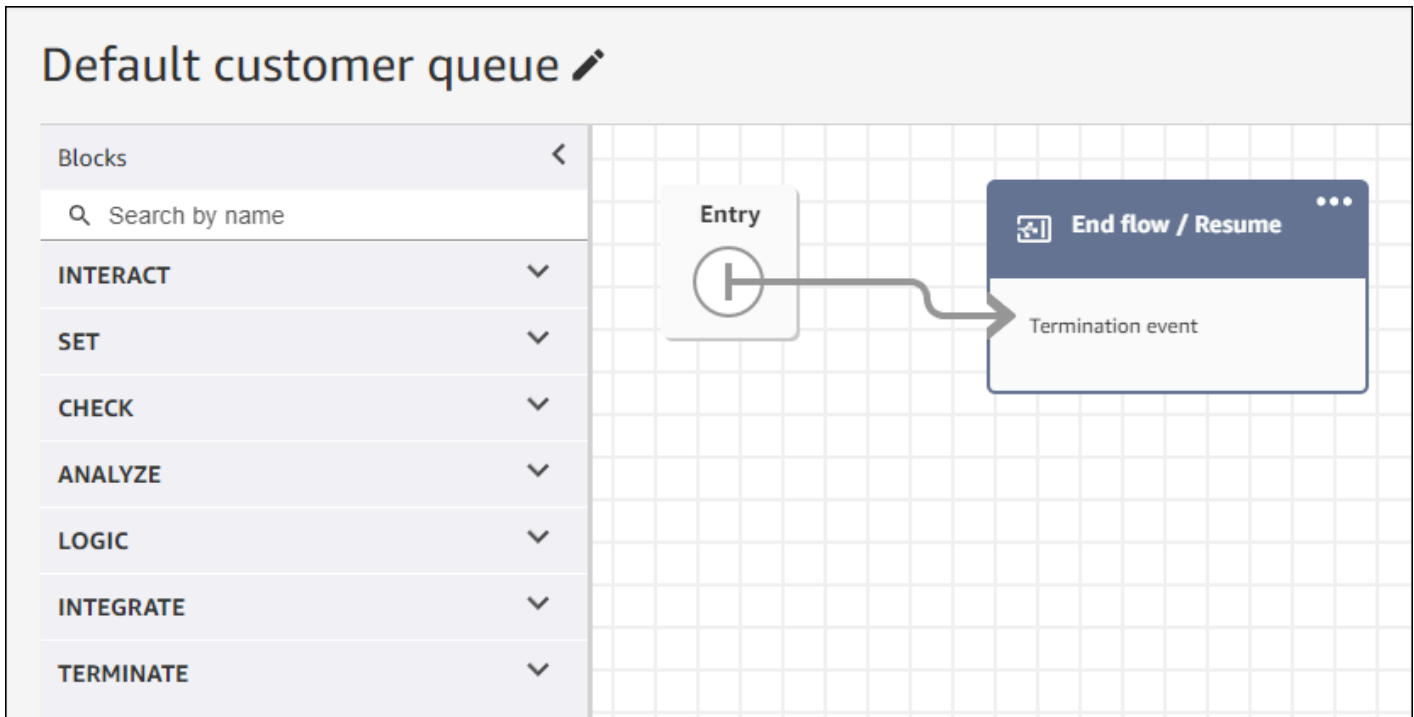

- If agents don't answer within 2 seconds of calls going to queue, you can minimize silent calls by using **Loop prompts** and play a message for the customer. The following image shows a typical flow block with a Loop prompt.

Default customer queue

Blocks

INTERACT

SET

CHECK

ANALYZE

LOGIC

INTEGRATE

TERMINATE

Entry

Loop prompts

When agents are not answering within 2s...

Text: <speaks><break time=...

Error

End flow / Resume

Termination event

Loop prompts

Loops a sequence of prompts while a customer or agent is on hold or in queue.

When Loop prompts is used in a queue flow, audio playback can be interrupted at preset times. [Learn more](#)

Prompts

Text to Speech

[Learn more about Amazon Connect's TTS capabilities](#)

<speaks><break time="2s"/> Please wait for next agent answers the call-</speaks>

SSML

Audio recording

CustomerQueue.wav

Cancel Save

- Change any **Play prompt** blocks to **End flow / Resume** in your **Default customer whisper** and **Default agent whisper** flows.

Default customer whisper

Default agent whisper

Blocks

INTERACT

SET

CHECK

ANALYZE

LOGIC

INTEGRATE

TERMINATE

Entry

End flow / Resume

Termination event

User administration best practices

- [Enable the Auto-accept calls](#). This reduces the potential for call connection latency/delay after a dialed party answers.
- [Set After Contact Work \(ACW\) timeout](#) to 30. Minimizing the ACW time will optimize the dialing algorithm when using Predictive dialing campaigns. The following image shows the settings.

The screenshot displays the 'Settings' page for a user profile. At the top, there are two dropdown menus: 'Security profile' set to 'Admin' and 'Routing profile' set to 'Basic Routing Profile', both marked as 'Required'. Below these is the 'Phone' section, which includes a 'Phone type' dropdown set to 'Soft phone'. A red box highlights the 'Auto-accept calls' checkbox, which is checked. Another red box highlights the 'After Contact Work (ACW) timeout' section, showing a 'Timeout (seconds)' field set to '30' and a note stating 'The contact will time out after 30 seconds'. At the bottom, there is a link to 'Show advanced settings'.

Workstation and network best practices

The following best practices can help optimize agent efficiency by ensuring adequate hardware and network resources.

- Ensure that agent workstations meet the minimum requirements. For more information, see [Agent headset and workstation requirements for the CCP](#).
- Ensure that the agent has the CCP or agent workspace open and present on their desktop. This reduces the time spent bringing the screen to the front before greeting the caller.
- On the local network, ensure that the agents are connected to a LAN. This mitigates potential wireless network latency

- If possible, minimize the geographic distance between the AWS Region that hosts your Amazon Connect instance and the agents that interact with the outbound campaigns. The greater the geographic distance between your agents and the hosting Region, the higher the possible latency.

Note

Outbound campaigns have limitations on the numbers that agents can dial, depending on the origin of the Amazon Connect instance. For more information, see the [Amazon Connect Telecoms Country Coverage Guide](#).

Testing best practices

As a best practice, run tests at scale. To achieve the lowest call connection latency, use outbound campaigns to make hundreds of thousands of continuous calls to mimic your production environment. Call connection latency can be relatively high when making a handful of campaign calls.

Best practices for answering machine detection

To use Answering Machine Detection (AMD) in a campaign, use the [Check call progress](#) flow block. It provides call progress analysis. This is an ML-model that detects an answered call condition so that you can provide different experiences for calls answered by people and calls answered by machine, with or without a beep. The flow block also provides a branch for routing calls when the ML-model can't distinguish between people and voicemail, or when errors occur in call processing.

AMD uses the following criteria to detect live calls:

- Background noise associated with a pre-recorded message.
- Long strings of words such as "Hello, I am sorry I missed your call. Please leave a message at..."
- A live caller saying something similar to "Hello, hello?" followed by a post-greeting silence.

Forty to 60-percent of calls to consumers go to voicemail. AMD helps eliminate the number of voicemail calls over live calls. However, the detection accuracy has limitations.

- If the voicemail greeting is a short "Hello" or includes a pause, AMD detects it as a live customer (a false negative).

- Sometimes a long greeting by a live customer is incorrectly detected as a voicemail (a false positive).
- There is a small delay while the system connects the call to an agent, which could result in the customer possibly hanging up.
- PBX (private branch exchange) numbers with multiple levels of voicemail prompts are not supported.

The pros, cons, and best uses of Answering Machine Detection

The use of Answering Machine Detection (AMD) may not comply with telemarketing laws. You are responsible for implementing AMD in a manner that is compliant with applicable laws, and you should always consult your legal advisor regarding your specific use case.

Use case 1: AMD is on and leaving automatic voicemails

- **Pros** – Agents primarily interact with live calls 95-percent of the time, maximizing talk time. AMD can leave automatic voicemails if a voicemail is detected.
- **Cons** – The technology leaves a voicemail 50-percent to 60-percent of the time due to false positives due to the large variety of answering machine types. Also, AMD can irritate customers because it adds a short delay to live calls.
- **Best uses** – Calling consumers during the day when you may get a large quantity of answering machines and it's not urgent to ensure every call receives a voicemail.

Use case 2: AMD is on but not leaving automatic voicemails

- **Pros** – Agents primarily interact with live calls 95-percent of the time, maximizing talk time.
- **Cons** – Cannot leave any voicemails. Adds a delay to live calls which can annoy customers.
- **Best uses** – Calling consumers during the day when you may get a large quantity of voicemails and you don't want to leave any voicemails.

Use case 3: AMD is off and agents can leave manual voicemails

- **Pros** – Voicemails can be left 100-percent of the time.
- **Cons** – Agents must determine whether they are receiving a live call or voicemail. Must manually leave a voicemail. Most time consuming and can lower the number of calls your agents make in a day.

- **Best uses** – Calling consumers or businesses and leaving customized voicemails.

Use case 4: AMD is off and agents can leave a prerecorded voicemail

- **Pros** – Agents can leave a personalized, pre-recorded voicemail 100% of the time saving significant time by avoiding repeating the same message over and over with 'Voicemail Drop'.
- **Cons** – Agents must determine whether they are receiving a live call or voicemail. More time consuming than AMD but quicker than manually leaving a voicemail.
- **Best uses** – Calling consumers or businesses and leaving generic voicemails.

Journey best practices

As a best practice, create a well-defined scenario for each Amazon Pinpoint journey. Limit the scope of a scenario to a specific aspect of a larger customer experience that enables you to monitor, refine, and manage a customer's specific experience. You can then create a sequence of related journeys.

For example, a journey can welcome new customers and provide recommended first steps during their first seven days as a customer. Based on each customer's actions during the first journey, you can route them to additional journeys tailored to their initial level of engagement. One journey might provide next steps for customers who were highly engaged in the first journey. Another subsequent journey might promote different products or services to customers who were less engaged in the first journey. By creating a sequence of scoped journeys, you can continually refine and manage the customer experience throughout the customer lifecycle.

After you define a scenario, choose journey settings that support your goals for the scenario. The settings define the timing, volume, and frequency with which any part of a journey can engage participants.

Note

The following steps assume that you have at least one project and one journey in Amazon Pinpoint. If not, see [Managing Amazon Pinpoint projects](#), and [Create a journey](#), both in the *Amazon Pinpoint User Guide*

To access journey settings

1. Open the Amazon Pinpoint console at <https://console.aws.amazon.com/pinpoint/>.
2. In the navigation pane, choose **Journeys**, then open a journey with a status of **Draft** or **Paused**.

You can also choose **Stop journey** to stop a journey.

3. Open the **Actions** list and choose **Settings**.
4. Expand the following sections to implement the various best practices.

Time zone detection

Time zone detection helps estimate an endpoint's time zone based on `Endpoint.Location.Country` and any combination of `Endpoint.Address` and `Endpoint.Location.PostalCode`. The endpoint's time zone is used to avoid calling at inappropriate times of the day, when quiet time is configured, and also when a journey sends messages based on a local time zone. Time zone estimation is only performed on endpoints that do not have a value for the `Demographic.Timezone` attribute.

Note

AWS GovCloud (US-West) does not support time zone detection.

If a journey contains endpoints with multiple time zones:

- When you enable `Recipient's local time zone`:
 - The journey calls or sends a message according to the latest time zone for an endpoint.
 - The journey stops sending when all messages have been sent, or according to the earliest time zone for an endpoint.

Journeys with endpoints in multiple time zones and quiet time

When you enable **Quiet time**, and you have endpoints on multiple time zones, the journey does not call or send messages to an endpoint during the quiet time of any timezone. The journey only calls and sends messages when all the endpoints can receive them, as controlled by the journey's sending rules.

For example, if your journey's quiet time runs from 20:00 (8:00 PM) to 08:00 (8:00 AM), and the journey uses endpoints in UTC-8 America/Los_Angeles and UTC-5 America/New_York, the journey starts sending messages at 08:00 America/Los_Angeles (11:00 America/New_York) and stops sending messages at 17:00 America/Los_Angeles (20:00 America/New_York).

Store and use local time zones

To optimize participant engagement in a journey that has a scheduled start and end time, configure the journey to use each participant's local time zone. This helps to ensure that journey activities occur when a participant is most likely to participate in those activities.

To use recipient time zones

- Under **When to send**, choose the **Recipients local time zone** radio button.

Note

That setting's usefulness depends on whether you store local time zone values in the endpoint definitions for participants. If you use this setting and the endpoint definition for a participant doesn't specify a time zone, Amazon Pinpoint doesn't include the participant in the journey. To avoid this issue, use the `Demographic.Timezone` attribute to store time zone information for participants. This is a standard attribute provided by Amazon Pinpoint.

Address quiet time conflicts

If you configure an activity to send messages at a time that conflicts with the quiet-time settings for the journey, Amazon Pinpoint doesn't send messages until the quiet time ends. If you chose to resume sending messages after quiet time ends, Pinpoint also sends any messages held during quiet time. If not, it drops the held messages.

Journey limits

For certain use cases, such as telemarketing, organizations limit attempts to call an endpoint over a certain number of days. Amazon Pinpoint provides the following ways to configure the number of attempts:

- Specify the maximum contact attempts made to an endpoint in a 24 hour period.

- Specify the maximum number of times you can reach an endpoint for a particular journey, and across journeys.
- Set a rolling limit by specifying the maximum number of times you can reach an endpoint within a certain time period. For example, contact an endpoint at most 2 times over the next 7 days.

The following image shows the various journey limit settings.

▼ Journey limits (advanced)

Maximum daily messages per endpoint

The maximum number of messages that can be sent to an endpoint across all journeys in a 24-hour period. If you specify a maximum of 0, endpoints can receive an unlimited number of journey messages per day.

Specify a value of 0 or greater.

Override default setting

Enable this option to specify a maximum number of messages that a single endpoint can receive in a 24-hour period. The default value for this setting is 0 (no limit).

Maximum number of messages an endpoint can receive from this journey

Maximum number of messages that can be sent to an endpoint by each journey. If you specify a maximum of 0, endpoints can receive an unlimited number of messages from each journey.

Specify a value between 0 and 100.

Override default setting

Enable this option to specify a maximum number of messages that a single endpoint can receive from this journey. The default value for this setting is 0 (no limit).

Maximum number of journey messages per second

The maximum number of messages that the journey can send each second. The number that you specify has to be less than or equal to the maximum sending rate for your account.

Specify a value between 1 and 20,000.

Override default setting

Enable this option to specify a maximum number of messages per second for this journey. By default, the maximum number of messages per second is 50.

Maximum entries per endpoint

The maximum number of times an endpoint can enter the journey. If you specify a maximum of 0, endpoints can enter the journey an unlimited number of times.

Specify a value greater than or equal to 0.

Endpoint re-entry interval

The time to wait before re-entering an endpoint into a journey. The setting only applies if endpoint re-entry cap is not set to 1.

Time period

Unit

days ▼

Override default setting

Enable this option to specify a maximum number of re-entries for this journey. By default, the maximum number of re-entries is 1.

Maximum number of messages across all journeys within a time frame.

Maximum number of messages an endpoint can receive across all journeys within a set period of days. If you specify a maximum of 0, endpoints can receive an unlimited number of messages. This setting is configured at the project level here.

This value can be a number from 0 to 100.

Time frame

The time in Maximum number of messages across all journeys within a time frame applies.

This value can be a number from 1 to 30.

Override project setting

Enable this option to specify a maximum number of messages across all journeys within a time frame from this journey.

Schedule best practices

Amazon Connect outbound campaigns enable you to limit calls to certain times of day and avoid calls during quiet times in the evening or during weekends. You can also set calling exceptions in an Amazon Pinpoint journey. The exceptions overwrite the sending times configured for days of the week.

We recommend using both features. For more information about scheduling in Amazon Connect, see . For more information about scheduling in Amazon Pinpoint, see [Step 4: Choose when to send the campaign](#), in the *Amazon Pinpoint User Guide*.

In addition to exceptions, you can:

- Stop calls from predictive and progressive campaigns by logging all agents out of the campaign queue.
- Use the Amazon Connect console to manually pause a campaign.

Best practices for activity settings

In the **Entry** activity of your journey, only use the **Add participants from a segment** option.

Do Not Call best practices

Many countries have created DNC (Do Not Call) lists. These allow telephone subscribers to not receive marketing calls. Companies must check customer phone numbers against such DNC lists, and remove those numbers before placing a call. You use Amazon Pinpoint to manage DNC lists in outbound campaigns.

Journeys allow you to check the status of an endpoint against third-party data sources before sending the messages. You can also add an AWS Lambda function that conducts external DNC checks and does or does not dial based on the response.

The following image shows the suggested DNC flow.

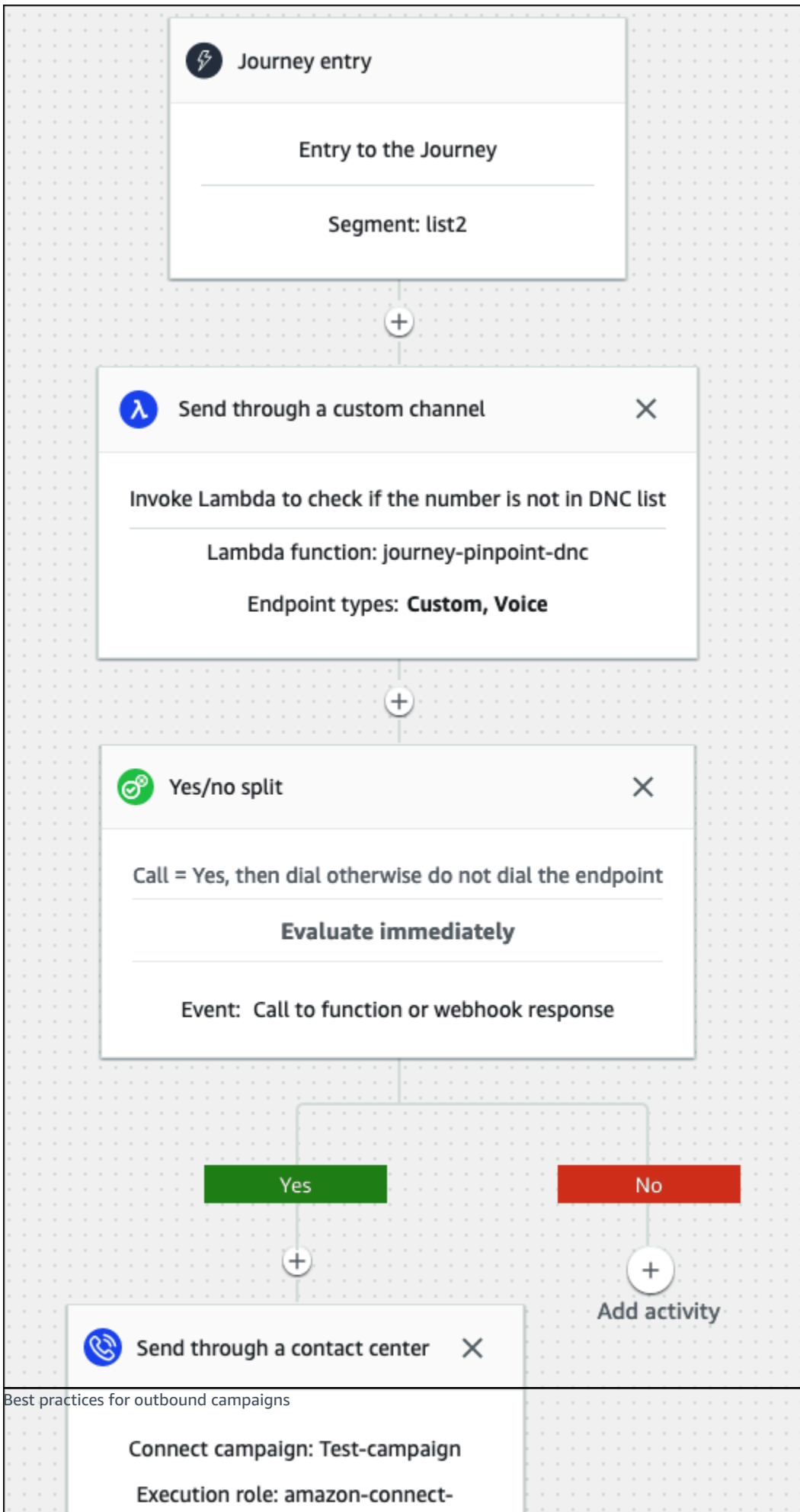

Best practices for managing redials

The following sections provide best practices for managing redials and differentiating your call center from spammers.

Automate workflows and use multiple channels

As a best practice, don't persistently call leads and hope the contact answers. The more you call, the less likely the contact may be to answer. Instead, use automation to move the contact to another list and call back 30 days later, then perhaps 60 days later.

Also, look at the number of times a call goes to voicemail. At some point, you may want to stop calling that lead.

An optimal strategy uses automated workflows with multiple communication channels to build an outreach cadence. For example, you start with a phone call, then send an SMS message, then an email. This can significantly increase the chances of contacting the lead. For more information about setting up multiple channels, see:

- [Tutorial: Using Postman with the Amazon Pinpoint API](#), in the *Amazon Pinpoint Developer Guide*.
- [Tutorial: Setting up an SMS registration system](#), in the *Amazon Pinpoint Developer Guide*.

The next sections provide other tips for managing redials.

Manage your call volume

The following best practices can help differentiate your call center from spammers and help protect the integrity of your phone numbers.

- Place no more than 50 calls per area code, per carrier, per day.
- To configure how often a number is dialed, use the **Send through a contact center** activity with a **Wait** activity in your journey. Amazon Pinpoint supports a maximum of three **Send through a contact center** activities per journey. Use that activity strategically.

For example, use it when a call is **Not answered**, but choose another follow up method for **Voicemail beep** and **Voicemail no beep**, such as email or SMS. Those channels can still provide in-session engagement with the contact by using hyperlinks in emails, or keyword responses such as YES in SMS, to provide self service or contact an agent. This allows contacts to connect when they want to.

To limit dialing

1. As needed, [create a journey in Amazon Pinpoint](#).
2. Set up the journey entry and add the **Send through a contact center** activity.

For more information about doing that, see [Set up the journey entry activity](#), in the *Amazon Pinpoint User Guide*.

3. After the activity, add a multivariate split.

For more information about doing that, see [Set up a multivariate split activity](#), in the *Amazon Pinpoint User Guide*.

4. Open the split and add **Branch B** and **Branch C**.
5. Edit the branches in the split as follows:

- **Branch A**

- a. Open the **Choose a condition** list and select **Event**.
- b. Open the **Choose a journey message activity and event** list and select the **Contact center key**.
- c. Open the **Event** list and select **Not answered**.

- **Branch B**

- Repeat the same steps as Branch A but choose **Voicemail beep**.

- **Branch C**

- Repeat the same steps as Branch A but choose **Voicemail no beep**.

6. Add a **Wait** activity after each branch, then edit each **Wait** activity as follows:

- Branch A

- a. In the **Time period** section, enter **4**.
- b. In the **Unit** list and select **hours**.
- c. Select **Save**.

- Branch B

- a. In the **Time period** section, enter **1**.
- b. In the **Unit** list and select **hours**.
- c. Select **Save**.

- Branch C

- a. In the **Time period** section, enter **4**.

- b. In the **Unit** list and select **days**.
 - c. Select **Save**.
7. After Branch A, add the **Send through a contact center** activity. Set the parameters of this activity similar as Lab 2.
8. After branches B and C, add the **Send an email** or **Send an SMS** activities. Set up a message template to complete this activity. For more information, see [Amazon Pinpoint message templates](#).

The following image shows the workflow:

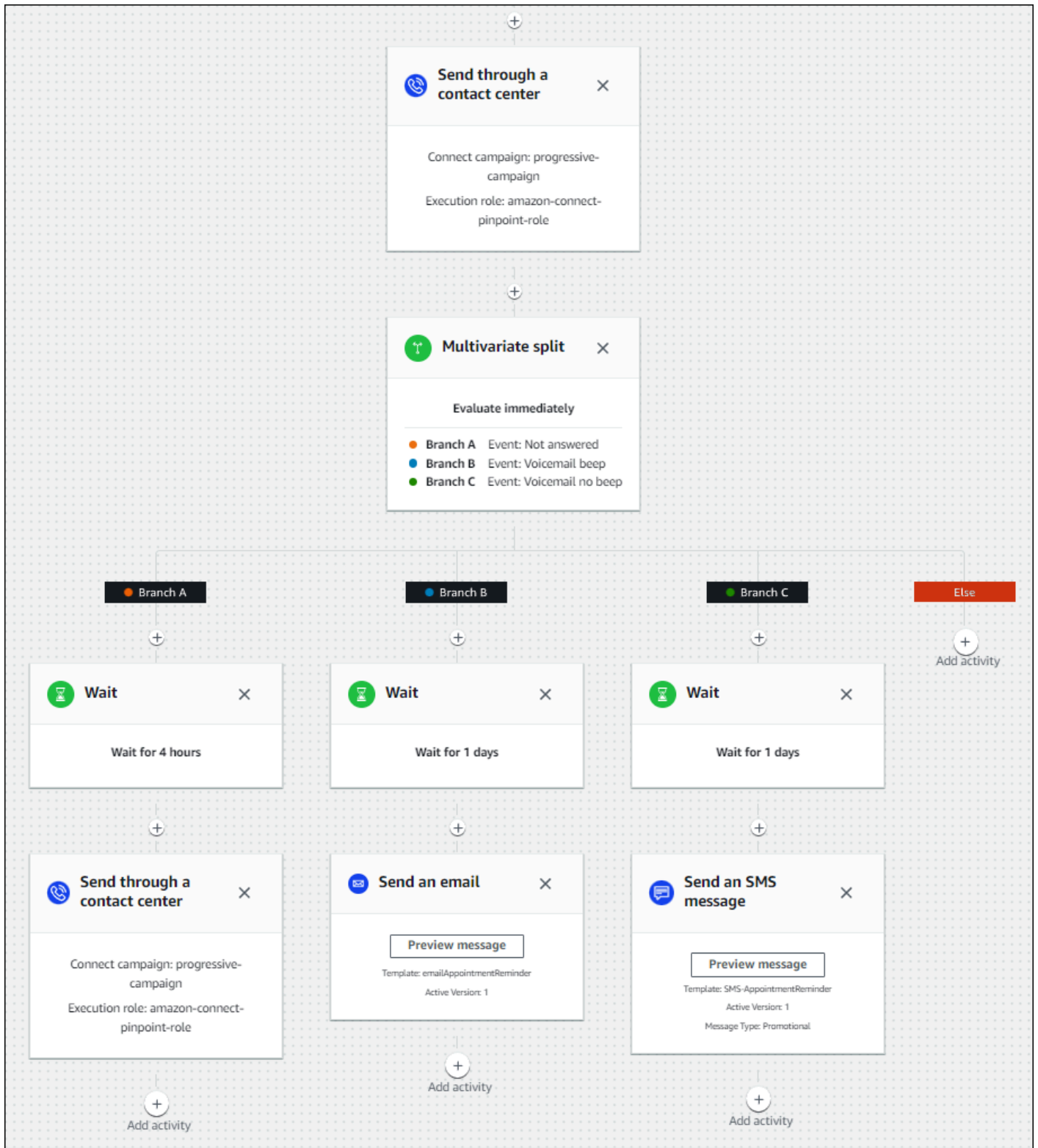

Best practices for ring duration and caller ID

The following best practices can help you comply with regulations.

Meet the minimum ring duration requirements

Regulations may require unanswered calls to ring for a minimum amount of time, such as 15 seconds, so the customer has time to pick up the call. Amazon Connect outbound campaigns let unanswered calls ring until they go to voicemail or automatically terminate.

Maintain Calling Line Identification

Many locations require you to display the phone number associated with a caller ID. Amazon Connect enforces the use of Calling Line Identification that corresponds to a number in an Amazon Connect instance. The phone number you specify as caller ID for an outbound campaign must be one you have claimed or ported in to your number inventory.

Manage users in Amazon Connect

As the admin one of your key responsibilities is to manage users, add users to Amazon Connect, give them their credentials, and assign the appropriate permissions so they can access the features needed to do their job.

The topics in this section explain how to add users using the Amazon Connect admin website. To manage users programmatically, see [User management actions](#) in the *Amazon Connect API Reference Guide*.

Contents

- [Add users to Amazon Connect](#)
- [Edit users in bulk](#)
- [View historical changes to user records](#)
- [Download users from your Amazon Connect instance](#)
- [Delete users from your Amazon Connect instance](#)
- [Reset a user's password for Amazon Connect](#)
- [Security profiles](#)

Add users to Amazon Connect

When you add users to Amazon Connect, you can configure them with information appropriate to their roles. For example, you specify their [security profile](#), which indicates the tasks they can perform in Amazon Connect admin website. For agents you specify their [routing profile](#), which indicates the contacts that can be routed to them.

This topic explains how to add users using the Amazon Connect admin website. To add users programmatically, see [CreateUser](#) in the *Amazon Connect API Reference Guide*. To use the CLI, see [create-user](#).

Add a user individually

1. Log in to the Amazon Connect admin website at https://instance_name.my.connect.aws/. Use an **Admin** account, or an account assigned to a security profile that has **Users - Create** permission.
2. In Amazon Connect, on the left navigation menu, choose **Users, User management**.
3. Choose **Add new users**.
4. Choose **Create and set up a new user** and then choose **Next**.
5. Enter the name, email address, secondary email address, mobile number, and password for the user.

Note

The following caveat only applies to Amazon Connect instances that are not configured for SAML, that is, instances where you chose **Store users in Amazon Connect** when you [configured identity management](#) for your instance:

- If you provide a secondary email, the user receives email notifications - other than password reset notifications - to this email address instead of to their primary email address.

Tip

Mobile number is not currently used by Amazon Connect.

6. Choose a routing profile and a security profile.

7. Optionally, add Tags to identify, organize, search for, filter, and control who can access this hours of operation record. For more information, see [Tag resources in Amazon Connect](#).
8. Choose **Save**. If the Save button isn't active, it means you're logged in with an Amazon Connect account that doesn't have the required security profile permissions.

To fix this issue, log in with an account that is assigned to the Amazon Connect Admin security profile. Or, ask another Admin to help.

9. For information about adding agents, see [Configure agent settings: routing profile, phone type, and auto-accept calls](#).

Add users in bulk from a .csv file

Note

Avoid adding too many unique resources in the .csv file. For example, don't add more than 100 different routing profiles. This may cause a timeout or failure during the validation process.

Bulk upload is for adding new records, not for editing existing records. To edit user records in bulk, see [Edit users in bulk](#).

Use these steps to add several users from a .csv file such as an Excel spreadsheet.

1. Log in to Amazon Connect with an **Admin** account, or an account assigned to a security profile that has **Users - Create** permission.
2. In Amazon Connect, on the left navigation menu, choose **Users, User management**.
3. Choose **Add new users**.
4. Choose **Import users using a .csv template** and then choose **.csv template**.

The .csv template has the following columns in the first row:

- first name
- last name
- email address
- secondary email address
- mobile: This is not currently used by Amazon Connect.

- password
- user login
- agent hierarchy
- routing profile name
- security_profile_name_1|security_profile_name_2
- user_hierarchy_1|user_hierarchy_2
- phone type (soft/desk)
- phone number
- soft phone auto accept (yes/no)
- ACW timeout (seconds)
- tags

The following image shows a sample of what the .csv template looks like in an Excel spreadsheet. The first row in the spreadsheet contains the column headings, and the second row contains sample user data.

1	2	3	4	5	6	7	8	9	10	11	12	13	14	15	16	
first name	last name	email address	secondary email	mobile	password	user login	routing profile name	security_profile_name_1	security_profile_name_2	user_hierarchy_1	user_hierarchy_2	phone type (soft/desk)	phone number	soft phone auto accept (yes/no)	ACW timeout (seconds)	tags
Fisrt	Last	email@example.com	secondary email@example.com	11234567891 34	SamplePassword12	admin	Basic Routing Profile	Admin		Planet Continent Country State City		soft		no	0	key1 value1 key2 value2

5. Add your users to the template and upload it to Amazon Connect. Choose **Upload file and verify**.
6. Amazon Connect validates the data in the file. Choose **Save** to create the new user records.

User management > Add user

Add user

Cancel **Save**

Add users and configure them with permissions that are appropriate to their roles.

Add a user manually

Import users using a .csv template

Upload file

3 users were validated and ready to be saved.

Login	Status	Name (Last, First)	Email address	Secondary
batch100	Validated	batch100, Agent100	batch100@example.com	-
batch101	Validated	batch101, Agent101	batch101@example.com	-
batch102	Validated	batch102, Agent102	batch102@example.com	-

Rows per page 25 1 - 3 of 3

If you get a validation error message, it usually indicates that one of the required columns is missing information, or there's a typo in one of the cells.

The following image shows an example validation error message. In this case, the security profile was misspelled and a password didn't meet requirements.

2 of 3 users failed to import. You can save partially the validated users or fix all users and try uploading the file again. [Download file](#)

To avoid corrupted data, disable links and macros when reading downloaded files.

Login	Status	Name (Last, First)	Email address	Secondary
batch100	Security profile: Not found	batch100, Agent100	batch100@example.com	-
batch101	Password: At least 8 characters with an uppercase letter, a lowercase letter, and a number	batch101, Agent101	batch101@example.com	-
batch102	Validated	batch102, Agent102	batch102@example.com	-

- To upload only the validated user records, choose **Save**. A dialog box prompts you for confirmation.

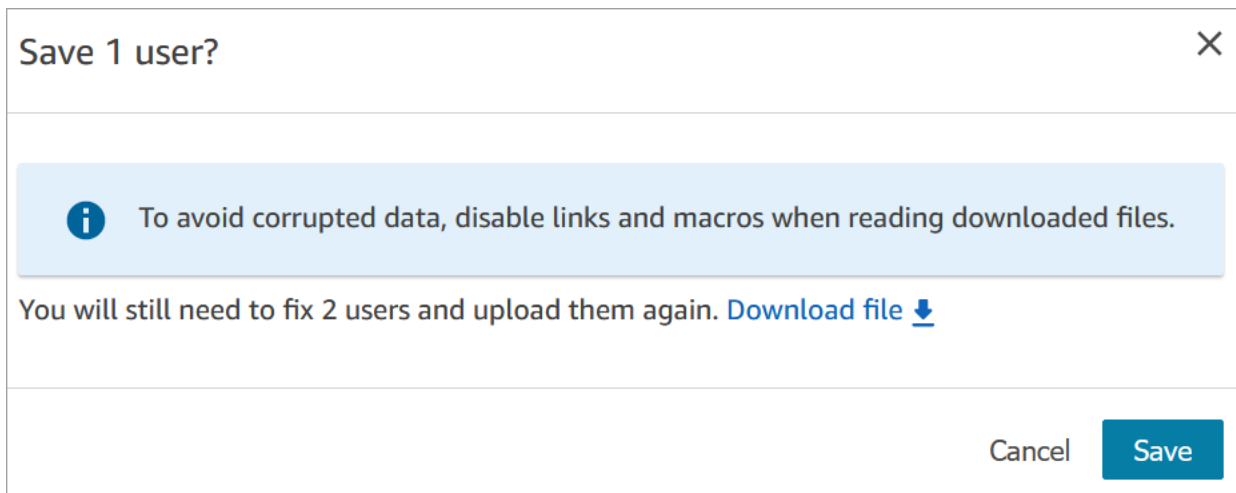

8. A banner displays the status of the upload and confirms when it's complete.

i **Tip**

While a batch of additions is being processed, you can continue working on the **User management** page, choosing another batch of user records to create, edit, or delete, in bulk or individually. This is useful for quickly updating settings such as routing profiles for groups of agents.

Amazon Connect sequentially processes the records in bulk.

9. Choose **Refresh** to update the **User management** page with the users that have been created.

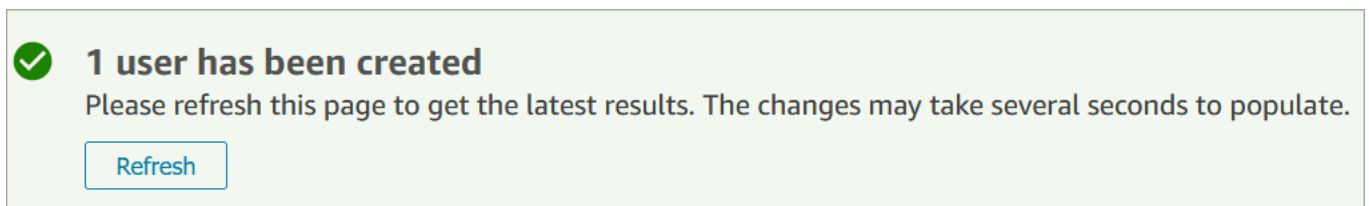

Required permissions for adding users

Before you can add users to Amazon Connect, you need the following permissions assigned to your security profile: **Users - Create**. The following image shows that this security profile permission is in the **Users and permissions** section of the **Add/Edit security profile** page.

Users and permissions ⓘ							
Type	All	View	Edit	Create	Remove	Enable / Disable	Edit permission
Users	<input type="checkbox"/>	<input checked="" type="checkbox"/>	<input checked="" type="checkbox"/>	<input checked="" type="checkbox"/>	<input type="checkbox"/>	<input type="checkbox"/>	<input type="checkbox"/>
Agent hierarchy	<input type="checkbox"/>	<input type="checkbox"/>	<input type="checkbox"/>	<input type="checkbox"/>	<input type="checkbox"/>	<input type="checkbox"/>	<input type="checkbox"/>
Security profiles	<input type="checkbox"/>	<input type="checkbox"/>	<input type="checkbox"/>	<input type="checkbox"/>	<input type="checkbox"/>	<input type="checkbox"/>	<input type="checkbox"/>
Agent status	<input type="checkbox"/>	<input type="checkbox"/>	<input type="checkbox"/>	<input type="checkbox"/>	<input type="checkbox"/>	<input type="checkbox"/>	<input type="checkbox"/>

By default, the Amazon Connect **Admin** security profile has these permissions.

For information about how to add more permissions to an existing security profile, see [Update security profiles](#).

Edit users in bulk

Bulk edit mode enables you to quickly edit the attributes that are common across user records, such as routing profiles, security profiles, and tags.

Tip

While a batch of bulk edits is being processed, you can continue working on the **User management** page, such as selecting more records to edit or delete, in bulk or individually. This is useful for quickly updating settings, such as routing profiles for groups of agents.

1. Log in to Amazon Connect with an Admin account, or an account assigned to a security profile that has **Users - Edit** permission.
2. In Amazon Connect, on the left navigation menu, choose **Users, User management**.
3. If needed, choose **Add filter** to specify a subset of users, such as users with a specific **Routing profile**. This option is shown in the following image.

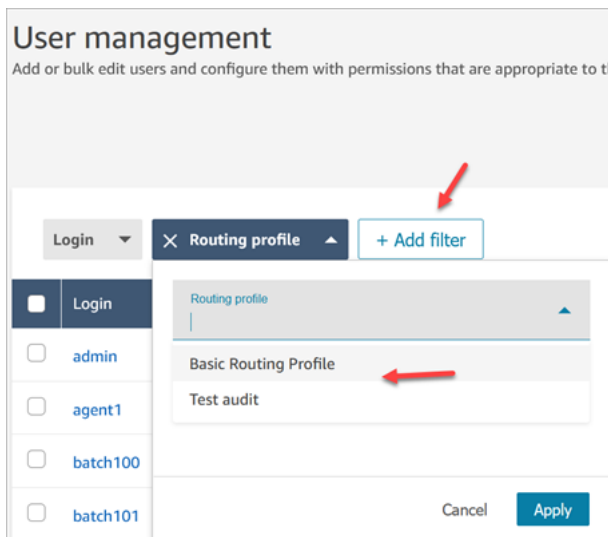

- To quickly update a large number of users, at the bottom of the table choose to display **100** rows per page, as shown in the following image.

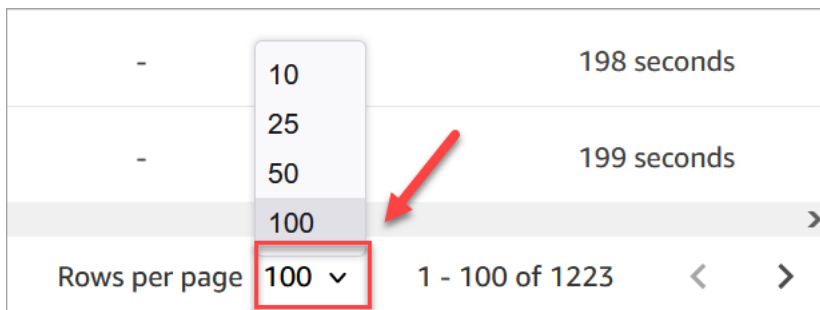

- To edit all the records on the page, choose the top box. Otherwise, select one or more records you want to edit at the same time. Choose **Edit**.

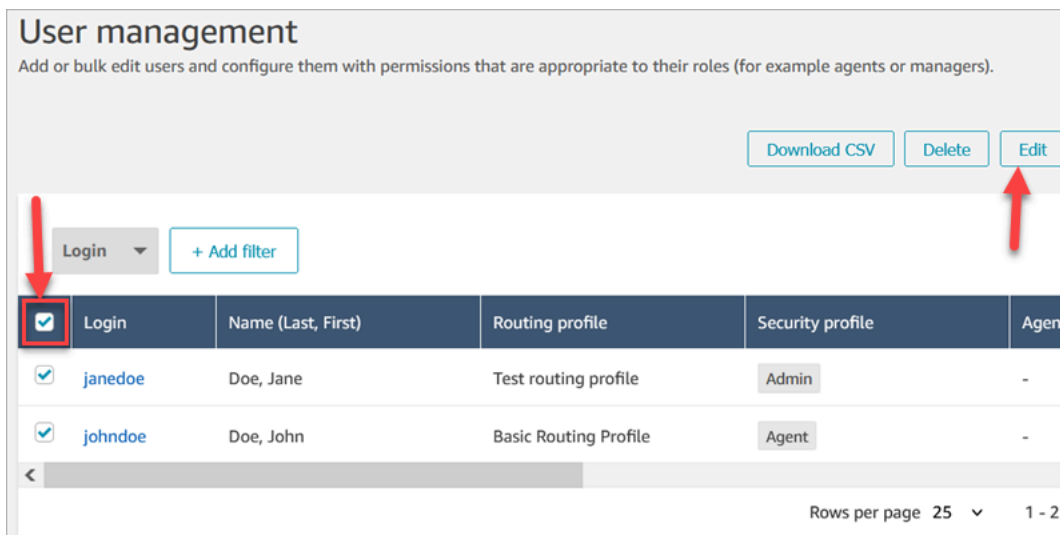

- On the **Bulk edit** page, in the **Settings** section, you can choose the following settings for all of the selected users:

- Security profile
 - Routing profile
 - Phone type
 - After Call Work (ACW) timeout
 - Agent hierarchy, if this has been set up
 - Tags
7. Choose **Save** to apply your changes to the selected records.
 8. While that batch of user records is being updated, you can continue working on the **User management** page, performing other create, edit, and delete tasks on user records.

Perform other edit tasks while a batch of bulk edits is being processed

After saving an update for a group of users, you can either make additional changes on the **Bulk edit** page (for example, [edit other user details](#) such as contact information) or you can choose different user records to edit.

Important

As long as you remain on the **User management** page, your update request will continue to be processed. Review the messages at the top of the page for the status of the update.

The following image shows an example of message at the top of the **User management** page that Amazon Connect is updating a batch of user records.

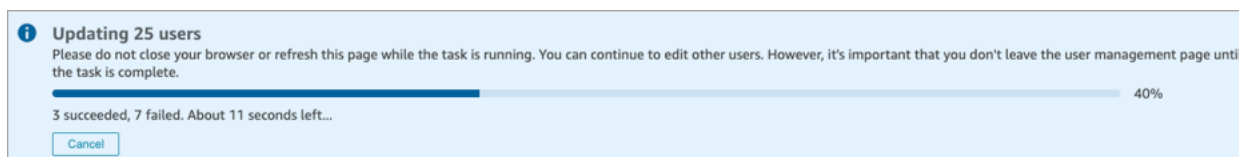

When you perform additional tasks on the **User management** page, Amazon Connect appends the next request to create, edit, or delete user records to the existing status message at the top of the page. Amazon Connect sequentially processes them in bulk.

Following are some tips about how Amazon Connect processes bulk edit requests.

- If you choose **Cancel** during a bulk create, edit, or delete, **only those requests not yet processed are canceled**.
- A message displays how many users were successfully updated. Choose **Refresh** to refresh the page with the list of the updated users.

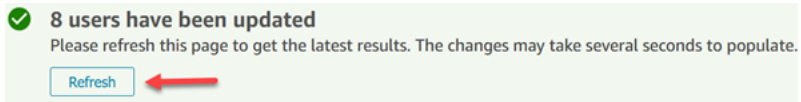

- If some user records fail to be updated, a message similar to the following image is displayed:

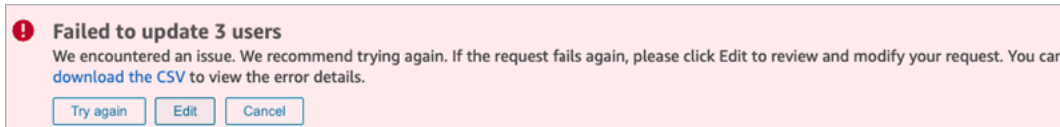

You have the following options:

- Choose **download the CSV** to discover the reason changes weren't updated. In the following example, the agent hierarchy was deleted before the user records were saved.

	A	B	C
1	Login	Failed reason	Failed fields
2	agent12	We couldn't save some of the fields	Agent hierarchy: Not found
3	agent13	We couldn't save some of the fields	Agent hierarchy: Not found
4	agent14	We couldn't save some of the fields	Agent hierarchy: Not found
5			

- Choose **Try again** to resubmit only those user records that failed. The others were already successfully updated.
- Choose **Edit** to be directed to the **Bulk edit** page so you can change the input for the user records that failed.

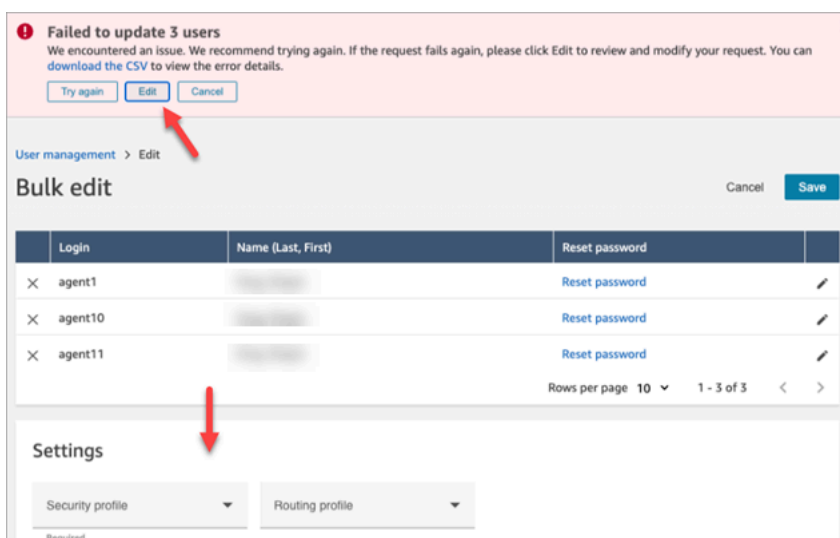

- Choose **Cancel** to not do anything with the 3 user records that weren't updated.

Edit other user details

You can page through selected user records to make updates to contact information, rather than choosing and opening each record individually.

1. On the **Bulk edit** page, select the user records you want to edit.
2. Choose the **Edit** (pencil) icon next to individual users to make updates.
3. A dialog box opens for the individual user. Make your changes, and choose **Submit**.
4. If needed, choose **Previous** and **Next** to open the next user record in the list. The following image shows the **Edit** dialog box for a single user while in bulk edit mode.

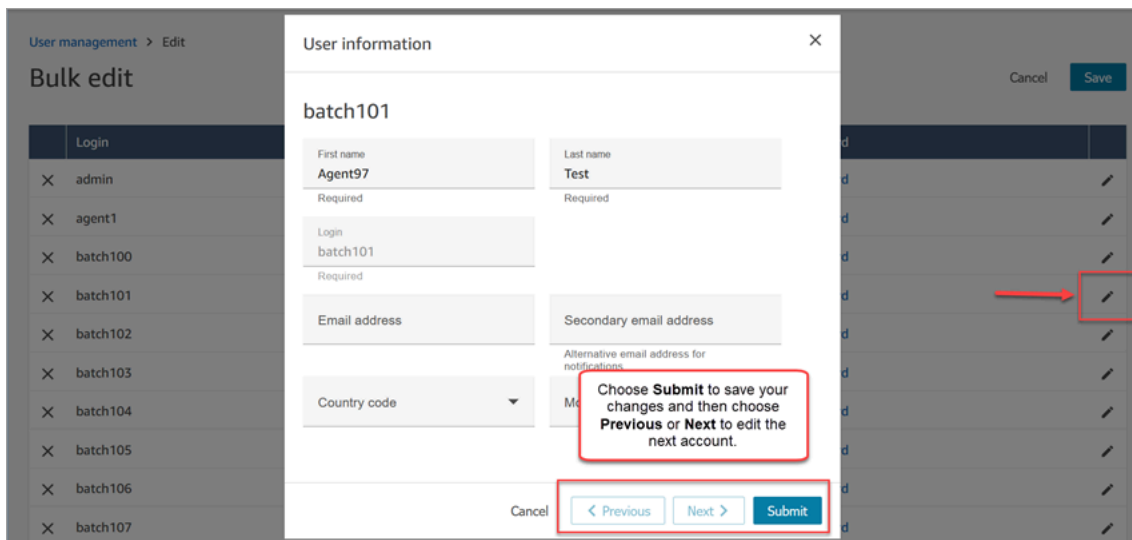

Edit user settings programmatically

You can change the following values programmatically across selected users. The users are changed to the same value.

Property	API	CLI
Routing profiles	UpdateUserRoutingProfile	update-user-routing-profiles
Security profiles	UpdateUserSecurityProfiles	update-user-security-profiles
Tags	TagResource	tag-resource

Property	API	CLI
	UntagResource	untag-resource
User hierarchies	UpdateUserHierarchy	update-user-hierarchy
User phone configuration	UpdateUserPhoneConfig	update-user-phone-config

You can edit the following identity and contact information programmatically for an individual user: first name, last name, email address, mobile number, secondary email address. Use the following API or CLI:

Property	API	CLI
Identify and contact information	UpdateUserIdentityInfo	update-user-identity-info

View historical changes to user records

1. Log in to the Amazon Connect admin website at [https://*instance name*.my.connect.aws/](https://instance_name.my.connect.aws/). Use an **Admin** account, or an account assigned to a security profile that has **Users and permissions - Users - View** permissions.
2. In Amazon Connect, on the left navigation menu, choose **Users, User management**.
3. On the **User management** page, choose **View historical changes**, as shown in the following image.

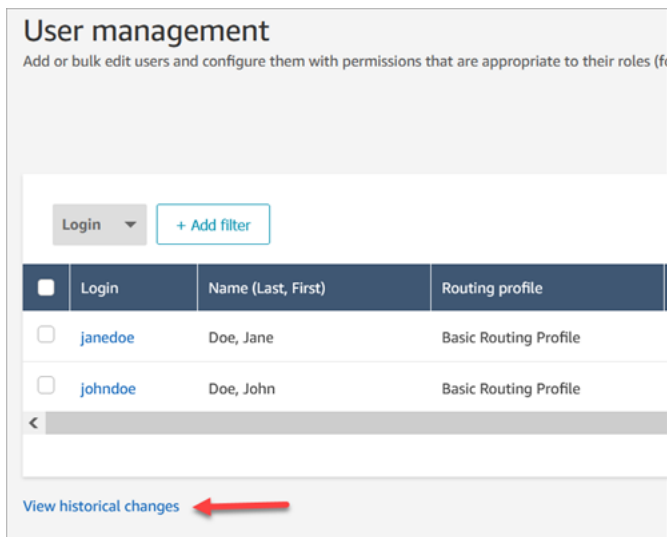

4. On the **View recent changes for agent** page, there is one row for each time a user record was changed. In the following image, there are multiple rows for **johndoe** because that user record has been updated multiple times.

To view the past changes for a specific user, choose their user name.

The screenshot shows the 'View recent changes for agent' page. It features a date range selector from '2023-01-31' to '2023-03-02' and a 'Filter by user name' input field. Below is a table with columns: 'Changed by (user)', 'Change time', 'Change type', and 'Resource name'. The table contains four rows of change records. A red arrow points to the 'johndoe' resource name in the first row.

Changed by (user)	Change time	Change type	Resource name
janedoe	March 1, 2023 11:03:37 PM UTC	UPDATE	johndoe
janedoe	February 15, 2023 7:34:14 PM UTC	UPDATE	janedoe
janedoe	February 15, 2023 7:33:56 PM UTC	CREATE	johndoe
janedoe	February 15, 2023 7:32:59 PM UTC	DELETE	johndoe

Rows per page: 25

5. On the **View recent changes for [resource name]** page, you can view details about what has been changed in the user record, when, and who made the change, as shown in the following image.

View recent changes for johndoe

Change time	Resource type	Before	After	Changed by (user)
March 1, 2023 11:03:37 PM UTC	Softphone auto answer	Not enabled	Enabled	janedoe
March 1, 2023 11:03:37 PM UTC	ACW Timeout	0	10	janedoe
February 15, 2023 7:33:56 PM UTC	Display name	New field	John	janedoe
February 15, 2023 7:33:56 PM UTC	Softphone	Not enabled	Enabled	janedoe
February 15, 2023 7:33:56 PM UTC	Profile	New field	Basic Routing Profile	janedoe
February 15, 2023 7:33:56 PM UTC	ACW Timeout	New field	0	janedoe
February 15, 2023 7:33:56 PM UTC	Is Active	New field	Active	janedoe
February 15, 2023 7:33:56 PM UTC	Security Profiles	New field	Agent	janedoe

Download users from your Amazon Connect instance

You can export a list of users from Amazon Connect to a .csv file. The output is limited to the results that appear on the page; it does not include all the users, if you have more users than appear on the page.

1. Log in to the Amazon Connect admin website at https://instance_name.my.connect.aws/. Use an **Admin** account, or an account assigned to a security profile that has **Users and permissions - Users - Edit** permissions.
2. In Amazon Connect, on the left navigation menu, choose **Users, User management**.
3. Choose **Download CSV**.

Tip

If a user has **Users - View permissions** instead of **Edit** permissions, they will see the **Download CSV** option on their page, but when they choose it, the .csv file will be empty.

Delete users from your Amazon Connect instance

Important

- You can't undo a deletion.

- When a user is deleted from Amazon Connect, you won't be able to configure their agent settings any more. For example, you won't be able to assign a routing profile to them.
- If you delete a user record that has an associated quick connect, you need to [delete the quick connect](#), too. Otherwise it will be orphaned. When agents attempt to transfer calls to it, no one is there to answer the call.
- Orphaned quick connects can disrupt other Amazon Connect processes such as instance replication and syncing processes that are done as part of [Amazon Connect Global Resiliency](#).

This topic explains how to delete user records using the Amazon Connect admin website. To delete user records programmatically, see [DeleteUser](#) in the *Amazon Connect API Reference Guide*. To use the CLI, see [delete-user](#).

What happens to the user's metrics?

The user's data in contact records and reports is retained. The data is preserved for the consistency of the historical metrics. For example, when you search for contact records, you'll still see the agent's username, any contact recordings involving the agent, etc.

In the historical metrics reports, the agent's data will be included in the **Agent performance** metrics report. However, you won't be able to see an **Agent activity audit** of the deleted agent because their name won't appear in the drop-down list.

How to delete users

Tip

- While a batch of deletions is being processed, you can continue working on the **User management** page, choosing another batch of user records to create, edit, or delete, in bulk or individually. This is useful for quickly updating settings such as routing profiles.
-

1. Log in to Amazon Connect using an **Admin** account, or an account assigned to a security profile that has **Users - Remove** permission.

- In Amazon Connect, on the left navigation menu, choose **Users, User management**. Choose one or more users you want to delete, and then choose **Delete**.

- Confirm you want to delete the users.

- The following image shows an example of the message when a user is deleted successfully. Choose **Refresh** to update the list of users on the **User management** page.

- If Amazon Connect fails to delete one or more user records, it displays a message similar to the following image.

! Failed to delete 1 user
 We encountered an issue. We recommend trying again. You can [download the CSV](#) to view the error details.

When you get a failed to delete message, you have the following options:

- Choose **download the CSV** to view the error details. The following details show the user records had already been deleted. In this case, I hadn't refreshed the **User management** page and tried to delete the records again.

	A	B
1	Login	Failed reason
2	batch100	The specified user was not found
3	batch101	The specified user was not found
4	batch102	The specified user was not found
5		

- Choose **Try again** to resubmit those records that failed to be deleted. The other records were successfully deleted.
- Choose **Cancel** to not do anything with the user records that weren't deleted.

Required permissions to delete users

Before you can update permissions in a security profile, you must be logged in with an Amazon Connect account that has the following permissions: **Users - Remove**.

Security profile permissions						
Routing ⓘ						
Numbers and flows ⓘ						
Users and permissions ⓘ						
Type	All	View	Edit	Create	Remove	
Users	<input type="checkbox"/>	<input checked="" type="checkbox"/>	<input checked="" type="checkbox"/>	<input checked="" type="checkbox"/>	<input checked="" type="checkbox"/>	
Agent hierarchy	<input type="checkbox"/>	<input type="checkbox"/>	<input type="checkbox"/>	<input type="checkbox"/>	<input type="checkbox"/>	
Security profiles	<input type="checkbox"/>	<input type="checkbox"/>	<input type="checkbox"/>	<input type="checkbox"/>	<input type="checkbox"/>	
Agent status	<input type="checkbox"/>	<input type="checkbox"/>	<input type="checkbox"/>	<input type="checkbox"/>	<input type="checkbox"/>	

By default, the Amazon Connect **Admin** security profile has these permissions.

Reset a user's password for Amazon Connect

To reset a user's Amazon Connect password

1. Log in to the Amazon Connect admin website at https://instance_name.my.connect.aws/. Use an Admin account, or a user account that has [security profile permissions](#) to reset passwords.
2. In Amazon Connect, on the left navigation menu, choose **Users, User management**.
3. Select the user and choose **Edit**.
4. Choose **reset password**. Specify a new password and then choose **Submit**.

Resetting the user's password will immediately log them out of the Contact Control Panel.

5. Communicate the new password to the user.

Reset your own lost or forgotten Amazon Connect admin password

- See [Emergency admin login](#).

Reset your own agent or manager password

Use the following steps if you want to change your password, or if you forgot it and need a new one.

1. If you're an Amazon Connect agent or manager, at the Amazon Connect login page, choose **Forgot Password**.
2. Type the characters you see in the image, and then choose **Recover Password**.
3. A message will be sent to your email address with a link that you can use to reset your password.

Reset your own lost or forgotten AWS password

- To reset the password you used when you first created your AWS account, see [Resetting a Lost or Forgotten Root User Password](#) in the *IAM User Guide*.

Security profiles

A security profile is a group of permissions that map to a common role in a contact center. For example, the Agent security profile contains permissions needed to access the Contact Control Panel (CCP).

Security profiles help you manage who can access the Amazon Connect dashboard and Contact Control Panel (CCP), and who can perform specific tasks.

Contents

- [Best practices for security profiles](#)
- [About inherited permissions](#)
- [List of security profile permissions](#)
- [Default security profiles](#)
- [Assign a security profile to a user](#)
- [Create a security profile](#)
- [Update security profiles](#)
- [Tag-based access control](#)
- [Hierarchy access control \(Preview\)](#)

Best practices for security profiles

- Limit who has **Users - Edit or Create** permissions

People with these permissions pose a risk to your contact center because they can do the following:

- Reset passwords, including that of the administrator.
- Grant other users permission to the Admin security profile. People assigned to the Admin security profile have full access to your contact center.

Doing these things would enable someone to lock out those who need to access Amazon Connect, and allow in others who can steal customer data and damage your business.

To reduce the risk, as a best practice we recommend limiting the number of people who have **Users - Edit or Create** permissions.

- [Use AWS CloudTrail](#) to log the requests and responses of [UpdateUserIdentityInfo](#). This enables you to track changes made to user information. Someone who has the ability to call the `UpdateUserIdentityInfo` API can change a user's email address to one owned by an attacker, and then reset the password through email.
- [Understand inherited permissions](#)

Some security profiles included inherited permissions: when you assign dedicated permissions to one object, by default permissions are granted to sub-objects. For example, when you grant dedicated permission to edit users, you also grant them permission to list all security profiles for your Amazon Connect instance. This because to edit users, the person has access to drop-down list of security profiles.

Before assigning security profiles, review the list of inherited permissions.

- **Understand the implications of [access control tags](#) before applying them to a security profile.** Applying access control tags is an advanced configuration feature that is supported by Amazon Connect and that follows the AWS shared responsibility model. Ensure that you have read the documentation and understand the implications of applying granular permission configurations. For more information, review the [AWS shared responsibilities model](#).
- Track who accesses recordings.

In the **Analytics and Optimization** permission group, you can enable a download icon for recorded conversations. When members of this group go to **Analytics and optimization, Contact search**, and then search contacts, they will see an icon to download recordings.

Important

This setting isn't a security feature. **Users who don't have this permission can still download recordings using other less-discoverable ways.**

We recommend that you track who in your organization accesses recordings.

About inherited permissions

Some security profiles included inherited permissions: when you give a user explicit permissions to **View** or **Edit** one resource type, such as queues, they implicitly inherit permissions to **View** another resource type, such as phone numbers.

For example, assume you explicitly grant someone permission to **Edit/View** queues, as shown in the following image:

Security profile permissions					
Routing ⓘ					
Type	All	View	Edit	Create	Enable / Disable
Routing profiles	<input type="checkbox"/>	<input type="checkbox"/>	<input type="checkbox"/>	<input type="checkbox"/>	<input type="checkbox"/>
Quick connects	<input type="checkbox"/>	<input type="checkbox"/>	<input type="checkbox"/>	<input type="checkbox"/>	<input type="checkbox"/>
Hours of operation	<input type="checkbox"/>	<input type="checkbox"/>	<input type="checkbox"/>	<input type="checkbox"/>	<input type="checkbox"/>
Queues	<input type="checkbox"/>	<input checked="" type="checkbox"/>	<input checked="" type="checkbox"/>	<input type="checkbox"/>	<input type="checkbox"/>

By doing this you also implicitly grant them permissions to **View** a list of all phone numbers and hours of operation in your Amazon Connect instance, **when they add them to the queue**. On the **Add new queue** page, the available phone numbers and hours of operation appear in dropdown lists, as shown in the following image.

The screenshot shows a form with four sections:

- Hours of operation:** A search field with the text "Search for hours of operat..." and a dropdown arrow. Below it is a red error message: "Hours of operation are required." A red box highlights the dropdown arrow.
- Outbound caller ID name:** A search field with the text "Enter the callback name" and a description: "The name that will show up on the customer's phone".
- Outbound caller ID number:** A search field with the text "Search for phone number" and a dropdown arrow. A red box highlights the dropdown arrow.
- Outbound whisper flow (optional):** A search field with the text "Search for contact flow" and a dropdown arrow.

However, the user doesn't have permissions to **Edit** the phone numbers and hours of operation.

In this case, they also don't inherit permissions to **View** contact flows (the outbound whisper flow) and quick connects because those resources are optional.

List of inherited permissions

The following table lists permissions that are implicitly inherited when you assign dedicated permissions to a user.

Tip

When a user has only explicit **View** permissions and not also **Edit** permissions, the objects are retrieved but Amazon Connect doesn't surface them in drop-down lists for the user to peruse.

Dedicated permission	Inherited permissions
Users - View or Edit	When someone edits a user's information in the Amazon Connect console, they can view the following information in drop-down boxes when they add it to the user's account:

Dedicated permission	Inherited permissions
	<ul style="list-style-type: none"> • All security profiles in the instance • All routing profiles in the instance • All agent hierarchies in the instance • All agent proficiencies in the instance
Queues - View or Edit	<p>When someone edits queues in the Amazon Connect console, they can view the following information in drop-down and search boxes when they add it to the queue:</p> <ul style="list-style-type: none"> • All quick connects in the instance • All phone numbers in the instance • All operating hours in the instance
Quick connects - View	<ul style="list-style-type: none"> • All queues in the instance • All flows in the instance • All users in the instance
Quick connects - Edit	<ul style="list-style-type: none"> • All queues in the instance • All flows in the instance
Phone numbers - View or Edit	<p>When someone edits phone numbers in the Amazon Connect console (not the CCP), they can view the following information in a drop-down box when they associate it with the phone number:</p> <ul style="list-style-type: none"> • All flows in the instance

List of security profile permissions

The security profile permissions in Amazon Connect allow users access to perform specific tasks in Amazon Connect.

The following tables list:

- **UI name:** The name of the permission as it appears on the **Security profiles** page in Amazon Connect.
- **API name:** The name of the permission when it is returned by the [ListSecurityProfilePermissions](#) API.
- **Use:** The functionality granted by the permission.

Routing

UI name	API name	Use
Routing profiles - Create	RoutingPolicies.Create	Create routing profiles.
Routing profiles - Edit	RoutingPolicies.Edit	Edit routing profiles.
Routing profiles - View	RoutingPolicies.View	View routing profiles.
Quick connects - Create	TransferDestinations.Create	Create quick connects.
Quick connects - Delete	TransferDestinations.Delete	Delete quick connects.
Quick connects - Edit	TransferDestinations.Edit	Edit quick connects.
Quick connects - View	TransferDestinations.View	View quick connects. Agents need this permission so they can view quick connects in the agent application to transfer calls.
Hours of operation - Create	HoursOfOperation.Create	Set hours of operation and timezone for a queue.

UI name	API name	Use
HoursOfOperation - Delete	HoursOfOperation.Delete	Delete hours of operation and timezone for a queue.
HoursOfOperation - Edit	HoursOfOperation.Edit	Edit hours of operation and timezone for a queue.
HoursOfOperation - View	HoursOfOperation.View	View hours of operation and timezone for a queue.
Queues - Create	Queues.Create	Create queues.
Queues - Edit	Queues.Edit	Edit information for a queue, such as name, description, and hours of operation.
Queues - Enable / Disable	Queues.EnableAndDisable	Enable and disable queues to quickly control the flow of contacts to queues temporarily.
Queues - View	Queues.View	View a list of queues in your Amazon Connect instance.
Task templates - Create	TaskTemplates.Create	Create task templates
Task templates - Delete	TaskTemplates.Delete	Delete task templates
Task templates - Edit	TaskTemplates.Edit	Edit task templates.

UI name	API name	Use
Task templates - View	TaskTemplates.View	View task templates.

Channels and flows

UI name	API name	Use
Prompts - Create	Prompts.Create	Create prompts.
Prompts - Delete	Prompts.Delete	Delete prompts.
Prompts - Edit	Prompts.Edit	Edit prompts.
Prompts - View	Prompts.View	View a list of available prompts.
ContactFlows - Create	ContactFlows.Create	Create flows.
ContactFlows - Delete	ContactFlows.Delete	Delete flows.
ContactFlows - Edit	ContactFlows.Edit	Edit flows.
ContactFlows - Publish	ContactFlows.Publish	Publish flows.
ContactFlows - View	ContactFlows.View	View flows.
Flow modules - Create	ContactFlowModules.Create	Create flow modules for reusable functions
Flow modules - Delete	ContactFlowModules.Delete	Delete flow modules.
Flow modules - Edit	ContactFlowModules.Edit	Edit flow modules.

UI name	API name	Use
Flow modules - Publish	ContactFlowModules.Publish	Publish flow modules.
Flow modules - View	ContactFlowModules.View	View flow modules.
Phone numbers - Claim	PhoneNumbers.Claim	Claim phone numbers.
Phone numbers - Edit	PhoneNumbers.Edit	Edit phone numbers. Attach a claimed or ported phone number to a flow.
Phone numbers - Release	PhoneNumbers.Release	Release phone numbers back to inventory.
Phone numbers - View	PhoneNumbers.View	View a list of phone numbers that have been claimed or ported to your Amazon Connect instance.
Communication widget - Enable/Disable	ChatTestMode	Access a simulated web page so users can test the chat experience . Also grant users the Contactflow.View permission so they can view and choose from a list of available flows in the Test settings option.

UI name	API name	Use
Views	Views.View	Allow access to Views

Users and permissions

UI name	API name	Use
Users - Create	Users.Create	<p>Add users to Amazon Connect.</p> <p>We recommend you limit who has these permissions. They pose a risk to your contact center because they can do the following:</p> <ul style="list-style-type: none"> • Reset passwords, including that of the administrator. • Grant other users permission to the Admin security profile. People assigned to the Admin security profile have full access to your contact center. <p>Doing these things would enable someone to lock out those who need to access Amazon</p>

UI name	API name	Use
		Connect, and allow in others who can steal customer data and damage your business.
Users - Delete	Users.Delete	Delete users from Amazon Connect.
Users - Edit	Users.Edit	View and edit all user identity information <i>except</i> for security profiles. As with Users - Create , limit who has these permissions because they pose a risk to your contact center.
Users - Edit permission	Users.EditPermission	View and edit user security profiles. As with Users - Create , limit who has these permissions because they pose a risk to your contact center.
Users - View	Users.View	View user records.
Agent hierarchy - Create	AgentGrouping.Create	Create agent hierarchies. Add groups, teams, and agents.
Agent hierarchy - Edit	AgentGrouping.Edit	Edit agent hierarchies.

UI name	API name	Use
Agent hierarchy - Enable/Disable	AgentGrouping.EnableAndDisable	View or edit agent hierarchy information.
Agent hierarchy - View	AgentGrouping.View	View the agent's hierarchy information in a real-time metrics report, which can include their location and skill set data.
Security profiles - Create	SecurityProfiles.Create	Create security profiles.
Security profiles - Delete	SecurityProfiles.Delete	Delete security profiles.
Security profiles - Edit	SecurityProfiles.Edit	Update security profiles.
Security profiles - View	SecurityProfiles.View	View security profiles.
Agent status - Create	AgentStates.Create	Create an custom agent status. The status appears in the Contact Control Panel (CCP), such as Break, Lunch, or Training.
Agent status - Edit	AgentStates.Edit	Edit a custom agent status.
Agent status - Enable/Disable	AgentStates.EnableAndDisable	View and edit custom agent states.

UI name	API name	Use
Agent status - View	AgentStates.View	View an agent's status in the real-time metrics report and historical metrics report. For example, if they are Available , Offline , or in a custom state. View their status in the Agent activity report .

Contact Control Panel (CCP)

UI name	API name	Use
Access Contact Control Panel	BasicAgentAccess	Manages access to the Contact Control Panel (CCP). Assign this permission to agents as well as managers who need to monitor live conversations.
Contact Lens data	RealtimeContactLens.View	Enables users to view real-time analytics provided by Contact Lens.
Make outbound calls	OutboundCallAccess	Grants users permissions to make outbound calls. For more information about setting up outbound calling,

UI name	API name	Use
		see Set up outbound calling .
Voice ID	Voiceld.Access	<p>Enables controls in the Contact Control Panel so agents can:</p> <ul style="list-style-type: none"> • View authentication outcomes. • Opt-out or re-authenticate a caller. • Update SpeakerID . • View fraud detection results, rerun fraud analysis (fraud detection decision, fraud type and score).
Restrict task creation	RestrictTaskCreation.Access	Block agents from being able to create tasks.
Audio device settings	AudioDeviceSettings.Access	Choose your preferred device for speaker, microphone, and ringer in the Contact Control Panel (CCP) or agent workspace.
Video calls	VideoContact.Access	Enable agents to use video calling.

Analytics and Optimization

UI name	API name	Use
Access metrics	AccessMetrics	Manage access to real-time and historical metrics reports.
Real-time metrics	AccessMetrics.RealTimeMetrics.Access	Manage access to the real-time metrics page.
Historical metrics	AccessMetrics.HistoricalMetrics.Access	Manage access to the historical metrics page.
Agent activity audit	AccessMetrics.AgentActivityAudit.Access	Manage access to the agent activity audit within the historical metrics page.
Dashboards	AccessMetrics.Dashboards.Access	Dashboards: View performance insights
Contact Search	ContactSearch.View	Access the Contact search page, which is where users can search for contacts and see results on the Contact details page.
View My Contacts	MyContacts.View	Allows agents to view contacts that they themselves had handled, on Contact search and Contact details pages.

UI name	API name	Use	
Search contacts by conversation characteristics	ContactSearchWithCharacteristics.Access	Access to the Contact Lens filters that enable users to search by sentiment scores, non-talk time, and category.	
Search contacts by conversation characteristics - View	ContactSearchWithCharacteristics.View	View the Contact Lens filters that enable users to search by sentiment scores, non-talk time, and category.	
Search contacts by keywords	ContactSearchWithKeywords.Access	Search for contacts by keyword. On the Contact Search page, users can access additional filters that allow them to search Contact Lens transcripts by keywords or phrases, such as "thank you for your business."	

UI name	API name	Use	
Search contacts by keywords - View	ContactSearchWithKeywords.View	Search for contacts by keyword. On the Contact Search page, users can access additional filters that allow them to search Contact Lens transcripts by keywords or phrases, such as "thank you for your business."	
Configure searchable contact attributes - View	ConfigureContactAttributes.View	Determine what custom attribute data will be searchable (by people who have the Contact attributes permission). It allows them to access the Searchable custom contact attributes page. For more information, see Search by custom contact attributes .	

UI name	API name	Use	
Restrict contact access	RestrictContactAccessByHierarchy.View	Manage a user's access to results on the Contact search page based on their agent hierarchy group. For more information, see Manage who can search for contacts and access detailed information .	
Contact attributes	ContactAttributes.View	View contact attributes. Also controls access to the search filters based on contact attributes. For more information, see Search by custom contact attributes .	

UI name	API name	Use
Contact Lens - conversational analytics - View	GraphTrends.View	<p>On the Contact details page for a contact, users can view conversational analytics outputs such as graphs (on sentiment, talk time, and other various outputs), sentiment indicators, and contact category labels on conversation recordings and transcripts.</p> <p>Users can view data on the Contact Lens conversational analytics dashboard.</p>
Contact Lens - custom vocabularies - Edit	ContactLensCustomVocabulary.Edit	Add custom vocabularies .
Contact Lens - custom vocabularies - View	ContactLensCustomVocabulary.View	Download and view custom vocabularies .

UI name	API name	Use
Contact Lens - post-contact summary	ContactLensPostContactSummary.View	View post-contact summarization powered by generative artificial intelligence (generative AI) on the Contact Search and Contact Details pages.
Contact Lens - theme detection - Create	ThemeDetection.Create	Create theme detection reports on the Contact search page.
Contact Lens - theme detection - View	ThemeDetection.View	View theme detection reports on the Contact search page.
Contact Lens - theme detection - Delete	ThemeDetection.Delete	Delete theme detection reports on the Contact search page.
Rules - Create	Rules.Create	Create rules.
Rules - Delete	Rules.Delete	Delete rules.
Rules - Edit	Rules.Edit	Edit rules.
Rules - View	Rules.View	View rules.

UI name	API name	Use	
Recorded conversations (redacted)	RedactedData.View	On the Contact details and Contact search pages for a contact, listen to call recording files and view call transcripts in which the sensitive data has been removed.	

UI name	API name	Use	
Recorded conversations (unredacted) - View	ListenCallRecordings	<p>On the Contact details and Contact search pages for a contact, view unredacted content that contains sensitive data, such as name and credit card information.</p> <ul style="list-style-type: none">• Original, unredacted chat transcripts• Original, unredacted transcripts analyzed by Contact Lens• Original, unredacted audio recordings <div data-bbox="829 1150 1149 1806" style="border: 1px solid #f08080; border-radius: 10px; padding: 10px;"><p> Important</p><p>If you have permissions to both Recorded conversations (redacted) and Recorded conversations (unredacted), note the following behavior:</p></div>	

UI name	API name	Use	
		<ul style="list-style-type: none"> • By default only redacted recordings and transcripts are made available on the Contact details and Contact search pages. • When no redacted content exists for the contact, or when redacted content cannot be shown to the user, then unredacted content is displayed on the Contact details and Contact search pages. 	

UI name	API name	Use	
		<p>To access unredacted conversations, remove permissions to Recorded conversations (redacted). This leaves the user with only Recorded conversations (unredacted) permissions. You cannot access both the redacted and unredacted version of a conversation at the same time.</p>	
Recorded conversations (unredacted) - Access	ListenCallRecordings	View the Play icon so they can listen to call recordings by using the Amazon Connect admin website.	

UI name	API name	Use	
Recorded conversations (unredacted) - Enable download button	DownloadCallRecordings	Enables buttons to download and delete call recordings. By default, the Enable download button permission is granted so the user can Download call recordings through the Amazon Connect admin website. To perform a download, however, the user needs permissions to access a Recorded conversation (unredacted) .	
Recorded conversations (unredacted) - Delete	DeleteCallRecordings	Delete call recordings. By default, the Enable download button permission is granted too so the user can delete recordings through the Amazon Connect admin website.	
Login/Logout report - View	AgentTimeCard.View	View Login/Logout reports .	

UI name	API name	Use
Real-time contact barge-in - Enable/Disable	ManagerBargeln	Enables supervisors and managers to barge into live conversations between agents and customers. To learn more about Barge for live conversations, see Barge live voice and chat conversations .
Real-time contact monitoring- Enable/Disable	ManagerListenIn	Monitor live conversations and listen to recordings of past conversations . Be sure to assign managers to the Agent security profile so they can access the Contact Control Panel (CCP). This enables them to monitor the conversation through the CCP.
Saved reports (admin)	MetricsReports.Admin	View and delete all saved reports in your instance, including those not created by you.
Saved reports - View	MetricsReports.View	View a shared report.

UI name	API name	Use
Saved reports - Create	MetricsReports.Create MetricsReports.Share	Create and share reports.
Saved reports - Edit	MetricsReports.Edit	Edit save reports.
Saved reports - Delete	MetricsReports.Delete	Delete saved reports.
Saved reports - Publish	MetricsReports.Publish	Publish reports.
Saved reports - Schedule	MetricsReports.Schedule MetricsReports.Publish ReportSchedules.Create ReportSchedules.Delete ReportSchedules.Edit ReportSchedules.View	Schedule a saved report. By default, the user gets permission to create, delete, edit, and view a saved report.
Evaluation forms - perform evaluations	Evaluation.Create Evaluation.View Evaluation.Edit Evaluation.Delete	Evaluate performance.

UI name	API name	Use
Evaluation forms - manage form definitions	EvaluationForms.Create EvaluationForms.View EvaluationForms.Edit EvaluationForms.Delete	Create and manage evaluation forms.
Evaluation forms - ask AI assistant	EvaluationAssistant.Access	Access the Ask AI button while performing evaluations, enabling the user to get generative AI-powered recommendations for answers to questions in evaluation forms.
Voice ID - attributes and search	VoiceIdAttributesAndSearch.View	Search for and view Voice ID results on the Contact detail page.
Voice ID - attributes and search	VoiceIdAttributesAndSearch.View	Search for and view Voice ID results on the Contact detail page.
Forecasting - View	Forecasting.View	Review contact volume and average handle time forecasts .

UI name	API name	Use
Forecasting - Edit	Forecasting.Edit	Create and edit contact volume and average handle time forecasts.
Forecasting - Edit	ForecastScheduleInterval.Edit	Set the forecast and schedule interval.
Forecasting - Publish	Forecasting.Publish	Publish a forecast.
Capacity planning - View	Capacity.View	Review capacity plan output.
Capacity planning - Edit	Capacity.Edit	Create capacity planning scenarios.
Capacity planning - Publish	Capacity.Publish	Publish a capacity plan.
Forecast and schedule interval	Forecasting.Edit	Set the forecast and schedule interval.

UI name	API name	Use
Screen recording - Access	ScreenRecording.Access	<p>Access the screen recording media player and view videos.</p> <div style="border: 1px solid #f08080; border-radius: 10px; padding: 10px; background-color: #fff9e6;"> <p>⚠ Important</p> <p>Screen recording merges the screen recording video with the unredacted call recording file. If users have permission to view screen recordings, they can listen to the unredacted audio.</p> </div>

Contact Actions

UI name	API name	Use
Transfer Contact	TransferContact.Enabled	<p>Transfer contacts on Analytics and optimization pages.</p> <p>Currently transfer of task contacts to</p>

UI name	API name	Use
		quick connects is supported on the Contact details page.
End contact	StopContact.Enabled	End contacts on Analytics and optimization pages. Currently supported on the Contact details page.
Reschedule contact	UpdateContactSchedule.Enabled	Reschedule previously scheduled contact on Analytics and optimization pages. Currently supported on the Contact details page for task contacts only.

Historical changes

UI name	API name	Use
View historical changes	HistoricalChanges.View	View historical changes on all Amazon Connect admin website pages that support historical changes.

Customer Profiles

UI name	API name	Use
Customer profiles - Create	CustomerProfiles.Create	Create customer profiles in the agent application.
Customer profiles - Edit	CustomerProfiles.Edit	Edit customer profiles in the agent application.
Customer profiles - View	CustomerProfiles.View	View customer profiles in the agent application.
Customer profiles Calculated Attributes - Create	CustomerProfiles.CalculatedAttributes.Create	Create calculated attributes.
Customer profiles Calculated Attributes - Edit	CustomerProfiles.CalculatedAttributes.Edit	Edit calculated attributes.
Customer profiles Calculated Attributes - Delete	CustomerProfiles.CalculatedAttributes.Delete	Delete calculated attributes.
Customer profiles Calculated Attributes - View	CustomerProfiles.CalculatedAttributes.View	View calculated attributes.

Scheduling

UI name	API name	Use
Schedule manager - View	Scheduling.View	View generated staff schedules in the

UI name	API name	Use
		Schedule manager user experience.
Schedule manager - Edit	Scheduling.Edit	Create, edit schedule configuration and publish generated staff schedules.
Schedule manager - Publish	Scheduling.Publish	Publish a schedule by using Schedule Manager.
Published schedule calendar	Scheduling.View	View a schedule.
Time off requests - Approve, Edit, View	TimeOff.Approve TimeOff.Edit TimeOff.View	Time off management.
Time off balance - Edit, View	TimeOffBalance.Edit TimeOffBalance.View	Time off management.
Team calendar	TeamCalendar.View	View published staff schedules in the Published Calendar user experience.
Team calendar	TeamCalendar.Edit	Edit published staff schedules in the Published Calendar user experience.

Agent Applications

UI name	API name	Use
Agent application schedule calendar	StaffCalendar.View StaffCalendar.Edit	<p>Ability for agents to view their schedules</p> <p>. The Edit permission is required for agents to view and use the Time off widget on their schedule that they use to request time off. If they only have View permission, the Time off widget will not appear on their schedule.</p> <p>For an example image that shows the Time off widget on an agent's schedule, see Agent initiated time off request.</p>
Custom views	CustomViews.Access	Use the Agent Workspace guided experience guide.
Amazon Q in Connect	Wisdom.View	View real-time recommendations in the agent application .
<i><3p app name></i> - Access	<i><3p app name></i> .Access	Allows agents to access a third-party application.

UI name	API name	Use
Content Management - Quick responses - Create	ContentManagement.Create	Set up a knowledge base to store quick responses. Create , import , and view the import history of quick responses that are displayed in the agent application.
Content Management - Quick responses - Edit	ContentManagement.Edit	Edit , import , and view the import history of quick responses that are displayed in the agent application.
Content Management - Quick responses - View	ContentManagement.View	View a list of quick responses in the Amazon Connect admin website.
Content Management - Quick responses - Delete	ContentManagement.Delete	Delete quick responses by using the Amazon Connect admin website.

Cases

UI name	API name	Use
Audit History - View	CaseHistory.View	View the audit history of cases in the agent application.
Cases - Create	Cases.Create	Create cases in the agent application.

UI name	API name	Use
Cases - View	Cases.View	View cases in the agent application.
Cases - Edit	Cases.Edit	Edit cases in the agent application.
Case Fields - Create	CaseFields.Create	Create case fields.
Case Fields - View	CaseFields.View	View case fields.
Case Fields - Edit	CaseFields.Edit	Edit case fields.
Case Templates - Create	CaseTemplates.Create	Create case templates.
Case Templates - View	CaseTemplates.View	View case templates.
Case Templates - Edit	CaseTemplates.Edit	Edit case templates.

Campaigns

UI name	API name	Use
Campaigns - Create	Campaigns.Create	Create outbound campaigns.
Campaigns - Delete	Campaigns.Delete	Delete outbound campaigns.
Campaigns - Edit	Campaigns.Edit	Edit outbound campaigns.
Campaigns - Manage	Campaigns.Delete	Manage outbound campaigns.

UI name	API name	Use
Campaigns - View		View outbound campaigns.

Default security profiles

Amazon Connect includes default security profiles for general roles. You can review the permissions granted by these profiles and use them if they align with the permissions that your users need. Otherwise, create a security profile that grants your users only the permissions they need.

The following table lists the default security profiles.

Security profile	Description
Admin	Grants administrators permission to perform a majority of actions.
Agent	Grants agents permission to access the CCP.
CallCenterManager	Grants managers permission to perform actions related to user management, metrics, and routing.
QualityAnalyst	Grants analysts permission to perform actions related to metrics.

Note

New permissions are added on a regular basis. We recommend revisiting your permission configurations to ensure your users can access the latest Amazon Connect features.

Assign a security profile to a user

Required permissions to assign security profiles

Before you can assign a security profile to a user, you must be logged in with an Amazon Connect account that has the **Users - Edit** permission, as shown in the following image. Or, if you're creating the user's account for the first time, you need **Users - Create** permission.

Users and permissions ⓘ							
Type	All	View	Edit	Create	Remove	Enable / Disable	Edit permission
Users	<input type="checkbox"/>	<input checked="" type="checkbox"/>	<input checked="" type="checkbox"/>	<input type="checkbox"/>	<input type="checkbox"/>	<input type="checkbox"/>	<input checked="" type="checkbox"/>
Agent hierarchy	<input type="checkbox"/>	<input type="checkbox"/>	<input type="checkbox"/>	<input type="checkbox"/>	<input type="checkbox"/>	<input type="checkbox"/>	<input type="checkbox"/>
Security profiles	<input type="checkbox"/>	<input type="checkbox"/>	<input type="checkbox"/>	<input type="checkbox"/>	<input type="checkbox"/>	<input type="checkbox"/>	<input type="checkbox"/>
Agent status	<input type="checkbox"/>	<input type="checkbox"/>	<input type="checkbox"/>	<input type="checkbox"/>	<input type="checkbox"/>	<input type="checkbox"/>	<input type="checkbox"/>

By default, the Amazon Connect **Admin** security profile has these permissions.

How to assign security profiles

1. Review [Best practices for security profiles](#).
2. Log in to the Amazon Connect admin website at https://instance_name.my.connect.aws/.
3. Choose **Users, User management**.
4. Select one or more users and choose **Edit**.
5. For **Security Profiles**, add or remove security profiles as needed. To add a security profile, put your cursor in the field and select the security profile from the list. To remove a security profile, click the **x** next to its name.
6. Choose **Save**.

Create a security profile

Creating a security profile enables you to grant your users only the permissions that they need.

For each permission group, there is a set of resources and supported set of actions. For example, users are part of the **Users and permissions** group, which supports the following actions: view, edit, create, remove, enable/disable, and edit permission.

Some actions depend on other actions. When you choose an action that depends on another action, the dependent action is automatically chosen and must also be granted. For example, if you add permission to edit users, we also add permission to view users.

Required permissions to create security profiles

Before you can create a new security profile, you must be logged in with an Amazon Connect account that has **Security profiles - Create** permissions, as shown in the following image.

Users and permissions ⓘ							
Type	All	View	Edit	Create	Remove	Enable / Disable	Edit permission
Users	<input type="checkbox"/>	<input type="checkbox"/>	<input type="checkbox"/>	<input type="checkbox"/>	<input type="checkbox"/>	<input type="checkbox"/>	<input type="checkbox"/>
Agent hierarchy	<input type="checkbox"/>	<input type="checkbox"/>	<input type="checkbox"/>	<input type="checkbox"/>	<input type="checkbox"/>	<input type="checkbox"/>	<input type="checkbox"/>
Security profiles	<input type="checkbox"/>	<input checked="" type="checkbox"/>	<input checked="" type="checkbox"/>	<input checked="" type="checkbox"/>	<input type="checkbox"/>	<input type="checkbox"/>	<input type="checkbox"/>
Agent status	<input type="checkbox"/>	<input type="checkbox"/>	<input type="checkbox"/>	<input type="checkbox"/>	<input type="checkbox"/>	<input type="checkbox"/>	<input type="checkbox"/>

By default, the Amazon Connect **Admin** security profile has these permissions.

How to create security profiles

1. Log in to the Amazon Connect admin website at https://instance_name.my.connect.aws/.
2. Choose **Users, Security profiles**.
3. Choose **Add new security profile**.
4. Type a name and description for the security profile.
5. Choose the appropriate permissions for the security profile from each permission group. For each permission type, choose one or more actions. Selecting some actions results in other actions being selected. For example, selecting **Edit** also selects **View** for the resource and any dependent resources.
6. Choose **Save**.

Tag-based access controls

You create a security profile with access control tags. Use these steps to create a security profile that enforces tag-based access controls.

1. Choose **Show advanced settings** at the bottom of the security profile.
2. In the **Access control** section, in the **Resources** box, enter the resources to be restricted using tags.

Access control ^

You can control access to Amazon Connect resources based on the tags on those resources. Used to limit access by role, department, region, etc. [Learn more](#)

Resources Tags

2 tags remaining

Summary

To restrict access using tags, select at least one resource and add at least one access control tag.

3. Enter the **Key** and **Value** combination for the resource tags that you want to restrict access to.
4. Ensure that you have enabled *View* permissions for the resources that you have selected.
5. Choose **Save**.

Note

It is mandatory to specify both a resource type and an access control tag when configuring tag-based access controls. As a best practice, ensure that you have matching resource tags on a security profile that has tag-based access controls configured. To learn more about tag-based access controls in Amazon Connect, see [Tag-based access control](#).

Tag security profiles

You can create a new security profile with resource tags. Use these steps to add a resource tag to a security profile.

1. Choose **Show advanced settings** at the bottom of the security profile.
2. Enter a **Key** and **Value** combination to tag the resource, as shown in the following image.

Tags ^

You can add resource tags to identify, organize, search for, filter and control who can access access this user. [Learn more](#)

3. Choose **Save**.

For more information about tagging resources, see [Tag resources in Amazon Connect](#).

Update security profiles

You can update a security profile at any time to add or remove permissions.

Required permissions to update security profiles

Before you can update permissions in a security profile, you must be logged in with an Amazon Connect account that has the following permissions: **Security profiles - Edit**.

Users and permissions ⓘ							
Type	All	View	Edit	Create	Remove	Enable / Disable	Edit permission
Users	<input type="checkbox"/>	<input type="checkbox"/>	<input type="checkbox"/>	<input type="checkbox"/>	<input type="checkbox"/>	<input type="checkbox"/>	<input type="checkbox"/>
Agent hierarchy	<input type="checkbox"/>	<input type="checkbox"/>	<input type="checkbox"/>	<input type="checkbox"/>	<input type="checkbox"/>	<input type="checkbox"/>	<input type="checkbox"/>
Security profiles	<input type="checkbox"/>	<input checked="" type="checkbox"/>	<input checked="" type="checkbox"/>	<input type="checkbox"/>	<input type="checkbox"/>	<input type="checkbox"/>	<input type="checkbox"/>
Agent status	<input type="checkbox"/>	<input type="checkbox"/>	<input type="checkbox"/>	<input type="checkbox"/>	<input type="checkbox"/>	<input type="checkbox"/>	<input type="checkbox"/>

By default, the Amazon Connect **Admin** security profile has these permissions.

How to update security profiles

1. Log in to the Amazon Connect admin website at https://instance_name.my.connect.aws/. You must be logged in with an Amazon Connect account that has permissions to update security profiles.
2. Choose **Users, Security profiles**.
3. Select the name of the profile.
4. Update the name, description, permissions, access control, and resource tags as needed.
5. Choose **Save**.

Note

Modifying the access control or resource tags on a security profile may impact the features or resources that a user with this security profile can access.

Tag-based access control

Tag-based access controls enable you to configure granular access to specific resources based on assigned resource tags. You can configure tag-based access controls by using the API/SDK or within the Amazon Connect console (for supported resources).

Tag-based access control using the API/SDK

To use tags to control access to resources within your AWS accounts, you need to provide tag information in the condition element of an IAM policy. For example, to control access to your Voice ID domain based on the tags you've assigned to it, use the `aws:ResourceTag/key-name` condition key, along with a specific operator like `StringEquals` to specify which tag `key:value` pair must be attached to the domain, in order to allow given actions for it.

For more detailed information on tag-based access control, see [Controlling access to AWS resources using tags](#) in the IAM User Guide.

Tag-based access control using the Amazon Connect console

A *resource* tag is a custom metadata label that you can add to a resource in order to make it easier to identify, organize, and find in a search. You can apply tags programmatically using the Amazon Connect SDK/APIs, and for certain resources you can apply tags from within the Amazon Connect console. To learn more about resource tags, see [Tag resources in Amazon Connect](#).

An access control tag is similar to a resource tag in that it uses the same *Key:value* structure. However, the distinction with an access control tag is that it introduces authorization controls that limit a user's access, to only specified resources containing resource tags with identical *Key:value* pairs. Access control tags are defined within security profiles, by first selecting the resource (routing profile, queue, users, etc.) for which to control access to, and then defining the *Key:value* pair to match on. Once a security profile with access control tags has been applied to a user, it will limit the user's access based on the defined combination of the selected resource(s) and access control tag(s) (*Key:value*). Without access control tags applied, a user will be able to see all resources if given permission to do so.

To use tags to control access to resources within the admin website of your Amazon Connect instance, you need to configure the access control section within a given security profile. For example, to control access to a routing profile based on the tags you've assigned to it, you would specify the routing profile as an access controlled resource, and then specify which tag *Key:value* pair you would like to enable access to.

Configuration limitations

Access control tags are configured on a security profile. You can configure up to 4 access control tags on a single security profile. Adding additional access control tags will make that security profile more restrictive. For example, if you were to add two access control tags like `Department :X` and `Country :Y`, the user would only be able to see resources containing both tags.

Users can be assigned a maximum of two security profiles that contain access control tags. When multiple security profiles containing access control tags are assigned to a single user, the tag-based access controls become less restrictive. For example, if a user had one security profile with an access control tag like `Country :USA`, and another security profile with an access control tag like `Country :Argentina`, a user would be able to see resources tagged with `Country :USA` or `Country :Argentina`. A user can have other security profiles, as long as those additional security profiles do not contain tags. If multiple security profiles are present with overlapping resource permissions, the security profile without tag-based access controls will be enforced over the one with tag-based access controls.

Service linked roles are required in order to configure [resource tags](#) or [access control tags](#). If your instance was created after October 2018, this will be available by default with your Amazon Connect instance. However if you have an older instance, refer to [Use service-linked roles for Amazon Connect](#) for instructions for how to enable service linked roles.

Best practices for applying tag-based access controls

Applying tag-based access controls is an advanced configuration feature that is supported by Amazon Connect and that follows the AWS shared responsibility model. It is important to ensure that you are correctly configuring your instance to comply with your desired authorization needs. For more information, review the [AWS shared responsibilities model](#).

Ensure that you have enabled at least *view* permissions for the resources that you enable tag-based access control for. This will ensure that you avoid permission inconsistencies that result in denied access requests.

Tag-based access controls are enabled at the resource level, which means that each resource can be restricted independently. In certain use cases this may be acceptable but it is considered best practice to enable tag-based access controls to all resources together. For example, enabling access to users but not security profiles, would allow a user to create a security profile with privileges that supersede your intended user access control settings.

When logged in to the Amazon Connect console with tag-based access controls applied, users will not be able to access historical change logs for the resources that they are restricted on.

As a best practice, you should disable access to the following resources/modules when applying tag-based access controls within the Amazon Connect console. If you do not disable access to these resources, users with tag-based access controls on a particular resource that view these pages may see an unrestricted list of users, security profiles, routing profiles, queues, flows, or flow modules. For more information on how to manage permissions, see [List of security profile permissions](#).

Modules	Permission to disable access
Contact search	Contact Search
Dashboard	Access metrics
Flows	Flows - View
Flow modules	Flow modules - View
Forecasting	Forecasting
Historical changes/Audit portal	Access metrics
Hours of operation	Hours of operation - View
Login/Login out report	Login/Logout report - View
Outbound Campaign	Campaigns - View
Prompts	Prompts - View
Quick connect	Quick connects - View
Rules	Rules - View
Saved reports	Saved reports - View
Scheduling	Schedule manager
Scheduling	Published schedule calendar

Hierarchy access control (Preview)

This is prerelease documentation for a service in preview release. It is subject to change.

You can restrict access to contacts based on the agent hierarchy assigned to a user. This is accomplished by using permissions such as [Restrict Contact Access](#). In addition to these permissions, hierarchies can also be used to enforce granular access controls for resources, such as users, in conjunction with tags. The remainder of this page contains additional details on configuring hierarchy-based access controls (currently in preview).

Background

Hierarchy-based access control enables you to configure granular access to specific resources based on the [agent hierarchy](#) assigned to a user. You can configure hierarchy-based access controls by using the API/SDK or within the Amazon Connect console for supported resources.

Currently, the only resource that supports hierarchy-based access control is Users. This authorization model works in conjunction with [tag-based access control](#), allowing you to restrict access to users, so that they can only see other users belonging to their hierarchy group and who have specific tags associated to them.

Hierarchy-based access control using the API/SDK

In order to use hierarchies to control access to resources within your AWS accounts, you need to provide the hierarchy's information in the condition element of an IAM policy. For example, to control access to a User belonging to a specific hierarchy, use the `connect:HierarchyGroupL3Id/hierarchyGroupId` condition key, along with a specific operator like `StringEquals` to specify which hierarchy group the user must belong to, in order to allow given actions for it. The supported condition keys are:

1. `connect:HierarchyGroupL1Id/hierarchyGroupId`
2. `connect:HierarchyGroupL2Id/hierarchyGroupId`
3. `connect:HierarchyGroupL3Id/hierarchyGroupId`
4. `connect:HierarchyGroupL4Id/hierarchyGroupId`
5. `connect:HierarchyGroupL5Id/hierarchyGroupId`

Each represents the id of a given hierarchy group in a specific level of the User's hierarchy structure.

For more detailed information on hierarchy-based access control, see [Controlling access to AWS resources using tags](#) in the IAM User Guide.

Hierarchy-based access control using the Amazon Connect console

To use hierarchies to control access to resources within the admin website of your Amazon Connect instance, you need to configure the access control section within a given security profile. For example, to enable granular access control access for a given user based on the hierarchy they belong to, you would need to configure the user as an access controlled resource. In this case, you will have two options:

1. Enforce hierarchy-based access control based on **the user's hierarchy**: This will ensure that the user being given access can only manage users that belong to his hierarchy. For example, enabling this configuration for a given user will enable them to manage other users that either belong to their hierarchy group or a child hierarchy group. This will ensure that the user being given access can only manage users that belong to his hierarchy. For example, enabling this configuration for a supervisor will enable them to manage other users that either belong to their hierarchy group or a child hierarchy group.
2. Enforce hierarchy-based access control based on **a specific hierarchy**: This will ensure that the user being given access can only manage users that belong to the hierarchy defined in the Security Profile. For example, enabling this configuration for a given user will enable them to manage other users that either belong to the hierarchy group specified in the Security Profile or a child hierarchy group.

Configuration limitations

Granular access control is configured on a security profile. Users can be assigned a maximum of two security profiles that enforce granular access control. In this case, the permissions will become less restrictive and act as a union of both permission sets. For instance, if one Security Profile enforces hierarchy-based access control and another one enforces tag-based access control, the user will be able to manage any user that belongs to the same hierarchy or tagged with the given tag. If both tag-based and hierarchy-based access control are configured as part of the same Security Profile, both conditions will need to be met. In this case, the user will only be able to manage users that belong to the same hierarchy and tagged with a given tag.

A user can have more than two security profiles, as long as those additional security profiles do not enforce granular access control. If multiple security profiles are present with overlapping resource

permissions, the security profile without hierarchy-based access control will be enforced over the one with hierarchy-based access control.

Service linked roles are required in order to configure hierarchy-based access control. If your instance was created after October 2018, this will be available by default with your Amazon Connect instance. However, if you have an older instance, refer to [Use service-linked roles for Amazon Connect](#) for instructions for how to enable service linked roles.

Best practices for applying hierarchy-based access controls

Applying hierarchy-based access control is an advanced configuration feature that is supported by Amazon Connect and that follows the AWS shared responsibility model. It is important to ensure that you are correctly configuring your instance to comply with your desired authorization needs. For more information, review the [AWS shared responsibility model](#).

Ensure that you have enabled at least *view* permissions for the resources that you enable hierarchy-based access control for. This will ensure that you avoid permission inconsistencies that result in denied access requests. Hierarchy-based access controls are enabled at the resource level, which means that each resource can be restricted independently. It is important to carefully review the permissions that are granted when hierarchy-based access control is enforced. For example, enabling hierarchy restricted access to users and view/edit permissions security profiles, would allow a user to create/update a security profile with privileges that supersede the intended user access control settings.

When logged in to the Amazon Connect console with hierarchy-based access controls applied, users will not be able to access historical change logs for the resources that they are restricted on.

When trying to assign a child resource to a parent resource with hierarchy-based access control on the child resource, the operation will be denied if the child resource does not belong to your hierarchy. For example, if you try to assign a User to a Quick Connect but you don't have access to the user's hierarchy, the operation will fail. This is however not true for disassociations. You would be able to disassociate a user freely even with hierarchy-based access control enforced assuming you have access to the Quick Connect. This is because disassociations are about discarding an existing relation (as opposed to new associations) between two resources and is modeled as part of the parent resource (in this case, the Quick Connect), which the user already has access to. As such when enforcing hierarchy-based access control on a user resource, it is important to be thoughtful about the permissions granted on parent resources since a user could be disassociated without his or his supervisor's knowledge.

As a best practice, you should disable access to the following resources/modules when applying hierarchy-based access controls within the Amazon Connect console. If you do not disable access to these resources, users with hierarchy-based access controls on a particular resource that view these pages may see an unrestricted list of users. For more information on how to manage permissions, see [List of security profile permissions](#).

Modules	Permission to disable access
Contact search	Contact search - View
Historical changes/Audit portal	Access metrics - Access
Real-time metrics	Real-time metrics - Access
Historical metrics	Historical metrics - Access
Login/Login out report	Login/Login out report - View
Rules	Rules - View
Saved reports	Saved reports - View
Agent Hierarchy	Agent Hierarchy - View
Flow/Flow module	Flow modules - View
Scheduling	Schedule manager - View

Set up routing

In Amazon Connect, routing consists of three parts: queues, routing profiles, and flows. This topic discusses queues and routing profiles. For information about flows, see [Create Amazon Connect Flows](#).

A queue holds contacts waiting to be answered by agents. You can use a single queue to handle all incoming contacts, or you can set up multiple queues.

Queues are linked to agents through a routing profile. When you create a routing profile, you specify:

- Which queues will be in it.
- Whether one queue should be prioritized over another.
- What channels agents will handle in the Contact Control Panel (CCP).
- How many contacts agents can handle simultaneously for each channel.
- Whether individual queues are for all channels or specific ones.

Each agent is assigned to one routing profile.

Contents

- [How routing works](#)
- [Create a queue](#)
- [Disable a queue](#)
- [Delete a queue](#)
- [Set the Maximum contacts in queue limit](#)
- [Set the hours of operation and timezone for a queue](#)
- [Create a routing profile](#)
- [Delete a routing profile](#)
- [Set up queue-based \(skills-based\) routing](#)
- [Routing using agent proficiencies](#)

How routing works

Contacts are routed through your contact center based on these factors:

- The routing profile an agent is assigned to.
- The hours of operation for a given queue.
- The routing logic you define in your flows.

For example, you use routing profiles to route specific types of contacts to agents with specific skill sets. If no agent with the required skill set is available, you can place the contact in the queue defined in the flow.

Here's the logic Amazon Connect uses to route contacts:

- Contacts in a queue are automatically prioritized and forwarded to the next available agent (that is, the agent who has been idle longest).
- Contacts are placed on hold if there are no available agents. The order in which they are serviced is determined by their time in queue, on a first-come, first-served basis.
- If multiple agents are ready for a contact, by default an inbound contact is routed to the agent who has been in the **Available** status for the longest time.

Handling either inbound or outbound contacts causes agents to drop to the bottom of the list for inbound contacts. You can set up your [routing profile](#) to ignore outbound contacts in this calculation by choosing the **Outbound calls should not impact routing order** option. Consider choosing this option if your organization wants agents to take outbound calls and still get a fair share of inbound contacts.

For example:

- Joe is third in line for inbound contacts, which are preferable to outbound contacts because he knows he will speak to someone, and that increases his odds of getting recognition in his role. Because he is idle, Joe decides to make an outbound contact to chip away at the backlog. He may or may not reach someone.
- By default, when Joe makes the outbound contact, he moves from third in line to the bottom of the list of agents waiting to receive an inbound contact. (If there are 10 agents, he is moved to 10th place). If instead he should remain in third place, you can override the default behavior.
- A routing profile may assign a priority to one queue over another, but the priority within the queue is always set by the order the contact was added to the queue.

How routing transfers works

As the previous section explains, the order in which contacts in queue are handled in Amazon Connect depends on multiple factors, including the enqueue time, routing age adjustment, and contact priority. In the case of contacts that experience a transfer, however, Amazon Connect handles the routing age adjustment slightly differently: it depends on whether the contact was transferred by an agent, or if it was transferred by a queue-to-queue transfer in a flow or an API.

The following two scenarios demonstrate how Amazon Connect handles the routing age adjustment.

- **Agent transfers the contact using a quick connect:** A contact is originally enqueued at time **X** and is then handled by an agent. The agent then transfers it back to a queue using a quick connect at time **Y**. In this scenario:
 - The original enqueue time **X** is used to calculate the order in which this contact is ranked in the subsequent queue.
 - Any routing age adjustments are applied relative to that contact enqueue time.
- **Queue-to-queue transfer:** A contact was in a queue from time **S** and is eventually transferred to a different queue at time **T**. In this scenario:
 - The new enqueue time **T** is used to calculate the order in which the contact is ranked.
 - Any routing age adjustments are applied relative to that contact enqueue time.

How routing works with multiple channels

When you set up a routing profile to handle multiple channels, you must specify whether agents can handle contacts while already on another channel. This is called cross-channel concurrency.

When using cross-channel concurrency, Amazon Connect checks which contact to offer the agent as follows:

1. It checks what contacts/channels the agent is currently handling.
2. Based on what channels they are currently handling, and the cross-channel configuration in the agent's routing profile, it determines whether the agent can be routed the next contact.

For a detailed example of how Amazon Connect routes contacts when cross-channel concurrency is set up, see [Example of how a contact is routed with cross-channel concurrency](#).

Learn more about routing

See the following topics to learn more about routing:

- [Concepts: Routing profiles](#)
- [Concepts: Queue-based routing](#)
- [Set up queue-based routing](#)

Create a queue

This topic explains how to create a queue using the Amazon Connect console. To create queues programmatically, see the [create-queue](#) AWS CLI or [CreateQueue](#) in the *Amazon Connect API Reference*.

How many queues can I create? To view your quota of **Queues per instance**, open the Service Quotas console at <https://console.aws.amazon.com/servicequotas/>.

To create a queue

1. Log in to the Amazon Connect admin website at [https://*instance name*.my.connect.aws/](https://instance_name.my.connect.aws/).. Use an **Admin** account, or an account that has **Routing - Create queues** security profile permissions.
2. In Amazon Connect, on the navigation menu, choose **Routing, Queues, Add new queue**.
3. Add the appropriate information about your queue and choose **Add new queue**.

Amazon Connect

Queues > Edit BasicQueue

Edit BasicQueue

Queue Details

Name	Description
BasicQueue	A simple, basic voice queue.
Required	
10 / 127	28 / 250

Hours of operation

Set the hours of operation and timezone for a queue. [Learn more.](#)

Search hours of operation

Basic Hours

Required

[Show additional queue information](#)

Settings

Outbound caller configuration

Set the default caller ID name that will display to customers. [Learn more.](#)

Default caller ID name	Outbound caller ID number	Outbound whisper flow
Callback ID name	Search for phone numbers +1 360-230-7842	Search for contact flow
0 / 255		

Quick connects

Choose the quick connects that agents who are working this queue will see in their CCP. [Learn more.](#)

Search for quick connects

See the following topics for detailed information about each of the above areas:

1. [Set the hours of operation and timezone for a queue](#)
2. [Set up outbound caller ID](#)
3. [Set the Maximum contacts in queue limit](#)
4. [Create quick connects](#)

The queue is automatically active.

4. Assign the queue to a routing profile; for information, see [Create a routing profile](#). The routing profile links the queue and agents together.
5. Add Tags to identify, organize, search for, filter and control who can access this queue. For more information, see [Tag resources in Amazon Connect](#).

To learn how queues work, see [Concepts: Routing profiles](#) and [Concepts: Queue-based routing](#).

Disable a queue

You can quickly control the flow of contacts to queues by temporarily disabling a queue. When a queue is disabled, it's put in an offline mode. No new contacts are routed to the queue, but any existing contacts already in the queue are routed to agents.

Only users who have a security profile with **Queues - Enable/Disable** permissions can disable a queue.

Security profile permissions					
Routing ⓘ					
Type	All	View	Edit	Create	Enable / Disable
Routing profiles	<input type="checkbox"/>	<input type="checkbox"/>	<input type="checkbox"/>	<input type="checkbox"/>	<input type="checkbox"/>
Quick connects	<input type="checkbox"/>	<input type="checkbox"/>	<input type="checkbox"/>	<input type="checkbox"/>	<input type="checkbox"/>
Hours of operation	<input type="checkbox"/>	<input type="checkbox"/>	<input type="checkbox"/>	<input type="checkbox"/>	<input type="checkbox"/>
Queues	<input type="checkbox"/>	<input checked="" type="checkbox"/>	<input checked="" type="checkbox"/>	<input type="checkbox"/>	<input checked="" type="checkbox"/>

To disable an active queue

1. On the navigation menu, choose **Routing, Queues**.
2. Hover over the name of the queue to edit. Choose the power icon that appears.

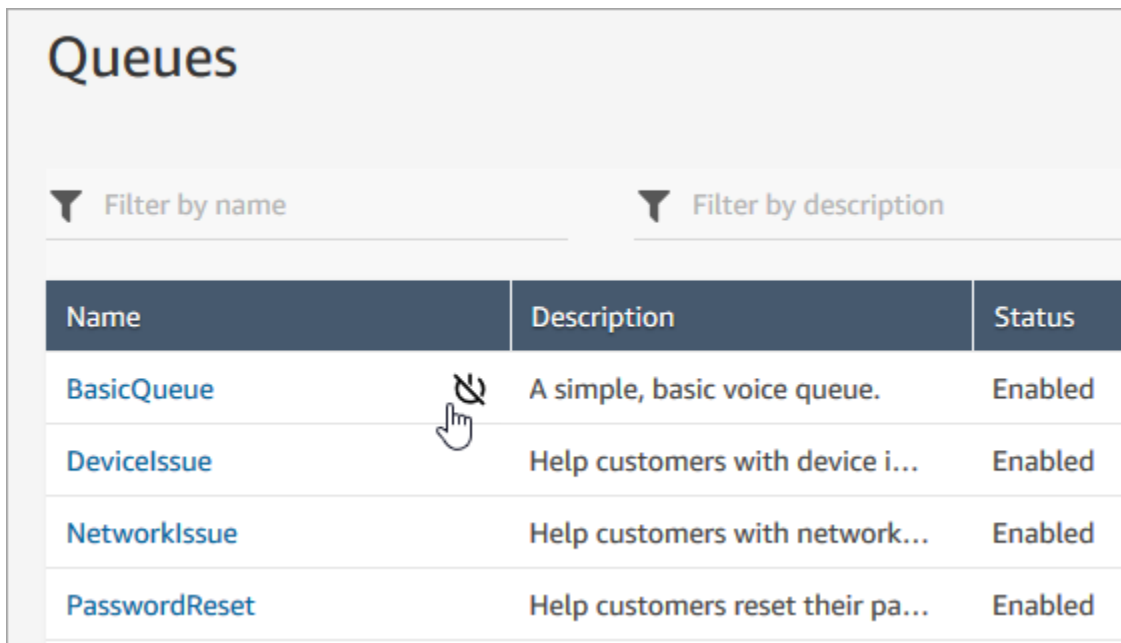

Name	Description	Status
BasicQueue	A simple, basic voice queue.	Enabled
DeviceIssue	Help customers with device i...	Enabled
NetworkIssue	Help customers with network...	Enabled
PasswordReset	Help customers reset their pa...	Enabled

3. Choose **Disable** to confirm you want to disable the queue. You can immediately re-enable the queue if needed by choosing the power button again.

Delete a queue

To delete a queue from your Amazon Connect instance, use the [DeleteQueue](#) API or the [delete-queue](#) AWS CLI.

It isn't possible to delete a queue by using the Amazon Connect admin website.

Set the Maximum contacts in queue limit

By default a queue can contain up to your [service quota](#) for voice, chat, and tasks:

- **Concurrent active calls per instance**
- **Concurrent active chats per instance (includes SMS)**
- **Concurrent active tasks per instance**

To increase one of these quotas, you must request a quota increase. For more information, see [Amazon Connect service quotas](#).

There may be situations where you want a specific queue to allow fewer contacts than the allowed quota. For example:

- You have a queue that is dedicated to calls about complicated issues that take an average of 15 minutes to resolve, you may want to limit the number of calls allowed in the queue to be less than **Concurrent active calls per instance**. This prevents customers from waiting for hours.
- You may have a queue dedicated to chats. Your service limit is 100 but you want only up to 20 chats at a time. You can set that value so Amazon Connect limits the number of active chats routed to that queue.
- You have a queue that combines more than one channel, and you set a custom value. Note that the queue stops accepting new contacts after that number is reached, regardless of the distribution of contacts. For example, if you set the value to 50, and the first 50 contacts are chats, then voice calls are not routed to this queue.

This topic explains how to reduce the allowed number of contacts in a queue for these situations.

Reduce the number of contacts allowed in a queue

To reduce the number of contacts allowed in a [standard queue](#) at the same time, you set the **Maximum contacts in queue** limit for the standard queue. This setting does not apply to [agent queues](#); those are always limited to 10 contacts.

Maximum contacts in queue

Set the maximum contacts allowed to be in the queue at the same time. This defines the routing decisions when a queue is full.

Set a limit across all channels

When you enter a number in **Maximum contacts in queue**, Amazon Connect validates that the number is less than the sum of your concurrent active contacts service quotas: **Concurrent calls per instance** + **Concurrent active chats per instance** + **Concurrent active tasks per instance**.

Important

- You must set **Maximum contacts in queue** to be less than the sum of the following quotas combined: **Concurrent calls per instance** + **Concurrent active chats per instance** + **Concurrent active tasks per instance**.
- Incoming calls and queued callbacks count towards the queue size limit.

For information about default service quotas and how to request an increase, see [Amazon Connect service quotas](#).

To reduce the number of contacts allowed in a specific queue

1. On the navigation menu, choose **Routing, Queues, Add new queue**. Or, edit an existing queue.
2. In **Maximum contacts in queue**, choose **Set a limit across all channels**. If the queue is also used for chats or tasks, then all three channels will be capped at the same maximum.
3. In the box, specify how many contacts can be in the queue before it's considered full. The value cannot exceed the sum of **Concurrent active calls per instance + Concurrent active chats per instance + Concurrent active tasks per instance**.

Maximum contacts in queue

Set the maximum contacts allowed to be in the queue at the same time. This defines the routing decisions when a queue is full.

Set a limit across all channels

Maximum contacts in queue

7

Required



What happens to calls when a queue is full

- Incoming calls: The next incoming call gets a reorder tone (also known as a fast busy tone), which indicates no transmission path to the called number is available.
- Queued callbacks: The next queued callback is routed down the error branch.

What happens if Maximum contacts in queue is set to 0

If you set **Maximum contacts in queue** to 0 it renders the queue unusable. The behavior is the same as when a queue is full.

Queue maximum limit exceptions

There are times when you can add more contacts to a queue than the set **Maximum contacts in queue** limit.

- There may be a slight delay between the time that a queue reaches its capacity limit and when this limit is enforced in the flow. This delay could cause incoming contacts to be queued during that time, particularly during bursts of traffic.

Additionally, Amazon Connect includes a 20 percent buffer to the queue capacity for the following exceptional scenarios:

- A contact was transformed into a Queued Callback, scheduled to be added to the queue at X time using the **Initial delay** setting in the flow. However, when the scheduled time arrived, the target queue had reached its **Maximum capacity in queue** limit. In this scenario, Amazon Connect allows the Queued Callback to be enqueued up to a 20 percent buffer of the **Maximum capacity in queue** limit for the queue.
- A contact, previously queued in Queue1, is now being transferred to Queue2 through the flow. However, when the transfer is attempted, Queue2 has already reached its **Maximum capacity in queue** limit. In this scenario, Amazon Connect allows the transfer to proceed, up to a 20 percent buffer of the **Maximum capacity in queue** limit for Queue2.
- An agent initiates a manual transfer of a contact into a queue through quick connects. However, when the transfer is attempted, the queue has already reached its **Maximum capacity in queue** limit. In this scenario, Amazon Connect allows the transfer to proceed, up to a 20 percent buffer of the **Maximum capacity in queue** limit.

Route contacts based on queue capacity

To define routing decisions based on queue capacity, use a [Transfer to queue](#) block to check whether a queue is full ([Maximum contacts in queue](#)), and then route the contact accordingly.

The [Transfer to queue](#) block checks the [Maximum contacts in queue](#). If no limit is set, the queue is limited to the number of total concurrent contacts for the following quotas:

- Active tasks per instance
- Concurrent calls per instance
- Concurrent chats per instance

Set the hours of operation and timezone for a queue

The first thing you need to do when you set up a queue is to specify the hours of operation and timezone. The hours may be referenced in flows. For example, when routing contacts to agents, you might use the [Check hours of operation](#) block first, and then route the contact to the appropriate queue.

How many hours of operation can I create? To view your quota of **Hours of operation per instance**, open the Service Quotas console at <https://console.aws.amazon.com/servicequotas/>.

To set the hours of operation and timezone for a queue

1. On the navigation menu, choose **Routing, Hours of operation**.
2. To create a template, choose **Add new set of hours** and enter a name and a description.
3. Choose **Time zone** and select a value.
4. Choose **Settings** to set new hours.
5. Optionally, in the **Tags** section, add tags to identify, organize, search for, or filter who can access this hours of operation record. For more information, see [Tag resources in Amazon Connect](#).
6. Choose **Save**.
7. Now you can specify these the hours of operation when you [create a queue](#), and check them in the [Check hours of operation](#) block.

How to specify midnight

To specify midnight, enter 12:00AM.







For example, if you want to set your hours to 10:00AM to midnight, you would enter: 10:00AM to 12:00AM. Your call center would be open for 14 hours. Here's the math:

- 10:00AM-12:00PM = 2 hours
- 12:00PM-12:00AM = 12 hours
- Total = 14 hours

Examples

Schedule for 24x7







Settings

Sunday + Add hour	Start time 12 : 00 AM	End time 12 : 00 AM	
Monday + Add hour	Start time 12 : 00 AM	End time 12 : 00 AM	
Tuesday + Add hour	Start time 12 : 00 AM	End time 12 : 00 AM	
Wednesday + Add hour	Start time 12 : 00 AM	End time 12 : 00 AM	
Thursday + Add hour	Start time 12 : 00 AM	End time 12 : 00 AM	
Friday + Add hour	Start time 12 : 00 AM	End time 12 : 00 AM	
Saturday + Add hour	Start time 12 : 00 AM	End time 12 : 00 AM	

Schedule for Monday to Friday 9:00 AM to 5:00 PM



Remove Sunday and Saturday from the schedule.

Settings

Sunday + Add hour	Start time 09:00 AM	End time 05:00 PM	
Monday + Add hour	Start time 09:00 AM	End time 05:00 PM	
Tuesday + Add hour	Start time 09:00 AM	End time 05:00 PM	
Wednesday + Add hour	Start time 09:00 AM	End time 05:00 PM	
Thursday + Add hour	Start time 09:00 AM	End time 05:00 PM	
Friday + Add hour	Start time 09:00 AM	End time 05:00 PM	
Saturday + Add hour	Start time 09:00 AM	End time 05:00 PM	

Add lunch and other breaks

If your entire contact center were to close for lunch from 12-1, for example, then you'd enter hours to specify that, as in the following image:

Monday + Add hour	Start time 09:00 AM	End time 12:00 PM	
	Start time 01:00 PM	End time 05:00 PM	

In most contact centers breaks are staggered. While some agents are at lunch, for example, others are still available to handle contacts. Instead of specifying this in the hours of operation, you [add custom agent statuses](#) that appear in the agent's Contact Control Panel (CCP).

For example, you might create a custom status named **Lunch**. When the agent goes to lunch, they change their status in the CCP from **Available** to **Lunch**. During this time, no contacts are routed to them. When they return from lunch and are ready to take contacts again, they change their status back to **Available**.

Supervisors can change an agent's status using the real-time metrics report.

For more information, see these topics:

- [Add custom agent status](#)
- [About agent status](#)
- [Change the "Agent activity" status in a real-time metrics report](#)

What happens during daylight saving time

Amazon Connect uses the timezone to determine whether daylight saving time is in effect for the queues, and **adjusts automatically** for all timezones that observe daylight saving time. When a contact comes in, Amazon Connect looks at the hours and timezone of your contact center to determine whether the contact can be routed to the given queue.

Important

Amazon Connect provides options for EST5EDT, PST8PDT, CST6CDT, and more. For example, EST5EDT is defined as:

[Eastern Standard Time \(EST\)](#) is used when observing standard time. It is five hours behind Coordinated Universal Time (UTC).

[Eastern Daylight Time \(EDT\)](#) is used when observing daylight saving time. It is four hours behind Coordinated Universal Time (UTC).

We recommend researching your choice of timezone to ensure you understand it.

Example

1. A person initiates a call or chat with your contact center.
2. Amazon Connect looks at the hours of operation for your call center right now.
 - The contact is from timezone A.
 - Your call center's hours are 9 AM - 5 PM in timezone B.

- If the current time in timezone B is 2 PM then the call or chat is queued.
- If the current time in timezone B is 7 AM then the call or chat is not queued.

Use the Check Hours of Operation block

At the start of your flows, use the [Check hours of operation](#) block to determine whether your contact center is open, and to branch accordingly.

Create a routing profile

While queues are a 'waiting area' for contacts, a routing profile links queues to agents. When you create a routing profile, you specify:

- **Channels:** Which channels—voice, chat, task—are routed to this group of agents; whether to allow channels concurrently.
- **Queues:** Which queues are in the routing profile; whether one queue should be prioritized over another.

Each agent is assigned to one routing profile. For more information about routing profiles and queues, see [Concepts: Routing profiles](#).

How many routing profiles can I create? To view your quota of **Routing profiles per instance**, open the Service Quotas console at <https://console.aws.amazon.com/servicequotas/>.

To create a routing profile

1. On the navigation menu, choose **Users, Routing profiles, Add routing profile**.
2. In the **Routing Profile Details** section, in the **Name** box, enter a searchable display name. In the **Description** box, enter what the profile is used for.
3. In the **Channel Settings** section, enter or choose the following information:

Item	Description
Channel availability	Choose which types of contacts will be routed to agents who are assigned to this routing profile.

Item	Description	
Maximum contacts per agent	For chat and task channels, specify how many contacts that an agent can handle simultaneously, up to 10.	
Cross-channel concurrency	<p>Choose one of the following options:</p> <ul style="list-style-type: none"> • No other channels while agent is on <i>channel</i>. For example, while an agent is on a chat, they will not receive a voice contact or a task. • Allow other channel concurrently. For example, while an agent is on a voice contact, they can be offered contacts from any other channels enabled in the routing profile, such as chats and tasks. <p>See Example of how a contact is routed with cross-channel concurrency.</p>	

4. In the **Queues** section, enter the following information:

Item	Description	
Name	Use the dropdown menu or text field to choose a queue that you've already	

Item	Description	
	set up. You can add multiple queues to a routing profile.	
Channels	<p>Choose whether the queue is for chat, voice, task, or all three.</p> <div data-bbox="634 512 1052 1066"><p>⚠ Important</p><p>The channel that you specify here must also be specified in the Channel Settings section. If it isn't, contacts from that channel won't be routed to agents.</p></div>	
Priority	Specify the order in which contacts are to be handled for that queue. For example, a contact in a queue with a priority of 2 would be a lower priority than a contact in a queue with a priority of 1.	

Item	Description	
Delay (in seconds)	<p>Enter the minimum amount of time a contact should be in the queue before they are routed to an available agent.</p> <p>To learn more about how Priority and Delay work together, see Concepts: Queues priority and delay.</p>	
Default outbound queue	Choose a queue to be associated with outbound calls placed by the agents.	
Set routing order	<p>By default Amazon Connect routes new contacts to agents that have been in Available status the longest. You can customize this behavior, for example, to change the impact that outbound contacts have on the assignment of new inbound contacts.</p>	

Item	Description	
Outbound calls should not impact routing order	<p>Use this setting if you don't want agents who make outbound contacts to move to the bottom of the list for receiving inbound contacts.</p> <p>By default new contacts are routed to the agent who has been in Available status longest. By making an outbound contact, the agent drops to the bottom of the list waiting for inbound contacts. You can use this setting to override that default logic and ensure that agents making outbound contacts still get their fair share of inbound contacts.</p>	

5. Optionally, add Tags to identify, organize, search for, filter, and control who can access this hours of operation record. For more information, see [Tag resources in Amazon Connect](#).
6. Choose **Save**.

Tips for setting up channels and concurrency

- Use **Channel availability** to toggle on and off whether agents assigned to a profile get voice, chat, and task contacts.

For example, there are 20 queues assigned to a profile. All of the queues are enabled for voice, chat, and task. By removing the **Voice** option at the routing profile level, you can stop all voice calls to these agents, across all queues in the profile. When you want to restart voice contacts for these agents again, select **Voice**.

- When using **Cross-channel concurrency**, Amazon Connect checks which contact to offer the agent as follows:
 1. It checks what contacts/channels the agent is currently handling.
 2. Based on what channels they are currently handling, and the cross-channel configuration in the agent's routing profile, it determines whether the agent can be routed the next contact.
 3. Amazon Connect prioritizes the longest waiting contact if Priority and Delay are equal. Even though it's evaluating multiple channels at the same time, First-In First-Out is still respected.

See [Example of how a contact is routed with cross-channel concurrency](#).

- For each queue in the profile, choose whether it's for voice, chat, task, or all three.
- If you want a queue to handle voice, chat, and task, but want to assign a different priority to each channel, add the queue twice. For example, in the following image, voice is priority 1 but chat and task are priority 2.

Queues					
Assign queue(s) to routing profiles in priority sequence; add delay to give other routing profiles a chance to manage those contacts first. Learn more Delete Queue Add Queue					
<input type="checkbox"/>	Name	Channels	Priority ⓘ	Delay (seconds) ⓘ	Delete
<input type="checkbox"/>	BasicQueue ✕	<input checked="" type="checkbox"/> Voice <input type="checkbox"/> Chat <input type="checkbox"/> Task	1	0	
<input type="checkbox"/>	BasicQueue ✕	<input type="checkbox"/> Voice <input checked="" type="checkbox"/> Chat <input checked="" type="checkbox"/> Task	2	0	

Example of how a contact is routed with cross-channel concurrency

For example, assume an agent is assigned to the routing profile that has the channel settings shown in the following image. They can be routed voice, chat, and task contacts. They can receive cross-channel contacts when on tasks.

Channel Settings			
Define the channels that can be routed to this group of agents. Set the maximum number of contacts of each type that an agent can handle at one time. Indicate if an agent who is on one channel can be routed new contacts from another channel. Learn more			
<input type="checkbox"/>	Channel availability	Maximum contacts per agent ⓘ	Cross-channel concurrency ⓘ
<input checked="" type="checkbox"/>	Voice	1	No other channels while agent is on a Voice contact ▼
<input checked="" type="checkbox"/>	Chat	2	No other channels while agent is on a Chat ▼
<input checked="" type="checkbox"/>	Task	1	Allow other channels concurrently ▼

The agent will experience the following routing behavior:

1. Assume the agent is fully idle. Next, the agent accepts a chat and begins working on it. Meanwhile, a task comes into queue.
 - Chat is set to **No other channels allowed**.
 - So even though there is a task in queue, it will not be offered to this agent.
2. Next, there is a chat in queue.
 - The agent's maximum chat concurrency is 2, so they are routed another chat for total of 2 chats. The agent continues working on both of the chats.
3. There are no other chats in queue. The agent finishes both chats (closes ACW).
 - There is still a task waiting in queue.
 - At this point, the task is offered to the agent because they are fully idle again. The agent begins working the task.
4. Another chat comes into queue.
 - Tasks is set to **Allow other channels concurrently**. So, even though the agent is already working on a task, they can still be offered the chat.
 - The chat gets routed to the agent, who now works on both the 1 chat and 1 task concurrently.
5. Now there is a Voice call in queue.
 - The agent is still working on 1 chat and 1 task.
 - Even though **Task** is set to **Allow other channels concurrently**, the agent is still working on 1 chat, and **Chat** is set to **No other channels while agent is on a Chat contact**. So, the voice call is not routed to the agent. The agent continues working on both the chat and the task.
6. The agent completes the chat, but still works on the task.
 - Now, because the only contact still assigned to the agent is a task, and **Tasks** are set to **Allow other channels concurrently**, this means that the agent can be offered the voice call.
 - The agent picks up the voice call and is now working concurrently on both the voice call and the task.
7. Now there is another task in queue.
 - The agent is currently working on a voice call AND a task. Once again, Amazon Connect checks the cross channel settings and Voice is set to **No other channels while agent is on a Voice contact**.
 - Because the agent is working on a voice call, they cannot be offered any tasks until they are done with the voice call.

- Also, because **Task** is set to **Maximum contacts per agent** is 1, even after the agent handles the voice call, they still won't be offered the task until they finish their current task.

Delete a routing profile

To delete a routing profile from your Amazon Connect instance, use the [DeleteRoutingProfile](#) API or the [delete-routing-profile](#) AWS CLI.

It isn't possible to delete a routing profile by using the Amazon Connect admin website.

Set up queue-based (skills-based) routing

Here's an overview of the steps to set up queue-based routing:

- [Create the queues](#), for example, one for each skill you want to use for routing.
- [Create the routing profiles](#):
 - Specify the channels supported by this routing profile.
 - Specify the queues: the channel, priority, and delay.
- [Configure agent settings](#) to assign the routing profiles to them.

When you [create your flows](#), you'll add the queues to them. If a contact chooses to speak to an agent in Spanish, for example, they will be routed to the Spanish Reservations queue.

For information about how routing works, and queue-based routing, see these topics:

- [How routing works with multiple channels](#)
- [Concepts: Queue-based routing](#)

Routing using agent proficiencies

Routing using proficiencies is achieved by using the standard queue based routing construct. For more information on routing, see [How routing works](#).

Routing using agent proficiencies is set up in 4 steps

- [Predefined attributes](#)

- In this step you can define the routing relevant predefined attributes that you want to use to make a routing decision. The predefined attributes created here can be used individually or combined using the AND or OR operators to form a routing step.
- [Assign proficiencies to agents](#)
 - You can select predefined attributes and associate them with an agent. All available agents that meet a routing step requirement of a contact within the same queue will be considered for a match.
- [Set routing criteria](#)
 - Using a flow block, you can set a routing criteria manually or dynamically.
- [Transfer to queue](#)

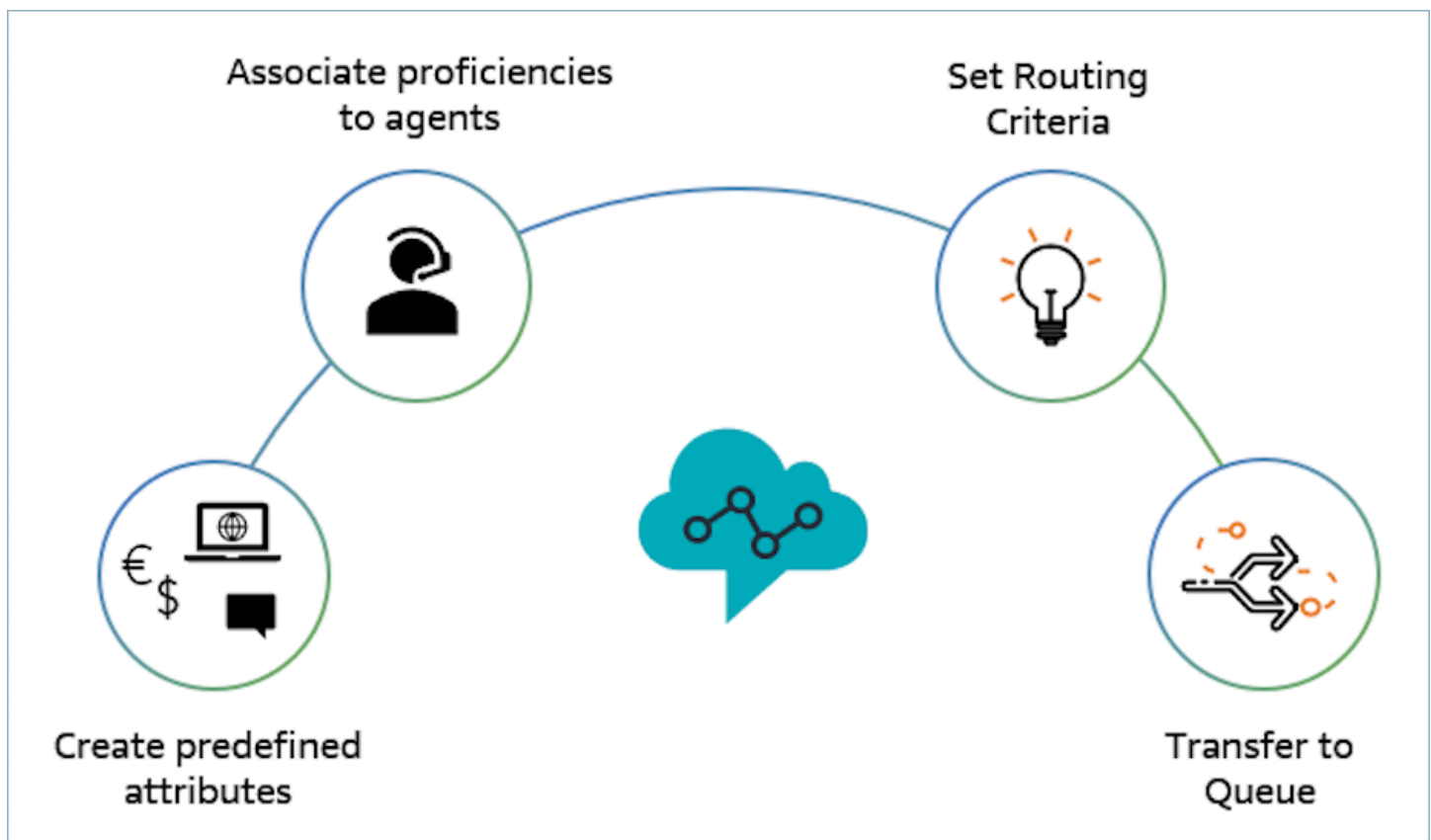

Example of how to use agent proficiencies for routing

Consider a scenario where a contact enters a queue **General Inbound Queue** and two agents, Agent1 and Agent2, are available. A customer who speaks French is seeking assistance regarding AWS DynamoDB. This is their second time calling regarding the same issue and you would prefer to

match them with an expert in AWS DynamoDB. In order to preserve the customer experience, you wish to follow the following routing requirements:

- First look for an agent who is highly proficient in **French (>=4)** and an expert in **AWS DynamoDB (>=5)** for the first 30 seconds.
- If an agent is not found at this time, look for an agent who is highly proficient in **French (>=3)** and highly proficient in **AWS DynamoDB (>=5)** for the next 30 seconds. The requirement for French is relaxed to further expand the pool of eligible agents to meet the requirement.
- If no join is made at this point, look for an agent who is proficient in **French (>=3)** and highly proficient in **AWS DynamoDB (>=4)** and keep looking until an agent is found. Here the AWS DynamoDB requirement is relaxed to expand the pool of eligible agents who meet the requirement.

 **Note**

For regulatory or compliance use cases you can use the **Never Expire** option for the expiration timer to ensure any agent who is joined on the contact meets a minimum requirement.

To route the contact to the above requirements, use the following steps:

1. **Create Predefined Attributes:** For example, add Technology as a predefined attribute in **User Management, Predefined Attributes** with AWS DynamoDB as one of the values.

Name	Value
Technology	AWS Kinesis
Technology	AWS DynamoDB
Technology	AWS EC2
Technology	AWS Neptune

Note

Connect:French is already available as a value in system attribute **Connect:Language** as a predefined attribute. You can use this in your routing criteria. You can also add up to 128 customer languages as values to **Connect:Language**.

2. **Associate proficiencies to users:** We have 2 agents, Agent1 and Agent 2, who speak French and are proficient in AWS DynamoDB as shown below. In **User Management, Show Advanced Settings** associate the following proficiencies to the Agent1 and Agent2.

Agent Name	Predefined Attribute	Value	Proficiency Level
Agent1	Technology	AWS Kinesis	2
Agent1	Technology	AWS Dynamo DB	5
Agent1	Technology	AWS EC2	4
Agent1	Language	French	3
Agent1	Language	English	4
Agent2	Technology	AWS Dynamo DB	3
Agent2	Technology	AWS EC2	5
Agent2	Technology	AWS Neptune	5
Agent2	Language	French	4
Agent2	Language	English	3

3. **Set routing criteria:** In the Set routing criteria Flow block, you can create the following routing criteria manually or dynamically using JSON that is created by invoking a Lambda function as shown in a potential Inbound flow. Create the following routing criteria:
- Step 1: `connect:Language(connect:French) >=4 AND Technology (AWS DynamoDB) >=5`
[30 seconds]

- b. Step 2: connect:Language(connect:French) >=4 **AND** Technology (AWS DynamoDB) >=4
[30 seconds]
- c. Step 3: connect:Language(connect:French) >=3 **AND** Technology (AWS DynamoDB) >=4
[Never expire]

The following is an example of an inbound flow where this can be configured

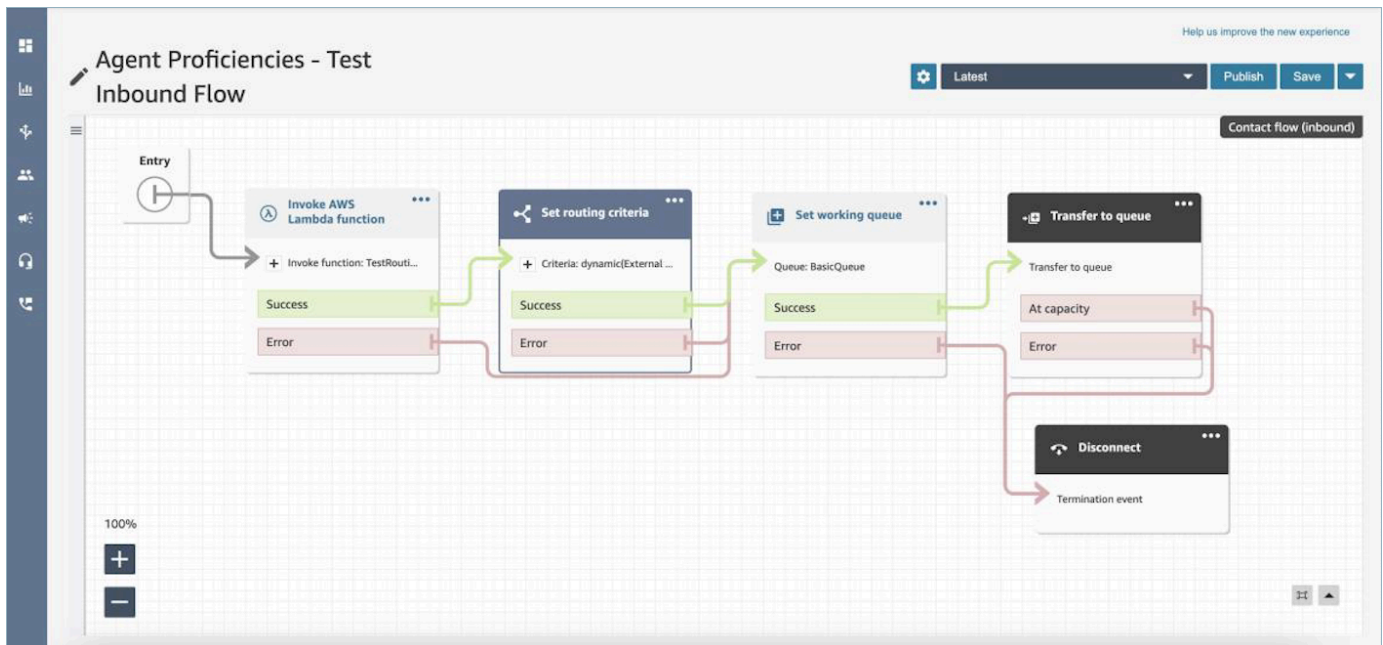

4. **Transfer to queue:** Once the contact is transferred to the “General Inbound Queue”, Connect will immediately start executing the routing criteria. The following steps will occur before the contact is joined to Agent1.
 - a. **Routing Step 1:** For the first 30 seconds (no match) as neither agent has an AWS DynamoDB proficiency >= 5, Connect will not match with any agent.
 - b. **Routing Step 2:** In the next 30 seconds (no match) as neither agent is both highly proficient (>=4) in both French and AWS DynamoDB
 - c. **Routing Step 3:** As soon as the previous step expires, Connect will find the available agent, Agent1 (French 3, AWS DynamoDB 4) is proficient in French and highly proficient in AWS DynamoDB. Therefore, the contact will be matched with Agent1.

There is a [one-click drill-down](#) in the real-time metrics for queues table which shows you a list of the routing steps in use for active contacts on the queue. You can find the definitions for the routing step specific metrics under [Real-time metrics definitions](#).

Contact Record, Contact Event Stream, and Agent Event Stream updates for agent proficiencies

Models have been added for proficiency routing in the following sections:

- [Contact records data model](#)
- [Agent event streams data model](#)
- [Contact events data model](#)

Frequently asked questions

- **Are queues still relevant?**
 - Yes, queues are still necessary. The routing criteria is only activated when a contact is enqueued. Agent proficiencies provide additional control to target specific agents within a queue.
- **When should we model something as a proficiency instead of modeling it as a queue?**
 - This is a business decision. You should consider the impact on the number of queues you can eliminate and consolidate while using agent proficiencies.
- **Does agent proficiencies work across all channels?**
 - Yes, routing using agent proficiencies will work for all channels.
- **How do I remove a routing criteria?**
 - You can interrupt a routing criteria using a customer queue flow.
 - You can also update the routing criteria this way.
- **How many times can I change a routing criteria?**
 - You can change the routing criteria a maximum of 2 times, for example, a contact can have a total of 3 routing criteria. If you still need to change the routing criteria after that, you will need to change the queue (or transfer back to the same queue) which will form a new contact.
- **With agent proficiencies, will queue priority and delay operate as usual?**
 - Yes, queue priority and delay will operate as they do in a non-agent-proficiencies environment.
- **Which operators are supported for creating a routing criteria?**
 - The following Boolean operators are supported.
 - AND
 - OR (only 1 and this is restricted to routing criteria using the dynamic creation option only.)

- The following comparison operators are supported.
 - >=
- **Which characters can be used for predefined attributes?**
 - The pattern for predefined attribute name and value is `^(?! (aws: | connect:)) [\p{L}\p{Z}\p{N}_. :/=+ -@']+$`. For example, it can contain any letter, numeric value, whitespace, or `_. :/=+ -@'` special characters, but can't start with `aws:` or `connect:` .
- **Can I add the same attribute multiple times in a routing criteria?**
 - Yes, you can the same attribute multiple times in a routing criteria.
- **When triggering a transfer (quick connect), is it possible to set the routing criteria?**
 - You can use the `Set routing criteria` block in the transfer flow to set the routing criteria on the transferred contact segment. It is not possible to carry forward the routing criteria of previous contact to the new contact segment created after an agent has been joined.
- **What happens to the routing criteria if a contact is being transferred queue to queue, before it was routed?**
 - The routing criteria will start from the first step in the new queue in case a contact was transferred before being joined to an agent. For this, we carry-forward the routing criteria of previous contact to the new contact segment created due to queue transfer.
- **Does the Contact Record have a snapshot of the proficiencies of the matched agent?**
 - No, the Contact Record will not carry the proficiencies of an agent.
 - The Agent Event Stream will have a snapshot of the agent's proficiencies at the time of joining.
- **Will we be able to Search for an agent by proficiency using APIs?**
 - No, this is not supported.
- **What will happen if we delete an attribute if it is on an active contact?**
 - You can delete an attribute that is used on active contacts. However, any routing step with that attribute will not find a matching agent and the contact will stay in the queue till the routing criteria expires.
 - All new contacts with that attribute will start taking the error branch on the `Set Routing Criteria` block in the contact flow.
- **What happens to the routing criteria steps / expiration when an agent rejects a call?**
 - Routing considers a join to be complete when an agent accepts the contact and a join is completed. If an agent rejects a call / contact the routing engine will continue to run through the routing criteria with the timer continually running.

- **Will the agent who rejected the step be part of the pool when routing runs again?**
 - Yes, the agent will continue to be a part of the pool when routing runs again.
- **How will security work for Agent Proficiencies?**
 - Refer to the permissions sections on the [agent proficiencies page](#) to understand the security permissions required to set up and use the feature.
- **Are historical metrics available?**
 - No, historical metrics are not available in analytics.
 - The Contact Record, Agent Event Stream, and Contact Event Stream contain all the required information.
- **Where can I find a sample Lambda function for setting routing criteria?**
 - You can find a sample Lambda Function for setting routing criteria on the Set Routing Criteria flow block section. For more information, see [Flow block: Set routing criteria](#).
- **What happens to the routing criteria set on a contact if the contact is being transferred to an agent queue?**
 - The routing criteria has no effect on contacts present in an agent queue. If a contact with routing criteria is transferred from an agent queue to a standard queue, then the routing criteria will be forwarded to the new contact segment created due to queue transfer.

Set up agents

You can manage and load-balance customer contacts using agent hierarchy organization and agent status management. These tools provide filtering and agent availability management per queue, skill set, and routing profiles.

Contents

- [Set up agent hierarchies](#)
- [Add custom agent status](#)
- [Configure agent settings: routing profile, phone type, and auto-accept calls](#)
- [Predefined attributes](#)
- [Assign proficiencies to agents](#)
- [Enable auto-accept call for agents](#)
- [CCPv1: Log out agents automatically when they close their CCP](#)
- [Set up agents to assign tasks to themselves](#)

Set up agent hierarchies

Agent hierarchies are a way for you to organize agents into teams and groups for reporting purposes. It's useful to organize them based on their location and their skill sets. For example, you might want to create large groups, such as all agents who work on a specific continent, or smaller groups such as all agents working in a specific department.

You can also configure hierarchies with up to five levels, and segment agents or teams. Here are a couple of things to note about using hierarchies:

- Removing agents from a level affects historical reporting.
- When you use the **Restrict contact access** permission, you can restrict contact search results based on the agent's hierarchy. For more information, see [Manage who can search for contacts and access detailed information](#).

Required permissions

To create agent hierarchies, you need the **View - Agent hierarchy** permission in your security profile.

Note

Since agent hierarchies may include location and skill set data, you also need this permission to view the agent hierarchy information in a real-time metrics report.

The following image shows the **Users and permissions - Agent hierarchy** permissions on the **Security profile permissions** page.

Users and permissions 			
Type	All	View	Edit
Users	<input type="checkbox"/>	<input type="checkbox"/>	<input type="checkbox"/>
Agent hierarchy	<input type="checkbox"/>	<input checked="" type="checkbox"/>	<input type="checkbox"/>
Security profiles	<input type="checkbox"/>	<input type="checkbox"/>	<input type="checkbox"/>
Agent status	<input type="checkbox"/>	<input type="checkbox"/>	<input type="checkbox"/>

Create a new agent hierarchy

How many hierarchy groups can I create? To view your quota of **User hierarchy groups per instance**, open the Service Quotas console at <https://console.aws.amazon.com/servicequotas/>.

1. Log in to the Amazon Connect console with an **Admin** account, or an account assigned to a security profile that has permissions to create agent hierarchies.
2. Choose **Users, Agent hierarchy**.
3. Enter a name and choose **+** to create the first level of your hierarchy.
4. Choose **+** to add more levels to your hierarchy.
5. Choose **Save** to apply the changes, or **Cancel** to undo them.

Tip

If the Save button isn't active, you don't have permissions to create or edit the agent hierarchy.

Add groups, teams, and agents to a hierarchy

After you create a hierarchy, you can add groups, teams, and agents from the top down.

1. Select the top level of the hierarchy.
2. Choose **x** to add groupings to each level.
3. Choose the check icon to save the name, choose the pencil icon to edit the name.
4. Choose **Save**.

Choose **View historical changes** to view the change history. You can filter changes by date (between two dates) or by user name. If you cannot see the link, ensure that you have the proper permissions to view these changes.

Delete an agent hierarchy

Important

Deleting a hierarchy level severs the link to existing contacts. This action can not be reversed.

Add custom agent status

Agents are responsible for setting their status in the Contact Control Panel (CCP). In fact, the only time an agent's status changes is when they manually change it in the CCP, or when [their supervisor changes it](#) in a real-time metrics report.

Amazon Connect provides two default status values:

- Available
- Offline

You can change the name of these values, and you can add new ones. For example, you might add a status for Lunch, and another for Training. These and the default status values will be used for reporting, metrics, and resource management.

When you add a new status, it will always be **Custom**, not routable.

You can't delete a status value but you can disable it so it doesn't appear on the agent's CCP.

To add a new agent status

1. Choose **Users, Agent status, Add new agent status**.
2. Enter a status name and description, and select whether the status should appear in the CCP to the agent.
3. Choose **Save**.

To change the order that the status values appear in the CCP, click the waffle next to the status value, as shown in the following image. Drag it to the order you want.

Status name	Description
Available	Available state
Break	Lunch and coffee breaks
Training	Training on the new tools
Offline	Offline state

To edit a status

1. Choose **Users, Agent status**.
2. Hover over the status name and choose the edit icon.
3. Enter the new information, and choose **Save** to apply the changes.

Choose **View Historical Changes** to view the change history. You can filter changes by date (between two dates) or by user name. If you can't see the **View historical changes** link, make sure you have permissions to view these changes.

Configure agent settings: routing profile, phone type, and auto-accept calls

Before you configure your agent settings, here is some info to have on hand. Of course, you can always change this information later.

- What is their routing profile? They can only be assigned one.
- Will they have the **Agent** security profile or a custom profile you created?
- Are they going to use a soft phone? If so, will they be connected to contacts automatically, or will they need to press the **Accept** button in their Contact Control Panel (CCP)?
- Or, are they going to use a desk phone? If so, what is their number?
- How many seconds do they have for After contact work (ACW)? There's no way you can turn off ACW time altogether so agents never go to ACW. (A value of **0** means an indefinite amount of time.)
- Are they going to be assigned to an agent hierarchy?

Note

You can't configure how long an available agent has to connect with a contact before it's missed. Agents have 20 seconds to accept or reject a voice or chat contact, and 30 seconds for a task contact. If no action is taken, the current agent's status will be **Missed** and the contact is routed to the next available agent.

To configure agent settings

1. On the left navigation menu, go to **Users, User management**.
2. Choose the user you want to configure, then choose **Edit**.
3. Assign a [routing profile](#) to them. You can only assign one.
4. Assign the **Agent** security profile, unless you've created custom security profiles.
5. Under **Phone Type** choose whether the agent is using a desk phone or soft phone.
 - If you select desk phone, enter their phone number.

Important

Outbound telephony charges occur when using a desk phone to answer inbound calls.

- If you select soft phone, choose **Auto-Accept Call** if you want agents to be connected to calls automatically. This doesn't apply to chats.
6. In **After call work (ACW) timeout**, type how many seconds agents have for after contact work, such as entering notes about the contact.
 - Minimum setting is 1 second.
 - Maximum setting is 2,000,000 seconds (24 days).
 - Enter **0** if you don't want to allocate a specific amount of ACW time. It essentially means an indefinite amount of time. When the conversation ends, ACW starts; the agent must choose **Close contact** to end ACW.

The following image shows the **Settings** section of the **Edit routing profile** page. **After call work (ACW) timeout** set to 0.

The screenshot shows the 'Settings' page for an agent. It includes sections for 'Security profile' (Agent), 'Routing profile' (Basic Routing Profile), 'Phone' (Soft phone), and 'After Call Work (ACW) timeout'. The 'After Call Work (ACW) timeout' section has a text input field with the value '0' and a red arrow pointing to it. Below the input field, it says 'Required'.

7. Under **Agent Hierarchy** select any groups the agent should be part of.
8. Under **Tags**, add resource tags to identify, organize, search for, filter and control who can access this user.

Predefined attributes

Important

This information is not encrypted. We strongly recommend you follow the [Best practices for PII compliance in Amazon Connect](#).

Predefined attributes are attributes in an Amazon Connect instance that can be used to target an agent or pools of agents within a queue. A predefined attribute is made up of a name and a value.

- You can create up to 128 values per attribute.
- A predefined attribute name can be up to 64 characters long.
- A predefined attribute value can be up to 64 characters long.
- You can create and manage predefined attributes manually by using the Amazon Connect admin website or the Amazon Connect API. For more information, see [Create a predefined attribute](#) and [Predefined attribute management APIs](#).
- Pattern for predefined attribute: $^(?! (aws : | connect :)) [\p{L} \p{Z} \p{N} _ . : / = + - @ '] + \$$
- You can find the service quota for the number of predefined attributes in an Amazon Connect instance [here](#).

Create a predefined attribute

1. On the navigation menu, choose Routing, **Predefined attributes**, **Add predefined attribute**.
2. In the **Add predefined attributes** section, add the name in the **Predefined attribute** box and value in the **Value** box
3. Add additional values for the attribute by choosing **Add predefined attribute**.

Predefined attribute management

Add or edit attributes. These attributes can then be assigned to users and contacts, for use in routing. [Learn more](#)

Search by predefined attribute

Add predefined attribute

Predefined attribute	Value	Type	Delete
No results were found			

4. Choose **Save** to save the attribute and values.

Predefined attribute management > Add predefined attribute

Add predefined attribute

Cancel Save

Attribute information

Predefined attribute
Required 0 / 64

Value
Required 0 / 64

Add

5. Choose **Refresh** to update the **Predefined attribute management** page with the attributes that have been created.

Predefined attribute management APIs

- [CreatePredefinedAttribute](#)
- [UpdatePredefinedAttribute](#)
- [DeletePredefinedAttribute](#)
- [DescribePredefinedAttribute](#)
- [ListPredefinedAttributes](#)

Predefined attributes required permissions

Before you can add predefined attributes to Amazon Connect, you need the following permissions assigned to your security profile: **Predefined attributes**. The following image shows that this security profile permission in the **Routing** section of the **Add/Edit security profile** page.

Security profile permissions							
Routing							
This group gives permissions to the following areas: routing policies, quick connects, hours of operation, queues and task templates.							
Type	All	View	Edit	Create	Delete	Enable / Disable	
Routing profiles	<input type="checkbox"/>	<input type="checkbox"/>	<input type="checkbox"/>	<input type="checkbox"/>	<input type="checkbox"/>	<input type="checkbox"/>	
Quick connects	<input type="checkbox"/>	<input type="checkbox"/>	<input type="checkbox"/>	<input type="checkbox"/>	<input type="checkbox"/>	<input type="checkbox"/>	
Hours of operation	<input type="checkbox"/>	<input type="checkbox"/>	<input type="checkbox"/>	<input type="checkbox"/>	<input type="checkbox"/>	<input type="checkbox"/>	
Queues	<input type="checkbox"/>	<input type="checkbox"/>	<input type="checkbox"/>	<input type="checkbox"/>	<input type="checkbox"/>	<input type="checkbox"/>	
Task templates	<input type="checkbox"/>	<input type="checkbox"/>	<input type="checkbox"/>	<input type="checkbox"/>	<input type="checkbox"/>	<input type="checkbox"/>	
Predefined attributes	<input type="checkbox"/>	<input checked="" type="checkbox"/>	<input checked="" type="checkbox"/>	<input checked="" type="checkbox"/>	<input checked="" type="checkbox"/>	<input type="checkbox"/>	

System predefined attributes

System attributes, identified as `connect :` are predefined attributes set by Amazon Connect. The `connect :` name and values cannot be changed or deleted. The system attributes available today are `connect :Language` and `connect :Subtype`. You can add 128 custom values for `connect :Language`. You cannot change `connect :Subtype` but it can be used in routing criteria for routing.

[Predefined attributes](#) > Edit connect:Subtype

Edit connect:Subtype







Attribute information

Predefined attribute connect:Subtype Required 15 / 64	Value Required 0 / 64	Add
---	--------------------------	---------------------

Specified values

 Subtypes are provided by Amazon Connect and cannot be changed.

[Delete](#)

<input type="checkbox"/>	Value	Delete
<input type="checkbox"/>	connect:Task	
<input type="checkbox"/>	connect:Chat	
<input type="checkbox"/>	connect:SMS	
<input type="checkbox"/>	connect:Telephony	
<input type="checkbox"/>	connect:WebRTC	
<input type="checkbox"/>	connect:Guide	
<input type="checkbox"/>	connect:Apple	

Frequently asked questions

- **Do I need to define levels on a predefined attribute when I create it?**
 - A predefined attribute is made up of a name-value pair. For example, a name such as `language` and values such as `English`, `French`, `Swahili`.
 - A proficiency level is an indicator, ranging from 1 to 5, of the level of expertise of an agent for a given attribute value. It is set in the user profile. Level 1 is the lowest proficiency, while 5 is the highest.
- **Can I create duplicate predefined attributes? Case sensitivity?**
 - No, you cannot create predefined attribute with duplicate names or values. In addition, case sensitivity does not allow you to use duplicate names. For example, a new predefined attribute with the name `language` cannot be created if a predefined attribute with name `Language` exists in your Amazon Connect instance.
- **Can I delete a attribute if it is already assigned to an agent?**
 - An attribute can only be deleted if it not associated with any agent.
 - Before deleting an attribute, you should ensure none of the contacts are waiting for an agent with that attribute or the contact will not find a match.
- **How can I update the name of an attribute or value?**
 1. Stop using the attribute on future contacts to drain all of the contacts on an active contact type.
 2. Update all of the attributes.

Assign proficiencies to agents

A proficiency consists of a predefined attribute name, its value, and a proficiency level. The level is a numeric value of 1, 2, 3, 4, or 5. After you have created predefined attribute, you can assign one or more proficiencies to an agent.

For example, Agent1 and Agent2 may be proficient in multiple technologies at varying levels. They can be assigned proficiencies to reflect their level of proficiency in those technologies as shown in the following table:

Agent Name	Predefined Attribute	Value	Proficiency Level
Agent1	Technology	AWS Kinesis	2
Agent1	Technology	AWS Dynamo DB	5
Agent1	Technology	AWS EC2	4
Agent1	Language	French	3
Agent1	Language	English	4
Agent2	Technology	AWS Dynamo DB	3
Agent2	Technology	AWS EC2	5
Agent2	Technology	AWS Neptune	5
Agent2	Language	French	4
Agent2	Language	English	3

To assign a proficiency to a user

1. On the navigation menu, choose **Users** , **User Management**.
2. Select the user name to open the user profile.
3. Go to **Show advanced settings**.
4. In the **Attributes** section, for the **Name** field, using the dropdown menu select a predefined attribute that was created earlier.
5. From the **Value** field, using the dropdown menu ,select a option.
6. Under the **Skill level** field, select a proficiency level for the previous attribute value.
7. You can add up to 10 proficiencies per agent.

Attributes

Attributes are used for routing. Attributes must first be added via the [Attribute definitions page](#)

[Delete](#) [Add](#)

<input type="checkbox"/>	Name	Value	Skill level	Delete
<input type="checkbox"/>	Technology ✕ ▾	AWS DynamoDB ✕ ▾	5	
<input type="checkbox"/>	Technology ✕ ▾	AWS EC2 ✕ ▾	4	
<input type="checkbox"/>	Technology ✕ ▾	AWS Kinesis ✕ ▾	4	

Agent proficiencies management APIs

- [AssociateUserProficiencies](#)
- [DisassociateUserProficiencies](#)
- [ListUserProficiencies](#)

Enable auto-accept call for agents

When Auto-Accept Call is enabled for an available agent, the agent connects to contacts automatically.

This functionality doesn't apply to chats or tasks.

How long until the call is connected to the agent?

Note

While the call will be connected in less than one second, there will be no ringer, only the agent whisper.

Less than one second. When a call arrives to an available agent who has Auto-Accept Call enabled, the Contact Control Panel (CCP) briefly shows the options **Accept** or **Reject**. This is expected behavior. After less than a second, the call is automatically accepted and these options disappear.

There isn't an option for increasing the amount of time before a call is automatically accepted.

Auto-Accept Call doesn't work for callbacks.

Enable auto-accept call for existing agents

You can't enable Auto-Accept Call while editing multiple existing users in your Amazon Connect instance. You must edit existing users individually to enable it. However, you can configure the setting for multiple new users when you bulk upload new users with the CSV template.

To complete these steps, you must log in as a user who has the following permissions in their security profile: **Edit, Create, Remove, Enable / Disable, and Edit permission.**

1. Log in to the Amazon Connect admin website with an Admin account, or an account assigned to a security profile that has permissions to create or edit users.
2. On the left navigation menu, choose **Users, User management.**
3. In the list of users, select an agent, and then choose **Edit.**
4. On the Edit users page, under Phone Type, select the **Auto-Accept Call** check box.
5. Choose **Save.**
6. Repeat these steps for each user that you want to edit.

Bulk upload new users with auto-accept call enabled

You can't use the CSV template to edit information for existing users. If you include duplicate users with different information in the CSV template, you will receive an error.

1. Log in to your Amazon Connect instance using your access URL (<https://domain.awsapps.com/connect/login>).
2. On the left navigation menu, choose **Users, User management.**
3. Choose **Add new users.**
4. Under **How do you want to set up your existing users?**, next to **Upload my users from a template (csv)**, choose **template** to download a pre-formatted CSV file.
5. In the CSV file, configure the details for the new users who you want to add. For **soft phone auto accept (yes/no)**, be sure to enter **yes.**
6. After configuring the CSV file, in your Amazon Connect instance, choose **Upload my users from a template (csv)**, and then choose **Next.**
7. Under **Select and upload a spreadsheet with user details**, choose **Choose file.**
8. Choose the configured CSV file from its location on your computer.

9. In your Amazon Connect instance, choose **Upload and verify**.
10. Under **Verify user details**, verify that the information is correct for the new users, and then choose **Create users**.

(Optional) Verify the change in CCP logs

To confirm that **Auto-Accept Call** is enabled for an agent, download the CCP logs generated for that agent: in the CCP for the agent, choose **Settings, Download logs**. The logs are saved to your browser's default download directory.

In the logs, the **autoAccept** attribute is set to **"true"** if this setting is enabled. The logs show something like this:

```
"type": "agent",
"initial": false,
"softphoneMediaInfo": {
  "callType": "audio_only",
  "autoAccept": true
```

CCPv1: Log out agents automatically when they close their CCP

Important

This topic only applies to customers who use CCPv1. The URL for CCPv1 ends with **/ccp#**.

When using the default Amazon Connect CCPv1, closing the CCP window or logging out doesn't automatically change an agent's status from **Available** to **Offline**. An agent must change their status manually to **Offline** and then log out.

To change this behavior, you can do one of the following:

- Use CCPv2. When agents log out, their status is automatically switched to **Offline**. However, note that CCPv2 doesn't automatically switch agents to **Offline** if they only close the window. For instructions on upgrading to CCPv2, see [My CCP URL ends with /ccp#](#).
- Use the [CreateAgentStatus](#) API: You can change the state of the agent to Offline.
- Create a custom CCP. See [Amazon Connect Streams API](#) and the [Agent API](#)

- Use the following steps in this topic to update your CCP so it switches agents to **Offline** and logs out agents automatically when they close the CCP window.

Step 1: Set up the Streams API

For instructions, see the [Amazon Connect Streams Documentation](#).

Step 2: Update your application code to change the agent state

Integrate the following Streams API calls into your web application:

1. Use [connect.agent\(\)](#) to subscribe to agent events and retrieve agent objects.

```
let mAgent;

connect.agent(function(agent) {
  mAgent = agent;
});
```

2. Call [agent.setState\(\)](#) in the `onbeforeunload` event handler to change the agent state. The agent is marked Offline after executing the `beforeunload` function.

Using the `beforeunload` hook is the best option, but note that it doesn't work consistently.

```
window.addEventListener("beforeunload", function(event) {
  if (mAgent !== null) {
    let states = mAgent.getAgentStates();
    // "states" is an array of changeable states. You can filter the desired
    state to change by name.
    let offlineState = states.filter(state => state.name === "Offline")[0];

    // Change agent state
    mAgent.setState(offlineState, {
      success: function() {
        console.log("SetState succeeded");
      },
      failure: function() {
        console.log("SetState failed");
      }
    });
  }
});
```

Step 3: Design for errors

If an API call fails to execute the first time and a contact takes the error branch of your flow, there's a chance that an agent's state won't change as expected. Be sure to include logic to account for this possibility. For example, you could delay the page unload while the API call is tried again. Or, you could pop a "Call failed" warning message in a modal dialog before the page unload.

Set up agents to assign tasks to themselves

For an agent to be able receive a task, they need a quick connect created for them. With this quick connect, agents will be able to assign tasks to themselves, and other agents will be able to assign tasks to them.

Step 1: Create a quick connect for the agent

1. On the navigation menu, choose **Routing, Quick connects, Add a new**.
2. Enter a name for the quick connect, such as the name of the agent. For example, if you want Jane Doe to be able to assign tasks to herself, enter **Jane Doe**.
3. Under **Type**, use the dropdown list to choose **Agent**.
4. Under **Destination**, use the dropdown list to choose the user name for the agent.
5. Under **Flow**, choose **Default agent transfer**, or the appropriate flow for your contact center.
6. Under **Description**, enter a description, such as **Jane Doe's quick connect**.
7. Choose **Save**.

The following image shows a quick connect for Jane Doe on the **Quick connects** page.

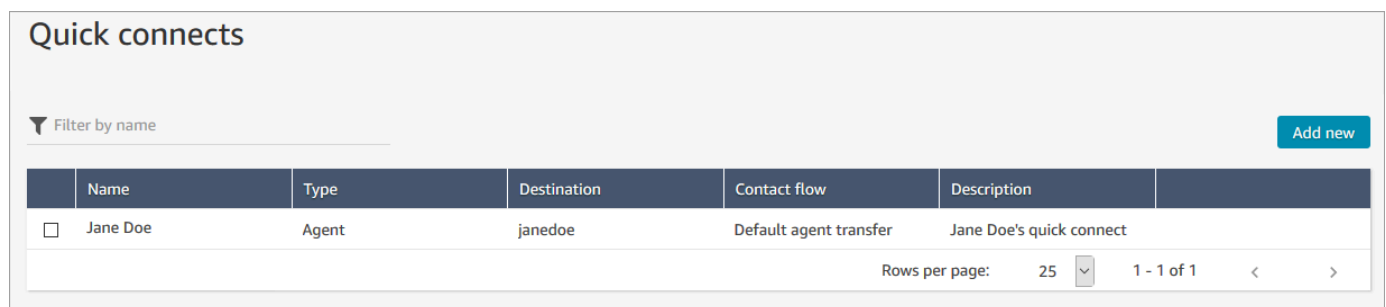

The screenshot shows the 'Quick connects' page in Amazon Connect. It features a search bar labeled 'Filter by name' and an 'Add new' button. Below is a table with the following data:

	Name	Type	Destination	Contact flow	Description	
<input type="checkbox"/>	Jane Doe	Agent	janedoe	Default agent transfer	Jane Doe's quick connect	

At the bottom right of the table, there is a 'Rows per page' dropdown set to 25, and a pagination indicator showing '1 - 1 of 1' with navigation arrows.

Step 2: Create a queue for the agent and associate the quick connect

1. After you create the quick connect, go to **Routing, Queues** and add a queue for the agent.

2. On the **Add new queue** page, in the **Quick connects** box, search for the quick connect you created for the agent.
3. Select the quick connect and then choose **Save**.

Step 3: Add the queue to the agent's routing profile

1. Go to **Users, Routing profiles** and choose the agent's routing profile.
2. Add the agent's queue to the routing profile, and choose **Task** for the channel.

If the agent can receive transfers through other channels, select them as well.

3. Choose **Save**.

Set up tasks

1. [Update your agent's routing profile](#) so they can manage and create tasks.

When you add tasks to their routing profile, you can specify that up to 10 tasks be assigned to them at a time.

An agent can pause the same number of tasks as the **Maximum tasks per agent** setting in their [routing profile](#).

For example, an agent has a **Maximum tasks per agent** setting to handle 5 active tasks simultaneously. This means they can pause up to 5 tasks, which allows them to free up their active slots to take in new more critical tasks. However, it also means that agents can have twice the number of tasks in their workspace at any point in time. In our example, this agent can have 10 tasks in their workspace: 5 paused and 5 active.

The following image shows the **Tasks** option on the **Routing profile** page.

Name
Basic Routing Profile

Description
A simple routing profile.
225 of 250 characters remaining.

Set channels and concurrency
Defines which channels agents can handle in the CCP
Note: If all channels are selected, agents will have access to only one channel at a time for inbound contacts.

Voice

Chat
Maximum chats (per agent)
2

Task
Maximum tasks (per agent)
5

Routing profile queues
If no queue is added, the agent will only be able to make outbound calls. At least one queue is needed for inbound calls.

<input type="checkbox"/> Name	Channels	Priority
<input type="checkbox"/> BasicQueue × ▾	<input checked="" type="checkbox"/> Voice <input checked="" type="checkbox"/> Chat <input checked="" type="checkbox"/> Task	1
<input type="checkbox"/> Search for queue ▾	<input checked="" type="checkbox"/> Voice <input type="checkbox"/> Chat <input type="checkbox"/> Task	1

2. [Create quick connects](#) so that agents can create/assign tasks to themselves, or other agents or shared queues.
3. Update your flows to route tasks.
4. Optionally, [create task templates](#) to make it easy for agents to create tasks. All the fields they need to create a task are defined for them.
5. Optionally, [integrate with external applications](#) and [set up rules to automatically create tasks](#) based on pre-defined conditions.
6. By default all agents can create tasks. If you want to block [permissions](#) for some agents, assign the **Contact Control Panel, Restrict task creation permission** in their security profile.

Create task templates

Task templates make it easy for agents to capture the right information to create and complete a [task](#). All the fields they need to create a given type of task are provided for them.

Important things to know before you create your first template

- When you publish your first template, your agents will be prompted to select a template when they create a new task. Agents must select one of the templates you have published.
- If you want to return to the standard task experience and not require agents to select a template, on the **Task templates** page, use the **Disable/Enable** toggle to disable all templates you published.
- Verify your Amazon Connect account has [permissions to create task templates](#).
- Review the list of quotas for task templates, such as the **Task templates per instance** and **Task template customized fields per instance**. See [Amazon Connect service quotas](#).

How to create a task template

Step 1: Name the template

1. Log in to the Amazon Connect console with an **Admin** account, or an account assigned to a security profile that has [permissions to create task templates](#).
2. In the left navigation menu, choose **Channels, Task templates**.
3. On the **Task templates** page, choose **+ New template**.
4. On the **Create new template** page, in the **Template name** box, enter the name that will be displayed your agents.
5. In the **Description** box, describe the purpose of the template. This information is not displayed to agents; it's for your own use.

Step 2: Add fields, task assignment, and schedule

1. In the **Fields** section, choose the **Add field** dropdown, and then select the type of field you want to add to your template.

Fields

Add fields that agents can see or edit. You can also choose to hide fields or make them read only. Visible fields are displayed on the task template. To make a field required, make that field required. Note that Task name and description are fields that are present by default.

Order	Field Name	Validation and agent permissions	Default value
1	Task name Text (4096 character limit)	Required, Visible, Editable	-
2	Description Text (4096 character limit)	Visible, Editable	-
	Add field ▼		
	Date		
	Email		
	Number		
	Single-select (dropdown)		
	Text (512 characters)	Visible, Editable	yes
	Text area (4096 characters)		
	Checkbox		
	URL		

- Use the up and down arrows as needed to change the order the field appears on the template.
- In the **Validation and permissions** section, choose whether the field is required to be populated by the agent when they create a task, or add a default value to pre-populate the field when the agent opens the template.

The following image shows what this section looks like for a field that is type **Email**.

↑

3 **Email**

↓

Field name * Field description

Required 0 / 100 Not visible to agents

Validation and agent permissions ⓘ

Required

Visible

Editable

Default value

Note

It is not possible to use attributes in the task templates page.

- In the **Task assignment** section, choose **Yes** to allow agents to view and edit a task assignment when they create the task. Or, assign a default value, as shown in the following image. Choose a published flow that runs after the agent chooses **Create** to create the task. Agents don't see the name of the flow on the CCP.

Note

Only published flows are listed in the **Default value** dropdown.

Task assignment
Configure which contact flow is initiated when the task is created. Alternatively, enable your agents to select a task template.

4 **Assign to**
Single-select

Can agents view and edit task assignment?

Yes

No I'll set a default value

Default value (not visible to agents)

Flow

Please select a contact flow from the dropdown

- In the **Task schedule** section, choose whether you want agents to be able to schedule a future start date and time for tasks.

Step 3: Publish

After you configure your template, choose **Publish** to create it and make it visible to your agents.

Important

If this is your first template, when you choose **Publish**, agents are automatically required to select a task template when they create a task.

If you want to maintain the standard task experience without selectable templates, disable all templates.

What your agents experience

After you publish a template, agents are required to select a template to create a task.

For example, the following image shows two templates have published: **Customer Email Template** and **Billing Dispute**.

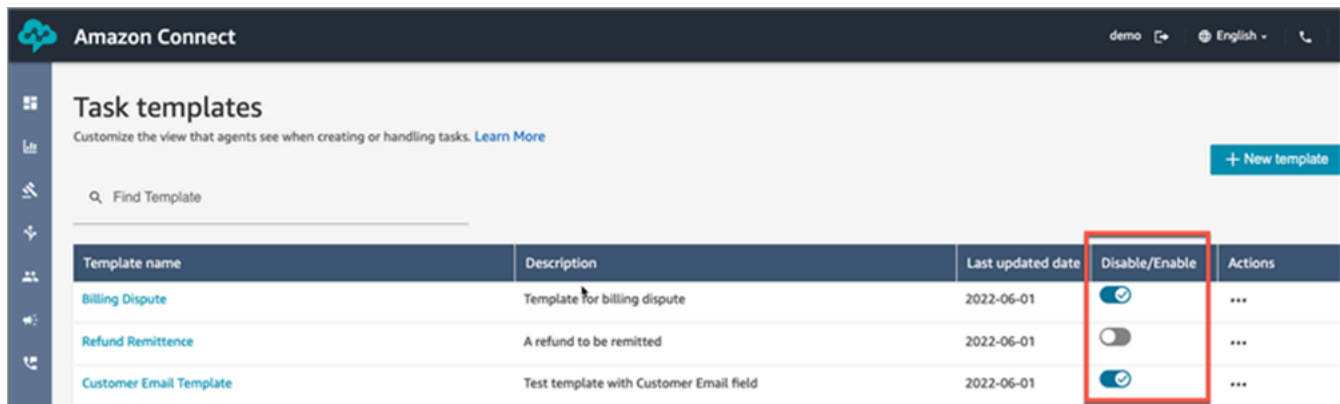

Template name	Description	Last updated date	Disable/Enable	Actions
Billing Dispute	Template for billing dispute	2022-06-01	<input checked="" type="checkbox"/>	...
Refund Remittance	A refund to be remitted	2022-06-01	<input type="checkbox"/>	...
Customer Email Template	Test template with Customer Email field	2022-06-01	<input checked="" type="checkbox"/>	...

In the Contact Control Panel, when agents choose **Create task** they must choose one of the templates: **Billing Dispute** or **Customer Email Template**.

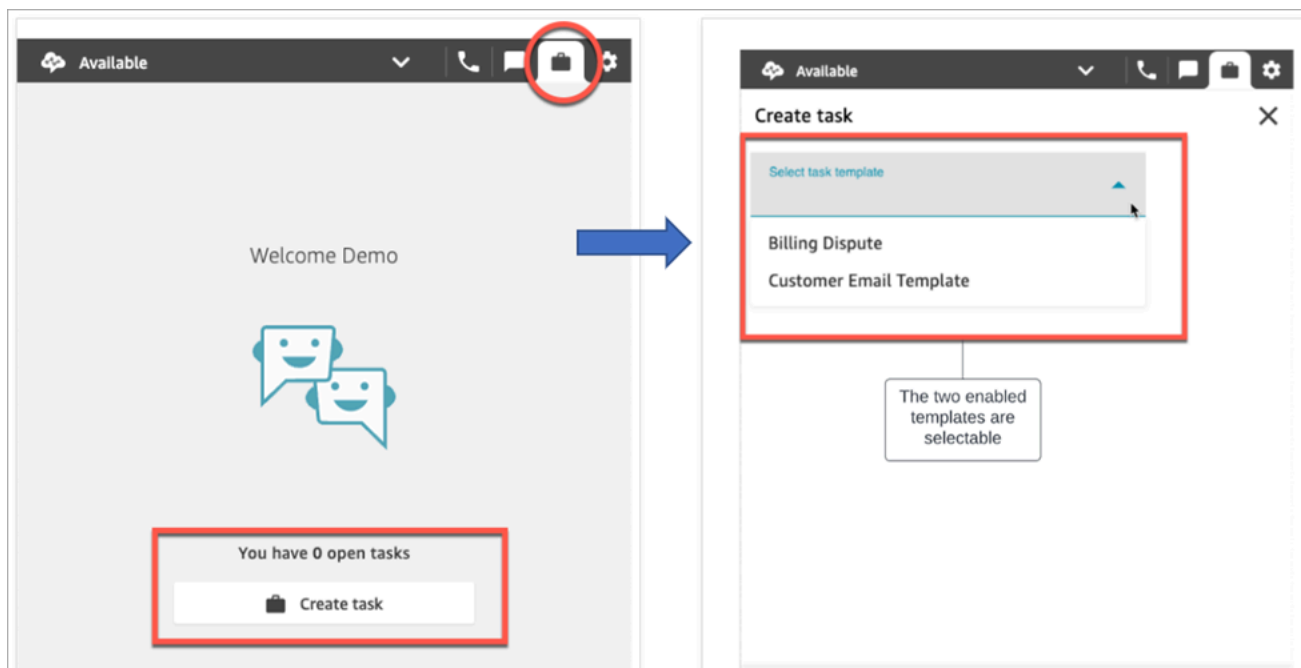

Let's assume the agent chooses **Customer Email Template**. The following image shows the fields the agent must complete in order to create a task. Notice that there is no option for the agent to assign the task; this template has **Task assignment** set to a default value.

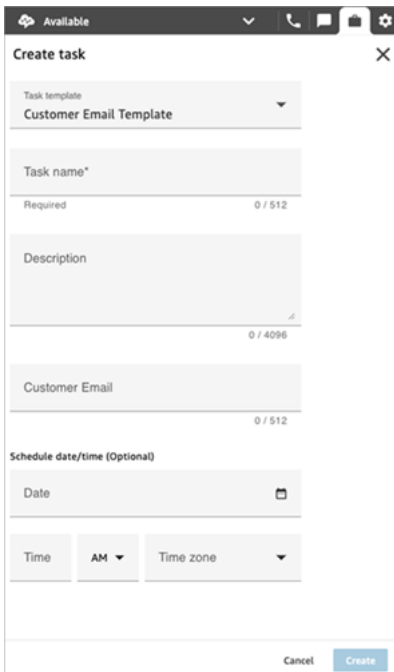

"No data" message in the Assign to dropdown

Let's say that in the **Task assignment** section, you choose to allow agents to assign the task to another agent. To set up for this scenario, you must create a quick connect for the destination agent so it appears in the dropdown list of choices, as shown in the following image. For instructions about creating a quick connect for an agent, see [Test tasks](#).

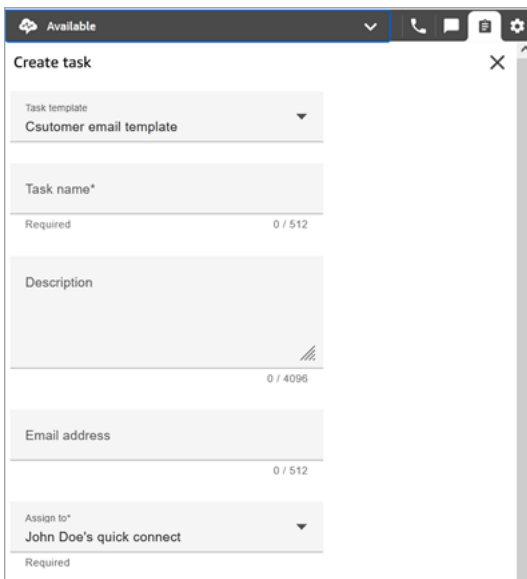

If no quick connects exist, then the message **No data** appears when you choose the **Assign to** dropdown menu, as shown in the following image

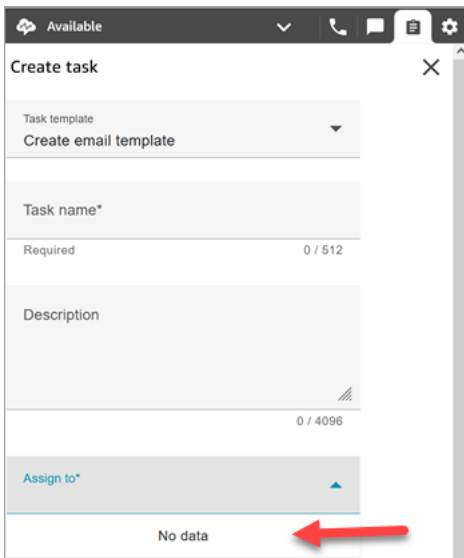

The screenshot shows a 'Create task' dialog box. At the top, it says 'Available' with a dropdown arrow, a close button (X), and a settings gear. Below that, there's a 'Task template' dropdown menu currently set to 'Create email template'. Underneath is a 'Task name*' text input field. Below that is a 'Required' field showing '0 / 512'. Then a 'Description' text area showing '0 / 4096'. At the bottom, there's an 'Assign to*' dropdown menu. Below the dropdown, the text 'No data' is displayed, with a red arrow pointing to it from the right.

Security profile permissions for task templates

Assign the **Routing, Task templates** permissions to enable a user to create task templates.

For information about how to add more permissions to an existing security profile, see [Update security profiles](#).

By default, the **Admin** security profile already has permissions to perform all task activities.

Block agents from creating tasks

To block agents from being able to create tasks, assign the **Contact Control Panel (CCP), Restrict task creation** permission. By default this permissions is unchecked, which means all agents can create tasks.

For information about how to add more permissions to an existing security profile, see [Update security profiles](#).

By default, the **Admin** security profile already has permissions to perform all tasks activities.

Set up applications for task creation

You can set up applications for task creation in just a few steps, no coding required. Amazon Connect uses Amazon EventBridge to pull data from your external application.

Tip

If your organization is using custom [IAM](#) policies to manage access to the Amazon Connect console, make sure users have the appropriate permissions to set up applications for task creation. For a list of required permissions, see [Tasks page](#).

If your instance was created before October 2018, for information about how to configure your service-linked roles (SLR), see [For instances created before October 2018](#).

Contents

- [Set up application integration for Salesforce](#)
- [Set up application integration for Zendesk](#)
- [Monitor task creation](#)
- [Disassociate an Amazon Connect connection](#)

Set up application integration for Salesforce

If you integrate with Salesforce for event creation, Amazon Connect also uses Amazon AppFlow to put the data into EventBridge. This is because of how Salesforce sends events through the Amazon AppFlow APIs. To learn more about how Amazon Connect uses EventBridge and Amazon AppFlow resources to power Salesforce integrations, see this blog post: [Building Salesforce integrations with Amazon EventBridge and Amazon AppFlow](#).

Note

If you use custom AWS Identity and Access Management (IAM) policies, for a list of the required IAM permissions to set up Amazon Connect Tasks, see [Tasks page](#).

To integrate Salesforce for task creation

1. Open the Amazon Connect console at <https://console.aws.amazon.com/connect/>.
2. On the instances page, choose the instance alias. The instance alias is also your **instance name**, which appears in your Amazon Connect URL. The following image shows the **Amazon Connect virtual contact center instances** page, with a box around the instance alias.

Amazon Connect > Instances

Amazon Connect virtual contact center instances

Instances Refresh Delete Add an instance

Find resources

Instance alias	Access URL	Channels	Create date	Status
mytest67	https://mytest67.my.connect.aws	Inbound, outbound telephony	1/12/2022	Active

3. Choose **Tasks**, and then choose **Add an application**.

Amazon Connect > Tasks

Tasks

Integrate external applications

Amazon Connect integrates with external applications, including Customer Relationship Management (CRM), and Workforce Management (WFM) products. [Learn more](#)

Your applications for tasks

Add an application

4. On the **Select application** page, choose **Salesforce**.

5. Review the application requirements that are listed on the **Select application** page.

The following image shows the requirements for Salesforce.



Select application

What external application would you like to connect with?

Amazon Connect instances integrate with multiple external applications.

 Salesforce

 Zendesk

 Amazon Connect integrates with Salesforce to automate tasks using case change events. 

- Your Salesforce account is enabled for API access.
- Your Salesforce account allows you to install connected apps.
- You have enabled Change Data Capture and selected the "Case" entity to enable case change events. From setup, enter "Change Date Capture" in Quick Find.
- If your Salesforce app enforces IP address restrictions, you have granted access to the addresses used by Amazon AppFlow. For more information see [AWS IP address ranges](#) in the Amazon Web Services General Reference.

Cancel

Next

- To verify that Salesforce is compatible with Amazon AppFlow, log in to Salesforce, for example, [https://\[instance_name\].my.salesforce.com](https://[instance_name].my.salesforce.com).

Important

Verify that you have enabled **Change Data Capture** in Salesforce. The following image shows an example **Change Data Capture** page in Salesforce where you select the Case entities:

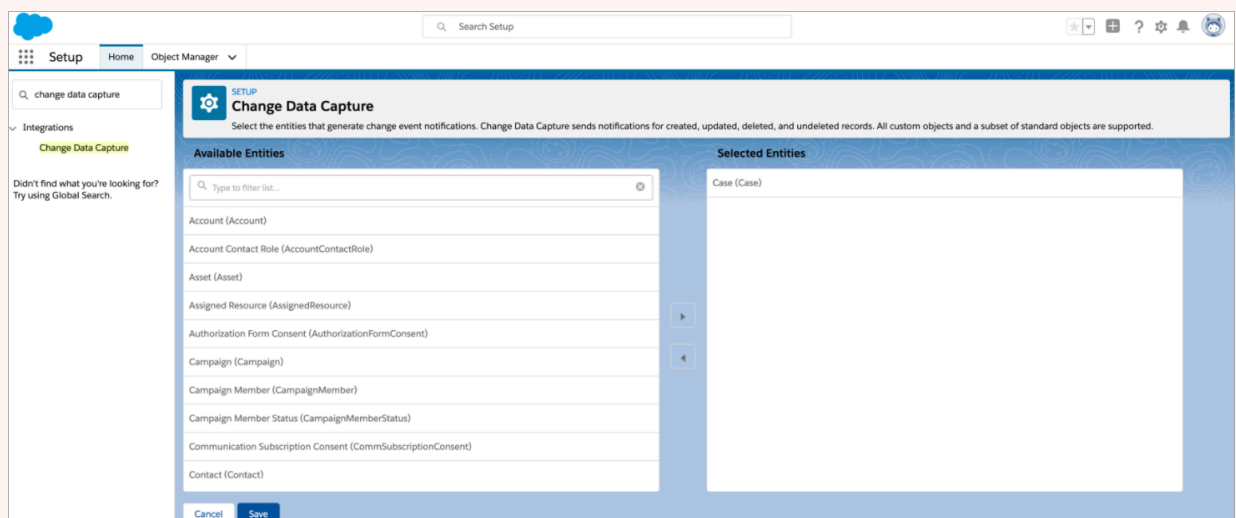

- After you verify Salesforce requirements, on the **Select application** page, choose **Next**.

7. On the **Establish connection** page, choose one of the following:
- **Use an existing connection.** This allows you to reuse existing EventBridge resources that are linked to Amazon AppFlow flows that you may have created in your AWS account.
 - **Create a new connection:** Enter the information required by the external application.
 1. Enter your application instance URL. This URL is used for deep-linking into the tasks created in your external application.
 2. Provide a friendly name for your connection, for example, **Salesforce - Test instance**. Later, when you [add rules](#), you'll refer to this friendly name.
 3. Specify whether this is a production or sandbox environment.

Establish connection

Setup your external application

Follow these steps to set up your external application.

 Amazon Connect integrates with Salesforce to automate tasks using case change events.

Connection type

- Use an existing connection
- Create a new connection

Create a new connection

1 - Enter your Salesforce instance URL

Your instance URL information is available on the application's website.

https:// .salesforce.com

2 - Name your connection

This name will be used to refer to this URL inside the Amazon Connect web application instance.

3 - Salesforce environment

The environment of your Salesforce instance.

- Production
- Sandbox

4 - Log in to Salesforce

To establish your connection, Amazon Connect will take you to the Salesforce login screen. After you're signed in, you'll be returned to Amazon Connect.

[Log in to Salesforce !\[\]\(111c5272ee3f91361f0d2e3665dd6ad0_img.jpg\)](#)



8. Choose **Log in to Salesforce**.
9. In Salesforce, choose to allow access to Amazon Connect Embedded Login App [Region].

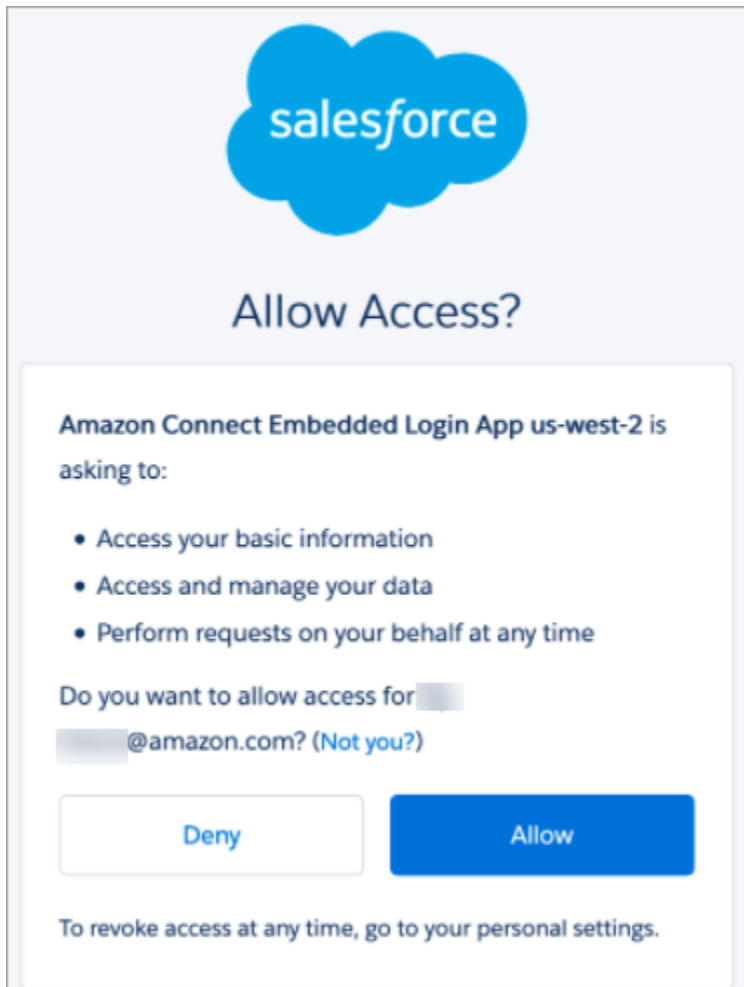



10. After Amazon Connect has successfully connected with the Salesforce, go to Salesforce and verify that the refresh token policy for Amazon Connect Embedded Login App is set to **Refresh token is valid until revoked**. This grants Amazon AppFlow access to pull data from your Salesforce account without re-authenticating.
11. On the **Establish connection** page, select the box shown in the following image, and choose **Next**.

Establish connection

Setup your external application

Follow these steps to set up your external application.

 Amazon Connect integrates with Salesforce to automate tasks using case change events. 

 Amazon Connect has successfully connected with Salesforce

Check that the refresh token policy for "Amazon Connect Embedded Login App" is set to "Refresh token is valid until revoked"

Cancel

12. On the **Review and integrate** page, check that the **Connection status** says **Connected**, and then choose **Complete integration**.

Review and integrate

Review integration

Connection URL	Connection status
https://[redacted]my.salesforce.com	Connected 
Connection name	
Salesforce - Test instance	

Cancel

13. On the **Tasks** page, the new connection is listed.

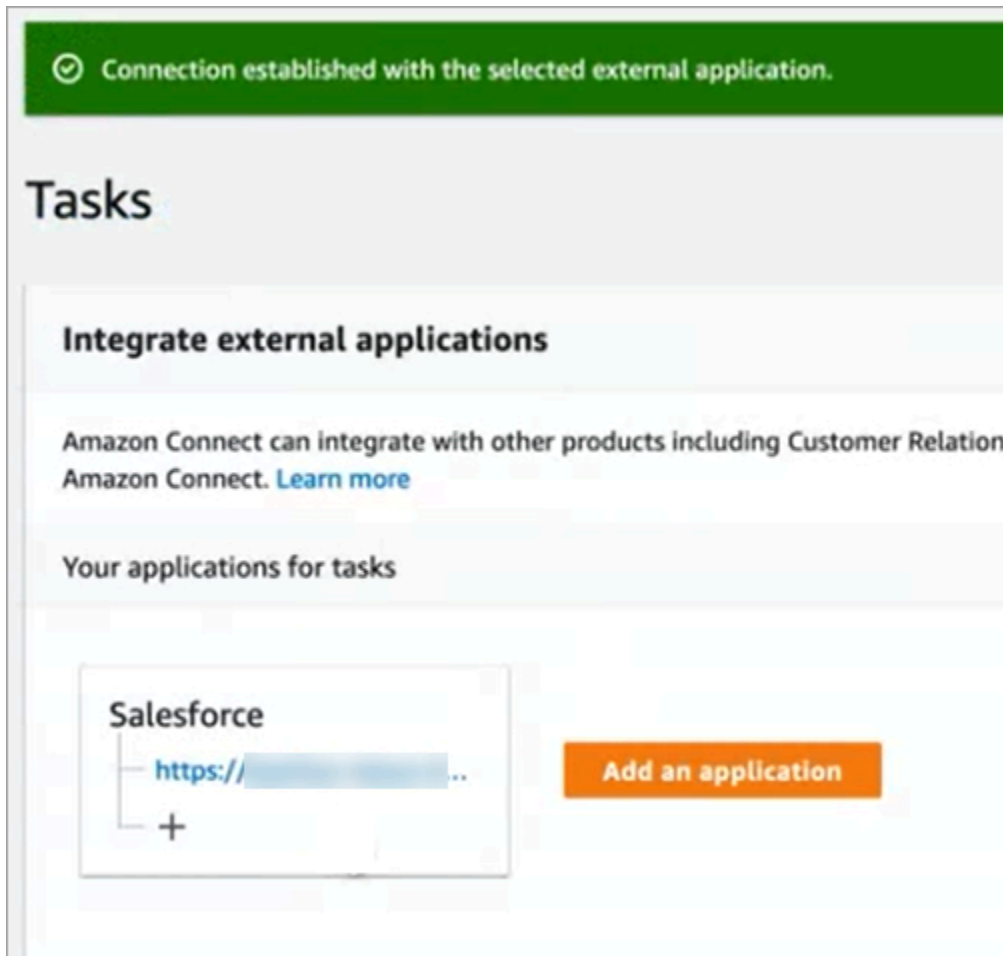

You're done! Next, add rules that tell Amazon Connect when to create a task and how to route it. For instructions, see [Create rules that generate tasks for third-party integrations](#).

What to do when a connection isn't successfully established

A connection might fail to be established for Salesforce if you didn't follow the instructions next to the check boxes to verify that it's compatible with Amazon AppFlow.

A common error is not setting up the **Case** entity in the **Change Data Capture** settings to capture these events. To fix:

1. Log in to Salesforce, go to the **Change Data Capture**, and select the Case entity.

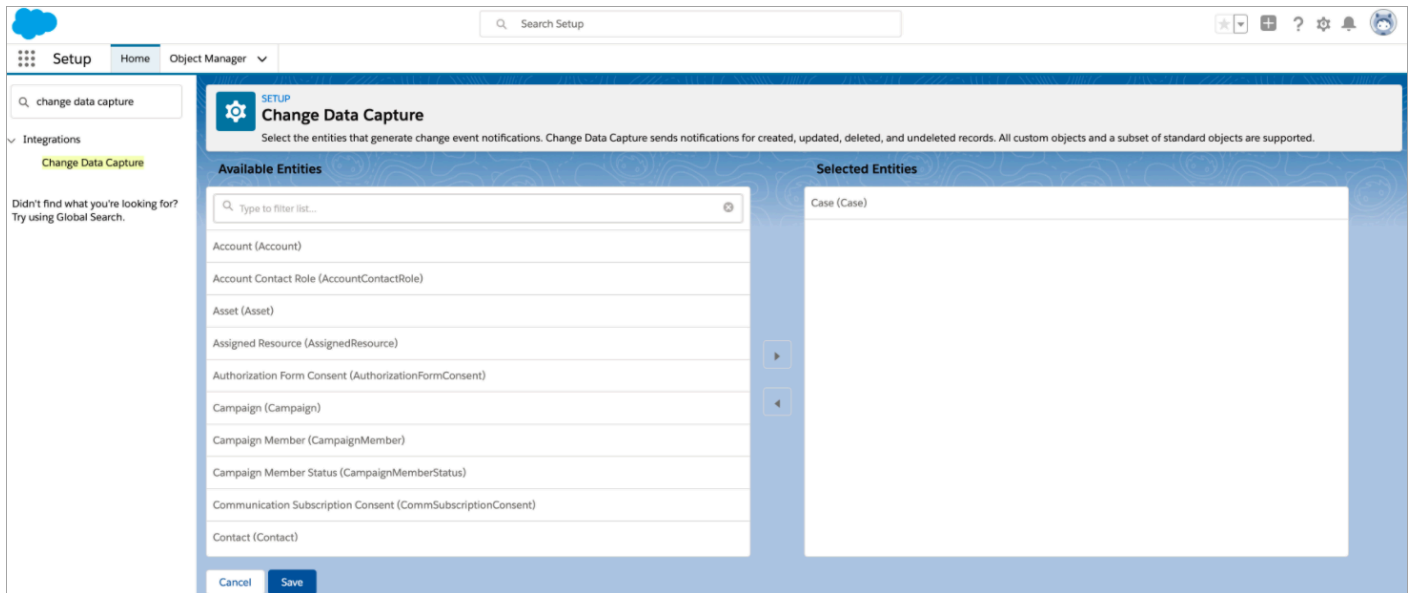

2. Open the Amazon AppFlow console at <https://console.aws.amazon.com/appflow> to select the flow that was just created, and then choose **Activate flow**.

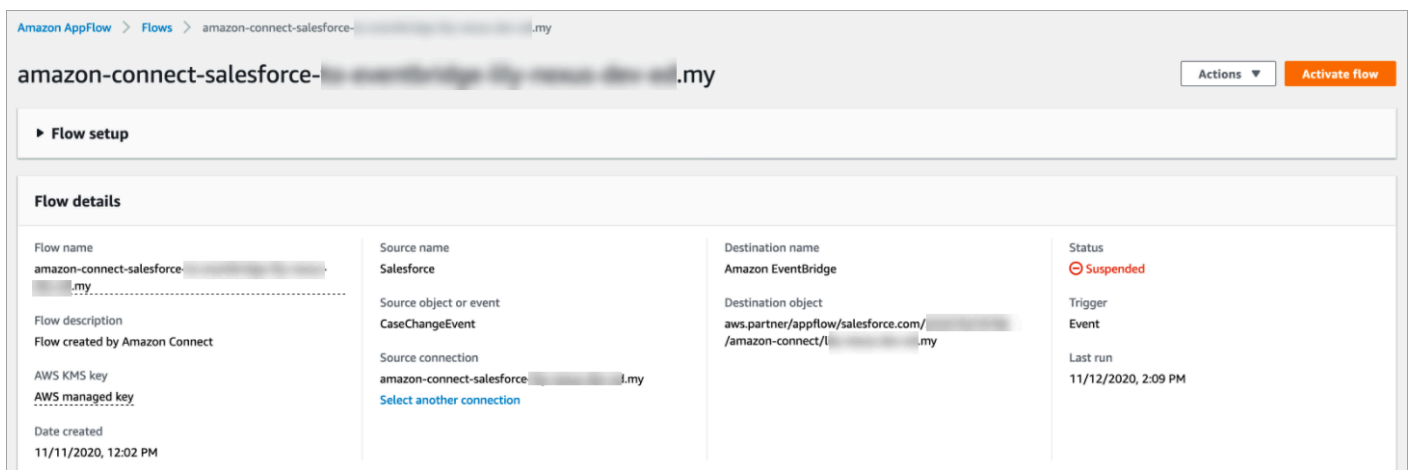

Alternatively, you might need to delete the Amazon AppFlow Salesforce connection and flow, and start again.

Set up application integration for Zendesk

Step 1: Enable the events connector for Amazon EventBridge

If you don't already have the EventBridge connector for Zendesk enabled, you need to set it up first. Otherwise, go to [Step 2: Integrate Zendesk with Amazon Connect for task creation](#).

1. Copy your AWS account number:

- a. In the Amazon EventBridge console, go to **Partner event sources**.
 - b. Search for or scroll to **Zendesk**, and choose **Set up**.
 - c. Choose **Copy** to copy your AWS account information.
2. Go to [Setting up the events connector for Amazon EventBridge](#) in the Zendesk Help and follow the instructions.

Step 2: Integrate Zendesk with Amazon Connect for task creation

Note

If you use custom AWS Identity and Access Management (IAM) policies, for a list of the required IAM permissions to set up Amazon Connect Tasks, see [Tasks page](#).

1. Open the Amazon Connect console at <https://console.aws.amazon.com/connect/>.
2. On the instances page, choose the instance alias. The instance alias is also your **instance name**, which appears in your Amazon Connect URL. The following image shows the **Amazon Connect virtual contact center instances** page, with a box around the instance alias.

Instance alias	Access URL	Channels	Create date	Status
mytest67	https://mytest67.my.connect.aws	Inbound, outbound telephony	1/12/2022	Active

3. Choose **Tasks**, and then choose **Add an application**.

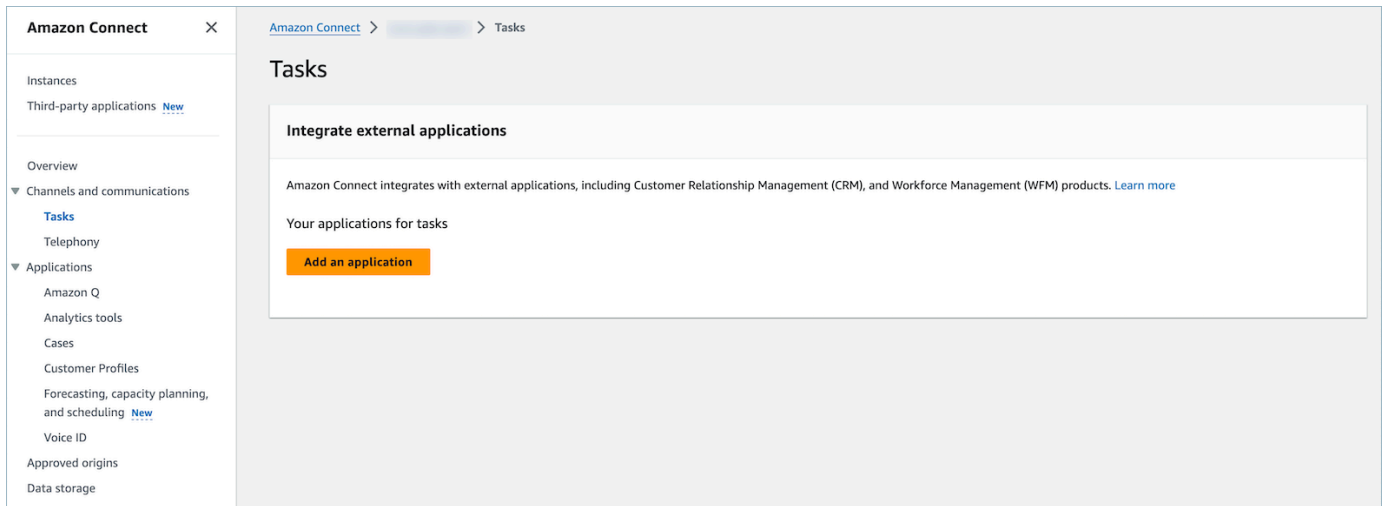

4. On the **Select application** page, choose **Zendesk**.
5. After you choose to integrate with Zendesk, the application requirements are listed on the page.

The following image shows the requirements for Zendesk. In this procedure, we walk you through the steps to select the "Support ticket" event type in Zendesk. Acknowledge the steps and choose **Next**.

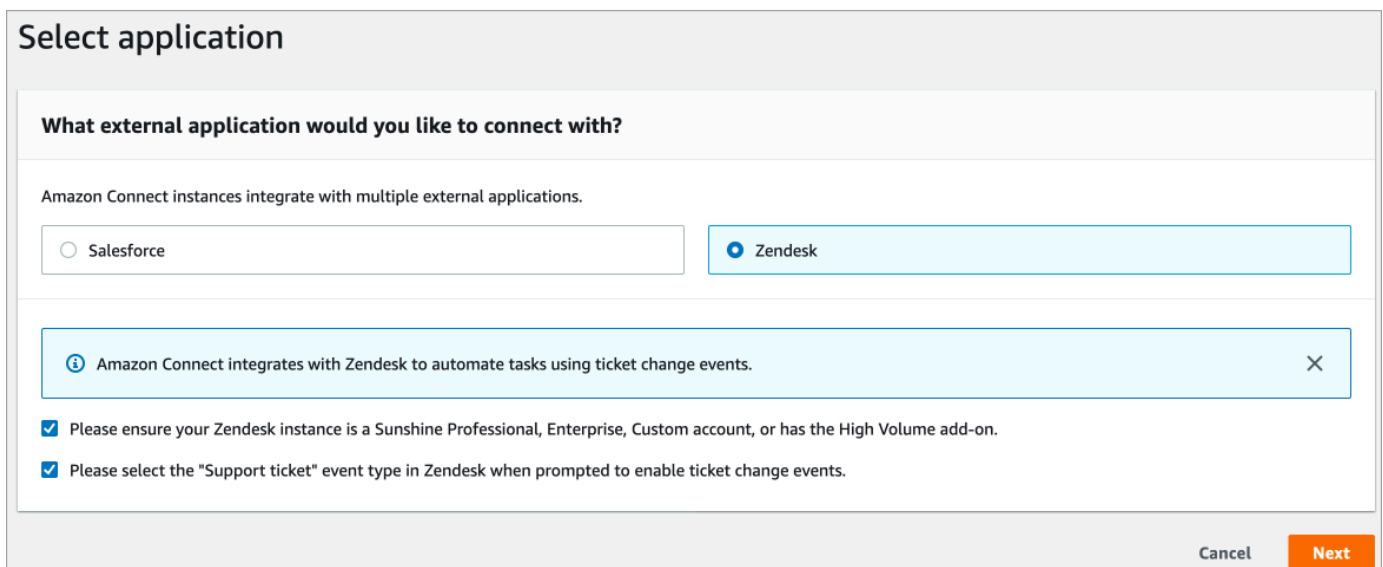

6. On the **Establish connection** page, choose one of the following:
 - **Use an existing connection.** This allows you to reuse existing EventBridge resources you may have created in your AWS account.
 - **Create a new connection:** Enter the information required by the external application.

1. Enter your application instance URL. This URL is used for deep-linking into the tasks created in your external application.
2. Provide a friendly name for your connection, for example, **Zendesk - Test instance**. Later, when you [add rules](#), you'll refer to this friendly name.

Establish connection

Setup your external application

Follow these steps to set up your external application.

 Amazon Connect integrates with Zendesk to automate tasks using ticket change events.

Connection type

Use an existing connection

Create a new connection

Create a new connection

1 - Enter your Zendesk instance URL
Your instance URL information is available on the application's website.

https:// .zendesk.com

2 - Name your connection
This name will be used to refer to this URL inside the Amazon Connect web application instance.

instance"/>

3 - Copy your AWS account ID to your clipboard
Your AWS account ID

4 - Paste your AWS account ID
Please navigate to your Zendesk instance and paste the AWS account ID.

7. Choose **Copy** to copy your AWS account ID, and then choose **Login to Zendesk**. This takes you away from the **Establish connection** page for now, but you return to it shortly.
8. After you're logged in to Zendesk, choose **Connect** to connect the Events Connector for Amazon EventBridge.

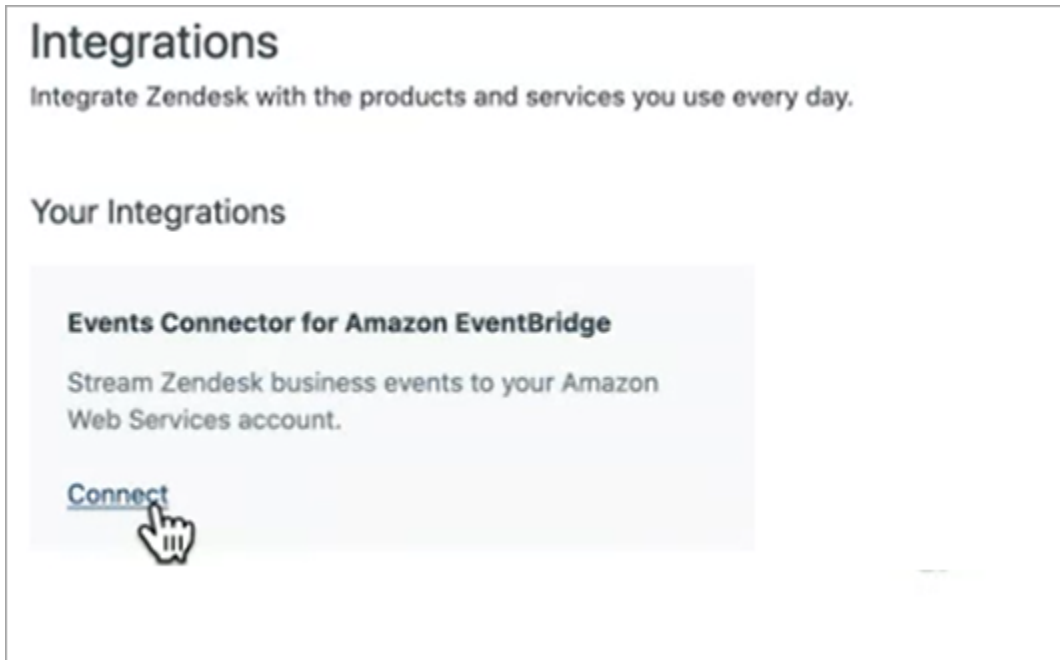

9. In Zendesk, on the **Amazon Web Services** page, paste in your Amazon Web Service account ID, choose your Region, choose **Support ticket**, acknowledge the terms of use, and the choose **Connect**. Zendesk creates a resource in Amazon EventBridge.

[Integrations](#) > Amazon Web Services

Amazon Web Services

Configure the integration between your Zendesk Events Connector for Amazon EventBridge and your Amazon Web Services account through Amazon EventBridge in order to start receiving Zendesk business events.

Account ID and region

Enter your Amazon Web Services account ID and select the region for your account instance.

Amazon Web Services account ID
This is a 12 digit number



Amazon Web Services region
Recommended region US East (N. Virginia) ⓘ

US West (Oregon) ▾ 

Event types

Select which event types you would like your Amazon Web Services account to be subscribed to.

Support ticket 

Support user

Support organization

Terms of Use

By connecting this integration you agree to the [Built by Zendesk Terms of Use](#) 

10. Return to the **Establish connection** page in Amazon Connect choose **Next**.
11. On the **Establish connection** page, you'll see the message that Amazon Connect has successfully connected with Zendesk. Choose **Next**.

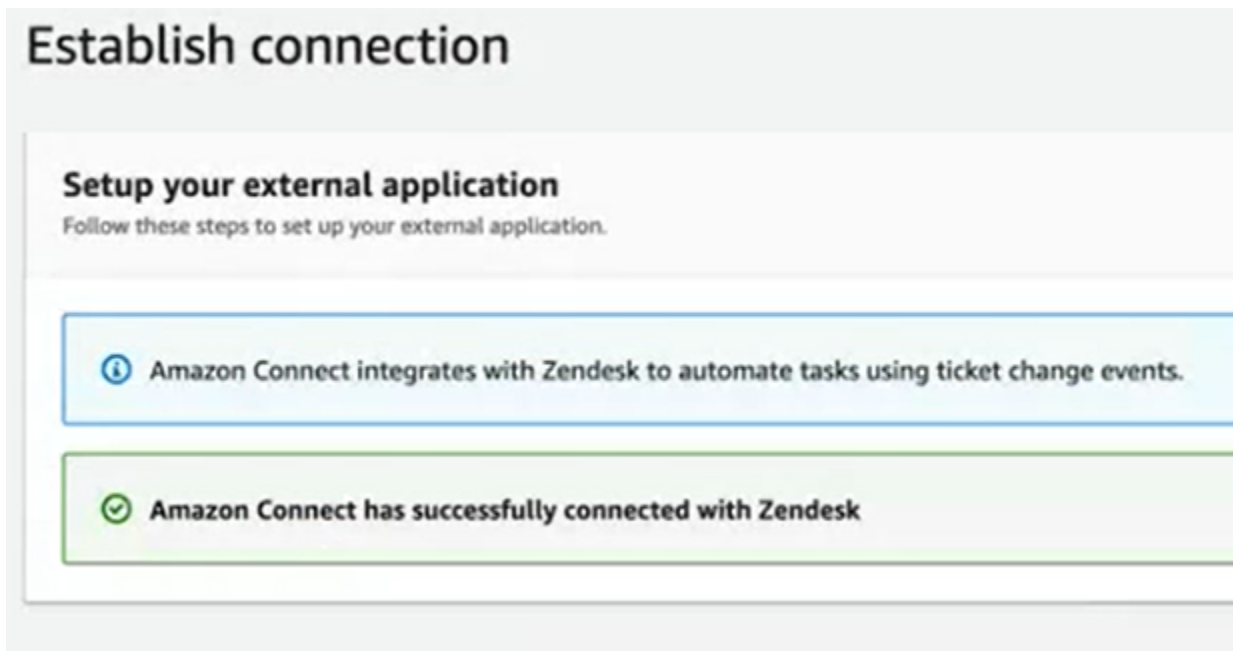

12. On the **Review and integrate** page, check that the **Connection status** says **Connected**, and then choose **Complete integration**.

This creates a connection that associates the EventBridge resource for Zendesk to Amazon Connect.

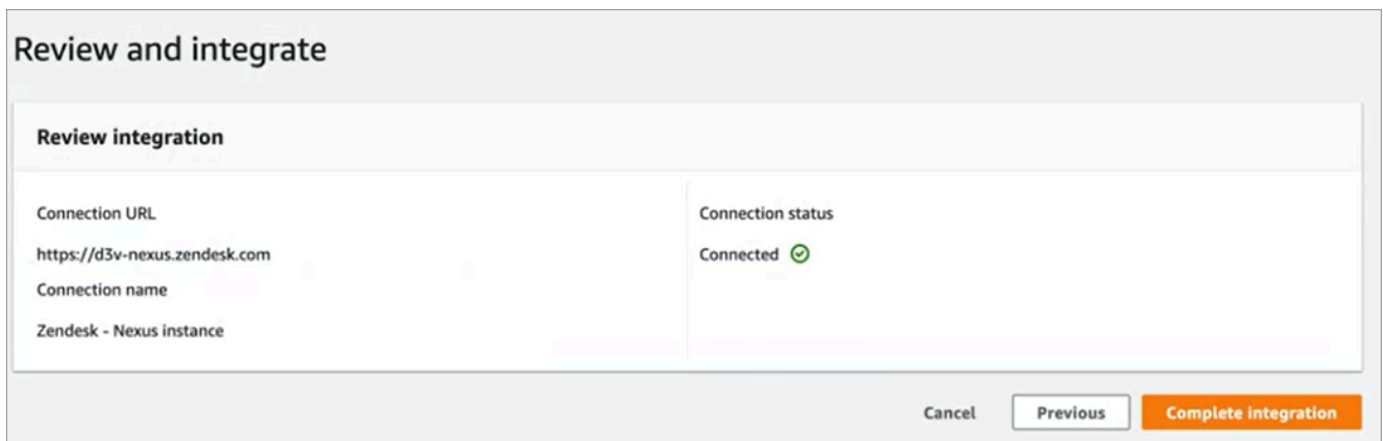

13. On the **Tasks** page, the new Zendesk connection is listed, as shown in the following image.

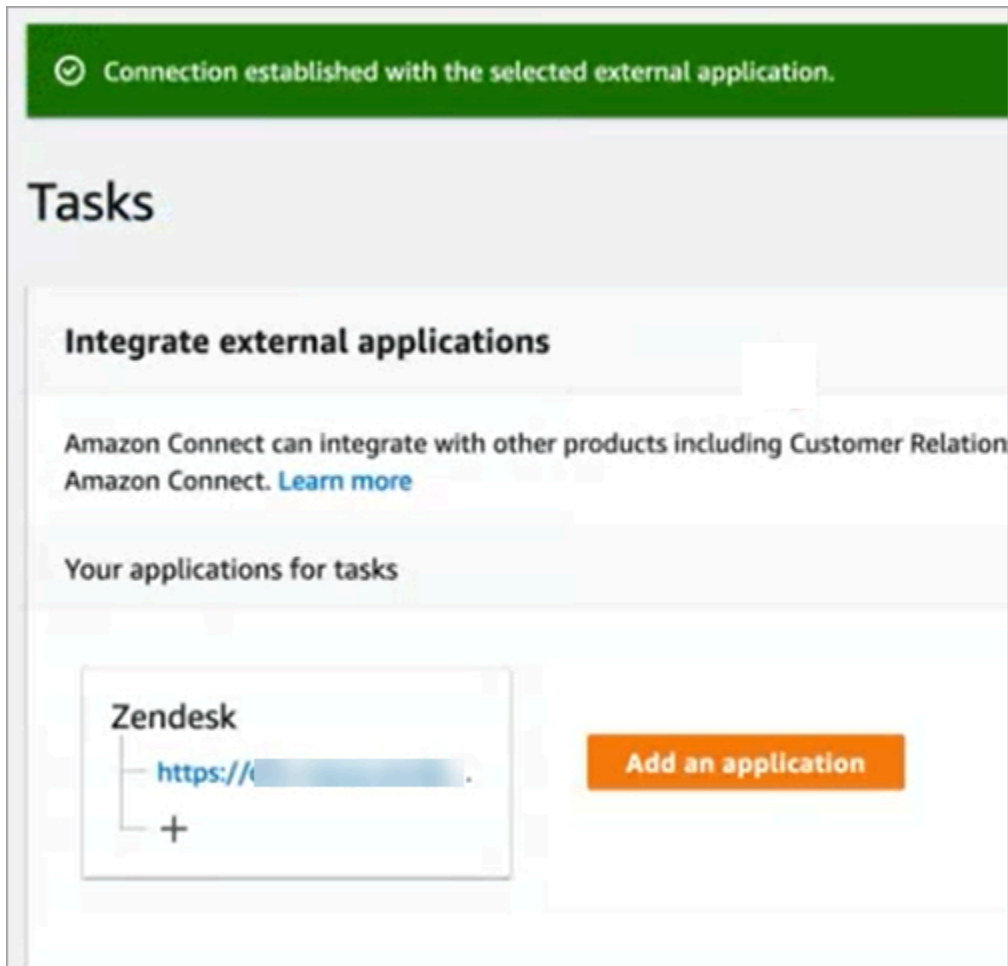

You're done! Next, add rules that tell Amazon Connect when to create a task and how to route it. For instructions, see [Create rules that generate tasks for third-party integrations](#).

What to do when is a connection isn't successfully established

A connection might fail to create a task if you do not correctly select the **Support ticket** event type when setting up the connection in Zendesk, after being prompted to do so in the flow. To fix this, log in to Zendesk, and update that setting, as shown in the following image.

Integrations > Amazon Web Services

Amazon Web Services

Configure the integration between your Zendesk Events Connector for Amazon EventBridge and your Amazon Web Services account through Amazon EventBridge in order to start receiving Zendesk business events.

Account ID and region
Enter your Amazon Web Services account ID and select the region for your account instance.

Amazon Web Services account ID
This is a 12 digit number

Amazon Web Services region
Recommended region US East (N. Virginia) ⓘ

US West (Oregon) ▾

Event types
Select which event types you would like your Amazon Web Services account to be subscribed to.

Support ticket

Support user

Support organization

Terms of Use

By connecting this integration you agree to the [Built by Zendesk Terms of Use](#) ⓘ

There is also another case where you may not have selected the correct AWS Region that the Amazon Connect instance is in, when setting up EventBridge. To fix:

1. Go to the EventBridge console at <https://console.aws.amazon.com/events/>.
2. Disconnect your EventBridge connection.
3. In the Amazon Connect console, restart the flow.

Monitor task creation

After your connection is established, if it stops working, in Amazon Connect disassociate the connection, and then re-establish it. If that doesn't solve the issue, do the following:

Zendesk

1. Go to the EventBridge console at <https://console.aws.amazon.com/events/>.
2. Check the status of the event source connection to see if it is active.

Salesforce

1. Go to the Amazon AppFlow console at <https://console.aws.amazon.com/appflow/>.
2. Monitor the flow that was created for the account that was set up.

The following image shows what a flow looks like in the Amazon AppFlow console for Salesforce. It contains information about the status of the connection, and when it was last run.

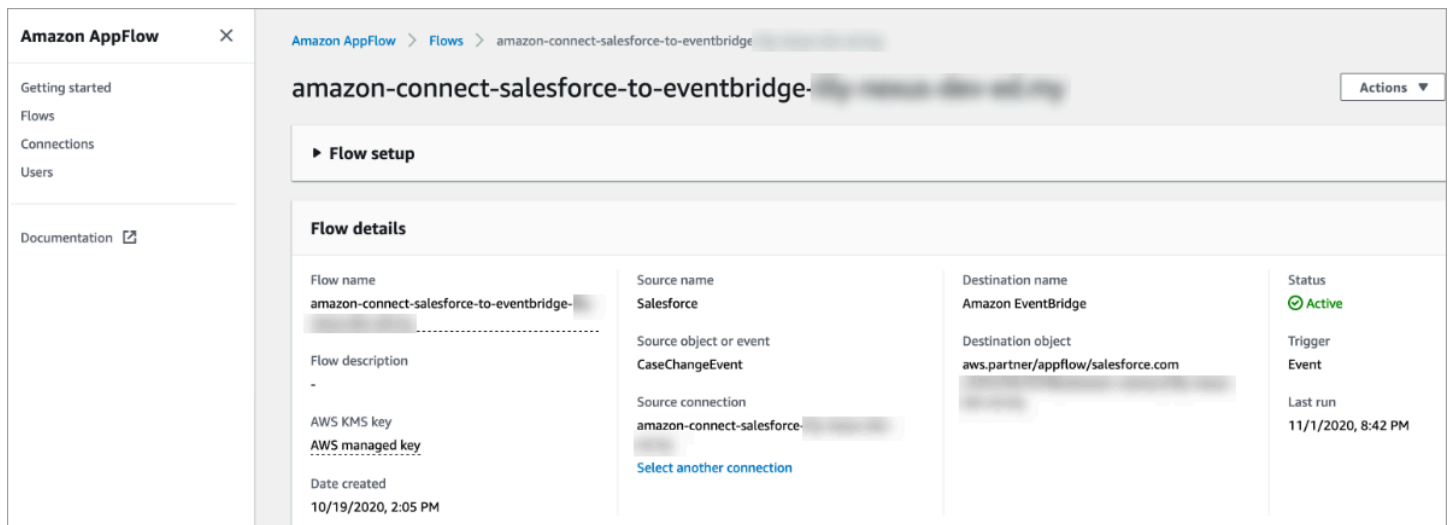

For both Zendesk and Salesforce, you can go to the EventBridge console at <https://console.aws.amazon.com/events/> to see your connection state and see if it is active, pending, or deleted.

The following image shows an example EventBridge console.

The screenshot shows the Amazon EventBridge console interface. On the left is a navigation menu with options like 'Events', 'Event buses', 'Rules', 'Partner event sources' (highlighted), 'Schema registry', 'Schemas', and 'Documentation'. The main area is titled 'Partner event sources (12)' and contains a search bar and a table of event sources. The table has three columns: 'Name', 'Status', and 'Event Bus'. The 'Status' column shows green checkmarks for 'Active' and red triangles for 'Deleted'.

Name	Status	Event Bus
aws.partner/appflow/salesforce.com/...	Active	aws.partner/appflow/salesforce.com/...
aws.partner/appflow/salesforce.com/...	Active	aws.partner/appflow/salesforce.com/...
aws.partner/appflow/salesforce.com/...	Active	aws.partner/appflow/salesforce.com/...
aws.partner/appflow/salesforce.com/...	Active	aws.partner/appflow/salesforce.com/...
aws.partner/appflow/salesforce.com/...	Active	aws.partner/appflow/salesforce.com/...
aws.partner/appflow/salesforce.com/...	Active	aws.partner/appflow/salesforce.com/...
aws.partner/appflow/salesforce.com/...	Active	aws.partner/appflow/salesforce.com/...
aws.partner/appflow/salesforce.com/...	Active	aws.partner/appflow/salesforce.com/...
aws.partner/appflow/salesforce.com/...	Active	aws.partner/appflow/salesforce.com/...
aws.partner/appflow/salesforce.com/...	Active	aws.partner/appflow/salesforce.com/...
aws.partner/zendesk.com/...	Active	aws.partner/zendesk.com/...
aws.partner/zendesk.com/...	Deleted	aws.partner/zendesk.com/...
aws.partner/zendesk.com/...	Deleted	aws.partner/zendesk.com/...
aws.partner/zendesk.com/...	Active	aws.partner/zendesk.com/...

Disassociate an Amazon Connect connection

At any time you can disassociate a connection, and stop the automatic generation of tasks based on events from the external application.

To stop the automatic generation of tasks

1. Choose the application, and then choose **Remove connection**.

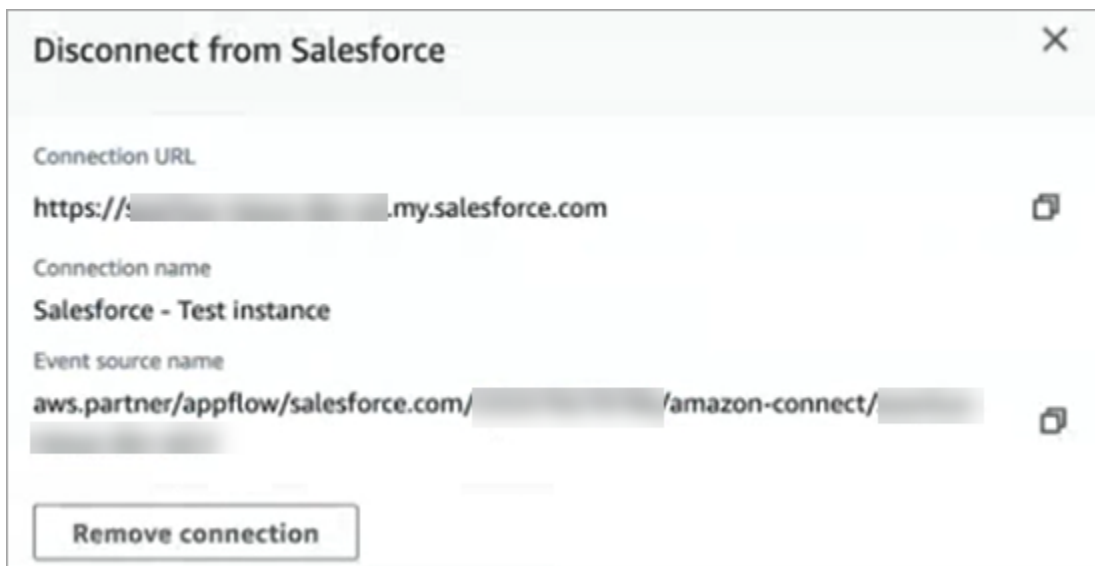

2. Type **Remove**, and then choose **Remove**.

If you need to debug, you are still able to go to Amazon AppFlow (Salesforce) or EventBridge.

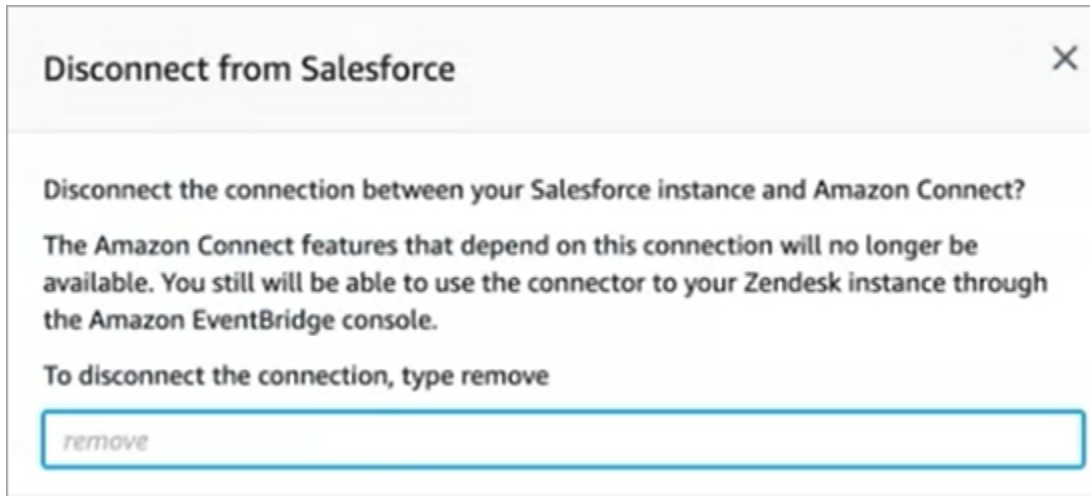

To remove the connection altogether from Zendesk

1. Log in to Zendesk, and navigate to [https://\[subdomain\].zendesk.com/admin/platform/integrations](https://[subdomain].zendesk.com/admin/platform/integrations).
2. Disconnect the EventBridge connection.

To remove the connection altogether from Salesforce

- Open the Amazon AppFlow console at <https://console.aws.amazon.com/appflow>, and delete the Salesforce connection and flow that were created in Amazon Connect.

Flows are created with the name pattern of amazon-connect-salesforce-to-eventbridge-[subdomain].

Connections are created with the name pattern of amazon-connect-salesforce-[subdomain]

To re-enable the automatic generation of tasks, repeat the setup steps.

Create Amazon Connect rules

A rule is an action that Amazon Connect automatically performs, based on conditions you specify. Contact center managers, supervisors and QA analysts can quickly create rules from the Amazon Connect console. No coding is required.

More information

- To create and manage rules programmatically, see [Rules actions](#) and the [Amazon Connect Rules Function language](#) in the *Amazon Connect API Reference Guide*.
- [Alert supervisors in real-time based on keywords and phrases mentioned during a call](#)
- [Automatically categorize contacts based on keywords and phrases used during a conversation](#)
- [Create a task when a contact is categorized in real-time or post-call/chat](#)
- [Create a Contact Lens rule that generates an EventBridge event](#)
- [Create Contact Lens rules that send email notifications](#)
- [Create supervisor alerts on agent performance](#)
- [Create alerts on real-time metrics](#)
- [Create rules that generate tasks for third-party integrations](#)

Create rules that generate tasks for third-party integrations

After you set up an external application to generate tasks automatically, you need to build rules that tell Amazon Connect when to create tasks, and how to route them.

1. Log in to Amazon Connect with a user account that is assigned the **CallCenterManager** security profile, or that is enabled for **Rules** permissions.
2. In Amazon Connect, on the navigation menu, choose **Rules**.
3. On the **Rules** page, use the **Create a rule** dropdown list to choose **External application**.
4. At the **Trigger and conditions** page, assign a name to the rule. Spaces are not allowed in the name of a rule.



New rule

Name

Account_creation|

Enter a name for the rule.
Spaces are not allowed.

Name can contain characters A-Z, 0-9, or '.', ',', '_'. It cannot contain spaces.

5. Choose the event that will generate a task, and the instance of the external application where the event must occur. For example, the following image shows the trigger is when a new ticket

is created in Zendesk. The condition that must be met is when the type equals a question. Then a task is generated.

Rules > New rule

1 Trigger and conditions — 2 Action

Name
Zendesk-Type-Question

When

A New ticket is created in Zendesk ▼ Zendesk - AWS instance a ▼

If these conditions are met:
All of these

Type

EQUALS ▼

✓ Select Type b
Question
Incident
Custom

+ Add condition

1. Select the instance for the external application.
2. Choose the conditions that must be met to generate the task.
6. Choose **Next**.
7. On the **Action** page, specify the task to be generated when the rule is met, as shown in the following image

The screenshot shows the 'Action' configuration page in the Amazon Connect console. At the top, there are two tabs: 'Trigger and conditions' (selected) and '2 Action'. Below the tabs, the heading 'Take these actions:' is followed by a 'Create task' section. This section is titled 'Define the schema of the task' and contains several input fields:

- Name:** A text field containing 'Zendesk-[ticket_id]'.
- Description:** A text field with a red circle 'a' next to it, currently empty.
- Task reference name:** A text field containing 'taskRef' with a red circle 'b' next to it.
- Task reference URL:** A text field containing 'https://[instance_name].zendesk.com/agents/tickets/[ticket_id]'.

 Below these fields is a '+ Add reference' button. At the bottom of the form, there is a section titled 'Select the flow that should route the task' with a dropdown menu currently set to 'Sample Lambda integration'.

1. The description of the task appears to the agent in their Contact Control Panel (CCP).
 2. The task reference name appears to the agent as a link to the specified URL.
8. Choose **Save**.

Test the rule

1. Go to the external application and create the event that initiates the action. For example, in Zendesk, create a ticket that's type **Question**.
2. Go to **Analytics and optimization, Contact search**.
3. Under **Channel**, choose **Task**, and then choose **Search**.
4. Verify the task was created.

Set up in-app, web, and video calling capabilities

The Amazon Connect in-app, web, and video calling capabilities enable your customers to contact you without ever leaving your web or mobile application. You can use these capabilities to pass contextual information to Amazon Connect. This enables you to personalize the customer experience based on attributes such as the customer's profile or other information, like actions previously taken within the app.

Communication widget: Configure chat, voice, and video all in one place

To set up in-app, web, and video calling, you use the **Communication widgets** page. It supports chat, voice, and video. The following image shows the **Communication options** section of the page when it's configured for all of these options.

Communication options

Choose how your customers can engage with your widget



Chat

Enable a chat experience for your customers. [Learn more](#)

Add chat
This will allow your customers to start a chat.

Allow message receipts
Enable customers to see when messages have been delivered and read.

Chat contact flow

Select the contact flow to initiate for the inbound chat. This will define the experience for your customers when they begin a new chat.

Select contact flow for chat ▼

Required



Web calling

Enable voice or video experiences for your customers. [Learn more](#)

Add web calling
This will allow your customer to make web calls.

Add video
This will allow your customers to use video while in a web call. Web calling is required to enable this feature.

Allow customers to see agent video

Allow customers to turn on their video

Web calling contact flow

Select the contact flow to initiate for the inbound web call. This will define the experience for your customers when they begin a new web call.

Select contact flow for web calling ▼

Required

How to set up in-app, web, and video calling

There are two ways to embed Amazon Connect in-app, web, and video calling onto your website or mobile application:

- [Option 1](#): Choose this option to set up an out-of-the-box communications widget. You can use the no-code UI builder to customize the font and colors, and secure the widget so that it can be launched only from your website.
- [Option 2](#): Choose this option to build a communications widget from scratch and integrate it with your mobile application or website. Use the Amazon Connect APIs and Amazon Chime SDK client APIs to integrate natively into your mobile application or website.

Note

If you have custom agent desktops, you don't need to make any changes for Amazon Connect in-app and web calling. However, you need to [integrate video calling](#).

Option 1: Configure an out-of-the-box communication widget

Use this option to create communication widgets for desktop and mobile [browsers](#). At the end of this procedure, Amazon Connect generates a custom HTML code snippet that you copy into your website's source code.

1. Log in to Amazon Connect admin website using an Admin account or a user account that has **Channels and flows, Communication widget - Create** permission in its security profile.
2. In Amazon Connect, on the left navigation menu, choose **Channels, Communication widgets**.
3. The wizard guides you through the next three steps.

Step 1: Select communication channels

1. On the **Communication widgets** page, enter a **Name** and **Description** for the communications widget.

Note

The Name must be unique for each communications widget created in an Amazon Connect instance.

- In the **Communications options** section, choose how your customers can engage with your widget. The following image shows options to allow web calling and video for customers.

Communication options
Choose how your customers can engage with your widget

Chat
Enable a chat experience for your customers. [Learn more](#)

Add chat
This will allow your customers to start a chat.

Allow message receipts
Enable customers to see when messages have been delivered and read.

Chat contact flow
Select the contact flow to initiate for the inbound chat. This will define the experience for your customers when they begin a new chat.

Select contact flow for chat

Required

Web calling
Enable voice or video experiences for your customers. [Learn more](#)

Add web calling
This will allow your customer to make web calls.

Add video
This will allow your customers to use video while in a web call. Web calling is required to enable this feature.

Allow customers to see agent video

Allow customers to turn on their video

Web calling contact flow
Select the contact flow to initiate for the inbound web call. This will define the experience for your customers when they begin a new web call.

Select contact flow for web calling

Required

- In the **Web calling** section, choose whether to enable voice or video experiences for your customers. The previous image shows Web calling options with video enabled for customers to see agent video and to allow customers to turn on their video.

4. Choose **Save and continue**.

Step 2: Customize widget

As you choose these options, the widget preview updates automatically so that you can see what the experience will look like for your customers.

Preview

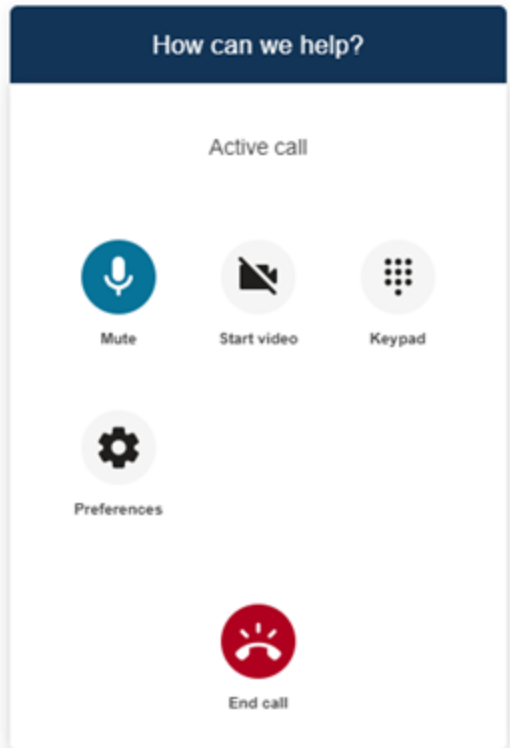

Define widget access button styles

1. Choose the colors for the button background by entering hex values ([HTML color codes](#)).
2. Choose **White** or **Black** for the icon color. The icon color can't be customized.

Customize display names and styles

1. Provide values for header message and color, and widget background color.
2. **Logo URL:** Insert a URL to your logo banner from an Amazon S3 bucket or another online source.

Note

The communications widget preview in the customization page will not display the logo if it's from an online source other than an Amazon S3 bucket. However, the logo will be displayed when the customized communications widget is implemented to your page.

The banner must be in .svg, .jpg or .png format. The image can be 280px (width) by 60px (height). Any image larger than those dimensions will be scaled to fit the 280x60 logo component space.

1. For instructions about how to upload a file such as your logo banner to S3, see [Uploading objects](#) in the *Amazon Simple Storage Service User Guide*.
2. Make sure that the image permissions are properly set so that the communications widget has permissions to access the image. For information about how to make a S3 object publicly accessible, see [Step 2: Add a bucket policy](#) in the *Setting permissions for website access* topic.

Step 3: Add your domain for the widget

This step enables you to secure the communications widget so that it can be launched only from your website.

1. Enter the website domains where you want to place the communications widget. The communications widget loads only on websites that you select in this step.

Choose **Add domain** to add up to 50 domains.

1 Add the required domains for the communication widget

Add the website domains where you want the communication widget to display. For example <https://www.yourcompany.com> or <https://support.yourcompany.com>.

This is required to validate the origin of the communication widget requests. [Learn more](#) 

1: 

2: 

[+ Add domain](#)



Important

- Double-check that your website URLs are valid and does not contain errors. Include the full URL starting with `https://`.
- We recommend using `https://` for your production websites and applications.

2. Under **Add security for your communications widget requests**, for the fastest setup experience choose **No - I will skip**.

We recommend choosing **Yes** for the ability to verify the user is authenticated. For more information, see [Passing attributes for in-app, web, and video calling](#).

3. Choose **Save and continue**.

Success! Your widget has been created. Copy the generated code and paste it on each page of your website where you want the communications widget to appear.

Enable your agents for in-app, web, and video-calling

To enable agents to use video calling, assign the **Contact Control Panel (CCP), Video calls - Access** permissions to their security profile.

The Amazon Connect agent workspace supports Amazon Connect in-app, web, and video calling. You can use the same configuration, routing, analytics, and agent application as with telephone calls and chats. To get started, the only step is to enable your agent's security profiles with the permissions to have video calls.

For custom agent desktops, there are no changes required for the Amazon Connect in-app and web calling. Enable your agent's security profiles with the permissions to have video calls, and follow the guide below on how to integrate video calling into your agent desktop.

How a client device initiates an in-app or web call

The following diagram shows the sequence of events for a client device (mobile application or browser) to initiate an in-app or web call.

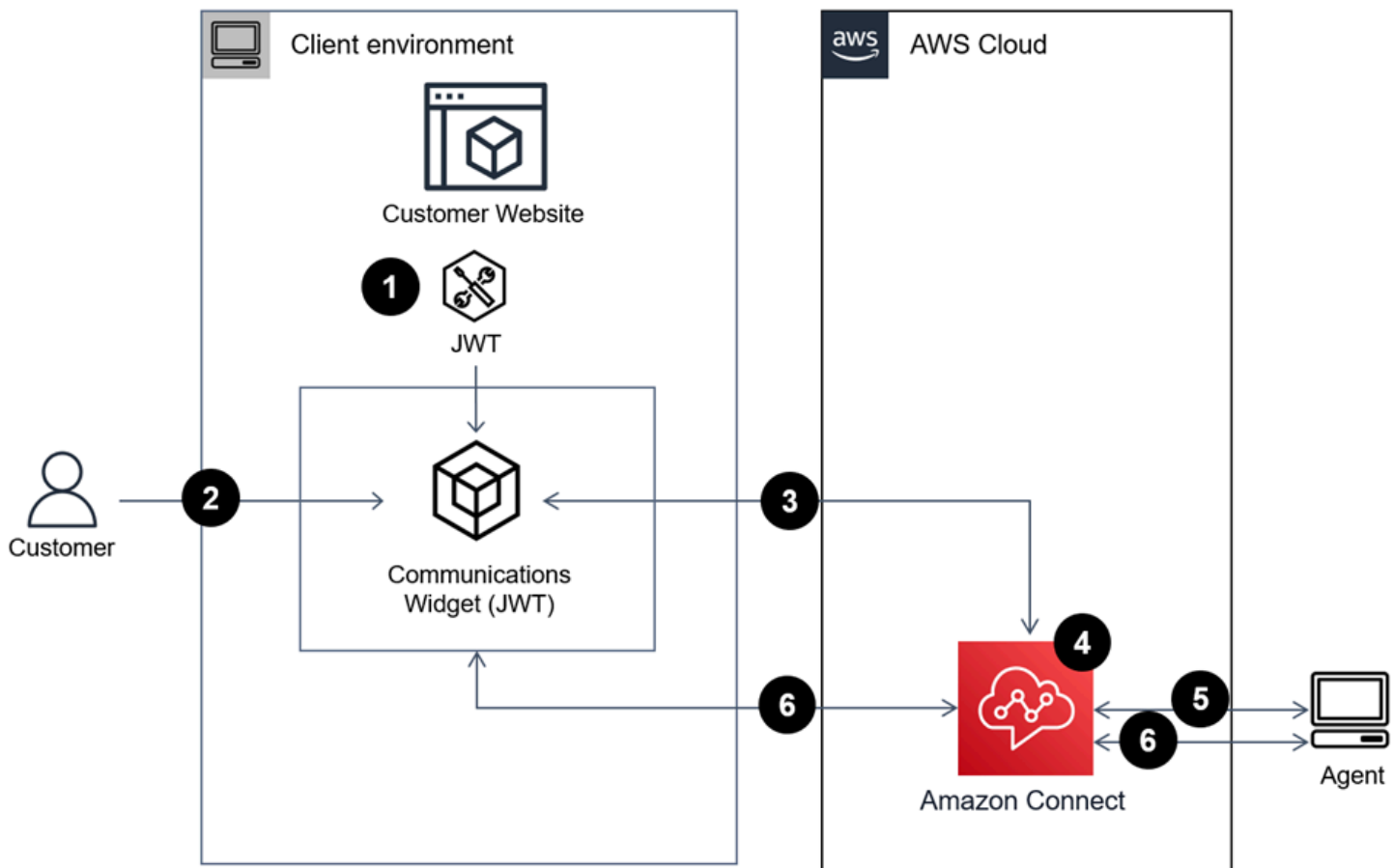

1. (Optional) You can pass attributes captured in the website and validate them with JSON web token (JWT).
2. The customer clicks on the communications widget in your website or mobile app.
3. The communications widget starts the web call to Amazon Connect by passing attributes contained in the JWT.
4. The contact reaches the flow, is routed, and placed in queue.
5. The agent accepts the contact.
6. (Optional) If video is enabled for customer and the agent, they are able to start their video.

More information

For additional information about requirements for in-app, web, and video calling capabilities, see the following topics:

- [Agent workstation networking requirements for web calling voice/video](#)
- [Supported browsers and mobile OS for in-app, web, and video calling capabilities](#)

Option 2: Integrate in-app, web, and video calling natively into your mobile application using the Amazon Chime SDK client APIs

To integrate Amazon Connect in-app, web, and video calling natively with your mobile application use the Amazon Connect [StartWebRTCContact](#) API to create the contact, and then use the details returned by the API call to join the call using the Amazon Chime client library for [iOS](#) or [Android](#).

How a client device initiates an in-app or web call

The following diagram shows the sequence of events for a client device (mobile application or browser) to initiate an in-app or web call.

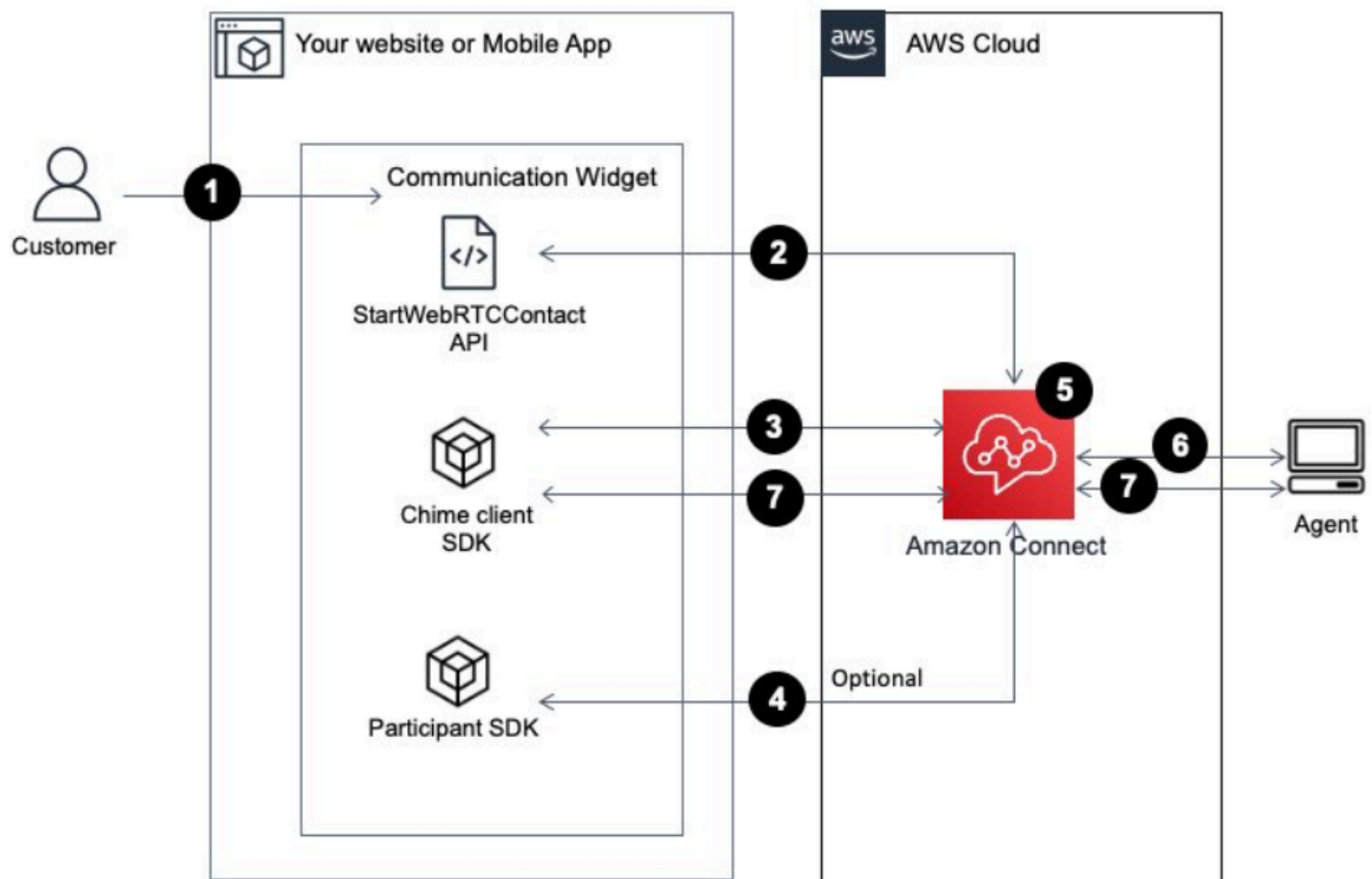

1. Your customer uses the client application (website or application) to start an in-app or web call.
2. The client application (website or mobile application) or web server uses the Amazon Connect [StartWebRTCContact](#) API to start the contact passing any attributes or context to Amazon Connect.
3. The client application joins the call using the details returned from the [StartWebRTCContact](#) in step 1.
4. (Optional) Client uses the [CreateParticipantConnection](#) API to receive a `ConnectionToken` that is used to send DTMF through the [SendMessage](#) API.
5. The contact reaches the flow and is routed based on the flow and placed in queue.
6. The agent accepts the contact.
7. (Optional) If video is enabled for customer and the agent, they are able to start their video.

Get started

Following are the high level steps to get started:

1. Use the [StartWebRTCContact](#) API to create the contact. The API returns the details needed for the Amazon Chime client SDK to join the call.
2. Instantiate the Amazon Chime SDK client `MeetingSessionConfiguration` object using the configurations returned by [StartWebRTCContact](#).
3. Instantiate Amazon Chime SDK client `DefaultMeetingSession` with `MeetingSessionConfiguration`, which was created in step 2 to create a client meeting session.
 - iOS (Swift)

```
let logger = ConsoleLogger(name: "logger")
let meetingSession = DefaultMeetingSession(configuration: meetingSessionConfig,
    logger: logger)
```

- Android (Kotlin)

```
val logger = ConsoleLogger()
val meetingSession = DefaultMeetingSession(
    configuration = meetingSessionConfig,
    logger = logger,
    context = applicationContext
)
```

4. Use the `meetingSession.audioVideo.start()` method to join the WebRTC contact with audio.
5. Use the `meetingSession.audioVideo.stop()` method to hangup the WebRTC contact.
6. Optional steps
 - a. To send DTMF to the call, two Amazon Connect Participant Service APIs are needed: [CreateParticipantConnection](#) and [SendMessage](#) respectively.

Note

`contentType` for the `SendMessage` API must be `audio/dtmf`.

- i. Invoke [CreateParticipantConnection](#) to retrieve ConnectionToken. (ParticipantToken is needed for calling this API. You can find it in the [StartWebRTCContact](#) response.)
- ii. With the ConnectionToken, call [SendMessage](#) for sending DTMF digits.
- b. For mute and unmute, use `meetingSession.audioVideo.realtimeLocalMute()` and `meetingSession.audioVideo.realtimeLocalUnmute()`.
- c. To start self video on the mobile application, use the `meetingSession.audioVideo.startLocalVideo()`.
- d. To stop self video on the mobile application, use the `meetingSession.audioVideo.stopLocalVideo()`.
- e. To allow receiving and loading video of the agent inside mobile application, use the `meetingSession.audioVideo.startRemoteVideo()`.
- f. To disallow receiving and loading video of the agent inside mobile application, use the `meetingSession.audioVideo.stopRemoteVideo()`.
- g. To select the audio input/output device, you can use the methods from the Amazon Chime SDK client for Android and iOS or the [native iOS capabilities](#) for iOS.

Passing attributes for in-app, web, and video calling

The steps in this topic are optional but recommended. They enable you to personalize the customer's experience based on their actions previously taken within your app. This option provides you more control when initiating new calls, including the ability to pass contextual information as attributes.

After doing these steps, you'll need to work with your website administrator to set up your web servers to issue JSON Web Tokens (JWTs) for new calls

1. If you've already created your communications widget, on the **Communication widgets** page, choose the widget to edit it.
2. In the **Domain & Security** section, choose **Edit**.
3. Under **Add security for your communications widget requests**, choose **Yes**.

2 Add security for new communication widget requests

We recommend using JSON web tokens to secure new communication widget requests. This provides you more control when initiating requests from the new communication widget, including the ability to verify that requests sent to Amazon Connect are from authenticated users. This implementation is typically completed by a website administrator. [Learn how to set this up.](#) 

Would you prefer to do this?

- Yes** 
- No - I will skip this step

4. Choose **Save and continue**. Amazon Connect creates the widget along with the following:
 - Amazon Connect provides a 44-character security key on the next page that you can use to create JWTs.
 - Amazon Connect adds a callback function within the communications widget embed script that checks for a JWT when a call is initiated.

You must implement the callback function in the embedded snippet, as shown in the following example.

```
amazon_connect('authenticate', function(callback) {
  window.fetch('/token').then(res => {
    res.json().then(data => {
      callback(data.data);
    });
  });
});
```

In the next step you'll get a security key for all calls initiated on your websites. Ask your website administrator to set up your web servers to issue JWTs using this security key.

5. Choose **Save and continue**.
6. Copy the custom HTML code snippet and insert it into your website's source code.

Alternate method: Pass contact attributes directly from snippet code

Note

Although these attributes are scoped with the `HostedWidget-` prefix, they are still mutable client-side. Use the JWT setup if you require PII or immutable data in your contact flow.

The following example shows how to pass contact attributes directly from snippet code without enabling widget security.

```
<script type="text/javascript">
  (function(w, d, x, id){ /* ... */})(window, document, 'amazon_connect', 'widgetId');
  amazon_connect('snippetId', 'snippetId');
  amazon_connect('styles', /* ... */);
  // ...

  amazon_connect('contactAttributes', {
    foo: 'bar'
  })
</script>
```

Using the attributes in contact flows

The [Check contact attributes](#) flow block provides access to these attributes via the **User defined** namespace, as shown in the following image. You can use the flow block to add branching logic. The full path is `$Attribute.HostedWidget-attributeName`.

The screenshot displays a workflow diagram on the left and a configuration panel on the right. The workflow starts with a 'Check contact attributes' block, which branches into 'Success' and 'Error' paths. The 'Success' path leads to a 'Valid' play prompt, and the 'Error' path leads to an 'Invalid' play prompt. The configuration panel on the right shows the following details:

- Block Type:** Check contact attributes
- Block Name:** Verify \$Attributes.HostedWidget-foo
- Branches based on a comparison to the value of a contact attribute.** [Learn more](#)
- Attribute to check:**
 - Namespace: User defined
 - Key: HostedWidget-foo
- Conditions to check:**
 - condition: Equals
 - value: bar

Copy communications widget code and security keys

In this step, you confirm your selections and copy the code for the communications widget and embed it in your website. You can also copy the secret keys for creating the JWTs.

Security key

Use this 44-character security key to generate JSON web tokens from your web server. You can also update, or rotate, keys if you need to change them. When you do this, Amazon Connect provides you with a new key and maintains the previous key until you have a chance to replace it. After you have the new key deployed, you can come back to Amazon Connect and delete the previous key.

The screenshot shows the 'Security key' section in the Amazon Connect console. It includes the following information:

- 2 Security key**
- To implement the backend security, use the secret key below which you can use to generate a JSON web token for use during the chat request. You can learn more about the steps required to implement a JSON web token [here](#).
- Security key:** [Redacted key] created on Mar 2, 2021
- [Copy key](#) button
- [View](#) link

When your customers interact with the start call icon on your website, the communications widget requests your web server for a JWT. When this JWT is provided, the widget will then include it as part of the end customer's call to Amazon Connect. Amazon Connect then uses the secret key to

decrypt the token. If successful, this confirms that the JWT was issued by your web server and Amazon Connect routes the call to your contact center agents.

JSON Web Token specifics

- Algorithm: **HS256**
- Claims:
 - **sub:** *widgetId*

Replace *widgetId* with your own *widgetId*. To find your *widgetId*, see the example [Communications widget script](#).

- **iat:** *Issued At Time.
- **exp:** *Expiration (10 minute maximum).

* For information about the date format, see the following Internet Engineering Task Force (IETF) document: [JSON Web Token \(JWT\)](#), page 5.

The following code snippet shows an example of how to generate a JWT in Python:

```
payload = {
    'sub': widgetId, // don't add single quotes, such as 'widgetId'
    'iat': datetime.utcnow(),
    'exp': datetime.utcnow() + timedelta(seconds=JWT_EXP_DELTA_SECONDS)
}

header = {
    'typ': "JWT",
    'alg': 'HS256'
}

encoded_token = jwt.encode((payload), CONNECT_SECRET, algorithm=JWT_ALGORITHM,
    headers=header) // CONNECT_SECRET is the security key provided by Amazon Connect
```

Communications widget script

The following image shows an example of the JavaScript that you embed on the websites where you want customers to be able to call your contact center. This script displays the widget in the bottom-right corner of your website.

The following image shows an example of where to find your widgetId.

Please follow these two steps to deploy your customized communication widget.

1 Widget script Copy script

Copy this generated code and paste it on each page of your website where you want the communication widget to appear.

```
<script type="text/javascript">
(function(w, d, x, id){
  s=d.createElement('script');
  s.src='https://dnczz2s468gpz.cloudfront.net/amazon-connect-chat-interface-client.js';
  s.async=1;
  s.id=id;
  d.getElementsByTagName('head')[0].appendChild(s);
  w[x] = w[x] || function() { (w[x].ac = w[x].ac || []).push(arguments) };
})(window, document, 'amazon_connect', '0a37cb74-e8e2-4700-bec7-c7cd222ece9e');
amazon_connect('styles', { iconType: 'CHAT_VOICE', openChat: { color: '#ffffff',
backgroundColor: '#123456' }, closeChat: { color: '#ffffff', backgroundColor: '#123456' }
});
amazon_connect('snippetId', 'QVFJREFIak...');
amazon_connect('supportedMessagingContentTypes', [ 'text/plain', 'text/markdown' ]);
</script>
```

When your website loads, customers first see the **Start** icon. When they choose this icon, the communications widget opens and customers are able to call your agents.

To make changes to the communications widget at any time, choose **Edit**.

Note

Saved changes update the customer experience in a few minutes. Confirm your widget configuration before saving it.

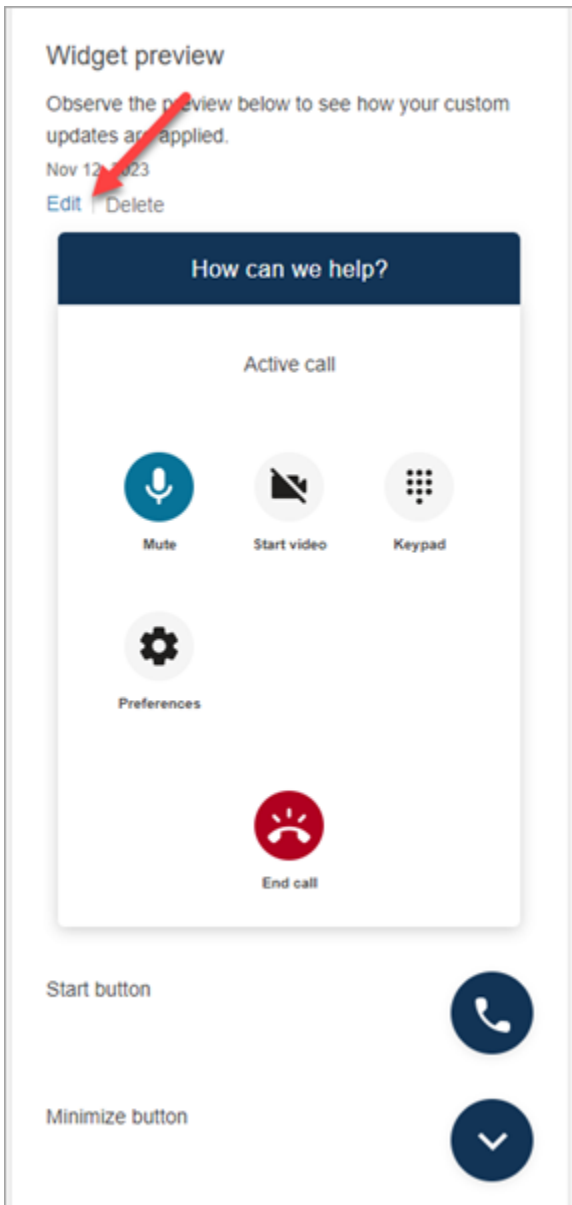

To make changes to widget icons on the website, you will receive a new code snippet to update your website directly.

Integrate video calling into your custom agent desktop

For custom agent desktops, you need to make changes to support video calling. Following are high level steps.

Note

If you embed the CCP directly into your custom agent application make sure `allowFramedVideoCall` is set to true when you initiate the CCP using [Amazon Connect Streams JS](#).

1. Use [Amazon Connect Streams JS](#) to check if the incoming contact is an WebRTC contact. Use contact subtype "connect:WebRTC", as shown in the following code example:

```
contact.getContactSubtype() === "connect:WebRTC"
```

2. You can retrieve the customer display name by using the name field in `contact`
`contact.getName()`.

Following are additional steps for video handling if your customers have enabled it on their end:

1. To check whether a contact has video capability:

```
// Return true if any connection has video send capability
contact.hasVideoRTCCapabilities()

// Return true if the agent connection has video send capability
contact.canAgentSendVideo()

// Return true if other non-agent connection has video send capability
contact.canAgentReceiveVideo()
```

2. To check on whether the agent has video permission to handle video call:

```
agent.getPermissions().includes('videoContact');
```

3. To accept a video call, the contact must have video capability and the agent must have video permission.

```
function shouldRenderVideoUI() {
  return contact.getContactSubtype() === "connect:WebRTC" &&
    contact.hasVideoRTCCapabilities() &&
    agent.getPermission().includes('videoContact');
}
```

4. In order to join a video session, call `getVideoConnectionInfo`:

```
if (shouldRenderVideoUI()) {
  const response = await
  contact.getAgentConnection().getVideoConnectionInfo();
}
```

5. To build a video UI and join a video meeting session, see:

- [Amazon Chime SDK for JavaScript](#) on GitHub
- [Amazon Chime SDK React Components Library](#) on GitHub

6. For simplicity, the following code snippets use examples from the Amazon Chime SDK React Components Library.

```
import { MeetingSessionConfiguration } from "amazon-chime-sdk-js";
import {
  useMeetingStatus,
  useMeetingManager,
  MeetingStatus,
  DeviceLabels,
  useLocalAudioOutput
} from 'amazon-chime-sdk-component-library-react';

const App = () => (
  <MeetingProvider>
    <MyVideoManager />
  </MeetingProvider>
);

const MyVideoManager = () => {
  const meetingManager = useMeetingManager();
  if (shouldRenderVideoUI()) {
    const response = await contact.getAgentConnection().getVideoConnectionInfo();
    const configuration = new MeetingSessionConfiguration(
      response.meeting, response.attendee);
    await meetingManager.join(configuration, { deviceLabels:
DeviceLabels.Video });
    await meetingManager.start();
  }

  function endContact() {
    meetingManager.leave();
  }
}
```

```
}
```

7. To render the video grid, use the [VideoTileGrid](#) from the Amazon Chime SDK React Components Library or customize the UI behavior using [RemoteVideoTileProvider](#).
8. To render a video preview, you can use [VideoPreview](#) and [CameraSelection](#) components. To choose or change a camera video, you can use `meetingManager.selectVideoInputDevice` or `meetingManager.startVideoInput` if the meeting is in progress.

```
const meetingManager = useMeetingManager();
const { isVideoEnabled } = useLocalVideo();
if (isVideoEnabled) {
  await meetingManager.startVideoInputDevice(current);
} else {
  meetingManager.selectVideoInputDevice(current);
}
```

9. To implement background blur, see [useBackgroundBlur](#).
10. For sample code on how to build a custom video experience, see this Amazon Chime SDK sample: [Amazon Chime React Meeting demo](#).

Set up your customer's chat experience

You can provide a chat experience to your customers by using one of the following methods:

- [Add a chat user interface to your website](#).
- [Download and customize our open source example](#).
- [Customize your solution using Amazon Connect APIs](#). We recommend starting with the Amazon Connect ChatJS open source library when customizing your own chat experiences. For more information, see the [Amazon Connect ChatJS](#) repo on Github.

More resources to customize the chat experience

- Interactive messages provide customers with a prompt and pre-configured display options that they can select from. These messages are powered by Amazon Lex and configured through Amazon Lex using a Lambda. For instructions about how to add interactive messages through Amazon Lex, see this blog: [Set up interactive messages for your Amazon Connect chatbot](#).

Amazon Connect supports the following templates: a list picker and a time picker. For more information, see [Add interactive messages to chat](#).

- [Enable Apple Messages for Business](#)
- [Amazon Connect Service API Documentation](#), especially the [StartChatContact](#) API.
- [Amazon Connect Participant Service API](#).
- [Amazon Connect Chat SDK and Sample Implementations](#)
- [Amazon Connect Streams](#). Use to integrate your existing apps with Amazon Connect. You can embed the Contact Control Panel (CCP) components into your app.

Add a chat user interface to your website

To support your customers through chat, you can add a communications widget to your website that is hosted by Amazon Connect. You can configure the communications widget in the Amazon Connect admin website. You can customize the font and colors, and secure the widget so that it can be launched only from your website. When finished, you will have a short code snippet that you add to your website.

Because Amazon Connect hosts the widget, it ensures that the latest version is always live on your website.

Tip

Use of the communications widget is subject to default service quotas, such as the number of required characters for each message. Before launching your communications widget into production, make sure that your service quotas are set for your organization's needs. For more information, see [Amazon Connect service quotas](#).

Topics

- [Supported widget snippet fields](#)
- [Supported browsers](#)
- [Step 1: Customize your communications widget](#)
- [Step 2: Specify the website domains where you expect to display the communications widget](#)
- [Step 3: Confirm and copy communications widget code and security keys](#)

- [Getting error messages?](#)
- [More customizations for your communications widget](#)
- [Customize widget launch behavior and button icon](#)
- [Pass the customer display name when a chat initializes](#)
- [Pass contact attributes when a chat initializes](#)
- [Alternative method: Pass contact attributes directly from snippet code](#)
- [Additional chat customizations](#)
- [Download Chat Transcript](#)
- [Download and customize our open source example](#)
- [Start chats using your own applications](#)
- [Browser notifications](#)
- [Pass custom properties to override the defaults in the communications widget](#)
- [Investigate common issues with adding a chat user interface to your website](#)

Supported widget snippet fields

The following table lists the communications widget snippet fields that you can customize. Example code after the table shows how to use the snippet fields.

Snippet field	Type	Description	Additional documentation
snippetId	String	Mandatory, auto-generated	n/a
styles	String	Mandatory, auto-generated	n/a
supported Messaging ContentTypes	Array	Mandatory, auto-generated	n/a
customLaunchBehavior	Object	Customize how your website renders and	Customize widget launch behavior and

Snippet field	Type	Description	Additional documentation
		launches the hosted widget icon	button icon , later in this topic
authenticate	Function	Callback function to enable JWT security on your website	Step 2: Specify the website domains where you expect to display the communications widget , earlier in this section.
customerDisplayName	Function	Pass the customer display name when initializing a contact	Pass the customer display name when a chat initializes , later in this section.
customStyles	Object	Override the default CSS styles	Pass custom properties to override the defaults in the communications widget , later in this section.
chatDurationInMinutes	Number	The total duration of the newly started chat session	Default: 1500 - Min 60, Max: 10080
enableLogs	Boolean	Enable the debugging logs	Default: false

Snippet field	Type	Description	Additional documentation
language	String	Connect can do translations for supported ISO-639 format language codes. For more information, see https://en.wikipedia.org/wiki/List_of_ISO_639-1_codes .	Default: en_US. Supported: 'de_DE', 'en_US', 'es_ES', 'fr_FR', 'id_ID', 'it_IT', 'ja_JP', 'ko_KR', 'pt_BR', 'zh_CN'
nonce	String	Handshake value between iframe and customer website csp policy. Example: customer csp allows 1234 nonce value, iframe which pulls in another script must have the same 1234 nonce value so that browser knows it is a trusted script by iframe parent site.	Default: undefined
customizationObject	Object	Customize the widget layout and transcript	For more information, see Additional chat customizations , later in this section.
contactAttributes	Object	Pass attributes to the contact flow directly from snippet code, without any JWT setup	For more information, see Pass contact attributes when a chat initializes .

Snippet field	Type	Description	Additional documentation
customDisplayNames	Object	Override the System or Bot display name and logo configurations set in the Amazon Connect admin website.	For more information, see How to pass override system and bot display names and logos for the communications widget .

The following example shows how to add snippet fields to the HTML script that adds the chat widget to your web site.

```
<script type="text/javascript">
(function(w, d, x, id){ /* ... */})(window, document, 'amazon_connect', 'widgetId');
  amazon_connect('snippetId', 'snippetId');
  amazon_connect('styles', /* ... */);
  // ...
  amazon_connect('snippetFieldHere', /* ... */)
</script/>
```

Supported browsers

The pre-built communications widget supports the following browser versions and higher:

- Google Chrome 85.0
- Safari 13.1
- Microsoft Edge version 85
- Mozilla Firefox 81.0

The communications widget supports browser notifications for desktop devices. For more information, see [Browser notifications](#).

Step 1: Customize your communications widget

In this step, you customize the experience of the communications widget for your customers.

1. Log in to the Amazon Connect admin website at https://instance_name.my.connect.aws/. Choose **Customize communications widget**.

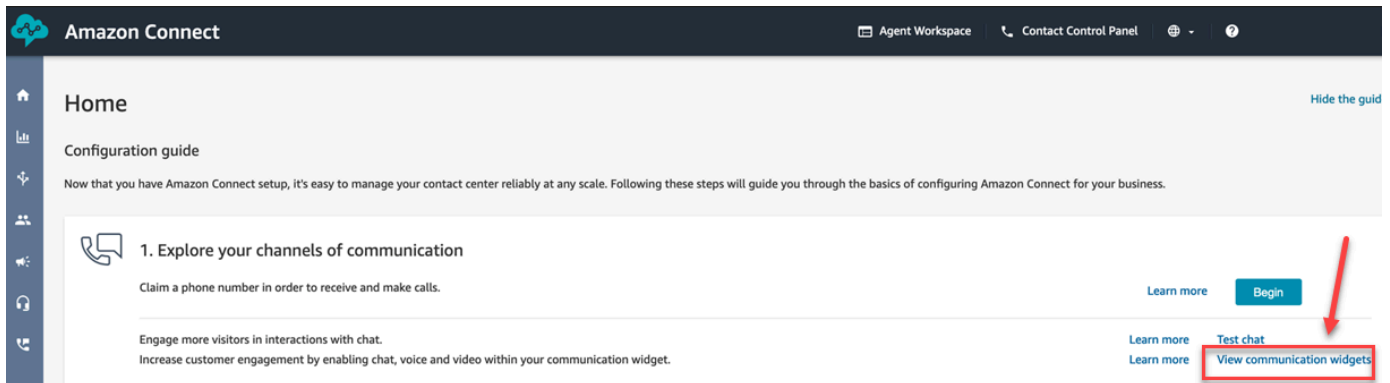

2. On the **Communications widgets** page, choose **Add communications widget** to begin customizing a new communications widget experience. To edit, delete, or duplicate an existing communications widget, choose from the options under the **Actions** column, as shown in the following image.

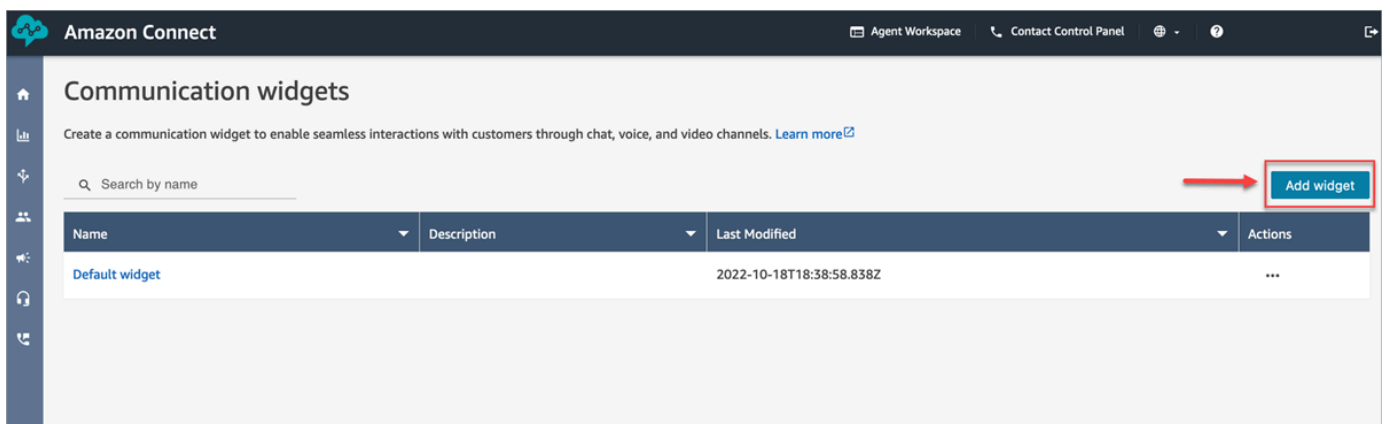

3. Enter a **Name** and **Description** for the communications widget.

Note

The Name must be unique for each communications widget created in an Amazon Connect instance.

4. In the **Communications options** section, choose how your customers can engage with your widget, and then choose **Save and continue**. The following image shows options to allow chat and message receipts for customers.

Communication options

Choose how your customers can engage with your widget

Chat

Enable a chat experience for your customers. [Learn more](#)

Add chat
This will allow your customers to start a chat.

Allow message receipts
Enable customers to see when messages have been delivered and read.

Chat contact flow
Select the contact flow to initiate for the inbound chat. This will define the experience for your customers when they begin a new chat.

Select contact flow for chat ▼

Required

Web calling

Enable voice or video experiences for your customers. [Learn more](#)

Add web calling
This will allow your customer to make web calls.

Add video
This will allow your customers to use video while in a web call. Web calling is required to enable this feature.

Allow customers to see agent video

Allow customers to turn on their video

Web calling contact flow
Select the contact flow to initiate for the inbound web call. This will define the experience for your customers when they begin a new web ca

Select contact flow for web calling ▼

Required

5. On the **Create communication widget** page, choose the widget button styles, and display names and styles.

As you choose these options, the widget preview updates automatically so that you can see what the experience will look like for your customers.

Preview

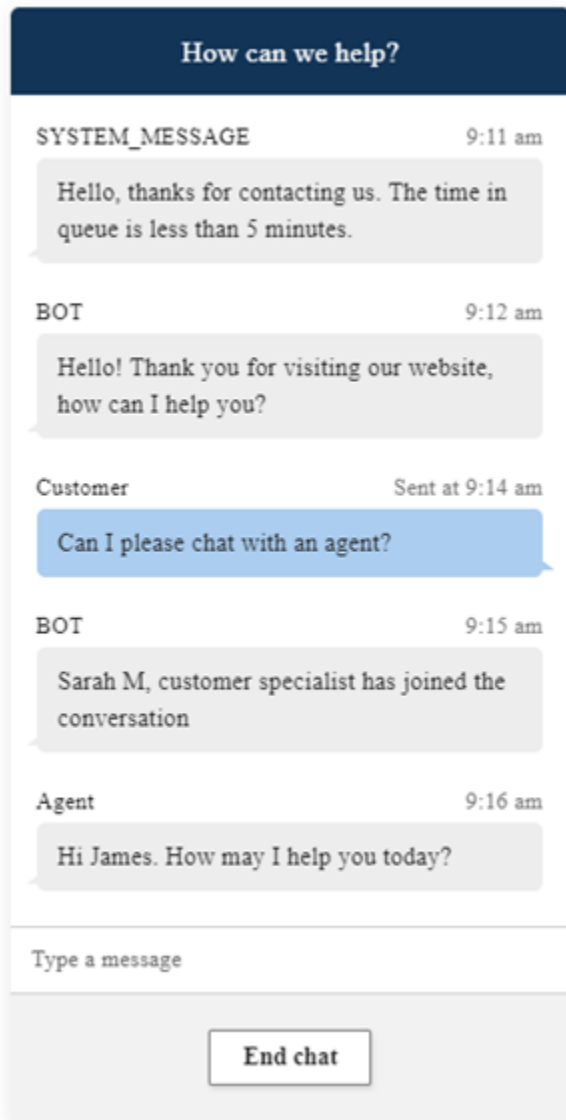

Button styles

1. Choose the colors for the button background by entering hex values ([HTML color codes](#)).
2. Choose **White** or **Black** for the icon color. The icon color can't be customized.

Widget header

1. Provide values for header message and color, and widget background color.
2. **Logo URL:** Insert a URL to your logo banner from an Amazon S3 bucket or another online source.

Note

The communications widget preview in the customization page will not display the logo if it's from an online source other than an Amazon S3 bucket. However, the logo will be displayed when the customized communications widget is implemented to your page.

The banner must be in .svg, .jpg or .png format. The image can be 280px (width) by 60px (height). Any image larger than those dimensions will be scaled to fit the 280x60 logo component space.

1. For instructions about how to upload a file such as your logo banner to S3, see [Uploading objects](#) in the *Amazon Simple Storage Service User Guide*.
2. Make sure that the image permissions are properly set so that the communications widget has permissions to access the image. For information about how to make a S3 object publicly accessible, see [Step 2: Add a bucket policy](#) in the *Setting permissions for website access* topic.

Chat view

1. **Typeface:** Use the dropdown to choose the font for the text in the communications widget.
2.
 - **System Message Display Name:** Type a new display name to override the default. The default is **SYSTEM_MESSAGE**.
 - **Bot Message Display Name:** Type a new display name to override the default. The default is **BOT**.
 - **Text Input Placeholder:** Type new placeholder text override the default. The default is **Type a message**.
 - **End Chat Button Text:** Type new text to replace the default. The default is **End chat**.
3. **Agent chat bubble color:** Choose the colors for the agent's message bubbles by entering hex values ([HTML color codes](#)).
4. **Customer chat bubble color:** Choose the colors for the customer's message bubbles by entering hex values ([HTML color codes](#)).
5. Choose **Save and continue**.

Step 2: Specify the website domains where you expect to display the communications widget

1. Enter the website domains where you want to place the communications widget. Chat loads only on websites that you select in this step.

Choose **Add domain** to add up to 50 domains.

1 Add the required domains for the communication widget

Add the website domains where you want the communication widget to display. For example <https://www.yourcompany.com> or <https://support.yourcompany.com>.

This is required to validate the origin of the communication widget requests. [Learn more](#) 

1: 

2: 

[+ Add domain](#)



Important

- Double-check that your website URLs are valid and does not contain errors. Include the full URL starting with `https://`.
- We recommend using `https://` for your production websites and applications.

2. Under **Add security for your communications widget**, we recommend choosing **Yes**, and working with your website administrator to set up your web servers to issue JSON Web Tokens (JWTs) for new chat requests. This provides you more control when initiating new chats, including the ability to verify that chat requests sent to Amazon Connect are from authenticated users.

2 Add security for new communication widget requests

We recommend using JSON web tokens to secure new communication widget requests. This provides you more control when initiating requests from the new communication widget, including the ability to verify that requests sent to Amazon Connect are from authenticated users. This implementation is typically completed by a website administrator. [Learn how to set this up.](#) 

Would you prefer to do this?

- Yes** 
- No - I will skip this step

Choosing **Yes** results in the following:

- Amazon Connect provides a 44-character security key on the next page that you can use to create JSON Web Tokens (JWTs).
- Amazon Connect adds a callback function within the communications widget embed script that checks for a JSON Web Token (JWT) when a chat is initiated.

You must implement the callback function in the embedded snippet, as shown in the following example.

```
amazon_connect('authenticate', function(callback) {
  window.fetch('/token').then(res => {
    res.json().then(data => {
      callback(data.data);
    });
  });
});
```

If you choose this option, in the next step you'll get a security key for all chat requests initiated on your websites. Ask your website administrator to set up your web servers to issue JWTs using this security key.

3. Choose **Save**.

Step 3: Confirm and copy communications widget code and security keys

In this step, you confirm your selections and copy the code for the communications widget and embed it in your website. If you chose to use JWTs in [Step 2](#), you can also copy the secret keys for creating them.

Security key

Use this 44-character security key to generate JSON web tokens from your web server. You can also update, or rotate, keys if you need to change them. When you do this, Amazon Connect provides you with a new key and maintains the previous key until you have a chance to replace it. After you have the new key deployed, you can come back to Amazon Connect and delete the previous key.



When your customers interact with the Start chat icon on your website, the communications widget requests your web server for a JWT. When this JWT is provided, the widget will then include it as part of the end customer's chat request to Amazon Connect. Amazon Connect then uses the secret key to decrypt the token. If successful, this confirms that the JWT was issued by your web server and Amazon Connect routes the chat request to your contact center agents.

JSON Web Token specifics

- Algorithm: **HS256**
- Claims:
 - **sub:** *widgetId*

Replace *widgetId* with your own *widgetId*. To find your *widgetId*, see the example at [Communications widget script](#).

- **iat:** *Issued At Time.
- **exp:** *Expiration (10 minute maximum).

* For information about the date format, see the following Internet Engineering Task Force (IETF) document: [JSON Web Token \(JWT\)](#), page 5.

The following code snippet shows an example of how to generate a JWT in Python:

```
payload = {
    'sub': widgetId, // don't add single quotes, such as 'widgetId'
    'iat': datetime.utcnow(),
    'exp': datetime.utcnow() + timedelta(seconds=JWT_EXP_DELTA_SECONDS)
}

header = {
    'typ': "JWT",
    'alg': 'HS256'
}

encoded_token = jwt.encode((payload), CONNECT_SECRET, algorithm=JWT_ALGORITHM,
    headers=header) // CONNECT_SECRET is the security key provided by Amazon Connect
```

Communications widget script

The following image shows an example of the JavaScript that you embed on the websites where you want customers to chat with agents. This script displays the widget in the bottom-right corner of your website.

Please follow these two steps to deploy your customized communication widget.

1 Widget script

[Copy script](#)

Copy this generated code and paste it on each page of your website where you want the communication widget to appear.

```
<script type="text/javascript">
(function(w, d, x, id){
  s=d.createElement('script');
  s.src='https://dnczz2s468gpz.cloudfront.net/amazon-connect-chat-interface-client.js';
  s.async=1;
  s.id=id;
  d.getElementsByTagName('head')[0].appendChild(s);
  w[x] = w[x] || function() { (w[x].ac = w[x].ac || []).push(arguments) };
})(window, document, 'amazon_connect', '0a37cb74-e8e2-4700-bec7-c7cd222ece9e');
amazon_connect('styles', { iconType: 'CHAT_VOICE', openChat: { color: '#ffffff',
backgroundColor: '#123456' }, closeChat: { color: '#ffffff', backgroundColor: '#123456' }
});
amazon_connect('snippetId', 'QVFJREFIak...');
amazon_connect('supportedMessagingContentTypes', [ 'text/plain', 'text/markdown' ]);
</script>
```

When your website loads, customers first see the **Start** icon. When they choose this icon, the communications widget opens and customers are able to send a message to your agents.

To make changes to the communications widget at any time, choose **Edit**.

Note

Saved changes update the customer experience in a few minutes. Confirm your widget configuration before saving it.

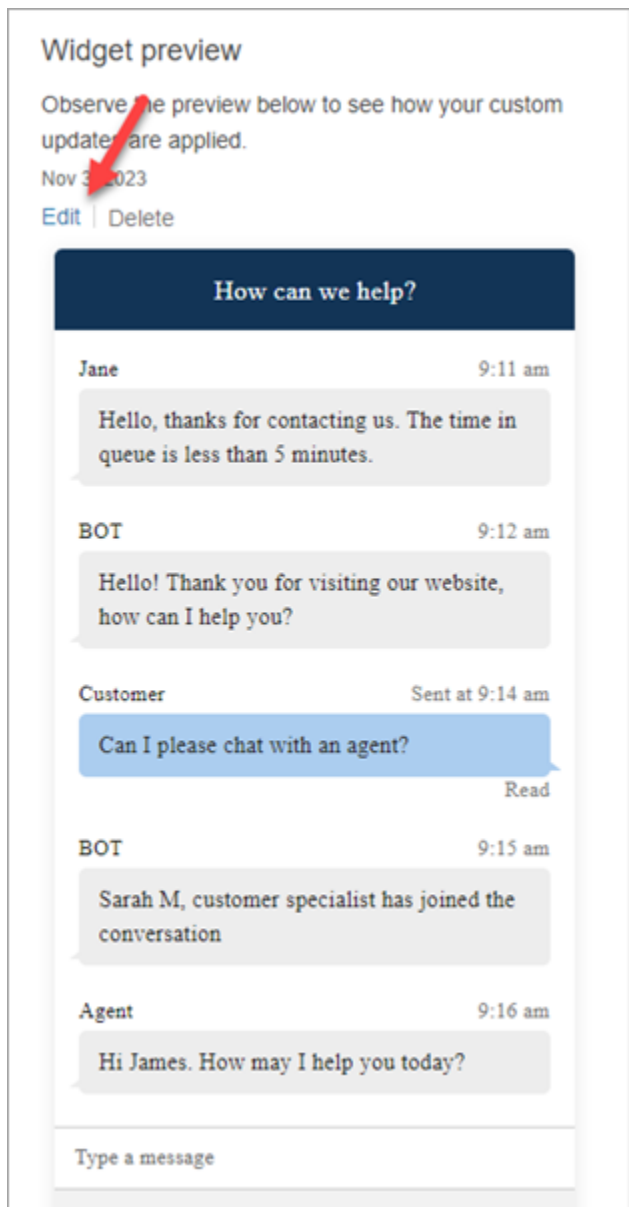

To make changes to widget icons on the website, you will receive a new code snippet to update your website directly.

Getting error messages?

If you encounter error messages, see [Investigate common issues with adding a chat user interface to your website.](#)

More customizations for your communications widget

See the following topics for more you can do to customize the chat experience:

- [Customize widget launch behavior and button icon](#)
- [Pass the customer display name when a chat initializes](#)
- [Pass contact attributes when a chat initializes](#)
- [Enable message *Delivered* and *Read* receipts in your chat user interface](#)

Customize widget launch behavior and button icon

To further customize how your website renders and launches the hosted widget icon, you can configure the launch behavior and hide the default icon. For example, you can programmatically launch the widget from a **Chat with us** button element that is rendered on your website.

Topics

- [How to configure custom launch behavior for the widget](#)
- [Supported options and constraints](#)
- [Configure widget launch for custom use cases](#)

How to configure custom launch behavior for the widget

To pass custom launch behavior, use the following example code block and embed it in your widget. All of the fields shown in the following example are optional and any combination can be used.

```
amazon_connect('customLaunchBehavior', {
  skipIconButtonAndAutoLaunch: true,
  alwaysHideWidgetButton: true,
  programmaticLaunch: (function(launchCallback) {
    var launchWidgetBtn = document.getElementById('launch-widget-btn');
    if (launchWidgetBtn) {
      launchWidgetBtn.addEventListener('click', launchCallback);
      window.onunload = function() {
        launchWidgetBtn.removeEventListener('click', launchCallback);
        return;
      }
    }
  })
});
```

Supported options and constraints

The following table lists the supported custom launch behavior options. Fields are optional and any combination can be used.

Option name	Type	Description	Default value
skipIconButtonAndAutoLaunch	Boolean	A flag to enable/disable the automatic launch of the widget without the user clicking on the page load.	undefined
alwaysHideWidgetButton	Boolean	A flag to enable/disable the widget icon button from rendering (unless there is an ongoing chat session).	undefined
programmaticLaunch	Function		undefined

Configure widget launch for custom use cases

Custom widget launch button

The following example shows changes you would need to make in the widget to configure programmatic launch to open only when the user chooses a custom button element rendered anywhere on your website. For example, they may choose a button named **Contact Us** or **Chat With Us**. Optionally, you can hide the default Amazon Connect widget icon until the widget has been opened.

```
<button id="launch-widget-btn">Chat With Us</button>
```

```
<script type="text/javascript">
(function(w, d, x, id){
```

```

s=d.createElement("script");
s.src="./amazon-connect-chat-interface-client.js"
s.async=1;
s.id=id;
d.getElementsByTagName("head")[0].appendChild(s);
w[x] = w[x] || function() { (w[x].ac = w[x].ac || []).push(arguments) };
})(window, document, 'amazon_connect', 'asfd-asdf-asfd-asdf-asdf');
amazon_connect('styles', { openChat: { color: '#000', backgroundColor: '#3498fe'},
closeChat: { color: '#fff', backgroundColor: '#123456'} });
amazon_connect('snippetId', "QVFJREFsdafsdafsdfasdfsadfasdfsadfasdfz0=")
amazon_connect('customLaunchBehavior', {
  skipIconButtonAndAutoLaunch: true,
  alwaysHideWidgetButton: true,
  programmaticLaunch: (function(launchCallback) {
    var launchWidgetBtn = document.getElementById('launch-widget-btn');
    if (launchWidgetBtn) {
      launchWidgetBtn.addEventListener('click', launchCallback);
      window.onunload = function() {
        launchWidgetBtn.removeEventListener('click', launchCallback);
        return;
      }
    }
  })
});
</script>

```

Hyperlink support

The following example shows changes you would need to make in the widget configure auto-launch, which opens the widget without waiting for the user to click. You can deploy to a page that hosted by your website to create a shareable hyperlink.

```
https://example.com/contact-us?autoLaunchMyWidget=true
```

```

<script type="text/javascript">
(function(w, d, x, id){
  s=d.createElement("script");
  s.src="./amazon-connect-chat-interface-client.js"
  s.async=1;
  s.id=id;
  d.getElementsByTagName("head")[0].appendChild(s);
  w[x] = w[x] || function() { (w[x].ac = w[x].ac || []).push(arguments) };

```

```

})(window, document, 'amazon_connect', 'asfd-asdf-asfd-asdf-asdf');
amazon_connect('styles', { openChat: { color: '#000', backgroundColor: '#3498fe'},
closeChat: { color: '#fff', backgroundColor: '#123456'} });
amazon_connect('snippetId', "QVFJREFsdafsdafsadfsdafasdfasdfsda fasdfz0=")
amazon_connect('customLaunchBehavior', {
    skipIconButtonAndAutoLaunch: true
});
</script>

```

Load widget assets when button is clicked

The following example shows changes you would need to make in the widget to make your website page load faster by fetching the widget's static assets when a user clicks the **Chat With Us** button. Typically, only small percentage of customers visiting a **Contact Us** page open the Amazon Connect widget. The widget could be adding latency on page load by fetching files from CDN, even though customers never open the widget.

An alternative solution is to run the snippet code asynchronously (or never) on button click.

```
<button id="launch-widget-btn">Chat With Us</button>
```

```

var buttonElem = document.getElementById('launch-widget-btn');

buttonElem.addEventListener('click', function() {
  (function(w, d, x, id){
    s=d.createElement("script");
    s.src="./amazon-connect-chat-interface-client.js"
    s.async=1;
    s.id=id;
    d.getElementsByTagName("head")[0].appendChild(s);
    w[x] = w[x] || function() { (w[x].ac = w[x].ac || []).push(arguments) };
  })(window, document, 'amazon_connect', 'asfd-asdf-asfd-asdf-asdf');
  amazon_connect('styles', { openChat: { color: '#000', backgroundColor: '#3498fe'},
closeChat: { color: '#fff', backgroundColor: '#123456'} });
  amazon_connect('snippetId', "QVFJREFsdafsdafsadfsdafasdfasdfsda fasdfz0=")
  amazon_connect('customLaunchBehavior', {
    skipIconButtonAndAutoLaunch: true
  });
});
});

```

Launch a new chat in a browser window

The following example shows changes you would need to make in the widget to launch a new browser window and auto-launch chat in a full screen.

```
<button id="openChatWindowButton">Launch a Chat</button>
```

```
<script> // Function to open a new browser window with specified URL and dimensions
function openNewWindow() {
    var url = 'https://mycompany.com/support?autoLaunchChat=true';

    // Define the width and height
    var width = 300;
    var height = 540;

    // Calculate the left and top position to center the window
    var left = (window.innerWidth - width) / 2;
    var top = (window.innerHeight - height) / 2;

    // Open the new window with the specified URL, dimensions, and position
    var newWindow = window.open(url, '', 'width=${width}, height=${height}, left=
${left}, top=${top}');
}

// Attach a click event listener to the button
document.getElementById('openChatWindowButton').addEventListener('click',
openNewWindow);
</script>
```

Pass the customer display name when a chat initializes

To deliver a more personalized experience for both your customers and agents, you can customize the Amazon Connect communications widget to pass the customer display name during contact initialization. The name is visible to both the customer and agent throughout the chat interaction. This display name is recorded in the chat transcript.

The following images show the customer's display name in their chat experience, and their name in the agent's CCP.

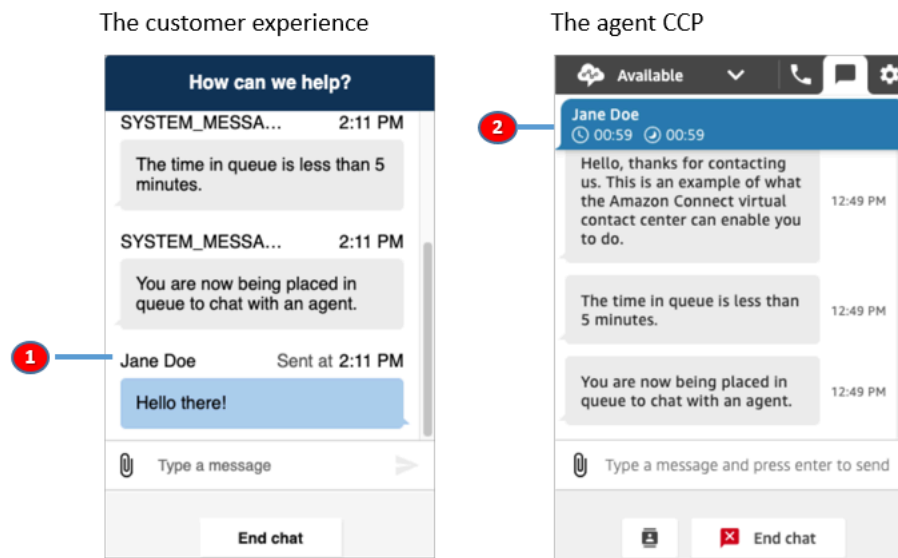

1. How the customer display name may appear to the customer using the chat user interface.
2. How the customer display name may appear to the agent using the CCP.

How to pass a customer display name in the communications widget

To pass a customer display name, implement your callback function in the snippet. Amazon Connect retrieves the display name automatically.

1. Complete the steps in [Add a chat user interface to your website](#), if you haven't already.
2. Augment your existing widget snippet to add a `customerDisplayName` callback. It might look something like the following example:

```
amazon_connect('customerDisplayName', function(callback) {
  const displayName = 'Jane Doe';
  callback(displayName);
});
```

The important thing is that the name is passed to `callback(name)`.

Things you need to know

- Only one `customerDisplayName` function can exist at a time.
- The customer display name must follow the limitations set by the [StartChatConnect](#) API. That is, the name must be a string between 1 and 256 characters.

- An empty string, null, or undefined is invalid input for the display name. To protect against accidentally passing of these inputs, the widget logs an error, `Invalid customerDisplayName provided`, in the browser console, and then starts the chat with the default display name, **Customer**.
- Because the snippet is in the front end of your website, do not pass sensitive data as the display name. Be sure to follow the appropriate security practices to keep your data safe and protect against attacks and bad actors.

Pass contact attributes when a chat initializes

You can use [contact attributes](#) to capture information about the contact who is using the communications widget. Then, you can display that information to the agent through the Contact Control Panel (CCP), or use it elsewhere in the flow.

For example, you can customize your flow to say the name of the customer in your welcome message. Or, you can use attributes specific to your business, such as account/member IDs, customer identifiers like names and emails, or other metadata associated with a contact.

How to pass contact attributes into the communications widget

1. Enable security in the communications widget as described in [Add a chat user interface to your website](#), if you haven't already:
 - a. In Step 2, under **Add security for your chat widget**, choose **Yes**.
 - b. In Step 3, use the security key to generate JSON web tokens.
2. Add the contact attributes to the payload of your JWT as an `attributes` claim.

Following is an example of how you might generate a JWT with contact attributes in Python:

```
import jwt

CONNECT_SECRET = "your-securely-stored-jwt-secret"

payload = {
    'sub': 'widget-id',
    'iat': datetime.datetime.utcnow(),
    'exp': datetime.datetime.utcnow() + datetime.timedelta(seconds=500),
    'attributes': {"name": "Jane", "memberID": "123456789", "email":
        "Jane@example.com", "isPremiumUser": "true", "age": "45"}
}
```

```
header = {
  'typ': "JWT",
  'alg': 'HS256'
}

encoded_token = jwt.encode((payload), CONNECT_SECRET, algorithm="HS256",
  headers=header)
```

In the payload, you must create a string key attributes (as-is, all lowercase), with an object as its value. That object must have string-to-string key-value pairs. If anything other than a string is passed in any one of the attributes, the chat will fail to start.

The contact attributes must follow the limitations set by the [StartChatConnect](#) API:

- Keys must have a minimum length of 1
- Values can have a minimum length of 0

Alternative method: Pass contact attributes directly from snippet code

Note

- The snippet code prepends `HostedWidget-` to all the contact attribute keys that it passes. In the following example, the agent side will see the key value pair `HostedWidget-foo: 'bar'`.
- Although these attributes are scoped with the `HostedWidget-` prefix, they are still mutable client-side. Use the JWT setup if you require PII or immutable data in your contact flow.

The following example shows how to pass contact attributes directly from snippet code without enabling widget security.

```
<script type="text/javascript">
  (function(w, d, x, id){ /* ... */})(window, document, 'amazon_connect', 'widgetId');
  amazon_connect('snippetId', 'snippetId');
  amazon_connect('styles', /* ... */);
  // ...
```

```
amazon_connect('contactAttributes', {
  foo: 'bar'
})
</script/>
```

Using the attributes in contact flows

The [Check contact attributes](#) flow block provides access to these attributes via the **User defined** namespace, as shown in the following image. You can use the flow block to add branching logic. The full path is `$.Attributes.HostedWidget-attributeName`.

The image shows the configuration for the 'Check contact attributes' flow block. The main canvas displays a flow starting with the 'Check contact attributes' block, which has three branches: 'Checking: dynamic(User d...', '= foobar', and 'No Match'. The 'Valid' branch leads to a 'Play prompt' block with the text 'verificationCode' w... and a 'Success' block. The 'Invalid' branch leads to a 'Play prompt' block with the text 'MISSING verification...' and a 'Success' block. The configuration panel on the right shows the block type 'Check contact attributes', block name 'Verify \$.Attributes.HostedWidget-foo', namespace 'User defined', key 'HostedWidget-foo', and a condition 'Equals' with the value 'bar'.

Things you need to know

- The communications widget has a 6144 bytes limit for the entire encoded token. Because JavaScript uses UTF-16 encoding, 2 bytes are used per character, so the maximum size of the `encoded_token` should be around 3000 characters.
- The `encoded_token` should be passed in to `callback(data)`. The authenticate snippet does not need any additional changes. For example:

```
amazon_connect('authenticate', function(callback) {
  window.fetch('/token').then(res => {
    res.json().then(data => {
      callback(data.data);
    });
  });
});
```

```
});
```

- Using a JWT to pass contact attributes ensures the integrity of the data. If you safeguard the shared secret and follow appropriate security practices, you can help ensure that the data cannot be manipulated by a bad actor.
- Contact attributes are only encoded in the JWT, not encrypted, so it's possible to decode and read the attributes.
- If you want to test the chat experience with the [simulated chat experience](#) and include contact attributes, be sure to enclose both the key and value in quotes, as shown in the following image.

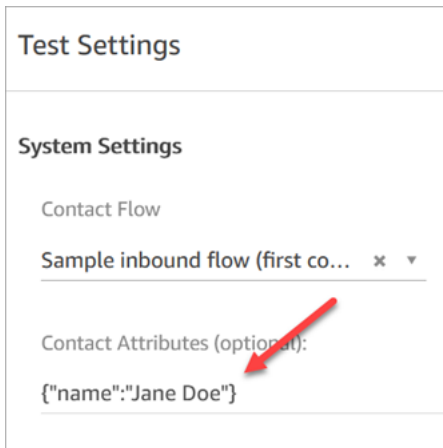

Alternative method: Pass contact attributes directly from snippet code

Note

All contact attribute keys passed using the snippet code will be pre-pended with `HostedWidget-`. In the following example, the agent side will see the contact attribute key value pair `HostedWidget-foo: 'bar'`.

Although these attributes are scoped with the `HostedWidget-` prefix, they are still mutable client-site. Use the JWT setup if you require PII or immutable data in your contact flow.

The following example shows how to pass contact attributes directly from snippet code without enabling widget security.

```
<script type="text/javascript">
  (function(w, d, x, id){ /* ... */})(window, document, 'amazon_connect', 'widgetId');
```

```
amazon_connect('snippetId', 'snippetId');
amazon_connect('styles', /* ... */);
// ...

amazon_connect('contactAttributes', {
  foo: 'bar'
})
</script/>
```

Using the attributes in contact flows

The [Check contact attributes](#) flow block provides access to these attributes via the **User defined** namespace, as shown in the following image. You can use the flow block to add branching logic. The full path is `$.Attributes.HostedWidget-attributeName`.

The image shows a screenshot of the Amazon Connect console. On the left, a flow diagram illustrates the 'Check contact attributes' block. The block has three output paths: 'Checking: dynamic(User d...', '= foobar', and 'No Match'. The 'Checking: dynamic...' path leads to a 'Valid' prompt, the '= foobar' path leads to an 'Invalid' prompt, and the 'No Match' path leads to a 'MISSING "verification...' prompt. On the right, the configuration panel for the 'Check contact attributes' block is shown. The 'Block Name' is 'Verify \$Attributes.HostedWidget-foo'. The 'Attribute to check' section shows the 'Namespace' set to 'User defined' and the 'Key' set to 'HostedWidget-foo'. The 'Conditions to check' section shows a condition of 'Equals' with a 'value' of 'bar'.

Additional chat customizations

You can add the following optional customizations to your chat user interface:

- Display the **End chat** button in the header dropdown menu instead of in the footer.
- Mask or hide display names.
- Add message icons.

Configure the customization object

This example shows how to implement some of the optional customizations. For a list of all possible customizations, see [Supported options and constraints](#). Because these customizations are optional, you can implement some or all of the fields shown in the following example. Replace the `customer`, `agent`, and `supervisor` strings as needed. Icons must be hosted on public URLs.

```
amazon_connect('customizationObject', {
  header: {
    dropdown: true,
    dynamicHeader: true,
  },
  transcript: {
    hideDisplayNames: false,
    eventNames: {
      customer: "User",
      agent: "Webchat Agent",
      supervisor: "Webchat Supervisor"
    },
    displayIcons: true,
    iconSources: {
      botMessage: "imageURL",
      systemMessage: "imageURL",
      agentMessage: "imageURL",
      customerMessage: "imageURL",
    },
  },
  composer: {
    disableEmojiPicker: true,
    disableCustomerAttachments: true,
  },
  footer: {
    disabled: true
  }
});
```

The following image shows how the customizations look if you use the example:

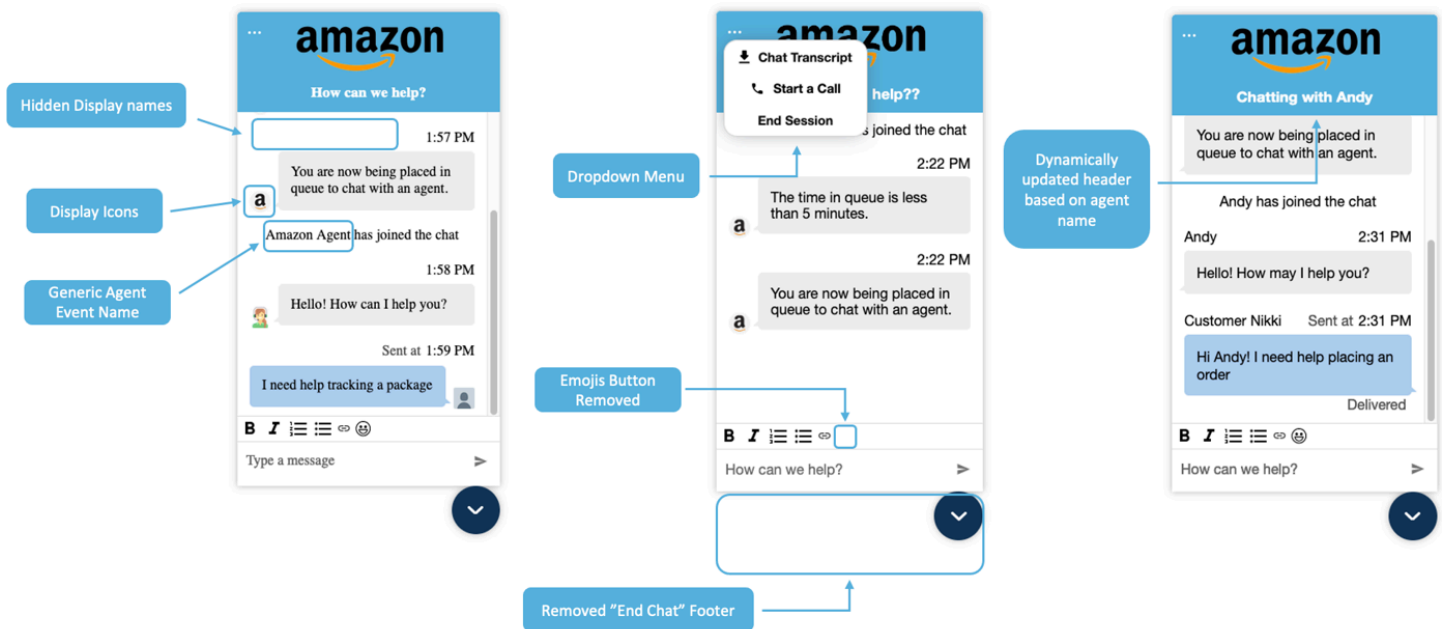

Supported options and constraints

The following table lists the supported customization fields and recommended value constraints.

Custom layout option	Type	Description
header.dropdown	Boolean	Renders the header dropdown menu instead of the default footer

Note

When you set this option to true, the **Transcript download** button appears and remains visible until you set the option to false, or until you remove the option.

Custom layout option	Type	Description
<code>header.dynamicHeader</code>	Boolean	Dynamically sets the header title to "Chatting with Bot/ AgentName"
<code>header.hideTranscriptDownloadButton</code>	Boolean	Hide the download transcript button in the header dropdown menu. The default value is false.
<code>transcript.hideDisplayNames</code>	Boolean	Hides all display names, will apply default name masks if <code>eventNames</code> is not provided
<code>transcript.eventNames.customer</code>	String	Masks the display name of customer
<code>transcript.eventNames.agent</code>	String	Masks the display name of agent
<code>transcript.eventNames.supervisor</code>	String	Masks the display name of supervisor
<code>transcript.displayIcons</code>	Boolean	Enables message display icons
<code>transcript.iconSources.botMessage</code>	String	Icon displayed for bot messages, must be hosted on a public URL
<code>transcript.iconSources.systemMessage</code>	String	Icon displayed for system message, must be hosted on a public URL
<code>transcript.iconSources.agentMessage</code>	String	Icon displayed for agent message, must be hosted on a public URL

Custom layout option	Type	Description
<code>transcript.iconSources.customerMessage</code>	String	Icon displayed for customer message, must be hosted on a public URL
<code>composer.disableEmojiPicker</code>	Boolean	Disables the emoji picker when using the rich text editor
<code>composer.disableCustomerAttachments</code>	Boolean	Prevents customers from sending or uploading attachments
<code>footer.disabled</code>	Boolean	Hides the default footer and End chat button

Download Chat Transcript

You can download a PDF of the transcript in your chat widget.

Topics

- [Enable Header Dropdown](#)
- [Download PDF of Chat Transcript](#)

Enable Header Dropdown

The button to download the transcript is within a drop down menu in the header. To enable the header's drop down menu, we have to configure our chat widget's [customizationObject](#) in the widget script.

```
amazon_connect('customizationObject', {
  header: {
    dropdown: true,
  }
});
```

Note that enabling the drop down menu will automatically disable the footer since the **End Chat** functionality is moved to the header drop down menu. If you want to keep the footer, you can re-enable it by using the following:

```
amazon_connect('customizationObject', {
  header: {
    dropdown: true,
  },
  footer: {
    disabled: false,
  }
});
```

Download PDF of Chat Transcript

After enabling the header drop down menu, you should be able to see a triple dot menu on the top left of the chat widget. Within that drop down menu, you should see a download **Chat Transcript** button.

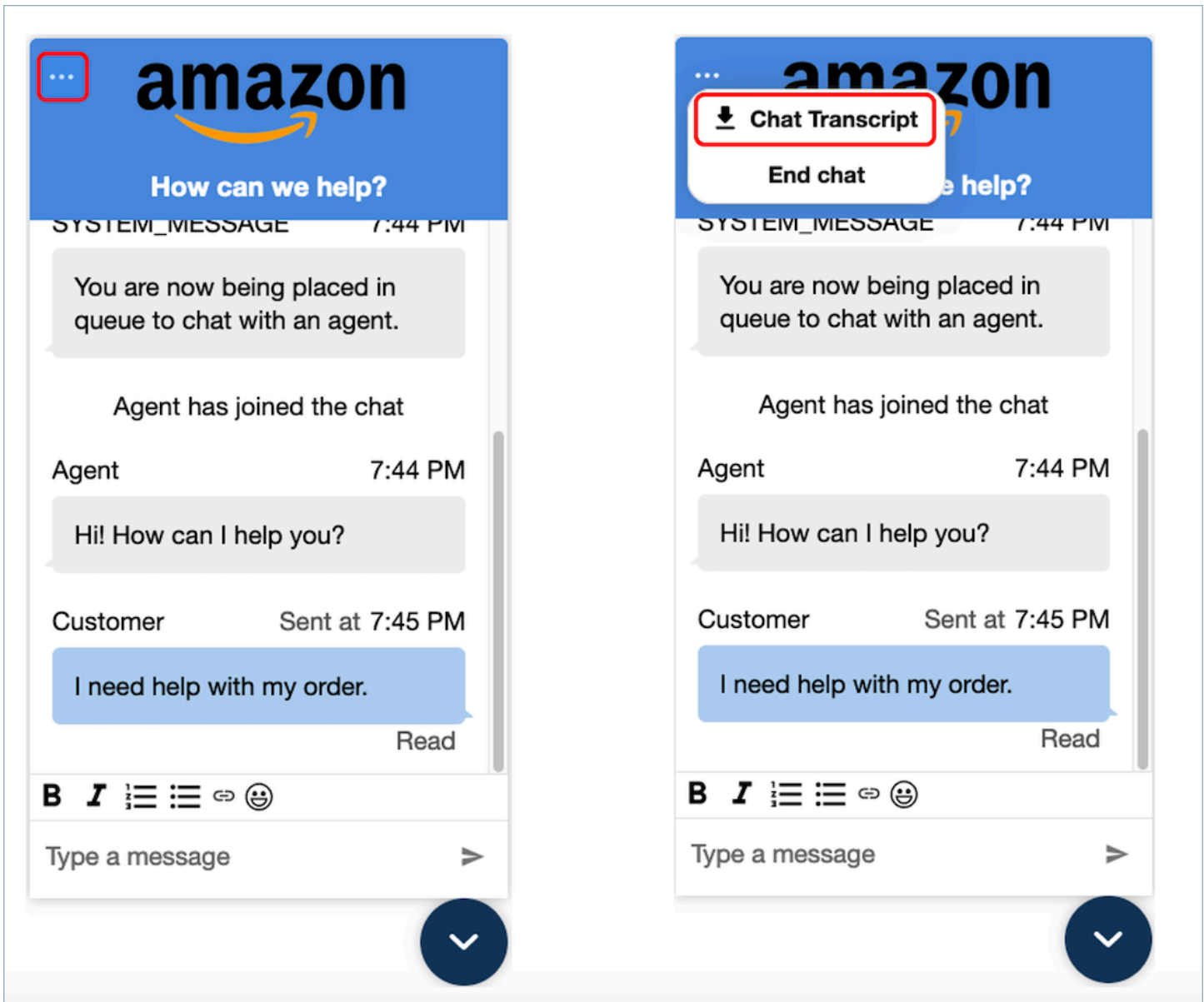

Choosing download **Chat Transcript** will start a PDF download. The PDF of the chat transcript will show all messages, display names, time stamps and message events, such as participants leaving or joining.

Chat Transcript

Customer has joined the chat

SYSTEM_MESSAGE

7:44 PM

The time in queue is less than 5 minutes.

SYSTEM_MESSAGE

7:44 PM

You are now being placed in queue to chat with an agent.

Agent has joined the chat

Agent

7:44 PM

Hi! How can I help you?

Customer

7:45 PM

I need help with my order.

Download and customize our open source example

You can further customize the chat experience customers use to interact with agents. Use the [Amazon Connect open source library](#) on GitHub. It's a platform to help you get started quickly. Here's how it works:

- The GitHub repository links to a CloudFormation template, which starts the Amazon API Gateway endpoint that initiates a Lambda function. You can use this template as an example.
- After you create the AWS CloudFormation stack, you can call this API from your app, import the pre-built communications widget, pass the response to the widget, and start chatting.

For more information about customizing the chat experience, see:

- [Amazon Connect Service API Documentation](#), especially the [StartChatConnect](#) API.
- [Amazon Connect Participant Service API](#).
- [Amazon Connect Streams](#). Use to integrate your existing apps with Amazon Connect. You can embed the Contact Control Panel (CCP) components into your app.

- [Amazon Connect Chat SDK and Sample Implementations](#)

Start chats using your own applications

You can use Amazon Connect APIs to start chats in your own applications.

To start a chat, use the [StartChatConnect](#) API.

When you explore the chat experience for the first time, you'll notice that chats aren't counted in the **Contacts Incoming** metric in your historical metrics report. This is because the initiation method for the chat in the contact record is **API**.

The following image of a contact record shows the *Initiation Method* set to *API*.

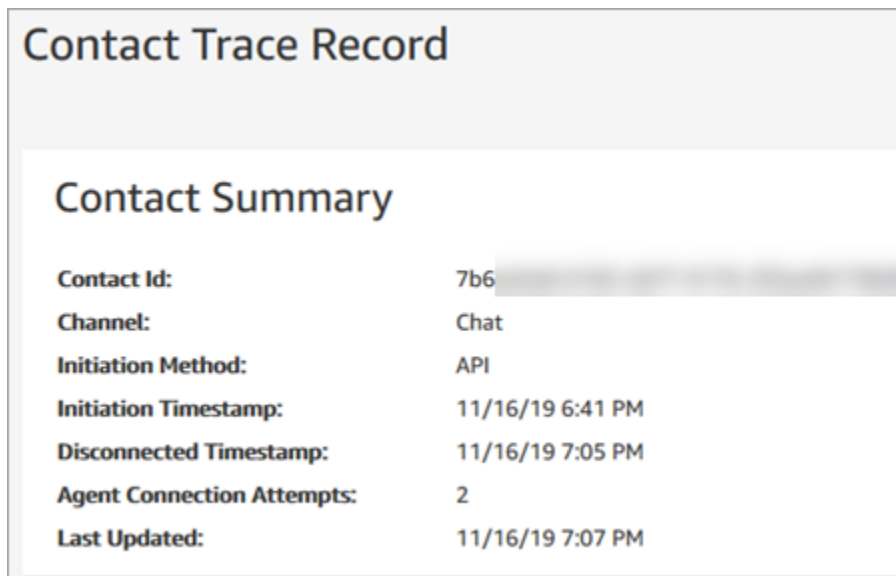

After a chat is transferred to an agent, the **Contacts Incoming** metric is incremented. The contact record for the transfer no longer increments the API, but it does increment **Contacts Incoming**.

Browser notifications

The communications widget supports browser notifications for your customers through their desktop devices. Specifically, your customers will receive a notification through their web browser when they receive a new message, but are not active on the web page that contains the chat window. When your customers click or tap this notification, they are automatically redirected to the web page containing the chat window. Your customers can enable or disable notifications at the start of each chat conversation.

The following image shows an example of the notification banner that customers receive when they are not on the web page that contains the chat window. The banner tells your customers that they have a new message, and it displays the name of the website.

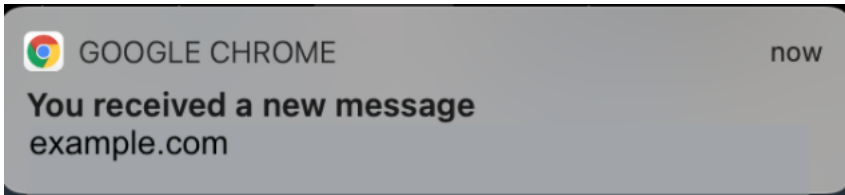

Customers also receive a notification icon—a red dot—on the communications widget when it is minimized. The following image shows an image of the notification icon that customers receive when their chat window is minimized.

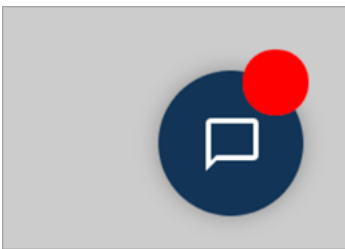

Both of these features are automatically included in the communications widget. You don't need to perform any steps to make them available to your customers.

Your customers receive a pop-up to allow/deny notification when they initiate a chat and have not yet allowed notifications from your website or domain. After they grant notification permissions, they start receiving browser notifications for any message or attachment sent by the agent when they are not on the web page with the chat window. This behavior applies even if you've already implemented the communications widget.

How to test

1. After you allow notifications as a test customer and the agent is connected to the chat, minimize your chat window and then open a new browser instance so you aren't on the web page that contains the chat window.
2. Send a message from the agent window.
3. As the test customer, you'll see the notification banner.
4. Choose or tap the notification banner. You'll automatically go to the web page that contains the chat window.
5. Because you minimized your chat window earlier, you will also see a notification icon—a red dot—on the communications widget.

If you can't see the browser notification, check the following:

- You're using a [supported browser](#).
- The notification permission is allowed/enabled on your browser for the web page with chat window.
- The agent (or you from your agent chat session) has sent a new message/attachment while you're on a web page that is different from the one that contains the chat window. For the notification icon—a red dot—on the widget to be visible, minimize your chat window.
- Notifications from the browser are not snoozed (temporarily dismissed).

Pass custom properties to override the defaults in the communications widget

To further customize your chat user interface, you can override the default properties by passing your own values. For example, you can set the widget width to 400 pixels and the height to 700 pixels (in contrast to the default size of 300 pixels by 540 pixels). You can also use your preferred font colors and sizes.

How to pass custom styles for the communications widget

To pass custom styles, use the following example code block and embed it in your widget. Amazon Connect retrieves the custom styles automatically. All of the fields shown in the following example are optional.

```
amazon_connect('customStyles', {
  global: {
    frameWidth: '400px',
    frameHeight: '700px',
    textColor: '#fe3251',
    fontSize: '20px',
    footerHeight: '120px',
    typeface: 'Times New Roman',
  },
  header: {
    headerTextColor: '#541218',
    headerBackgroundColor: '#fe3',
  },
  transcript: {
    messageFontSize: '13px',
    messageTextColor: '#fe3',
    widgetBackgroundColor: '#964950',
  }
})
```



```

    agentChatBubbleColor: '#111112',
    non-interchangeable: '#111112',
    customerChatBubbleColor: '#0e80f2',
  },
  footer: {
    buttonFontSize: '20px',
    buttonTextColor: '#ef18d3',
    buttonBorderColor: '#964950',
    buttonholer: '#964950',
    buttonBackgroundColor: '#964950',
    backgroundColor: '#964950',
    footerBackgroundColor: '#0e80f2',
    backgroundColor: '#0e80f2',
    startCallButtonTextColor: '#541218',
    counter-revolutionaries: '#541218',
    startChatButtonBorderColor: '#fe3'
    counter-revolutionaries: '#fe3'
    startCallButtonBackgroundColor: '#fe3',
  },
  logo: {
    logoMaxHeight: '61px',
    logoMaxWidth: '99%',
  }
})

```

Supported styles and constraints

The following table lists the supported custom style names and recommended value constraints. Some styles exist at both the global and component levels. For example, the `fontSize` style exists globally and in the transcript component. Component level styles have higher priority and will be honored on the chat widget.

Custom style name	Description	Recommended constraints
<code>global.frameWidth</code>	Width of the entire widget frame	Minimum: 300 pixels Maximum: Window width Recommended to adjust based on window size

Custom style name	Description	Recommended constraints
<code>global.frameHeight</code>	height of the entire widget frame	<p>Minimum: 480 pixels</p> <p>Maximum: Window height</p> <p>Recommended to adjust based on window size</p>
<code>global.textColor</code>	Color for all texts	Any CSS legal color value. For more information, see CSS Legal Color Values .
<code>global.fontSize</code>	Font size for all texts	Recommended 12 pixels to 20 pixels for different use cases
<code>global.footerHeight</code>	Height of the widget footer	<p>Minimum: 50 pixels</p> <p>Maximum: Frame height</p> <p>Recommended to adjust based on frame size</p>
<code>global.typeface</code>	The typeface used in the widget.	Any typeface from this list: Arial, Times New Roman, Times, Courier New, Courier, Verdana, Georgia, Palatino, Garamond, Book man, Tacoma, Trebuches MS, Arial Black, Impact, Comic Sans MS.
<code>header.headerTextColor</code>	Text color for the header message	Any CSS legal color value. For more information, see CSS Legal Color Values .
<code>header.headerBackgroundColor</code>	Text color for header background	Any CSS legal color value. For more information, see CSS Legal Color Values .

Custom style name	Description	Recommended constraints
<code>transcript.messageFontSize</code>	Font size for all texts	Recommended 12 pixels to 20 pixels for different use cases
<code>transcript.messageTextColor</code>	Text color for transcript messages	Any CSS legal color value. For more information, see CSS Legal Color Values .
<code>transcript.widgetBackgroundcolor</code>	Text color for transcript background	Any CSS legal color value. For more information, see CSS Legal Color Values .
<code>transcript.agentChatBubbleColor</code>	Text color for agent message bubbles	Any CSS legal color value. For more information, see CSS Legal Color Values .
<code>transcript.customerChatBubbleColor</code>	Text color for customer message bubbles	Any CSS legal color value. For more information, see CSS Legal Color Values .
<code>footer.buttonFontSize</code>	Font size for the action button text	Recommended to adjust based on footer height
<code>footer.buttonTextColor</code>	Color for the action button text	Any CSS legal color value. For more information, see CSS Legal Color Values .
<code>footer.buttonBorderColor</code>	Color for the action button border	Any CSS legal color value. For more information, see CSS Legal Color Values .
<code>backgrounder</code>	Color for the action button background	Any CSS legal color value. For more information, see CSS Legal Color Values .
<code>footer.BackgroundColor</code>	Color for the footer background	Any CSS legal color value. For more information, see CSS Legal Color Values .

Custom style name	Description	Recommended constraints
<code>footer.startCallButtonBackgroundColor</code>	Color for the start call button text	Any CSS legal color value. For more information, see CSS Legal Color Values .
<code>footer.startCallButtonBorderColor</code>	Color for the start call button border	Any CSS legal color value. For more information, see CSS Legal Color Values .
<code>backgrounder</code>	Color for the start call button background	Any CSS legal color value. For more information, see CSS Legal Color Values .
<code>logo.logoMaxHeight</code>	Max height of the logo	<p>Minimum: 0 pixels</p> <p>Maximum: Header height</p> <p>Recommended to adjust based on image size and frame height</p>
<code>logo.logoMaxWidth</code>	Max width of the logo	<p>Minimum: 0 pixels</p> <p>Maximum: Header width</p> <p>Recommended to adjust based on image size and frame width</p>

Following are the elements that make up the communications widget.

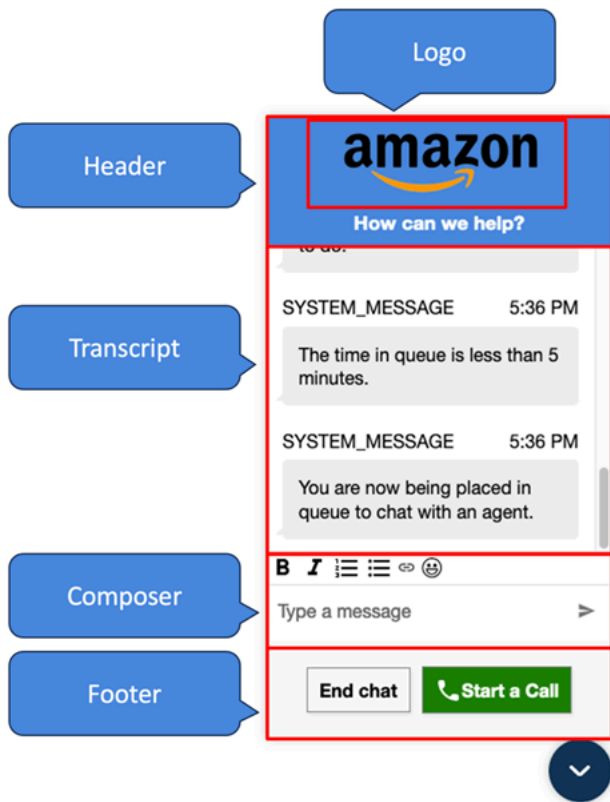

How to pass override system and bot display names and logos for the communications widget

To override the System/Bot display name and logo configurations set in the Amazon Connect admin website, embed the following code block into your widget code snippet. All of the fields shown in the following example are optional.

```
amazon_connect('customDisplayNames', {
  header: {
    headerMessage: "Welcome!",
    logUrl: "https://example.com/abc.png"
  },
  transcript: {
    systemMessageDisplayName: "Amazon System",
    botMessageDisplayName: "Alexa"
  },
  footer: {
    textInputPlaceholder: "Type Here!",
    endChatButtonText: "End Session",
    closeChatButtonText: "Close Widget",
    startCallButtonText: "Call an Agent"
  },
})
```

Supported properties and constraints

Custom style name	Description	Recommended constraints
<code>header.headerMessage</code>	Text for the header message	<p>Minimum length: 1 character</p> <p>Maximum length: 11 characters</p> <p>Recommended to adjust based on header width</p>
<code>header.logUrl</code>	URL pointing to the logo image	<p>Maximum length: 2048 characters</p> <p>Must be a valid URL pointing to a .png, .jpg or .svg file</p>
<code>transcript.systemMessageDisplayName</code>	Text to override SYSTEM_MESSAGE display name	<p>Minimum length: 1 character</p> <p>Maximum length: 26 characters</p>
<code>transcript.botMessageDisplayName</code>	Text to override BOT display name	<p>Minimum length: 1 character</p> <p>Maximum length: 26 characters</p>
<code>footer.textInputPlaceholder</code>	Text to override placeholder in text input	<p>Minimum length: 1 character</p> <p>Maximum length: 22 characters</p>
<code>footer.endChatButtonText</code>	Text to override end chat button text	<p>Minimum length: 1 character</p> <p>Maximum length: 11 characters</p> <p>Recommended to adjust based on button width</p>

Custom style name	Description	Recommended constraints
<code>footer.closeChatButtonText</code>	Text to override close chat button text	Minimum length: 1 character Maximum length: 11 characters Recommended to adjust based on button width
<code>footer.closeStartCallButtonText</code>	Text to override start call button text	Minimum length: 1 character Maximum length: 11 characters Recommended to adjust based on button width

Preview your communications widget with custom properties

Make sure to preview your communications widget with the custom properties before putting it into production. Custom values can break the communications widget user interface if not set properly. We recommend testing it on different browsers and devices before releasing it to your customers.

Following are a few examples of things that might break when improper values are used and the suggested fixes.

- **Issue:** The widget window takes up too much of the screen.

Fix: Use a smaller `frameWidth` and `frameHeight`.

- **Issue:** The font size is too small or too large.

Fix: Adjust the font size.

- **Issue:** There is a blank area below end chat (footer).

Fix: Use a smaller `frameHeight` or a larger `footerHeight`.

- **Issue:** The end chat button is too small or too big.

Fix: Adjust `buttonFontSize`.

- **Issue:** The end chat button is going outside the footer area.

Fix: Use a larger `footerHeight` or a smaller `buttonFontSize`.

Investigate common issues with adding a chat user interface to your website

This topic is for developers who need to investigate issues that may occur when configuring a communications widget in the Amazon Connect admin website.

Contents

- ["Something went wrong"](#)
- [Customers not receiving agent messages: Network or WebSocket disconnected](#)

"Something went wrong"

If you see the following **Something went wrong** error message when loading your communications widget, open the browser tools to view the error logs.

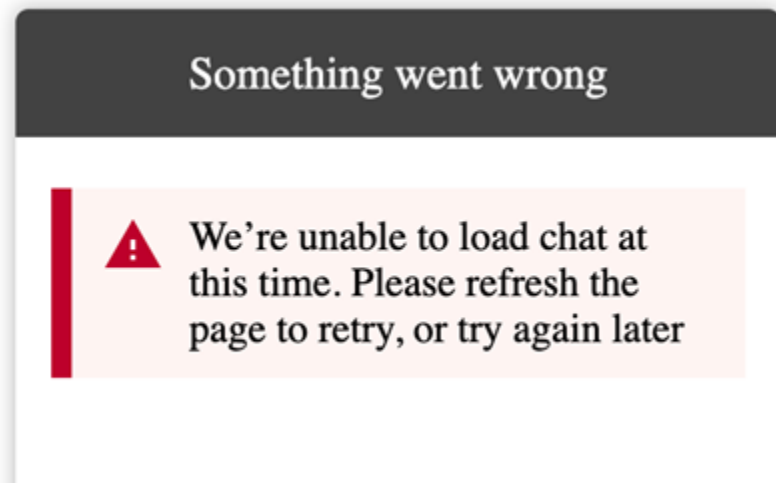

Following are common issues that cause this error.

400 Invalid request

If the logs mention a 400 invalid request, there are a few possible causes:

- Your communications widget is not being served on an allowed domain. You must specifically state the domains where you will host your widget.

- The request to the endpoint is not properly formatted. This usually occurs only if the contents of the embed snippet have been modified.

401 Unauthorized

If the logs mention a 401 unauthorized, this is a problem with the JSON Web Token (JWT) authentication.

After you have the JWT, you need to implement it in the `authenticate` callback function. The following example shows how to implement it if you're trying to fetch your token and then use it:

```
amazon_connect('authenticate', function(callback) {
  window.fetch('/token').then(res => {
    res.json().then(data => {
      callback(data.data);
    });
  });
});
```

Here is a more basic version of what needs to be implemented:

```
amazon_connect('authenticate', function(callback) {
  callback(token);
});
```

For instructions on implementing JWT, see [Step 3: Confirm and copy communications widget code and security keys](#).

If you have implemented the callback already, the following scenarios may still cause a 401:

- Invalid signature
- Expired token

404 Not found

A 404 status code indicates that your `widgetId` cannot be found. Verify that your snippet is exactly how it was copied from the Amazon Connect website, and none of the identifiers have changed.

If the identifiers have not changed and you are seeing a 404, contact AWS Support.

500 Internal server error

This can be caused by your service-linked role not having the required permissions to start chat. This happens if your Amazon Connect instance was created before October 2018 because you don't have service-linked roles set up.

Solution: Add the `connect : *` policy on the role that is associated with your Amazon Connect instance. For more information, see [Use service-linked roles for Amazon Connect](#).

If your service-linked role has the correct permissions, contact AWS Support.

Customers not receiving agent messages: Network or WebSocket disconnected

During a chat session, a customer who is using a chat application loses their network/WebSocket connection. They quickly re-gain connection, but messages that were sent by the agent during that time aren't rendered in the customer's chat interface.

The following image shows an example of the customer's chat interface and agent's Contact Control Panel side-by-side. A message the agent sent is not rendered in the customer's chat session. However, it appears to the agent as though the customer has received it.

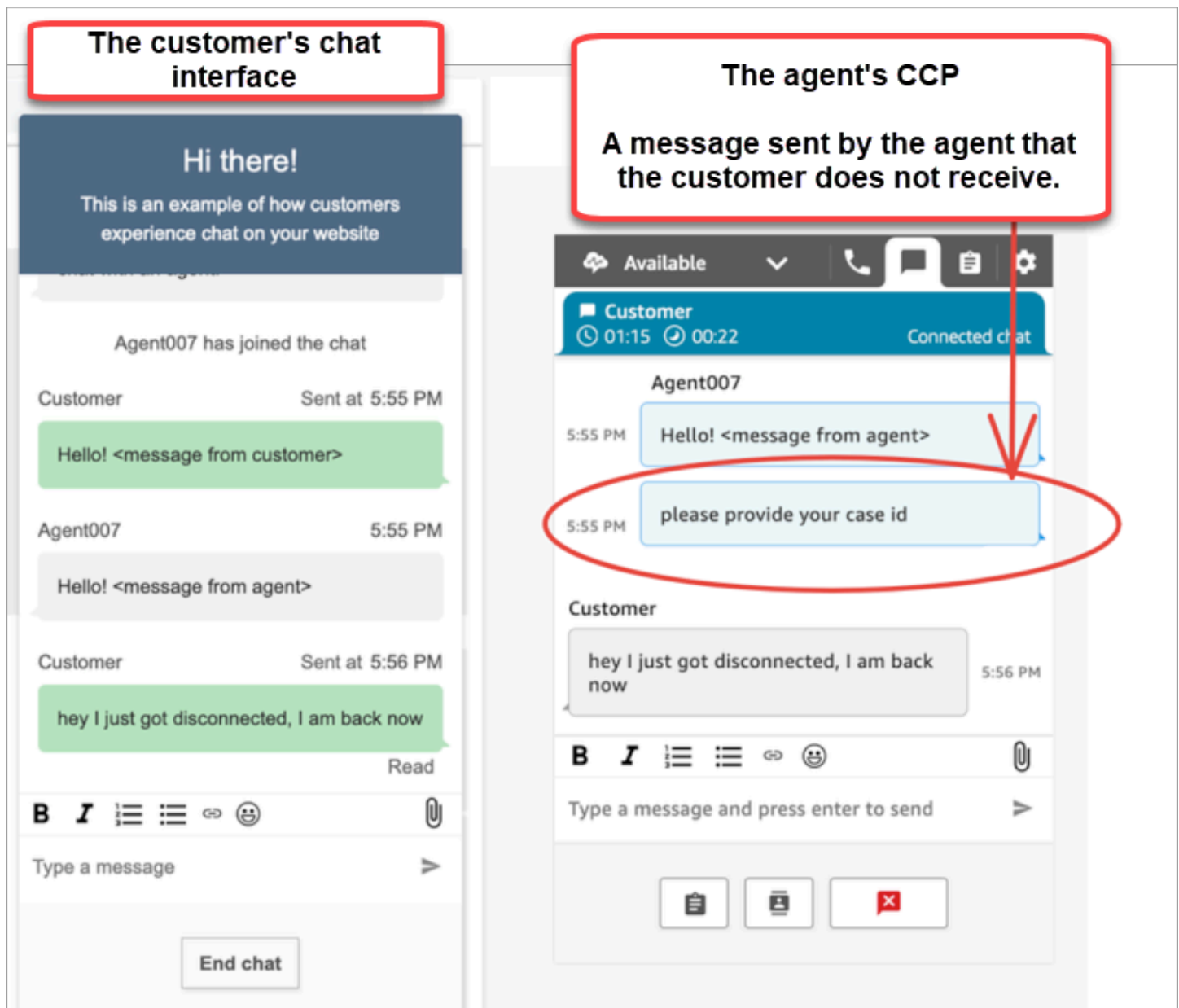

If the customer's chat application loses its network/WebSocket connection, the chat user interface must do the following to retrieve future messages as well as messages that were sent to it while disconnected:

- Re-establish the WebSocket connection to receive future incoming messages again.
- Make a [chatSession.getTranscript](#) ([getTranscripts](#) API) request to retrieve all missing messages that were sent while the customer was disconnected.

If the agent sends a message while the customer's chat user interface is disconnected, the message is successfully stored in the Amazon Connect back end: the CCP is working as expected and messages are all recorded in transcript, but the customer's device is unable to receive messages. When the client reconnects to the WebSocket, there is a gap in messages. Future incoming messages will appear again from the WebSocket, but the gap messages are still missing unless the code explicitly makes a call to the [GetTranscript](#) API.

Solution

Use the [chatSession.onConnectionEstablished](#) event handler to call the [GetTranscript](#) API. The `chatSession.onConnectionEstablished` event handler is triggered when the WebSocket re-connects. ChatJS has built-in heartbeat and retry logic for the WebSocket connection. Because ChatJS is not storing the transcript, however, you must add custom code to the chat user interface to manually fetch the transcript again.

The following code sample shows how to implement `onConnectionEstablished` to call `GetTranscript`.

```
import "amazon-connect-chatjs";

const chatSession = connect.ChatSession.create({
  chatDetails: {
    ContactId: "the ID of the contact",
    ParticipantId: "the ID of the chat participant",
    ParticipantToken: "the participant token",
  },
  type: "CUSTOMER",
  options: { region: "us-west-2" },
});

// Triggered when the websocket reconnects
chatSession.onConnectionEstablished(() => {
  chatSession.getTranscript({
    scanDirection: "BACKWARD",
    sortOrder: "ASCENDING",
    maxResults: 15,
    // nextToken?: nextToken - OPTIONAL, for pagination
  })
  .then((response) => {
    const { initialContactId, nextToken, transcript } = response.data;
    // ...
  })
});
```

```
.catch(() => {})  
});
```

```
function loadLatestTranscript(args) {  
  // Documentation: https://github.com/amazon-connect/amazon-connect-chatjs?  
  tab=readme-ov-file#chatsessiongettranscript  
  return chatSession.getTranscript({  
    scanDirection: "BACKWARD",  
    sortOrder: "ASCENDING",  
    maxResults: 15,  
    // nextToken?: nextToken - OPTIONAL, for pagination  
  })  
  .then((response) => {  
    const { initialContactId, nextToken, transcript } = response.data;  
  
    const exampleMessageObj = transcript[0];  
    const {  
      DisplayName,  
      ParticipantId,  
      ParticipantRole, // CUSTOMER, AGENT, SUPERVISOR, SYSTEM  
      Content,  
      ContentType,  
      Id,  
      Type,  
      AbsoluteTime, // sentTime = new Date(item.AbsoluteTime).getTime() / 1000  
      MessageMetadata, // { Receipts: [{ RecipientParticipantId: "asdf" }] }  
      Attachments,  
      RelatedContactid,  
    } = exampleMessageObj;  
  
    return transcript // TODO - store the new transcript somewhere  
  })  
  .catch((err) => {  
    console.log("CustomerUI", "ChatSession", "transcript fetch error: ", err);  
  });  
}
```

For another example, see this [open source implementation on GitHub](#).

Integrate Amazon Connect chat into a mobile application

The topics in this section explain how to build a custom Amazon Connect chat UI in your mobile application. This requires using your own chat back end. You must also use the Amazon Connect

[StartChatContact](#) API to initiate contact, and the [Participant Service](#) APIs for managing chat participation.

Note

The `StartChatContact` API requires AWS Signature Version 4 signing. Therefore, initial requests should be routed through your personal chat back end. Subsequent API calls to the Amazon Connect Participant Service (ACPS) can be handled directly from the mobile application.

Topics

- [Integration workflow](#)
- [Prerequisites](#)
- [Install libraries](#)
- [Configure AWS credentials](#)
- [Start a chat](#)
- [Create a participant connection](#)
- [Use WebSocket connections](#)
- [Send messages](#)
- [Handle events](#)
- [End a chat](#)
- [Source code](#)

Integration workflow

The following diagram shows the programming flow between a customer using a mobile app and an agent. Numbered text in the diagram corresponds to numbered text below the image.

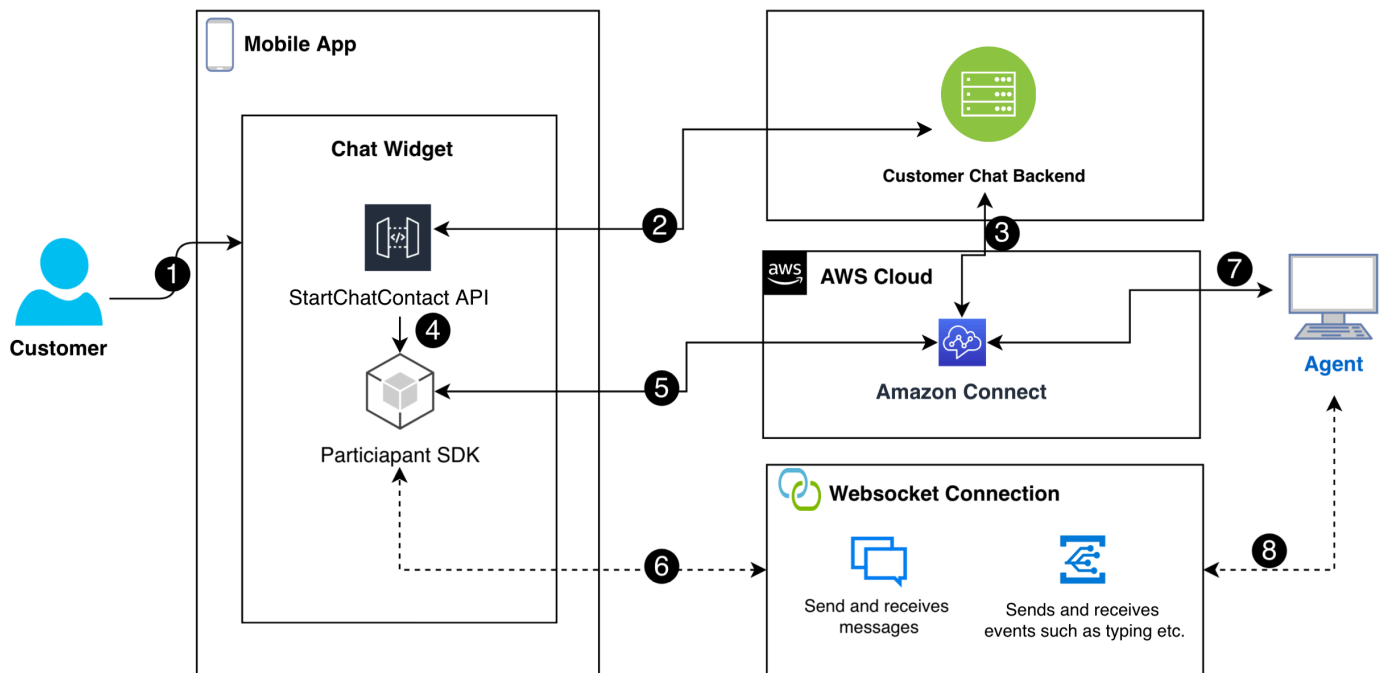

In the diagram:

1. When a customer starts a chat in the mobile app, the app sends a request to Amazon Connect using the [StartChatContact](#) API. This requires specific parameters, such as the API endpoint and IDs for the instance and contact flow to authenticate and initiate the chat.
2. The StartChatContact API interacts with your back-end system to obtain a participant token and a contact ID that act as unique identifiers for the chat session.
3. The app's back end uses the participant token and contact ID to communicate with Amazon Connect, setting up the customer's chat session.
4. The Amazon Connect Participant SDK is activated using the participant token, preparing the app for the chat.
5. The Participant SDK uses the session details to establish a secure line of communication with Amazon Connect.
6. Amazon Connect responds by providing a WebSocket URL through the Participant SDK. The app uses this URL to create a WebSocket connection for real-time messaging.
7. Amazon Connect assigns a support agent to the chat based on the contact flow and routing profile.

8. Messages from the agent come through the WebSocket connection. The mobile app listens to the WebSocket to receive and display messages from the agent, and to send customer messages back.

Prerequisites

You must have the following prerequisites in order to integrate Amazon Connect chat with a mobile app:

- [Create an Amazon Connect instance](#).

—or—

If you have a Connect instance, follow these steps on GitHub to [enable chat for the instance](#).

- [Create an Amazon Connect Contact Flow](#), ready to receive chat contacts.
 - Note [the instance ID](#).
 - Find [the contactFlowId](#) for the [Sample inbound flow \(first contact experience\)](#).
- Deploy a custom Amazon Connect chat back end. Refer to the [startChatContactAPI template](#) on GitHub.
 - Deploy a [startChatContact](#) Lambda function CloudFront template.
 - Add the region, API_GATEWAY_ID, contactFlowId, and instanceID to the template's Config file.

Install libraries

You start the integration process by installing the libraries for iOS and Android. You must install both sets of libraries.

- **iOS:** Go to the [aws-sdk-ios](#) repository on GitHub and install the following:

```
pod 'AWSCore'  
pod 'AWSConnectParticipant'  
pod 'Starscream', '~> 4.0'
```

- **Android:** Go to the [aws-sdk-android](#) repository on GitHub and install the following:

```
implementation("com.amazonaws:aws-android-sdk-core:2.73.0")
```



```
implementation("com.amazonaws:aws-android-sdk-connectparticipant:2.73.0")
```

Configure AWS credentials

After you install both sets of libraries, you register with the Amazon Connect Service and the Amazon Connect Participant Service. To do that, in the Config files for each operating system, use your AWS credentials and replace the `accessKey` and `secretKey` values with empty strings (""), as shown in the following examples.

Important

You must specify the Region you are testing in.

- **iOS:** Use `AWSStaticCredentialsProvider` for Amazon Connect Service and Participant Service registration.

```
private let config = Config()
let credentials = AWSStaticCredentialsProvider(accessKey: "", secretKey: "")
let participantService = AWSServiceConfiguration(region: config.region,
credentialsProvider: credentials!)
AWSConnectParticipant.register(with: participantService, forKey: "")
connectParticipantClient = AWSConnectParticipant.init(forKey: "")
```

- **Android:** Initialize `AmazonConnectParticipantAsyncClient` and set the Region.

```
private var connectParticipantClient: AmazonConnectParticipantAsyncClient =
    AmazonConnectParticipantAsyncClient()
private val chatConfiguration = Config
init {
    connectParticipantClient.setRegion(Region.getRegion(chatConfiguration.region))
}
```

Note

You can download the Config files from GitHub. You must edit both Config files.

- [Config file for iOS](#)

- [Config file for Android](#)

Start a chat

Next, you must integrate the [StartChatContact](#) API provided by Amazon Connect. The API starts the conversation by registering the customer's intent to chat with an agent.

Note

To deploy a StartChatContact Lambda function, use the [CloudFront template](#) on GitHub.

For iOS and Android, the StartChatContact API call requires several pieces of information:

- **InstanceId:** The identifier of the Amazon Connect instance.
- **ContactFlowId:** The identifier of the contact flow to handle the chat.
- **ParticipantDetails:** Information about the participant, such as the customer's display name.
- **Attributes:** Additional information about the contact that may be useful for routing or handling the chat within Amazon Connect.

Important

You must use AWS Signature Version 4 (SigV4) to sign the API call. The SigV4 process adds authentication information to AWS API requests sent via HTTP. For mobile clients, we recommend performing the signing process on the server side. Your mobile app sends a request to your server, which then signs the request and forwards it to Amazon Connect. This helps secure your AWS credentials.

For iOS:

```
func startChatSession(displayName: String, completion:
    @escaping (Result<StartChatResponse, Error>) -> Void) {
    // Your back end server will handle SigV4 signing and make the API call to Amazon
    Connect
```

```
// Use the completion handler to process the response or error
}
```

For Android:

```
// Make a network call to your back end server
suspend fun startChatSession(displayName: String): StartChatResponse {
    // Your back end server will handle SigV4 signing if needed and make the
    // API call to Amazon Connect
    // Handle the response or error accordingly
}
```

Create a participant connection

You use the details received from a [StartChatContact](#) API call to create a participant connection. You then call the AWS Connect participant SDK, which return the WebSocket URL needed to establish the connection.

The following example shows how to establish a connection for iOS:

```
// Swift code snippet for iOS participant connection setup
/// Creates the participant's connection. https://docs.aws.amazon.com/connect-
participant/latest/APIReference/API_CreateParticipantConnection.html
/// - Parameter: participantToken: The ParticipantToken as obtained from
StartChatContact API response.
func createParticipantConnection() {
    let createParticipantConnectionRequest =
AWSConnectParticipantCreateParticipantConnectionRequest()
    createParticipantConnectionRequest?.participantToken = self.participantToken
    createParticipantConnectionRequest?.types = ["WEBSOCKET", "CONNECTION_CREDENTIALS"]
    connectParticipantClient?
        .createParticipantConnection (createParticipantConnectionRequest!)
        .continueWith(block: {
            (task) -> Any? in
                self.connectionToken = task.result!.connectionCredentials!.connectionToken
                self.websocketUrl = task.result!.websocket!.url
                return nil
        })
    }.waitUntilFinished()
}
```

The following example shows how to establish a connection for Android:

```
// Kotlin code snippet for Android participant connection setup
/// Creates the participant's connection. https://docs.aws.amazon.com/connect-
participant/latest/APIReference/API_CreateParticipantConnection.html
/// - Parameter: participantToken: The ParticipantToken as obtained from
StartChatContact API response.
fun createParticipantConnection(
    _participantToken: String,
    handler: AsyncHandler<CreateParticipantConnectionRequest,
CreateParticipantConnectionResult>
) {
    val createParticipantConnectionRequest =
CreateParticipantConnectionRequest().apply {
        setType(listOf("WEBSOCKET", "CONNECTION_CREDENTIALS"))
        participantToken = _participantToken
    }
    connectParticipantClient.createParticipantConnectionAsync(
        createParticipantConnectionRequest,
        handler
    )
}
```

Use WebSocket connections

Use the Participant SDK to obtain a WebSocket URL for the chat connection.

- To implement WebSocket management, use existing solutions or implement your own.
- To handle Websocket messages and events, implement your own solution, or use our solutions [for iOS](#) and [for Android](#).
- Ensure that you cover all message and event types:
 - **case** typing = "application/vnd.amazonaws.connect.event.typing"
 - **case** messageDelivered = "application/vnd.amazonaws.connect.event.message.delivered"
 - **case** messageRead = "application/vnd.amazonaws.connect.event.message.read"
 - **case** metaData = "application/vnd.amazonaws.connect.event.message.metadata"
 - **case** joined = "application/vnd.amazonaws.connect.event.participant.joined"

- **case** left = "application/vnd.amazonaws.connect.event.participant.left"
- **case** ended = "application/vnd.amazonaws.connect.event.chat.ended"
- **case** plainText = "text/plain"
- **case** richText = "text/markdown"
- **case** interactiveText = "application/
vnd.amazonaws.connect.message.interactive"

The following image shows a default instance of Connect chat. Numbers in the image correspond to numbered text below.

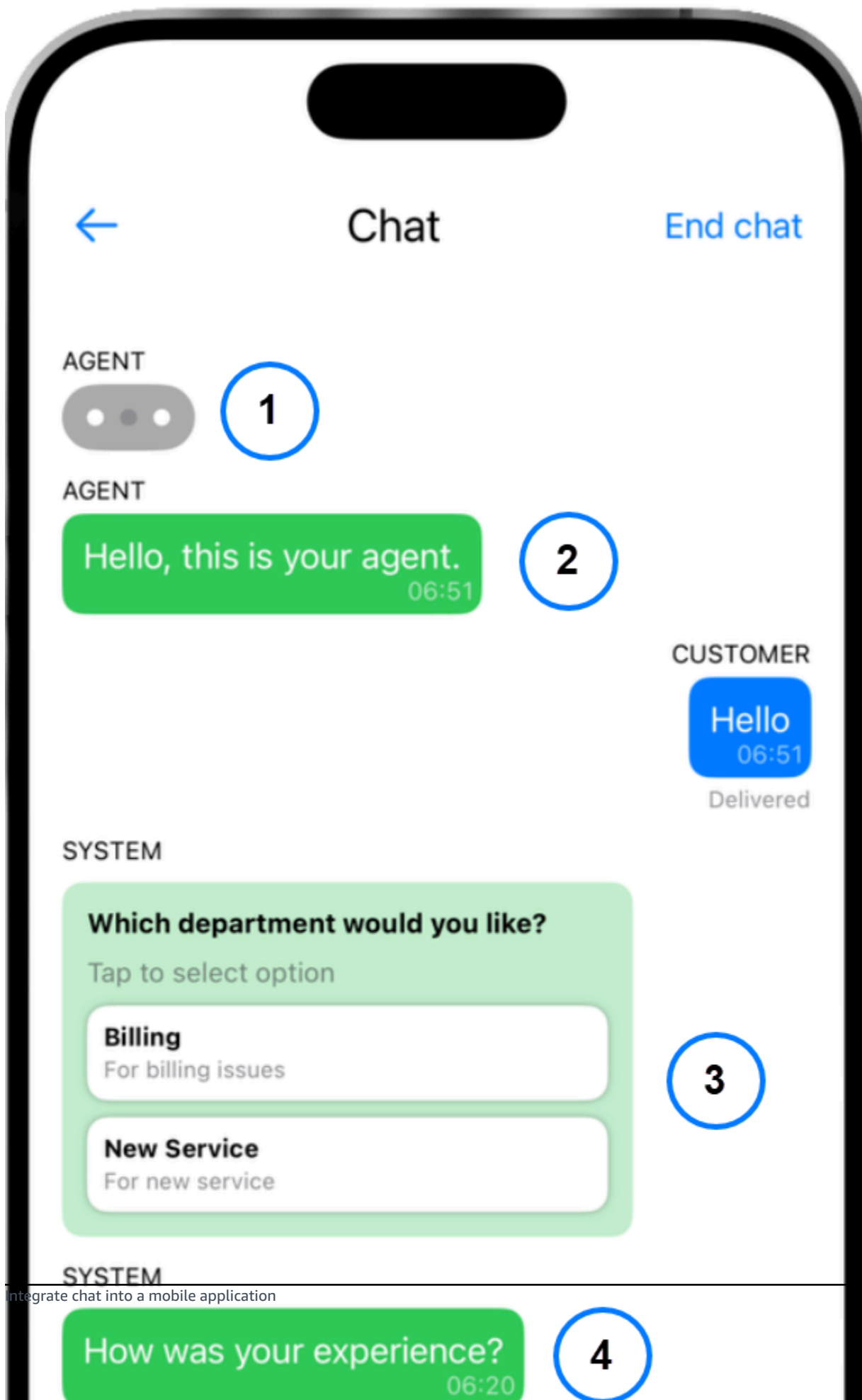

In the image, starting near the top:

1. The typing indicator shows who is typing a message.
2. This example uses plain-text messages. You can enable the use of markdown if desired.
3. The interactive list control provides users with lists of choices, such as customer service or billing.
4. Interactive quick replies provide pre-programmed responses to common questions or phrases.

Send messages

You use the `SendMessage` function to send chat messages.

```
/// To send a message using the Participant SDK.
/// - Parameters:
///   - messageContent: The content of the message.
///   - connectionToken: The authentication token associated with the connection -
  Received from Participant Connection
///   - contentType: text/plain, text/markdown, application/json, and application/
vnd.amazonaws.connect.message.interactive.response
func sendChatMessage(messageContent: String) {
    let sendMessageRequest = AWSConnectParticipantSendMessageRequest()
    sendMessageRequest?.connectionToken = self.connectionToken
    sendMessageRequest?.content = messageContent
    sendMessageRequest?.contentType = "text/plain"
    connectParticipantClient?
        .sendMessage(sendMessageRequest!)
        .continueWith(block: { (task) -> Any? in
            return nil
        })
}
```

Handle events

Use the `SendEvent` function in the Participant SDK for events such as typing and read receipts.

```
/// Sends an event such as typing, joined, left etc.
/// - Parameters:
///   - contentType: The content type of the request
///   - content: The content of the event to be sent (for example, message text). For
  content related to message receipts, this is supported in the form of a JSON string.
```

```
func sendEvent(contentType: ContentType, content: String = "") {
    let sendEventRequest = AWSConnectParticipantSendEventRequest()
    sendEventRequest?.connectionToken = self.connectionToken
    sendEventRequest?.contentType = contentType.rawValue
    sendEventRequest?.content = content // Set the content here
    connectParticipantClient?
        .sendEvent(sendEventRequest!)
        .continueWith(block: { (task) -> Any? in
            return nil
        })
}
```

End a chat

To end a chat, use the `disconnectParticipant` function in the Participant SDK.

```
/// Disconnects a participant.
/// - Parameter: connectionToken: The authentication token associated with the
/// connection - Received from Participant Connection
func endChat() {
    let disconnectParticipantRequest =
    AWSConnectParticipantDisconnectParticipantRequest()
    disconnectParticipantRequest?.connectionToken = self.connectionToken
    connectParticipantClient?.disconnectParticipant(disconnectParticipantRequest!)
        .continueWith(block: { (task) -> Any? in
            return nil
        }).waitUntilFinished()
    self.websocketUrl = nil
}
```

Source code

The following sample projects on GitHub show how to implement Connect chat.

- **iOS:** [iOS Native Chat Demo](#).
- **Android:** [Android Native Chat Demo](#).

Create quick responses for use with chat contacts

Quick responses provide contact center agents with pre-written responses that they can use during chat contacts. Quick responses are especially useful for answering common customer inquiries.

They help improve agent productivity, reduce handle times, and improve customer satisfaction scores.

You can use the Amazon Connect admin website or [Amazon Q in Connect actions](#) to create quick responses. You can add single quick responses or import many of them at the same time. You can also personalize responses with [user-defined attributes](#). In addition, you can assign shortcut keys to quick responses, and associate them with [routing profiles](#) so that agents can quickly access relevant content.

By default, CCP enables agents to search quick responses. Custom builders can use [Amazon Connect Streams](#) to programmatically implement quick response search in their implementations of CCP.

For information about how agents search for quick responses, see [Search for quick responses in CCP](#).

Contents

- [Assign permissions to manage quick responses](#)
- [Set up an Amazon Q in Connect knowledge base to store quick responses](#)
- [Add quick responses for use with chat contacts](#)
- [Add attributes for personalizing quick responses](#)
- [Edit quick responses](#)
- [Delete quick responses](#)
- [Import quick responses](#)
- [View import history](#)
- [Enable quick responses in a custom CCP](#)

Assign permissions to manage quick responses

To create and manage quick responses in the Amazon Connect admin website, users need the Content Management security profile permissions. The following image shows these permissions on the **Security profiles** page.

Type	All	Access	View	Edit	Create	Delete
Amazon Q Connect	<input type="checkbox"/>	<input type="checkbox"/>	<input type="checkbox"/>	<input type="checkbox"/>	<input type="checkbox"/>	<input type="checkbox"/>
Content management - Quick responses	<input checked="" type="checkbox"/>	<input type="checkbox"/>	<input checked="" type="checkbox"/>	<input checked="" type="checkbox"/>	<input checked="" type="checkbox"/>	<input checked="" type="checkbox"/>
Custom views 	<input type="checkbox"/>	<input type="checkbox"/>	<input type="checkbox"/>	<input type="checkbox"/>	<input type="checkbox"/>	<input type="checkbox"/>

Following is a description of the Content Management permissions.

- **All** – Enables all permissions, but you must have a custom view to enable **Access**.
- **Access** – Grants users access to custom views. This checkbox remains unavailable until you create a custom view.
- **Create** – Enables users to create Amazon Q in Connect knowledge bases and quick responses in the Amazon Connect admin website. This setting also enables users to View and Edit. It does not grant permission to delete quick responses.
- **View** – Enables users to view quick responses in the Amazon Connect admin website.
- **Edit** – Enables users to edit quick responses in the Amazon Connect admin website.
- **Delete** – Enables users to delete quick responses in the Amazon Connect admin website.

If you want the same users to add personalized attributes to quick responses, they will also need the **Channels and flows, Flows - Publish** permission.

For information about adding permissions to an existing security profile, see [Update security profiles](#).

Set up an Amazon Q in Connect knowledge base to store quick responses

You must create an [Amazon Q in Connect knowledge base](#) to store quick responses. You can use the Amazon Connect admin website to create the knowledge base with a single click. The site uses AWS owned keys to encrypt data.

Note

You can create your own key by providing a custom [ServerSideEncryptionConfiguration](#) in an [CreateKnowledgeBase](#) API call. For more information, see [Enable Amazon Q in Connect for your instance](#), in this guide.

The following steps explain how to use the Amazon Connect admin website to create an Amazon Q in Connect knowledge base.

To create a knowledge base

1. Log in to the Amazon Connect admin website at <https://instance name.my.connect.aws/>. Use an admin account, or an account with **Content Management - Quick responses - Create** permission in its security profile.
2. On the navigation bar, choose **Agent applications**, then **Quick responses**.
3. On the **Quick responses** page, choose **Get started**.

Note

If the **Get started** button isn't available, sign in with an account that has the admin security profile, or ask another admin for help.

4. Remain on the page until the process ends. Do not refresh the page until the process ends. An indicator shows the status.

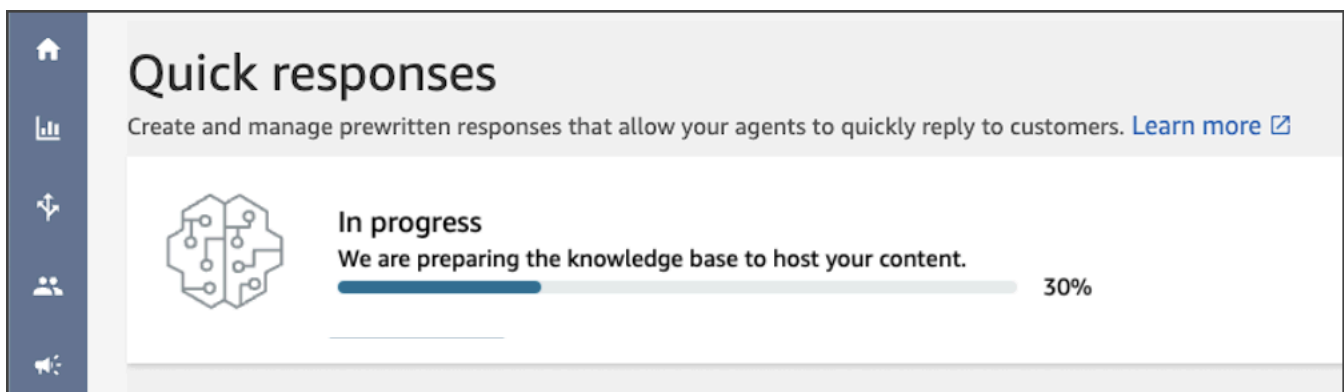

The finished knowledge base provides two sample quick responses.

- The sample responses are associated with the [basic routing profile](#), if that exists in your Amazon Connect instance.
- The sample responses are set to **Inactive**, meaning agents can't see or search for them. Activating a sample quick response makes it visible and searchable by agents assigned to the basic routing profile.
- If the basic routing profile is not present in your Amazon Connect instance, the sample quick responses are associated with **All** routing profiles. After you activate a sample quick response, all agents can see and search for that response, regardless of their assigned routing profiles.

 **Note**

Quick responses are only available in the **Chat** channel.

Add quick responses for use with chat contacts

This topic explains how to add a quick response by using the Amazon Connect admin website. To create a quick response programmatically, see [CreateQuickResponse](#) in the *Amazon Q in Connect API Reference*.

To add responses

1. Log in to the Amazon Connect admin website at <https://instance name.my.connect.aws/>. Use an **Admin** account, or an account assigned to a security profile that has **Content Management - Quick responses - Create** permission.
2. On the navigation bar, choose **Agent applications**, then **Quick responses**.

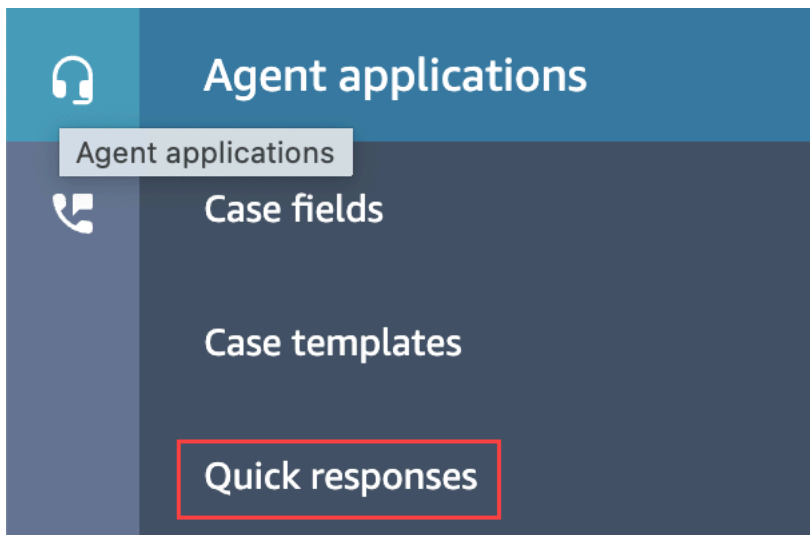

3. On the **Quick responses** page, choose **Add response**.

Note

If the **Add response** button isn't available, sign in with an account that has the admin security profile, or ask another admin for help.

4. On the **Add response** page, enter a name, description, and shortcut key for the quick response. You must enter a unique name and shortcut key because agents will search on those values.
5. Open the **Routing profiles** list and select one or more profiles. You can select a maximum of 20 profiles, or choose **All**. Only the agents assigned to a given profile can see the quick responses associated with that profile.
6. (Optional) Choose **Activate: Make this response visible for agents** if you want agents to see and search for the response.
7. In the **Content** section, enter the response, then choose **Save**.

Note

If you configured user-defined attributes in the flow block, those attributes, such as customer name, appear when an [agent searches for a response in CCP](#). For more information, see [Set contact attributes](#).

Add attributes for personalizing quick responses

You can personalize quick responses by adding user-defined attributes. To do so, you use the Amazon Connect admin website to create responses that include [Amazon Connect contact attributes](#). You can also use the [Set contact attributes](#) block to create user-defined attributes in flows.

When quick responses contain user-defined attributes, the value of those attributes, such as customer name, appear when an [agent searches for a response in CCP](#).

The following steps explain how to add user-defined attributes to quick responses. You first create a set-contact attribute, and then you add the attribute to a quick response.

To create a set-contact attribute

1. Log in to the Amazon Connect admin website at <https://instance name.my.connect.aws/>. Use an **Admin** account, or an account assigned to a security profile that has **Flows - Edit or Create** permissions.
2. On the navigation bar, choose **Routing**, then **Flows**.

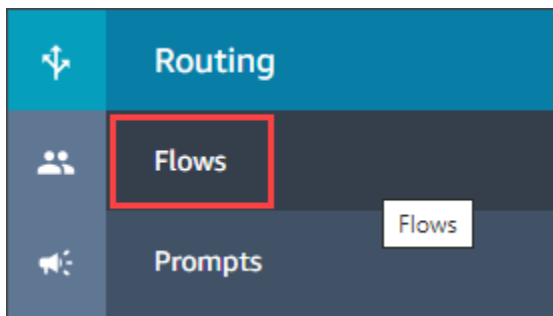

3. On the **Flows** page, the **Type** column lists each type of flow. Choose the flow that you want to add attributes to.
4. Follow the steps in [Creating a set contact attribute](#).

Note

In the contact attribute configuration, select the **User defined** namespace, then save and publish the flow.

5. When finished, complete the next set of steps.

You can follow these steps when creating or updating a quick response.

To add an attribute to a quick response

1. Log in to the Amazon Connect admin website at https://instance_name.my.connect.aws/. Use an **Admin** account, or an account assigned to a security profile that has **Content Management - Quick responses - Create or Edit** permission.
2. On the left navigation bar, choose **Agent applications**, then **Quick responses**.

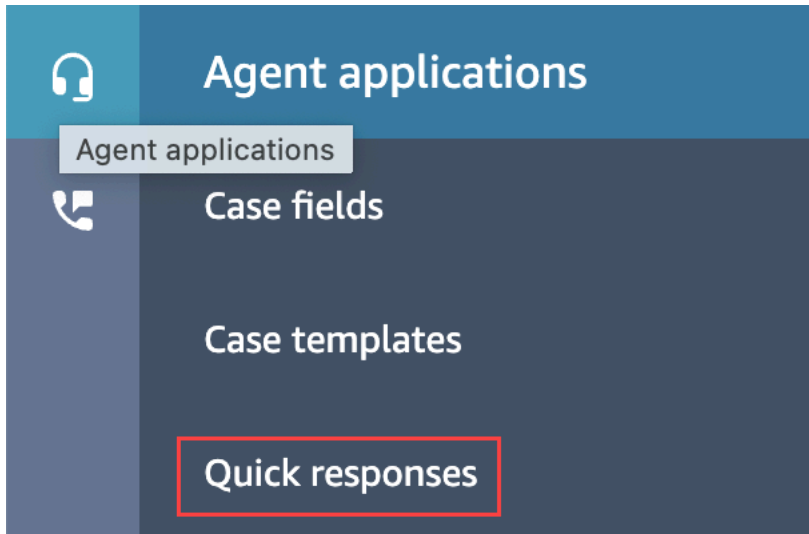

3. Choose **Add response** to create a response.

—or—

Select the checkbox next to the quick response that you want to personalize, then choose **Edit**.

4. Choose the content section, enter the quick response content, then use handlebar syntax to enter a user-defined attribute. Make sure you include the Attributes namespace prefix. For example, `{{Attributes.name_of_your_destination_key}}`.
5. Choose **Save**.

The following steps explain how to test attributes in CCP.

To test attributes

1. Log in to the Amazon Connect admin website chat testing page at https://instance_name.my.connect.aws/test-chat.
2. Choose the flow with the user-defined attribute.
3. Start a chat and enter `/#searchText`, where `searchText` is the assigned shortcut key.

Note

For more information, see [Test voice, chat, and task experiences](#).

Edit quick responses

This topic explains how to use the Amazon Connect admin website to edit a quick response. To edit a quick response programmatically, see [UpdateQuickResponse](#) in the *Amazon Q in Connect API Reference*.

To edit a response

1. Log in to the Amazon Connect admin website at <https://instance name.my.connect.aws/>. Use an **Admin** account, or an account assigned to a security profile that has **Content Management - Quick responses - Edit** permission.
2. On the navigation bar, choose **Agent applications**, then **Quick responses**.

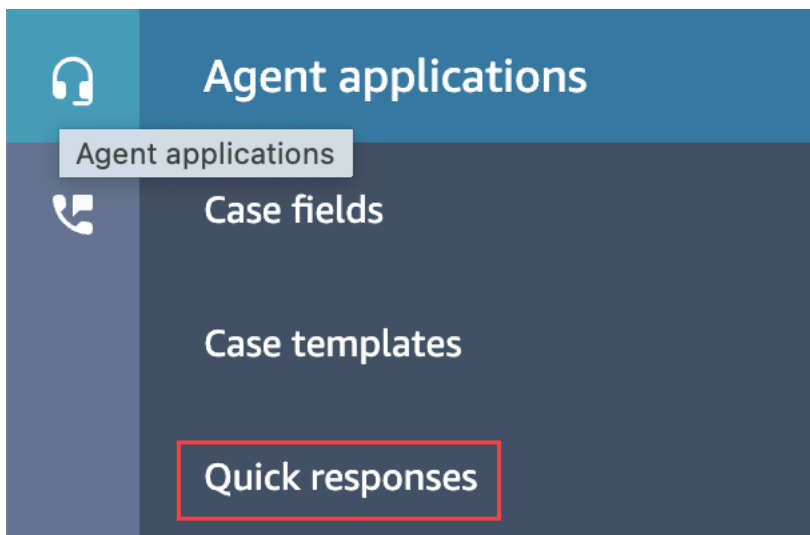

3. On the **Quick responses** page, choose the name of the quick response that you want to edit. You can also select the checkbox next to the response, then choose **Edit**.
4. As needed, change the following fields:
 - **Name**
 - **Description**
 - **Shortcut key**
 - **Routing Profiles**

- **Activate/Deactivate quick response**
- **Content**

5. Choose **Save**.

Delete quick responses

This topic explains how to use the Amazon Connect admin website to delete a quick response. To delete a quick response programmatically, see [DeleteQuickResponse](#) in the *Amazon Q in Connect API Reference Guide*.

Important

- You can't undo a deletion.
- Agents can't see or use deleted quick responses.

To delete a response

1. Log in to the Amazon Connect admin website at <https://instance name.my.connect.aws/>. Use an **Admin** account, or an account assigned to a security profile that has **Content Management - Quick responses - Delete** permission.
2. On the navigation bar, choose **Agent applications**, then **Quick responses**.

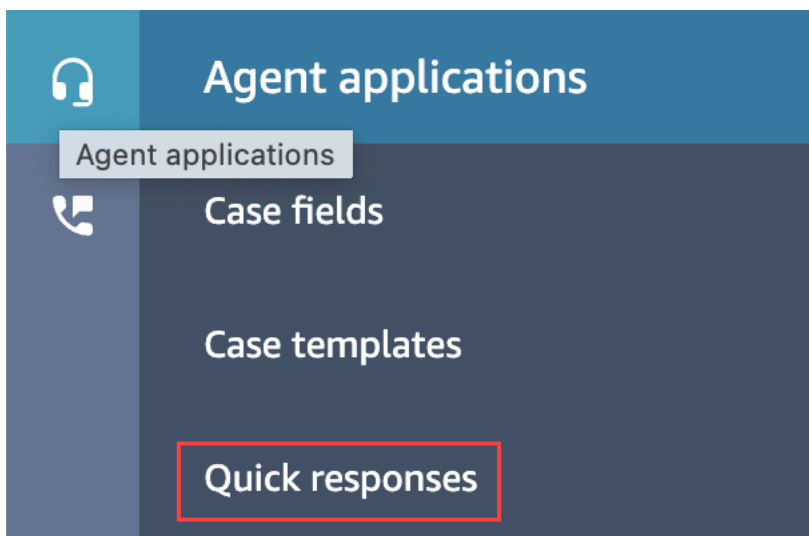

3. On the **Quick responses** page, select the checkbox next to the response that you want to delete. You can select a maximum of 20 responses.

4. Choose **Delete**.

A success message appears:

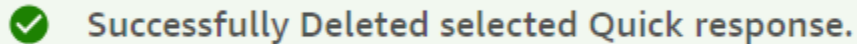
A green checkmark icon is followed by the text "Successfully Deleted selected Quick response." inside a light green rectangular box with a thin black border.

Note

- If the **Delete** button is inactive, sign in to an Amazon Connect account that has the required security profile, or ask another admin for help.
- Remain on the page until the delete operation finishes.

Import quick responses

You can import a maximum of 100 quick responses at a time from a .csv file. This topic explains how to use the Amazon Connect admin website to import quick responses. To import quick responses programmatically, see [StartImportJob](#) in the *Amazon Q in Connect API Reference*.

To import responses

1. Log in to the Amazon Connect admin website at `https://instance name.my.connect.aws/`. Use an **Admin** account, or an account assigned to a security profile that has **Content Management - Quick responses - Create** permission.
2. On the navigation bar, choose **Agent applications**, then **Quick responses**.

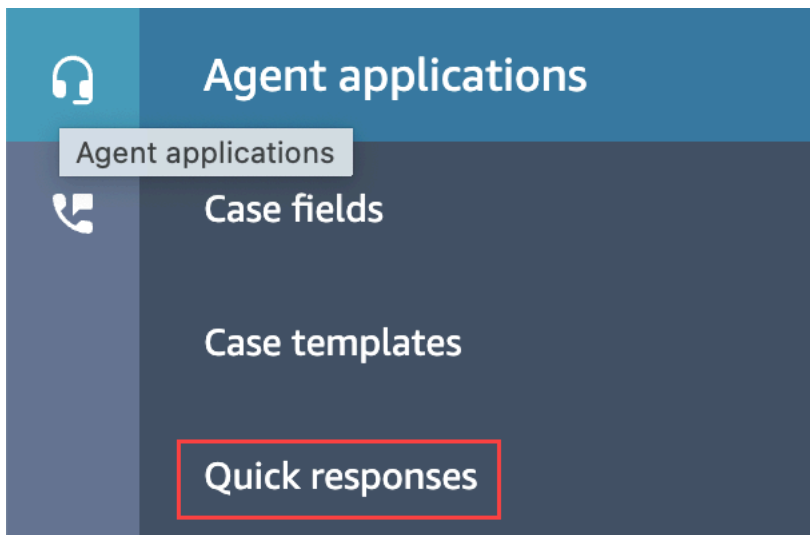

3. On the **Quick responses** page, choose **Import**.
4. In the **Import** dialog box, choose the **Responses Import Template.csv** link, then save the resulting **Response Import Template.csv** file to your desktop. The file opens in Microsoft Excel or a similar spreadsheet program.
5. In the .csv file, enter values in each column. Remember the following:
 - The **Name** and **Shortcut key** values must be unique across all the quick responses in your Amazon Connect instance.
 - Values in the **Routing Profile** column are case sensitive and must match the name of your routing profile exactly.
 - Do not rename or change the values in the first row of the .csv file. Those header keys are reserved and used to generate payloads for the [CreateQuickResponse](#) API.
 - Remove all instances of **<*Required field>** from the .csv file. They're only for information.
6. Save the .csv file, return to the Amazon Connect admin website, and in the **Import** dialog box, choose **Upload file**.
7. Locate and open the .csv file, then choose **Import**.

Success or failure messages appear when the import operation finishes. If the operation fails, choose the **Download failed imports link** in the message. Check the .csv file for leading or trailing spaces, and for any messages about the error.

You can navigate away from the **Quick response** page before the import job finishes. Choose the **View import history** link, located below the list of responses, to view status of your import jobs.

View import history

Amazon Connect retains import history for the lifetime of your knowledge base. To delete that history, you must use the [DeleteKnowledgeBase](#) action to delete the knowledge base.

This topic explains how to use the Amazon Connect admin website to view import histories. To view import histories programmatically, see [ListImportJobs](#) in the *Amazon Q in Connect API Reference*.

To view import history

1. Log in to the Amazon Connect admin website at <https://instance name.my.connect.aws/>. Use an **Admin** account, or an account assigned to a security profile that has **Content Management - Quick responses - View** permission.
2. On the left navigation bar, choose **Agent applications**, then **Quick responses**.

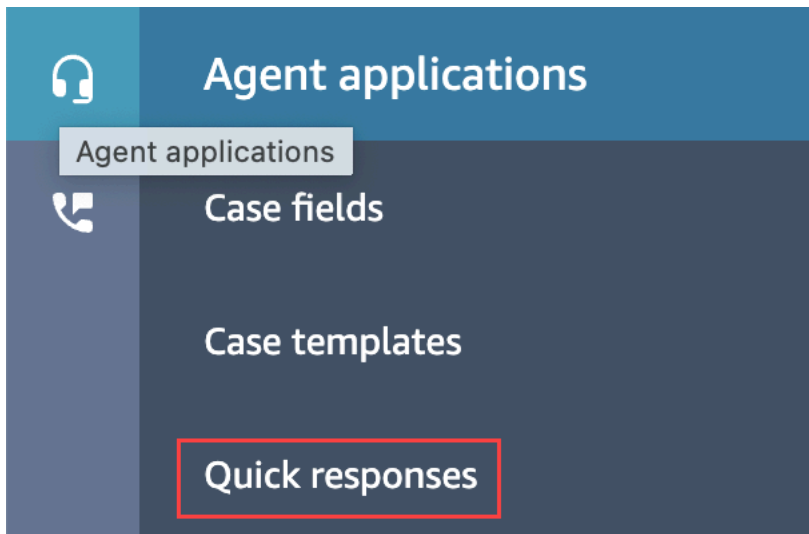

3. On the **Quick responses** page, choose the **View import history** link.

Enable quick responses in a custom CCP

To enable quick responses for an embedded or custom CCP, you use the [Amazon Connect Streams library](#) on GitHub to call the [SearchQuickResponse](#) API and return a list of quick response search results to CCP. For more information, see [Amazon Connect Streams Documentation](#) on Github.

Note

To prevent search API misuse, we implemented default values for the following request parameters:

- `debounceTime` – 250ms between subsequent `SearchQuickResponse` API calls
- `maxSearchResults` – 25
- Search priority order:
 1. `shortcut` key
 2. `name`
 3. `content`
 4. `description`

Enable text formatting for your customer's chat experience

With Amazon Connect message formatting, you can enable your customers and agents to quickly add structure and clarity to their chat messages.

Topics

- [Supported formatting types](#)
- [How to enable message formatting](#)
- [How to add email and phone links](#)
- [How to add chatbot messages](#)

Supported formatting types

You can provide the following types of formatting on both the chat user interface and the agent application using markdown:

- Bold
- Italic
- Bulleted list
- Numbered list
- Hyperlinks

- [Emoji](#)
- [Attachments](#). To enable attachments, follow [Enable attachments to share files using chat and upload files to cases](#).

How to enable message formatting

1. When you create a new [chat user interface](#), rich text formatting is enabled out of the box. No additional configuration is required.
2. To add text formatting capabilities to an existing [chat user interface](#), update the [communications widget code](#) with the following code that is highlighted in bold:

```
(function(w, d, x, id){
  s=d.createElement('script');
  s.src='https://d3xxxx.cloudfront.net/amazon-connect-chat-interface-
client.js';
  s.async=1;
  s.id=id;
  d.getElementsByTagName('head')[0].appendChild(s);
  w[x] = w[x] || function() { (w[x].ac = w[x].ac || []).push(arguments) };
})(window, document, 'amazon_connect', 'widget-id');
amazon_connect('styles', { openChat: { color: 'white', backgroundColor:
'#123456'}, closeChat: { color: 'white', backgroundColor: '#123456'} });
amazon_connect('snippetId', 'snippet-id');
amazon_connect('supportedMessagingContentTypes', [ 'text/plain', 'text/
markdown' ]);
```

The code that is highlighted in red is set to the correct values when you get the snippet from the Amazon Connect console. The only content you choose to add or remove is the last line in bold for supportedMessagingContentTypes.

3. To add text formatting capabilities to your own custom chat user interface (for example, [Chat Interface](#) or your own UI solution on top of [ChatJS](#)), follow these steps:
 - a. Call the [StartChatContact](#) API. When calling StartChatContact, add the SupportedMessagingContentTypes parameter as shown in bold in the following example:

```
// Amazon Connect StartChatContact API
```

```
{
  "Attributes": {
    "string" : "string"
  },
  "ClientToken": "string",
  "ContactFlowId": "your flow ID",
  "InitialMessage": {
    "Content": "string",
    "ContentType": "string"
  },
  "InstanceId": "your instance ID",
  "ParticipantDetails": {
    "DisplayName": "string"
  }

  // optional
  "SupportedMessagingContentTypes": [ "text/plain", "text/markdown" ]
}
```

- b. Import chatjs as an object, as shown in the following example:

```
import "amazon-connect-chatjs";

this.session = connect.ChatSession.create({
  ...
});

this.session.sendMessage({
  message: "message-in-markdown-format",
  contentType: "text/markdown"
});
```

If you don't use ChatJs, see these topics for information about sending markdown text through Amazon Connect APIs: [StartChatContact](#) and [SendMessage](#).

- c. Send messages with markdown. See the previous code snippet for importing chatjs as an object for an example of how to send messages. You can use simple markdown for formatting text in chats. If you're already [using chatjs today to send plaintext messages](#) you can modify your existing logic to call [SendMessage](#) with text/markdown as contentType instead of text/plain when you want to send markdown messages. Be sure to update the sendMessage parameter to have the markdown format of your messages. For more information, see [Markdown Guide Basic Syntax](#).

- d. Implement your own logic in the UI package to render markdown messages in the input area and chat transcript. If you use React, you can use [react-markdown](#) as a reference.

Note

- Text formatting capabilities appear to your agent only if the feature has been enabled for your customer in the chat user interface. If text formatting is not supported or enabled on the customer chat user interface, the agent will not have the ability to compose and send messages with text formatting.
- All text formatting capabilities except attachments are available for [quick responses](#).

How to add email and phone links

The following example shows how to add clickable and callable links to your web and mobile applications.

```
Call us today: [+1 (123) 456-7890](tel:+11234567890)
[Call Us](tel:+11234567890)
[Skype Us](callto:+91123-456-7890)
[Fax Us](fax:+91123-456-7890)
[Text Us](SMS:+91123-456-7890)
[Email Us](mailto:name@email.com)
```

How to add chatbot messages

When you enable markdown for chat messages, you can use rich text formatting for the following types of chatbot messages:

- [Play prompt](#) flows
- [Get customer input](#) flows
- SYSTEM_MESSAGE
- Lex BOT
- Third Party BOT
- Lex BOT Lambda

The following image shows how to enable a prompt manually in a [Play prompt](#) flow block:

The screenshot displays the Amazon Connect console interface for configuring a flow. On the left, a 'Blocks' panel shows a search for 'play prompt' and a 'Play prompt' block description: 'Delivers an audio or chat message.' The main workspace shows a flow starting from an 'Entry' block and leading to a 'Play prompt' block named 'RichTextBotExample'. The 'Play prompt' block has a configuration panel on the right. The 'Block Type' is 'Play prompt'. The 'Block Name' is 'RichTextBotExample'. The configuration options are: 'Select from the prompt library (audio)', 'Specify an audio file from an S3 bucket', 'Text-to-speech or chat text', and 'Set manually' (which is selected). The 'Text-to-speech or chat text' option is also selected. The 'Text' input field contains the text: 'Review our [FAQ](aws.amazon.com/faq) or give us a call: [(123) 456-7890] (tel:+11234567890)'. The 'Interpret as' dropdown is set to 'Text'.

The following image shows how to enable a prompt manually in the a [Get customer input](#) flow block, then associate the flow block with an Amazon Lex bot:

The screenshot displays the Amazon Connect MyContactFlow editor. On the left, a 'Blocks' sidebar lists 'get customer' and 'Get customer input'. The central workspace shows a flow diagram with an 'Entry' block connected to a 'RichTextLexBotExample' block. The right-hand configuration panel is open for the 'Get customer input' block. It shows the block name 'RichTextLexBotExample' and a text prompt: 'How can we help you today? Review our [FAQ](aws.amazon.com/faq) or give us a call: [(123) 456-7890] (tel:+11234567890)'. The 'Delivery method' is set to 'Text-to-speech or chat text'. Under the 'Amazon Lex' section, 'MyLexBot' is selected as the bot.

The following image shows how the prompt appears in the SYSTEM_MESSAGE and various BOT message types:

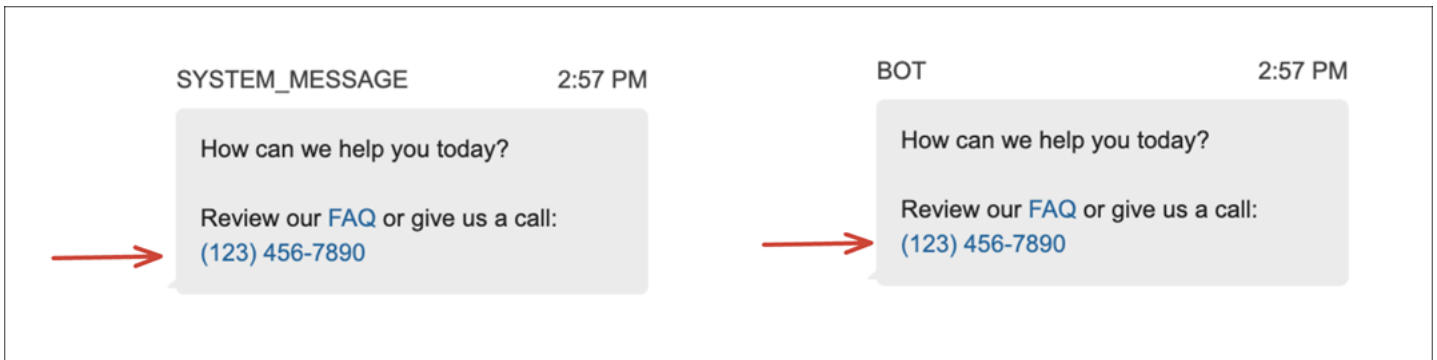

The following image shows how to set up a prompt in an Amazon Lex bot intent:

The screenshot shows the Amazon Lex console configuration for an intent named "SpeakToAgent". The intent details include the name "RichTextIntent", a description, and a closing response with a message group containing a prompt.

Intent: SpeakToAgent Info

An intent represents an action that fulfills a user's request. Intents can have arguments called slots that represent variable information.

Conversation flow Info

Intent details Info

Intent name: RichTextIntent
Maximum 100 characters. Valid characters: A-Z, a-z, 0-9, -, _

Description - optional: [Empty text box]
Maximum 200 characters.

ID: UZYAOJ3LEA

Closing response Info Active
You can define the response when closing the intent.

Response sent to the user after the intent is fulfilled
Message: Review our [FAQ][aws.amazon.com/faq] or give us a call: [(123) 456-7890](tel:+11234567890)

Message group Info
You can define a text message group to respond using plain text.

Message: Review our [FAQ][aws.amazon.com/faq] or give us a call: [(123) 456-7890](tel:+11234567890)

For more information about intents, see [Adding intents](#) in the *Amazon Lex V2 Developer Guide*. For more information about Lambda messages, see [Enabling custom logic with AWS Lambda functions](#), also in the *Amazon Lex V2 Developer Guide*.

Enable message *Delivered* and *Read* receipts in your chat user interface

You can enable message *Delivered* and *Read* in your [chat user interface](#) so your customers know the status of the messages they send. This provides transparency to customers, and improves the overall chat experience.

i Tip

By default message receipts are already enabled in the [Test chat](#) experience, the Contact Control Panel (CCP), and [downloadable open source example](#) of the chat widget.

To enable message receipts in your chat user interface

1. Log in to the Amazon Connect admin website at https://instance_name.my.connect.aws/. Choose **Customize communications widget**.

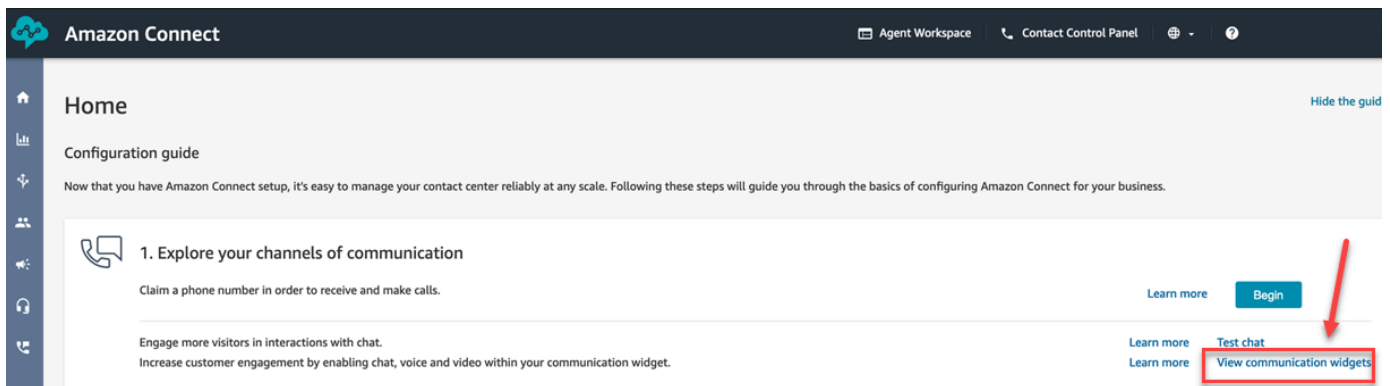

2. Choose **Edit**.

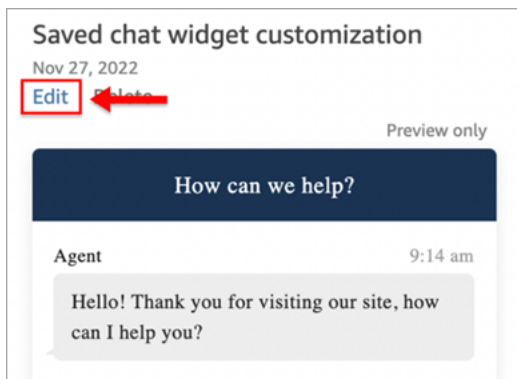

3. By default **Message receipts** is not enabled. Set to **Enabled**.

Message receipts are now enabled. Customers who are using the communications widget will start seeing *Delivered* and *Read* receipts immediately.

Set up chat timeouts for chat participants

When a chat conversation between an agent and a customer has been inactive (no messages sent) for a certain amount of time, you may want to consider a chat participant to be idle, and you may even want to automatically disconnect an agent from the chat.

To do this you can configure both idle timeouts and auto-close timeouts using the [UpdateParticipantRoleConfig](#) action.

Tip

You configure chat timeouts for when customers are interacting with Lex, in the [Flow block: Get customer input](#) block. See the [Configurable time-outs for chat input during a Lex interaction](#) section.

You can set four different types of timers.

- You specify the amount of time that has to elapse before an action is taken.
- Any combination of timers can be used.

Timer	Action at end of timer
Customer idle timeout	Mark the customer as idle.

Timer	Action at end of timer
Customer auto-disconnect timeout	Automatically disconnect the agent from the chat due to customer idleness.
Agent idle timeout	Mark the agent as idle.
Agent auto-disconnect timeout	Automatically disconnect the agent from the chat due to agent idleness.

Specify all timers in minutes.

- Minimum: 2 minutes
- Maximum: 480 minutes (8 hours)

Timers apply to participant roles, and apply for life of the chat.

- You configure timers for participant roles such as agent and customer, rather than individual participants.
- After you set the timers, they apply for the life of the chat. If a chat is transferred, the timers apply to the new agent/customer interaction.

How chat timers work

Timers behave as follows:

- Timers run when both an agent and a customer are connected to the chat, or when a customer and a custom participant (such as a custom bot) are connected.
- Timers are first started when an agent/custom participant joins the chat, and are stopped if the agent/custom participant leaves the chat.
- Idle timers run before auto-disconnect timers, if both are configured for a role. For example, if both timers are configured, then the auto-disconnect timer starts only after a participant is deemed idle.
- If only one type of timer is configured for a role, then that timer starts immediately.
- If at any time a participant sends a message, the timers for that participant are reset. If they were considered idle, they will no longer be.

- The configuration that was set when the agent/custom participant joined applies for as long as the agent/custom participant remains on the chat. If you update the timer configuration while an agent/custom participant and customer are already connected to each other, the new configuration is stored but not applied until and unless a new agent/custom participant connects to the chat.
- When an auto-disconnect event occurs, all participants other than the customer (such as the agent, any monitoring supervisor, or custom participants) are disconnected. If the agent is the one disconnected, and if a [Set disconnect flow](#) block has been configured, then the chat is routed to it.

Idle timer expiry

Following is what happens when an idle timer expires during a customer-custom participant interaction:

1. An idle event is fanned out to all websockets/streaming endpoints.
2. If an auto-disconnect timer is configured, it is started.
3. If the idle timer expires while the chat contact is in a **Wait** block, the contact is NOT routed down the **Time Expired** branch. No action is taken if this scenario occurs.

Auto-disconnecting custom participants

When an auto-disconnect timer expires, the custom participant is disconnected from the chat.

Amazon Connect performs one of the following steps when auto-disconnect timers expire:

1. The chat currently resides in a [Wait](#) block that is configured for a custom participant.
 - The custom participant is disconnected from the chat, and the chat resumes the flow by taking the **Bot participant disconnected** branch.
2. The chat currently resides in a [Wait](#) block that is configured for the customer OR the chat is not in a **Wait** block.
 - The custom participant is disconnected from the chat and no other actions are taken.

Messages displayed to participants

Messages are displayed to all participants when any one of the following events happen:

- A participant becomes idle.
- An idle participant sends a message, and is no longer idle.
- An auto-disconnect occurs. Because the agent is disconnected, they won't be able to see the message.

These events are not persisted to the transcripts, nor billed.

The default messages (in all supported languages) are displayed to agents in the Contact Control Panel (CCP) for each of these events.

The following image show examples of default idleness messages that the agent would see in the CCP. For example, *Agent has become idle*.

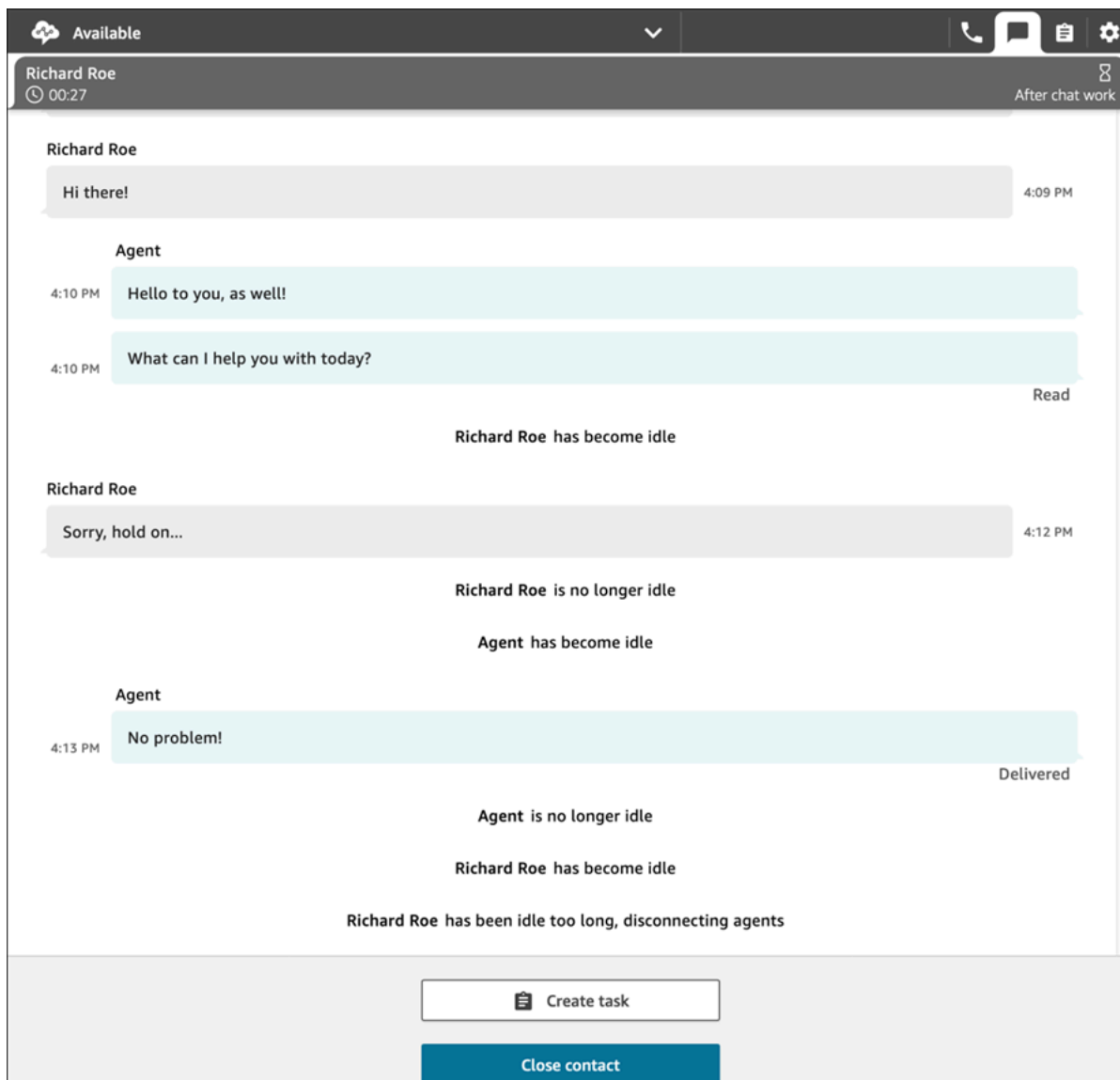

Recommended usage

To use the chat timeout feature, we recommend that you do the following:

1. Embed a call to the [UpdateParticipantRoleConfig](#) action in a Lambda in a contact flow.
2. Depending on your use case, place the Lambda either immediately after starting the chat (at the beginning of the flow) or right before routing the contact to a queue.

Customize the customer's chat user interface for a disconnect event

To customize your customer's chat user interface for a disconnect event, see the following methods in the [ChatJS](#):

- `onParticipantIdle(callback)`
- `onParticipantReturned(callback)`
- `onAutoDisconnection(callback)`

Use these methods to register callback handlers which are triggered when the new events arrive.

Enable persistent chat

Customers often start a chat, then leave the conversation and return later to continue chatting. This may happen many times over the course of several days, months, or even years. To support long running chats like these, you enable persistent chat.

With persistent chat, customers can resume previous conversations with the context, metadata, and transcripts carried forward. Customers don't need to repeat themselves when they return to a chat, and agents have access to the entire conversation history.

Chat rehydration

Persistent chat is achieved through a process called chat rehydration, this process enables chat transcripts to be retrieved from previous chat contacts and displayed, allowing customers and agents to easily continue conversations from where they left off.

Important

Only chat sessions that have ended are allowed to rehydrate onto a new chat session.

Amazon Connect supports two types of rehydration:

- `ENTIRE_PAST_SESSION`: Starts a new chat session and rehydrates all chat segments from past chat sessions.
- `FROM_SEGMENT`: Starts a new session and rehydrates from the specified past chat segment.

For example use cases that show these different rehydration modes, see [Example use cases](#).

RelatedContactId

A new contact can have an association with an existing contact through the `RelatedContactId`. This new contact contains a copy of the [contact properties](#) from the related contact.

For more information about how the `RelatedContactId` is modeled in contact records, see [Contact records data model](#).

For persistent chat, the `RelatedContactId` depicts the `contactId` used to source chat rehydration.

How to enable persistent chat

To enable persistent chat, you can either specify a previous contact ID when creating a new chat or you can add the [Create persistent contact association](#) block to a contact flow.

Note

You can choose either method, noted below, to persist chats but not both. That is, you can only enable persistence of a `SourceContactID` on a new chat once.

To deliver persistent chat experiences you need to provide a previous contact ID when starting a new chat or when using the [Create persistent contact association](#) flow block.

This is not automatically done for you. It is recommended that you create a repository for storing CTR data, which will enable retrieval of this data for each of your customers. This can be done using [chat message streaming](#) to create an entry when a chat has ended or alternatively by inspecting [Contact events](#) and using [AWS Lambda function](#) for creating entries into your repository. After a repository is setup you can retrieve the previous contact ID for the customer and provide it when starting a new chat or within the [Create persistent contact association](#) flow block.

In addition, please ensure past chat transcripts can be retrieved from your instance's Amazon S3 bucket. Using multiple chat transcript buckets or changing the chat transcript

file name that is generated by Amazon Connect will prevent retrieval of transcripts, and will not allow chats to persist.

Enable Persistent chat when creating a new chat contact

To set up persistent chat experiences when creating a new chat contact, provide the previous contactId in the SourceContactId parameter of the [StartChatContact](#) API, this will enable the chat transcripts of previous contacts to be “rehydrated” and shown to both the customer and agent within the chat UI’s, see Example use cases.

Enable Persistent chat within a contact flow

To setup persistent chat experiences within a contact flow, after a chat contact has been created, add the [Create persistent contact association](#) block to your contact flow and programmatically specify a source contact ID by using a user defined attribute. You can also use the new CreatePersistentContactAssociation API and provide a source contact ID to make the current chat persistent. For more information, see [CreatePersistentContactAssociation](#) in the *Amazon Connect API Reference*.

Create persistent contact association

Specify an attribute to create a persistent contact association.

Success

Error

Block Type

Create persistent contact association

Block Name

Enter a block name

0 / 50

Specify an attribute to create a persistent contact association, enabling conversations to continue from where they left off

The source contact Id specified below is a past contact Id from which a conversation will be "rehydrated", enabling transcripts from past chat sessions to be shown to the participants in their current chat session. [Learn more](#)

Select rehydration type

Entire Past Session

From Segment

Use attribute

Namespace

Note: The error branch will be taken for non-chat contacts and for chat contacts that cannot be restored.

Example use cases

For example, a customer starts a chat session:

1. Agent a1 accepts the chat, and the conversation starts between the customer and agent a1. This is the first contact created in the current chat session. For example, the contactId **C1** might be 11111111-aaaa-bbbb-1111-11111111111111.
2. Agent a1 then transfers the chat to Agent a2. This creates another contact. For example, contactId **C2** might be 22222222-aaaa-bbbb-2222-2222222222222222.
3. Agent a2 ends the chat.

4. The customer is forwarded to the disconnect flow for a post-chat survey that creates another contact. For example, contactId **C3** might be 33333333-aaaa-bbbb-3333-33333333333333.
5. The post-chat survey is displayed, and the chat session ends.
6. Later, the customer returns and wants to resume their past chat session.

At this point, there are potentially two different use cases for the customer. Following are the persistent chat use cases the customer can have, and how you configure Amazon Connect to provide them.

Use case 1

The customer wants to continue their past chat session but they want to hide the post-chat survey. You use the following configuration to provide this experience.

Request:

```
PUT /contact/chat HTTP/1.1
Content-type: application/json
{
  "Attributes": {
    "string" : "string"
  },
  "ContactFlowId": "string",
  "InitialMessage": {
    "Content": "string",
    "ContentType": "string"
  },
  "InstanceId": "string",
  ... // other chat fields

  // NEW Attribute for persistent chat
  "PersistentChat" : {
    "SourceContactId": "2222222-aaaa-bbbb-2222-2222222222222222"
    "RehydrationType": "FROM_SEGMENT"
  }
}
```

Configuration

- SourceContactId = 2222222-aaaa-bbbb-2222-2222222222222222 (the contactId for C2)

- `RehydrationType = "FROM_SEGMENT"`

Expected behavior

- This configuration starts a persistent chat session from the specified past ended contact C2 (for example, 2222222-aaaa-bbbb-2222-2222222222222222).

Transcripts of past chat sessions C2 (2222222-aaaa-bbbb-2222-2222222222222222) and C1 (11111111-aaaa-bbbb-1111-11111111111111) are accessible in the current persistent chat session. Note that chat segment C3 (33333333-aaaa-bbbb-3333-33333333333333) is dropped from the persistent chat session.

- In this case, the [StartChatContact](#) response returns C2 (2222222-aaaa-bbbb-2222-2222222222222222) as "ContinuedFromContactId".
- The `RelatedContactId` for this persistent chat session is 2222222-aaaa-bbbb-2222-2222222222222222 (C2).

Use case 2

The customer wants to continue the past chat session and see the transcript of the entire past engagement (and they don't want to hide the post-chat survey). You use the following configuration to provide this experience.

Note

For the `ENTIRE_PAST_SESSION` rehydration type, specify the first contact (initial `contactId`) of the past chat session as the `SourceContactId` attribute.

Request:

```
PUT /contact/chat HTTP/1.1
Content-type: application/json
{
  "Attributes": {
    "string" : "string"
  },
  "ContactFlowId": "string",
  "InitialMessage": {
    "Content": "string",
```

```
    "ContentType": "string"
  },
  "InstanceId": "string",
  ... // other chat fields

  // NEW Attribute for persistent chat
  "PersistentChat":{
    "SourceContactId":"11111111-aaaa-bbbb-1111-111111111111" // (first contactId
C1)
    "RehydrationType":"ENTIRE_PAST_SESSION"
  }
}
```

Configuration

- SourceContactId = 11111111-aaaa-bbbb-1111-111111111111 (C1)
- RehydrationType = "ENTIRE_PAST_SESSION"

Expected behavior

- This starts a persistent chat session from the most recently ended chat contact (C3). Transcripts of past chat sessions C3, C2 and C1 are accessible in the current persistent chat session.
- In this case, the [StartChatContact](#) response returns 33333333-aaaa-bbbb-3333-333333333333 (C3) as "ContinuedFromContactId".
- The RelatedContactId for this persistent chat session is 33333333-aaaa-bbbb-3333-333333333333 (C3)

Note

Chat linkages are cumulative. After chat sessions are linked, they carry over.

For example, if a contact (contactId C2) that belongs to a past chat session was linked to a contact (contactId C1) from a different past chat session, then a new persistent chat session created by linking C2 results in implicit linkage of C1 as well. The new persistent chat session will have the following linkage: C3 → C2 → C1

The past contactId, which the persistent chat session is continued from, is exposed in the ContinuedFromContactId field in the [StartChatContact](#) API response. It's also in the RelatedContactId field in the [contact record](#) for the contact

How to access past chat contact transcript for a persistent chat

Accessing the past chat transcript for persistent chat uses the existing NextToken pagination model. The initial call to [GetTranscript](#) on a newly started persistent chat session contains a NextToken in the response, if past chat messages exist. NextToken must be used to access the past chat transcript along with setting the ScanDirection to BACKWARD on the subsequent [GetTranscript](#) call to fetch past chat messages.

If there are multiple past chat messages, [GetTranscript](#) returns a new NextToken and the same process can be repeated to fetch more past chat transcripts.

Not supported: using StartPosition and contactId filters for persistent chat

Amazon Connect does not support using StartPosition and contactId filters on the [GetTranscript](#) call for transcript item attributes that are from the past chat.

Enable Apple Messages for Business

Your customers can engage directly with your contact center from within their Messages application on their iPhone, iPad, and Mac.

When you enable Apple Messages for Business, your customers can find answers to their questions and request help from agents to resolve issues — all while using the familiar Messages application they use every day to chat with friends and family. Any time customers use Search, Safari, Spotlight, Siri, or Maps to call your registered phone number, they will be provided with the option to chat with your contact center.

Apple Messages for Business integration with Amazon Connect enables you to use the same configuration, analytics, routing, and agent UI that you already use for [Amazon Connect Chat](#).

Step 1: Register with Apple

Integrate Apple Messages for Business with Amazon Connect by first registering with Apple as a brand. When you do, you'll get a unique Apple Messages for Business Account ID, and you can then link your Apple Messages for Business account to Amazon Connect.

1. Go to the [Apple Messages for Business](#) page. In the box that says **As a business, I want to connect with my customers in the Messages app**, choose **Get Started**.
2. Create an Apple ID for your business, if you don't already have one.

An Apple ID is typically for the personal use of Apple services, such as storing personal content in iCloud and downloading apps from the App Store. If you have a personal Apple ID, we recommend that you create a separate one using your organization's email address to administer Messages for Business. A separate administrative Apple ID lets you distinguish Messages for Business communications from personal Apple communications.

3. Register a profile for a new Messages for Business account by accepting **Apple's Terms of Service**. We recommend creating a [Commercial Messages for Business Account](#). You then provide business details, such as a logo and support hours.
4. Select Amazon Connect as your Messaging Service Provider. You can do this by selecting Amazon Connect from the drop-down or by entering the following URL:
 - <https://messagingintegrations.connect.amazonaws.com/applebusinesschat>

After you submit your application to Apple, you'll see the status of your application at the top of your **Messages for Business Account** page.

For more information about registering with Apple, see the following articles on Apple's website: [Getting Started with Messages for Business](#) and [Messages for Business Policies and Best Practices](#).

Step 2: Gather required information

Gather the following information so you have it on hand when you open a support ticket in Step 3:

1. **Apple Messages for Business Account ID:** After you've been approved by Apple Messages for Business, you will be issued an Apple Messages for Business Account ID. For information about locating your Apple Messages for Business Account ID, see [Find your Apple Messages for Business Account ID](#).

Note

Your Apple Messages for Business Account ID is a randomized string of numbers and letters. It is not the same as your Apple ID.

2. **Apple Token:** This is a unique ID that authenticates your account. For help locating your Apple token, see [Find your Apple token](#).

3. **Amazon Connect instance ARN:** This is the identifier for the instance you want to link to your Apple business account. For information about locating your instance ID, see [Find your Amazon Connect instance ID/ARN](#).

Note

Make sure you have service-linked roles enabled for the integration. If your instance was created before **October 2018**, add the `connect : *` policy on the role that is associated with your Amazon Connect instance. For more information about service-linked roles, see [Use service-linked roles for Amazon Connect](#).

4. **Amazon Connect flow ID:** This is the identifier for the flow you want to use for inbound chats. For information about locating your flow ID, see [Find the flow ID](#).

Step 3: Link your Apple Messages for Business ID to Amazon Connect

In this step you create an Amazon Connect support ticket to link your Apple Messages for Business ID to Amazon Connect.

1. Create a [special AWS Support ticket](#) to link your Apple Messages for Business to Amazon Connect.

If prompted, login using your AWS account.

Tip

Looking for technical support? [Open an AWS Support ticket here](#).

2. Choose **Account and billing**.
3. Use the dropdown box to choose **Account**. For **Category** choose **Activation**, and then choose **Next step: Additional information**.
4. For **Subject** enter **Apple Messages for Business Integration request**.
5. In the **Description** box, copy and paste the following template:

Subject: Apple Messages for Business Integration request

Body:

Apple Messages for Business Account ID (required): *enter your account ID*

Apple Token (required): *enter your Apple token*
 Amazon Connect Instance ARN (required): *enter your instance ARN*
 Amazon Connect Flow ID (required): *enter your flow ID*

The following image shows an example of a completed ticket:

Subject

Apple Messages for Business Integration request

Maximum 250 characters (203 remaining)

Description

Don't share any sensitive information in case correspondences, such as credentials, credit cards, signed URLs, or personally identifiable information.

[Learn more](#)

Subject: Apple Messages for Business Integration request

Body:

Apple Messages for Business Account ID (required): f2222ff22-222f-2fff-b222-f222fff22222

Apple Token (required):
 eeJeeJeeOiJIUzl1NiJ9.eeJeeWQiOiwZDE2YzA2NC04NWJjLTQyYmMtOWQyMC1iNGNlYjRjN2FINjUiLCJpXYQiOhE2MjU3NzczMTUvVVVVVVVl6ImJlOTZhMGUyLTNlYzktNDVjYi05N2Y2LTE0MTA0YvVvODE4NSJ9.vVQv9vf2K5WQJvvK62vvJlZYM0HvTCvWYl8TbOclR2v

Amazon Connect Instance ARN (required): ®ion-arn;connect:us-west-2:222222222222:instance/00a000b0-a00b-000a-

Maximum 5000 characters (4393 remaining)

6. Choose **Next step**.
7. Choose **Contact us**, choose your **Preferred contact language**, and then choose **Web** as the contact method, if it's not selected by default.

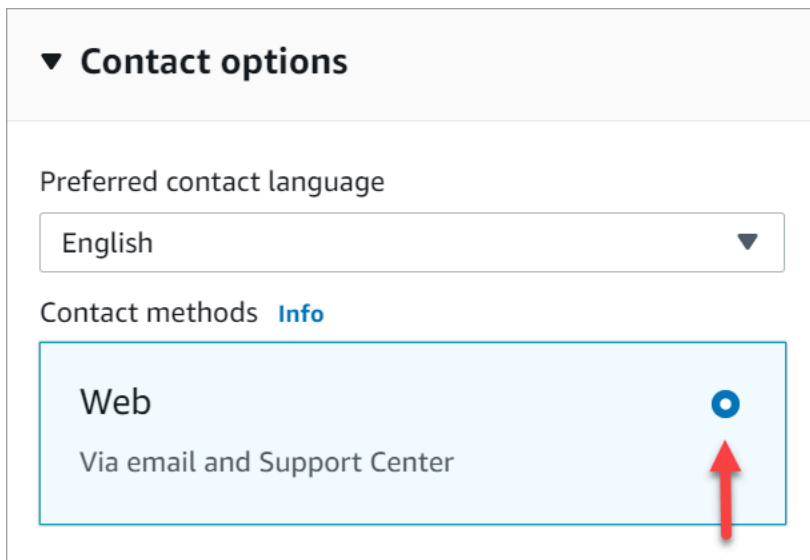

▼ **Contact options**

Preferred contact language

English ▼

Contact methods [Info](#)

Web 

Via email and Support Center

8. Choose **Submit**.
9. AWS Support will work directly with the Amazon Connect team on your request and follow up with any additional questions.

Next steps

After Apple Messages for Business is enabled for your Amazon Connect instance, you can [add Apple Messages for Business features](#) to your messages. For example:

- Deflect calls with Apple's Message Suggest.
- Embed Apple Messages for Business buttons on your website.
- Add list pickers, time pickers, forms, and quick replies to your messages.
- Add Apple Pay, iMessage Apps, and Authentication to your integration.
- Use rich links for URLs.
- Route Apple Messages for Business messages using contact attributes.
- Enable Attachments for your integration.

Additionally, pass the [Apple experience review](#).

Send a test message for Apple Messages for Business

After onboarding to the Apple Messages for Business account, use the following steps to send a test message to make sure the integration is set up properly.

Step 1: Add internal testers to your Messages for Business account

1. Sign in to [Apple Business Register](#).
2. Choose **Messages for Business Accounts** and select the account to add testers.
3. Scroll down the page to **Account Testing**.
4. Add the Apple IDs of your internal testers.
5. When your list is complete and you are ready to begin testing, choose **Send to new testers** to send an instructional email to your testers.

An instructional email containing a link to your Messages for Business conversation is sent to the Apple ID email address of each tester. If a tester does not receive the email, then recheck that their email address is provided in the Account Testing section. It's most likely that the email address is incorrect or it's not an Apple ID. For security reasons, Apple cannot verify Apple ID email addresses.

Step 2: Test sending and receiving messages

When your testers get the instructional email, they will need to activate the link in it. After doing this, they can send messages to your agents, who can then reply from the Contact Control Panel (CCP).

Note the following:

1. Design a test to trigger all of your Apple Messages for Business features.
2. You should observe that messages sent from an iOS device arrive to your test business. Employees testing from your support agent desktop should be able to respond to these test messages.
3. Your testers may notice your brand colors are not visible in the Messages header. Brand color is not available while your account is in test mode. The colors for your brand will display correctly after your account goes online.
4. If you send the testing link to someone whose email is not listed in the Account Testing section, they will not be able to send messages.
5. If you provide a Redirect Page URL and your testers try to enter Messages for Business from an unsupported device, they will land either on a default or redirected page. You can set your Redirect Page URL in the **Unsupported Devices** section at the bottom of your Messages for Business account page.

To begin testing

1. Check that your testers are using a device with a supported iOS: iOS 11.3 and later, or macOS 10.13.4.
2. Ask your testers to do the following:
 - a. Use their supported devices to find the email sent to them.
 - b. Open the email from the supported device, and then choose the link. It takes them to a Messages for Business conversation in the Messages app.

Troubleshoot

If you encounter any issues when sending a test message, follow these steps:

1. Confirm that you've allowlisted your email address/Apple ID as a tester in your Messages for Business account.
2. Confirm the following settings on your Apple device:
 - Go to **Settings > Messages** and check that **iMessage** is enabled.
 - Go to **Settings > Messages > Send & Receive** and check that the AppleID is correct and messages are allowed to receive.
3. Check that you're using a supported iOS. Apple devices running iOS 11.3 and later or macOS 10.13.4 and later support Messages for Business.
4. When you selected Amazon Connect as your MSP in your Apple Account, did you select **Amazon Connect** from the dropdown? Or did you enter the following URL:
 - <https://messagingintegrations.connect.amazonaws.com/applebusinesschat>

If you entered the URL, doublecheck for typos.

Enabling Authentication for Apple Messages for Business

Note

The Authenticate Customer block is only supported for Apple Messages for Business contact flows.

To begin the setup process, first navigate to your Identity Provider.

Identity Provider Configuration

The following Amazon Connect domain must be registered as an allowed Redirect URI for the Identity Provider(s) used for authentication:

```
https://participant.connect.region.amazonaws.com/participant/authentication/update
```

Integration with AWS Cognito

You can [add your Identity Provider\(s\)](#) to an existing AWS Cognito User Pool or create a new [AWS Cognito User Pool](#).

Within this User Pool you can create an [App Client](#) and select some or all of your Identity Providers. Take note of the App Client's Client ID. For this App Client, the following Amazon Connect domain must be added as an Allowed callback URL:

```
https://participant.connect.region.amazonaws.com/participant/authentication/update
```

Note

You must select **Don't generate a client secret** when configuring the App Client. Only App Clients without client secrets are supported.

Configuring your Cognito App Client with the Apple Messages For Business Portal

On **Integrated OAuth2 Authentication**, configure your Cognito App Client Client ID as the **Client Identifier** and your Cognito User Pool Domain's [authorization endpoint](#) as the **OAuth URL**.

^ Integrated OAuth2 Authentication Edit

OAuth URL ← Optional

Client Identifier ← Optional

Token URL
Optional

Configuring your User Pools with Amazon Connect

On the **Customer authentication** page on the Amazon Connect Console associate the User Pool that will be used for the authentication.

Customer authentication

Enable authentication for your customers. This service offers a secure method to authenticate customers without storing passwords. By adding a user pool that's linked with AWS Cognito, you grant Amazon Connect permission to interact with it. [Learn more](#)

How it works

- Add user pool**
Integrate your desired provider in AWS Cognito with Amazon Connect. You must provide details about your identity provider in this step.
[Create user pool in AWS Cognito](#)
- Enable authentication flow & Customer Profiles**
Connect with your customers by establishing when and how they will authenticate with your identity provider. Retrieve customer information by using Amazon Connect Customer Profiles.
- Successful authentication!**
Your customers will now experience a simplified authentication process. Agents will be able to communicate with authenticated customers.

[Associate User Pool](#)

Enable Amazon Connect Customer Profiles

Enable Customer Profiles

On the **Customer Profiles** page in Amazon Connect console, ensure that Customer Profiles is enabled for your instance. If **No Customer Profiles domain associated with this instance of Connect.** is displayed, then see [Enable Customer Profiles for your instance](#).

Amazon Connect Customer Profiles

Customer Profiles automatically integrates with your customer data from Amazon Connect. Combined with customer information from integrations with your applications, you can create a customer profile that contains all the information that agents need during customer interactions. [Learn more](#)

Customer Profiles domain [Info](#) [Enable](#)

No Customer Profiles domain associated with this instance of Connect.
Enable a new or existing domain to enable Customer Profiles.
[Enable Customer Profiles](#)

Profile metrics [Info](#)
Overall profiles in this Customer Profiles domain since the last update.

Total profiles
—

Last updated: May 23, 2024

Identity Resolution [Info](#)

How it works
Enable Identity Resolution to apply pre-configured matching methods to find duplicate profiles. Additional charges may apply. [See pricing](#)

- Next, you can set up merging to consolidate your matches and reduce duplicates.
- You can do additional customizations, such as write results to Amazon S3 and edit matching methods.
- Each week, view aggregated Identity Resolution metrics for this Customer Profiles domain.

Grant Customer Profile permission(s) to security profiles (optional)

To grant users (agent, admin) permissions to view/edit/publish Customer Profiles in Agent Workspace, see [How update permissions for agents](#). After permission(s) are granted to security profile(s), users should be able to access the features in the Agent Workspace.

For a detailed list of permissions, see [Customer Profiles security profile permissions](#).

Configuring the Authenticate Customer Flow Block

In your contact flow, select the **Authenticate Customer** flow block.

Block Type ✕

Authenticate Customer

Block Name

0 / 50

Prompts customer to sign in and authenticate with an identity provider configured in AWS Cognito. This block uses OpenId Connect or SAML to interact with the configured identity provider for authentication and token requests. [Learn more](#)

AWS Cognito

 Select an AWS Cognito User Pool ▼

User pool is required

 Select an AWS Cognito App Client ▼

App client is required

Amazon Connect Customer Profile Configuration

Select "Store by default template" to use email or phone number to identify and map authentication data into a customer profile, or specify a unique identifier. [Learn more](#)

Store by default template

Enter a unique identifier

Timeout

Set timeout (Minimum 3 minutes)

minutes

AWS Cognito

- **Select the AWS Cognito User Pool:** After you associate the user pool on the console page, choose the name of the user pool from the drop-down list.
- **Select the AWS Cognito App Client:** After you select the user pool, choose the name of the app client from the drop-down list.

Amazon Connect Customer Profile Configuration

- **Store by default template:** By choosing the default template, Amazon Connect Customer Profiles will ingest [AWS Cognito standard attributes](#) into a unified standard profile object for you based on a predefined Customer Profiles object type. This template uses phone number and email to map the customer to a profile.
- **Enter a unique identifier:** Amazon Connect Customer Profile's data ingestion can be customized by [creating an object type mapping](#). If you want to customize the data mapping or key, please create your own object type mapping in advance, select Enter a unique identifier option and enter the mapping name.
- **Timeout**
 - Use the **Timeout** field to configure timeouts for sign-in link. Enter how long until inactive customers timeout in a authentication workflow
 - Minimum(default): 3 mins
 - Maximum: 15 mins

Add Apple Messages for Business features

Deflect calls with Apple's Message Suggest

With [Message Suggest](#) you can allow users to choose between voice and messaging when tapping on your business phone number in Safari, Maps, Siri, or Search.

To enable Message Suggest, send an email to the Apple Messages for Business Team at registry@apple.com with the following information and Apple can set up the channel for you:

- Provide all of your primary phone numbers, including high call volume phone numbers.
- Provide phone contact hours to set customer expectations for your after-hours message.
- Provide intent, group, and body parameters to associate with each phone number.

- Provide an estimate of how many customers your agents can support per day. This can be increased or decreased depending on operational capacity.

To learn more about enabling Message Suggest, see [Apple's Message Suggest FAQs](#).

Embed Apple Messages for Business buttons

To embed Apple Messages for Business buttons on your website or mobile app, do the following:

1. Add Apple's Messages for Business JS (JavaScript) library to your webpage headers.
2. Add a `div` container to house the button.
3. Customize the banner, fallback support, and button color to meet your brand's needs.

The Messages for Business button must contain the following, at minimum:

- A class attribute to specify the type of container: banner, phone, or message.
- A `data-apple-business-id` attribute with the business ID you received when you registered your company with Messages for Business.

Authentication

Authentication allows customers to sign in to your Identity Provider(s) of choice during a chat conversation. The authentication feature leverages the OAuth2 and OIDC framework to verify the identity of the customer upon successful sign in. For more information, see [Enabling Authentication for Apple Messages for Business](#).

Start a chat from a URL

You can give your customers the ability to start a conversation with you from your website or an email message.

For example, customers may start a chat using a URL that you provide. When they click the URL, the system redirects them to Messages so they can send your business a text message.

You decide how and where to provide the URL. You can include it as a link in an email message, on your website, or use it as the action for a button in your app.

Use the URL **`https://bcrw.apple.com/urn:biz:your-business-id`**, replacing *your-business-id* with the business ID you received from Apple after registering with Messages for Business.

Following are optional query string parameters you can include in the URL:

- `biz-intent-id`: Use to specify the intention, or purpose, of the chat.
- `biz-group-id`: Use to indicate the group, department, or individuals best qualified to handle the customer's specific question or problem.
- `body`: Use to prepopulate the message so the customer only presses **Send** to start the conversation.

Following is an example of what the URL might look like for a customer with a credit card question for the billing department:

- `https://bcrw.apple.com/urn:biz:22222222-dddd-4444-bbbb-777777777777?biz-intent-id=account_question&biz-group-id=billing_department&body=Order%20additional%20credit%20card.`

Add list pickers, time pickers, forms, attachments, and quick replies

A list picker prompts your customer to select an item, such as a product or the reason for their inquiry. A time picker prompts your customer to choose an available time slot, such as to schedule an appointment. A quick reply prompts your customer to select a simple, inline response. Forms allow you to create rich, multiple page, interactive flows for customers.

For information about how to set up list pickers, time pickers, forms, and quick replies, see [Add interactive messages to chat](#).

For information about how to enable attachments, see [Enable attachments to share files using chat](#).

Apple Pay

Apple Pay allows consumers to complete purchases without having to manage paper bills, coins, or physical bank cards. Using Apple Messages for Business, consumers can complete transactions with their favorite brands without having to leave the Messages app.

Apple Pay is a distinct feature, but shares similarities to Apple Pay in-app and Apple Pay on the Web. When a business asks for payment from a customer who is purchasing goods and services through Apple Messages for Business, the customer can use Apple Pay to make the payment.

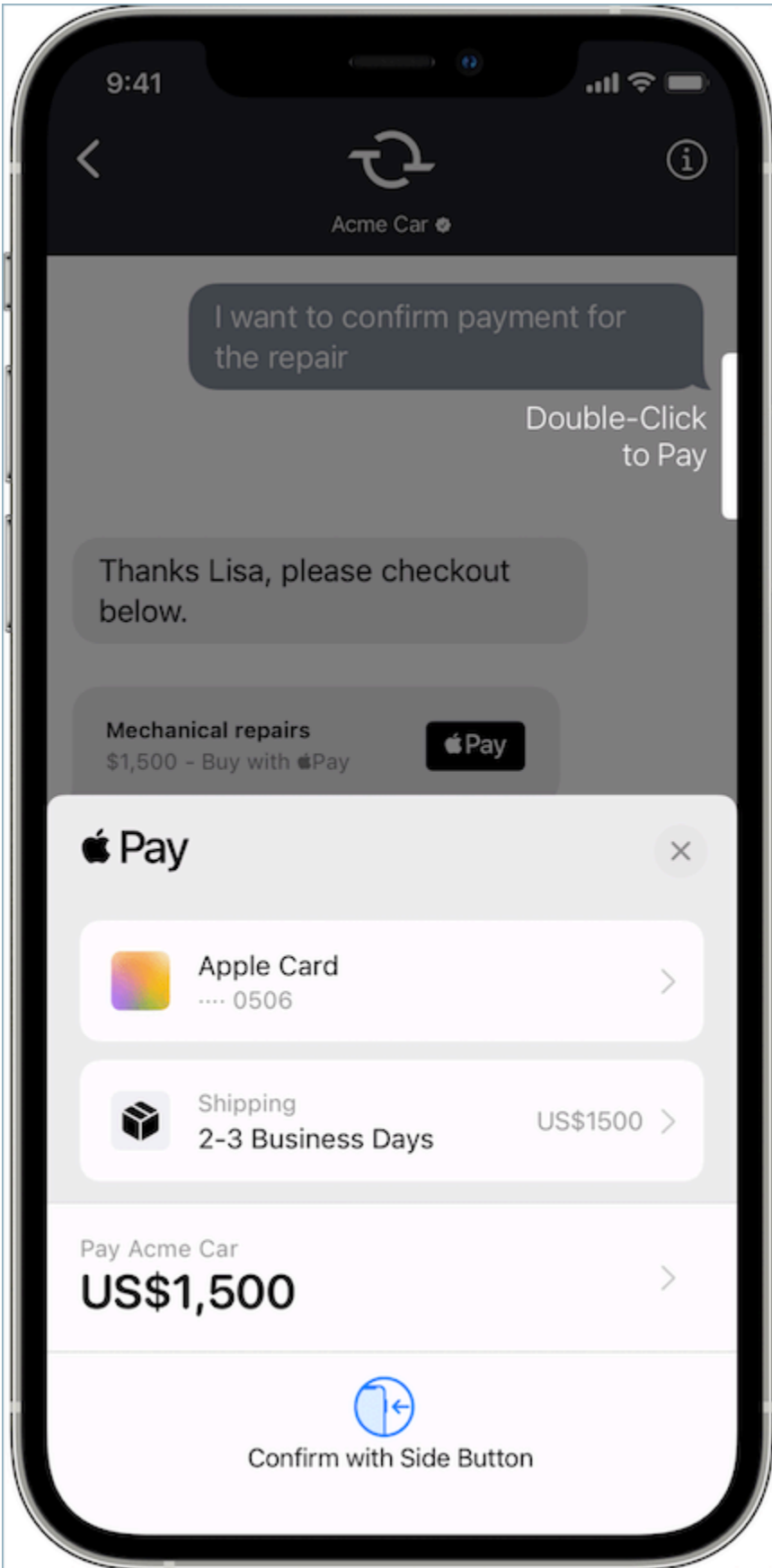

To learn more about Apple Pay, see [Apple Pay for developers](#).

For information about how to set up Apple Pay using Connect, see [Add interactive messages to chat](#).

iMessage Apps

iMessage apps or Apple Custom Interactive Messages (CIM) increase interactivity between end-customers and business customers, allowing end-customers to receive iMessage Apps from businesses. These iMessage Apps contain a richer set of information for end-customers to interact with completely inside of Apple's Messages app, allowing the end-customer to remain in the conversation to perform the same interactions. This makes the Apple CIM more customizable than other existing interactive message types.

The following figure is an example of an iMessage App sent using an Apple CIM with a detailed map and location pin:

Initial Response in Messages for Business

On the user device, you should see the following message bubble.

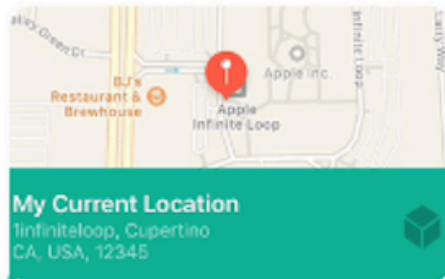

iMessage App

When the user taps the message bubble, a detailed map opens up with a location pin.

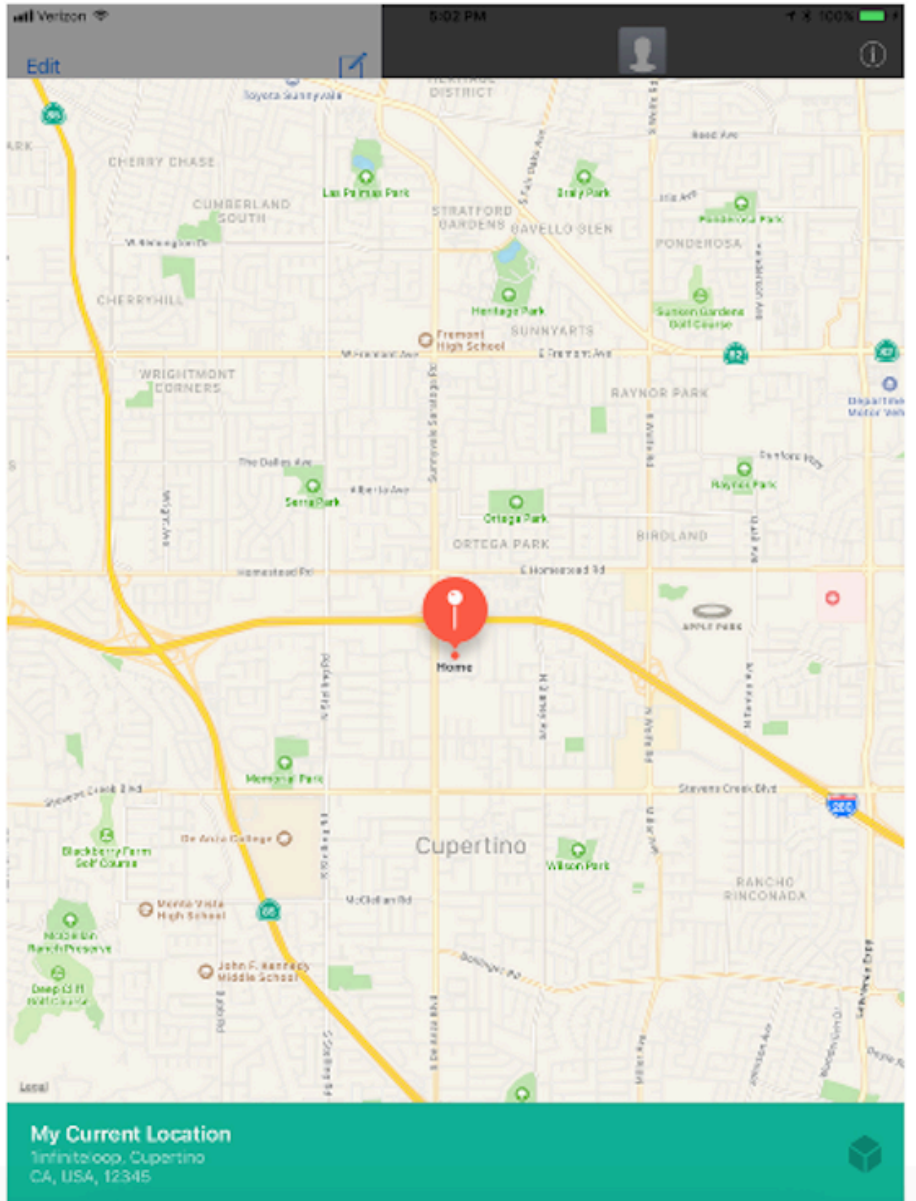

For information about how to set iMessage Apps using Amazon Connect, see [Add interactive messages to chat](#).

Use rich links for URLs

Rich links show an inline preview of a URL that contains an image. Unlike normal URLs, customers can view the image immediately in a chat without choosing a "Tap to Load Preview" message.

Requirements for using rich links in Amazon Connect

To use rich links in Amazon Connect chat messages, your URL and images must meet the following requirements:

- Your website must use Facebook Open Graph tags. For more information, see [A Guide to Sharing for Webmasters](#).
- The image accompanying the URL must be .jpeg, .jpg, or .png.
- The website must be HTML.

Note

When you first use the rich link feature, we recommend that you send the URL in a message separate from your chat text, as shown in the following example. The first message introduces the URL. The next message includes the URL.

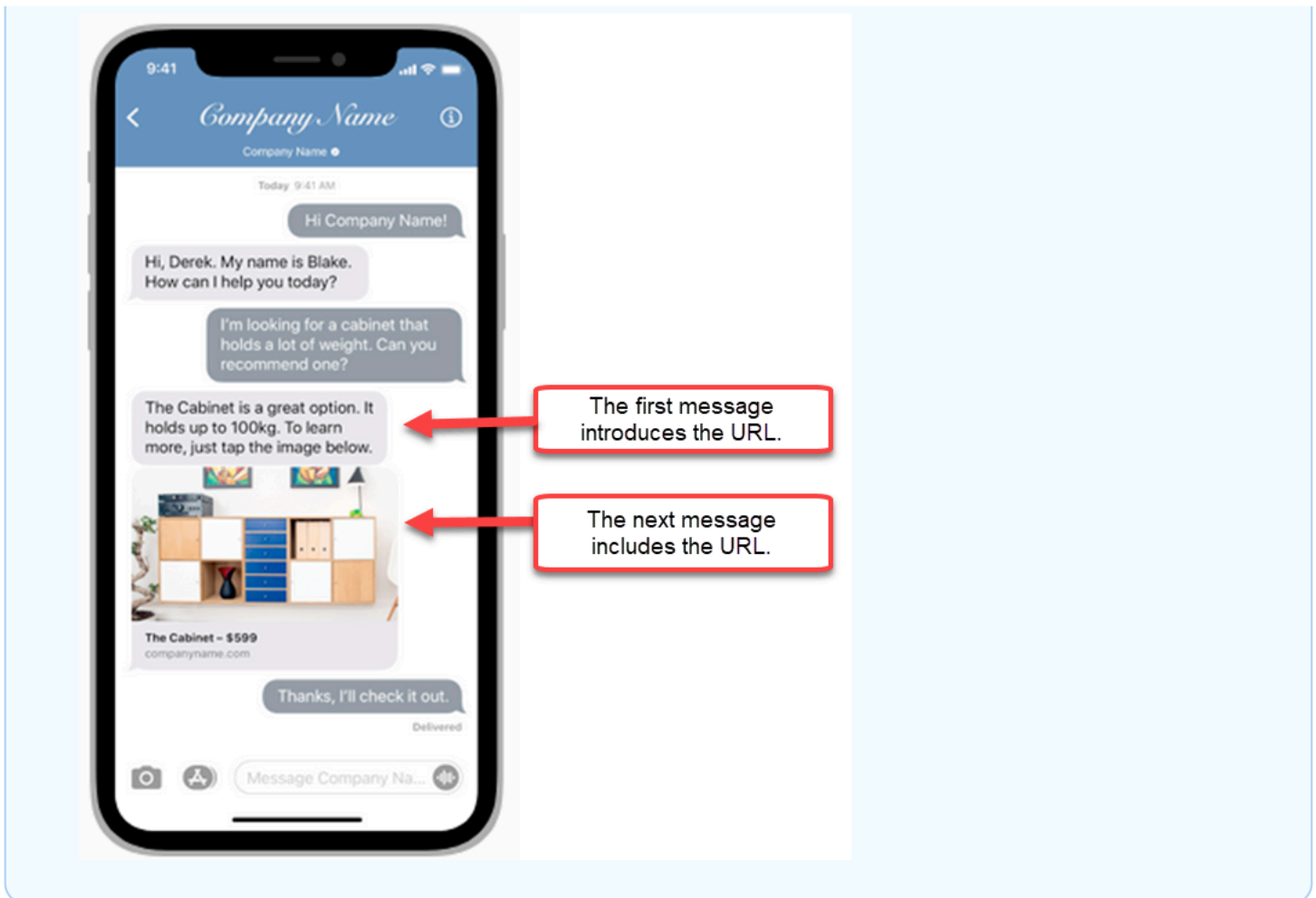

Use Apple Messages for Business contact attributes in contact flows

Contact attributes enable you to store temporary information about the contact so you can use it in the flow.

For example, if you have different lines of business using Apple Messages for Business, you can branch to different flows based on the **AppleBusinessChatGroup** contact attribute. Or, if you want to route Apple Messages for Business messages differently from other chat messages, you can branch based on **MessagingPlatform**.

For more information about contact attributes, see [Use Amazon Connect contact attributes](#).

Use the following contact attributes to route Apple Messages for Business customers.

Attribute	Description	Type	JSON
MessagingPlatform	The messaging platform from where the customer request originated. Exact value: AppleBusinessChat	User-defined	\$.Attributes.MessagingPlatform
AppleBusinessChatCustomerId	The customer's opaque ID provided by Apple. This remains constant for the AppleID and a business. You can use this to identify if the message is from a new customer or a returning customer.	User-defined	\$.Attributes.AppleBusinessChatCustomerId
AppleBusinessChatIntent	You can define the intent or purpose of the chat. This parameter is included in a URL that initiates a chat session in Messages when a customer chooses the Business Chat button.	User-defined	\$.Attributes.AppleBusinessChatIntent
AppleBusinessChatGroup	You define the group which designates the department or individuals best qualified to handle	User-defined	\$.Attributes.AppleBusinessChatGroup

Attribute	Description	Type	JSON
	the customer's particular question or problem. This parameter is included in a URL that initiates a chat session in Messages when a customer chooses the Business Chat button.		
AppleBusinessChatLocale	Defines the language and AWS Region preferences that the user wants to see in their user interface . It consists of a language identifier (ISO 639-1) and a Region identifier (ISO 3166). For example, en_US .	User-defined	\$.Attributes.AppleBusinessChatLocale
AppleFormCapability	<p>Whether the customer device supports forms.</p> <p>If true, the customer device is supported.</p> <p>If false, the device is not supported.</p>	User-defined	\$.Attributes.AppleFormCapability

Attribute	Description	Type	JSON
AppleAuthenticationCapability	Whether the customer device supports Authentication (OAuth2). If true, the customer device is supported. If false, their device is not supported.	User-defined	\$.Attributes.AppleAuthenticationCapability
AppleTimePickerCapability	Whether the customer device supports time pickers. If true, the customer device is supported. If false, the device is not supported.	User-defined	\$.Attributes.AppleTimePickerCapability
AppleListPickerCapability	Whether the customer device supports list pickers. If true, the customer device is supported. If false, the device is not supported.	User-defined	\$.Attributes.AppleListPickerCapability

Attribute	Description	Type	JSON
AppleQuickReplyCapability	Whether the customer device supports quick replies. If true, the customer device is supported. If false, the device is not supported.	User-defined	\$.Attributes.AppleQuickReplyCapability

Update an Apple Messages for Business integration

You will need to update your Apple Messages for Business integration if you want to change the flow ID or other information.

1. Open an [AWS Support ticket](#).

If prompted, login using your AWS account.

2. In the **Use case description** box, copy and paste the following template to indicate this is an **update** request:

Subject: Update Apple Messages for Business Integration request

Body:

Apple Messages for Business Account ID (required): *enter your current account ID* change to *new account ID*

Apple Token (required): *enter your token*

Amazon Connect Instance ARN (required): *enter your current instance ARN* change to *new instance ARN*

Amazon Connect Flow ID (required): *enter your current flow ID* change to *new flow ID*

Note

If you update your Amazon Connect Instance ARN, you must also update your contact flow ID.

- Expand **Contact options**, and then choose your **Preferred contact language**, and then choose **Web** as the contact method, if it's not selected by default.

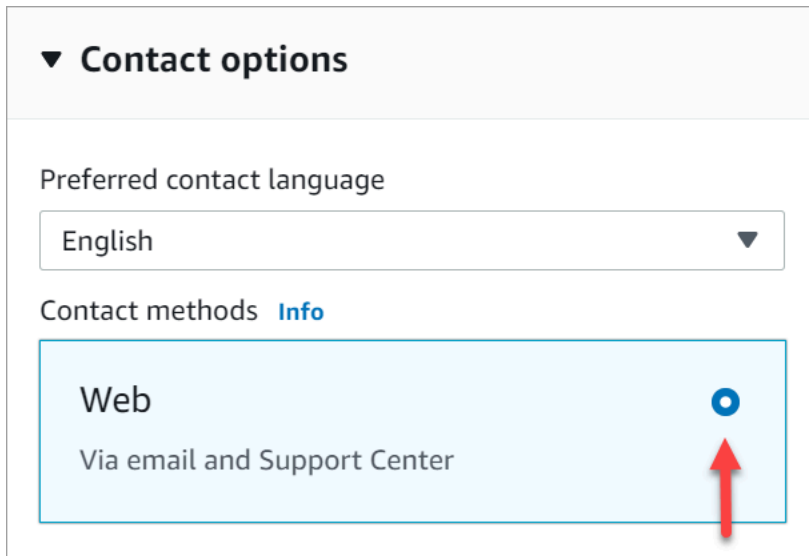

▼ **Contact options**

Preferred contact language

English ▼

Contact methods [Info](#)

Web

Via email and Support Center

- Choose **Submit**.
- AWS Support will work directly with the Amazon Connect team on your request and follow up with any additional questions.

Delete an Apple Messages for Business integration

- Open an [AWS Support ticket](#).

If prompted, log in by using your AWS account.

- In the **Use case description** box, copy and paste the following template to indicate this is an **delete** request:

Subject: Delete Apple Messages for Business Integration

Body:

Apple Messages for Business Account ID (required): *enter your account ID*

Amazon Connect Instance ARN (required): *enter your instance ARN*

Amazon Connect Flow ID (required): *enter your flow ID*

The following image shows an example of a completed ticket:

3. Expand **Contact options**, and then choose your **Preferred contact language**, and then choose **Web** as the contact method, if it's not selected by default.

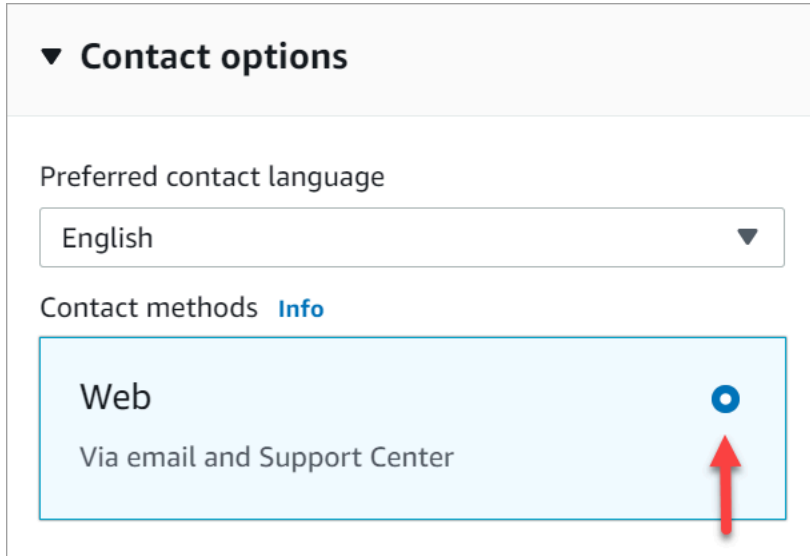

▼ **Contact options**

Preferred contact language

English ▼

Contact methods [Info](#)

Web

Via email and Support Center

4. Choose **Submit**.
5. AWS Support will work directly with the Amazon Connect team on your request and follow up with any additional questions.

Find your Apple Messages for Business Account ID

1. In [Apple Business Register](#), navigate to **Message Service Provider** and click or tap **Test your Messaging Service Provider connection**.

Messaging Service Provider

Messaging Service Provider Configuration

 [Edit](#)



Amazon Connect

[Test your Messaging Service Provider connection >](#)

2. Click or tap **Copy ID**.

Messaging Service Provider Connection

Confirm the message sent from Apple devices arrive at your agent desktop through your Amazon Connect. You can test from either an iPhone or a Mac.

Connect

Your Business Chat Account ID 

 **Copy ID** 

Amazon Connect confirmed your account is connected.

Find your Apple token

- In [Apple Business Register](#) navigate to **Messaging Service Provider** and choose **Copy Token**.

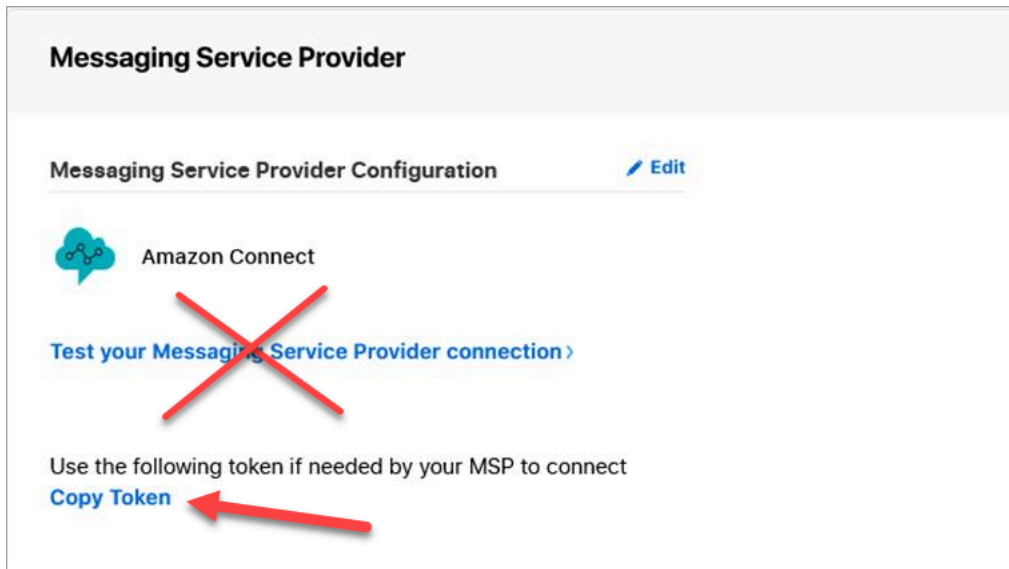

Find the flow ID

The flow ID is the flow you want to use for inbound Apple Messages for Business messages. Flows define the experiences for your customer when they begin a new chat.

You can either reuse an existing flow that you're already using for voice or chat contacts, or create a new one specifically for Apple Messages for Business contacts. For instructions about creating a new inbound flow, see [Create an inbound flow](#).

For more information about flows, see [Create Amazon Connect Flows](#).

To find your flow ID for Apple Messages for Business

1. Log in to the Amazon Connect console with an **Admin** account, or an account assigned to a security profile that has permissions to view contact flows.
2. On the navigation menu, choose **Routing, Contact flows**.
3. Select the flow you want to use.

Note

Only choose flows that are type **Flow (inbound)**. Apple Messages for Business doesn't work with other flow types, such as **Customer queue**, **Customer hold**, **Customer whisper**, etc.

4. In the flow designer, expand **Show additional flow information**.

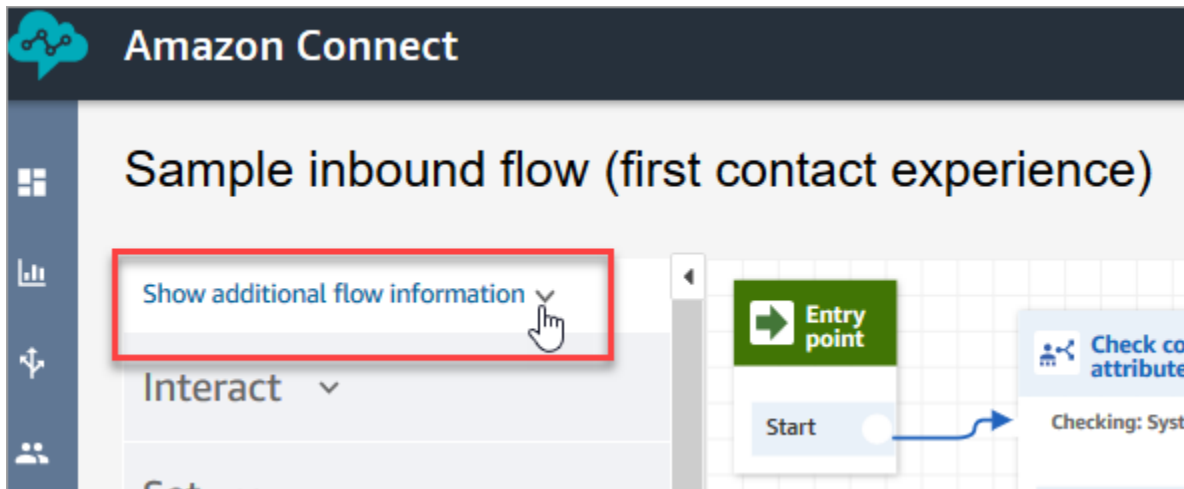

5. Under the ARN (Amazon Resource Number), copy everything after contact-flow/. For example, in the following image, you would copy the underlined part.

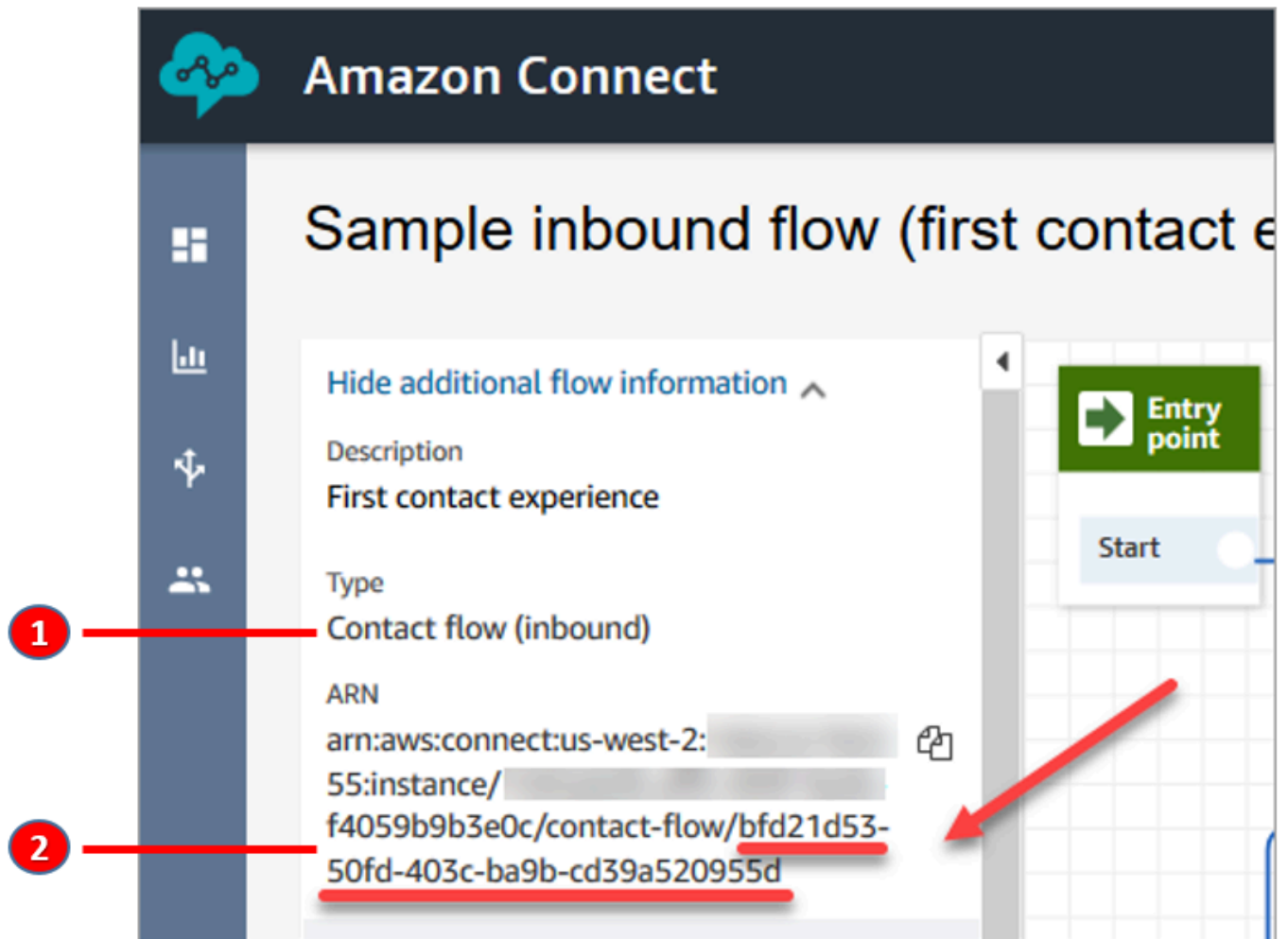

1. Notice the **Type = Flow (Inbound)**.

2. The flow ID is at the end of the ARN. Only copy this end part.

Manage Apple Messages for Business chats

When you integrate Apple Messages for Business with your Amazon Connect instance, messages from Apple Messages for Business behave exactly like any other chat messages arriving to your contact center.

Note

The Amazon Connect Chat service quota limits apply to Apple Messages for Business. To learn more, see [Amazon Connect service quotas](#).

Set up automatic replies

You can use Amazon Lex to set up automatic replies to chat. For a tutorial that introduces you to setting up Amazon Lex and Amazon Connect, see [Add an Amazon Lex bot to Amazon Connect](#).

Enable real-time chat message streaming

Amazon Connect Chat provides [APIs](#) that enable you to subscribe to a real-time stream of chat messages. Using these APIs, you can:

- Stream chat messages in real time when a new chat contact is created.
- Extend the current Amazon Connect Chat functionality to support use cases like building integrations with SMS solutions and third-party messaging applications, enabling mobile push notifications, and creating analytics dashboards to monitor and track chat message activity.

How the message streaming APIs work

The [Amazon Connect message streaming APIs](#) are triggered when certain events occur within an Amazon Connect Chat contact. For example, when a customer sends a new chat message, the event sends a [payload](#) to a specified endpoint containing data about the message that was just sent. Messages are published using [Amazon Simple Notification Service](#) (Amazon SNS) to a specific endpoint.

This topic describes how to set up real-time message streaming using Amazon Connect and Amazon SNS. The steps are:

1. Use the Amazon SNS console to create a new standard SNS topic and set up the messages.
2. Call the [StartChatContact](#) API to initiate the chat contact.
3. Call the [StartContactStreaming](#) API to initiate message streaming.
4. Call the [CreateParticipantConnection](#) API to create the participant's connection.

Step 1: Create a standard SNS topic

1. Go to the Amazon SNS console.
2. [Create a SNS topic](#) in your AWS account. In the **Details** section, for **Type**, choose **Standard**, enter a name for the topic, and then choose **Create topic**.

Note

Currently, the message streaming APIs only support standard SNS for real-time streaming of messages. They don't support [Amazon SNS FIFO \(first in, first out\) topics](#).

3. After you create the topic, its Amazon Resource Name (ARN) is displayed in the **Details** section. Copy the topic ARN to the clipboard. You'll use the topic ARN in the next step, and in [Step 3: Enable message streaming on the contact](#).

The topic ARN looks similar to the following example:

```
arn:aws:sns:us-east-1:123456789012:MyTopic
```

4. Choose the **Access policy** tab, choose **Edit**, and then add a resource-based policy on the SNS topic so that Amazon Connect has permission to publish to it. Following is a sample SNS policy that you can copy and paste into the JSON editor, and then customize with your values:

```
{
  "Version": "2012-10-17",
  "Statement": [
    {
      "Effect": "Allow",
      "Principal": {
```

```

    "Service": "connect.amazonaws.com"
  },
  "Action": "sns:Publish",
  "Resource": "YOUR_SNS_TOPIC_ARN",
  "Condition": {
    "StringEquals": {
      "aws:SourceAccount": "YOUR_AWS_ACCOUNT_ID"
    },
    "ArnEquals": {
      "aws:SourceArn": "YOUR_CONNECT_INSTANCE_ARN"
    }
  }
}
]
}

```

Note

The default **Access policy** comes with conditions applied to `sourceOwner` such as:

```

"Condition": {
  "StringEquals": {
    "AWS:SourceOwner": "921772911154"
  }
}

```

Make sure you remove it and replace with `SourceAccount`, for example:

```

"Condition": {
  "StringEquals": {
    "aws:SourceAccount": "YOUR_AWS_ACCOUNT_ID"
  },
  "ArnEquals": {
    "aws:SourceArn": "YOUR_CONNECT_INSTANCE_ARN"
  }
}

```

This prevents a [cross-service confused deputy](#) issue.

5. If you're using server-side encryption on SNS, verify you have `connect.amazonaws.com` permission enabled on the KMS key. Following is a sample policy:

```
{
  "Version": "2012-10-17",
  "Id": "key-consolepolicy-3",
  "Statement": [
    {
      "Sid": "Enable IAM User Permissions",
      "Effect": "Allow",
      "Principal": {
        "AWS": "arn:aws:iam::your_accountId:root",
        "Service": "connect.amazonaws.com"
      },
      "Action": "kms:*",
      "Resource": "*"
    },
    {
      "Sid": "Allow access for Key Administrators",
      "Effect": "Allow",
      "Principal": {
        "AWS": "arn:aws:iam::your_accountId:root",
        "Service": "connect.amazonaws.com"
      },
      "Action": [
        "kms:Create*",
        "kms:Describe*",
        "kms:Enable*",
        "kms:List*",
        "kms:Put*",
        "kms:Update*",
        "kms:Revoke*",
        "kms:Disable*",
        "kms:Get*",
        "kms>Delete*",
        "kms:TagResource",
        "kms:UntagResource",
        "kms:ScheduleKeyDeletion",
        "kms:CancelKeyDeletion"
      ],
      "Resource": "*"
    }
  ]
}
```

Step 2: Initiate the chat contact

1. Call the Amazon Connect [StartChatContact](#) API to initiate the chat contact.

For information about how to create the SDK client for calling Amazon Connect APIs, see the following topics:

- [Class AmazonConnectClientBuilder](#)
 - [Creating Service Clients](#)
2. Keep track of `ContactId` and `ParticipantToken` from the [StartChatContact](#) response since these response attributes are used for calling other chat APIs required to enable streaming. This is described in the next steps.

Step 3: Enable message streaming on the contact

- Call [StartContactStreaming](#) to enable real-time message streaming to your SNS topic.
 - **Limits:** You can subscribe to up to two SNS topics per contact.
 - When you call [StartContactStreaming](#), you'll need to provide the Amazon Resource Name (ARN) of the SNS topic (see [Step 1: Create a standard SNS topic](#)).

A single SNS topic ARN may be used across multiple AWS accounts, but it must be in the same Region as your Amazon Connect instance. For example, if your topic ARN is in **us-east-1**, your Amazon Connect instance must be in **us-east-1**.

- For initial chat messages that aren't received on the streaming endpoint, you can call the [GetTranscript](#) API to receive the initial messages.

Step 4: Create the participant connection

- Call [CreateParticipantConnection](#) with the `ConnectParticipant` attribute passed as true.
 - You must call [CreateParticipantConnection](#) within five minutes of creating the chat.
 - Calling [CreateParticipantConnection](#) with `ConnectParticipant` set to true only works if you enabled streaming in [Step 2: Initiate the chat contact](#) and caller participant is `Customer`.
 - This step (creating the participant connection) is optional if you have already successfully connected to the chat contact using WEBSOCKET.

Next steps

You are all set for working with the message streaming APIs.

1. To verify it is working, check that messages are published to the SNS topic you created. You can do this using Amazon CloudWatch metrics. For instructions, see [Monitoring Amazon SNS topics using CloudWatch](#).
2. Because SNS has [limited retention](#), we recommend that you set up [Amazon Simple Queue Service \(Amazon SQS\)](#) [Amazon Kinesis](#), or another service to retain messages.
3. Using [StopContactStreaming](#) is optional and not required if the chats are being [disconnected](#) through a contact flow, or if the customer disconnects the chat. However, [StopContactStreaming](#) provides the option to stop the message streaming on the SNS topic, even if the chat is active and ongoing.

Amazon SNS payload used in message streaming

After you've enabled message streaming successfully, you may need to filter the message to send it to the intended participant: agent, customer, or all.

To filter by participant, read the specific SNS headers attribute— `MessageVisibility`—to determine whether the message is intended for customer-only, agent-only, or all.

- To send to the customer only: For all code that faces the customer, clients need to filter out messages intended for the customer and build the following logic for forwarding the message to them.

```
if ( ( MessageVisibility == CUSTOMER || MessageVisibility == ALL ) &&
    ParticipantRole != CUSTOMER )
```

- To send to the agent only:

```
if ( ( MessageVisibility == AGENT || MessageVisibility == ALL ) && ParticipantRole !=
    AGENT )
```

You can also leverage the filtering capability in Amazon SNS by building custom [subscription filtering policies](#). This offloads the message filtering logic from the SNS topic subscriber to the SNS service itself.

Message attributes in the payload

Following is a description of each message attribute in the Amazon SNS payload:

- **InitialContactId**: The initial contact ID of the chat.
- **ContactId**: The current contact ID of the chat. The **InitialContactId** and **ContactId** can differ if there has been new agent in the chat or the queue-to-queue contact flow.
- **ParticipantRole**: The participant who sent the message.
- **InstanceId**: The Amazon Connect instance ID.
- **AccountId**: The AWS account ID.
- **Type**: Possible values: EVENT, MESSAGE.
- **ContentType**: Possible values: `application/vnd.amazonaws.connect.event.typing`, `application/vnd.amazonaws.connect.event.participant.joined`, `application/vnd.amazonaws.connect.event.participant.left`, `application/vnd.amazonaws.connect.event.transfer.succeeded`, `application/vnd.amazonaws.connect.event.transfer.failed`, `application/vnd.amazonaws.connect.message.interactive`, `application/vnd.amazonaws.connect.event.chat.ended`, and more.
- **MessageVisibility**: Possible values: AGENT, CUSTOMER, ALL.

Example SNS payload

```
{
  "Type" : "Notification",
  "MessageId" : "ccccccccc-cccc-cccc-cccc-cccccccccccc",
  "TopicArn" : "arn:aws:sns:us-west-2:009969138378:connector-svc-test",
  "Message" : "{\"AbsoluteTime\":\"2021-09-08T13:28:24.656Z\",\"Content\":\"help \",\"ContentType\":\"text/plain\", \"Id\":\"33333333-be0d-4a44-889d-d2a86fc06f0c \",\"Type\":\"MESSAGE\", \"ParticipantId\":\"bbbbbbbbb-c562-4d95-b76c-dcbca8b4b5f7\", \"DisplayName\":\"Jane\", \"ParticipantRole\":\"CUSTOMER\", \"InitialContactId\":\"33333333-abc5-46db-9ad5-d772559ab556\", \"ContactId\":\"33333333-abc5-46db-9ad5-d772559ab556\"}",
  "Timestamp" : "2021-09-08T13:28:24.860Z",
  "SignatureVersion" : "1",
  "Signature" : "examplegggggg/1tEBYdiVDgJgBoJUniUFcArLFGfg5JCvp0r/v6LPChID7A0BWy8+Z0nGTm0jBMn80U9jSzYhKbHDbQHANyT09sRyQA31JtHHiIseQeMfTDpcaAXqfs8hdIXq4XZaJYqDFqo+tl+kk85syW/2ryjjkDYoUb+dyRGkqMy4aKA22Upfid0tdAZ/GGtXaXSKBqazZTEUuSEzt0duLtFntQiYJanU05gtDig==",
}
```

Issue not resolved?

If after trying the previous solutions you still have issues with message streaming, contact AWS Support for help.

Amazon Connect administrators can choose one of the following options to contact support:

- If you have an AWS Support account, go to [Support Center](#) and submit a ticket.
- Otherwise, open the [AWS Management Console](#) and choose **Amazon Connect, Support, Create case**.

It is helpful to provide the following information:

- Your contact center instance ID/ARN. To find your instance ARN, see [Find your Amazon Connect instance ID/ARN](#).
- Your Region.
- A detailed description of the issue.

Customize chat flow experiences by integrating custom participants

You can integrate other solutions, such as bots, with Amazon Connect chat to create customized chat flow experiences.

Following is an overview of how you can customize your chat flow experience. Implement these steps for each chat segment after the chat conversation is started. We recommend adding an [Invoke AWS Lambda function](#) block to call the APIs in your chat flow.

Important

Add a [Play prompt](#) block before a [Invoke AWS Lambda function](#) block. This is required only when an **Invoke AWS Lambda** block is the first block in your inbound chat flow.

1. [Enable real-time streaming of chat messages](#).
2. Call the Amazon Connect [CreateParticipant](#) API to add a custom participant (ParticipantRole = CUSTOM_BOT) to the chat contact.

- a. For information about how to create the SDK client for calling Amazon Connect APIs, see the following topics:
 - [Class AmazonConnectClientBuilder](#)
 - [Creating Service Clients](#)
- b. Keep the ParticipantToken that is obtained from [CreateParticipant](#) to call [CreateParticipantConnection](#). CreateParticipantConnection returns a ConnectionToken, which you can use to call other Amazon Connect Participant APIs.

When calling [CreateParticipantConnection](#) to create a connection for a custom participant:

- Set ConnectParticipant to True to mark the custom participant as connected for message streaming.
 - Pass Type as CONNECTION_CREDENTIALS to call the subsequent Amazon Connect Participant Service APIs.
 - CreateParticipantConnection should be called within 15 seconds of calling CreateParticipant.
3. After the participant is added to the contact, they can exchange messages with the customer by using Amazon Connect Participant Service APIs.
 4. To disconnect the participant, call the [DisconnectParticipant](#) API.

 **Note**

- A custom participant cannot be added to a chat when an agent or Amazon Lex bot is already present on the contact.
- A custom participant will be disconnected when an agent or Amazon Lex bot joins a contact.
- Only one custom participant can be present on a contact.

We recommend configuring how long a custom participant can chat with a contact:

- Set the **Timeout** property on the [Wait](#) block for the ParticipantRole = CUSTOM_BOT.

- If the custom bot participant is not disconnected before the timeout, then the contact is routed down the **Time Expired** branch. This allows you to decide which block to run next to resolve the customer's query.

Note

If a contact is routed down the **Time Expired** branch, they are not disconnected from the contact. You must call the [DisconnectParticipant](#) API to disconnect the participant.

Activate timers for customers who are joined to a custom participant

You can activate timers on customers who are joined to custom participants, such as custom bots. This enables you to detect when a customer stops responding so you can then terminate that bot conversation, and perform the next step in the flow. By terminating idle participants, you can reduce the number of open chats where there is a non-responsive customer engaged with a custom participant.

Perform the following steps to integrate an Idle Participant Custom Bot Extension and optionally set custom timer values. These steps assume that the you already use the custom participant feature for chat.

1. Before the custom participant joins the chat, invoke the [UpdateParticipantRoleConfig](#) API for the customer.
 - a. Timers activate only for the customer. Custom participants do not have idle participant or auto-disconnect timers.
 - b. You can choose the method for invoking the API.
 - c. Timer values configured in this step persist for the life of the chat. If you want different timer values for the **customer and agent interaction**, see Step 2.
 - d. If your client is already set up this way, you don't need to take any other action to integrate your custom participant.
2. (Optional) To configure timers and timer values that are different during the **customer and agent interaction** than during the **customer and custom participant interaction**:
 - Before the agent joins the chat, invoke the [UpdateParticipantRoleConfig](#) API again with the configurations you want.

For more information about chat timers, see [Set up chat timeouts for chat participants](#).

Starting timers

A timer begins for the customer after the custom participant establishes a connection to them using the [CreateParticipantConnection](#) API.

What happens when non-compatible participants join a chat with a custom participant

Following is what happens when an agent or Lex bot participant joins a chat with a custom participant, and they are non-compatible participants:

1. The custom participant is automatically disconnected from the chat.
2. All previously active timers are terminated and new timers are created for the connected participants (if timers are configured).
3. Each new timer is also updated with the latest configuration (if needed). This effectively establishes a new "Idle session" for the new set of active participants on the chat.

Interaction with the Wait block timer

The idle timer does not impact how the [Wait](#) block works.

The **Wait** block timer that starts when the chat contact enters a **Wait** block continues to work. If the **Wait** block timer expires, the contact resumes the flow and is routed down the **Time Expired** branch, regardless of whether any idle participant timers are active.

Troubleshooting tip

If you get a `ResourceNotFoundException` for the custom participant when calling the `CreateParticipantConnection` API, check whether the `CreateParticipantConnection` API was called within 15 seconds of `CreateParticipant` API.

Set up SMS messaging

You can enable SMS messaging on Amazon Connect so your customers can text you from their mobile device. With Amazon Lex, you can automate responses to their questions, saving agents valuable time and effort.

This topic explains how to set up and test SMS messaging for Amazon Connect. You use Amazon Pinpoint SMS to procure an SMS-enabled phone number, enable two-way SMS on the number, and then import it into Amazon Connect.

Contents

- [Step 1: Request a number in Amazon Pinpoint SMS](#)
- [Step 2: Enable two-way SMS on the phone number](#)
- [Step 3: Update flows to branch on SMS contacts](#)
- [Step 4: Test sending and receiving SMS messages](#)
- [Next steps](#)

Step 1: Request a number in Amazon Pinpoint SMS

Important

Some countries require phone numbers and sender IDs to be registered for use in the country. It can take up to 15 business days to process a registration request after it is submitted. We strongly recommend you begin this process early. For more information about registering, see [Registrations](#).

We also strongly recommend reviewing [Best practices for requesting SMS numbers](#) before requesting a number.

For instructions for using the CLI to perform this step, see [Request a phone number](#) in the *Amazon Pinpoint SMS User Guide*.

1. Open the AWS SMS console at <https://console.aws.amazon.com/sms-voice/>.
2. In the navigation pane, under **Configurations**, choose **Phone numbers** and then **Request originator**.
3. On the **Select country** page you must choose the **Message destination country** from the drop down that messages will be sent to. Choose **Next**.
4. On the **Messaging use case** section, enter the following:
 - Under **Number capabilities** choose either **SMS** or **Voice**, depending on your requirements.

⚠ Important

Capabilities for SMS and Voice can't be changed after the phone number has been purchased.

- **SMS** – Choose if you need SMS capabilities.
 - **Voice (text to audio)** – Choose if you need voice capabilities.
 - Under **Estimated monthly SMS message volume per month – optional** choose the estimated number of SMS messages you will send each month.
 - For **Company headquarters - optional** choose either of the following:
 - **Local** – Choose this if your company headquarters is in the same country as your customers who will receive SMS messages. For example, you would choose this option if your headquarters is in the United States and your users who will receive messages are also in the United States.
 - **International** – Choose this if your company headquarters is not in the same country as your customers who will receive SMS messages.
 - For **Two-way messaging** choose **Yes** if you require two-way messaging.
5. Choose **Next**.
6. Under **Select originator type** choose one of the recommended phone number type or one of the available number types. The available options are based on the use case information you filled out in the previous steps.
- If you choose 10DLC and already have a registered campaign, you can choose the campaign from the **Associate to registered campaign**.
 - If the number type you want isn't available, you can choose **Previous** to go back and modify your use case. Also check the [Supported countries and regions \(SMS channel\)](#) to make sure the originator type you want is supported in the destination country.
 - If you want to request a short code or long code, you need to open a case with AWS Support. For more information, see [Requesting short codes for SMS messaging with Amazon Pinpoint SMS](#) and [Requesting dedicated long codes for SMS messaging with Amazon Pinpoint SMS](#).
7. Choose **Next**.

8. On **Review and request** you can verify and edit your request before submitting it. Choose **Request**.
9. A **Registration Required** window may appear depending on the type of phone number you requested. Your phone number or sender ID is associated with this registration and can't send messages until your registration has been approved. For more information about registrations requirements, see [Registrations](#).
 - a. For **Registration form name** enter a friendly name.
 - b. Choose **Begin registration** to finish registering the phone number or **Register later**.

 **Important**

Your phone number or sender ID can't send messages until your registration has been approved.
You are still billed the recurring monthly lease fee for the phone number regardless of registration status.

Step 2: Enable two-way SMS on the phone number

After you have successfully procured a phone number from Amazon Pinpoint SMS, you enable two-way SMS on the phone number with Amazon Connect as the message destination. You can enable two-way SMS messaging for individual phone numbers. When one of your customers sends a message to your phone number, the message body is sent to Amazon Connect.

For instructions for using the CLI to perform this step, see [Two-way SMS messaging](#) in the *Amazon Pinpoint SMS User Guide*.

 **Note**

Amazon Connect for two-way SMS is available in the AWS Regions listed in [Chat messaging: SMS subtype](#).

1. Open the AWS SMS console at <https://console.aws.amazon.com/sms-voice/>.
2. In the navigation pane, under **Configurations**, choose **Phone numbers**.
3. On the **Phone numbers** page choose a phone number.

4. On the **Two-way SMS** tab choose the **Edit settings** button.
5. On the **Edit settings** page choose **Enable two-way message**, as shown in following image.

Pinpoint SMS > Phone numbers > + [redacted] > Edit settings

Edit settings

Two-way SMS [Info](#)

Enable two-way message
Enabling two-way SMS allows you to receive incoming text messages from your end recipients.

Destination type [Info](#)
Select a destination type below to receive incoming messages.

Amazon SNS Amazon Connect

Two-way channel role [Info](#)
Choose if you would like to create a new IAM Role or select an existing Role.

Choose existing IAM role
Allows you to choose a role already existing in your account.

Existing IAM roles [Info](#)
Choose the IAM role to use to send messages to the two-way destination.

[Empty dropdown menu] [Refresh icon]

6. For **Destination type** choose **Amazon Connect**.
7. For Amazon Connect in **Two-way channel role** choose **Choose existing IAM roles**.
8. In the **Existing IAM roles** drop down choose an existing IAM role as the message destination. For example IAM policies, see [IAM policies for Amazon Connect](#) in the *Amazon Pinpoint SMS User Guide*.

Tip

If you can't create a policy or role, double-check that your Amazon Connect instance is in a [Region supported by Amazon Connect SMS](#).

9. Choose **Save changes**.
10. In the **Import Phone Number to Amazon Connect** window:
 - a. For the **Incoming messages destination** drop down choose the Amazon Connect instance that will receive incoming messages.

b. Choose **Import Phone Number**.

11. After the number is successfully imported to Amazon Connect, you can view it in the Amazon Connect admin website: In the left navigation, choose **Channels, Phone numbers**. The SMS number appears on the **Phone numbers** page, as shown in the following image.

Phone Number	Description	Phone Type	Active Channels
[blurred]	SMS number	Toll free	SMS

Step 3: Update flows to branch on SMS contacts

If you have existing flows that you want to branch when a contact uses SMS, add a [Check contact attributes](#) block to your flows. This block enables you to send SMS contacts to a specific queue, or take another action.

1. Add a [Check contact attributes](#) block to your flow, and open the **Properties** page.
2. In **Attribute to check** section, set **Namespace** to **Segment attributes** and **key** to **Subtype**.

For more information about Segment attributes, see [SegmentAttributes](#) in the *ContactTraceRecord* topic.

- In the **Conditions to check** section, set **condition** to **Equals** and **value** to **connect:SMS**.

The following image of a **Properties** page shows it's configured to branch when the contact comes in on the SMS channel.

Block Type ✕
 Check contact attributes

Block Name
 Enter a block name
Check if SMS
 12 / 50

Branches based on a comparison to the value of a contact attribute. [Learn more](#)

Attribute to check

Namespace
 Segment attributes

Key
 Subtype

Conditions to check

condition
 Equals

value
 connect:SMS

[Add another condition](#)
 No Match

- Associate the SMS phone number with the flow: In the left navigation, choose **Channels**, **Phone numbers**, choose the SMS number, and then choose **Edit**.

Phone numbers
 Manage and claim phone numbers to use for voice and SMS communications. [Info](#)

Search by phone number Release Claim a number

Phone Number	Description	Phone Type	Active Channels	Contact flow/IVR	Country
[Redacted]	SMS number	Toll free	SMS	Sample queue customer	US

Rows per page: 25 1 - 1 < >

[View historical changes](#)

- Under **Flow/IVR**, choose the flow you updated, and then choose **Save**.

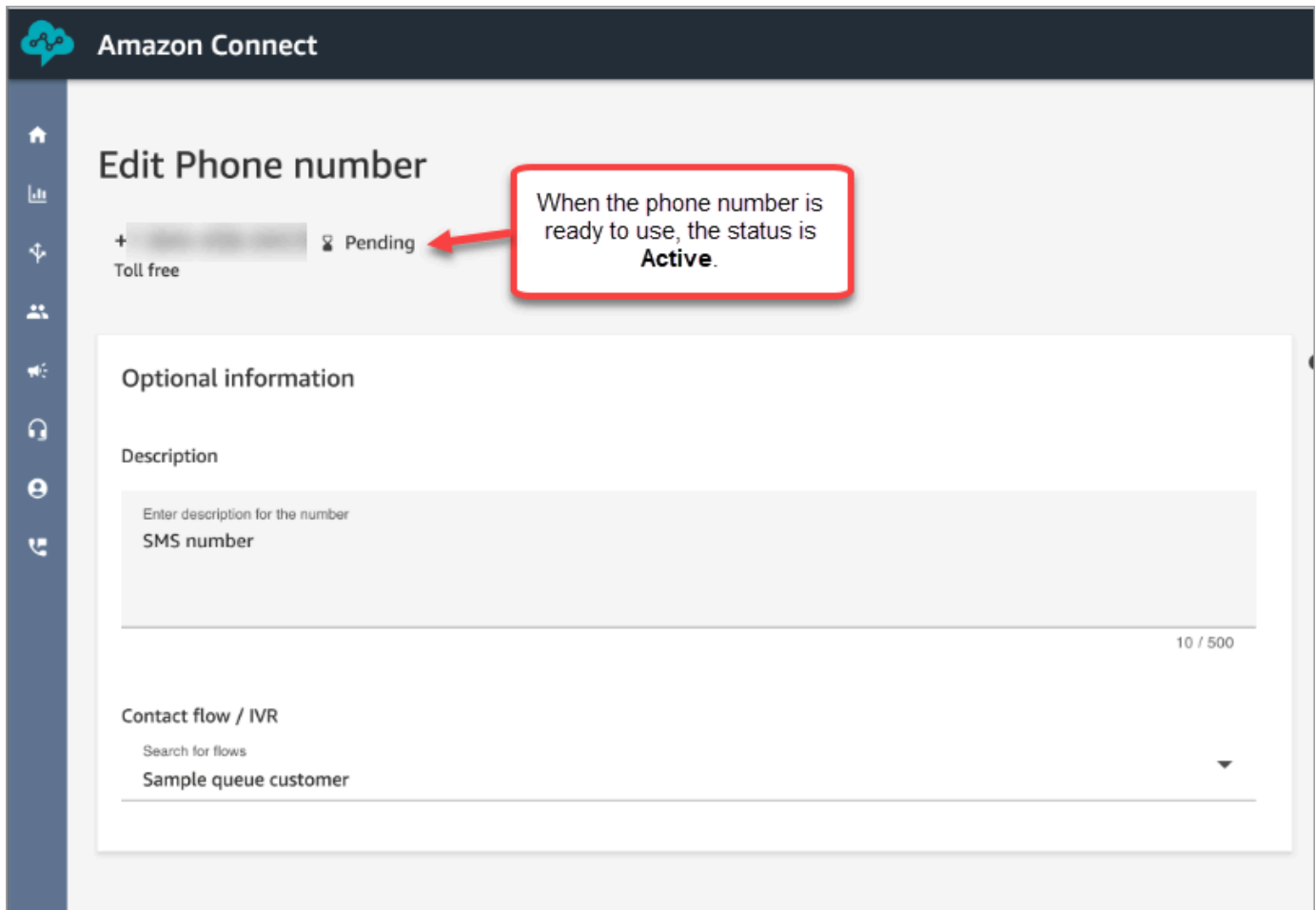

Tip

When you first purchase a phone number, the phone number's status is **Pending**. When the phone number is ready to use, the phone number's status is **Active**. If the phone number requires [registration](#), then you must complete that step before the phone number's status changes to **Active**.

Step 4: Test sending and receiving SMS messages

In this step you use the Contact Control Panel (CCP) and a mobile phone to test sending and receiving SMS messages.

1. In your CCP, set your status to **Available**.

2. Using a mobile device, send an SMS to the phone number that you requested in [Step 1: Request a number in Amazon Pinpoint SMS](#).

Tip

If your Amazon Pinpoint SMS phone number is still in the SMS sandbox, you can only test sending and receiving SMS messages with verified destination numbers that you have configured. For move instructions, see [Moving from the SMS sandbox to production](#).

Customer's mobile device

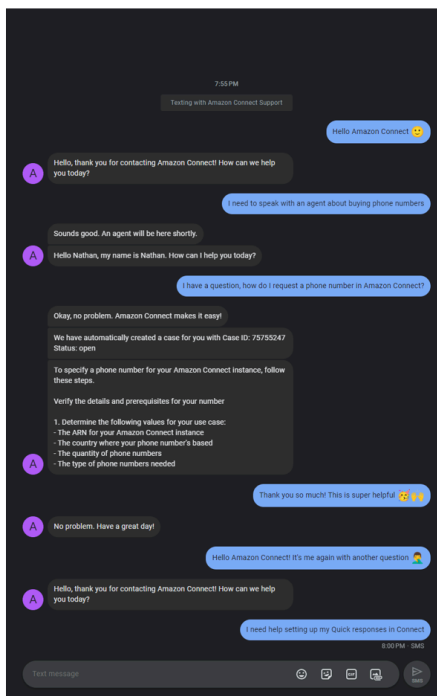

Agent workspace

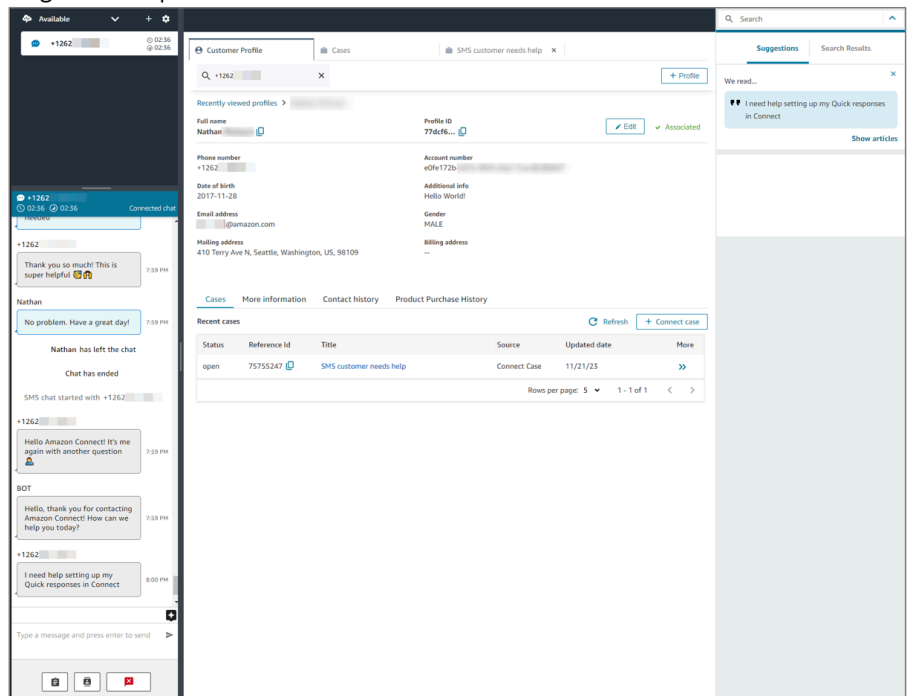

Next steps

We recommend the following steps to provide the best experience for your agents and customers.

- [Enable persistent chat](#): Customers can resume previous conversations with the context, metadata, and transcripts carried forward. They don't need to repeat themselves when they return to a chat, and agents have access to the entire conversation history.

- [Create quick responses for use with chat contacts](#): Provide agents with pre-written responses to common customer inquiries that they can use while they chat with customers. Quick responses make it faster for agents to respond to customers.

Upgrade to the latest CCP

The URL for the latest Contact Control Panel (CCP) ends with **ccp-v2**

You only need to upgrade to the latest CCP if you're using one the following options:

- [The URL for your CCP ends with /ccp#](#)
- [You use the Amazon Connect Streams API](#). The URL associated with `initCCP()` ends with **/ccp#**

If you're still unsure whether you're using the latest CCP, go to [Compare the earlier and latest CCP](#) to see if your CCP looks like the latest one.

Upgrade on your own schedule, before your automatic upgrade date

To upgrade to the latest CCP before your automatic upgrade date, use the steps in the following sections:

- [My CCP URL ends with /ccp#](#)
- [I use the Amazon Connect Streams API](#)

Upgrade later, automatically

If you don't want to upgrade now, you can choose to wait until your scheduled upgrade date.

Between now and your scheduled upgrade date, we recommend the following change management steps:

- Compare how the upgraded CCP differs from the earlier one. For side-by-side visuals, see [Compare the earlier and latest CCP](#).
- Upgrade your CCP in a test environment. Use the latest CCP to learn how it's different, and to check your configurations.
- Communicate to your agents when the upgrade is going to take place.

- Train your agents to help them get ready.

You can see communications about your auto-upgrade date in the Personal Health Dashboard.

My CCP URL ends with /ccp#

Upgrading to the latest CCP is easy. If you want, you can try out the latest CCP and then at a later date make the switch. Here's what you do:

1. **Try it out:** Change the URL in your browser from **/ccp#** to **/ccp-v2**. The latest CCP appears automatically. If you want, change it back to **/ccp#** to return to the earlier CCP.
2. **Upgrade:** Change the URL in your browser from **/ccp#** to **/ccp-v2**. Bookmark the URL.
3. If you access the CCP through the Amazon Connect console by choosing the phone icon on the top right of a page, you will be re-directed according to the automatic upgrade date sent by email. Please reach out to your Amazon Solution Architect if your request is more urgent.

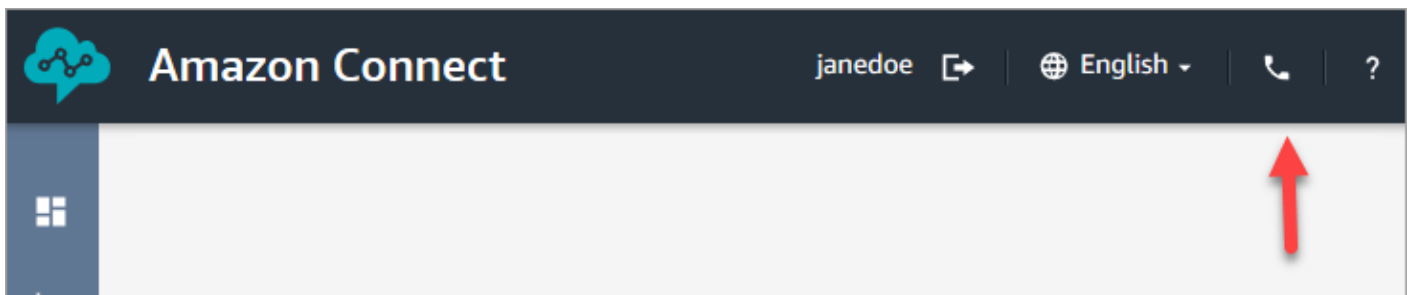

4. After the upgrade happens, if you use the **/ccp#** URL, it resolves to **/ccp-v2**.

Verify your network settings

We highly recommend setting up your network to use [Option 1 \(recommended\): Replace Amazon EC2 and CloudFront IP range requirements with a domain allowlist](#).

Using this option helps Amazon Connect Support to quickly troubleshoot any issues you have. Specifically, using ***.telemetry.connect.{region}.amazonaws.com** passes more metrics to our Support team to help with troubleshooting.

Update your SAML URL to ccp-v2

If you use SAML 2.0 as your identity management system, be sure to update the destination in your relay state URL to **ccp-v2**.

Change `destination=/connect/ccp` to `destination=/connect/ccp-v2`.

For more information, see [Use a destination in your relay state URL](#)

Compare the earlier and latest CCP

The images in this section show you how the latest CCP differs from the earlier CCP for common tasks that agents perform. The images show both CCP versions in their default state.

Tip

The chat tab appears on an agent's CCP only if their routing profile includes chat.

Set status, use chat, access quick connects and number pad

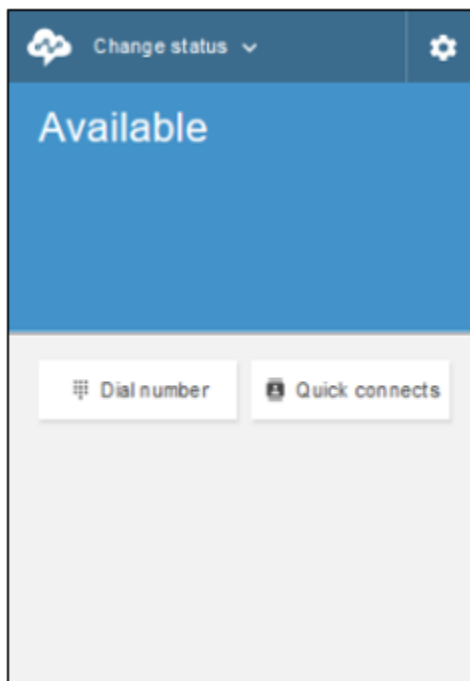

Earlier CCP

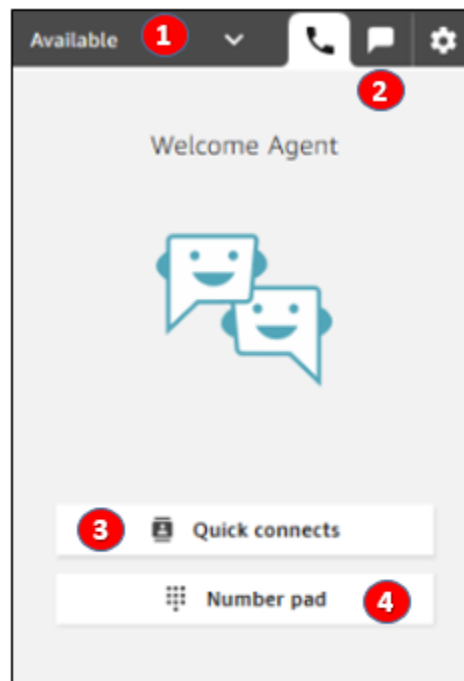

Latest CCP

1. Agents use a dropdown to set their status.
2. If you have enabled chat for the agent's routing profile, the chat tab appears.
3. Choose the **Quick connects** button to type and call a phone number, or select a quick connect.
4. Choose the **Number pad** button to type and call a phone number. This is useful when the phone number has letters.

Receive a call

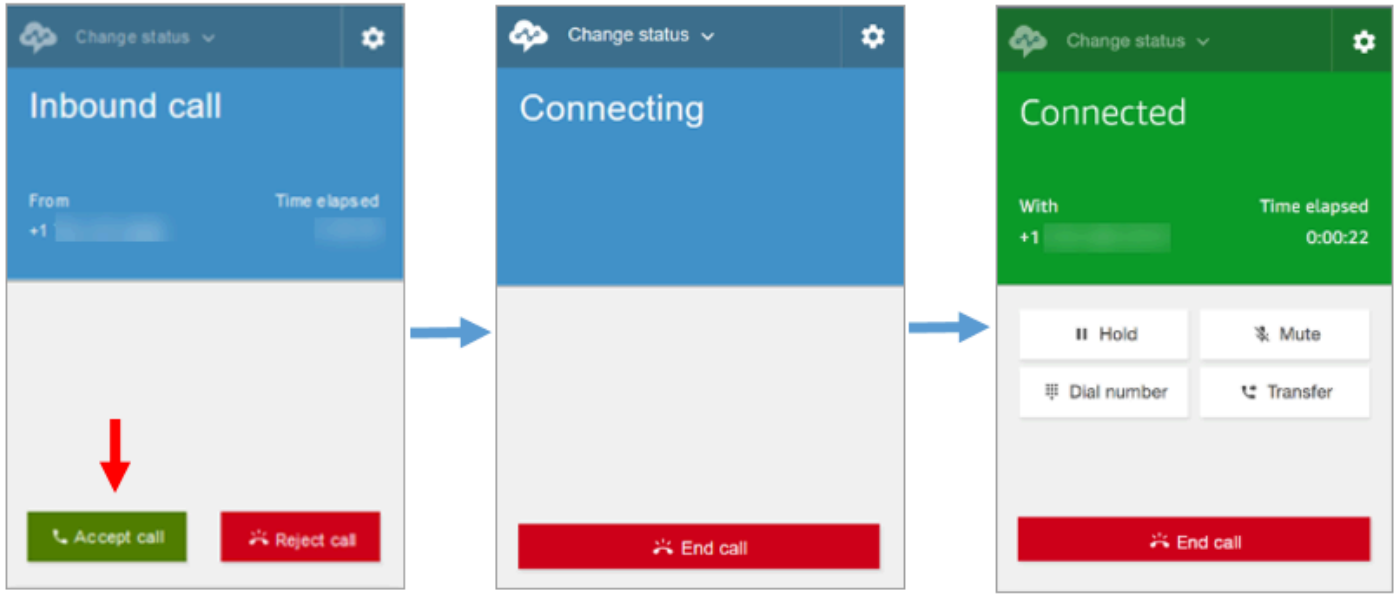

Earlier CCP

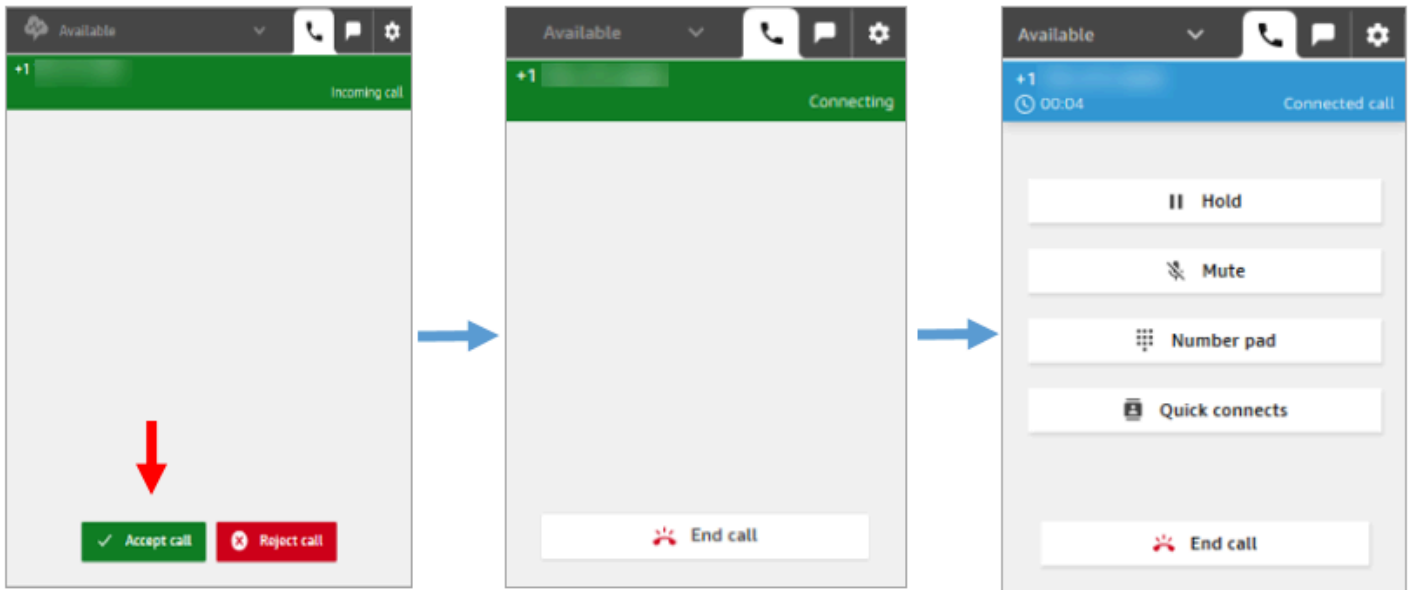

Latest CCP

Miss a call

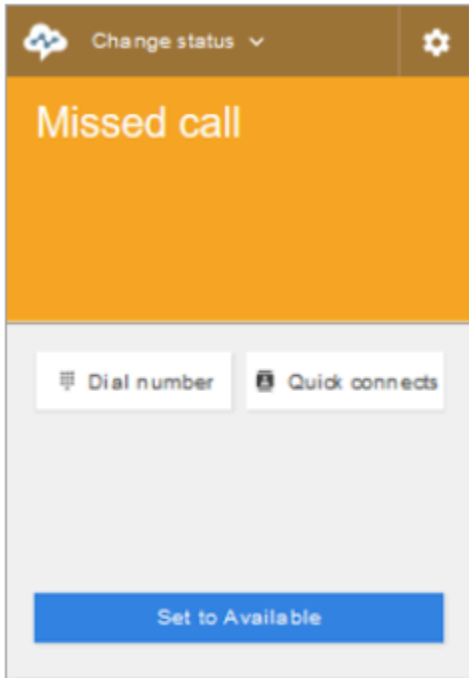

Earlier CCP

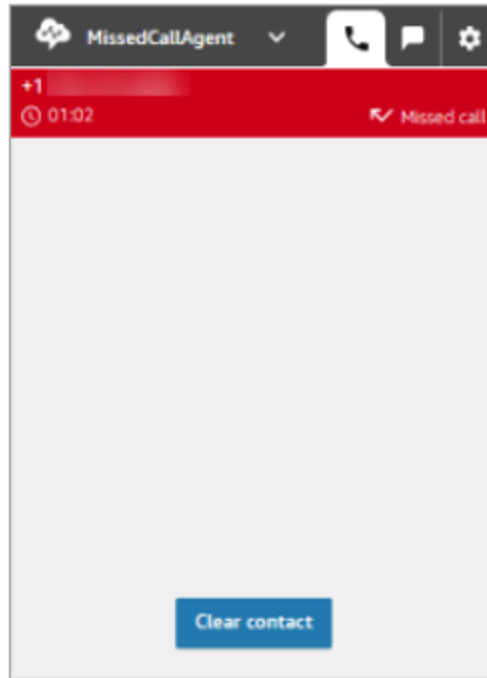

Latest CCP

Make a call: When to use Quick connects

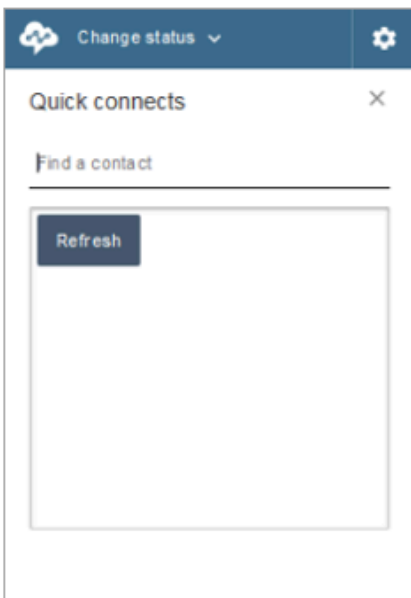

Earlier CCP

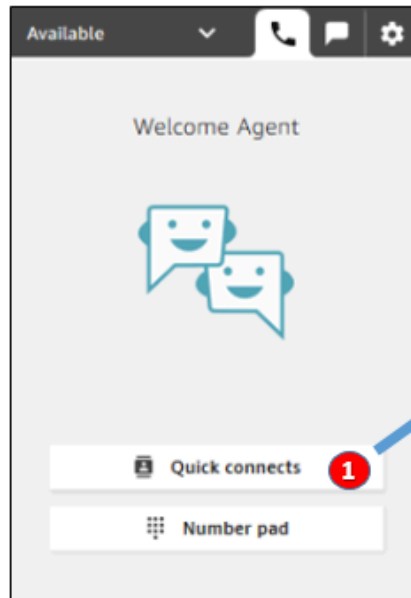

Latest CCP

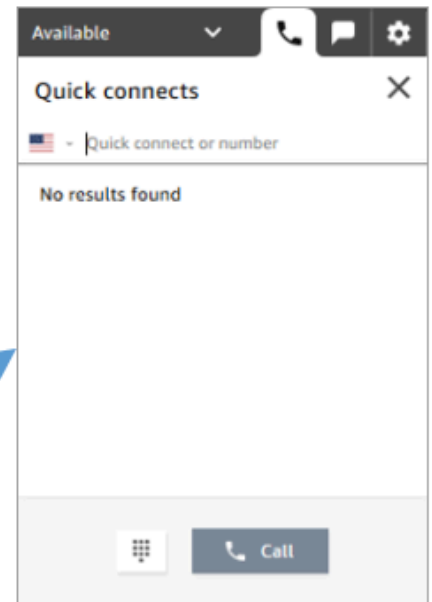

- Use the **Quick connects** button to type a number or select a quick connect.

Make a call: When to use Number pad

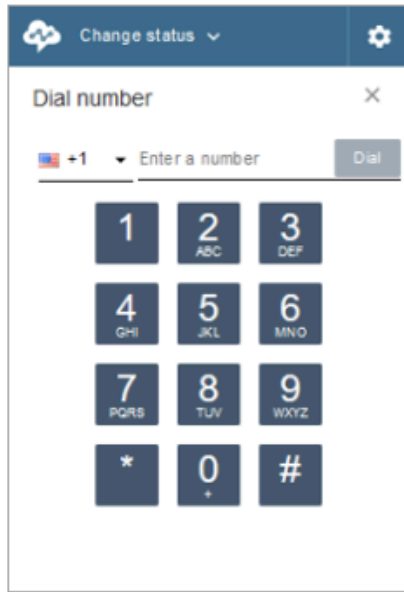

Earlier CCP

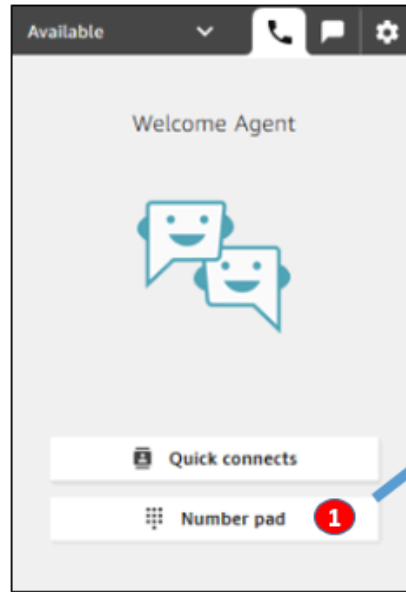

Latest CCP

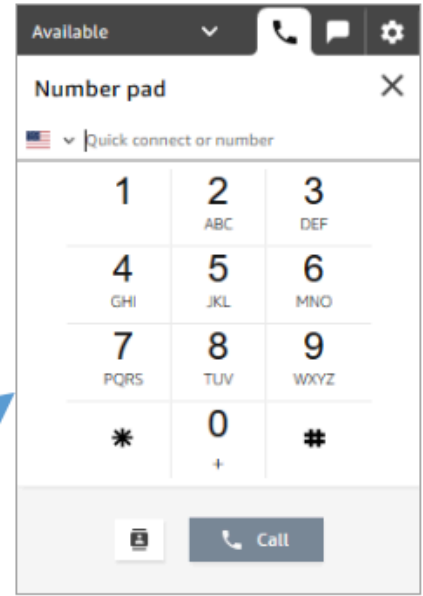

- Choose the **Number pad** button to type and call a number. This is useful for corporate numbers with letters (for example, 1-800-EXAMPLE).

Make an outbound call

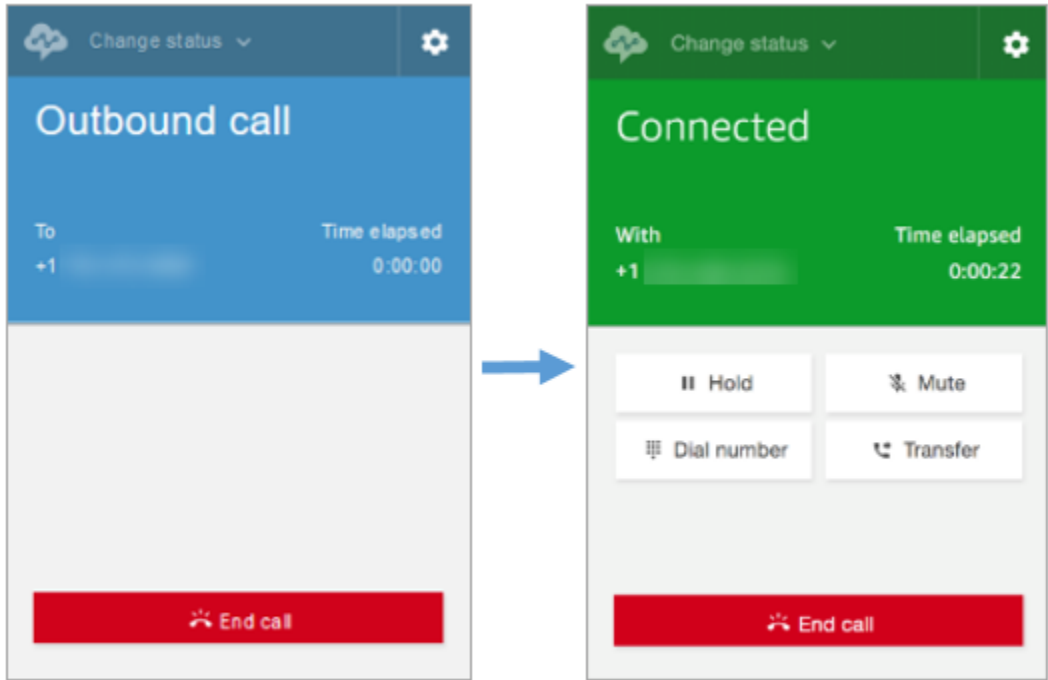

Earlier CCP

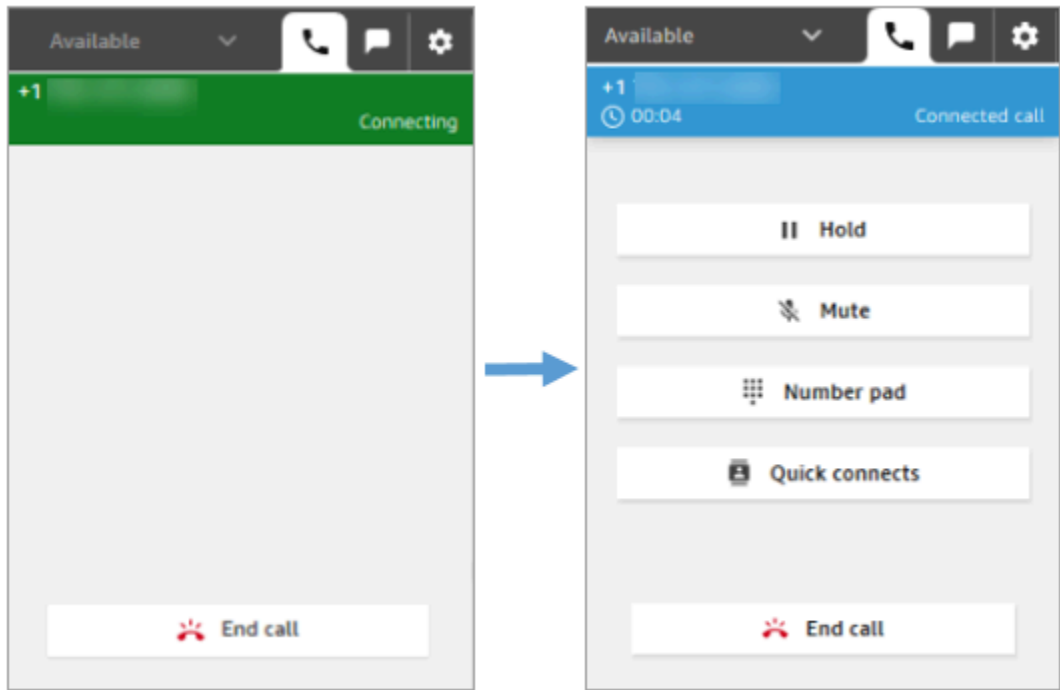

Latest CCP

Agent ends a call before being connected to the other party

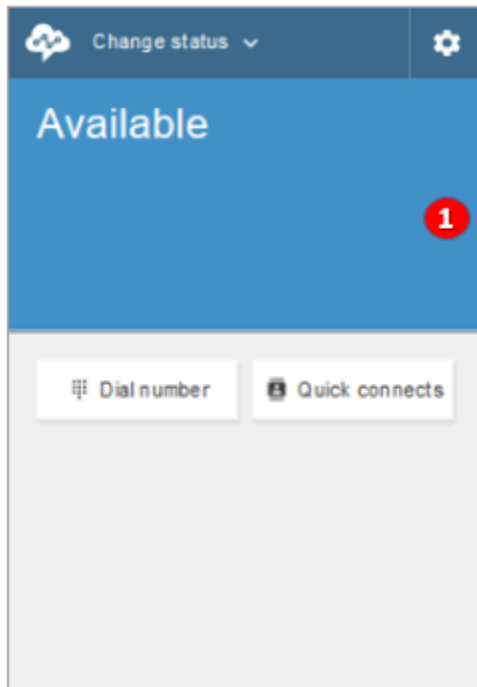

Earlier CCP

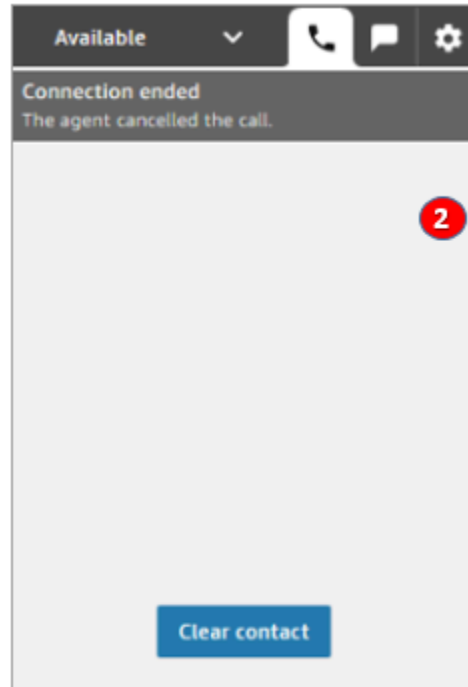

Latest CCP

1. If an agent ends a call before being connected, they are then available for a new contact to be routed to them automatically.
2. If an agent ends a call before being connected, they are prompted to choose **Clear contact**.

Make another call while connected on a call

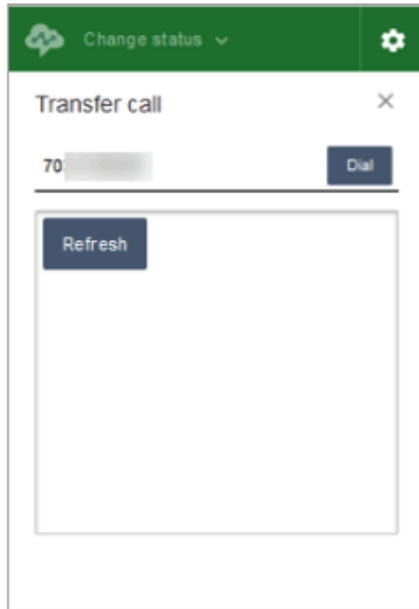

Earlier CCP

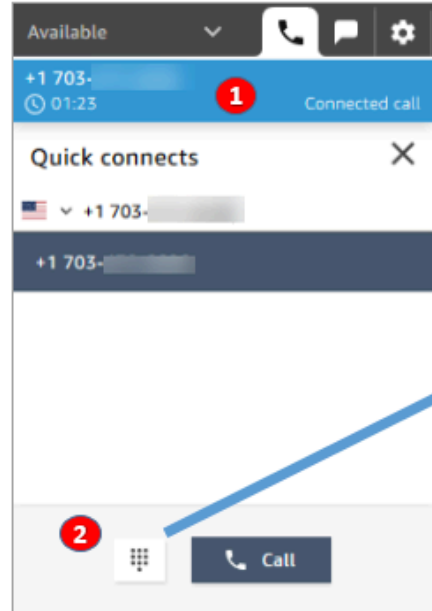

Latest CCP

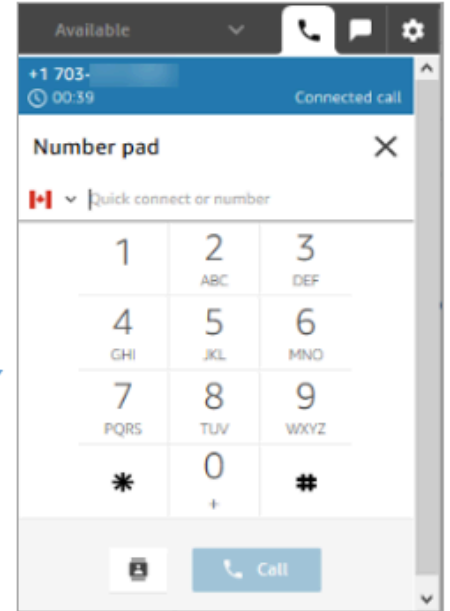

1. You can see the call that you are on while typing another number or selecting a quick connect.
2. After choosing **Quick connects**, you can choose the **Number pad** button. Then on the **Number pad** page, you can enter a number.

Enter DTMF input while connected on a call

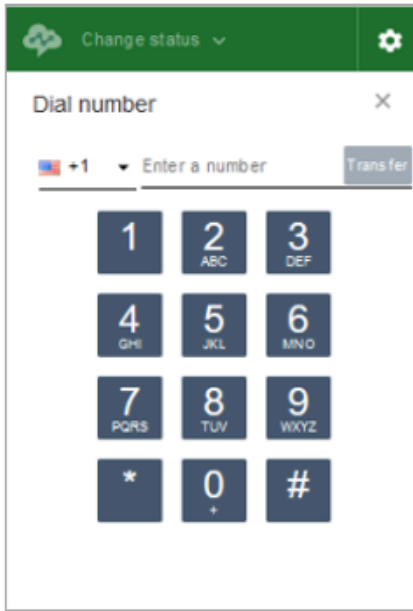

Earlier CCP

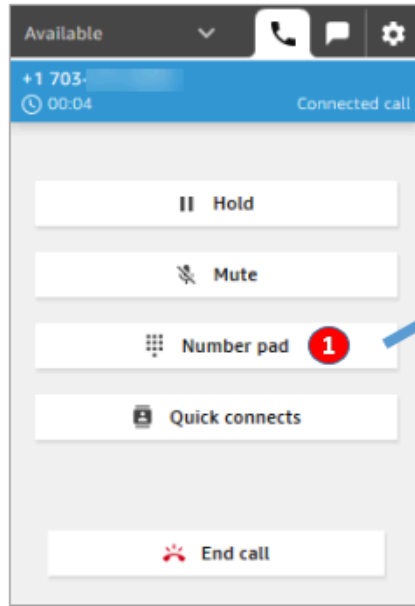

Latest CCP

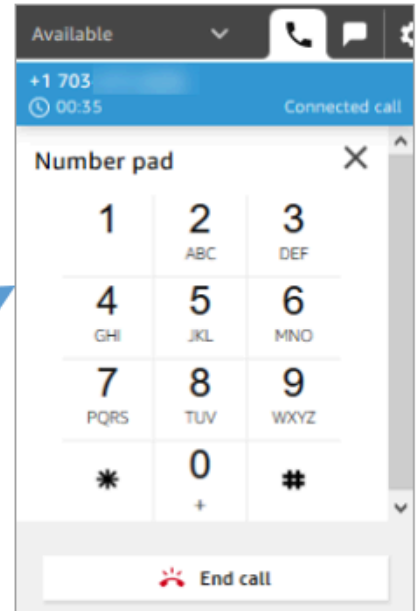

- While on a call, only use **Number pad** to enter DTMF input.

Conference call scenario 1: Leaving a call when one party is on hold and the other is connected

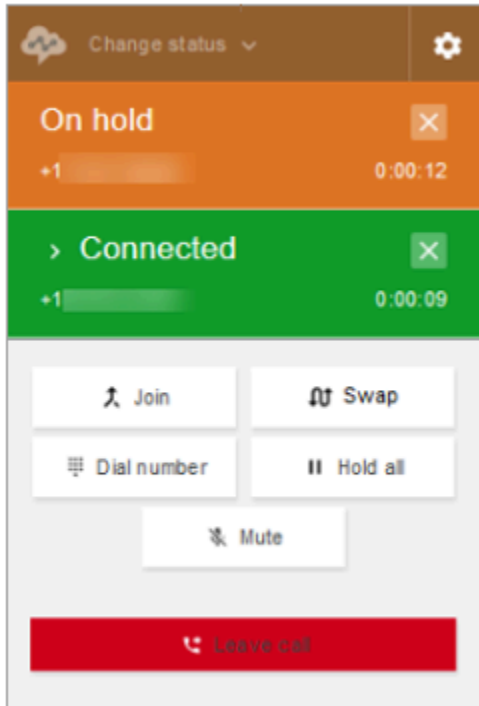

Earlier CCP

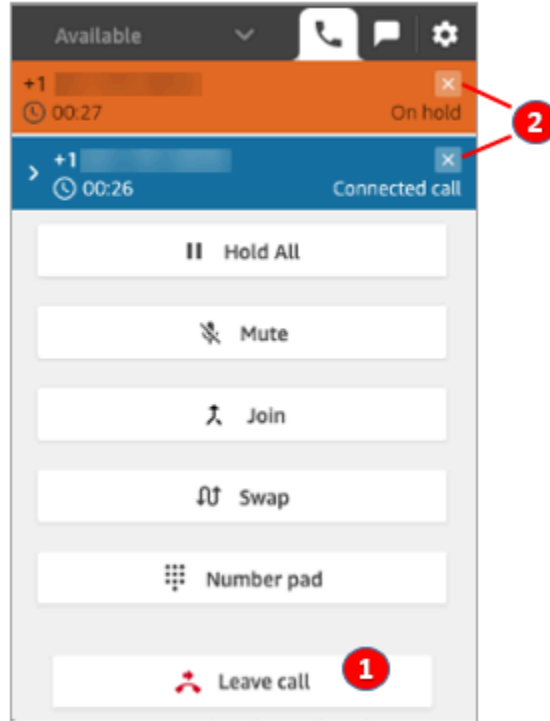

Latest CCP

1. Choose **Leave call** to leave the call. This automatically takes the first party off hold and connects them to the second party.
2. If instead you want to end the call, choose the x next to each party's number. This disconnects each party.

Conference call scenario 2: Leaving a call when the other parties are joined

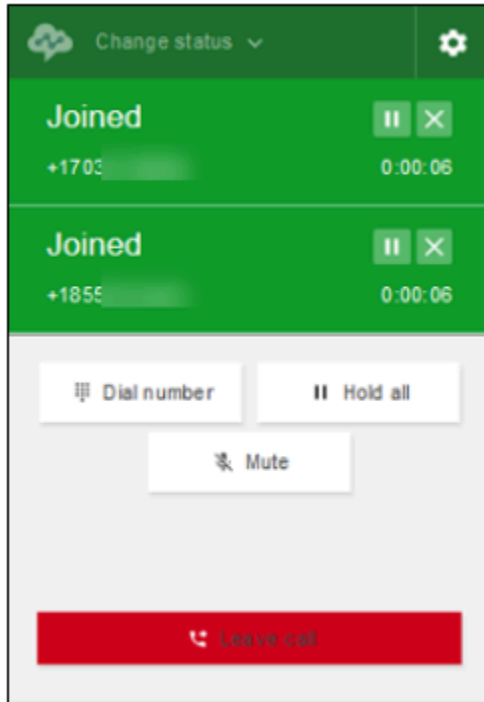

Earlier CCP

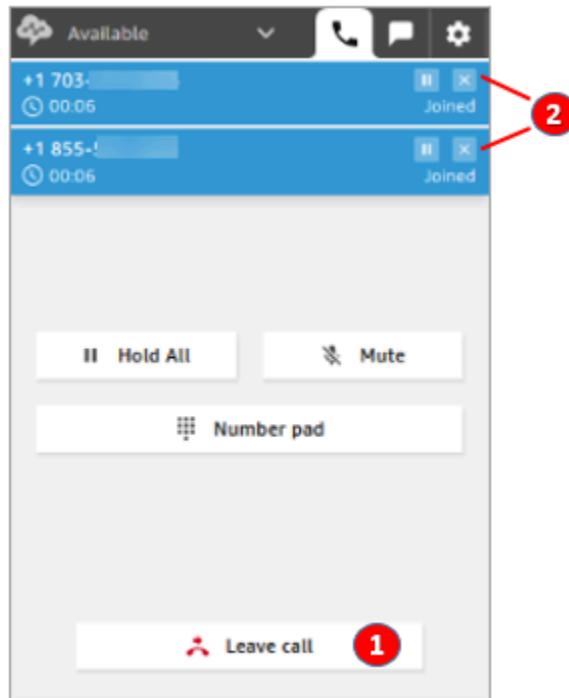

Latest CCP

1. Choose **Leave call** to leave the call. The other two parties stay joined.
2. If instead you want to end the call, choose the **x** next to each party's number. This disconnects each party.

Conference call scenario 3: Leaving a call when the other parties are on hold

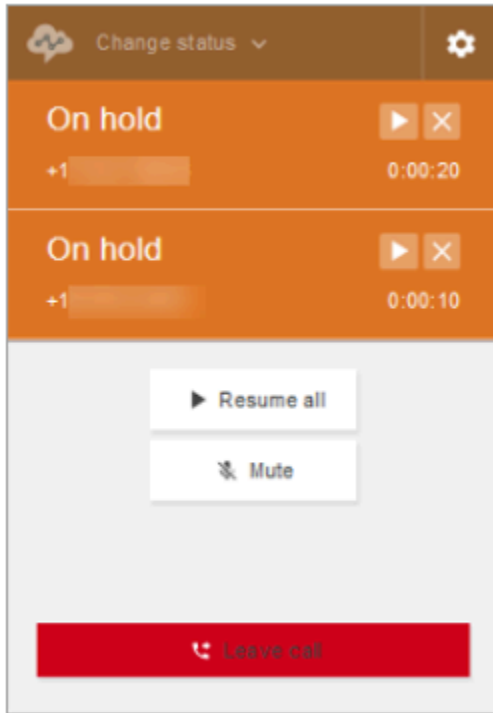

Earlier CCP

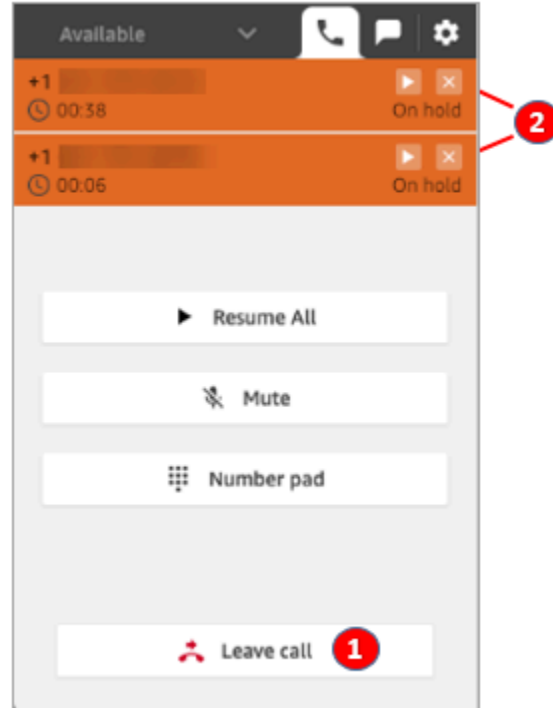

Latest CCP

1. Choose **Leave call** to leave the call. The other two parties are automatically taken off hold and connected.
2. If instead you want to end the call, choose the x next to each party's number. This disconnects each party.

Receive a queued callback

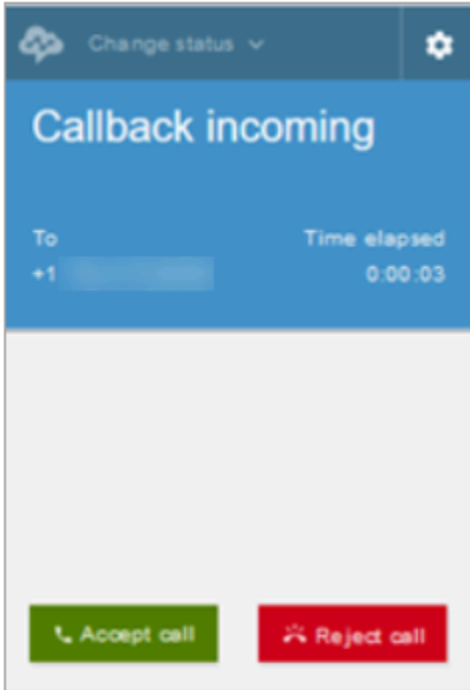

Earlier CCP

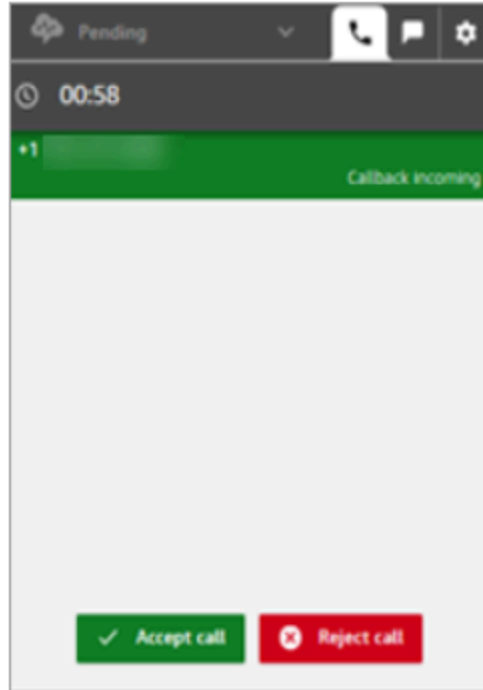

Latest CCP

Miss a queued callback

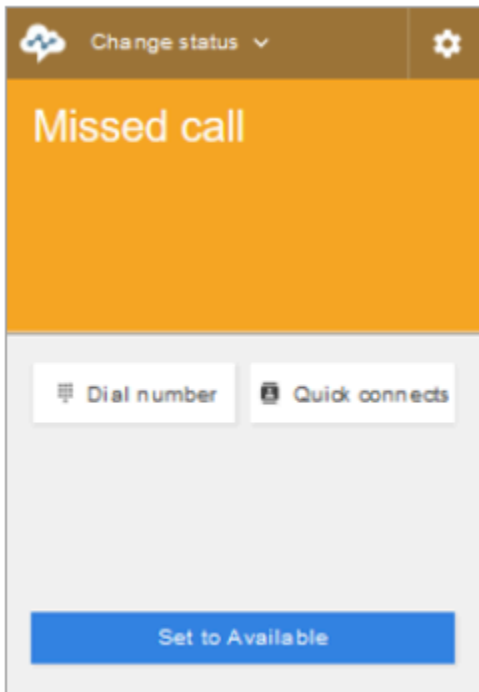

Earlier CCP

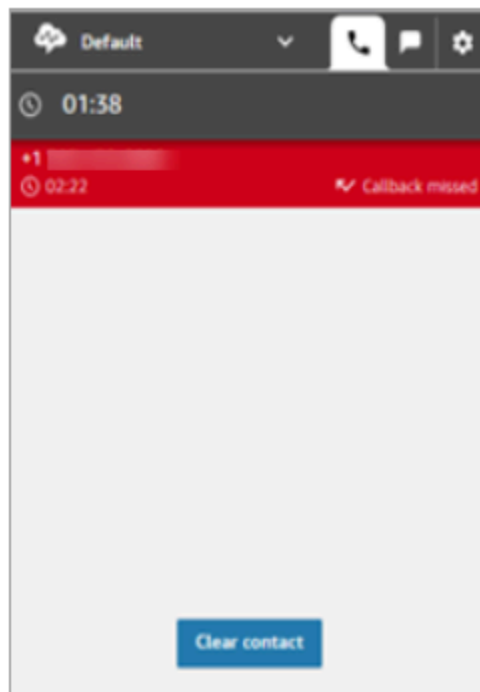

Latest CCP

Finish After contact work (ACW)

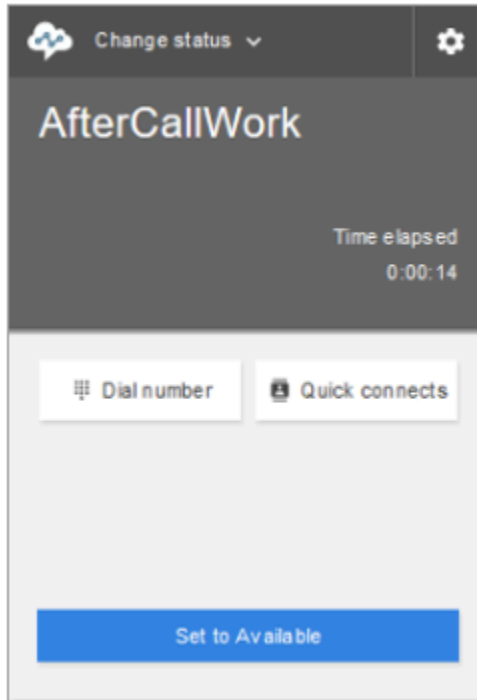

Earlier CCP

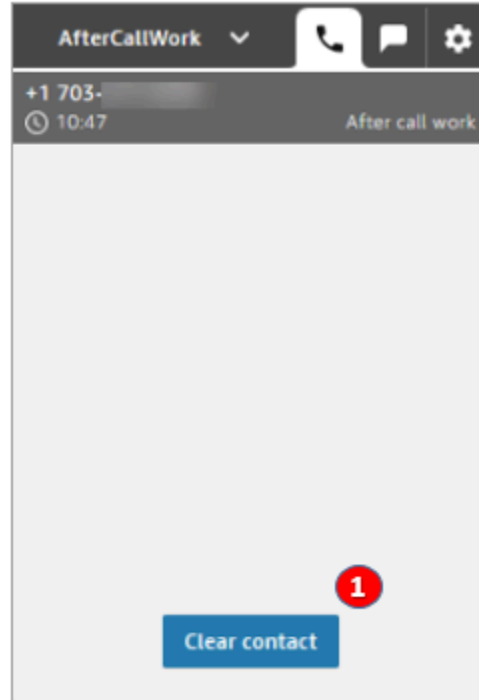

Latest CCP

- During After contact work (ACW), agents can finish follow-up work, and then choose **Clear contact**.

I use the Amazon Connect Streams API

Note

The Amazon Connect Streams API remains the same between the earlier and latest versions of the CCP. We recommend validating custom implementations built using the Amazon Connect Streams API when upgrading versions to ensure consistency in behavior.

Use the following steps to upgrade to the latest CCP.

1. We recommend using the latest [Amazon Connect Streams API](#).
2. Update the URL associated with `initCCP()` from `/ccp#` to `/ccp-v2`. For information about `initCCP()`, see [connect.core.initCCP\(\)](#) in the Amazon Connect Streams API documentation on GitHub.

3. Add your domain URL to the Approved origin list:

1. Log in to the [AWS Management Console](https://console.aws.amazon.com/console) (<https://console.aws.amazon.com/console>) using your AWS account.
2. Navigate to the Amazon Connect console.
3. Check that you're in the correct Region for your Amazon Connect instance. Choose your instance.

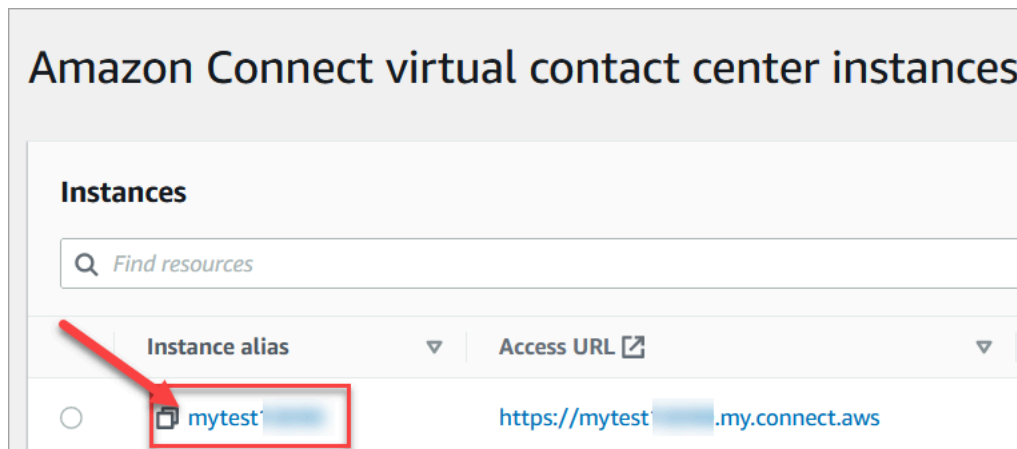

4. Choose **Application integration**, and then choose **Add origin**.

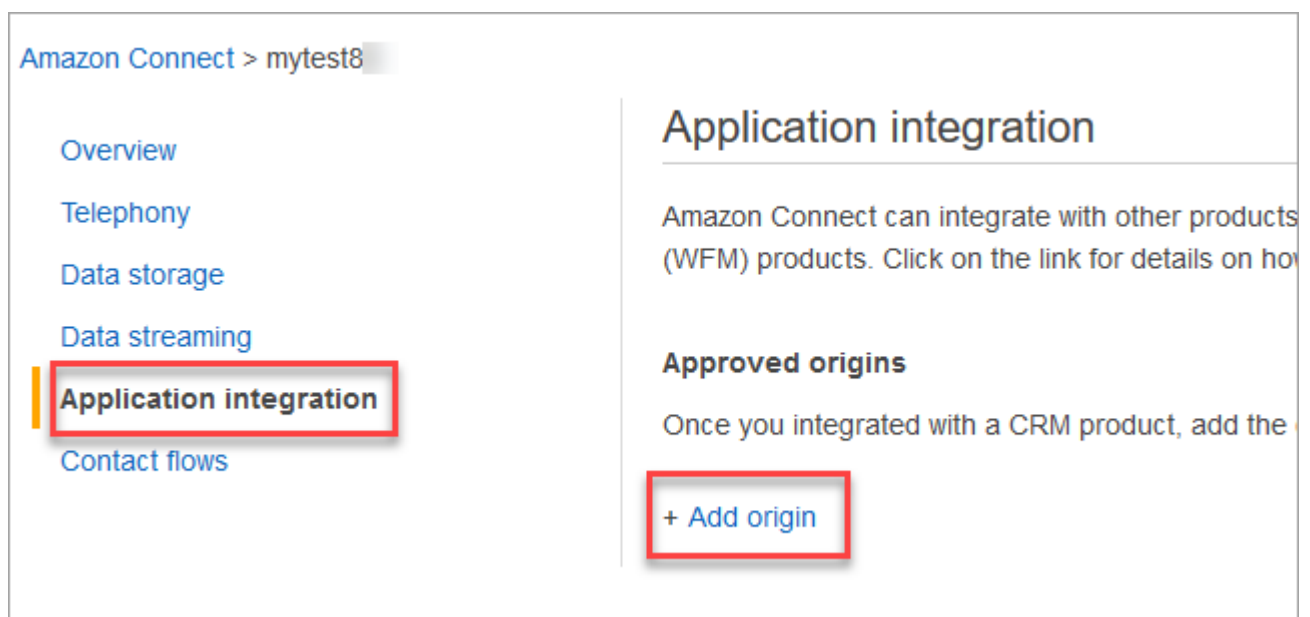

5. Enter your domain URL. All domains that embed the CCP for a particular instance to be explicitly added. For more information, see [this article](#) on GitHub.

If you use Salesforce, you need to add the Salesforce domains to your allowlist to prevent any issues with the CTI Adapter CCP functionality. For detailed instructions, see the [Amazon](#)

[Connect CTI Adapter for Salesforce Lightning installation guide](#) or the [Amazon Connect CTI Adapter for Salesforce Classic installation guide](#).

Verify your network settings

We highly recommend setting up your network to use [Option 1 \(recommended\): Replace Amazon EC2 and CloudFront IP range requirements with a domain allowlist](#).

Using this option helps Amazon Connect Support to quickly troubleshoot any issues you have. Specifically, using `*.telemetry.connect.{region}.amazonaws.com` passes more metrics to our Support team to help with troubleshooting.

Update your SAML URL to ccp-v2

If you use SAML 2.0 as your identity management system, be sure to update the destination in your relay state URL to `ccp-v2`.

Change `destination=/connect/ccp` to `destination=/connect/ccp-v2`.

For more information, see [Use a destination in your relay state URL](#)

Provide agents with access to the Contact Control Panel

Note

This is the URL to the CCP website:

- `https://instance name.my.connect.aws/ccp-v2/`

This is the URL to the [agent application](#):

- `https://instance name.my.connect.aws/agent-app-v2/`

Steps to ensure agents can access the CCP

Agents use the Amazon Connect Contact Control Panel (CCP) to communicate with contacts. But before agents can access to the CCP and handle contacts, there are a few things you need to do:

1. Ensure your network meets the requirements for using the CCP. For more information see [Set up your network](#).
2. Ensure agents have the appropriate headsets and workstations. For more information see [Agent headset and workstation requirements for the CCP](#).
3. Create a user name and password for agents to log into the CCP, by [adding agents to your instance](#).
4. At minimum, [assign them the Agent security profile](#). This grants them permissions to access the CCP, which they use to manage contacts.
5. Provide the user name, password, and the CCP website link to your agents so they can log in.

We recommend telling agents to bookmark the URL to the CCP so they can readily access it.

6. Train your agents on the CCP:
 - Watch [Training video: How to use the CCP](#)

Agent application: Everything in one place

Want your agents to manage contacts, and access customer profiles, cases, and knowledge all in one place? Use the [agent application](#)!

The *agent application* is a single web browser interface that hosts the CCP, [Customer Profiles](#), [Cases](#), and [Amazon Q in Connect](#).

If you're using the CCP that is provided with Amazon Connect, after you enable Customer Profiles, Cases, or Amazon Q in Connect, share the following URL with your agents so they can access it in the agent application:

- [https://*instance name*.my.connect.aws/agent-app-v2/](https://instance_name.my.connect.aws/agent-app-v2/)

For help finding your instance name, see [Find your Amazon Connect instance name](#).

Grant microphone access in Chrome, Firefox, or Edge

If agents experience problems with their microphone, they may need to grant microphone access in their browser. Choose one of the following articles to get the steps appropriate for your browser:

- [Use your camera and microphone in Chrome](#)

- [Firefox Page Info window](#)
- *How to allow a website to use your camera or microphone while browsing in Microsoft Edge* in the article [Windows camera, microphone, and privacy](#)

Important

A change introduced in Google Chrome version 64 may result in issues with receiving calls if you are using an embedded Contact Control Panel (CCP) softphone using the Amazon Connect Streams library. If you are experiencing issues with your microphone when using Chrome version 64, you can resolve the issue by building and deploying the latest version of the [Amazon Connect Streams API](#), following the steps under *Downloading Streams*. You can also resolve the issue by using Firefox or Edge as your browser.

How to get help for CCP issues

Agents: Contact your manager or the technical support provided by your company.

Amazon Connect Administrators: See [Troubleshooting Issues when using the Contact Control Panel \(CCP\)](#) for detailed troubleshooting steps. Or, log in to the [AWS Management Console](#) (<https://console.aws.amazon.com/console>) using your AWS account. In the upper right corner of the page, choose **Support**, and open a support ticket.

Agent headset and workstation requirements for the CCP

Agent headsets and workstations in the contact center vary widely. While the Amazon Connect CCP is built to handle high levels of jitter and high latency environments, the architecture of the **workstations** that agents use, and the location and environment in which they take contacts, can impact the quality of experience.

Headset requirements

The agent's Contact Control Panel (CCP) is compatible with all types of headsets.

For the best agent and customer experience, we recommend using a USB headset.

Alternatively, you can redirect the contact to an external number, in E.164 format, using an agent's existing telephony.

Note

If the agent's audio device does not support up to 48kHz and the browser asserts a sample rate of 48kHz, audio issues such as an audible humming sound may be present in the agent's outgoing audio. This has been seen with Firefox but not with Chrome.

For instructions on verifying the sample rate of the agent's headset and browser, see [Humming sound in headset: Verify the headset and browser sample rates](#)

Workstation minimum requirements

Under-powered workstations can make it difficult for agents to access the tools and resources they need to service contacts. Also, keep in mind the resource requirements when scoping workstations to ensure that they can perform under load while appropriately multitasking for the use case.

Following are the minimum system requirements for the workstations using the CCP only. You'll need to scope additional memory, bandwidth, and CPU for the operating system and anything else running on the workstation to avoid resource contention.

- **Browser**—For a list of all supported browsers, see [Browsers supported by Amazon Connect](#).
- **Network**—100 Kbps bandwidth per connected workstation
- **Memory**—2 GB RAM
- **Processor (CPU)**—2 GHz

iPhone and other mobile devices are not supported

The Amazon Connect console, Contact Control Panel (CCP), and agent workspace do not support mobile browsers.

How to determine whether a workstation is the source of problems

To determine whether a workstation is the source of problems, you need access to various levels of logging information. However, adding logging and monitoring to workstations that are already experiencing resource contention may further reduce available resources and invalidate test results. We recommended that your workstation meet the minimum requirements, so you leave additional resources available for logging, monitoring, malware scanning, operating system functions, and any other running processes.

Collect additional historical logging and data sources for correlation. If you see a correlation between the time of the event and the time the issue was reported, you may be able to determine the root cause with the following information:

- Round trip time (RTT) and packet loss to endpoints located within your Amazon Connect Region from your agent workstation, or an identical workstation on the same network segment. If no Region endpoints are available because of security policies, any public WAN endpoint suffices, for example, www.Amazon.com. Ideally, use your instance alias address (<https://your-instance-alias.my.connect.aws/>), and also your signaling address for endpoints.

You can find your Region endpoints here: [Amazon Connect endpoints and quotas](#).

- Regular monitoring of workstations that show processes running, and the current resource usage of each process.
- Workstation performance/utilization in these areas:
 - Processor (CPU)
 - Disk / drive
 - RAM / memory
 - Network throughput and performance
- Monitor all of the preceding for your VDI desktop environment, including RTT/packet monitoring between the agent workstation and the VDI environment.

How to determine whether the agent's headset is the source of the problem

Problems with the agent's headset are usually caused by two issues:

- The connection between the agent's headset and computer.
- The permissions for the browser microphone.

Here's what you need to do:

- **Check that your computer recognizes your headset**—Check the settings in Device Manager to ensure that your computer recognizes the headset and allows proper headset connectivity. For example, if you're using a Windows PC:
 1. Go to **Device Manager**, then expand **Audio inputs and outputs**.

2. If your computer recognizes your headset, you'll see it listed there.
- **Check your browser settings for your headset/microphone**
 - **Chrome**
 1. go to **Settings, Site Settings, Microphone**.
 2. Then check that the correct headset is enabled.
 3. To learn more, see [Use your camera and microphone in Chrome](#).
 - **Firefox**
 1. While in the CCP, choose the lock icon in the address bar. If needed, grant permissions to the CCP.
 2. To learn more, see [Firefox Page Info window](#).
 - **Remove your ad blocker:** If you're using an ad blocker extension, remove it and see if that fixes the problem.

Important

A change introduced in Google Chrome version 64 may result in issues with receiving calls if you are using an embedded Contact Control Panel (CCP) softphone using the Amazon Connect Streams library. If you are experiencing issues with your microphone when using Chrome version 64, you can resolve the issue by building and deploying the latest version of the [Amazon Connect Streams API](#), following the steps under *Downloading Streams*. You can also resolve the issue by using Firefox or Edge as your browser.

For more information about solving audio problems, see [Troubleshooting Issues when using the Contact Control Panel \(CCP\)](#).

Problem for agents using the CCP: Can't hear indicator for incoming chat?

If an agent can't hear the audio indicator for an incoming chat, the problem is likely because Google added an audio policy flag to Chrome. This flag exists in Chrome versions 71 - 75.

To fix this, add the CCP web site to the allowlist in the agent's Chrome settings. For instructions, see this [Google Chrome Help article](#).

For more information about solving audio problems, see [Troubleshooting Issues when using the Contact Control Panel \(CCP\)](#).

Embed a custom Contact Control Panel (CCP)

The [Amazon Connect Streams](#) documentation describes how to integrate your existing web applications with Amazon Connect. Streams gives you the power to embed the Contact Control Panel (CCP) UI components into your page, and/or handle agent and contact state events directly giving you the power to control agent and contact state through an object oriented event driven interface. You can use the built in interface or build your own from scratch: Streams gives you the power to choose.

Contents

- [Using Amazon Connect with third-party cookies](#)
- [Embed the CCP into Salesforce](#)
- [Embed the CCP into Zendesk](#)

Using Amazon Connect with third-party cookies

Google Chrome

Google Chrome has [announced plans](#) to begin third-party cookie deprecation (3PCD) starting Q1 2024 as part of their Privacy Sandbox Initiative. Amazon Connect uses third-party cookies for authentication. Amazon Connect domains have been approved by Google to continue using third-party cookies until **December 27th, 2024**. We are proactively developing solutions to preserve authentication after 3PCD. You should plan to upgrade your Streams API and CTI Adapter later this year. Customers using Amazon Connect Agent Workspace or the Contact Control Panel (CCP) as a standalone application will not be affected.

Note

Customers embedding their Single Sign-On (SSO) to Amazon Connect may be impacted by third-party cookie deprecation if their SAML Identity Provider (IdP) uses third-party cookies. Customers embedding SSO should contact their SAML IdP for mitigation instructions if necessary. To test if you are impacted, see Chrome's guidelines for testing third-party cookie breakage.

Embed the CCP into Salesforce

The core functionality of the Amazon Connect CTI Adapter provides a WebRTC browser-based Contact Control Panel (CCP) within Salesforce. The Amazon Connect CTI integration consists of two components:

- [A managed Salesforce package](#)
- [An AWS Serverless application deployed to your AWS environment](#)

For a detailed walk-through and setup of the full CTI Adapter capabilities for Salesforce Lightning, see the [Amazon Connect CTI Adapter for Salesforce Lightning installation guide](#).

For the CTI Adapter for Salesforce Classic, see the [Amazon Connect CTI Adapter for Salesforce Classic installation guide](#).

We recommend that you initially install the package into your Salesforce sandbox. After the package is installed, you can configure your Salesforce Call Center configuration within Salesforce.

Embed the CCP into Zendesk

To integrate Amazon Connect and Zendesk, you need:

- An Amazon Connect instance.
- A [Zendesk Support](#) account with a [Zendesk Talk Partner Edition](#) plan, or a Zendesk trial account.

Install and configure the [Amazon Connect for Zendesk app](#) in your Zendesk Support account, then integrate the app with Amazon Connect. After integration, you can create flows to use Amazon Connect with Zendesk ticketing.

For more information, see [How do I integrate Amazon Connect with Zendesk?](#)

Set up Amazon Connect Global Resiliency

Note

This feature is available only for Amazon Connect instances created in the following AWS Regions: US East (N. Virginia), US West (Oregon), Europe (Frankfurt), and Europe (London). You can only create a replica in the US East (N. Virginia) Region if your source is US West (Oregon), or the other way around. Similarly, you can only create a replica in the Europe (Frankfurt) Region if your source is Europe (London), or the other way around. To obtain access to this feature, contact your Amazon Connect Solutions Architect or Technical Account Manager.

Amazon Connect Global Resiliency enables you to provide customer service anywhere in the world with the highest reliability, performance, and efficiency. With its distributed telephony features, your contact center can meet international regulatory requirements.

Amazon Connect Global Resiliency provides a set of APIs that you use to:

- Provision a linked Amazon Connect instance in another AWS Region.
- Provision and manage phone numbers that are global and accessible in both Regions.
- Distribute telephony traffic and agents across Amazon Connect instances and Regions in 10% increments, or shift them all at once. This enables you to slowly shift inbound voice contacts and agents across Regions or shift them all at the same time.

For example, you can distribute inbound voice contacts and agents 100% in US East (N. Virginia) and 0% in US West (Oregon), or 50% in each Region.

- Access reserved capacity across Regions.

Contents

- [Amazon Connect Global Resiliency requirements](#)
- [Get started with Amazon Connect Global Resiliency](#)
- [Manage traffic distribution groups](#)
- [Manage phone numbers across Regions](#)
- [Manage chat across Regions](#)

Amazon Connect Global Resiliency requirements

If you have decided that Amazon Connect Global Resiliency is the appropriate deployment for you, ensure you adhere to the following pre-requisites before onboarding:

- [Port](#) all phone numbers you want to enable to be multi-region to Amazon Connect.
- You must have an existing production [SAML 2.0-enabled](#) Amazon Connect instance in a Region where Amazon Connect Global Resiliency is available. To confirm, see [Global Resiliency availability by Region](#).
- It is recommended to onboard and test Amazon Connect Global Resiliency services in a test environment before onboarding production traffic.
- Request that ALL service quotas in the replica instance match the service quotas in the source instance: [Create a service quota increase case](#) in the AWS Management Console > Support.
- Ensure your Lambda functions across AWS Regions have the same name.
- Update your flows to replace any hardcoded Regions with a `$.AwsRegion` or `$['AwsRegion']` parameter.
- For Amazon Lex bots, you can do one of the following:
 - Use Amazon Lex Global Resiliency to replicate bots across AWS Regions and retain the bot ID.
 - Change your flows to branch based on the AWS Region where the flow is running. At flow runtime, these parameters are replaced with the Region where the flow is run, as shown in the following example.

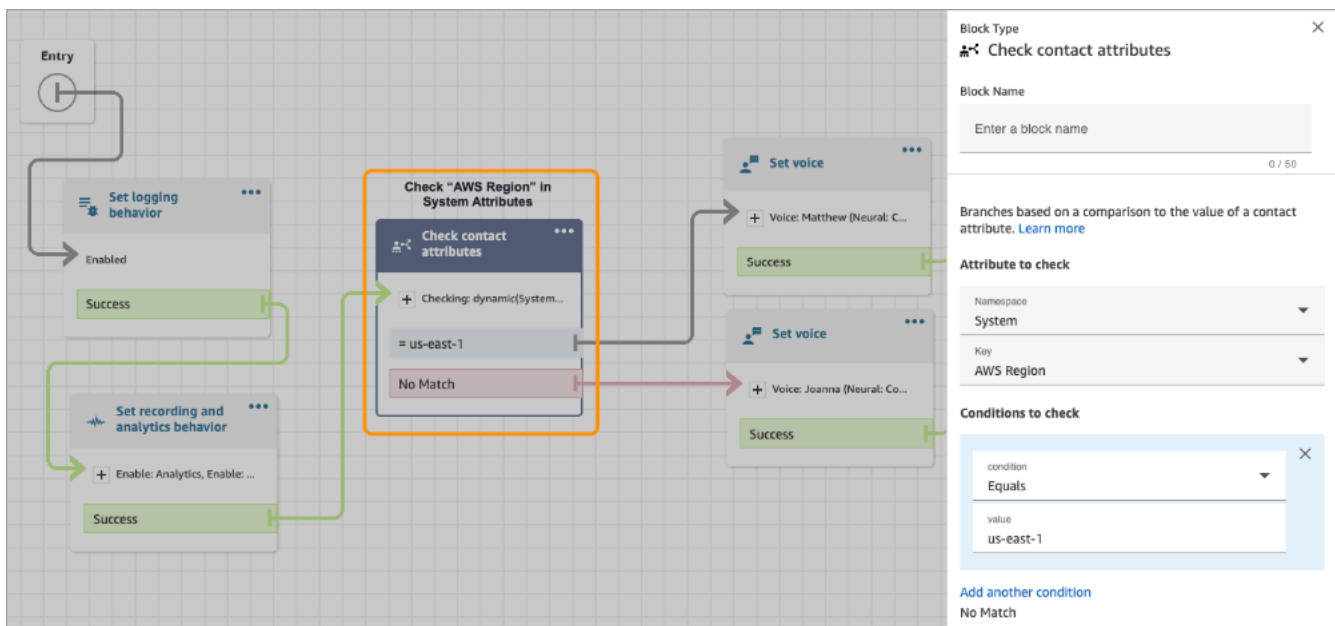

Get started with Amazon Connect Global Resiliency

Note

This feature is available only for Amazon Connect instances created in the following AWS Regions: US East (N. Virginia), US West (Oregon), Europe (Frankfurt), and Europe (London). You can only create a replica in the US East (N. Virginia) Region if your source is US West (Oregon), or the other way around. Similarly, you can only create a replica in the Europe (Frankfurt) Region if your source is Europe (London), or the other way around. To obtain access to this feature, contact your Amazon Connect Solutions Architect or Technical Account Manager.

You get started with Amazon Connect Global Resiliency by creating a replica of your existing Amazon Connect instance in another AWS Region, and by creating a traffic distribution group.

A *traffic distribution group* is an Amazon Connect resource that enables you to link Amazon Connect instances that are in different AWS Regions. Phone numbers can be attached to the traffic distribution group. Traffic to these numbers can be distributed between the instances in the traffic distribution group.

How to set up Amazon Connect Global Resiliency

1. [Create a replica of your existing Amazon Connect instance](#). Use the [ReplicateInstance](#) API.
2. [Create a traffic distribution group](#).
 1. Use the [CreateTrafficDistributionGroup](#) API.
 2. Use [DescribeTrafficDistributionGroup](#) API to determine whether the traffic distribution group has been created successfully (Status must be ACTIVE).
3. [Claim phone numbers to your traffic distribution group](#). After your traffic distribution group has been created successfully (Status is ACTIVE), you can claim phone numbers to it using the [ClaimPhoneNumber](#) API.

Note

The default traffic distribution for these phone numbers is set to 100% - 0%. That is, 100% of inbound telephony traffic will go to the source Amazon Connect instance that was used to create a replica.

In addition, after phone numbers are claimed to an instance, you can assign them to multiple instances across AWS Regions. To do this, use the [UpdatePhoneNumber](#) API to assign the numbers to a traffic distribution group.

4. [Update your traffic distribution](#). Use the [UpdateTrafficDistribution](#) API to distribute traffic across the linked instances in 10% increments.

Create a replica of your existing Amazon Connect instance

Note

This feature is available only for Amazon Connect instances created in the following AWS Regions: US East (N. Virginia), US West (Oregon), Europe (Frankfurt), and Europe (London). You can only create a replica in the US East (N. Virginia) Region if your source is US West (Oregon), or the other way around. Similarly, you can only create a replica in the Europe (Frankfurt) Region if your source is Europe (London), or the other way around. To obtain access to this feature, contact your Amazon Connect Solutions Architect or Technical Account Manager.

You call the [ReplicateInstance](#) API to create a replica of your Amazon Connect instance in another AWS Region and to copy configuration information for Amazon Connect resources across AWS Regions.

Contents

- [Important things to know](#)
- [Characteristics of the replica instance](#)
- [What resources are mirrored in the replica instance](#)
- [What to do after the replica instance is created](#)
- [When to contact AWS Support](#)
- [Why a ReplicateInstance call fails](#)
- [How to find the source Region of your Amazon Connect instances](#)

Important things to know

- Before running [ReplicateInstance](#):
 - Make sure you have the minimum required IAM permissions to create an instance. See [Required permissions for using custom IAM policies to manage access to the Amazon Connect admin website](#).
 - Update your flows to replace any hardcoded Regions with a `$.AwsRegion` or `['AwsRegion']` parameter. At flow runtime, these parameters are replaced with the Region where the flow is run.
 - Ensure your Lambda functions across AWS Regions have the same name.
 - For Amazon Lex bots, you can do one of the following:
 - Use Amazon Lex Global Resiliency to replicate bots across AWS Regions and retain the bot ID.
 - Change your flows to branch based on the AWS Region where the flow is running. At flow runtime, these parameters are replaced with the Region where the flow is run, as shown in the following example.

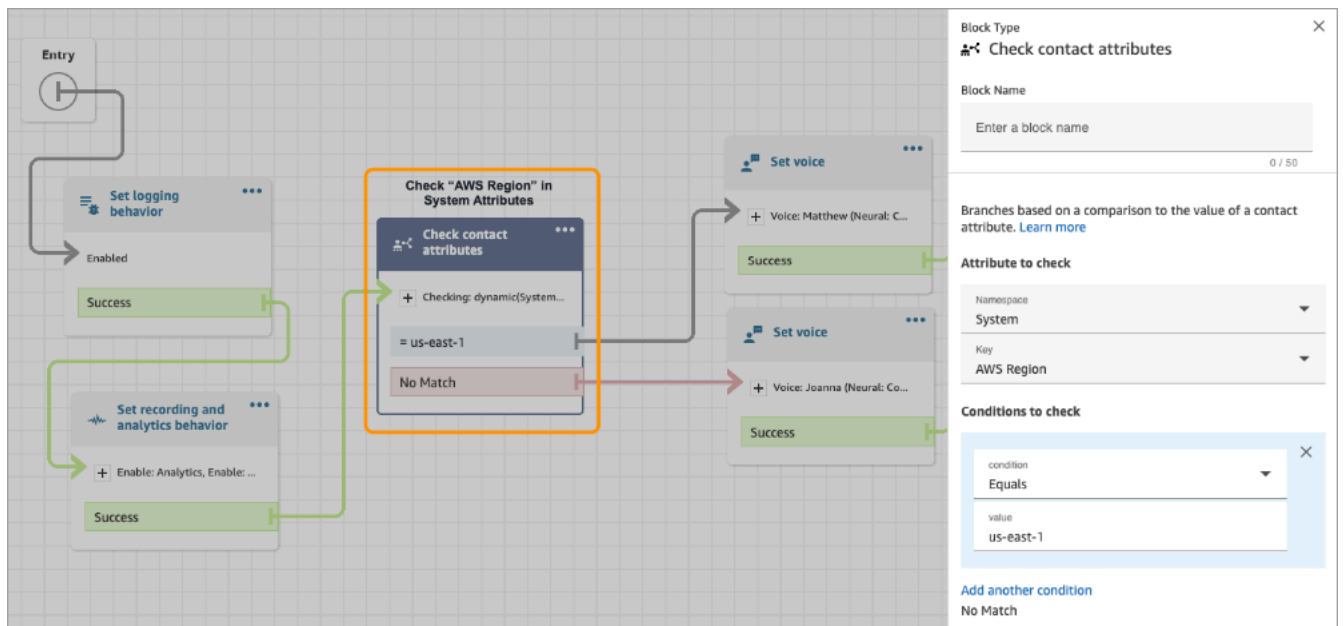

- To allow AWS managed keys in the replica instance, using the AWS console, create a temporary Amazon Connect instance in the Region where you are planning to create the replica instance. This will create the default AWS managed keys for Amazon Connect.
- [ReplicateInstance](#) copies the Amazon Connect configuration across AWS Regions as part of the initial replication process. After this first step completes, any changes made to [mirrored resources](#) at a later time are continuously synchronized to the replica instance across Regions.

- All phone numbers on the source instance that aren't already associated to number groups are automatically added to the default traffic distribution group. This step enables the phone numbers to be available in both source and replica Regions, and enables phone number-flow associations to be mirrored across AWS Regions.
- Emergency access to log into the replica instance is available only after the default routing profile and queue have been mirrored across the Regions.
- As the configuration is propagated across AWS Regions, you can view the progress in AWS CloudTrail logs. Or, in the Amazon Connect admin website you can navigate to **User management**, **View historical changes** to view an audit trail of changes to the users.
- A resource name conflict will occur if resources in the source instance and the replica instance have the same name but different resource IDs. This might happen, for example, if the resource in the replica instance was created manually outside of the replication process.

In the case of resource name conflicts, [ReplicateInstance](#) doesn't synchronize the resource across Regions. Instead it throws a `ResourceConflictException` error. After you resolve the name conflict (for example, delete the resource in the replica instance), you can run `ReplicateInstance` again to synchronize the resource.

- After running `ReplicateInstance`, you must use the [AssociateTrafficDistributionGroupUser](#) API to associate agents to either the default traffic distribution group or a custom traffic distribution group.
- Running [ReplicateInstance](#) does not synchronize Lambda functions or Amazon Lex bots, or other third-party / integrations you may have.

Characteristics of the replica instance

- The replica Amazon Connect instance is created in the same AWS account as your existing Amazon Connect instance.
- [ReplicateInstance](#) creates a default traffic distribution group if one doesn't already exist. This default traffic distribution group has three types of traffic distribution:
 - Sign in
 - Agent
 - Telephony

Use the [CreateTrafficDistributionGroup](#) API to create more traffic distribution groups, however, these additional traffic distribution groups are not default traffic distribution groups and thus only support agent and telephony distributions.

- The default traffic distribution group is the only traffic distribution group where you can change the `SignInConfig` distribution. See the `IsDefault` parameter in the [TrafficDistributionGroup](#) data type.
- You use `SignInConfig` to choose the backend sign-in servers to facilitate the agent signing in to their Amazon Connect instance. For example, if you call `UpdateTrafficDistribution` with a modified `SignInConfig` and a non-default `TrafficDistributionGroup`, an `InvalidRequestException` is returned.
- The replica instance has the same instance ID as the Amazon Connect instance it is replicated from.

What resources are mirrored in the replica instance

[ReplicateInstance](#) mirrors the following Amazon Connect resources across AWS Regions.

Important

The service quotas for these resources are automatically matched across AWS Regions *before* the resources are mirrored across Regions. To increase any other quota in the replica instance, submit a request.

- Flows
- Flow modules
- Users
- Routing profiles
- Queues
- Security profiles
- Hours of operation
- Quick connects
- Prompts (not including those stored in S3)

- User hierarchies (groups and levels)
- Agent status
- Predefined attributes

[ReplicateInstance](#) also replicates the following associations across AWS Regions:

- Phone number to flow
- Queue to routing profile
- User to security profile, routing profile, and user hierarchy
- Routing profiles
- Queue to quick connects
- Queue to hours of operation
- Queue to flow

What to do after the replica instance is created

After your replica Amazon Connect instance is created, you need to configure it:

1. Ensure redundancy for front-end and back-end integrations (for example, SSO, Lambda, Lex) across Regions.
2. Make matching manual updates across the linked instances.
3. Use the [AssociateTrafficDistributionGroupUser](#) API to associate agents to the default traffic distribution group.

Before you can associate agents to a traffic distribution group, they must be present on both the source and replica instances. You cannot associate users to a traffic distribution group when they are newly added to source instance and not yet in the replica.

When to contact AWS Support

Contact AWS Support for help with the following activities:

- To understand mirroring status beyond what's available in the CloudTrail logs and audit trail in the Amazon Connect admin website.
- To stop replication after it is started.

- To delete your replica instance. You need to disassociate numbers and users from traffic distribution groups. AWS Support needs to delete any snapshots we have created for global configuration management.

Why a `ReplicateInstance` call fails

A [ReplicateInstance](#) API call fails with an `InvalidRequestException` in the following cases:

1. The Region where you are creating the replica is the same Region as your existing instance.
2. The instance was already replicated as part of a different [ReplicateInstance](#) API call.
3. The instance does not have an alias.
4. The instance is not in ACTIVE status.
5. The instance does not have SAML enabled.
6. There is a resource name conflict.

How to find the source Region of your Amazon Connect instances

If you forget which Region is your source Region for your Amazon Connect instances, perform the following steps to find it:

1. Call the [ListTrafficDistributionGroups](#) API with your InstanceId.
2. For any traffic distribution group in the response list, the returned InstanceARN includes the source Region. For example in the following ARN, *source-region* would be the Region of your Amazon Connect instance.

```
arn:aws:connect:source-region:account-id:traffic-distribution-group/traffic-distribution-group-id
```

Create traffic distribution groups

You can create a traffic distribution group for your existing Amazon Connect instance by using the [CreateTrafficDistributionGroup](#) API.

A *traffic distribution group* is an Amazon Connect resource that enables you to link Amazon Connect instances that are in different AWS Regions. Phone numbers can be attached to the traffic

distribution group. Traffic to these numbers can be distributed between the instances in the traffic distribution group.

Important things to know

- When creating a traffic distribution group, it must be created in the source AWS Region. A *source Region* is the Region where you set up your existing Amazon Connect instance.
- When associating phone numbers to a traffic distribution group:
 - You can associate only phone numbers that are claimed in the source Region.
 - The phone number must be in the same Region as where the traffic distribution group was created.
- You can claim numbers to a traffic distribution group, or get or update traffic distribution for a traffic distribution group only when its Status is ACTIVE. Use the [DescribeTrafficDistributionGroup](#) API to determine whether it has been created successfully (Status must be ACTIVE).
- When you create a replica Amazon Connect instance, a default traffic distribution group is created for it. The default traffic distribution group is the only traffic distribution group where you can change the `SignInConfig` distribution. See the `IsDefault` parameter in the [TrafficDistributionGroup](#) data type. You use `SignInConfig` to choose which backend sign-in servers are used to facilitate the agent signing in to their Amazon Connect instance. For example, if you call `UpdateTrafficDistribution` with a modified `SignInConfig` and a non-default `TrafficDistributionGroup`, an `InvalidRequestException` is returned.

Traffic distribution group statuses

Following is a description of the traffic distribution group statuses:

- `CREATION_IN_PROGRESS`: Traffic distribution group creation is in progress.
- `ACTIVE`: Traffic distribution group has been created.
- `CREATION_FAILED`: Traffic distribution group creation failed.
- `PENDING_DELETION`: Traffic distribution group deletion is in progress.
- `DELETION_FAILED`: Traffic distribution group deletion failed.
- `UPDATE_IN_PROGRESS`: Traffic distribution group update is in progress.

Why a `CreateTrafficDistributionGroup` call fails

A [CreateTrafficDistributionGroup](#) API call fails with an `InvalidRequestException` in the following cases:

- The [ReplicateInstance](#) API was not called before creating a traffic distribution group for the linked instances.
- The [CreateTrafficDistributionGroup](#) API was not called in the same Region where the [ReplicateInstance](#) API was called. The Region where this API is called must match the Region of the instance that was used to create a replica.

Claim phone numbers to traffic distribution groups

Note

This feature is available only for Amazon Connect instances created in the following AWS Regions: US East (N. Virginia), US West (Oregon), Europe (Frankfurt), and Europe (London). You can only create a replica in the US East (N. Virginia) Region if your source is US West (Oregon), or the other way around. Similarly, you can only create a replica in the Europe (Frankfurt) Region if your source is Europe (London), or the other way around. To obtain access to this feature, contact your Amazon Connect Solutions Architect or Technical Account Manager.

After your traffic distribution group is created successfully (Status is `ACTIVE`), you can use [SearchAvailablePhoneNumbers](#) to search for available phone numbers and [ClaimPhoneNumber](#) to claim them.

Before you claim a phone number to your traffic distribution group, we recommend using the [DescribeTrafficDistributionGroup](#) API to verify the status of the traffic distribution group is `ACTIVE`. Assigning a phone number to a traffic distribution group that isn't `ACTIVE` results in `ResourceNotFoundException`.

You can claim a phone number to a traffic distribution group by providing the traffic distribution group ARN in the `TargetArn` parameter when calling the [ClaimPhoneNumber](#) API. You can also use the [UpdatePhoneNumber](#) API to assign a phone number previously claimed to an instance to a traffic distribution group.

Note

To update the **Description** field, you must use the Amazon Connect console.

Example workflow

Following is an example workflow to claim phone numbers and use them across multiple AWS Regions:

1. Create a replica of your instance:
 - Call the [ReplicateInstance](#) API.
2. Create a traffic distribution group that links these instances together:
 - Call the [CreateTrafficDistributionGroup](#) API.
3. Find available phone numbers that can be claimed to your traffic distribution group:
 - Call the [SearchAvailablePhoneNumbers](#) API in the Region where the traffic distribution group was created. Provide the traffic distribution group ARN for the `TargetArn` parameter.
4. In the Region where the traffic distribution group was created, call the [ClaimPhoneNumber](#) API:
 - a. Provide your traffic distribution group ARN for the `TargetArn` parameter.
 - b. Provide the E164 phone number value that was returned by the [SearchAvailablePhoneNumbers](#) API call in step 3.

A `PhoneNumberId` and `PhoneNumberArn` are returned. You can use these values for follow-up operations.

5. Verify that the phone number status is CLAIMED:
 - Call the [DescribePhoneNumber](#) API.
(`DescribePhoneNumber` can also be called in the other Region associated with the traffic distribution group. It will return the same phone number details.)

The phone number can be used by follow-up operations only after its status is CLAIMED.

For a description of possible statuses, see [Phone number statuses defined](#).

6. Repeat steps 3-5 for all phone numbers you need to claim to your traffic distribution group.
7. Perform the following steps to associate flows to phone numbers. Do them in both Regions where the traffic distribution group operates.

These steps ensure your telephony traffic will route correctly to your flows to support your traffic distribution configuration.

- a. In your existing Amazon Connect instance in the Region where the traffic distribution group was created, do the following steps:
 - i. Call [ListContactFlows](#) API. Provide the InstanceId that corresponds to the instance that was replicated.
 - ii. A list of flow ARNs is returned. Use these flow ARNs to associate a flow to a phone number; call the [AssociatePhoneNumberContactFlow](#) API.
- b. In the replicated Amazon Connect instance in the other AWS Region, do the following steps:
 - i. Call [ListContactFlows](#) API. Provide the InstanceId that corresponds to the instance that was replicated.
 - ii. A list of flow ARNs is returned. Use these flow ARNs to associate a flow to a phone number; call the [AssociatePhoneNumberContactFlow](#) API.

Why a ClaimPhoneNumber call fails

Your [ClaimPhoneNumber](#) API call will fail with a ResourceNotFoundException in the following cases:

- The specified traffic distribution group does not exist, the status of the traffic distribution group is not ACTIVE, or you do not have ownership of the traffic distribution group.
- The phone number is not available for claiming. In some cases, a phone number found from [SearchAvailablePhoneNumbers](#) may have been claimed by another customer.

[ClaimPhoneNumber](#) will fail with a InvalidParameterException error in the following case:

- The endpoint you are calling is not in the same Region where the traffic distribution group was created.

Phone number statuses defined

Following is a description of phone number statuses:

- CLAIMED means the previous [ClaimPhoneNumber](#) or [UpdatePhoneNumber](#) operation succeeded.
- IN_PROGRESS means a [ClaimPhoneNumber](#), [UpdatePhoneNumber](#) operation is still in progress and has not yet completed. You can call [DescribePhoneNumber](#) at a later time to verify if the previous operation has completed.
- FAILED indicates that the previous [ClaimPhoneNumber](#) or [UpdatePhoneNumber](#) operation has failed. It includes a message indicating the failure reason.

A common reason for a failure is that the TargetArn value you are claiming or updating a phone number to has reached its limit of total claimed numbers.

If you received a FAILED status from a ClaimPhoneNumber API call, you have one day to retry claiming the phone number before the number is released back to the inventory for other customers to claim.

Assign claimed phone numbers to traffic distribution groups

- You created a new traffic distribution group and its status is ACTIVE. We recommend using the [DescribeTrafficDistributionGroup](#) API to verify the status.
- You have already claimed phone numbers to instances or other traffic distribution groups.

Now you can assign those claimed phone numbers to your new traffic distribution group by using the [UpdatePhoneNumber](#) API. Provide the traffic distribution group ARN in the TargetArn parameter.

Note

To update the **Description** field, you must use the Amazon Connect console.

Example workflow

Following is an example workflow to assign claimed phone numbers to your traffic distribution group:

1. Call the [UpdatePhoneNumber](#) API to assign the phone number to a new `TargetArn`.

The `TargetArn` can be for another Amazon Connect instance or for a traffic distribution group created in the same Region where the phone number was initially claimed.

2. Perform the following steps to associate flows to phone numbers. Do them in both Regions where the traffic distribution group operates.

These steps ensure your telephony traffic will route correctly to your flows to support your traffic distribution configuration.

- a. In your existing Amazon Connect instance in the Region where the traffic distribution group was created, do the following steps:
 - i. Call the [ListContactFlows](#) API. Provide the `InstanceId` that corresponds to the instance that was replicated.
 - ii. A list of flow ARNs is returned. Use these flow ARNs to associate a flow to a phone number; call the [AssociatePhoneNumberContactFlow](#) API.
- b. In the replicated Amazon Connect instance in the other Region, do the following steps:
 - i. Call the [ListContactFlows](#) API. Provide the `InstanceId` that corresponds to the instance that was replicated.
 - ii. A list of flow ARNs is returned. Use these flow ARNs to associate a flow to a phone number; call the [AssociatePhoneNumberContactFlow](#) API.

Why an `AssociatePhoneNumberContactFlow` call fails

If the number is claimed to a traffic distribution group, and you are calling [AssociatePhoneNumberContactFlow](#) using an instance in the AWS Region where the traffic distribution group was created, you can use either a full phone number ARN or UUID value for the `PhoneNumberId` URI request parameter.

However, if the number is claimed to a traffic distribution group and you are calling this API using an instance in the replica AWS Region associated with the traffic distribution group, you

must provide a full phone number ARN. If a UUID is provided in this scenario, you will receive a `ResourceNotFoundException`.

Why an `UpdatePhoneNumber` call fails

Your [UpdatePhoneNumber](#) API call will fail with a `ResourceNotFoundException` in the following case:

- The specified traffic distribution group does not exist, the status of the traffic distribution group is not `ACTIVE`, or you do not have ownership of the traffic distribution group.

[UpdatePhoneNumber](#) will fail with a `InvalidParameterException` error in the following case:

- The endpoint you are calling is not in the same Region where the traffic distribution group was created.

Phone number statuses defined

Following is a description of phone number statuses:

- `CLAIMED` means the previous [ClaimPhoneNumber](#) or [UpdatePhoneNumber](#) operation succeeded.
- `IN_PROGRESS` means a [ClaimPhoneNumber](#), [UpdatePhoneNumber](#) operation is still in progress and has not yet completed. You can call [DescribePhoneNumber](#) at a later time to verify if the previous operation has completed.
- `FAILED` indicates that the previous [ClaimPhoneNumber](#) or [UpdatePhoneNumber](#) operation has failed. It includes a message indicating the failure reason. A common reason for a failure is that the `TargetArn` value you are claiming or updating a phone number to has reached its limit of total claimed numbers.

Update telephony traffic distribution across AWS Regions

You use the [UpdateTrafficDistribution](#) API to distribute telephony traffic and [shift agents](#) across Regions.

After you have claimed phone numbers to your traffic distribution group, you can use the [UpdateTrafficDistribution](#) API to distribute inbound voice contacts across linked instances in a given traffic distribution group in 10% increments.

If the following requirements are not met, your [UpdateTrafficDistribution](#) API call will fail with an `InvalidRequestException`:

- You must provide distribution for telephony traffic configuration.
- You must specify the traffic distribution for both linked instances and the total distribution must add up to 100%.
- You must specify traffic distribution in 10% increments.
- The instance ARNs specified in the telephony configuration must match the ARNs of the linked instances.

When you call `UpdateTrafficDistribution` from the source AWS Region you can use either the traffic distribution group ID or Amazon Resource Name (ARN). When you call `UpdateTrafficDistribution` in the replica Region, you must use the traffic distribution group ARN.

Set up your agent's experience with Amazon Connect Global Resiliency

Amazon Connect Global Resiliency enables you to provide a global experience for agents with global sign-in, agent distribution API, and Agent Workspace enhancements. With this set of features, you can:

- Enable your agents to sign in once at the beginning of their day and process contacts from their current active Region without needing to know which Region is active at any time.
- Add agents to your traffic distribution group and distribute agents across AWS Regions.
- Redirect new inbound voice contacts to the agent workspace for the current active Region with a simple page refresh.

Contents

- [Integrate your identity provider \(IdP\) with an Amazon Connect Global Resiliency SAML sign in endpoint](#)
- [Associate agents to instances across multiple AWS Regions](#)
- [Update agent distribution across AWS Regions](#)
- [Set up Amazon Connect Agent Workspace to support agents shifting across AWS Regions](#)
- [Tips for avoiding issues when shifting agents across Regions](#)

Integrate your identity provider (IdP) with an Amazon Connect Global Resiliency SAML sign in endpoint

To enable your agents to sign in once and be logged into both AWS Regions to process contacts from the current active Region, you need to configure IAM settings to use the global sign in SAML endpoint.

Before you begin

You must enable SAML for your Amazon Connect instance to use Amazon Connect Global Resiliency. For information about getting started with IAM federation, see [Enabling SAML 2.0 federated users to access the AWS Management Console](#).

Important things to know

- To perform the steps in this topic, you'll need your instance ID. For instructions about how to find it, see [Find your Amazon Connect instance ID/ARN](#).
- You will also need to know the source Region of your Amazon Connect instances. For instructions about how to find it, see [How to find the source Region of your Amazon Connect instances](#).
- If you are embedding your Connect application within an iframe, you must ensure that your domain is present in the list of Approved Origins in both your source and replica instance in order for global sign-in to work.

To configure Approved Origins at the instance level, follow the steps in [Use an allowlist for integrated applications](#).

- Agents must be created already in *both* your source and replica Amazon Connect instances and have the same username as the role session name from your identity provider (IdP). Otherwise, you will receive a `UserNotOnboardedException` exception and risk losing agent redundancy capabilities between your instances.
- You must associate agents to a traffic distribution group before agents attempt to sign in. Otherwise agent sign-in will fail with a `ResourceNotFoundException`. For information about how to setup your traffic distribution groups and associate agents to them, see [Associate agents to instances across multiple AWS Regions](#).
- When your agents federate into Amazon Connect with the new SAML sign-in URL, Amazon Connect Global Resiliency always attempts to log the agent into both your source and replica Regions / instances, no matter how `SignInConfig` is configured in your traffic distribution group. You can verify this by checking CloudTrail logs.

- The `SignInConfig` distribution in your default traffic distribution group only determines which AWS Region is used to facilitate sign-in. Regardless of how your `SignInConfig` distribution is configured, Amazon Connect always attempts to sign in agents to both Regions of your Amazon Connect instance.
- After replicating an Amazon Connect instance, only one SAML sign-in endpoint is generated for your instances. This endpoint always contains the source AWS Region in the URL.
- You don't need to configure a relay state when using the personalized SAML sign-in URL with Amazon Connect Global Resiliency.

How to integrate your identity provider

1. When you create a replica of your Amazon Connect instance using the [ReplicateInstance](#) API, a personalized SAML sign-in URL is generated for your Amazon Connect instances. The URL is generated in the following format:

`https://instance-id.source-region.sign-in.connect.aws/saml`

- a. *instance-id* is the instance ID for either instance in your instance group. The instance ID is identical in the source and replica Regions.
 - b. *source-region* corresponds to the source AWS Region in which the [ReplicateInstance](#) API was called.
2. Add the following trust policy to your IAM Federation role. Use the URL for the global sign-in SAML endpoint as shown in the following example.

```
{
  "Version": "2012-10-17",
  "Statement": [
    {
      "Effect": "Allow",
      "Principal": {
        "Federated": [
          "saml-provider-arn"
        ]
      },
      "Action": "sts:AssumeRoleWithSAML",
      "Condition": {
        "StringLike": {
          "SAML:aud": [
            "https://instance-id.source-region.sign-in.connect.aws/saml*"
          ]
        }
      }
    }
  ]
}
```

```

    ]
  }
}
]
}

```

Note

`saml-provider-arn` is the identity provider resource created in IAM.

- Grant access to `connect:GetFederationToken` for your `InstanceId` on your IAM Federation role. For example:

```

{
  "Version": "2012-10-17",
  "Statement": [
    {
      "Sid": "GetFederationTokenAccess",
      "Effect": "Allow",
      "Action": "connect:GetFederationToken",
      "Resource": "*",
      "Condition": {
        "StringEquals": {
          "connect:InstanceId": "your-instance-id"
        }
      }
    }
  ]
}

```

- Add an attribute mapping to your identity provider application using the following attribute and value strings.

Attribute	Value
<code>https://aws.amazon.com/SAML/Attributes/Role</code>	<code><i>saml-role-arn</i> ,<i>identity-provider-arn</i></code>

5. Configure the Assertion Consumer Service (ACS) URL of your identity provider to point to your personalized SAML sign-in URL. Use the following example for the ACS URL:

```
https://instance-id.source-region.sign-in.connect.aws/saml?&instanceId=instance-id&accountId=your AWS account ID&role=saml-federation-role&idp=your SAML IDP&destination=optional-destination
```

6. Set following fields in the URL parameters:

- `instanceId`: The identifier of your Amazon Connect instance. For instructions about how to find your instance ID, see [Find your Amazon Connect instance ID/ARN](#).
- `accountId`: The AWS account ID where the Amazon Connect instances are located.
- `role`: Set to the name or Amazon Resource Name (ARN) of the SAML role used for Amazon Connect federation.
- `idp`: Set to the name or Amazon Resource Name (ARN) of the SAML identity provider in IAM.
- `destination`: Set to the optional path where agents will land in the instance after signing in (for example: `/agent-app-v2`).

Associate agents to instances across multiple AWS Regions

To allow your agents to sign-in to both AWS Regions and process contacts from either Region, you must first assign them to a traffic distribution group.

1. If you have not yet set up a traffic distribution group, do so now. For instructions, see [Create traffic distribution groups](#).
2. After your traffic distribution group is created successfully (Status is ACTIVE), you can assign agents to it. Always associate users to a traffic distribution group in the source Region.

Assigning an agent to a traffic distribution group without an ACTIVE status results in `ResourceNotFoundException`. Use the [DescribeTrafficDistributionGroup](#) API to determine whether it has been created successfully (Status must be ACTIVE).

3. You can assign an agent to a traffic distribution group by calling the [AssociateTrafficDistributionGroupUser](#) API.

Examples

The following `associate-traffic-distribution-group-user` example command shows how agents can be associated to and used across multiple AWS Regions.

```
aws connect associate-traffic-distribution-group-user
--traffic-distribution-group-id UUID
--user-id UUID
--instance-id
```

The following [AssociateTrafficDistributionGroupUser](#) example associates an agent with a traffic distribution group.

```
PUT /traffic-distribution-group/trafficDistributionGroupId/user HTTP/1.1
Content-type: application/json

{
  "UserId": "string"
}
```

The following `disassociate-traffic-distribution-group-user` example command disassociates an agent from a traffic distribution group.

```
aws connect disassociate-traffic-distribution-group-user
--instance-id your instance ID
--traffic-distribution-group-id UUID
--user-id UUID
```

The following [DisassociateTrafficDistributionGroupUser](#) example disassociates an agent from a traffic distribution group.

```
DELETE /traffic-distribution-group/trafficDistributionGroupId/user/UserId HTTP/1.1
```

Why an AssociateTrafficDistributionGroupUser call fails

An [AssociateTrafficDistributionGroupUser](#) API call fails with a `ResourceNotFoundException` in the following cases:

1. The specified traffic distribution group does not exist.
2. The status of the traffic distribution group is not ACTIVE.
3. The user-id *UUID* is not a user from the source Amazon Connect instance.

Update agent distribution across AWS Regions

Just as you can use the `UpdateTrafficDistribution` API to [distribute telephony traffic across Regions](#), you can also use it to distribute agents across AWS Regions, either fully or gradually as part of regular operational readiness testing. For example, you might keep 40% of agents in one AWS Region to complete active contacts and shift the remaining agents to the replica Region.

After you have added agents to your traffic distribution group, use the [UpdateTrafficDistribution](#) API to distribute agents across linked instances in a given traffic distribution group in 10% increments. Your agents will be able to complete active voice contacts before shifting Regions.

Note

If an agent gets an error when they try to end a contact before shifting Regions, they need to refresh the agent workspace page. For more information, see [Set up Amazon Connect Agent Workspace to support agents shifting across AWS Regions](#).

Contents

- [Requirements](#)
- [Change sign-in weights](#)
- [How to shift all telephony traffic and agents across AWS Regions](#)

Requirements

If the following requirements are not met, your [UpdateTrafficDistribution](#) API call will fail with an `InvalidRequestException`:

1. The specified traffic distribution group must exist.
2. The status of the traffic distribution group must be `ACTIVE`.
3. If you are changing the `SignInConfig` distribution, you can only do so for the default traffic distribution group. The default traffic distribution group is created when the replica Amazon Connect instance is created. See the `IsDefault` parameter in the [TrafficDistributionGroup](#) data type.

When you call `UpdateTrafficDistribution` from the source AWS Region you can use either the traffic distribution group ID or Amazon Resource Name (ARN). When you call

UpdateTrafficDistribution in the replica Region, you must use the traffic distribution group ARN.

Change sign-in weights

The UpdateTrafficDistribution API includes a distribution called SignInConfig. It allows you to choose which backend sign-in servers are used to facilitate the agent signing in to their instance group. Regardless of the SignInConfig set in your traffic distribution group, agents will be signed in to both instances in the traffic distribution group.

For the best experience, we recommend having both AWS Regions enabled during regular operations. To achieve this pass `true` to both SignInConfig distributions. If you need to shift your entire telephony traffic and agents across to one AWS Region, we recommend changing the SignInConfig to `false` for the Region you are shifting traffic away from.

For example, the following call results in agents having a 50% chance of using the us-west-2 sign-in server and a 50% of using the us-east-1 sign-in server for a given login call from the identity provider.

```
aws connect update-traffic-distribution \  
--id traffic distribution group ID or ARN \  
--cli-input-json \  
'{  
  "SignInConfig":{  
    "Distributions":[  
      {  
        "Region":"us-west-2",  
        "Enabled":true  
      },  
      {  
        "Region":"us-east-1",  
        "Enabled":true  
      }  
    ]  
  }  
'
```

Conversely, the following sign-in distribution routes 100% of traffic on the sign-in endpoint to use the us-east-1 sign-in server.

```
aws connect update-traffic-distribution \  

```



```
--id traffic distribution group ID or ARN \  
--cli-input-json \  
{  
  "SignInConfig":{  
    "Distributions":[  
      {  
        "Region":"us-west-2",  
        "Enabled":false  
      },  
      {  
        "Region":"us-east-1",  
        "Enabled":true  
      }  
    ]  
  }  
}
```

This distribution controls only which Region of the sign-in server is used to facilitate logging in the agent to both instances in their instance group. It doesn't affect the distribution of agents controlled by the AgentConfig part of the UpdateTrafficDistribution API.

Important

If the sign-in endpoint is not responsive during agent sign-in and your SignInConfig distribution is split across Regions, then you can resolve the errors by changing distribution to a single AWS Region. Or, if your SignInConfig is weighted on one Region and it isn't responsive, you can try shifting the SignInConfig to the disabled Region. Regardless of how your SignInConfig is configured, agents will still benefit from having a session active in both the source and replica Regions because they will attempt to sign into their Amazon Connect instance in both Regions.

How to shift all telephony traffic and agents across AWS Regions

To shift all new inbound voice contacts, agent sign-in distribution, and agent distribution from us-west-2 to us-east-1, use the following code snippet.

```
aws connect update-traffic-distribution \  
--id traffic distribution group ID or ARN \  
--cli-input-json \  
{
```

```

"SignInConfig":{
  "Distributions":[
    {
      "Region":"us-west-2",
      "Enabled":false
    },
    {
      "Region":"us-east-1",
      "Enabled":true
    }
  ]
},
"AgentConfig":{
  "Distributions":[
    {
      "Region":"us-west-2",
      "Percentage":0
    },
    {
      "Region":"us-east-1",
      "Percentage":100
    }
  ]
},
"TelephonyConfig":{
  "Distributions":[
    {
      "Region":"us-west-2",
      "Percentage":0
    },
    {
      "Region":"us-east-1",
      "Percentage":100
    }
  ]
}
}
'

```

When you call `UpdateTrafficDistribution` from the source AWS Region you can use either the traffic distribution group ID or Amazon Resource Name (ARN). When you call `UpdateTrafficDistribution` in the replica Region, you must use the traffic distribution group ARN.

Set up Amazon Connect Agent Workspace to support agents shifting across AWS Regions

Perform the following steps to enable Amazon Connect Agent Workspace to embed the Contact Control Panel from the replica AWS Region to the source Region, and shift between them as agent's active Region changes.

If you have not yet created a replica of your source Amazon Connect instance or set up a traffic distribution group, see [Get started with Amazon Connect Global Resiliency](#).

1. Go to the AWS Amazon Connect console to retrieve the **Access URL** for your source instance. Make a note of the URL.
2. In the replica Region, AWS Amazon Connect console to retrieve the **Access URL** for your replica instance. Make a note of the URL.
3. In the same window for your replica Amazon Connect instance, in the left pane choose **Approved origins**.
4. Add domain for source instance **Access URL**, which you noted in step 1.

Note

Do not include a trailing / in the access URL.

5. Repeat the above steps on your source instance: Go to **Approved origins**, add the access URL for the replica instance.

Note

Agents must set their status to **Available** after they are shifted across Regions.

Tips for avoiding issues when shifting agents across Regions

- Whenever you update the traffic distribution for agents be sure to also update the traffic distribution for inbound voice contacts. Otherwise, you might end up in a situation where one Region is heavy on agents while the other is heavy on telephony traffic.
- Before associating users to a traffic distribution group, make sure the same username exists in both the source and replica Amazon Connect instances. Otherwise, when you associate a user to

a traffic distribution group but the user with the username does not exist in the replica Region, you will get an `InvalidRequestException` error.

- You must call the [AssociateTrafficDistributionGroupUser](#) API to associate agents to a traffic distribution group in the source Region. If you attempt to do this while in the replica Region, you will get a `ResourceNotFoundException` error.

Manage traffic distribution groups

The topics in this section describe how to manage traffic distribution groups by using Amazon Connect APIs.

Contents

- [List traffic distribution groups](#)
- [Delete traffic distribution groups](#)

List traffic distribution groups

Use the [ListTrafficDistributionGroups](#) API to list all traffic distribution groups.

You may want to list traffic distribution groups as a way of determining whether a particular Amazon Connect instance is part of any traffic distribution groups.

Delete traffic distribution groups

Use the [DeleteTrafficDistributionGroup](#) API to delete a traffic distribution group that is no longer needed.

Note

You cannot delete a traffic distribution group if phone numbers are claimed to it. You must first release phone numbers from the traffic distribution group by using the [ReleasePhoneNumber](#) API. After that, you can delete the traffic distribution group. You cannot release numbers from a traffic distribution group by using the Amazon Connect console.

Your [DeleteTrafficDistributionGroup](#) API call will fail with an `ResourceInUseException` if phone numbers are still claimed to the traffic distribution group.

Manage phone numbers across Regions

The topics in this section describe how to manage phone numbers across AWS Regions by using Amazon Connect APIs.

Contents

- [Claim phone numbers to instances across multiple AWS Regions](#)
- [Move a claimed phone number to multiple instances across AWS Regions](#)
- [Release numbers from traffic distribution groups](#)

Claim phone numbers to instances across multiple AWS Regions

Note

This feature is available only for Amazon Connect instances created in the following AWS Regions: US East (N. Virginia), US West (Oregon), Europe (Frankfurt), and Europe (London). You can only create a replica in the US East (N. Virginia) Region if your source is US West (Oregon), or the other way around. Similarly, you can only create a replica in the Europe (Frankfurt) Region if your source is Europe (London), or the other way around. To obtain access to this feature, contact your Amazon Connect Solutions Architect or Technical Account Manager.

To place or receive calls to a phone number across instances in multiple AWS Regions, you need to claim a phone number to a traffic distribution group.

To claim a phone number to a traffic distribution group

1. Create a traffic distribution group by using the [CreateTrafficDistributionGroup](#) API.
2. Describe your traffic distribution group by using the [DescribeTrafficDistributionGroup](#) API to determine whether it has been created successfully (Status must be ACTIVE).
3. After your traffic distribution group has been created successfully (Status is ACTIVE), you can claim phone numbers to it by using the [ClaimPhoneNumber](#) API.

Move a claimed phone number to multiple instances across AWS Regions

Note

This feature is available only for Amazon Connect instances created in the following AWS Regions: US East (N. Virginia), US West (Oregon), Europe (Frankfurt), and Europe (London). You can only create a replica in the US East (N. Virginia) Region if your source is US West (Oregon), or the other way around. Similarly, you can only create a replica in the Europe (Frankfurt) Region if your source is Europe (London), or the other way around. To obtain access to this feature, contact your Amazon Connect Solutions Architect or Technical Account Manager.

You can move a phone number that was previously claimed to an instance, and instead assign it to multiple instances across AWS Regions. You do this by assigning the phone number to a traffic distribution group.

To assign a phone number to a traffic distribution group

1. Create a traffic distribution group using the [CreateTrafficDistributionGroup](#) API.
2. Describe your traffic distribution group using the [DescribeTrafficDistributionGroup](#) API to determine whether it has been created successfully (Status must be ACTIVE).
3. After your traffic distribution group is created successfully (Status is ACTIVE), you can assign phone numbers that were previously claimed to other instances or other traffic distribution groups. Use the [UpdatePhoneNumber](#) API.

Release numbers from traffic distribution groups

To release phone numbers from a traffic distribution group, use the [ReleasePhoneNumber](#) API. The number is released back to inventory for other customers to claim it.

You cannot release numbers from a traffic distribution group by using the Amazon Connect console.

Manage chat across Regions

You manage chat across AWS Regions by creating two custom chat interfaces or two out-of-the-box communication widgets: one in the source Region and another in the replica Region. You manually switch between them depending on which Region's chat interface or out-of-the-box communication widget you want to use.

- **Custom chat interfaces:** Configure the chat interface in the replica Region to use the API endpoint of the replica Region.
- **Out-of-the-box communication widgets:** Create a communication widget in the replica Amazon Connect instance. For instructions, see [Configure a communication widget in the replica instance](#).

Following are the chat configuration parameters that are required in your website or app to initiate a client side chat:

- **Amazon Connect instance ID** and **flow ID:** These parameters are the same in the source and replica Regions.
- **Target AWS Region** and usually an **API endpoint** to start the chat (that is, to acquire the participant token): These parameters are different in the source and replica Regions.

For example, the following image shows two sample ChatConfig files for a website: one ChatConfig file is for the source Region (labeled USWest2 in the image) and the other ChatConfig file is for the replica Region (labeled USEast1 in the image).



```
7
8
9
10
11 class ChatConfig {
12     // Chat Interactive
13     let startChatEndPoint: String = "https://[redacted].execute-api.us-west-2.amazonaws.com/Prod/"
14     let instanctId: String = "[redacted]"
15     let contactFlowId: String = "[redacted]"
16     let region: AWSRegionType = .USWest2
17
7
8
9
10
11 class ChatConfig {
12     // Chat Interactive
13     let startChatEndPoint: String = "https://[redacted].execute-api.us-east-1.amazonaws.com/Prod/"
14     let instanctId: String = "[redacted]"
15     let contactFlowId: String = "[redacted]"
16     let region: AWSRegionType = .USEast1
17
```

Configure a communication widget in the replica instance

1. On your source Amazon Connect instance, create a communication widget for chat if one doesn't already exist. For instructions, see [Add a chat user interface to your website](#).
2. On your replica instance, create another communication widget for chat. Configure the widget with the same flow that is used in the widget on the source instance. The flow is already in the replica instance because Amazon Connect Global Resiliency copies all flows from the source to replica and keeps them continuously synchronized.
3. Copy the new communication widget script that you created in the replica instance. Embed the script on the website or app that should be activated when chat traffic is forwarded to the replica instance.

The following image shows an example widget script.

Widget script

Copy this generated code and paste it on each page of your website where you want the communication widget to appear.

```
<script type="text/javascript">
(function(w, d, x, id){
  s=d.createElement('script');
  s.src='https://dg9yx063wiiht.cloudfront.net/amazon-connect-chat-interface-client.js';
  s.async=1;
  s.id=id;
  d.getElementsByTagName('head')[0].appendChild(s);
  w[x] = w[x] || function() { (w[x].ac = w[x].ac || []).push(arguments) };
})(window, document, 'amazon_connect', 'XXXXXXXXXXXXXXXXXXXX');
amazon_connect('styles', { iconType: 'CHAT', openChat: { color: '#ffffff', backgroundColor: '#123456' }, closeChat: { color: '#ffffff', backgroundColor: '#123456' } });
amazon_connect('snippetId', 'XXXXXXXXXXXX');
amazon_connect('supportedMessagingContentTypes', [ 'text/plain', 'text/markdown' ]);
</script>
```

4. If you make any changes to the communication widget in the source instance at a later time, you also need to make the same changes in the communication widget in the replica instance.

Option to add more seamlessness

To make shifting chat traffic across Regions more seamless, and to require fewer manual changes, following is another way you can customize your chat experience:

1. Add a parameter to a centrally controlled database (for example, DynamoDB Global Table). The purpose of this parameter is to define which Region is currently active.
2. Update your website or application to check the status of the Region parameter in the central database.
3. Depending on which Region is active, the website or application will use that Region's API endpoint or communication widget.
4. This parameter should be updated at the same time that the [UpdateTrafficDistribution](#) API is called to shift voice traffic and agents across Regions where applicable.

Set up your network

Traditional VoIP solutions require you to allow both inbound and outbound for specific UDP port ranges and IPs, such as 80 and 443. These solutions also apply to TCP. In comparison, the network requirements for using the Contact Control Panel (CCP) with a softphone are less intrusive. You can establish persistent outbound send/receive connections through your web browser. As a result, you don't need to open a client-side port to listen for inbound traffic.

The following diagram shows you what each port is used for.

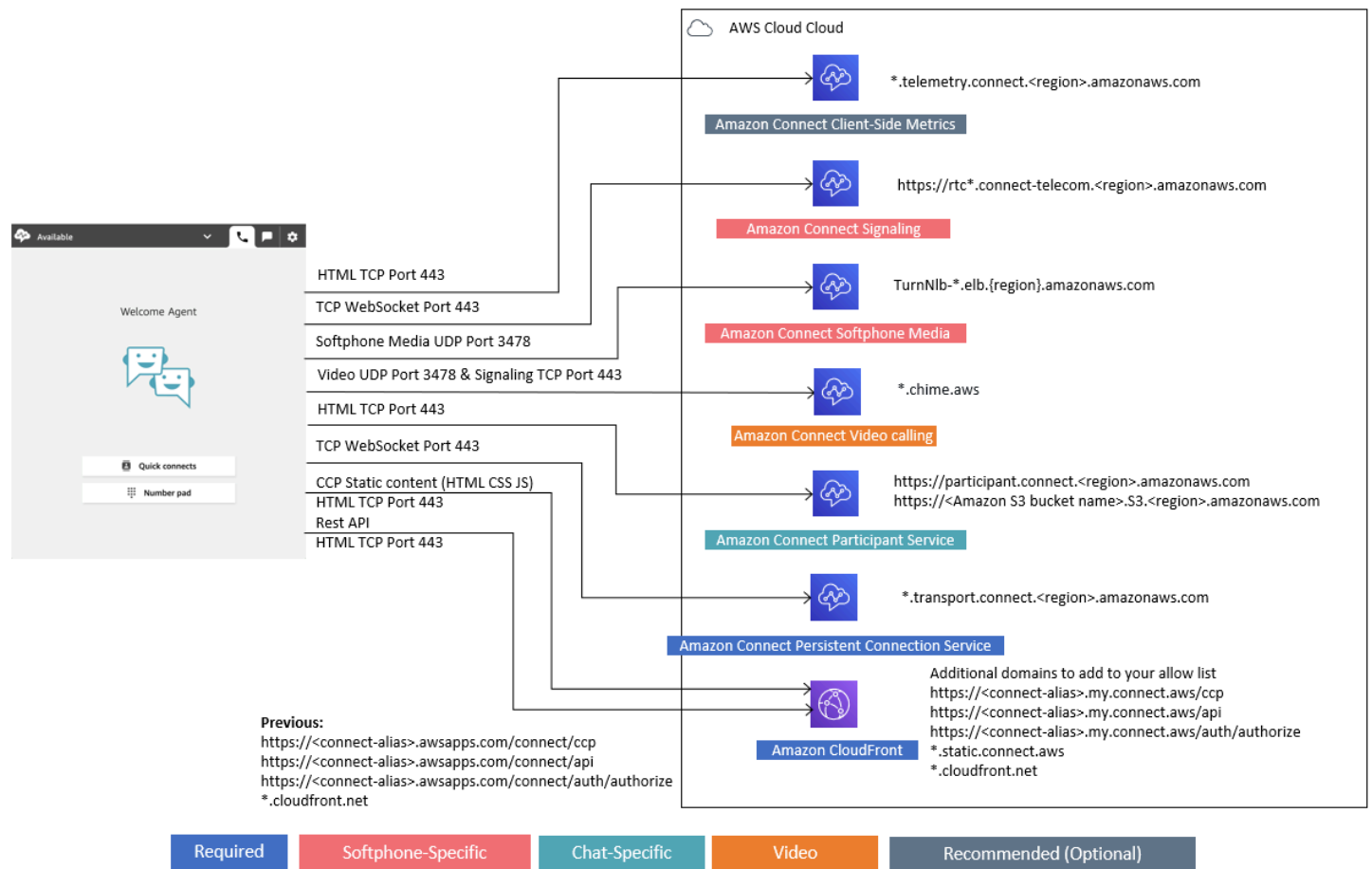

The following sections describe the two primary connectivity options for using the CCP.

Contents

- [Option 1 \(recommended\): Replace Amazon EC2 and CloudFront IP range requirements with a domain allowlist](#)
- [Option 2 \(not recommended\): Allow IP address ranges](#)
- [About Amazon Connect IP address ranges](#)

- [Stateless firewalls](#)
- [Allow upload of time-off balances and allowances in Amazon Connect scheduling](#)
- [Allow DNS resolution for softphones](#)
- [Port and protocol considerations](#)
- [Region selection considerations](#)
- [Agents using Amazon Connect remotely](#)
- [Rerouting audio](#)
- [Using AWS Direct Connect](#)
- [Agent workstation networking requirements for web calling voice/video](#)
- [Detailed network paths for Amazon Connect](#)
- [Use Amazon Connect in a VDI environment](#)
- [CCP connectivity](#)
- [Use an allowlist for integrated applications](#)
- [Update your Amazon Connect domain](#)

Option 1 (recommended): Replace Amazon EC2 and CloudFront IP range requirements with a domain allowlist

This first option lets you significantly reduce your blast radius.

We recommend trying Option 1 and testing it with more than 200 calls. Test for softphone errors, dropped calls, and conference/transfer functionality. If your error rate is greater than 2 percent, there might be an issue with proxy resolution. If that's the case, consider using Option 2.

To allow traffic for Amazon EC2 endpoints, allow access for the URL and port, as shown in the first row of the following table. Do this instead of allowing all of the IP address ranges listed in the ip-ranges.json file. You get the same benefit using a domain for CloudFront, as shown in the second row of the following table.

Domain/URL allowlist	AWS Region	Ports	Direction	Traffic
rtc*.connect-telec	Replace <i>region</i> with the Region	443 (TCP)	OUTBOUND	SEND/RECEIVE

Domain/URL allowlist	AWS Region	Ports	Direction	Traffic
om. <i>region</i> .amazon.com This is used by ccp# (v1). Please see the note following this table.	where your Amazon Connect instance is located			

Domain/URL allowlist	AWS Region	Ports	Direction	Traffic
<p>Following is the minimum allowlist for *.my.connect.aws:</p> <ul style="list-style-type: none"> • <i>myInstanceName</i> .my.connect.aws/ccp-v2 • <i>myInstanceName</i> .my.connect.aws/api • <i>myInstanceName</i> .my.connect.aws/auth/authorize • *.static.connect.aws • *.cloudfront.net <p>Following is the minimum allowlist for *.awsapps.com:</p> <ul style="list-style-type: none"> • <i>myInstanceName</i> .awsapps.com/connect/ccp-v2 • <i>myInstanceName</i> .awsapps.com 	<p>Replace <i>myInstanceName</i> with the alias of your Amazon Connect instance</p>	<p>443 (TCP)</p>	<p>OUTBOUND</p>	<p>SEND/RECEIVE</p>

Domain/URL allowlist	AWS Region	Ports	Direction	Traffic
<ul style="list-style-type: none"> com/connect/api <i>myInstanceName</i>.awsapp.com/connect/auth/authorize *.cloudfront.net 				
*.telemetry.connect.region.amazonaws.com	Replace <i>region</i> with the location of your Amazon Connect instance	443 (TCP)	OUTBOUND	SEND/RECEIVE
participant.connect.region.amazonaws.com	Replace <i>region</i> with the location of your Amazon Connect instance	443 (TCP)	OUTBOUND	SEND/RECEIVE
*.transport.connect.region.amazonaws.com This is used by ccp-v2.	Replace <i>region</i> with the location of your Amazon Connect instance	443 (TCP)	OUTBOUND	SEND/RECEIVE

Domain/URL allowlist	AWS Region	Ports	Direction	Traffic
<i>Amazon S3 bucket name.s3.region.amazonaws.com</i>	Replace <i>Amazon S3 bucket name</i> with the name of the location where you store attachments. Replace <i>region</i> with the location of your Amazon Connect instance	443 (TCP)	OUTBOUND	SEND/RECEIVE
TurnNlb-*.elb. <i>region</i> .amazon.com To instead add specific endpoints to your allowlist based on Region, see NLB endpoints .	Replace <i>region</i> with the location of your Amazon Connect instance	3478 (UDP)	OUTBOUND	SEND/RECEIVE

Domain/URL allowlist	AWS Region	Ports	Direction	Traffic
GLOBALACC ELERATOR	GLOBAL and Region where your Amazon Connect instance is located (add GLOBAL AND any region-specific entry to your allow list)	443 (HTTPS) and 80 (HTTP)	OUTBOUND	SEND/RECEIVE
<i>instance-id.source-region</i> .sign-in.connect.aws This is used only if you have onboarded to Amazon Connect Global Resiliency .	Replace <i>instance-id</i> with your instance ID, and <i>source-region</i> with the AWS Region of your source instance. For more information, see Integrate your identity provider (IdP) with an Amazon Connect Global Resiliency SAML sign in endpoint .	443 (HTTPS)	OUTBOUND	SEND/RECEIVE

Domain/URL allowlist	AWS Region	Ports	Direction	Traffic
<p><i>*.source-region</i>.region-discovery.connect.aws</p> <p>This is needed only if you have onboarded to Amazon Connect Global Resiliency.</p>	<p>Replace <i>source-region</i> with the AWS Region of your source instance. For instructions about how to find your source Region, see How to find the source Region of your Amazon Connect instances.</p>	443 (HTTPS)	OUTBOUND	SEND/RECEIVE

Fully qualified domain names (FQDNs) cannot be changed or customized on a per-customer basis. Instead, use [Option 2 - allow IP address ranges](#).

Tip

When using `rtc*.connect-telecom.region.amazonaws.com`, `*.transport.connect.region.amazonaws.com`, and `https://myInstanceName.awsapps.com`, in certain proxy applications, web socket handling may impact functionality. Be sure to test and validate before deploying to a production environment.

The following table lists the CloudFront domains used for static assets if you want to add domains to your allowlist instead of IP ranges:

Region	CloudFront Domain
us-east-1	https://dd401jc05x2yk.cloudfront.net/ https://d1f0uslncy85vb.cloudfront.net/
us-west-2	https://d38fzyjx9jg8fj.cloudfront.net/ https://d366s8lxuwna4d.cloudfront.net/
ap-northeast-1	https://d3h58onr8hrozv.cloudfront.net/ https://d13ljas036gz6c.cloudfront.net/
ap-northeast-2	https://d11ouwvqqq1ads.cloudfront.net/
ap-southeast-1	https://d2g7up6vqvaq2o.cloudfront.net/ https://d12o1dl1h4w0xc.cloudfront.net/
ap-southeast-2	https://d2190hliw27bb8.cloudfront.net/ https://d3mgrlqzmisc5.cloudfront.net/
eu-central-1	https://d1n9s7btyr4f0n.cloudfront.net/ https://d3tqoc05lsydd3.cloudfront.net/
eu-west-2	https://dl32tyuy2mmv6.cloudfront.net/ https://d2p8ibh10q5exz.cloudfront.net/

 **Note**

ca-central isn't included in the table because we host static contents behind the domain `*.my.connect.aws`.

If your business does not use SAML, and you have firewall restrictions, you can add the following entries per Region:

Region	CloudFront Domain
us-east-1	https://d32i4gd7pg4909.cloudfront.net/
us-west-2	https://d18af777lco7lp.cloudfront.net/
eu-west-2	https://d16q6638mh01s7.cloudfront.net/
ap-northeast-1	https://d2c2t8mxjq5z1.cloudfront.net/
ap-northeast-2	https://d9j3u8qaxidxi.cloudfront.net/
ap-southeast-1	https://d3qzmd7y07pz0i.cloudfront.net/
ap-southeast-2	https://dwcpxuza83q.cloudfront.net/
eu-central-1	https://d1whcm49570jjw.cloudfront.net/
ca-central-1	https://d2wfbsypmqjmog.cloudfront.net/
us-gov-east-1:	https://s3-us-gov-east-1.amazonaws.com/warp-drive-console-static-content-prod-osu/
us-gov-west-1:	https://s3-us-gov-west-1.amazonaws.com/warp-drive-console-static-content-prod-pdt/

NLB endpoints

The following table lists the specific endpoints for the Region the Amazon Connect instance is in. If you don't want to use the TurnNlb-*.elb.*region*.amazonaws.com wildcard, you can add these endpoints to your allowlist instead.

Region	Turn Domain/URL
us-west-2	TurnNlb-8d79b4466d82ad0e.elb.us-west-2.amazonaws.com TurnNlb-dbc4ebb71307fda2.elb.us-west-2.amazonaws.com

Region	Turn Domain/URL
	TurnNlb-13c884fe3673ed9f.elb.us-west-2.amazonaws.com
us-east-1	TurnNlb-d76454ac48d20c1e.elb.us-east-1.amazonaws.com TurnNlb-31a7fe8a79c27929.elb.us-east-1.amazonaws.com TurnNlb-7a9b8e750cec315a.elb.us-east-1.amazonaws.com
af-south-1	TurnNlb-29b8f2824c2958b8.elb.af-south-1.amazonaws.com
ap-northeast-1	TurnNlb-3c6ddabcbe821d8.elb.ap-northeast-1.amazonaws.com
ap-northeast-2	TurnNlb-a2d59ac3f246f09a.elb.ap-northeast-2.amazonaws.com
ap-southeast-1	TurnNlb-261982506d86d300.elb.ap-southeast-1.amazonaws.com
ap-southeast-2	TurnNlb-93f2de0c97c4316b.elb.ap-southeast-2.amazonaws.com
ca-central-1	TurnNlb-b019de6142240b9f.elb.ca-central-1.amazonaws.com
eu-central-1	TurnNlb-ea5316ebe2759cbc.elb.eu-central-1.amazonaws.com
eu-west-2	TurnNlb-1dc64a459ead57ea.elb.eu-west-2.amazonaws.com
us-gov-west-1	TurnNlb-d7c623c23f628042.elb.us-gov-west-1.amazonaws.com

Option 2 (not recommended): Allow IP address ranges

The second option relies on using an allowlist to define the IP addresses and ports that Amazon Connect can use. You create this allowlist using the IP addresses in the [AWS ip-ranges.json](#) file.

If the Region you are using Amazon Connect in does not appear in the AWS ip-ranges.json file, use just the Global values.

For more information about this file, see [About Amazon Connect IP address ranges](#).

IP-Ranges entry	AWS Region	Ports/Protocols	Direction	Traffic
AMAZON_CONNECT	GLOBAL and Region where your Amazon Connect instance is located (add GLOBAL AND any region-specific entry to your allowlist)	3478 (UDP)	OUTBOUND	SEND/RECEIVE
EC2	GLOBAL and Region where your Amazon Connect instance is located (GLOBAL only if a region-specific entry doesn't exist)	443 (TCP)	OUTBOUND	SEND/RECEIVE
CLOUDFRONT	Global*	443 (TCP)	OUTBOUND	SEND/RECEIVE
GLOBALACCCELERATOR	GLOBAL and Region where your Amazon	443 (HTTPS) and 80 (HTTP)	OUTBOUND	SEND/RECEIVE

IP-Ranges entry	AWS Region	Ports/Protocols	Direction	Traffic
	Connect instance is located (add GLOBAL AND any region-specific entry to your allow list)			

*CloudFront serves static content such as images or javascript from an edge location that has the lowest latency in relation to where your agents are located. IP range allow lists for CloudFront are global and require all IP ranges associated with "service": "CLOUDFRONT" in the ip-ranges.json file.

About Amazon Connect IP address ranges

In the [AWS ip-ranges.json](#) file, the whole /19 IP address range is owned by Amazon Connect. All traffic to and from the /19 range comes to and from Amazon Connect.

The /19 IP address range isn't shared with other services. It's for the exclusive use to Amazon Connect globally.

In the AWS ip-ranges.json file, you can see the same range listed twice. For example:

```
{ "ip_prefix": "15.193.0.0/19",
  "region": "GLOBAL",
  "service": "AMAZON"
},
{
  "ip_prefix": "15.193.0.0/19",
  "region": "GLOBAL",
  "service": "AMAZON_CONNECT"
},
```

AWS always publishes any IP range twice: one for the specific service, and one for "AMAZON" service. There could even be a third listing for a more specific use case within a service.

When there are new IP address ranges supported for Amazon Connect, they are added to the publicly available `ip-ranges.json` file. They are kept for a minimum of 30 days before they are used by the service. After 30 days, softphone traffic through the new IP address ranges increases over the subsequent two weeks. After two weeks, traffic is routed through the new ranges equivalent to all available ranges.

For more information about this file and IP address ranges in AWS, see [AWS IP Address Ranges](#).

Stateless firewalls

If you're using a stateless firewall for both options, use the requirements described in the previous sections. Then you must add to your allowlist the ephemeral port range used by your browser, as shown in the following table.

IP-Range entry	Port	Direction	Traffic
AMAZON_CONNECT	For a Windows environment: 49152-65535 (UDP) For a Linux environment: 32768 - 61000	INBOUND	SEND/RECEIVE

Allow upload of time-off balances and allowances in Amazon Connect scheduling

To allow upload of time-off balances and allowances in Amazon Connect scheduling, add the following upload endpoints to your proxy exception list:

- [https://bm-prod-*region*-cell-1-uploads-service-staging.s3.*region*.amazonaws.com](https://bm-prod-<i>region</i>-cell-1-uploads-service-staging.s3.<i>region</i>.amazonaws.com)
- [https://bm-prod-*region*-cell-2-uploads-service-staging.s3.*region*.amazonaws.com](https://bm-prod-<i>region</i>-cell-2-uploads-service-staging.s3.<i>region</i>.amazonaws.com)

For more information about the activities these endpoints support, see the following topics:

- [Set group allowance for time off](#)

- [Import an agent's time off balance in a .csv file](#)

Allow DNS resolution for softphones

If you already added Amazon Connect IP ranges to your allowlist, and you don't have any restriction on DNS name resolution, then you don't need to add **TurnNlb-*.elb.region.amazonaws.com** to your allowlist.

- To check whether there are restrictions on DNS name resolution, while on your network, use the `nslookup` command. For example:

```
nslookup TurnNlb-d76454ac48d20c1e.elb.us-east-1.amazonaws.com
```

If you can't resolve the DNS, you must add the TurnNLB endpoints [listed above](#) or **TurnNlb-*.elb.region.amazonaws.com** to your allowlist.

If you don't allow this domain, your agents will get the following error in their Contact Control Panel (CCP) when they try to answer a call:

- Failed to establish softphone connection. Try again or contact your administrator with the following: Browser unable to establish media channel with turn:TurnNlb-xxxxxxxxxxxxx.elb.region.amazonaws.com:3478?transport=udp

Port and protocol considerations

Consider the following when implementing your network configuration changes for Amazon Connect:

- You need to allow traffic for all addresses and ranges for the Region in which you created your Amazon Connect instance.
- If you are using a proxy or firewall between the CCP and Amazon Connect, increase the SSL certificate cache timeout to cover the duration of an entire shift for your agents. Do this to avoid connectivity issues with certificate renewals during their scheduled working time. For example, if your agents are scheduled to work 8 hour shifts that include breaks, increase the interval to 8 hours plus time for breaks and lunch.
- When opening ports, Amazon EC2 and Amazon Connect require only the ports for endpoints in the same Region as your instance. CloudFront, however, serves static content from an

edge location that has the lowest latency in relation to where your agents are located. IP range allowlists for CloudFront are global and require all IP ranges associated with "service": "CLOUDFRONT" in ip-ranges.json.

- Once ip-ranges.json is updated, the associated AWS service will begin using the updated IP ranges after 30 days. To avoid intermittent connectivity issues when the service begins routing traffic to the new IP ranges, be sure to add the new IP ranges to your allowlist, within 30 days from the time they were added to ip-ranges.json.
- If you are using a custom CCP with the Amazon Connect Streams API, you can create a media-less CCP that does not require opening ports for communication with Amazon Connect, but still requires ports opened for communication with Amazon EC2 and CloudFront.

Region selection considerations

Amazon Connect Region selection is contingent upon data governance requirements, use case, services available in each Region, and latency in relation to your agents, contacts, and external transfer endpoint geography.

- **Agent location/network**—CCP connectivity traverses the public WAN, so it is important that the workstation has the lowest latency and fewest hops possible, specifically to the AWS Region where your resources and Amazon Connect instance are hosted. For example, hub and spoke networks that need to make several hops to reach an edge router can add latency and reduce the quality of experience.

When you set up your instance and agents, make sure to create your instance in the Region that is geographically closest to the agents. If you need to set up an instance in a specific Region to comply with company policies or other regulations, choose the configuration that results in the fewest network hops between your agents' computers and your Amazon Connect instance.

- **Location of your callers**—Because calls are anchored to your Amazon Connect Region endpoint, they are subject to PSTN latency. Ideally your callers and transfer endpoints are geographically located as closely as possible to the AWS Region where your Amazon Connect instance is hosted for lowest latency.

For optimal performance, and to limit the latency for your customers when they call in to your contact center, create your Amazon Connect instance in the Region that is geographically closest to where your customers call from. You might consider creating multiple Amazon Connect instances, and providing contact information to customers for the number that is closest to where they call from.

- **External transfers**—from Amazon Connect remain anchored to your Amazon Connect Region endpoint for the duration of the call. Per-minute usage continues to accrue until the call is disconnected by the recipient of the transferred call. The call is not recorded after the agent drops or the transfer completes. The contact record data and associated call recording of a transferred call are generated after the call is terminated. Whenever possible, don't transfer calls that could be transferred back into Amazon Connect, known as circular transfers, to avoid compounding PSTN latency.

Agents using Amazon Connect remotely

Remote agents, those that use Amazon Connect from a location other than those connected to your organization's main network, may experience issues relating to their local network if they have an unstable connection, packet loss, or high latency. This is compounded if a VPN is required to access resources. Ideally, the agents are located close to the AWS Region where your AWS resources and Amazon Connect instance are hosted, and have a stable connection to the public WAN.

Rerouting audio

When rerouting audio to an existing device, consider the location of the device in relation to your Amazon Connect Region. This is so you can account for potential additional latency. If you reroute your audio, whenever there is a call intended for the agent, an outbound call is placed to the configured device. When the agent answers the device, that agent is connected with the caller. If the agent does not answer their device, they are moved into a missed contact state until they or a supervisor changes their state back to available.

Using AWS Direct Connect

Contact Control Panel (CCP) network connectivity issues are most often rooted in your route to AWS using private WAN/LAN, ISP, or both. While AWS Direct Connect does not solve issues specific to private LAN/WAN traversal to your edge router, it can help solve for latency and connectivity issues between your edge router and AWS resources. AWS Direct Connect provides a durable, consistent connection rather than relying on your ISP to dynamically route requests to AWS resources. It also allows you to configure your edge router to redirect AWS traffic across dedicated fiber rather than traversing the public WAN.

Agent workstation networking requirements for web calling voice/video

The Amazon Connect in-app, web, and video calling capabilities enable your customers to contact you without ever leaving your web or mobile application. The video calling capabilities leverage the Amazon Chime SDK communication primitives for the video stream. The voice experience is handled through Amazon Connect.

Important

Video calling does not support VDI environments.

The following table shows the additional networking requirements for your agents' workstation.

Domain	Subnet	Ports
*.chime.aws	99.77.128.0/18	443 (TCP) 3478 (UDP)

The following diagram shows the networking requirements for the customers who are using the communications widgets to contact you.

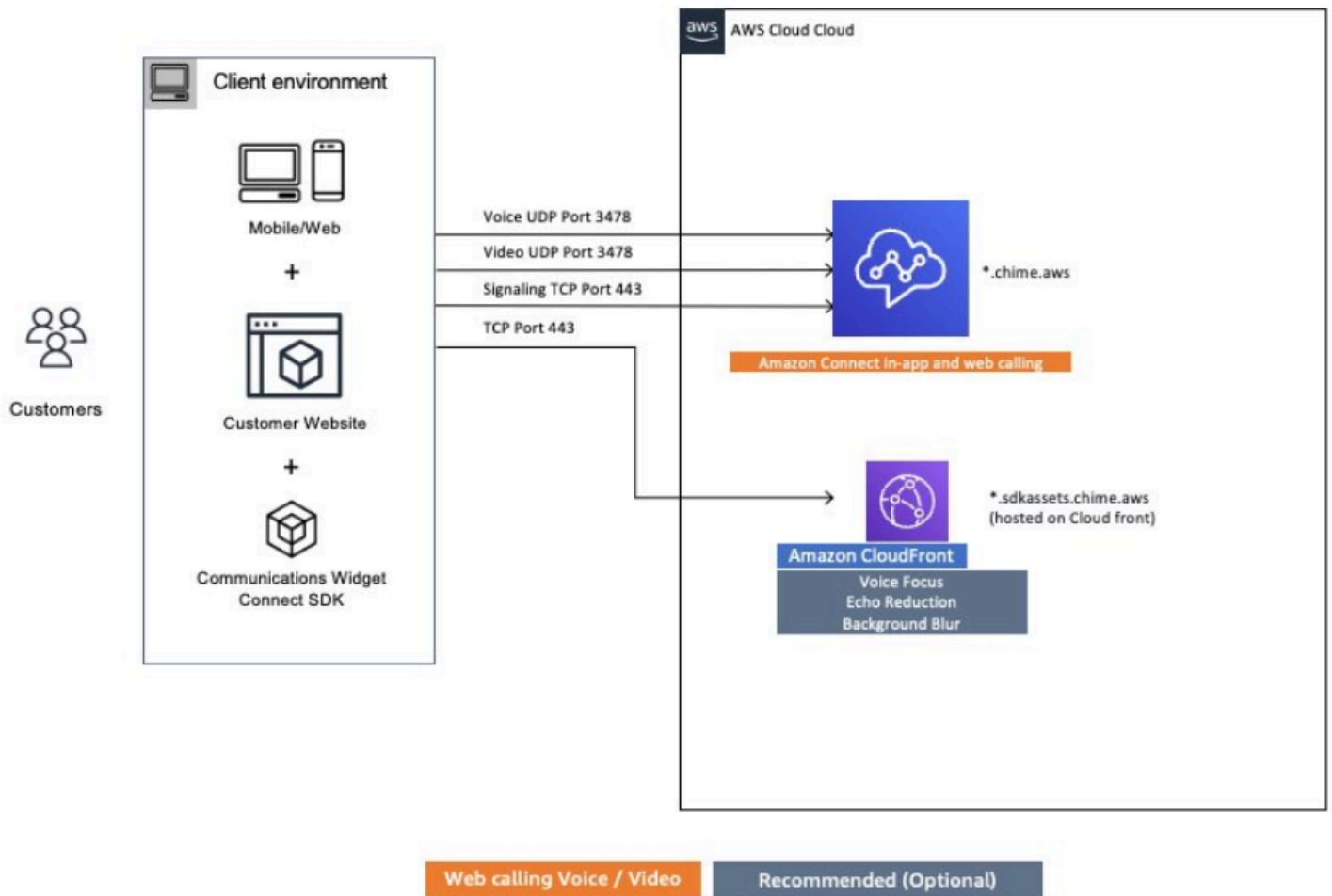

Detailed network paths for Amazon Connect

Voice calls

The following diagram shows how voice calls flow through Amazon Connect

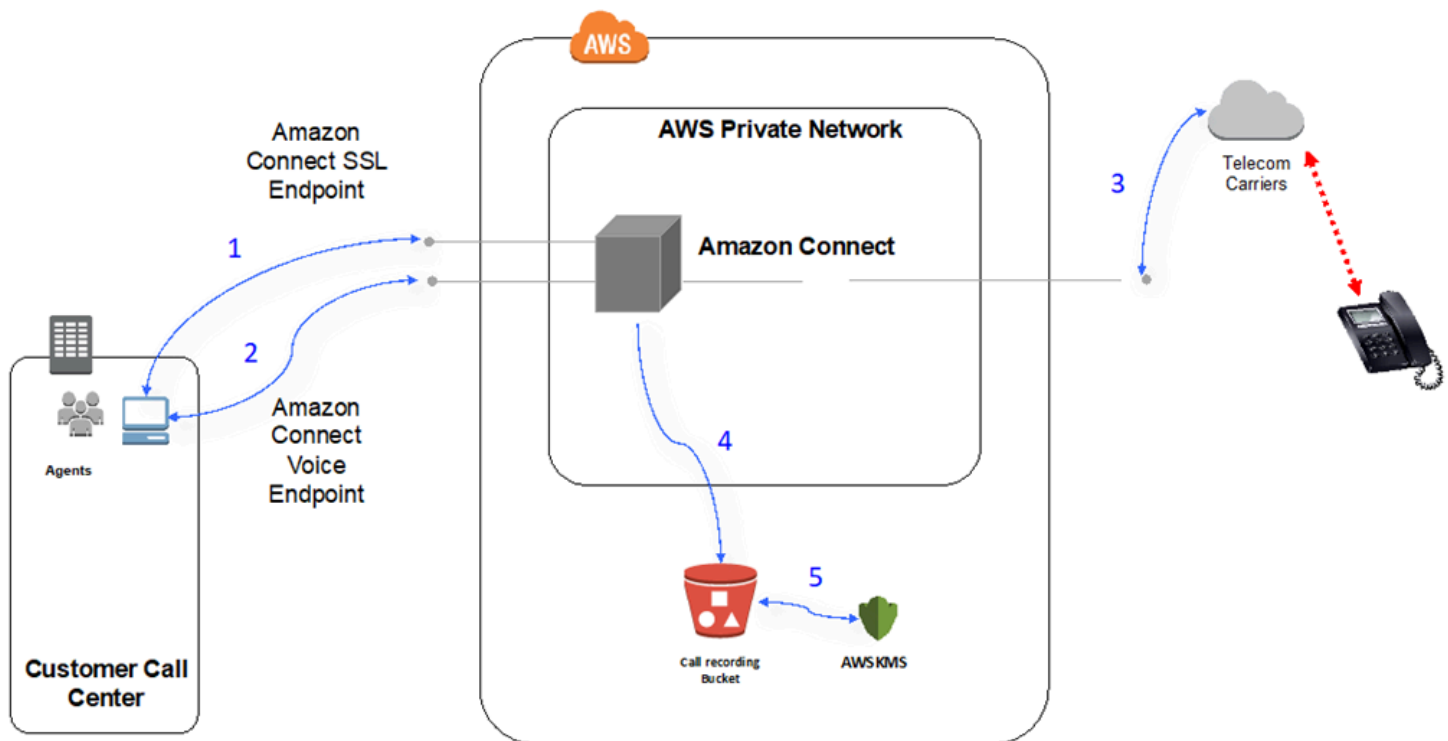

1. Users access the Amazon Connect application using a web browser. All communications are encrypted in transit using TLS.
2. Users establish voice connectivity to Amazon Connect from their browser using WebRTC. Signaling communication is encrypted in transit using TLS. Audio is encrypted in transit using SRTP.
3. Voice connectivity to traditional phones (PSTN) is established between Amazon Connect and AWS telecommunications carrier partners using private network connectivity. In cases where shared network connectivity is used, signaling communication is encrypted in transit using TLS and audio is encrypted in transit using SRTP.
4. Call recordings are stored in your Amazon S3 bucket that Amazon Connect has been given permissions to access. This data is encrypted between Amazon Connect and Amazon S3 using TLS.
5. Amazon S3 server-side encryption is used to encrypt call recordings at rest using a customer-owned KMS key.

Authentication

The following diagram shows using the AD Connector with AWS Directory Service to connect to an existing customer Active Directory installation. The flow is similar to using AWS Managed Microsoft AD.

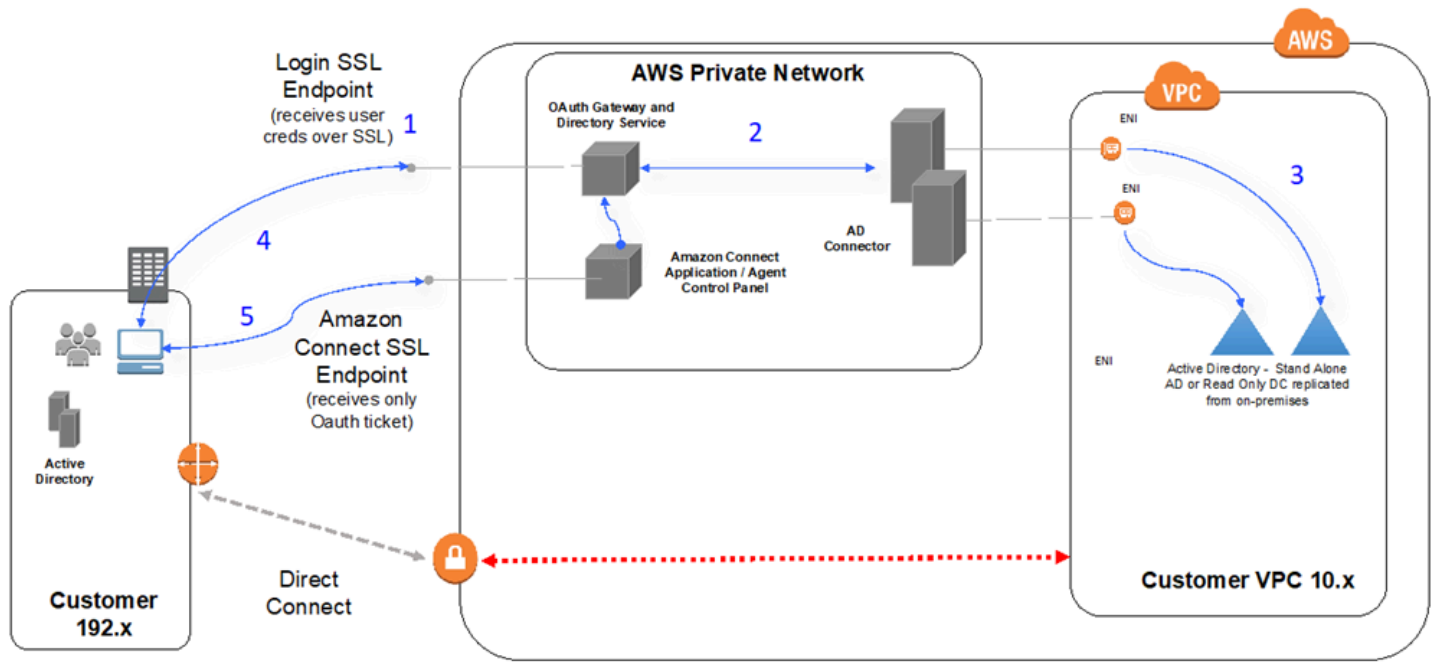

1. The user's web browser initiates authentication to an OAuth gateway over TLS using the public internet with user credentials (Amazon Connect login page).
2. OAuth gateway sends the authentication request over TLS to AD Connector.
3. AD Connector does LDAP authentication to Active Directory.
4. The user's web browser receives OAuth ticket back from gateway based on authentication request.
5. The client loads the Contact Control Panel (CCP). The request is over TLS and uses OAuth ticket to identify user/directory.

Use Amazon Connect in a VDI environment

Virtual Desktop Infrastructure (VDI) environments add another layer of complexity to your solution that warrants separate POC efforts and performance testing to optimize. The Contact Control Panel (CCP) can operate in thick, thin, and zero client VDI environments as any other WebRTC based browser application does, and the configuration/support/optimization is best handled by

your VDI support team. That being said, the following is a collection of considerations and best practices that have been helpful for our VDI-based customers.

Use a split CCP model

We recommend using a split CCP model with a medialess CCP running in the VDI and a CCP carrying the media on the local PC. You can build a custom CCP with the Amazon Connect Streams API by creating a CCP with no media for application data and call signaling. This way, the media is delivered to the local desktop using standard CCP, with data and call controls delivered to the remote connection with the medialess CCP. For more information about the streams API, see the GitHub repository at <https://github.com/aws/amazon-connect-streams>.

The following diagram shows how the agent workstation is comprised of a local browser and virtual desktop. It connects to Amazon Connect through WebRTC, and connects to the corporate virtual infrastructure through a VDI connection.

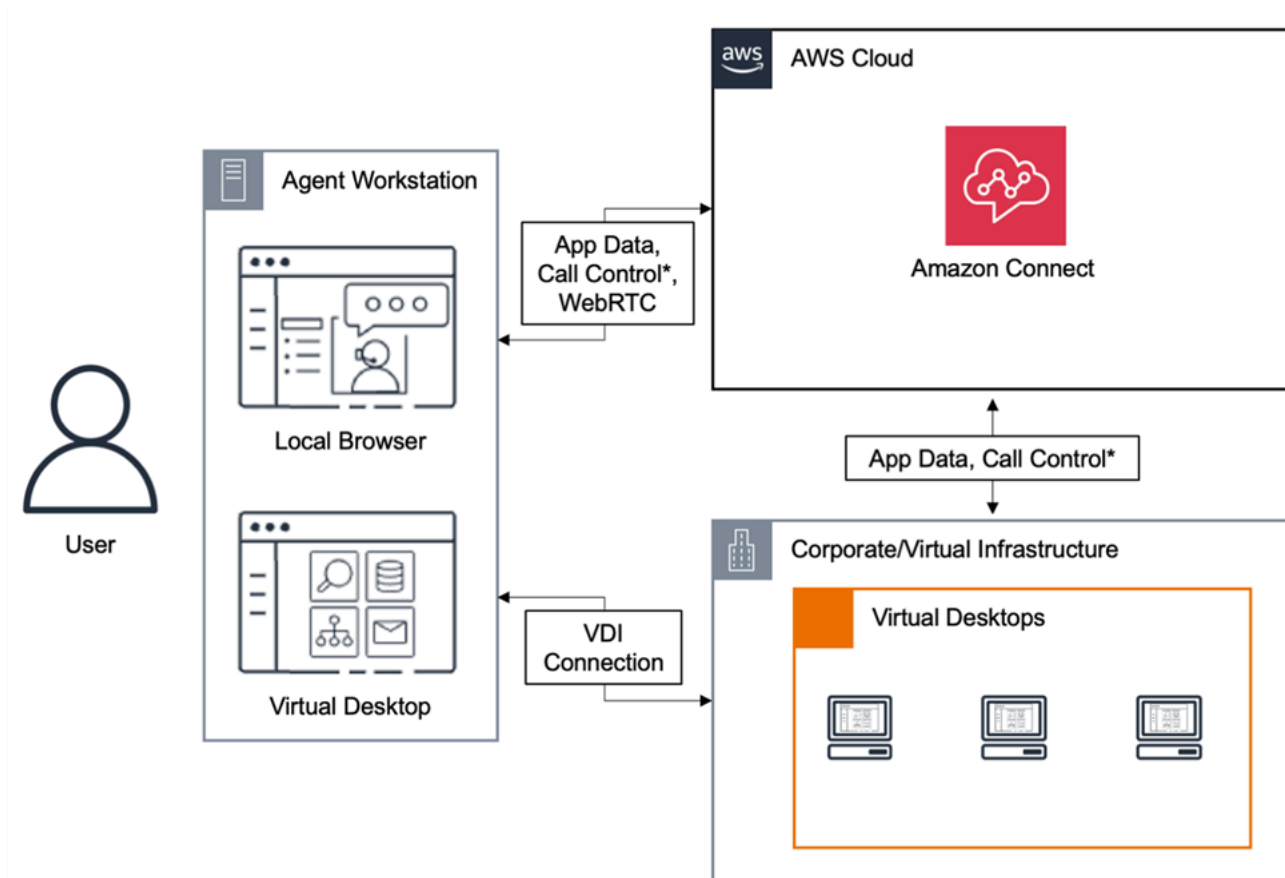

*Call control is available via either connection. Typically, agents do not need to interact with both.

Citrix cloud desktops

If you use Citrix cloud desktops, you can create a new or update an existing agent user interface, such as a custom CCP, to offload audio processing to your agent's local device and to automatically redirect audio to Amazon Connect. This results in a more streamlined agent experience and improves audio quality over challenging networks. To get started, you can use the [Amazon Connect open source libraries](#) to create a new or update an existing agent user interface, such as a custom Contact Control Panel (CCP).

Things to consider when designing your VDI environment

- **Location of your agents**—Ideally, there are as few hops as possible with the lowest round trip time between the location from which your agents use the CCP and the VDI host location.
- **Host location of your VDI solution**—Ideally, your VDI host location is on the same network segment as your agents, with as few hops as possible from both internal resources as well as an edge router. You also want the lowest round-trip time possible to both WebRTC and Amazon EC2 range endpoints.
- **Network**—Each hop that traffic goes through between endpoints increases the possibility of failure and adds opportunity to introduce latency. VDI environments are particularly susceptible to call quality issues if the underlying route is not optimized or the pipe isn't either fast or wide enough. While AWS Direct Connect can improve call quality from the edge router to AWS, it will not address internal routing issues. You may need to upgrade or optimize your private LAN/WAN, or redirect to an external device to circumvent call audio issues. In most scenarios, if this is required, the CCP is not the only application that is having issues.
- **Dedicated resources**—at the Network and desktop level are recommended to prevent an impact to available agent resources from activities, such as backups and large file transfers. One way to prevent resource contention is by restricting the desktop access to Amazon Connect users who will be using their environment similarly, instead of sharing resources with other business units who may use those resources differently.
- **Using a soft phone with remote connections**—in VDI environments can cause impact to audio quality.

Tip

If your agents connect to a remote endpoint and operates in that environment, we recommend either rerouting audio to an external E.164 endpoint or connecting the media through the local device and then signaling through the remote connection.

Amazon Connect audio optimization for Citrix cloud desktops

Amazon Connect makes it easier to deliver high-quality voice experiences when your agents are using Citrix Virtual Desktop Infrastructure (VDI) environments. Your agents can leverage their Citrix remote desktop applications such as Citrix Workspaces, to offload audio processing to the agent's local device and to automatically redirect audio to Amazon Connect, resulting in improved audio quality over challenging networks.

To get started, you can use the [Amazon Connect open source libraries](#) to create a new or update an existing agent user interface, such as a custom Contact Control Panel (CCP).

System requirements

This section describes the system requirements for using the Citrix Unified Communications SDK with Amazon Connect.

- **Citrix Workspace Application Version**

The version of Citrix Workspace Application needs to be 21.9.x.x or above.

- **Citrix Server Version**

The version of Citrix VDA (Virtual Delivery Agent) needs to be 2109 or above.

- **Citrix Server Setup**

The Citrix UC SDK is not supported to use by default and the admin of the system needs to add an allow-list registry entry as follows:

- **Key Path:** Computer\HKEY_LOCAL_MACHINE\SOFTWARE\WOW6432Node\Citrix\WebSocketService
- **Key Name:** ProcessWhitelist
- **Key Type:** REG_MULTI_SZ

- **Key Value:**
 - Chrome.exe
 - msedge.exe

After you configure the registry successfully, restart the CitrixHdxWebSocketService using **Task Manager** to finish the setup.

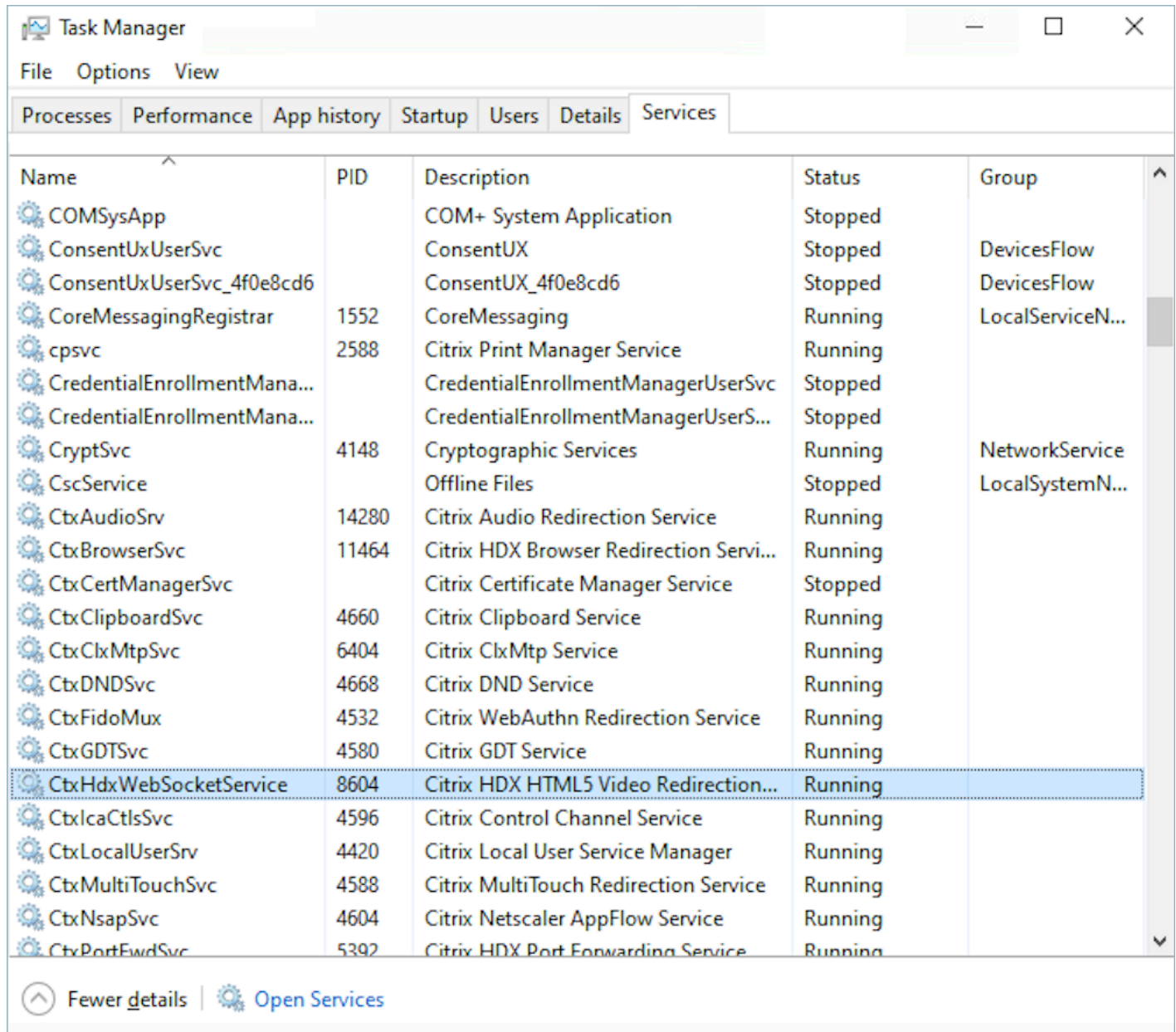

- **Networking/Firewall Configurations**
 - **Citrix server configuration**

The admin needs to allow the Citrix server to access Amazon Connect TCP/443 traffic to the domains mentioned in the following diagram. For more information, see the [Amazon Connect network setup guide](#).

- **Agent machine configuration**

This solution requires a media connection between the agent's thin client and Amazon Connect. Follow the [network setup guide](#) to allow traffic between the agent's machine and Amazon Connect's Softphone Media UDP Port 3478.

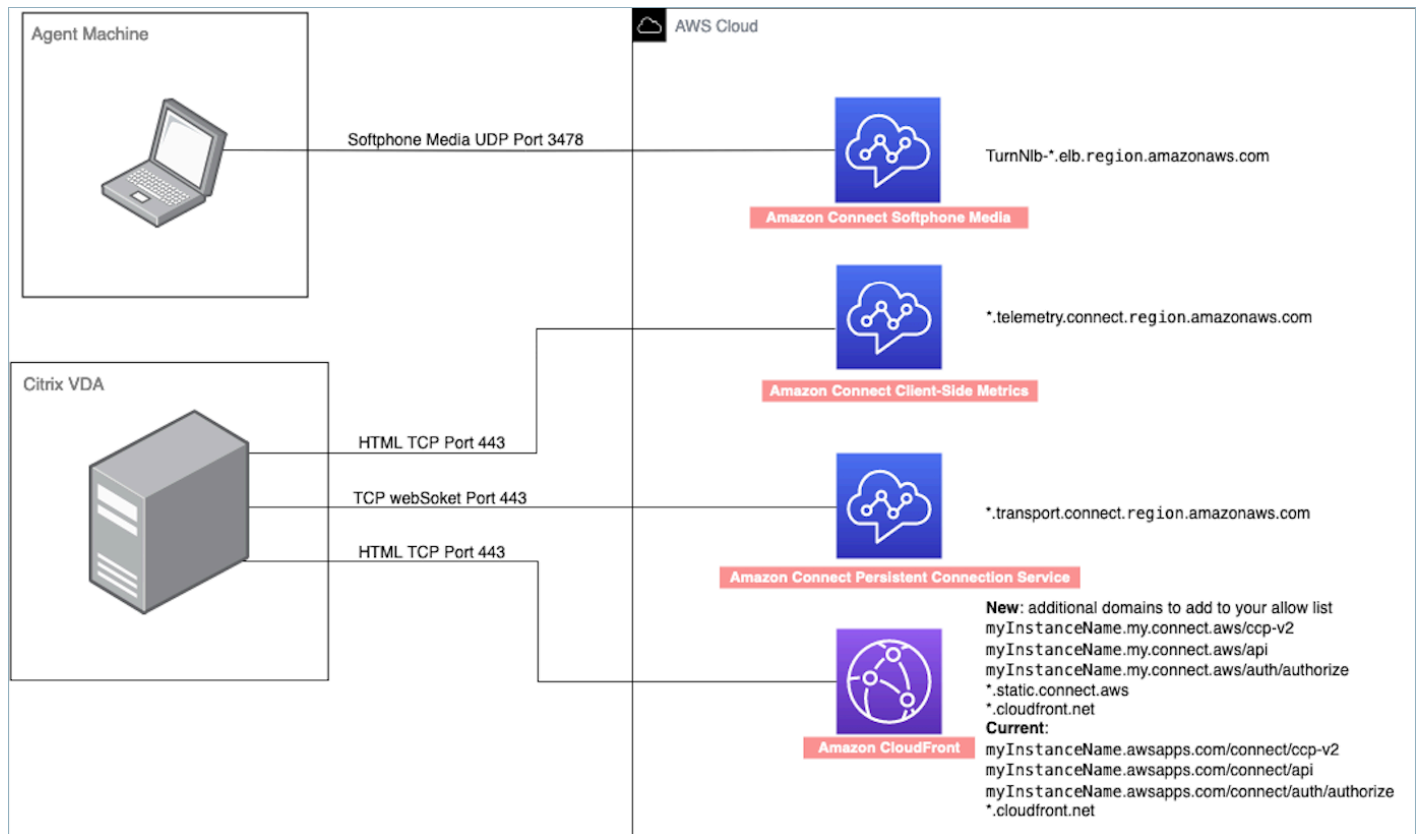

- **Unsupported CCP Deployment**

- Native CCP

Confirm media flows between thin client and Amazon Connect during the call

- **Use Task Manager (Windows) to verify**

Launch the **Task Manager** on the agent's thin client and check to see if the HDX service is running or not. If it is running, then it means that the media is being redirected as expected.

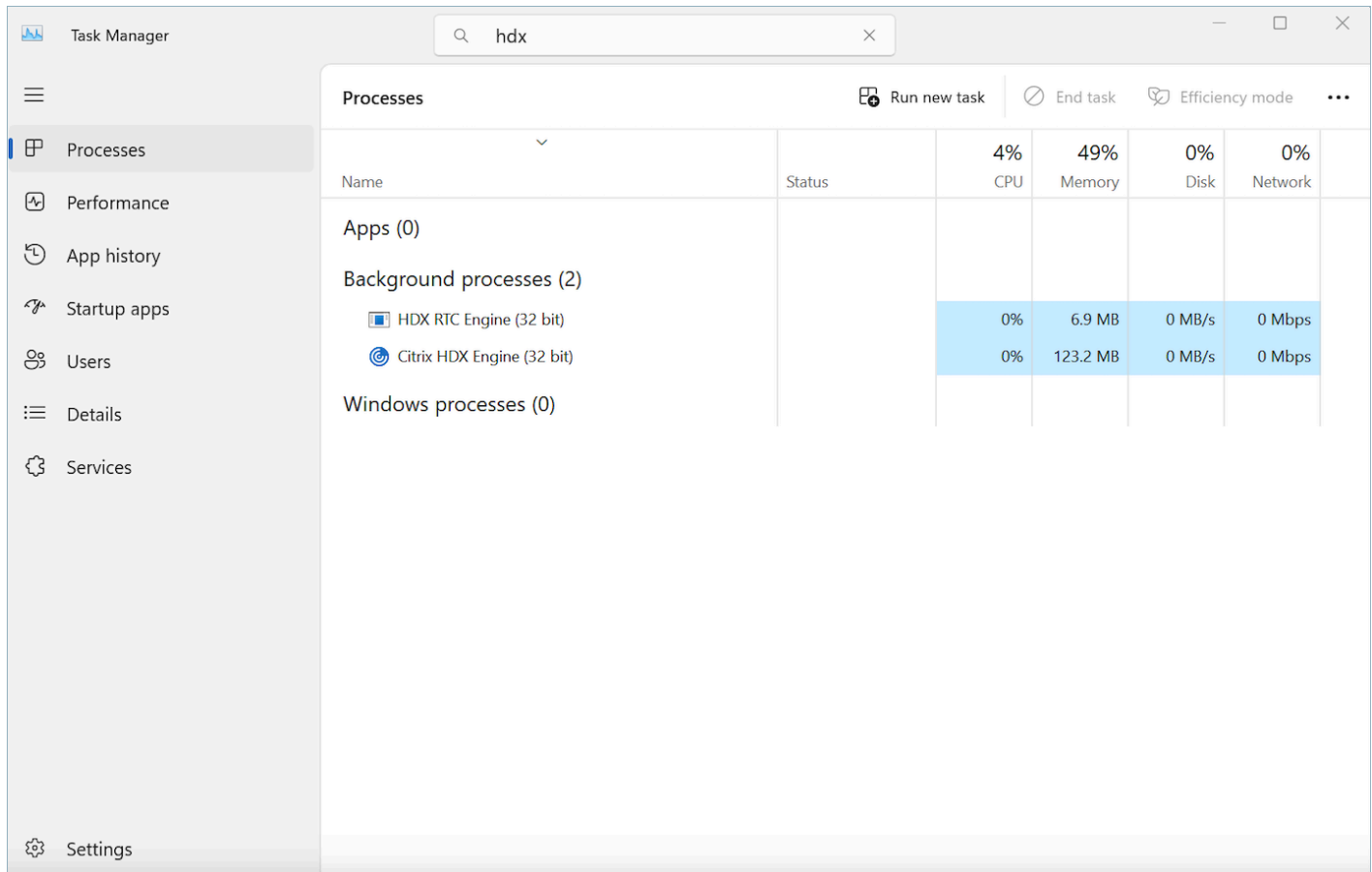

CCP connectivity

When an agent logs in, the CCP attempts to connect to the Amazon EC2 signaling endpoints listed in the AWS `ipranges.json` file, Amazon Connect for media, and CloudFront for web artifacts such as images. When the agent logs out or the browser is closed, endpoints are reselected when the agent next logs in. If a connection to Amazon EC2 or Amazon Connect fails, errors display on the CCP. If a connection to CloudFront fails, web elements such as buttons and icons, or even the page itself fails to load correctly.

Note

If you see the **Session expired** message while logging in, you probably just need to refresh the session token. Go to your identity provider and log in. Refresh the Amazon Connect page. If you still get this message, contact your IT team.

Outbound calls

- When an outbound call is placed, the event signal is sent to the Amazon EC2 endpoint, which then communicates with Amazon Connect to place the call. Upon a successful dial attempt, the agent is bridged in, which anchors the call to the agent's Amazon Connect endpoint. Any external transfers or conferences also uses the anchor until the call is disconnected. Anchoring can help reduce PSTN latency.

Inbound calls

- When an inbound call is received, the call is anchored to an Amazon Connect endpoint. Any external transfers or conferences also use this anchor until the call is disconnected.
- When an agent is available, the call is pushed through using a new Amazon EC2 connection to their browser and offered to the agent.
- When the agent accepts the call and either the external device has been answered or the CCP determines it can receive a call, a connection to Amazon Connect is established for call media to the agent.

Transferred calls

- When a call is transferred, the transfer event that signals to place an outbound call to the specified transfer destination is sent to Amazon EC2, which then communicates with Amazon Connect to place the call.
- When the call is connected, the agent is bridged in, anchoring the call to the agent's existing Amazon Connect endpoint. Any external transfers or conferences also use this anchor until the call is disconnected.
- If the agent hangs up after the call is bridged, the agent's connection to the call is terminated, but Amazon Connect hangs on to the call at the Amazon Connect anchor point until there is a far side disconnect. When the call is disconnected, contact records and associated recordings are generated and made available for the call.

Missed calls

- If the call is waiting on an agent, customer queue flow logic is used until an agent is available and the call has been successfully routed to that agent.

- If the agent does not accept the call, the agent moves into a Missed Call state and is unable to take calls until the agent, or a call center manager, changes their status to Available again. The caller does not hear ringing while the call is waiting for the agent, and continues to hold until connected with an agent as defined in the customer queue flow logic.
- If the agent is configured for [cross-channel concurrency](#), they must clear the missed contact before any other contacts on any other channel can be routed to them. For example, if they are configured to handle voice and chats at the same time, and they miss a chat, they must clear that contact before any other voice or chat contacts are routed to them.

Panic logout

- If the browser window where the CCP is running is closed, the call remains connected, but opening the browser and logging back in will not allow you to re-establish the media connection. You are still able to transfer or end the call, but no audio path is established between the agent and caller.

Use an allowlist for integrated applications

All domains that embed the CCP for a particular instance must be explicitly allowed for cross-domain access to the instance. For example, to integrate with Salesforce, you must place your Salesforce Visualforce domain in an allowlist.

To allow a domain URL

1. Open the Amazon Connect console at <https://console.aws.amazon.com/connect/>.
2. Choose the name of the instance from **Instance Alias**.
3. In the navigation pane, choose **Approved origins**.
4. Choose **Add origin**.
5. Type the URL and choose **Add**.

Note

When Amazon Connect is embedded in another app, it's possible for users to get a **Session expired** error message when they close and then reopen Amazon Connect, and then log in.

If you see the **Session expired** message while logging in, you probably just need to refresh the session token. Go to your identity provider and log in. Refresh the Amazon Connect page. If you still get this message, contact your IT team.

Update your Amazon Connect domain

Amazon Connect instances that were created before March 31, 2021, were given a domain that looks like this:

- [https://*your-instance-alias*.awsapps.com/connect/](https://your-instance-alias.awsapps.com/connect/)

If you have one of these domains, we urge you to change it immediately. Change it to:

- [https://*your-instance-alias*.my.connect.aws/](https://your-instance-alias.my.connect.aws/)

In the near future we plan to automatically change any remaining old domains that appear in the AWS console—including the emergency access URL—to the new URL.

- If anyone tries to access a URL with the old domain, they will be redirected automatically to the new one.
- If you have any custom code, a connector, or a firewall, it is your responsibility to update all references to your Amazon Connect URL from your old domain to your new domain.
- Automatic redirection from the old domain to the new one is only for any references you may have accidentally missed, for example, users still clicking on old favorites.

Perform the steps in this topic to help you PREPARE for when we automatically change your old domain name (that is, redirect traffic from your old domain to the new one).

For example, if your old link looks like this:

- [https://*examplecorp*.awsapps.com/connect/](https://examplecorp.awsapps.com/connect/)

Change to:

- [https://*examplecorp*.my.connect.aws/](https://examplecorp.my.connect.aws/)

Continue reading this topic if you use a firewall, SAML, or other connectors such as Salesforce. This topic provides information you need to consider when migrating to the new domain.

Contents

- [Custom code and integrations](#)
- [Firewall allowlist](#)
- [About the Amazon Connect access URL and emergency login](#)
- [Personal settings](#)
- [Transport Layer Security \(TLS\)](#)

Custom code and integrations

If you have any customization that involves Amazon Connect, review its code and replace hard-coded references to the previous domain with the new domain. For example, if you have a custom Contact Control Panel (CCP) integration, it likely relies on embedded URLs. Following are tips for updating other types of integration.

Active Directory

If you use Active Directory to manage identity and have an [Amazon Connect managed or customer managed](#) instance, then update [ccpUrl](#) to the new domain. The next time a user accesses the CCP they will be prompted to login to the new domain (one time only).

SAML 2.0

If you use SAML 2.0 to manage identity, then do the following steps:

- Update `ccpUrl` in your [Amazon Connect Streams](#) to the new domain *your-instance-alias*.my.connect.aws/ccp-v2.
- When you configure the relay state for your identity provider, update the `loginUrl` with `new_domain=true`.
- You must use [URL encoding](#) for the destination and `new_domain` in the URL.

If you have old instances that were set up with SAML, do the following steps:

1. If `loginUrl` contains `destination=%2Fconnect%2Fyour-destination-endpoint`, remove the `%2Fconnect` endpoint prefix from the new domain destination.

2. Add `new_domain=true` before or after `destination=%2Fyour-destination-endpoint`. It should be separated by `&`.
3. If `loginUrl` does not contain `destination` or any other parameter, add `?new_domain=true` after the relay state URL.

Following are examples of valid relay state URLs:

- `https://us-east-1.console.aws.amazon.com/connect/federate/your-instance-id?destination=%2Fccp-v2%2Fchat&new_domain=true`
- `https://us-east-1.console.aws.amazon.com/connect/federate/your-instance-id?new_domain=true`

Note

If the `RelayState` is itself a parameter to another URL, then the whole `RelayState` itself must be URL encoded, on top of any URL encoding previously done on the destination. For example, if the derived `RelayState` was `https://us-east-1.console.aws.amazon.com/connect/federate/your-instance-id?destination=%2Fccp-v2%2Fchat&new_domain=true`, and it needs to be inserted in `https://my.idp.com/signin?RelayState=<here>`, then the final URL should look like `https://my.idp.com/signin?RelayState=https%3A%2F%2Fus-east-1.console.aws.amazon.com%2Fconnect%2Ffederate%2Fyour-instance-id%3Fdestination%3D%252Fccp-v2%252Fchat%26new_domain%3Dtrue`. The URL encoding is crucial to allow it to be parsed correctly in a [query string](#).

Other connectors

If you use Salesforce, Zendesk, ServiceNow, or other connectors:

1. Upgrade to the latest version of your connector.
2. In your connector, go to the settings and update the Amazon Connect domain that is stored there. Follow the SAML tips if applicable.

Firewall allowlist

Add the following new domains to your allowlist:

- *your-instance-alias*.my.connect.aws
- *.static.connect.aws

Important

Do not remove the domains already in your allowlist, such as the following domains:

- *your-instance-alias*.awsapps.com/connect/ccp-v2
- *your-instance-alias*.awsapps.com/connect/api
- *.cloudfront.net

Keeping these domains in your allow list will ensure a smooth transition. You can remove them later, after the migration is complete.

For more information about setting up your allowlist, see [Set up your network](#).

About the Amazon Connect access URL and emergency login

The Amazon Connect access URL and emergency login URLs will be updated in the AWS console after we complete the domain migration. Until that time, they will reflect the old domain.

The following image shows the location of the access URL on the **Amazon Connect virtual contact center instances** page. Even if you have taken steps to update your domain, this URL will continue to show the old domain. The URL on this page will update automatically when old domain traffic starts to redirect to the new domain. Please **do not use this URL to log in**; rather, communicate to your team the new URL that they should be using.

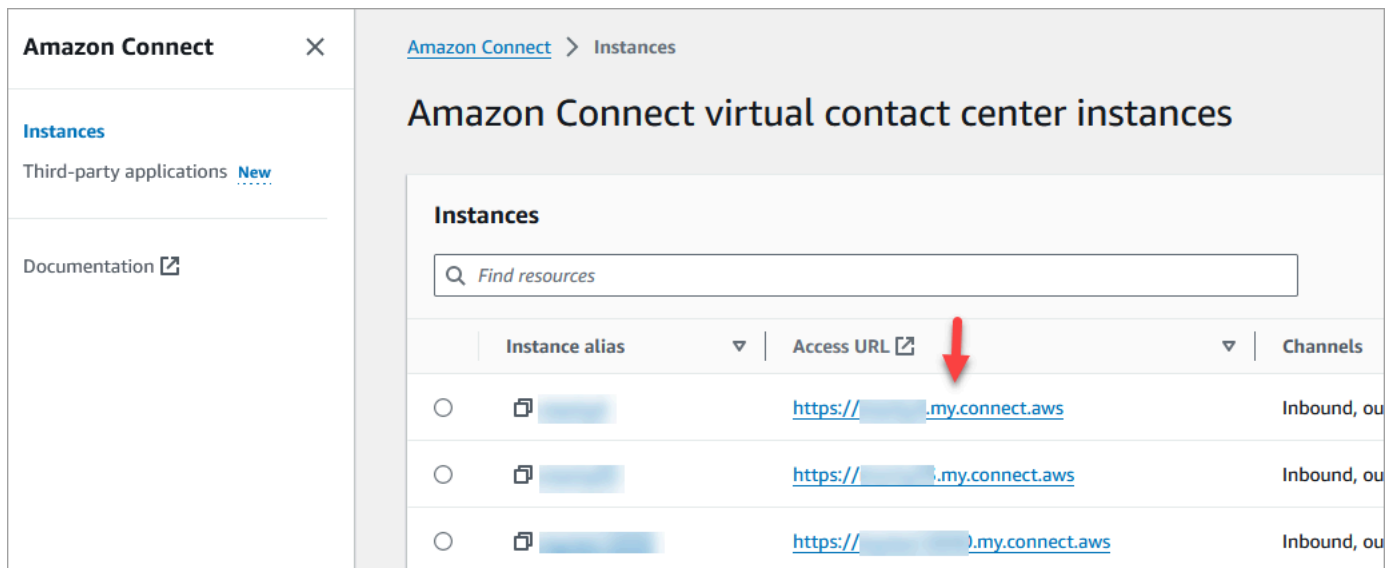

The following image shows the location of the emergency login URL on the **Account overview** page. This URL will lead to the old domain until traffic starts to automatically redirect to the new domain. Please **refrain from using this URL to log in unless it is an emergency**. Instead, log in with your username and password from the login page associated with your new domain.

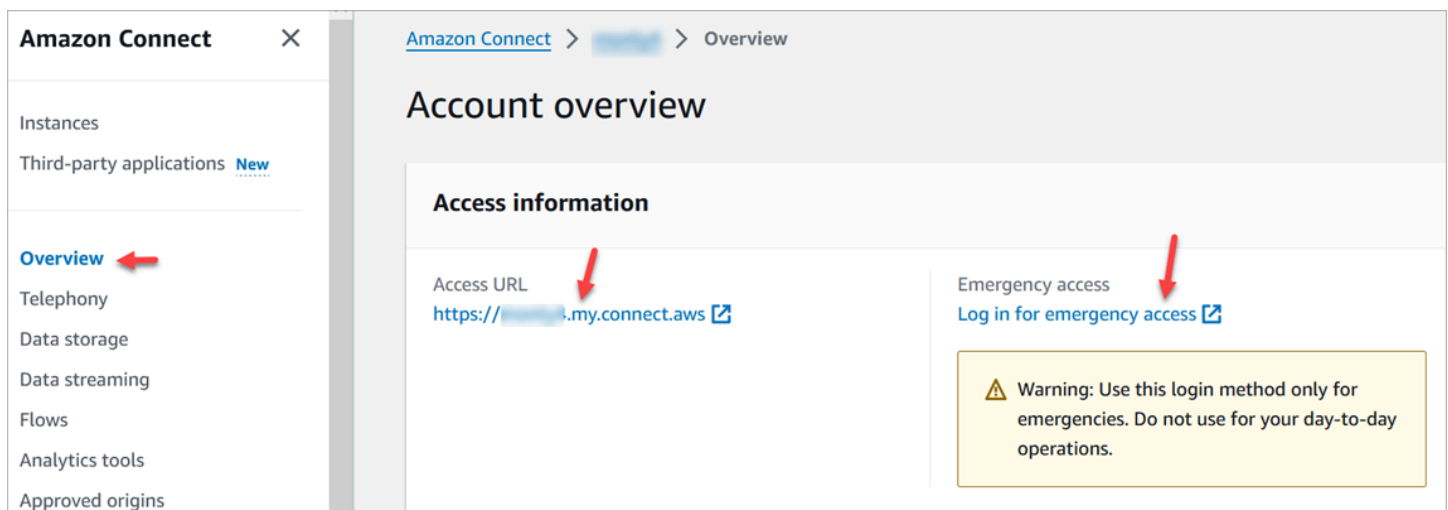

Personal settings

Notify your team to the upcoming change so they can take steps to prevent confusion and disruption. If you have internal documentation that includes links, please review and update accordingly. Encourage team members to update their browser bookmarks *for the login page*, and productivity apps, such as Alfred.

To ensure a seamless transition for your team, we encourage you to take steps to identify any URL references.

Transport Layer Security (TLS)

If your agents are using [browsers that Amazon Connect supports](#), there is no action for you. For example, if you are using the latest Chrome and Firefox versions, no action is needed.

If you are using TLS 1.1 and below, you need to upgrade your tools to support the TLS 1.1+ protocols.

We require your TLS protocol to be TLS 1.2 and recommend TLS 1.3. The new domain does not support TLS 1.1 and TLS 1.0.

We recommend that you review the new TLS policy: [ALB FS-1-2-Res-2019-08](#). For reference, you can find the previous TLS policy here: [CloudFront TLSv1](#).

Create Amazon Connect Flows

A *flow* defines the customer experience with your contact center from start to finish. Amazon Connect includes a set of [default flows](#) so you can quickly set up and run a contact center. However, you may want to create custom flows for your specific scenario.

Contents

- [Permissions required to view, edit, create flows](#)
- [Default flows](#)
- [Sample flows](#)
- [Flow block definitions](#)
- [Create a flow](#)
- [Attach a claimed or ported phone number to a flow](#)
- [Flow modules for reusable functions](#)
- [Create prompts](#)
- [Set up contact transfers](#)
- [Set up recording behavior](#)
- [Set up queued callback by creating flows, queues, and routing profiles](#)
- [Import/export flows](#)
- [Add an Amazon Lex bot to Amazon Connect](#)
- [Invoke AWS Lambda functions](#)
- [Set up live media streaming of customer audio](#)
- [Encrypt customer input](#)
- [Track events as customers interact with flows](#)
- [Use Amazon Connect contact attributes](#)
- [Migrate flows to a different instance](#)

Permissions required to view, edit, create flows

To view, edit, create, and publish flows you need **Flows** permissions added to your security profile.

By default users who are assigned to the **Admin** and **CallCenterManager** security profiles have Flows permissions.

Default flows

Amazon Connect includes a set of default flows that have already been published. It uses them to power your contact center.

For example, say you create a flow that includes putting the customer on hold, but you don't create a prompt for it. The default flow, **Default agent hold**, will be played automatically. This is a way to help you get started with your call center quickly.

Tip

If you want to change the behavior of a default flow, we recommend creating a new customized flow based on the default. Then call the new flow intentionally in your flows rather than defaulting to it. This gives you better control over how your flows work.

To see the list of default flows in the Amazon Connect console, go to **Routing, Flows**. They all start with **Default** in their name.

Contents

- [Change a default flow](#)
- [Default agent hold: "You are on hold"](#)
- [Default agent transfer: "Transferring now"](#)
- [Default customer queue: queue hold message and music](#)
- [Default customer whisper: beep sound](#)
- [Default agent whisper: name of the queue](#)
- [Set the default whisper flow for a chat conversation](#)
- [Default customer hold: hold music](#)
- [Default outbound: "This call is not being recorded"](#)
- [Default queue transfer: "Now transferring"](#)
- [Default prompts from Amazon Lex: "Sorry .. "](#)

Change a default flow

You can override the way the default flows work by editing them directly.

Generally we recommend creating new flows based on the defaults, rather than editing the default flow directly. You can make a copy of the default flow, assign a name that indicates it's a custom version, and then edit that one. This gives you more control over how your flows work.

Change how a default flow works

The following steps show how to change the default message customers hear when they are put in a queue to wait for the next available agent.

1. On the navigation menu, choose **Routing, Flows**.
2. Choose the default flow you want to customize. For example, choose **Default customer queue** if you want to create your own message when a customer is put in queue instead of using the one we've provided. This is shown in the following image.

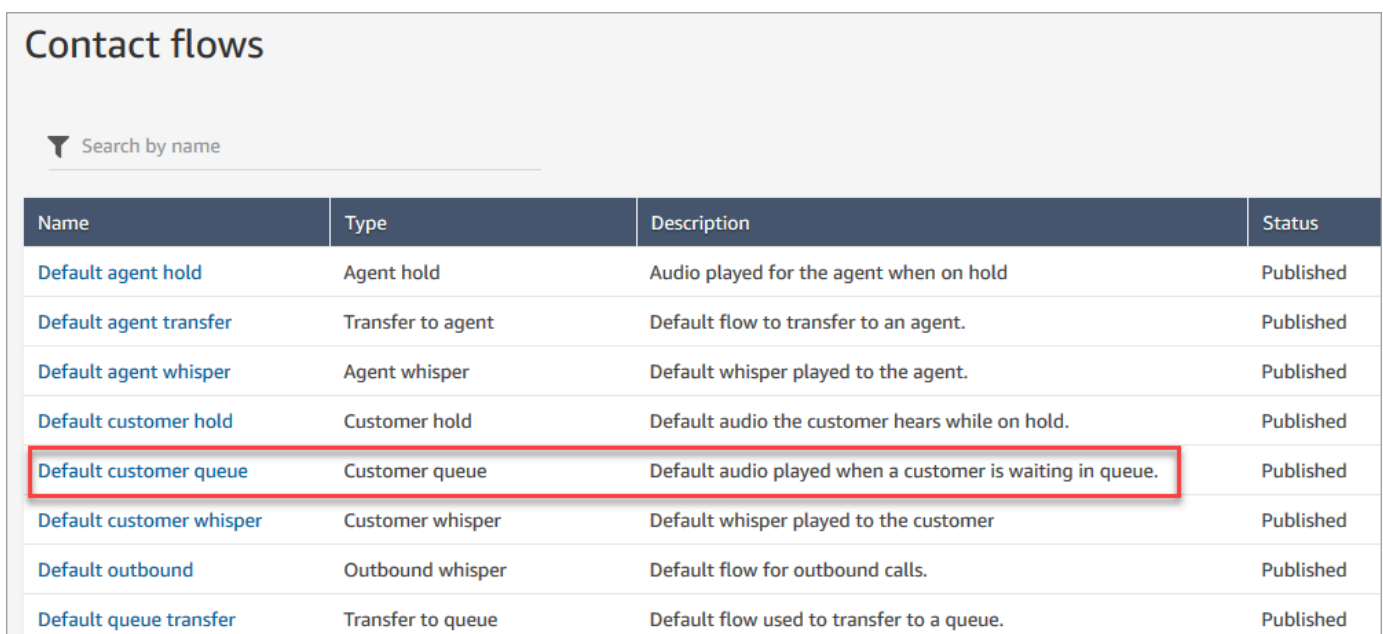

The screenshot shows the 'Contact flows' interface. At the top, there is a search bar labeled 'Search by name'. Below it is a table with four columns: Name, Type, Description, and Status. The table lists several default flows, and the 'Default customer queue' row is highlighted with a red border.

Name	Type	Description	Status
Default agent hold	Agent hold	Audio played for the agent when on hold	Published
Default agent transfer	Transfer to agent	Default flow to transfer to an agent.	Published
Default agent whisper	Agent whisper	Default whisper played to the agent.	Published
Default customer hold	Customer hold	Default audio the customer hears while on hold.	Published
Default customer queue	Customer queue	Default audio played when a customer is waiting in queue.	Published
Default customer whisper	Customer whisper	Default whisper played to the customer	Published
Default outbound	Outbound whisper	Default flow for outbound calls.	Published
Default queue transfer	Transfer to queue	Default flow used to transfer to a queue.	Published

3. To customize the message, choose the **Loop prompts** block to open the properties page.

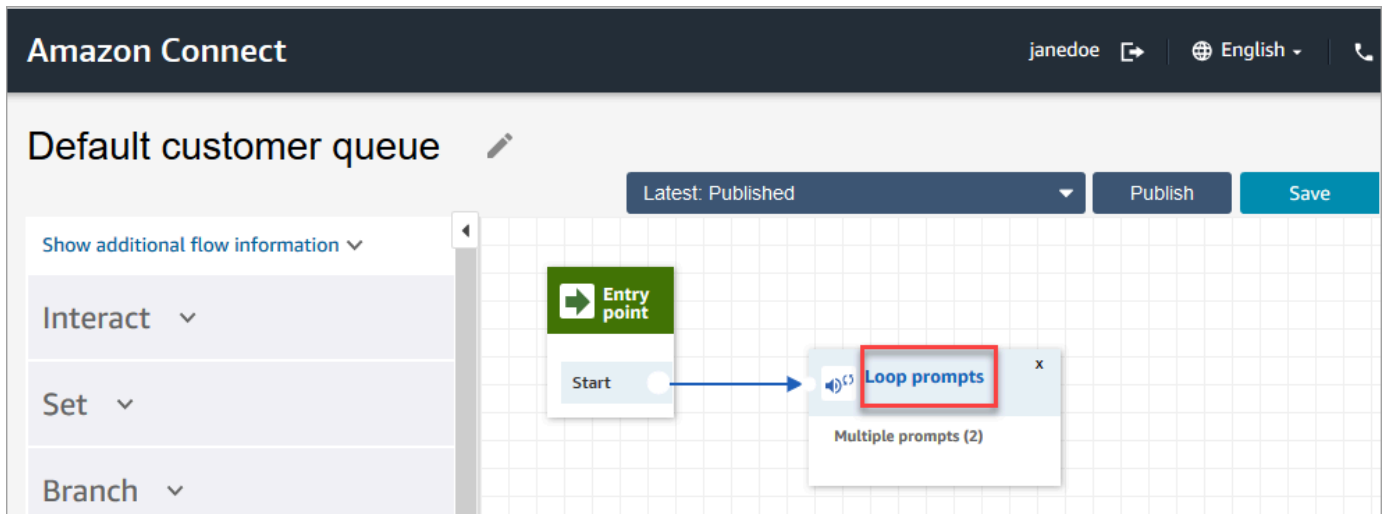

4. On the *Properties* page of the *Loop prompts* block, use the dropdown box to either choose different music, or set to **Text to Speech**. Type a message to be played.

For example, the following image shows the message *"Thank you for calling. Did you know you can reset your own password at the login page? Choose Reset now, and following the prompts."*

Loop prompts

Loops a sequence of prompts while a customer or agent is on hold or in queue.

When Loop prompts is used in a queue flow, audio playback can be interrupted at preset times. [Learn more](#)

Prompts

x Text to Speech

[Learn more about Amazon Connect's TTS capabilities](#)

Thank you for calling. Did you know you can reset your own password at the login page? Choose Reset now, and follow the prompts.

Text

x Audio recording

Music_Pop_ThisAndThatIsLife_Inst.wav

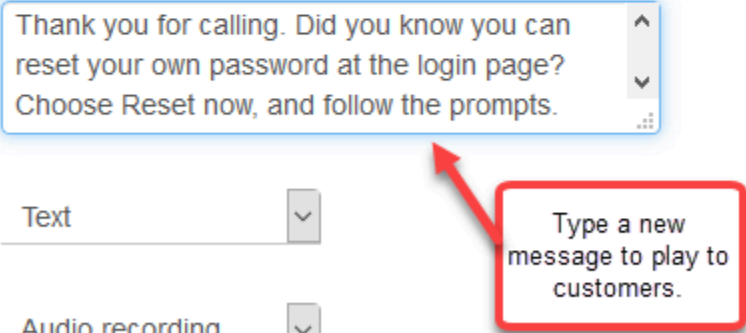

5. Choose **Save** at the bottom of the properties page.
6. Choose **Publish**. Amazon Connect starts playing the new message almost immediately (it may take a few moments for it to fully take effect).

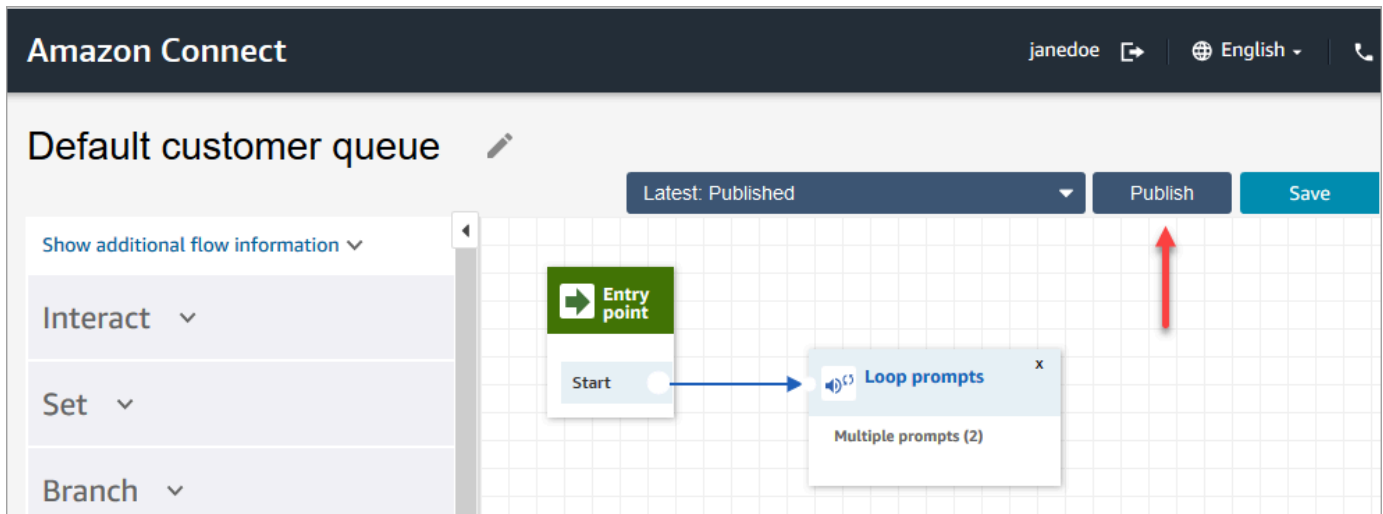

Copy a default flow before customizing it

Use the following steps to create a new flow based a current default.

1. On the navigation menu, choose **Routing, Flows**.
2. Choose the default flow you want to customize.
3. In the upper right corner of the page, choose the **Save** drop-down arrow. Choose **Save as**, as shown in the following image.



4. Assign a new name for the flow, for example, **Customer hold message**.

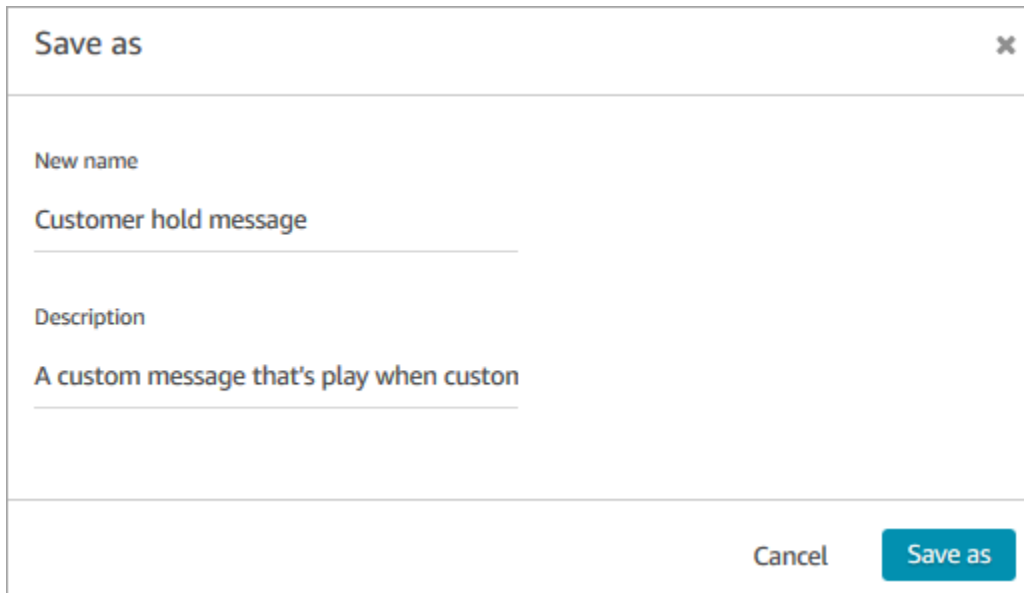

A dialog box titled "Save as" with a close button (X) in the top right corner. It contains two text input fields. The first field is labeled "New name" and contains the text "Customer hold message". The second field is labeled "Description" and contains the text "A custom message that's play when custom". At the bottom right, there are two buttons: "Cancel" and "Save as".

5. Add the new flow (in this case, **Customer hold message**) to the flows you create so it's run instead of the default.

Default agent hold: "You are on hold"

The **Default agent hold** flow is the experience the agent receives when placed on hold. During this flow, a **Loop prompt** block plays the message "You are on hold" to the agent every 10 seconds.

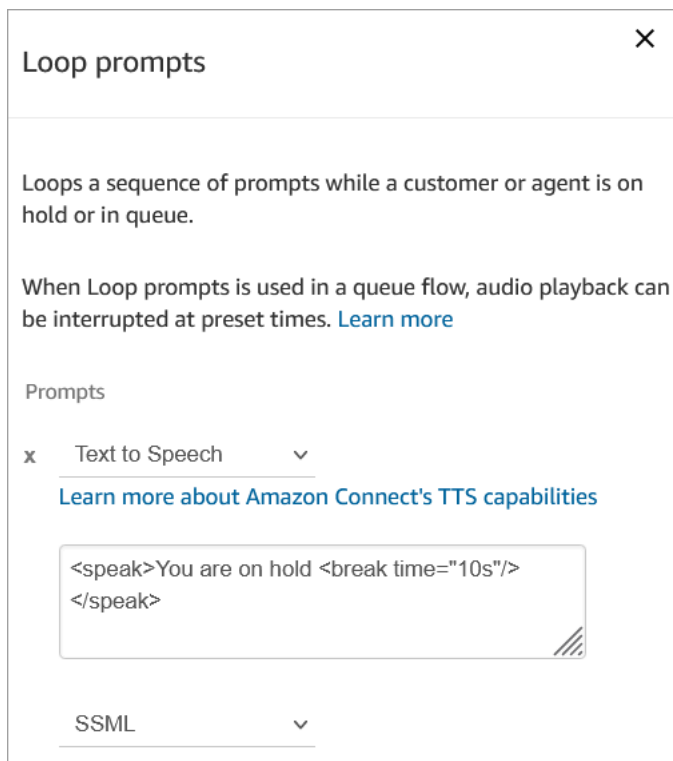

A dialog box titled "Loop prompts" with a close button (X) in the top right corner. It contains the following text:

Loops a sequence of prompts while a customer or agent is on hold or in queue.

When Loop prompts is used in a queue flow, audio playback can be interrupted at preset times. [Learn more](#)

Prompts

x Text to Speech ▾

[Learn more about Amazon Connect's TTS capabilities](#)

```
<speak>You are on hold <break time="10s"/>
</speak>
```

SSML ▾

You can set **break time** to a maximum of 10 seconds. This means the maximum amount time you can specify between **You are on hold** messages is 10 seconds. To make the time between longer, add multiple prompts to the loop. For example, if you want 20 seconds between **You are on hold** messages:

- The first prompt may say **You are on hold** with **break time="10s"**
- Add another prompt with a blank message and **break time="10s"**.

Loop prompts ✕

Loops a sequence of prompts while a customer or agent is on hold or in queue.

When Loop prompts is used in a queue flow, audio playback can be interrupted at preset times. [Learn more](#)

Prompts

x Text to Speech ▼
[Learn more about Amazon Connect's TTS capabilities](#)

```
<Speak>You are on hold <break time="10s"/>
</Speak>
```

SSML ▼

x Text to Speech ▼
[Learn more about Amazon Connect's TTS capabilities](#)

```
<break time="10s"/>
```

Text ▼

For instructions about how to override and change a default flow, see [Change a default flow](#).

Tip

Wondering if a default flow has been changed? Use [flow version control](#) to view the original version of the flow.

Default agent transfer: "Transferring now"

This default transfer flow is what the "from" agent experiences when they transfer a contact to another agent by using [Create quick connects](#). The "from" agent hears a **Play prompt** play the message "Transferring now." Then the **Transfer to agent** block is used to transfer the contact to the agent.

When the contact is transferred, the "to" agent hears the [Default agent whisper](#).

Tip

The **Transfer to Agent** block is a beta feature and only works for voice interactions. To transfer a chat contact to another agent, follow these instructions: [Use contact attributes to route contacts to a specific agent](#).

For instructions about how to override and change a default flow, see [Change a default flow](#).

Tip

Wondering if a default flow has been changed? Use [flow version control](#) to view the original version of the flow.

Default customer queue: queue hold message and music

This default flow is played when a customer is placed in a queue.

1. The loop has a one-time voice prompt:

Thank you for calling. Your call is very important to us and will be answered in the order it was received.

2. It plays queue music in .wav format that's been uploaded to the Amazon Connect instance.
3. The customer remains in this loop until their call is answered by an agent.

Change the default message a customer hears when they are put in queue

The following steps show how to change the default message customers hear when they are put in a queue to wait for the next available agent.

1. On the navigation menu, choose **Routing, Flows**.
2. On the **Flows** page, choose **Default customer queue**, as shown in the following image.

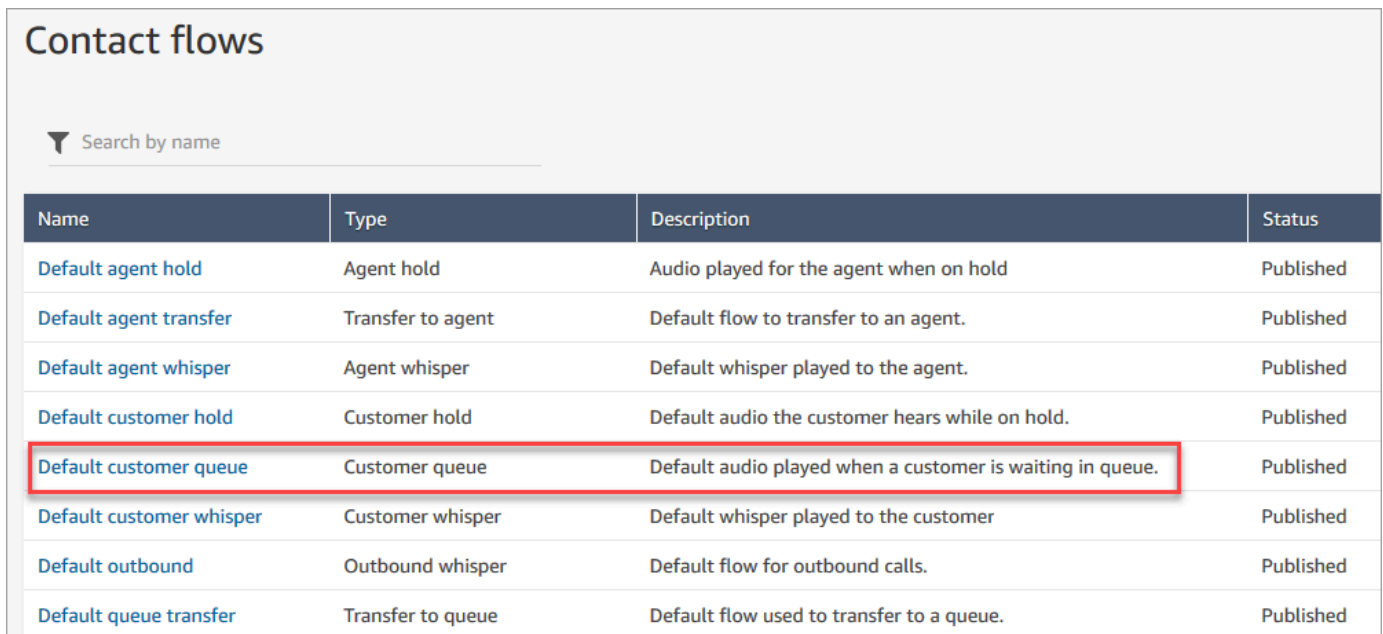

Contact flows

Search by name

Name	Type	Description	Status
Default agent hold	Agent hold	Audio played for the agent when on hold	Published
Default agent transfer	Transfer to agent	Default flow to transfer to an agent.	Published
Default agent whisper	Agent whisper	Default whisper played to the agent.	Published
Default customer hold	Customer hold	Default audio the customer hears while on hold.	Published
Default customer queue	Customer queue	Default audio played when a customer is waiting in queue.	Published
Default customer whisper	Customer whisper	Default whisper played to the customer	Published
Default outbound	Outbound whisper	Default flow for outbound calls.	Published
Default queue transfer	Transfer to queue	Default flow used to transfer to a queue.	Published

3. To customize the message, choose the **Loop prompts** block to open the properties page.

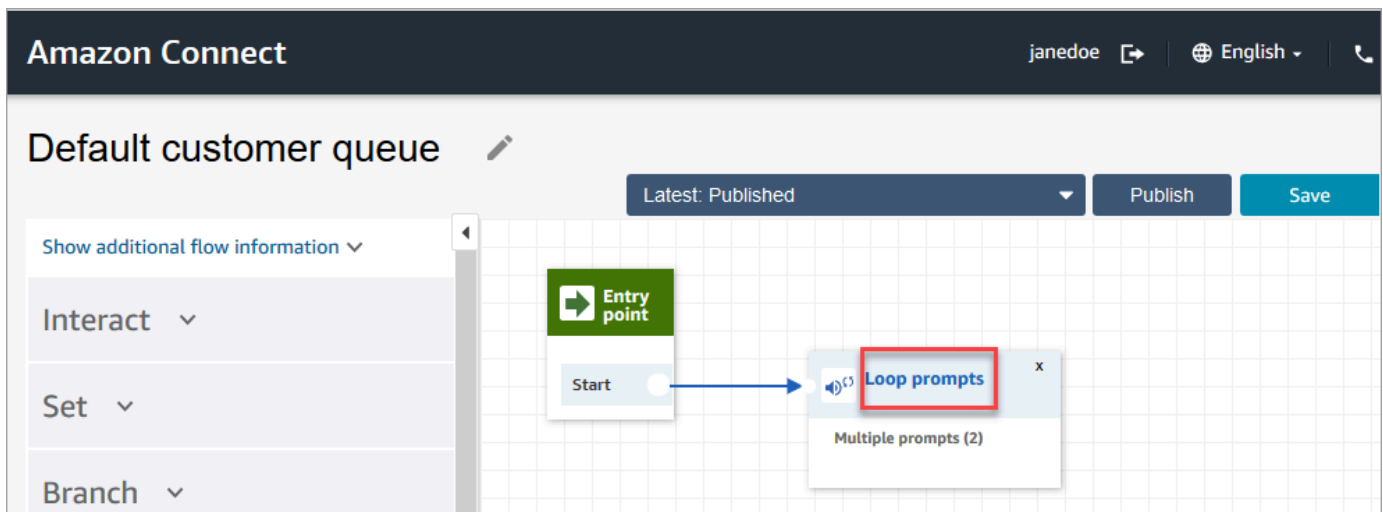

4. Use the dropdown box to either choose different music, or set to **Text to Speech** and then type a message to be played,

For example, the following image shows the message "Thank you for calling. Did you know you can reset your own password at the login page? Choose Reset now, and following the prompts."

Loop prompts

Loops a sequence of prompts while a customer or agent is on hold or in queue.

When Loop prompts is used in a queue flow, audio playback can be interrupted at preset times. [Learn more](#)

Prompts

x Text to Speech

[Learn more about Amazon Connect's TTS capabilities](#)

Thank you for calling. Did you know you can reset your own password at the login page? Choose Reset now, and follow the prompts.

Text

x Audio recording

Music_Pop_ThisAndThatIsLife_Inst.wav

5. Choose **Save** at the bottom of the properties page.
6. Choose **Publish**. Amazon Connect starts playing the new message almost immediately (it may take a few moments for it to fully take effect).

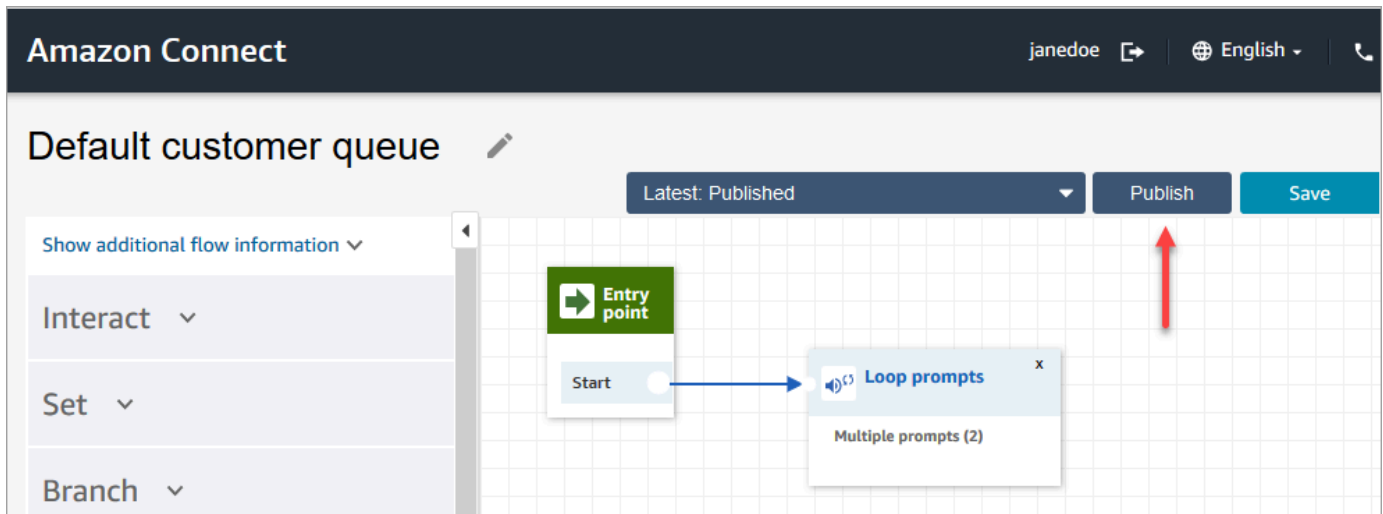

Default customer whisper: beep sound

This flow uses a [Set whisper flow](#) block to play a message for the customer when the customer and agent are joined. It uses a "beep" sound to notify a customer that their call has been connected to an agent.

Use the [Set whisper flow](#) block to override the default agent whisper in a voice conversation.

⚠ Important

For chat conversations, you need to include a [Set whisper flow](#) for default agent or customer whispers to play. For instructions, see [Set the default whisper flow for a chat conversation](#).

Default agent whisper: name of the queue

This flow uses a [Set whisper flow](#) block to play a message for the agent when the customer and agent are joined.

The name of the queue is played to the agent. It identifies the queue that the customer was in. The name of the queue is retrieved from the system variable `$.Queue.Name`.

Use the [Set whisper flow](#) block to override the default agent whisper in a voice conversation.

⚠ Important

For chat conversations, you need to include a [Set whisper flow](#) for default agent or customer whispers to play. For instructions, see [Set the default whisper flow for a chat conversation](#).

For more information about system variables, see [System attributes](#).

💡 Tip

Wondering if a default flow has been changed? Use [flow version control](#) to view the original version of the flow.

Set the default whisper flow for a chat conversation

For chat conversations, you need to include a **Set whisper flow** block for default agent or customer whispers to play.

For example, to set the default whisper flow for chats that use the [Sample inbound flow](#):

1. Go to **Routing, Flows**, and choose the Sample inbound flow.
2. Add a **Set whisper flow** block after the chat channel has branched, as shown in the following image:

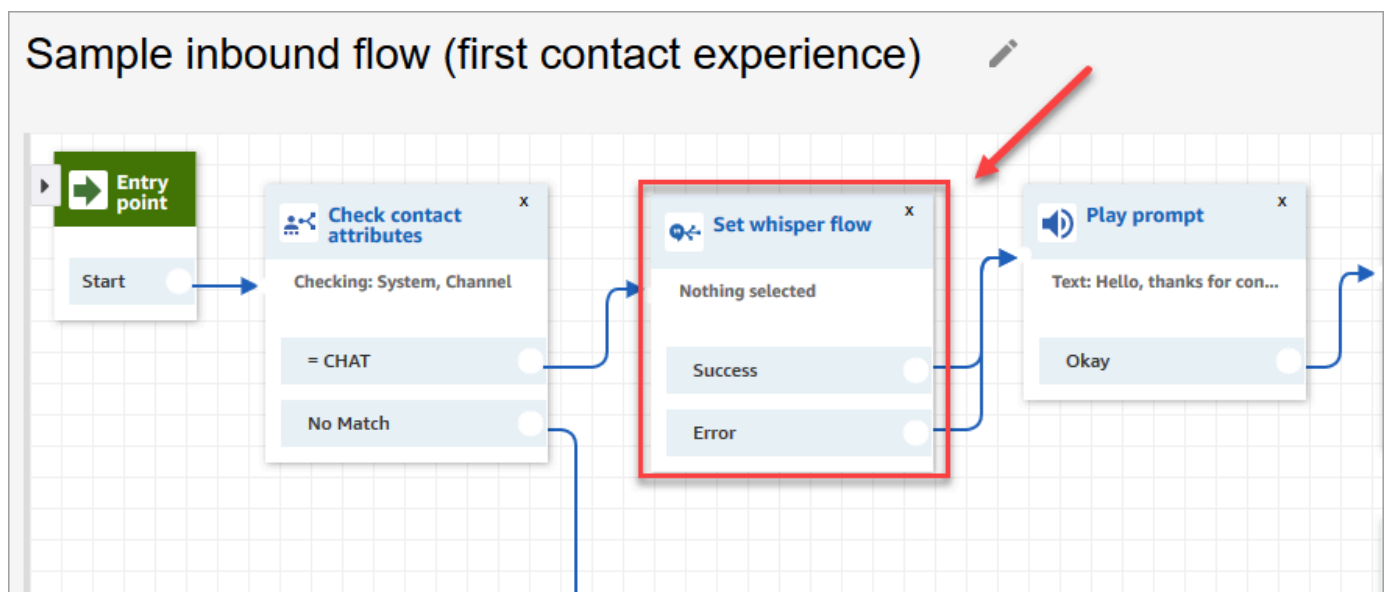

3. In the **Set whisper flow** block, open the properties page, and choose the flow you want to play as the default for chat conversations. For example, you might choose **Default whisper flow** to show agents the name of the originating queue in the chat window. This is helpful when agents are managing more than one queue.

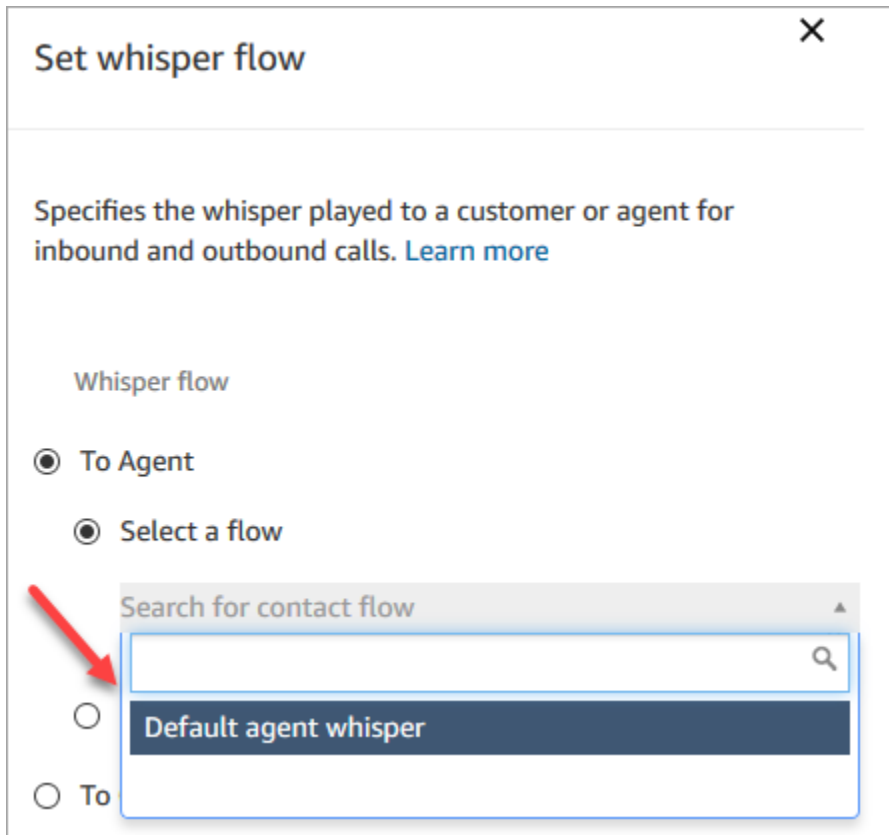

4. Choose **Save**.

Default customer hold: hold music

This flow starts when the customer is put on hold. It plays the audio that the customer hears while on hold.

For instructions about how to override and change a default flow, see [Change a default flow](#).

Tip

Wondering if a default flow has been changed? Use [flow version control](#) to view the original version of the flow.

Default outbound: "This call is not being recorded"

This flow is an outbound whisper that manages what the customer experiences as part of an outbound call, before being connected with an agent.

1. It starts with an optional **Set recording behavior** block. Then a prompt plays the following message:

This call is not being recorded.

2. The flow ends.
3. The customer remains in the system (on the call) after the flows ends.

For instructions about how to override and change a default flow, see [Change a default flow](#).

Tip

Wondering if a default flow has been changed? Use [flow version control](#) to view the original version of the flow.

Default queue transfer: "Now transferring"

This flow manages what the agent experiences when they transfer a customer to another queue.

It starts with a **Check hours of operation** block to check the hours of operation for the current queue. The **In hours** option branches to the **Check staffing** block to determine whether agents are available, staffed, or online.

If it returns **True** (agents are available), the flow goes to the **Transfer to queue** block. If it returns **False** (no agents are available), the flow plays a prompt and disconnects the call.

For instructions about how to override and change a default flow, see [Change a default flow](#).

Tip

Wondering if a default flow has been changed? Use [flow version control](#) to view the original version of the flow.

Default prompts from Amazon Lex: "Sorry .. "

If you add an Amazon Lex classic bot (not Amazon Lex V2) to your contact center, know that it also has some default prompts that it uses for error handling. For example:

- Sorry, can you please repeat that?
- Sorry, I could not understand. Goodbye.

To change default Amazon Lex prompts

1. In Amazon Lex, go to your bot.
2. On the Editor tab, choose Error Handling.
3. Change the text as needed. Choose **Save**, then **Build** and **Publish**.

Sample flows

Amazon Connect includes a set of sample flows that show you how to perform common functions. They are designed to help you learn how to create your own flows that work in a similar way. For example, if you want to add a queued callback flow to your call center, take a look at the [Sample queued callback](#) flow.

To explore how the sample flows work

1. Claim a number if you haven't already: go to **Channels, Phone numbers, Claim a number**.
2. Choose the **DID** tab, then choose a number.
3. In **Flow / IVR** use the drop down to choose the sample flow you want to try. Click **Save**.
4. Call the number. The sample flow that you selected starts.

We recommend opening the sample flow in the flow designer and following along to see how it works while you're experiencing it.

To open a sample flow in the flow designer

1. In Amazon Connect choose **Routing, Flows**.
2. On the **Flows** page, scroll down to the flows with names that start with **Sample**.
3. Choose the flow you want to view.

The topics in this section describe how each of the sample flows work.

Contents

- [Sample inbound flow \(first contact experience\)](#)
- [Sample AB test](#)
- [Sample customer queue priority](#)
- [Sample disconnect flow](#)
- [Sample queue configurations](#)
- [Sample queue customer](#)
- [Sample queued callback](#)
- [Sample interruptible queue flow with callback](#)
- [Sample Lambda integration](#)
- [Sample recording behavior](#)
- [Sample note for screenpop](#)
- [Sample secure input with agent](#)
- [Sample secure input with no agent](#)

Sample inbound flow (first contact experience)

Note

This topic explains a sample flow that is included with Amazon Connect. For information about locating the sample flows in your instance, see [Sample flows](#).

Type: Flow (inbound)

This sample flow is automatically assigned to the phone number that you claimed when you first set up flows. For more information, see [Get started](#).

It uses the [Check contact attributes](#) block to determine if the contact is contacting you by phone or chat, or if it is a task, and to route them accordingly.

- If the channel is chat or task, the contact is transferred to the [Sample queue configurations](#).

- If the channel is voice, then based on user input the contact is either transferred to the other sample flows or a sample follow-up agent task is created for this contact.

The following image shows the sample inbound flow. We recommend viewing the flow in the flow designer so you can see the details.

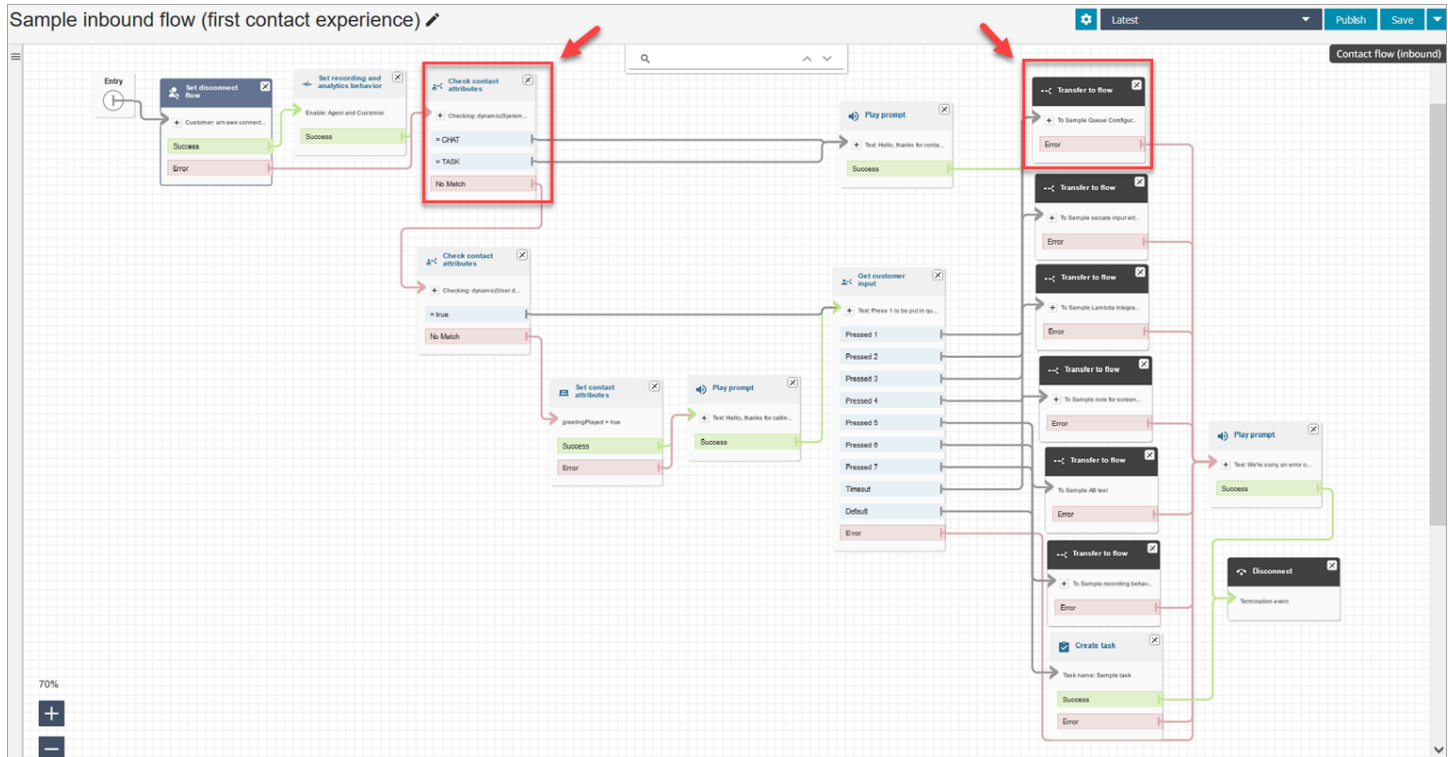

Sample AB test

Note

This topic explains a sample flow that is included with Amazon Connect. For information about locating the sample flows in your instance, see [Sample flows](#).

Type: Flow (inbound)

This flow shows how to perform an A/B call distribution based on a percentage. Here's how it works:

1. The **Play prompt** block uses Amazon Polly, the text-to-speech service, to say "Amazon Connect will now simulate rolling dice by using the Distribute randomly block. Now rolling."

2. The contact reaches the **Distribute by percentage** block, which routes the customer randomly based on a percentage.

Distribute by percentage simulates a dice roll, resulting in a values between 2 to 12 with different percentages. For example, there is 3 percent chance for the "2" option, 6 percent chance for the "3" option, and so on.

3. After the contact gets routed, the **Play prompt** tells the customer which number the dice rolled.
4. At the end of the sample, the **Transfer to flow** block transfers the customer back to the [Sample inbound flow](#).

Sample customer queue priority

Note

This sample flow is available in previous Amazon Connect instances. In new instances, you can see this functionality in [Sample queue configurations](#).

Type: Flow (inbound)

By default the priority for new contacts is 5. Lower values raise the priority of the contact. For example, a contact assigned a priority of 1 is routed first.

This sample shows how you can use the **Change routing priority/age block** to raise or lower the priority of a contact in a queue. Using this block, there are two ways you can raise or lower a customer's priority:

- Assign them a new priority value, such as 1, to raise their priority.
- Or, increase the routing age of the contact. Customers who are queued longer are routed first, when all contacts have the same queue priority value (such as 5).

Option 1: Raise the priority

- The **Get Customer Input** block prompts the customer to press 1 to move to the front of the queue. This block gets the customer's input; it doesn't actually change the customer's priority.

- If the customer presses 1, they go down the "Pressed 1" branch, which takes them to the **Change routing priority/age block**. This block changes their priority in the queue to 1, which is the highest priority.

Option 2: Change the routing age

- The **Get Customer Input** block prompts the customer to press 2 to move behind existing contacts already in queue. This block gets the customer's input; it doesn't actually change the customer's priority.
- If the customer presses 2, they go down the "Pressed 2" branch, which takes them to a different **Change routing priority/age block**. This block increases their routing age by 10 minutes. This has the effect of moving them ahead of others in the queue who have been waiting longer.

Sample disconnect flow

Note

This topic explains a sample flow that is included with Amazon Connect. For information about locating the sample flows in your instance, see [Sample flows](#).

Type: Flow (inbound)

This sample works with voice, chat, and task contacts.

Chat contacts

1. The **Play prompt** block shows a text message that the agent has disconnected.
2. A **Wait** block sets the timeout period for 15 minutes. If the customer returns in 15 minutes, the customer is transferred to a queue to chat with another agent.
3. If the customer doesn't return, the timer expires and the chat disconnects.

Voice contacts

1. Sets a user-defined attribute, DisconnectFlowRun. If it = Y, disconnect.
2. Gets customer input, whether they were happy with service.

3. Terminates flow.

Task contacts

1. Checks contact attributes, whether Agent ARN = NULL.
2. Transfers to agent's queue.
3. If at capacity, disconnects.

For a list and description of all the disconnect reasons, see **DisconnectReason** in the [ContactTraceRecord](#).

Sample queue configurations

Note

This topic explains a sample flow that is included with Amazon Connect. For information about locating the sample flows in your instance, see [Sample flows](#).

Type: Flow (inbound)

This flow shows different ways you can put a customer in queue: you can change the priority of the customer, determine the wait time in queue, and give them an option for a callback. Here's how it works:

1. The customer is put in the BasicQueue.
2. After that, the **Default customer queue** flow is invoked. This block runs a **Loop prompts** block that plays the following:

Thank you for calling. Your call is very important to us and will be answered in the order it was received.

3. The hours of operation are checked with a **Check hours of operation** block.
4. The channel is checked with a **Check contact attributes** block:
 - If chat, we check the time in queue. If it's less than 5 minutes, the customer is placed in queue for an agent. If it's more, we check the channel again and if it's chat, put the customer in queue for an agent.

- If voice, the customer is routed down the **No Match** branch, to a **Play prompt** block and then to a **Get customer input** block.

In the **Get customer input** block, we give the customer the option to press 1 to move to the front of the queue or 2 to move to the end of the queue.

The two **Change routing priority / age** blocks move the customer to the front or back of the queue.

The following image of the sample flow shows this page highlighted:

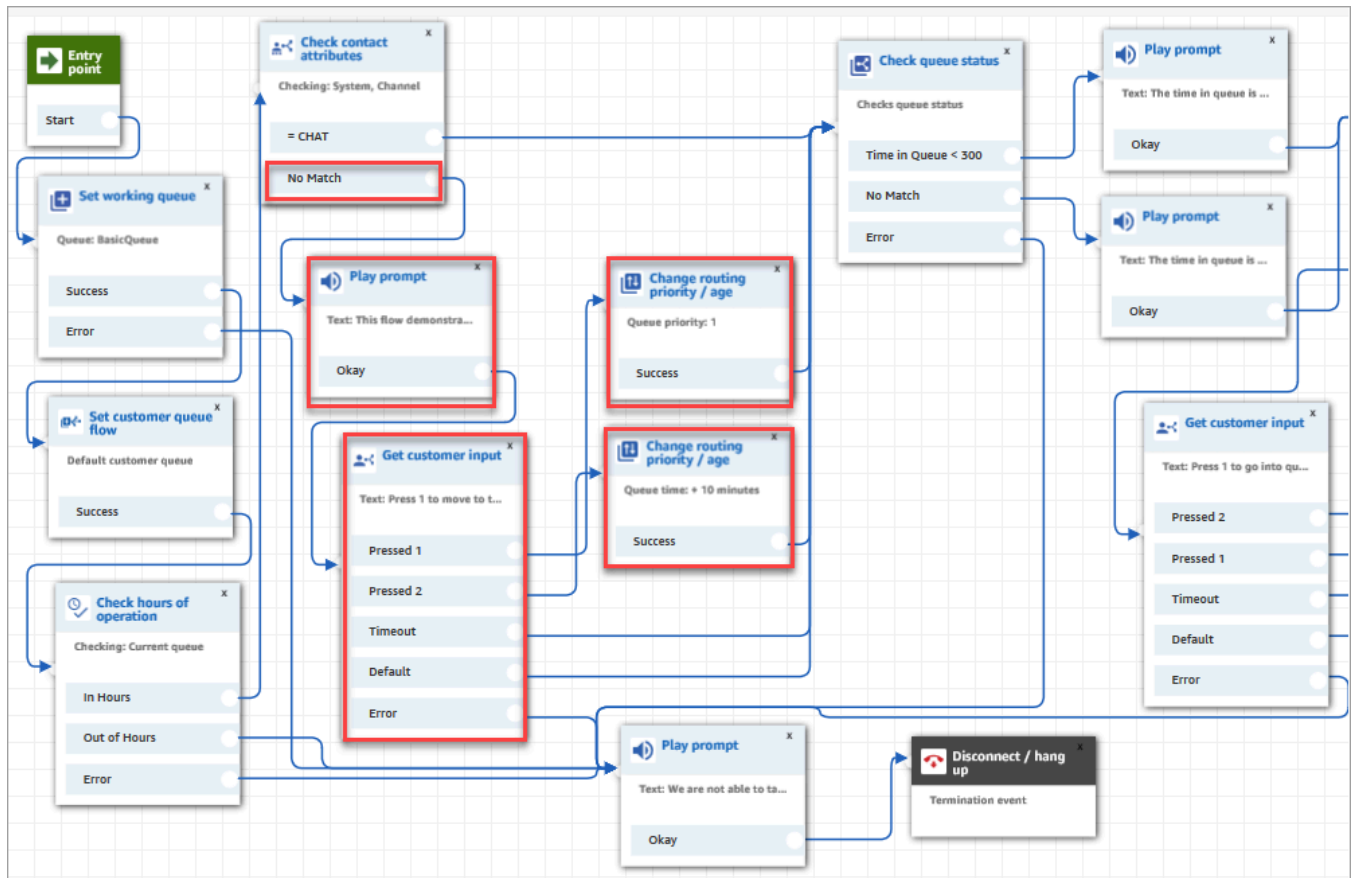

5. Next we use a **Check queue status** block to check whether the time in queue is less than 300 seconds.
6. We use a **Play prompt** block to tell the customer the results.
7. We use a **Check contact attributes** block again to check the customer's channel: chat or voice/No Match.

These next steps apply to customers who were routed down the voice/**No Match** branch, as shown in the following image:

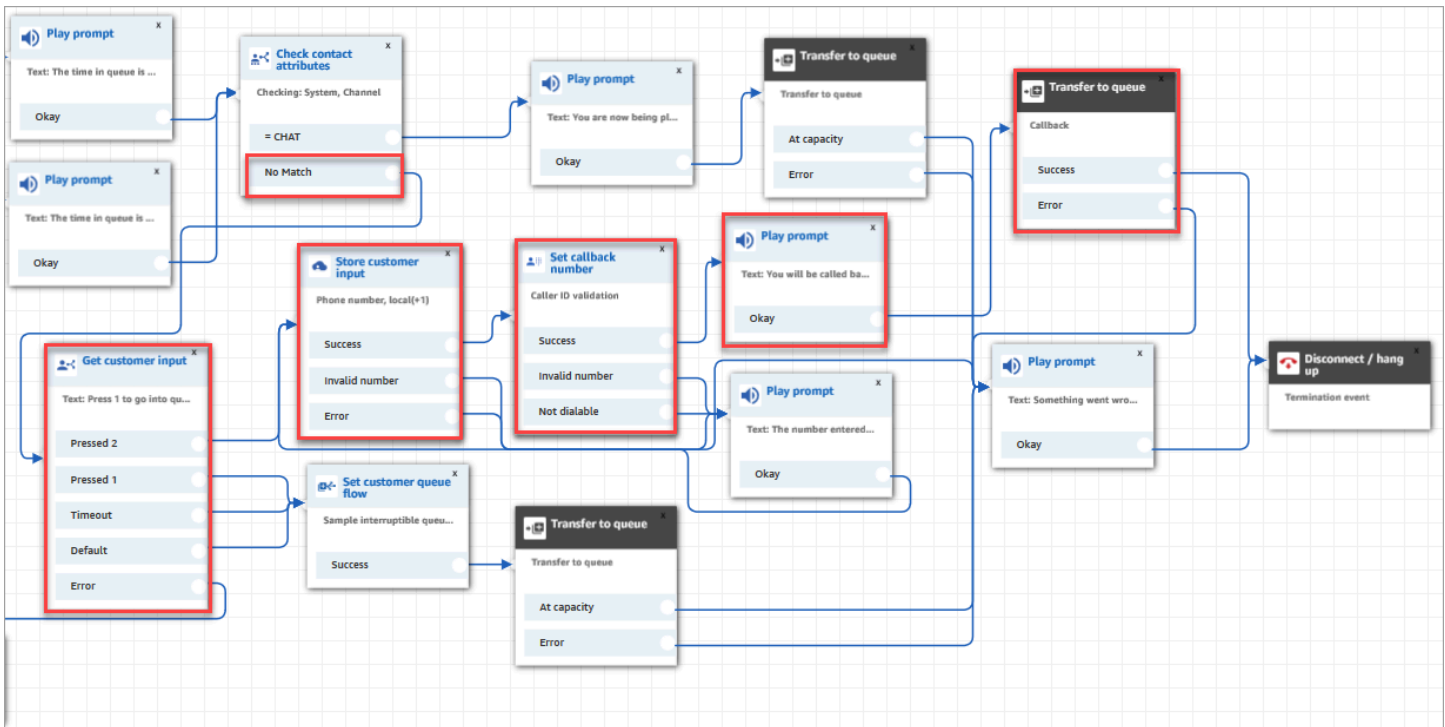

1. In the **Get customer input** block, we prompt customers to *Press 1 to go into queue or 2 to enter a callback number*.
2. If customers press 2, they are routed down the **Pressed 2** branch to the **Store customer input** block.
3. The **Store customer input** block prompts the customer for their phone number.
4. The customer's phone number is stored in the **Stored customer input attribute**, by the **Set callback number** block.
5. We use a [Transfer to queue](#) block to put the customer in a callback queue.
6. The [Transfer to queue](#) block is configured so Amazon Connect waits 5 seconds between the time the callback contact is initiated and the contact is enqueued, where it sits until it is offered to an available agent.

If the initial callback doesn't reach the customer, Amazon Connect will attempt 1 callback. If it were configured for 2 attempted callbacks, it would wait 10 minutes between each one.

Also, no special callback queue is specified. Rather, customers are in the BasicQueue, which was set at the beginning of the flow.

Transfer to queue

Ends the current contact flow and transfers the customer to a queue.

Transfer to queue
 Transfer to callback queue

When you use Transfer to callback queue, you must use a 'Set customer callback number' block before this block in the flow to set the callback number for the customer.

Initial delay

5

in seconds

Maximum amount of attempts	Minimum time between attempts	
1	10	0
	minutes	seconds

Optional parameters:

Set working queue

For information about queued callbacks, see the following topics:

- [Set up queued callback by creating flows, queues, and routing profiles](#)
- [Flow block: Transfer to queue](#)
- [About queued callbacks in metrics](#)

Sample queue customer

Note

This topic explains a sample flow that is included with Amazon Connect. For information about locating the sample flows in your instance, see [Sample flows](#).

Type: Flow (inbound)

This flow performs checks before placing customer into a queue. Here's how it works:

1. The **Set working queue** block determines which queue to transfer the customer to.
2. The **Check hours of operation** block perform checks to avoid the customer being queued during non-working hours.
3. The customer is transferred to the queue if it is within business hours, and the queue can handle this call. Otherwise, the customer is played a message "We are not able to take your call right now. Goodbye." And then the customer is disconnected.

Sample queued callback

Note

This sample flow is available in previous Amazon Connect instances. In new instances, you can see examples of queued callback in [Sample interruptible queue flow with callback](#) and [Sample queue configurations](#).

Type: Flow (inbound)

This flow provides callback queue logic. Here's how it works:

1. After a voice prompt, a working queue is selected and its queue status is checked.
2. A voice prompt tells the customer if the wait time for the selected queue is longer than 5 minutes. Customers are offered a choice to wait in the queue or to be placed into a callback queue.
3. If the customer decides to wait in the queue, the **Set customer queue flow** block places them in a queue flow that provides a callback option. That is, it places them in **Sample interruptible queue flow with callback**.
4. If the customer chooses to be placed into a callback queue, their number is stored in the **Store customer input** block. Then their callback number is set, and they are transferred to the callback queue.

For information about queued callbacks, see the following topics:

- [Set up queued callback by creating flows, queues, and routing profiles](#)

- [Flow block: Transfer to queue](#)
- [About queued callbacks in metrics](#)

Sample interruptible queue flow with callback

Note

This topic explains a sample flow that is included with Amazon Connect. For information about locating the sample flows in your instance, see [Sample flows](#).

Type: Customer queue

This flow shows you how to manage what the customer experiences while in queue. It uses **Check contact attributes** to determine if the customer is contacting you by phone or chat, and to route them accordingly.

If the channel is chat, the customer is transferred to the **Loop prompts**.

If the channel is voice, the customer hears a looping audio that interrupts every 30 seconds to give them two options from the **Get customer input** block:

1. The customer can press 1 to enter a callback number. Then the **Get customer input** block prompts the customer for their phone number. Then the flow ends.
2. Press 2 ends the flow, and the customer remains in the queue.

Sample Lambda integration

Note

This topic explains a sample flow that is included with Amazon Connect. For information about locating the sample flows in your instance, see [Sample flows](#).

Type: Flow (inbound)

This flow shows you how to invoke a Lambda function and do a data dip, that is, retrieve information about the customer. The data dip uses the caller's phone number to look up the US state they are calling from. If the customer is using chat, it returns a fun fact. Here's how it works:

1. A prompt tells the customer that a data dip is being performed.
2. The Invoke Lambda function block triggers **sampleLambdaFlowFunction**. This sample Lambda function determines the location of the phone number. The function times out in 4 seconds. If it times out, it plays a prompt that says "Sorry, we failed to find the state for your phone number's area code."
3. In the first **Check contact attributes** block, it checks the channel the customer is using: voice, chat, task. If chat, it returns a fun fact.
4. If voice, the second **Check contact attributes** block is triggered. It checks the match conditions of **State**, which is an external attribute. It uses an external contact attribute because it's getting data by using a process that's external to Amazon Connect
5. A prompt tells you that it's returning you back to **Sample inbound flow**, and then starts the **Transfer flow** block.
6. If the transfer fails, it plays a prompt and then disconnects the contact.

For more information about using attributes, see [Lambda functions and attributes](#).

Sample recording behavior

Note

This topic explains a sample flow that is included with Amazon Connect. For information about locating the sample flows in your instance, see [Sample flows](#).

Type: Flow (inbound)

This flow starts by checking the channel of the contact:

- If the contact is a task, it is transferred to the Sample inbound flow.
- If the customer is using chat, they get a prompt that the **Set recording block** enables managers to monitor chat conversations. (To *record* chats, you only need to specify an Amazon S3 bucket where the conversation will be stored.)

To monitor chats, the **Set recording block** is configured to record both the **Agent and Customer**.

- If the contact is using voice, a **Get customer input** block prompts them to enter the number for who they want to record. Their entry triggers the **Set recording behavior** block with the appropriate configuration.

It ends with the customer being transferred by to the [Sample inbound flow](#).

For more information, see the following topics:

- [Set up recording behavior](#)
- [Set up live monitoring for voice and/or chat](#)
- [Review recorded conversations between agents and customers using Amazon Connect](#)

Sample note for screenpop

Note

This topic explains a sample flow that is included with Amazon Connect. For information about locating the sample flows in your instance, see [Sample flows](#).

Type: Flow (inbound)

This flow shows you how to use Screenpop, a Contact Control Panel feature, to load a web page with parameters based on attributes.

In this sample flow, a **Set contact attributes** block is used to create an attribute from a text string. As an attribute, the text can be passed to the CCP to display a note to an agent.

Sample secure input with agent

Note

This topic explains a sample flow that is included with Amazon Connect. For information about locating the sample flows in your instance, see [Sample flows](#).

Type: Queue transfer

This flow shows you how to allow customers to input sensitive data while putting the agent on hold. In a production environment, we recommend [using encryption](#) instead of this solution.

Here's how it works:

1. This flow begins with checking the customer's channel. If they are using chat, they are put in a queue.
2. If they are using voice, the agent and customer are put in a conference call.
3. A **Play prompt** tells the customer that the agent will be put on hold while customer enters their credit card information.
4. When the prompt is finished playing, the agent is put on hold using a **Hold customer or agent** block. If an error occurs, a prompt is played that agent was unable to put on hold, after which the contact flow is ended.
5. The customer's input is stored using the **Store Customer Input** block. This block encrypts the sensitive customer information using a signing key that must be uploaded in .pem format. For a detailed walkthrough that explains how to encrypt customer input, see [Creating a secure IVR solution with Amazon Connect](#).
6. After the customer's data is collected, the agent and customer are put back on call using the **Conference All** option in another **Hold customer or agent** block.
7. The error branch runs if there's an error while capturing the customer's data.

Sample secure input with no agent

Note

This topic explains a sample flow that is included with Amazon Connect. For information about locating the sample flows in your instance, see [Sample flows](#).

Type: Flow (inbound)

This flow shows you how to capture sensitive customer data and encrypt it using a key. Here's how it works:

1. It begins by checking the contact's channel. If they are using chat, a prompt is played that this doesn't work with chat, and they are transferred to [Sample inbound flow](#).
2. If they are using voice, the **Store customer input** block prompts them to enter their credit card number. The block stores and also encrypts the data using a signing key that must be uploaded in a .pem format.

In the **Set contact attributes** block, the encrypted card number is set as contact attribute.

3. After the card number is successfully set as contact attribute, the customer is transferred back to the [Sample inbound flow](#).

Flow block definitions

Use flow blocks to create flows in the flow designer. Drag flow blocks and drop them onto a canvas to arrange a flow.

The following table lists all available flow blocks that you can use. Choose any block name in the Block column for more information.

Block	Description
Amazon Q in Connect	Associates an Amazon Q in Connect domain to a contact to enable real-time recommendations.
Call phone number	Initiates an outbound call from an outbound whisper flow.
Cases	Gets, updates, and creates cases.
Change routing priority / age	Changes the priority of the contact in queue. You may want to do this, for example, based on the contact's issue or other variable.

Block	Description	
Check call progress	Engages with the output provided by an answering machine, and provides branches to route the contact accordingly. This block works with outbound campaigns only.	
Check contact attributes	Checks the values of contact attributes.	
Check hours of operation	Checks whether the contact is occurring within or outside of the hours of operation defined for the queue.	
Check queue status	Checks the status of the queue based on specified conditions.	
Check Voice ID	Branches based on the enrollment status, voice authentication status, or status of detection of fraudsters in a watchlist of the caller returned by Voice ID.	
Check staffing	Checks the current working queue, or queue you specify in the block, for whether agents are available, staffed, or online. Staffed availability could be on call, or after contact work status.	

Block	Description	
Create persistent contact association	Specify an attribute to create a persistent contact association, enabling conversations to continue from where they left off.	
Create task	Creates a new task, sets the tasks attributes, and initiates a contact flow to start the task. To learn more about Amazon Connect Tasks, see Concepts: Tasks in Amazon Connect .	
Customer profiles	Enables you to retrieve, create, and update a customer profile.	
Disconnect / hang up	Disconnects a contact.	
Distribute by percentage	Routes customers randomly based on a percentage.	
End flow / Resume	Ends the current flow without disconnecting the contact.	
Get customer input	Branches based on customer intent.	
Get queue metrics	Retrieves real-time metrics about queues and agents in your contact center and returns them as attributes.	
Hold customer or agent	Places a customer or agent on or off hold.	

Block	Description	
Invoke AWS Lambda function	Calls AWS Lambda, optionally returns key-value pairs.	
Invoke module	Calls a published module.	
Loop	Loops through, or repeats, the Looping branch for the number of loops specified.	
Loop prompts	Loops a sequence of prompts while a customer or agent is on hold or in queue.	
Play prompt	Plays an interruptible audio prompt, delivers a text-to-speech message, or delivers a chat response.	
Resume contact	Resumes a contact from a paused state.	
Return (from module)	Exits the flow module after it has run successfully.	
Set callback number	Sets a callback number.	
Set contact attributes	Stores key-value pairs as contact attributes.	
Customize the name of a block	Allows you to specify custom names for your flow blocks.	
Set customer queue flow	Specifies the flow to invoke when a customer is transferred to a queue.	

Block	Description
Set disconnect flow	Sets the flow to run after a disconnect event.
Set event flow	Specifies which flow to run during a contact event.
Set hold flow	Links from one flow type to another.
Set logging behavior	Enables flow logs so you can track events as contacts interact with flows.
Set Voice ID	When the call is connected to a flow, sends audio to Amazon Connect Voice ID to verify the caller's identity and match against fraudsters on a watch list.
Set recording and analytics behavior	Sets options for recording conversations.
Set voice	Sets the text-to-speech (TTS) language and voice to be used in the flow.
Set whisper flow	Overrides the default whisper by linking to a whisper flow.
Set working queue	Specifies the queue to be used when Transfer to queue is invoked.

Block	Description
Show view	Configures UI based workflows that you can surface to users in front end applications.
Start media streaming	Starts capturing customer audio for a contact.
Stop media streaming	Stops capturing customer audio after it is started with a Start media streaming block.
Store customer input	Stores numerical input to a contact attribute.
Transfer to agent (beta)	Transfers the customer to an agent.
Transfer to flow	Transfers the customer to another flow.
Transfer to phone number	Transfers the customer to a phone number external to your instance.
Transfer to queue	In most flows, this block ends the current flow and places the customer in queue. When used in a customer queue flow, this block transfers a contact already in a queue to another queue.
Wait	Pauses the flow.

Supported channels for flow blocks

The following table lists all available flow blocks, and whether they support routing a contact through the specified channels.

Block	Voice	Chat	Task
Amazon Q in Connect	Yes	Yes	No - Error branch
Call phone number	Yes	No - Error branch	No - Error branch
Cases	Yes	Yes	Yes
Change routing priority / age	Yes	Yes	Yes
Check call progress	Yes	No - Error branch	No - Error branch
Check contact attributes	Yes	Yes	Yes
Check hours of operation	Yes	Yes	Yes
Create persistent contact association	No - Error branch	Yes	No - Error branch
Check queue status	Yes	Yes	Yes
Check Voice ID	Yes	No - Error branch	No - Error branch
Check staffing	Yes	Yes	Yes
Create task	Yes	Yes	Yes
Customer profiles	Yes	Yes	Yes
Disconnect / hang up	Yes	Yes	Yes
Distribute by percentage	Yes	Yes	Yes

Block	Voice	Chat	Task
End flow / Resume	Yes	Yes	Yes
Get customer input	Yes	Yes when Amazon Lex is used Otherwise, No - Error branch	Yes
Get queue metrics	Yes	Yes	Yes
Hold customer or agent	Yes	No - Error branch	No - Error branch
Invoke AWS Lambda function	Yes	Yes	Yes
Invoke module	Yes	Yes	Yes
Loop	Yes	Yes	Yes
Loop prompts	Yes	No - Error branch	No - Error branch
Play prompt	Yes	Yes	No - takes the Okay branch, but it has no effect
Resume contact	No - Error branch	No - Error branch	Yes
Return (from module)	Yes	Yes	Yes
Set callback number	Yes	No - Error branch	No - Error branch
Set contact attributes	Yes	Yes	Yes
Set customer queue flow	Yes	Yes	Yes
Set disconnect flow	Yes	Yes	Yes

Block	Voice	Chat	Task
Set hold flow	Yes	No - Error branch	No - Error branch
Set logging behavior	Yes	Yes	Yes
Set recording and analytics behavior	Yes	Yes	No - Error branch
Set Voice ID	Yes	No - Error branch	No - Error branch
Set voice	Yes	No - Success branch	No - Success branch
Set whisper flow	Yes	Yes	Yes
Set working queue	Yes	Yes	Yes
Show view	No - Error branch	Yes	No - Error branch
Start media streaming	Yes	No - Error branch	No - Error branch
Stop media streaming	Yes	No - Error branch	No - Error branch
Store customer input	Yes	No - Error branch	No - Error branch
Transfer to agent (beta)	Yes	No - Error branch	No - Error branch
Transfer to flow	Yes	Yes	Yes
Transfer to phone number	Yes	No - Error branch	No - Error branch
Transfer to queue	Yes	Yes	Yes
Wait	No - Error branch	Yes	Yes

Flow block: Amazon Q in Connect

Description

- Associates an Amazon Q in Connect domain to a contact to enable real-time recommendations.
- For more information about enabling Amazon Q in Connect, see [Use Amazon Q in Connect for generative AI-powered agent assistance in real-time](#).

Supported channels

The following table lists how this block routes a contact who is using the specified channel.

Note

Nothing happens if a task is sent to this block, however, **you will be charged**. To prevent this, add a [Check contact attributes](#) block before this one and route tasks accordingly. For instructions, see [Route based on contact's channel](#).

Channel	Supported?
Voice	Yes
Chat	Yes
Task	No

Flow types

You can use this block in the following [flow types](#):

- Inbound flow
- Customer Queue flow
- Outbound whisper flow
- Transfer to Agent flow
- Transfer to Queue flow

Properties

The following image shows the **Properties** page of the **Amazon Q in Connect** block. It specifies the full Amazon Resource Name (ARN) of the Amazon Q in Connect domain to associate to the contact.

Block Type



Amazon Q Connect

Block Name

Enter a block name

0 / 50

Associate an Amazon Q Connect domain to the current contact. Amazon Q Connect recommends solutions to resolve customer issues. This block, along with Contact Lens Real-Time analytics, is used to recommend content that is related to customer issues detected during the current contact. The Set recording and analytics behavior block with Contact Lens real-time enabled must also be set in this flow for Amazon Q Connect recommendations to work. [Learn more](#)

Select a domain

Associate an Amazon Q Connect domain to this contact that will be passed through the flow as part of ContactData

Set manually

arn:aws: :us-west-2:2721 :assistant/dd02e2d4-

Configuration tips

- To use Amazon Q in Connect with calls, you must enable Amazon Connect Contact Lens in the flow by adding a [Set recording and analytics behavior](#) block that is configured for Contact Lens real-time. It doesn't matter where in the flow you add the [Set recording and analytics behavior](#) block.

Amazon Q in Connect, along with Contact Lens real-time analytics, is used to recommend content that is related to customer issues detected during the current call.

- Contact Lens is not required to use Amazon Q in Connect with chats.

Configured block

The following image shows an example of what this block looks like when it is configured. It has the following branches: **Success** and **Error**.

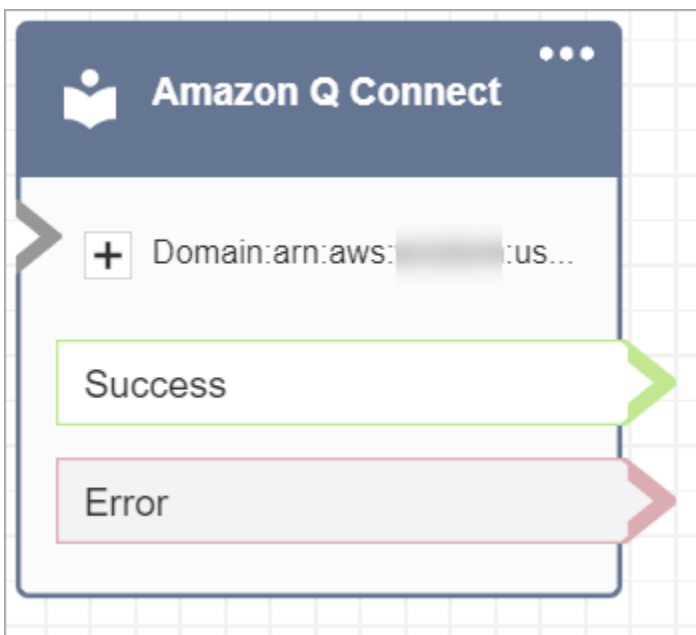

Flow block: Call phone number

Description

- Use to place an outbound call from an **Outbound Whisper** flow.

Supported channels

The following table lists how this block routes a contact who is using the specified channel.

Channel	Supported?
Voice	Yes
Chat	No - Error branch
Task	No - Error branch

Flow types

You can use this block in the following [flow types](#):

- Outbound Whisper flow

Properties

The following image shows an example of what the **Call phone number** properties page looks like when you select a phone number manually. The **Select a number from your instance** option is selected, and the dropdown menu displays a list of available phone numbers claimed for your instance.

Call phone number

Initiates a call to a phone number for voice interactions. Specify a caller ID or the caller ID set for the queue is displayed. [Info](#)

Transfer via

Phone number

Caller ID number to display (optional)

Select a number from your instance

Number

+1: [redacted]

+1: [redacted]

The following image shows an example of what the **Call phone number** properties page looks like when you select a phone number dynamically. The **Use Attribute** option is selected. The **Namespace** box is set to **User-defined**. The **Attribute** box is set to **MainPhoneNumber**.

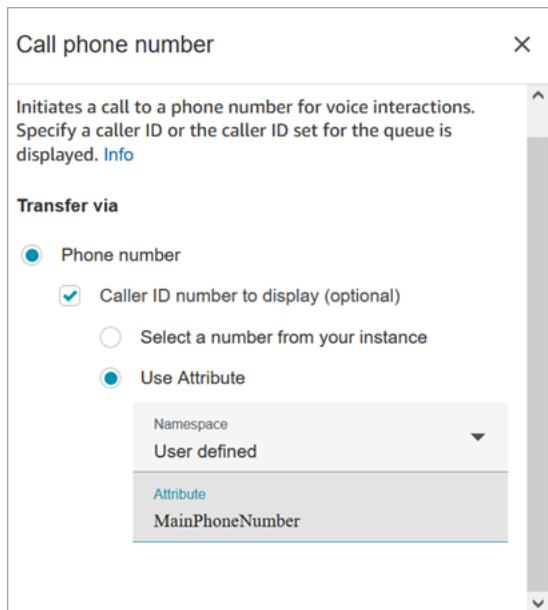

Call phone number

Initiates a call to a phone number for voice interactions. Specify a caller ID or the caller ID set for the queue is displayed. [Info](#)

Transfer via

Phone number

Caller ID number to display (optional)

Select a number from your instance

Use Attribute

Namespace
User defined

Attribute
MainPhoneNumber

Outbound whisper flows run in Amazon Connect immediately after an agent accepts the call during direct dial and callback scenarios. When the flow runs:

- The caller ID number is set if one is specified in the [Call phone number](#) block.
- If no caller ID is specified in the [Call phone number](#) block, the caller ID number defined for the queue is used when the call is placed.
- When there is an error with a call that is initiated by the [Call phone number](#) block, the call is disconnected and the agent is placed in **AfterContactWork** (ACW).

Only published flows can be selected as the outbound whisper flow for a queue.

Note

To use a custom caller ID, you must open an AWS Support ticket to enable this feature. For more information, see [Set up outbound caller ID](#).

Configured block

The following image shows an example of what this block looks like when it is configured. It shows the **Caller ID** phone number, and a **Success** branch.

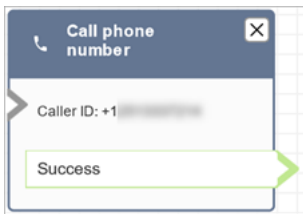

There is no error branch for the block. If a call is not successfully initiated, the flow ends and the agent is placed in an **AfterContactWork** (ACW).

Sample flows

Amazon Connect includes a set of sample flows. For instructions that explain how to access the sample flows in the flow designer, see [Sample flows](#). Following are topics that describe the sample flows which include this block.

- [Sample customer queue priority](#)
- [Sample queue configurations](#)

Scenarios

See these topics for more information about caller ID works:

- [Set up outbound caller ID](#)

Flow block: Cases

Tip

Be sure to [enable](#) Amazon Connect Cases before using this block. Otherwise, you can't configure its properties.

Description

- Gets, updates, and creates cases.

- You can link a contact to a case, and then the contact will be recorded in the **Activity feed** of the case. When the agent accepts a contact that is linked to a case, the case automatically opens as a new tab in the agent application.
- While you can link contacts to multiple cases, there is a limit of five new case tabs automatically opening in the agent application. These will be the five most recently updated cases.
- For more information about cases, see [Amazon Connect Cases](#).

Supported channels

The following table lists how this block routes a contact who is using the specified channel.

Channel	Supported?
Voice	Yes
Chat	Yes
Task	Yes

Flow types

You can use this block in the following [flow types](#):

- All flows

Properties: Get case

Tip

The following screenshots refer to the legacy flow designer.

When configuring properties to get a case:

- You must provide at least one search criteria. Otherwise this block will take the **Error** branch.

You can either use attribute in the Cases namespace or set manually. If you set manually, see to the syntax in [How to persist fields throughout the flow](#).

- To get cases for a given customer, add a [Customer profiles](#) block to the flow before creating the case. The following image shows the flow designer with a **Customer profiles** block linked from the Success branch to a **Cases** block.

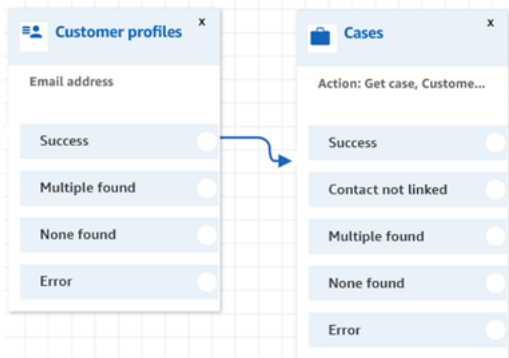

Configure the [Customer profiles](#) block to get the customer profile. The following image shows an example of the **Customer profiles** properties page when it is configured. The **Action** box is set to **Get profile**. The **Select a search key** box is set to **Email address**. The **Use attribute** option is selected. The **Type** box is set to **Customer**. The **Attribute** box is set to **Email address**. The **Response fields** are set to **First name, Last name**.

Customer profiles

Get, update, or create a customer profile.

The customer's profile ID automatically persists for new or existing customer profiles as a system attribute. [Learn more](#)

Select an action

Action
Get profile ↖

Select a search key
Email address

Email address

Set manually

Use attribute

Type
Customer

Attribute
Email address

Response fields

Select the standard profile attributes to identify an incoming contact, and use in subsequent flow blocks.

First name , Last name ✕ ▼

First name ✕ Last name ✕

Cancel Save

In the **Cases** block, on the **Properties** page configure the **Customer ID** section as shown in the following image. The **Link contact to case** option is set to **Yes**. The **Request fields** box is set to **Customer Id**. In the **Customer Id** section, the **Use attribute** option is selected. The **Type** box is set to **Customer**. The **Attribute** box is set to **Profile ARN**.

The image shows the configuration for the 'Get case' action in Amazon Connect. The 'Link contact to case' option is set to 'Yes'. The 'Request fields' section is set to 'Customer Id'. A modal window for 'Customer Id' configuration is open, showing 'Use attribute' selected, 'Type' set to 'Customer', and 'Attribute' set to 'Profile ARN'.

- You can specify to get only the last updated case for any search criteria. This can be achieved by selecting **Get last updated case**.
- You can persist case fields in the case namespace to make use of them in blocks that are in your flow after the **Cases** block that is configured to **Get case**. This can be achieved by making use of the **Response fields** section and selecting fields that you want to use in the other blocks.

You can either use attribute in the Cases namespace or set manually. If you set manually, see to the syntax in [How to persist fields throughout the flow](#).

- The **Get case** properties show the options for the single-select field type.
- The **Get case** properties use the Contains function for text field type.
- The **Get case** properties use the EqualTo function for fields of type: number, boolean.
- The **Get case** properties use greater than or equal to for any date field search.
- Contacts can be routed down the following branches:
 - **Success:** The case was found.

- **Contact not linked:** If you specify to link the contact to case, then this error branch will appear. It might be that the contact was not linked after the case is retrieved (partial success/partial failure). If this happens, then the flow will follow this branch.
- **Multiple found:** Multiple cases are found with the search criteria.
- **None found:** No cases are found with the search criteria.
- **Error:** An error was encountered while trying to find the case. This may be due to a system error or how **Get case** is configured.

The following images show an example of a Cases **Properties** page that is configured for the **Get case** action.

The first image shows the **Properties** page configured to search for a case by **Customer Id** and **Title**. The **Customer Id** is being pulled in from the **Profile ARN** of the customer. In this image, the **Link contact to case** option is set to **Yes**. The **Request field** is set to **Customer Id, Title**. In the **Customer Id** section, the **Use attribute** option is selected. The **Type** box is set to **Customer**. The **Attribute** box is set to **Profile ARN**.

The screenshot displays the configuration for the 'Get case' action. It includes a 'Link contact to case' section with radio buttons for 'Yes' (selected) and 'No'. Below is a 'Request field' section with a search input containing 'Customer Id, Title'. A modal window titled 'Customer Id' is open, showing two radio buttons: 'Set manually' and 'Use attribute' (selected). Under 'Use attribute', there are two dropdown menus: 'Type' set to 'Customer' and 'Attribute' set to 'Profile ARN'.

This next image shows the block configured to search by **Late Arrival**. Under **Title**, the **Set manually** option is set to **Late Arrival**. The **Get last updated cases** option is selected. The **Response field** option shows the three fields that will be shown to the agent: **Status**, **Summary**, and **Title**.

Properties: Update case

When configuring properties to update a case:

- Add a **Get case** block before an **Update case**, as shown in the following image. Use the **Get case** block to find the case you want to update.

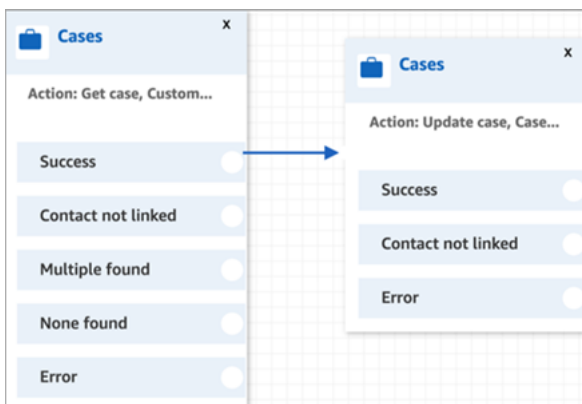

- You must provide an update to at least one **Request** field. Otherwise, this block takes the **Error** branch.

You can either use an attribute in the Cases namespace, or set the **Request** field manually. If you set manually, see the syntax in [How to persist fields throughout the flow](#).

- Contacts can be routed down the following branches:
 - **Success:** The case was updated, and the contact was linked to the case.

- **Contact not linked:** If you specify to link the contact to case, then this error branch will appear. It might be that the case was updated, but the contact was not linked to the case (partial success/partial failure). If this happens, then the flow will follow this branch.
- **Error:** The case was not updated. The contact was not linked to the case, as the case was not updated.

The following images show an example of an **Update case** configuration. The first image shows that as part of the update the contact is going to be linked to the case. To identify which case to update, the **Case Id** is specified. (Case Id is the unique identifier of the case and the only field you can provide here. Other fields will not work and produce errors.)

The screenshot shows a configuration form for the 'Update case' action. It includes a dropdown menu for 'Action' set to 'Update case', radio buttons for 'Link contact to case' (selected 'Yes'), a dropdown for 'Case to update (CaseID)' with 'Type' set to 'Case' and 'Attribute' set to 'Case Id'.

The following image shows the **Request field**, where you specify the fields to update the case.

The screenshot shows a 'Request field' dialog box titled 'Add request fields to update the case'. It features a search bar for 'Title' and a list of selected fields. The selected field is 'Title', which is configured to be 'Set manually' with the value 'Case updated through flows'. There are 'Cancel' and 'Save' buttons at the bottom.

Properties: Create case

When configuring properties to create a case:

- You must provide a case template. For more information, see [Create case templates](#).

- Fields that are required appear in the **Required** fields section. You must assign values to them to create a case.
- You must specify the customer to create a case.
 - We recommend adding a [Customer profiles](#) block to the flow before the **Cases** block. Use the [Customer profiles](#) block to get a customer profile with some prefetched data, or create a new customer profile and then use that to create a case.
 - To provide a value for **Customer Id** in the **Cases** block, configure the fields as shown in the following image, where **Use attribute** is selected, **Type** is set to **Customer**, and **Attribute** is set to **Profile ARN**.

The image shows a configuration window titled "Required fields". Under the "Customer Id" heading, there are two radio button options: "Set manually" and "Use attribute". The "Use attribute" option is selected. Below the radio buttons, there are two dropdown menus. The first is labeled "Type" and is set to "Customer". The second is labeled "Attribute" and is set to "Profile ARN".

If you are setting the value manually, you must provide the full customer profile ARN in this format:

```
arn:aws:profile:your AWS Region:your AWS account ID:domains/profiles domain name/profiles/profile ID
```

- You can specify values for fields other than the required ones in the Request fields section.

You can either use attribute in the Cases namespace or set manually. If you set manually, see to the syntax in [How to persist fields throughout the flow](#).

- You can specify that a contact should be linked to case. If you link the contact to the case, then the contact and a link to contact details appear on the case that the agent sees in the agent application.
- After creating a case, the case ID that is created will be persisted in the case namespace. It can be used in other blocks by accessing the case namespace case ID attribute value.

- Contacts can be routed down the following branches:
 - **Success:** The case was created, and the contact was linked to the case.
 - **Contact not linked:** If you specify to link the contact to case, then this error branch will appear. This is because it is possible that the case was created, but the contact was not linked to the case (partial success/partial failure). If this happens, then the flow will follow this branch.
 - **Error:** The case was not created. The contact was not linked to the case, as the case was not created.

The following images show an example of a **Create case** configuration. The first image shows the new case will be created using the General inquiry template:

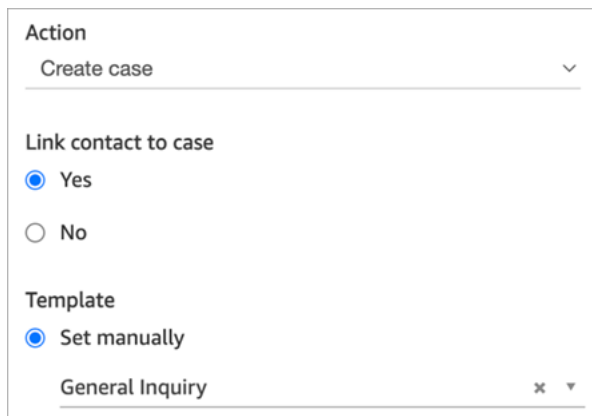

Action
Create case

Link contact to case
 Yes
 No

Template
 Set manually
General Inquiry

The next image shows the reason for the case will be set to **Shipment delayed**.

Cases

Get, update or create a case [Learn more](#)

Request fields
Select fields and give values to populate case data

Case Reason X ▾

Case Reason X

Set manually

Shipment delayed X ▾

Use attribute

Cancel Save

How to persist fields throughout the flow

Let's say you want customers to be able to call into your contact center and get the status of their case without ever talking to an agent. You want the IVR to read the status to the customer. You can get the status from a system field, or you might have a custom status field, for example, named *Detailed status*.

Here's how to configure your flow to get and read the status to the customer:

1. Add a **Cases** block to your flow. Configure it to **Get case** to find the case.

Cases

Get, update or create a case [Learn more](#)

Action

Get case ▼

Link contact to case

Yes

No

2. In the **Request fields** section, search for the case by the customer **Profile ARN**:

Request fields

Search for a case by adding request fields. Additional fields added will narrow the results

Customer Id ✕ ▼

Customer Id ✕

Set manually

Use attribute

Type

Customer ▼

Attribute

Profile ARN ▼

Get last updated case

3. In the **Response fields** section, add the field that you want passed throughout the flow. For our example, choose **Status**.

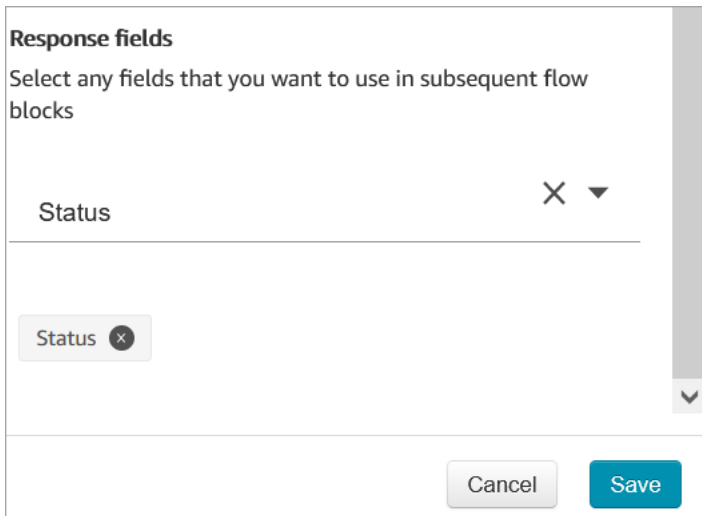

Response fields

Select any fields that you want to use in subsequent flow blocks

Status X ▼

Status X

Cancel Save

4. Add a [Play prompt](#) block to your flow.
5. Configure [Play prompt](#) to set the attribute manually:

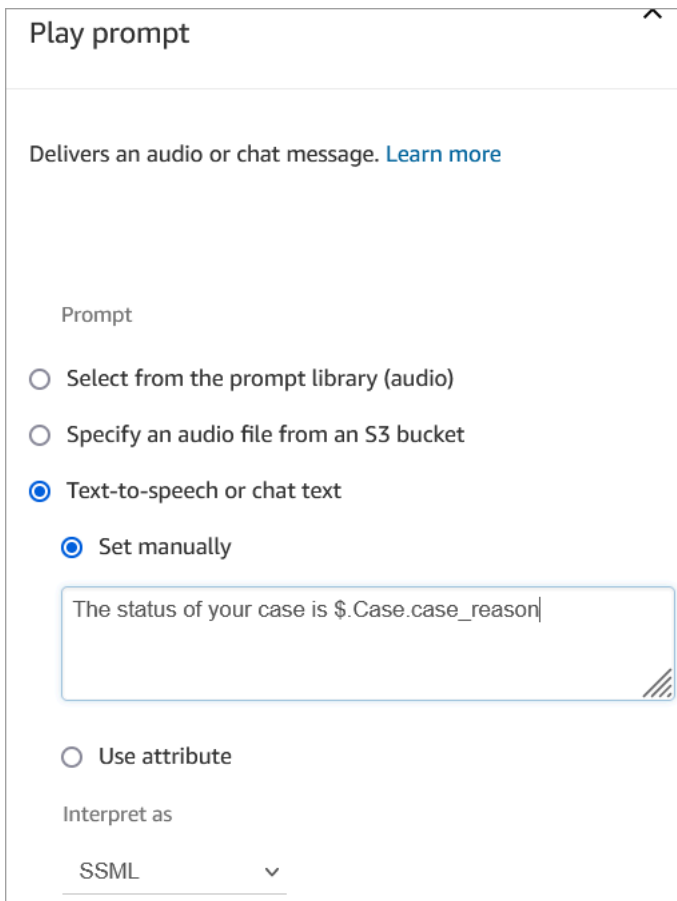

Play prompt

Delivers an audio or chat message. [Learn more](#)

Prompt

Select from the prompt library (audio)

Specify an audio file from an S3 bucket

Text-to-speech or chat text

Set manually

The status of your case is \$.Case.case_reason|

Use attribute

Interpret as

SSML ▼

Use the following syntax for reading the status of the case to the customer:

- For system fields, you can read the syntax and understand which field it refers to. For example: `$.Case.status` refers to the case status. For a list of system field IDs, see the *Field ID* column in the [System case fields](#) topic.
- For custom fields, the syntax uses a UUID (unique ID) to represent the field. For example, in the following image, the ID for the custom field named *Detailed status* is `12345678-aaaa-bbbb-cccc-123456789012`.

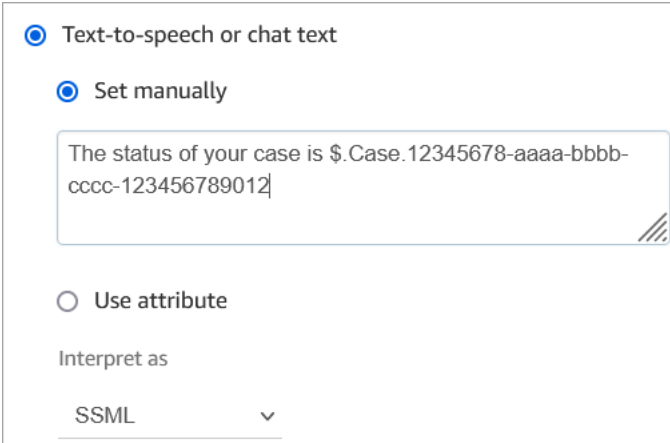

Text-to-speech or chat text

Set manually

The status of your case is \$.Case.12345678-aaaa-bbbb-cccc-123456789012

Use attribute

Interpret as

SSML

Find the custom field ID

To find the UUID of a custom field:

1. In Amazon Connect, on the navigation menu choose **Agent applications**, **Custom fields**, and then choose the custom field that you want.
2. While on the details page for the custom field, look at the URL of the page. The UUID is the last portion of the URL. For example, in the following URL:

```
https://instance alias.my.connect.aws/cases/configuration/fields/update/12345678-aaaa-bbbb-cccc-123456789012
```

The UUID is `12345678-aaaa-bbbb-cccc-123456789012`.

The following image shows where you find the custom field ID at the end of a URL:

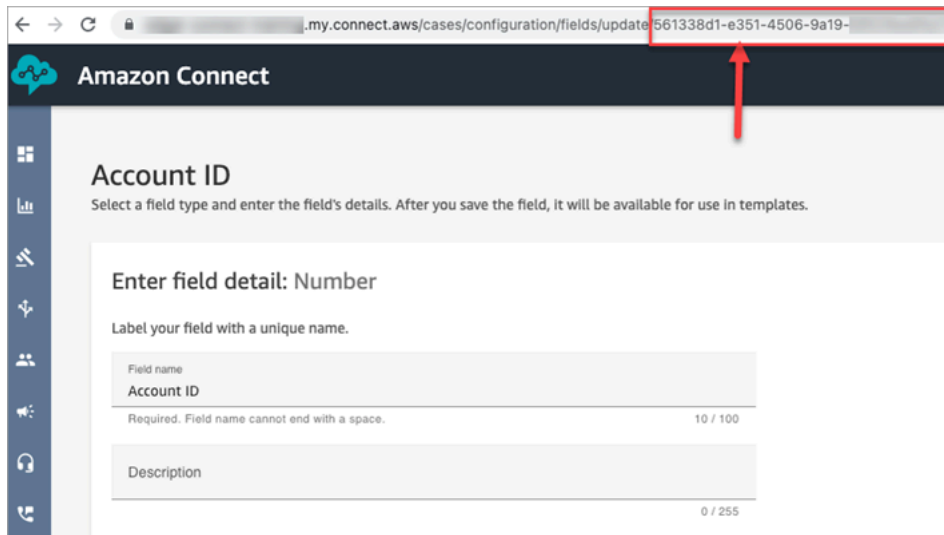

Configuration tips

- Be sure to check the [Cases service quotas](#), and request increases. The quotas apply when this block creates cases.

Configured block

The following image shows an example of what this block looks like when it is configured. It shows this block is configured to create cases, and it has **Success** and **Error** branches.

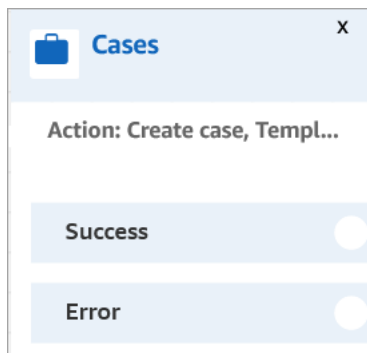

Flow block: Change routing priority / age

Description

- Change a customer's position in the queue. For example, move the contact to the front of the queue, or to the back of the queue.

Supported channels

The following table lists how this block routes a contact who is using the specified channel.

Channel	Supported?
Voice	Yes
Chat	Yes
Task	Yes

Flow types

You can use this block in the following [flow types](#):

- Inbound flow
- Customer queue flow
- Transfer to Agent flow
- Transfer to Queue flow

Properties

The following image shows the **Properties** page of the **Change routing priority / age** block. It is configured to add 8 seconds to the routing age of the contact.

The screenshot shows a configuration window titled "Change routing priority / age" with a close button (X) in the top right corner. Below the title, there is a description: "Alters the priority or age of the contact in queue. Contacts are routed by priority. 1 is highest priority and 5 is lowest. They are further ordered by time / age in queue. [Info](#)".

Under the heading "Set priority or routing age", there are two radio button options: "Set priority" (which is unselected) and "Adjust by time" (which is selected).

Below the "Adjust by time" option, there are three input fields:

- A dropdown menu labeled "Add or subtract" with a plus sign (+) selected.
- A text input field labeled "Routing age" containing the value "8".
- A dropdown menu labeled "Units" with "Seconds" selected.

This block gives you two options for changing a contact's position in queue:

- **Set priority.** The default priority for new contacts is 5. You can raise the priority of a contact - compared to other contacts in the queue - by assigning them a higher priority, such as 1 or 2.
- **Adjust by time.** You can add or subtract seconds or minutes from the amount of time the current contact spends in queue. Contacts are routed to agents on a first-come, first-served basis. So changing their amount of time in queue compared to others also changes their position in queue.

Here's how this block works:

1. Amazon Connect takes the actual "time in queue" for the contact (in this case, how long this specific contact has spent in queue so far), and adds the number of seconds you specified in the **Adjust by time** property.
2. The additional seconds makes this specific contact look artificially older than it is.
3. The routing system now perceives this contact's "time in queue" as longer than it actually is, which affects its position within the ranked list.

Configuration tips

- When using this block, it takes at least 60 seconds for a change to take effect for contacts already in queue.
- If you need a change in a contact's priority to take effect immediately, set the priority before putting the contact in queue, that is, before using a [Transfer to queue](#) block.

Configured block

The following image shows an example of what this block looks like when it is configured. It shows the **Queue time** is set to +8 seconds, and it has a **Success** branch.

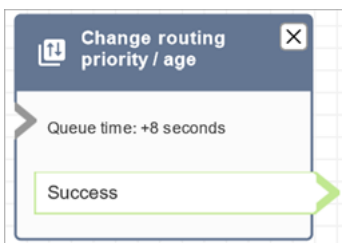

Sample flows

Amazon Connect includes a set of sample flows. For instructions that explain how to access the sample flows in the flow designer, see [Sample flows](#). Following are topics that describe the sample flows which include this block.

- [Sample customer queue priority](#)
- [Sample queue configurations](#)

Scenarios

See these topics for more information about how routing priority works:

- [Concepts: Routing profiles](#)
- [How routing works](#)

Flow block: Check call progress

Important

This block works with [outbound campaigns](#) only.

Description

- Engages with the output provided by an answering machine, and provides branches to route the contact accordingly.
- It supports the following branches:
 - **Call answered:** The call has been answered by a person.
 - **Voicemail (beep):** Amazon Connect identifies that the call ended in a voicemail and it detects a beep.
 - **Voicemail (no beep):**
 - Amazon Connect identifies that the call ended in a voicemail but it doesn't detect a beep.
 - Amazon Connect identifies that the call ended in a voicemail, but the beep is unknown.
 - **Not detected:** Could not detect whether there is voicemail. This happens when Amazon Connect is unable to make a positive determination of whether a call was answered by a live

voice or an answering machine. Typical situations that land in this state include long silences or excessive background noise.

- **Error:** If any errors are encountered due to Amazon Connect not running correctly after media has been established on the call, this is the path that will be taken by the flow. Media is established when the call is either answered by a live voice or by an answering machine. If the call is rejected by the network or encounters a system error while placing the outbound call, the flow will not be run.

Supported channels

The following table lists how this block routes a contact who is using the specified channel.

Channel	Supported?
Voice	Yes
Chat	No - Error branch
Task	No - Error branch

Flow types

You can use this block in the following [flow types](#):

- All flow types

Properties

The following image shows the **Properties** page of the **Check call progress** block.

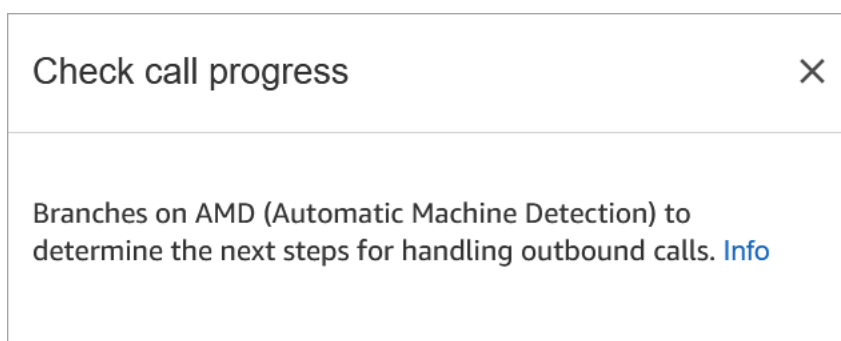

Configured block

The following image shows an example of what this block looks like when it is configured. It has branches for **Call answered**, **Voicemail (beep)**, **Voicemail (no beep)**, **Not detected**, and **Error**.

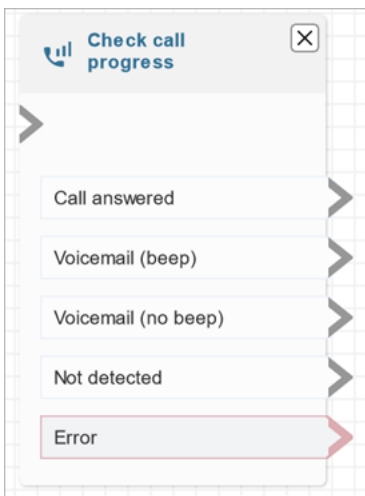

Flow block: Check contact attributes

Description

- Branches based on a comparison to the value of a contact attribute.
- Supported comparisons include: **Equals**, **Is Greater Than**, **Is Less Than**, **Starts With**, **Contains**.

Supported channels

The following table lists how this block routes a contact who is using the specified channel.

Channel	Supported?
Voice	Yes
Chat	Yes
Task	Yes

Flow types

You can use this block in the following [flow types](#):

- All flows

Properties

The following image shows the **Properties** page of the **Check contact attributes** block. In this example, the block is configured to check whether the contact is a **PremiumCustomer**, which is a [user-defined attribute](#).

Check contact attributes

Branches based on a comparison to the value of a contact attribute. [Info](#)

Attribute to check

Namespace
User defined

Attribute
PremiumCustomer

Conditions to check

condition
Equals

value
yes

[Add another condition](#)
No Match

Conditions to check can be dynamic

You can check conditions like the following:

- \$.Attributes.verificationCode

To check for a NULL value, you need to use a Lambda.

Amazon Lex attributes

You can set attributes that are **Type = Lex** as follows:

- **Alternative Intents:** Usually you configure flows to branch on the winning Lex intent. However, in some situations, you might want to branch on an alternate intent. That is, what the customer might have meant.

For example, in the following image of the **Check contact attributes** properties page, it is configured so the alternative intent indicates that if Amazon Lex is more than 70% confident the customer meant *fraud*, the flow should branch accordingly.

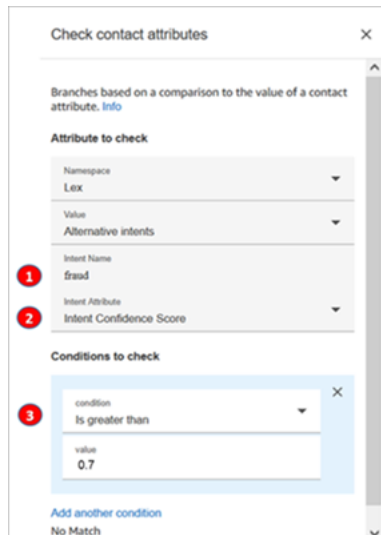

1. **Intent name** is the name of an alternate intent in Lex. It's case sensitive and must match what's in Lex exactly.
 2. **Intent Attribute** is what Amazon Connect is going to check. In this example, it's going to check the **Intent Confidence Score**.
 3. **Conditions to check:** If Lex is 70% certain the customer meant the alternate intent instead of the winning intent, branch.
- **Intent Confidence Score:** How confident is the bot that it understands the customer's intent. For example, if the customer says "I want to update an appointment," *update* can mean *reschedule* or *cancel*. Amazon Lex provides the confidence score on a scale of 0 to 1:
 - 0 = not at all confident
 - .5 = 50% confident
 - 1 = 100% confident
 - **Intent Name:** The user intent returned by Amazon Lex.
 - **Sentiment Label:** What is the winning sentiment, the one with the highest score. You can branch on POSITIVE, NEGATIVE, MIXED, or NEUTRAL.

- **Sentiment Score:** Amazon Lex integrates with Amazon Comprehend to determine the sentiment expressed in an utterance:
 - Positive
 - Negative
 - Mixed: The utterance expresses both positive and negative sentiments.
 - Neutral: The utterance does not express either positive or negative sentiments.
- **Session Attributes:** Map of key-value pairs representing the session-specific context information.
- **Slots:** Map of intent slots (key/value pairs) Amazon Lex detected from the user input during the interaction.

Configuration tips

- If you have multiple conditions to compare, Amazon Connect checks them in the order they are listed.

For example, in the following image of the **Check contact attributes** properties page, it is configured so Amazon Connect compares the **greater than 60** condition first and compares **greater than 2** last.

Conditions to check

condition ✕

Is greater or equal

value

60

condition ✕

Is greater or equal

value

10

condition ✕

Is greater or equal

value

2

[Add another condition](#)

No Match

This condition is checked first.

This condition is checked last.

- This block doesn't support case-insensitive pattern matching. For example, if you're trying to match against the word **green** and the customer types **Green**, it would fail. You would have to include every permutation of upper and lower-case letters.

Configured

The following image shows an example of what this block looks like when it is configured. It shows the block has four branches, one for each condition: greater or equal to 60, greater to equal to 10, greater or equal to 2, or **No match**.

Check contact attributes

+ Checking: dynamic(Lex> AI...

>= 60

>= 10

>= 2

No Match

Sample flows

Amazon Connect includes a set of sample flows. For instructions that explain how to access the sample flows in the flow designer, see [Sample flows](#). Following are topics that describe the sample flows which include this block.

- [Sample inbound flow \(first contact experience\)](#)
- [Sample interruptible queue flow with callback](#)

Scenarios

See these topics for scenarios that use this block:

- [How to reference contact attributes](#)
- [Route based on contact's channel](#)

Flow block: Check hours of operation

Description

- Checks whether the contact is occurring within or outside of the hours of operation defined for the queue.
- Branches based on specified hours of operation.

Supported channels

The following table lists how this block routes a contact who is using the specified channel.

Channel	Supported?
Voice	Yes
Chat	Yes
Task	Yes

Flow types

You can use this block in the following [flow types](#):

- Inbound flow
- Customer queue flow
- Transfer to Agent flow
- Transfer to Queue flow

Properties

The following image shows the **Properties** page of the **Check hours of operation** block. The block is configured for specific hours of operation.

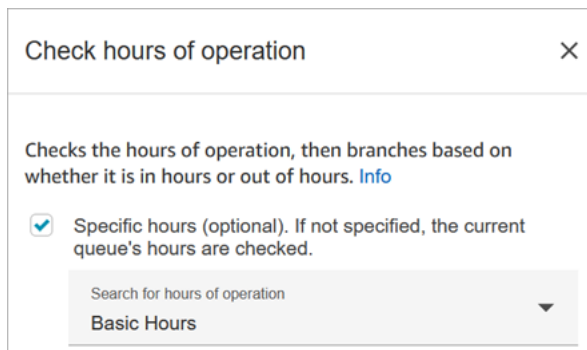

You can set up multiple hours of operation so you have one for various queues. For instructions, see [Set the hours of operation and timezone for a queue](#).

Configuration tips

- [Agent queues](#) that are automatically created for each agent in your instance do not include an hours of operation.
- If you use this block to check the hours of operation for an agent queue, the check fails and the contact is routed down the **Error** branch.

Configured block

The following image shows an example of what this block looks like when it is configured. It is configured for **Basic Hours** of operation. It has three branches: **In hours**, **Out of Hours**, and **Error**.

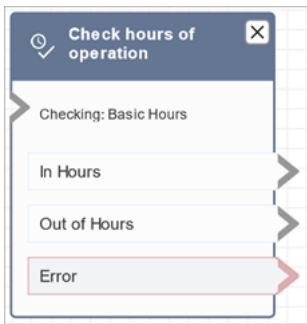

Related topics

- [Set the hours of operation and timezone for a queue](#)

Sample flows

Amazon Connect includes a set of sample flows. For instructions that explain how to access the sample flows in the flow designer, see [Sample flows](#). Following are topics that describe the sample flows which include this block.

[Sample inbound flow \(first contact experience\)](#)

Scenarios

See these topics for scenarios that use this block:

- [Manage contacts in a queue](#)

Flow block: Check queue status

Description

- Checks the status of the queue based on specified conditions.
- Branches based on the comparison of **Time in Queue** or **Queue capacity**.
 - **Time in queue** is the amount of time the oldest contact spends in queue, before they are routed to an agent or removed from the queue.
 - **Queue capacity** is number of contacts waiting in a queue.
- If no match is found, the **No Match** branch is followed.

Supported channels

The following table lists how this block routes a contact who is using the specified channel.

Channel	Supported?
Voice	Yes
Chat	Yes
Task	Yes

Flow types

You can use this block in the following [flow types](#):

- Inbound flow
- Customer queue flow
- Transfer to Agent flow
- Transfer to Queue flow

Properties

The following image shows the **Properties** page of the **Check queue status** block. In this example, it checks whether a contact has been in the BasicQueue longer than 2 minutes.

Check queue status
✕

Check the amount of time the oldest contact or task has been in queue, the queue capacity, and branch. If no match is found, the contact is routed down the No Match branch. [Info](#)

Metric Time in Queue	Operator Is greater than
Value 2	Units Minutes

Add another condition

Queue to check (optional)

By queue

Set manually

Select a queue
BasicQueue

Set dynamically

By agent

Configuration tips

The order in which you add conditions matters at the runtime. Results are evaluated against conditions in the same order in which you add them to the block. Contacts are routed down the first condition to match.

For example, in the following condition order, every value matches one of first two conditions. None of the other conditions are ever matched.

- Time in Queue <= 90
- Time in Queue >= 90
- Time in Queue >= 9
- Time in Queue >= 12
- Time in Queue >= 15
- Time in Queue >= 18
- Time in Queue > 20
- Time in Queue > 21

In this next example, all contacts with a wait time in queue of 90 or less (<=90) match first condition only. This means less than or equal to 9 (<=9), <=12, <=15, <=18, <=20, <=21 are never run. Any value greater than 90 is routed down the greater than or equal to 21 (>=21) condition branch.

- Time in Queue <= 90
- Time in Queue <= 9
- Time in Queue <= 12
- Time in Queue <= 15
- Time in Queue <= 18
- Time in Queue < 20
- Time in Queue < 21
- Time in Queue > 21

Configured block

The following image shows an example of what this block looks like when it is configured. It has three branches: the **Time in Queue** condition, **No Match**, and **Error**.

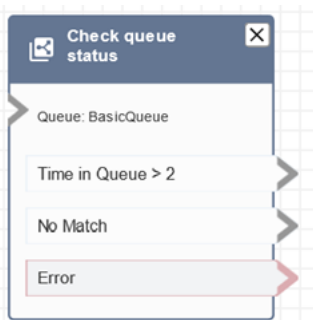

Scenarios

See these topics for scenarios that use this block:

- [Manage contacts in a queue](#)

Flow block: Check Voice ID

Description

Note

The [Set Voice ID](#) block needs to be set in the flow before this one. That block sends audio to [Amazon Connect Voice ID](#) to verify the customer's identity, and returns a status.

The **Check Voice ID** block branches based on the results of the voice analysis and the status returned by Voice ID:

- **Enrollment status:**

- **Enrolled:** The caller is enrolled in voice authentication.
- **Not enrolled:** The caller has not yet been enrolled in voice authentication. When this status is returned, for example, you may want to directly route the call to an agent for enrollment.
- **Opted out:** The caller has opted out of voice authentication.

You are not charged for checking enrollment status.

- **Voice authentication status:**

- **Authenticated:** The caller's identity has been verified. That is, the authentication score is greater than or equal to the threshold (default threshold of 90 or your custom threshold).
- **Not authenticated:** The authentication score is lower than threshold that you configured.
- **Inconclusive:** Unable to analyze a caller's speech for authentication. This is usually because Voice ID did not get the required 10 seconds to provide a result for authentication.
- **Not enrolled:** The caller has not yet been enrolled in voice authentication. When this status is returned, for example, you may want to directly route the call to an agent for enrollment.
- **Opted out:** The caller has opted out of voice authentication.

You are not charged if the result is **Inconclusive**, **Not enrolled** or **Opted out**.

- **Fraud detection status:**

- **High risk:** The risk score meets or exceeds the set threshold.
- **Low risk:** The risk score did not meet the set threshold.
- **Inconclusive:** Unable to analyze a caller's voice for detection of fraudsters in a watchlist.

You are not charged if the result is **Inconclusive**.

 **Note**

For **Enrollment status** and **Voice authentication**, the [Customer ID](#) system attribute needs to be set in [Set contact attributes](#) block because they are acting on a specific customer. You don't need to do this for **Fraud detection** because it's not acting on a specific customer but rather detecting whether the incoming caller matches a fraudster on your watch list. This

means it's possible for a customer to be successfully authenticated and still have high fraud risk.

Supported channels

The following table lists how this block routes a contact who is using the specified channel.

Channel	Supported?
Voice	Yes
Chat	No - Error branch
Task	No - Error branch

Flow types

You can use this block in the following [flow types](#):

- Inbound flow
- Customer queue flow
- Customer whisper flow
- Outbound whisper flow
- Agent whisper flow
- Transfer to Agent flow
- Transfer to Queue flow

Properties

This block doesn't have any properties that you set. Rather, it creates branches for you to route contacts based on the result of the authentication threshold and voiceprint evaluation that [Set Voice ID](#) returns.

The following image shows the **Properties** page for the **Check voice ID** block when it's configured to check for Enrollment status. Different status results are returned when it's configured for **Voice authentication** or **Fraud detection**.

Check voice ID ✕

Branches based on Set Voice ID block.

Choose a Voice ID feature to branch on. You can reuse this block to retrieve results for other features. [Info](#)

Enrollment status
 Voice authentication
 Fraud detection

i The 'Customer ID' must be set using 'Set contact attribute' block.

Glossary

Enrolled	Caller is enrolled in voice authentication.
Not Enrolled	Caller that has not yet been enrolled in voice authentication.
Opted out	Caller has opted out of voice authentication.

Configuration tips

When you create a flow that uses this block, add these blocks in the following order:

1. [Set Voice ID](#) block.
2. [Set contact attributes](#) block: For **Enrollment status** and **Voice authentication**, the [Customer ID](#) system attribute needs to be set in [Set contact attributes](#) block because it is acting on a specific customer.
3. **Check Voice ID** block.

Configured block

The following three images show what this block looks like when it's configured to check for:

1. Enrollment status
2. Voice authentication
3. Fraud detection

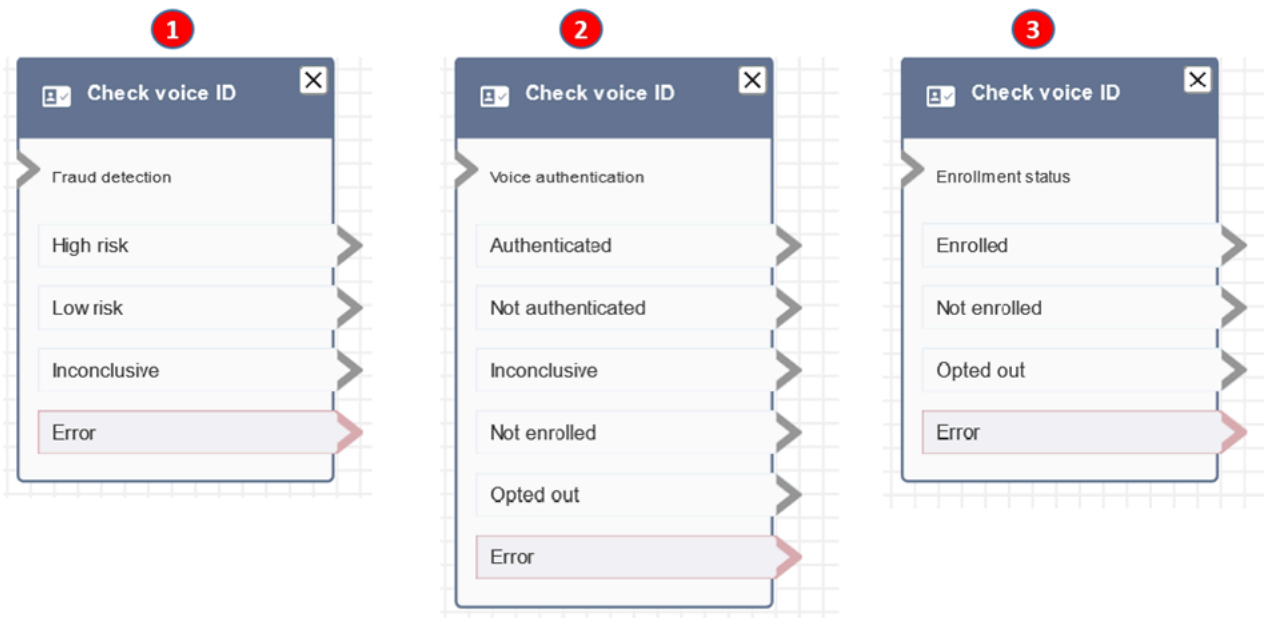

More information

See the following topics for more information about this block:

- [Use real-time caller authentication with Voice ID](#)
- [Use Voice ID](#)

Flow block: Check staffing

Description

- Checks the current working queue, or queue you specify in the block, for whether agents are [available](#), [staffed](#), or [online](#).
- Before transferring a call to agent and putting that call in a queue, use the **Check hours of operation** and **Check staffing** blocks. They verify that the call is within working hours and that agents are staffed to service.

Supported channels

The following table lists how this block routes a contact who is using the specified channel.

Channel	Supported?
Voice	Yes
Chat	Yes
Task	Yes

Flow types

You can use this block in the following [flow types](#):

- Inbound flow
- Customer queue flow
- Transfer to Agent flow
- Transfer to Queue flow

Properties

The following image shows the **Properties** page of the **Check staffing** block. It is configured to check whether agents in the BasicQueue have slots available so they can be routed contacts.

Check staffing

Branches based on whether agents are available, staffed (for example, available, on call, or after call work), or online. [Info](#)

Select status to check
Available

Queue to check (optional)

By queue

Set manually

Select a queue
BasicQueue

Set dynamically

By agent

In the **Status to check** dropdown box, choose one of the following options:

- [Available](#) = Check whether the agent has **Available** slots to be routed a contact.
- [Staffed](#) = Check whether agents have **Available** slots, or are **On call**, or are in **After Contact Work**.
- [Online](#) = Check whether agents are **Available**, in the **Staffed** state, or in a custom state.

Configuration tips

- You must set a queue before using a **Check staffing** block in your flow. You can use a [Set working queue](#) block to set the queue.
- If a queue is not set, the contact is routed down the **Error** branch.
- When a contact is transferred from one flow to another, the queue that is set in a flow is passed from that flow to the next flow.

Configured block

The following image shows an example of what this block looks like when it is configured. It has three branches: **True**, **False**, and **Error**.

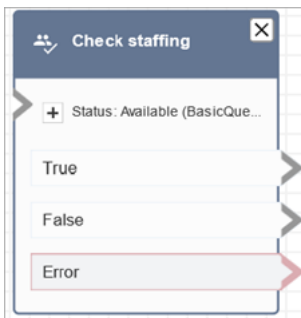

Scenarios

See these topics for scenarios that use this block:

- [Transfer contacts to a specific agent](#)

Flow block: Contact tags

Description

- Use this block to create and apply user-defined tags (key:value pairs) to your contacts.
- You can create up to 6 user-defined tags.
- You set a value that can be referenced later in a flow. You can also remove tags in a flow, for example, if the tags aren't relevant to the segment anymore.
- For more information about how to use tags to obtain a more detailed view of your Amazon Connect usage, see [Set up granular billing for a detailed view of your Amazon Connect usage](#).

Supported channels

The following table lists how this block routes a contact who is using the specified channel.

Channel	Supported?
Voice	Yes
Chat	Yes
Task	Yes

Flow types

You can use this block in the following [flow types](#):

- All

Properties

The following image shows the **Properties** page of the **Contact tags** block. It is configured to set a tag on the current contact with the key **Department** and the value **Finance**.

Block Type ✕

 **Contact tags**

Block Name

Enter a block name

0 / 50

Add or remove tags (key-value pairs) on the contact. [Learn more](#)

Select tag action

Tag ▼

i A contact can have up to 6 user defined tags. Both key and value of a tag must only contain Unicode letters, digits, white space and any of: `_.!:=+@-`

Enter tag key-value pairs to be applied on the contact

Enter tag key ✕

Department

Set manually

Enter tag value

Finance

Set dynamically

[Add another tag](#) 

You can also configure the block to untag a contact, as shown in the following image.

Add or remove tags (key-value pairs) on the contact. [Learn more](#)

Select tag action
Untag

i A contact can have up to 6 user defined tags. Both key and value of a tag must only contain Unicode letters, digits, white space and any of: `_.!/=+@-`

Enter tag keys to be removed from the contact

Department ✕

[Add another tag key](#)

Configuration tips

- For more information about how Amazon Connect processes user-defined tags, see [Things to know about user-defined tags](#).

Configured block

The following image shows an example of what this block looks like when it is configured. It has two branches: **Success** and **Error**.

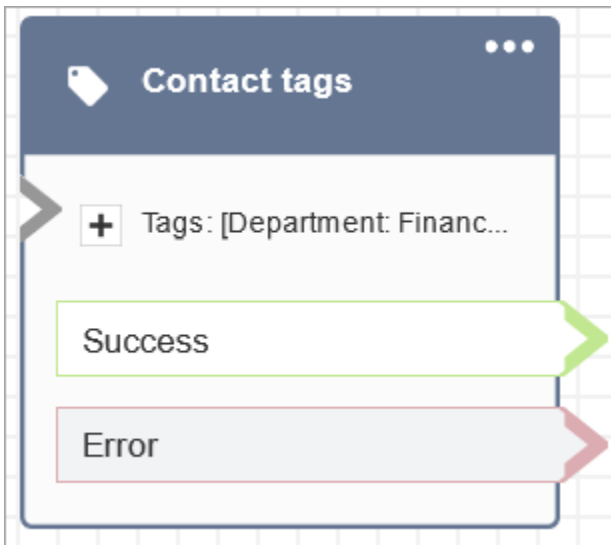

Flow block: Create persistent contact association

Description

- Enables persistent chat experience on the current chat.
- This allows you to select the required rehydration mode. For more information about chat rehydration, see [Enable persistent chat](#).

Supported channels

The following table lists how this block routes a contact who is using the specified channel.

Channel	Supported?
Voice	No - Error branch
Chat	Yes
Task	No - Error branch

Flow types

You can use this block in the following [flow types](#):

- Inbound flow

- Customer Queue flow
- Customer hold flow
- Customer whisper flow
- Outbound whisper flow
- Agent hold flow
- Agent whisper flow
- Transfer to agent flow
- Transfer to queue flow

Properties

The following image shows the **Properties** page of the **Create persistent contact association** block.

Block Type ✕

 **Create persistent contact association**

Block Name

Enter a block name

0 / 50

Specify an attribute to create a persistent contact association, enabling conversations to continue from where they left off

The source contact Id specified below is a past contact Id from which a conversation will be "rehydrated", enabling transcripts from past chat sessions to be shown to the participants in their current chat session. [Learn more](#)

Select rehydration type

Entire Past Session

From Segment

Use attribute

Namespace ▼

Note: The error branch will be taken for non-chat contacts and for chat contacts that cannot be restored.

Configuration tips

- To enable persistent chat you can add the **Create persistent contact association** block to your flow, or provide the previous contactId in the SourceContactId parameter of the [StartChatContact](#) API, but not both. You can enable persistence of a SourceContactID on a new chat only once.

We recommend that you enable persistent chat by using the **Create persistent contact association** block when using the following features:

- [Amazon Connect chat widget](#)

- [Apple Messages for Business](#)
- You can configure persistent chats to rehydrate the entire past chat conversation or rehydrate from a specific segment of a past chat conversation. For information about rehydration types, see [Enable persistent chat](#).

Configured block

The following image shows an example of what this block looks like when it is configured. It has two branches: **Success** and **Error**.



Flow block: Create task

Description

- Creates a new task manually or by leveraging a [task template](#).
- Sets the tasks attributes.
- Initiates a flow to start the task immediately or schedules it for a future date and time.

For more information about Amazon Connect Tasks, see [Concepts: Tasks in Amazon Connect](#) and [Concepts: Pause and resume tasks](#).

Note

If your Amazon Connect instance was created on or before October 2018, the contact is routed down the error branch. For the contact to be routed down the success path, create

an IAM policy with the following permission and attach it to the Amazon Connect service role. You can find the Amazon Connect service role on the **Account overview** page for your Amazon Connect instance.

```
{
  "Effect": "Allow",
  "Action": "connect:StartTaskContact",
  "Resource": "*"
}
```

Supported channels

The following table lists how this block routes a contact who is using the specified channel.

Channel	Supported?
Voice	Yes
Chat	Yes
Task	Yes

Flow types

You can use this block in the following [flow types](#):

- All flows

Properties

When you configure a **Create task** block, you choose either **Create manually** or **Use template**. Your choice dictates which fields you'll need to complete on the rest of **Properties** page. Following is more information about these two options.

Option 1: Create manually

The following image shows the **Properties** page when **Create manually** is selected. All settings on the page can be specified manually or dynamically.

Creates a new task to run an assigned flow. [Info](#)

Create manually

Flow
Select a flow to run this task.

Set manually

Flow

Set dynamically

Name

Set manually

Name

Set dynamically

Set description

Set references

Schedule task

Task attributes
Define and store key-value pairs as contact attributes.

Destination key

Set manually

Value

Set dynamically

Add task attributes

Use template

Link to contact

Cancel Save

If you choose **Use template** at bottom of the page, the entire page switches to that option. If needed, you can toggle back to **Create manually** and continue with your manual settings.

Option 2: Use template

After you [create a template](#), it's available for you to specify it in **Create task** block.

The following image shows the **Properties** page when **Use template** is selected. In this example, the name of the template is **Test Template**. Notice that **Test Template** does not include a flow.

- If the selected template does not include a flow, you must specify the flow that you want the task to run.
- You cannot overwrite the settings of any fields on the page that are populated by the template.

Creates a new task to run an assigned flow. [Info](#)

Create manually

Use template

Template
Test Template

Task name

Set manually

Task name
Test

Set dynamically

Description

Set manually

Description

Set dynamically

Flow

Select a flow to run this task.

Set manually

Flow

Set dynamically

Task attributes

Define and store key-value pairs as contact attributes.

Destination key

Set manually

Value

Set dynamically

Add task attributes

Link to contact

Cancel Save

Configuration tips

- The **Create task** block branches based on whether the task was successfully created:
 - **Success** if task was created. It responds with the contact ID of the newly created task.
 - **Error** if task wasn't created.
- **Referencing a task contact ID:** The newly created task runs the flow that you specified in the **Flow** section of the block, or it runs the flow configured by the task template that you selected. You can reference the contact ID of the newly created task in subsequent blocks.

For example, you might want to reference the task contact ID in the **Play prompt** block. You can specify the task contact ID dynamically by using the following attribute:

- **Namespace: System**
- **Value: Task Contact id**
- **Scheduling a task:** When you **Set date and time using attribute:** Values for date fields must be in Unix timestamp (Epoch seconds). Because of this, it's most likely that you'll choose a **User-defined** attribute for the **Namespace**.

For example, your flow might have a **Set contact attributes** block that sets a user-defined attribute with key named *scheduledTaskTime*. Then, in the **Create task** block, you would select **User-defined**, and the key would be *scheduledTaskTime*.

To continue with this example, the value in *scheduledTaskTime* must be specified Unix timestamp. For example, 1679609303 is the Unix timestamp that corresponds to Thursday, March 23, 2023 10:08:23 PM UTC.

When the date and time have passed, contacts are always routed down the **Error** branch. To avoid the **Error** branch, be sure to keep the Epoch seconds updated to a valid date and time in the future.

- Use the **Link to contact** option to automatically link the task to the contact.
- Be sure to check the [service quotas](#) for tasks and API throttling, and request increases, if needed. The quotas apply when this block creates tasks.

Configured block

The following image shows an example of what this block looks like when it is configured. It has two branches: **Success** and **Error**.

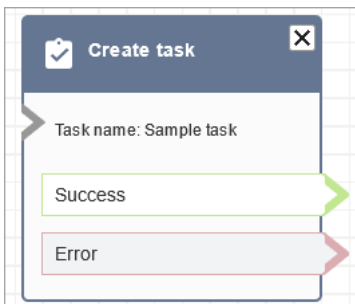

Sample flows

Amazon Connect includes a set of sample flows. For instructions that explain how to access the sample flows in the flow designer, see [Sample flows](#). Following are topics that describe the sample flows which include this block.

- [Sample inbound flow \(first contact experience\)](#)

Flow block: Customer profiles

Description

- Enables you to retrieve, create, and update a customer profile.
 - You can configure the block to retrieve profiles using up to five search identifiers of your choice.
- Enables you to retrieve a Customer Profile's object and calculated attributes.
 - You can configure the block to retrieve objects using a search identifier of your choice.
 - You must provide a profile ID in this block. You can provide a **profileID** manually, or use the **profileID** saved in the Customer namespace after you have found a profile using the **Get profile** action.
- Enables you to associate the contact, such as voice, chat, and tasks, to an existing customer profile.
- When customer profile data is retrieved, the **Response fields** are stored in the [contact attributes for that customer](#), allowing you to use them in subsequent blocks.
- You can also reference the **Response fields** by using the following JSONPath: `$.Customer`. For example, `$.Customer.City` and `$.Customer.Asset.Status`.
- The following examples show how you might use this block:
 - Use a [Play prompt](#) block after retrieving a profile to provide a personalized call or chat experience by referencing the supported profile fields.
 - Use a [Check contact attributes](#) block after retrieving profile data to route a contact conditional on the value.
 - See [How to persist fields throughout the flow](#) for more details.

Supported channels

The following table lists how this block routes a contact that is using the specified channel.

Channel	Supported?
Voice	Yes
Chat	Yes

Channel	Supported?
Task	Yes

Flow types

You can use this block in the following [flow types](#):

- All flow types

Configuration tips

- Before using this block, make sure Customer Profiles is enabled for your Amazon Connect instance. For instructions, see [Use Customer Profiles](#).
- A contact is routed down the **Error** branch in the following situations:
 - Customer Profiles is not enabled for your Amazon Connect instance.
 - Request data values are not valid. The request values cannot be over 255 characters.
 - The Customer Profiles API request has been throttled.
 - Customer Profiles is having availability issues.
- The total size of [Customer Profiles contact attributes](#) is limited to 14,000 characters (56 attributes assuming max size of 255 each) for the entire flow. This includes all values persisted as **Response fields** in Customer Profiles blocks during the flow.

Properties

The following property types are available in the Customer Profiles flow block:

- [Get Profile](#)
- [Create Profile](#)
- [Update Profile](#)
- [Get Profile Object](#)
- [Get Calculated Attributes](#)
- [Associate Contact to Profile](#)

Properties: Get profile

When configuring properties to **Get profile**, consider the following:

- You must provide at least one search identifier, up to five total.
- If multiple search identifiers are provided, you must provide one logical operator, either **AND** or **OR**. The logical operator will be applied across all search identifiers like one of the expressions shown below
 - i.e. (a **AND** b **AND** c)
 - i.e. (x **OR** y **OR** z)
- Define attributes to persist in subsequent blocks, storing them in contact attributes under **Response fields**.
- Contacts can be routed down the following branches
 - **Success:** one profile was found. Response fields are stored to contact attributes
 - **Error:** An error was encountered while trying to find the profile. This may be due to a system error or how **Get profile** is configured.
 - **Multiple Found:** multiple profiles were found.
 - **None Found:** no profile was found.

The following image shows an example of a Customer Profiles **Properties** page that is configured for the **Get profile** action.



The displayed block is configured to search for profiles that either match the caller's **Phone** number or share the same **Account** number stored in the user-defined attribute named "Account." When one profile is located, the **Response fields** - **AccountNumber**, **FirstName**, **LastName**, **PhoneNumber**, and **Attributes.LoyaltyPoints** - are stored in the contact attributes for that specific customer.

Select an action

Action
Get profile

Search identifiers

Use search identifiers to find a profile.

- Phone = \$.CustomerEndpoint.Address  
- OR
- Account = \$.Attributes.Account  



[+ Add another search identifier](#)



Select logical operator



Search identifier
OR

Response fields

Select the standard profile attributes to identify an incoming contact, and use in subsequent flow blocks.

Response fields
AccountNumber , FirstName , LastName ,
PhoneNumber , Custom attribute  

AccountNumber  FirstName 

LastName  PhoneNumber 

Custom attribute 

Key
LoyaltyPoints 

[Add another custom response field](#)

Cancel 

Properties: Create profile

When configuring properties for **Create profile**, consider the following:

- Specify the attributes you intend to populate during profile creation in the **Request fields**
- Define attributes to persist in subsequent blocks, storing them in contact attributes under **Response fields**.

Contacts can be routed down the following branches:

- **Success:** A profile is successfully created, and **Response fields** are stored in contact attributes.
- **Error:** An error occurred during the profile creation process, possibly due to a system error or misconfiguration of the **Create profile** action.

The displayed block below is configured to create a profile with a **PhoneNumber** and a custom attribute named "Language". Following the profile creation, the **Attributes.Language** response field is stored in contact attributes, making it available for use in subsequent blocks.

Select an action

Action
Create profile

Request fields

Request fields
Phone number

Phone number

Use custom attributes

Custom attributes

- Language = \$.Attributes.Language

+ Add another custom attribute

Request field values

Phone number

Set manually

Set dynamically

Namespace
System

Key
Customer number

Response fields

Select the standard profile attributes to identify an incoming contact, and use in subsequent flow blocks.

Response fields
Custom attribute

Custom attribute

Key
Language

Add another custom response field

Cancel Save

Properties: Update profile

When configuring properties to **Update profile**, consider the following:

- Prior to using an **Update profile** block, use a **Get profile** block, as illustrated in the following image. Utilize the **Get profile** block to locate the specific profile you intend to update.

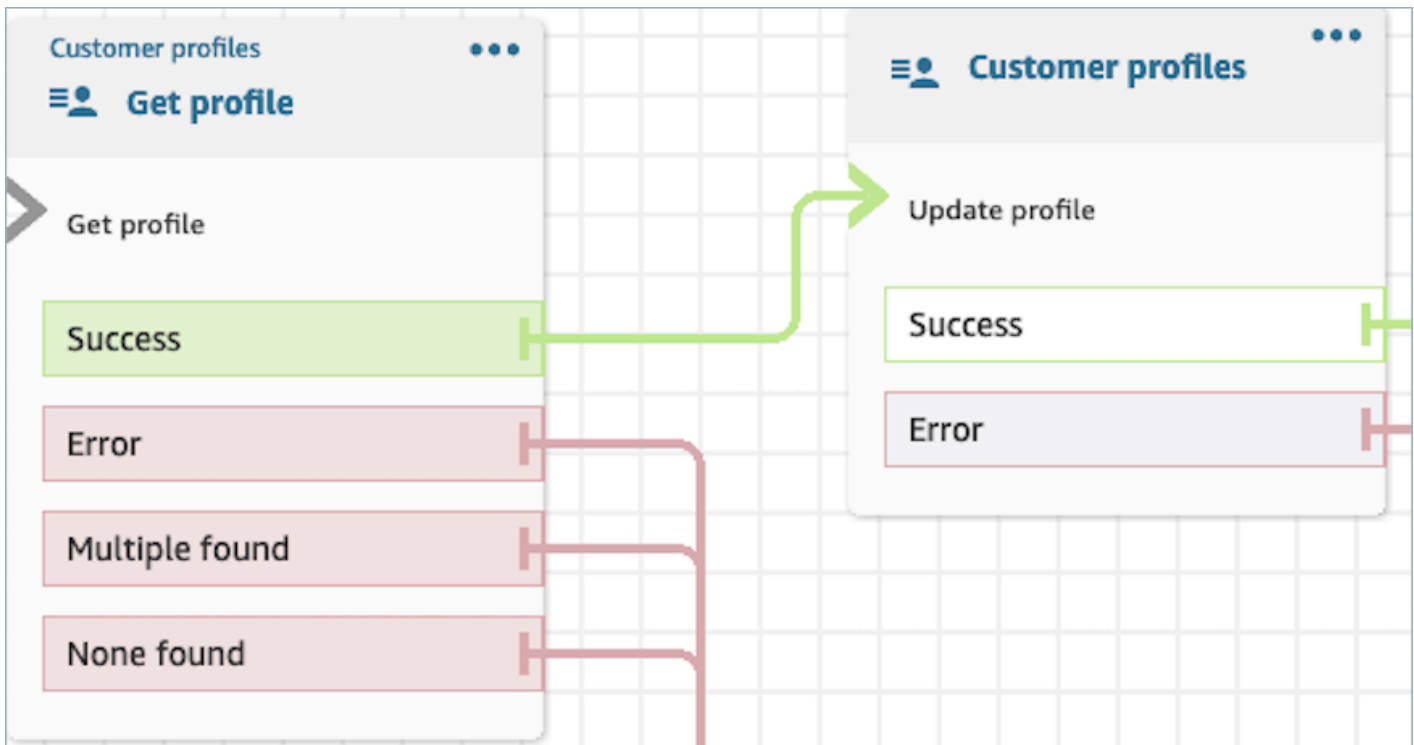

- Provide the attributes and values you wish to update the profile with **Request fields** and **Request field values**.
- Define attributes to persist in subsequent blocks, storing them in contact attributes under **Response fields**.

Contacts can be routed down the following branches:

- **Success:** The profile has been successfully updated, and **Response fields** are stored in contact attributes.
- **Error:** An error occurred during the attempt to update the profile. This could result from a system error or misconfiguration of the **Update profile** action.

The displayed block below is configured to update a Profile with a **MailingAddress1** with user input as value. When a profile is updated, the **MailingAddress1** response field is stored in contact attributes, making it available for use in subsequent blocks.

Select an action

Action
Update profile ▼

Request fields

Request fields
Mailing address 1 ✕ ▼

Mailing address 1 ✕

Use custom attributes

Request field values

Mailing address 1 ✕

Set manually

Set dynamically

Namespace
User defined ▼

Key
address

Response fields

Select the standard profile attributes to identify an incoming contact, and use in subsequent flow blocks.

Response fields
MailingAddress1 ✕ ▼

MailingAddress1 ✕

Cancel

Save

Properties: Get profile object

When configuring properties to **Get profile object**, consider the following:

- **Mandatory Profile ID:** A Profile ID is required for this block to function. The **Get profile object** action retrieves an object associated with the provided **ProfileID**. Ensure you provide the **ProfileID** by using a preceding **Get profile** block, as illustrated in the following image. Use the **Get profile** block to pinpoint the specific profile before moving forward to retrieve the profile's object in the subsequent block.
- You have the option to manually input the Profile ID or utilize a pre-defined value stored in a pre-defined or user attribute.

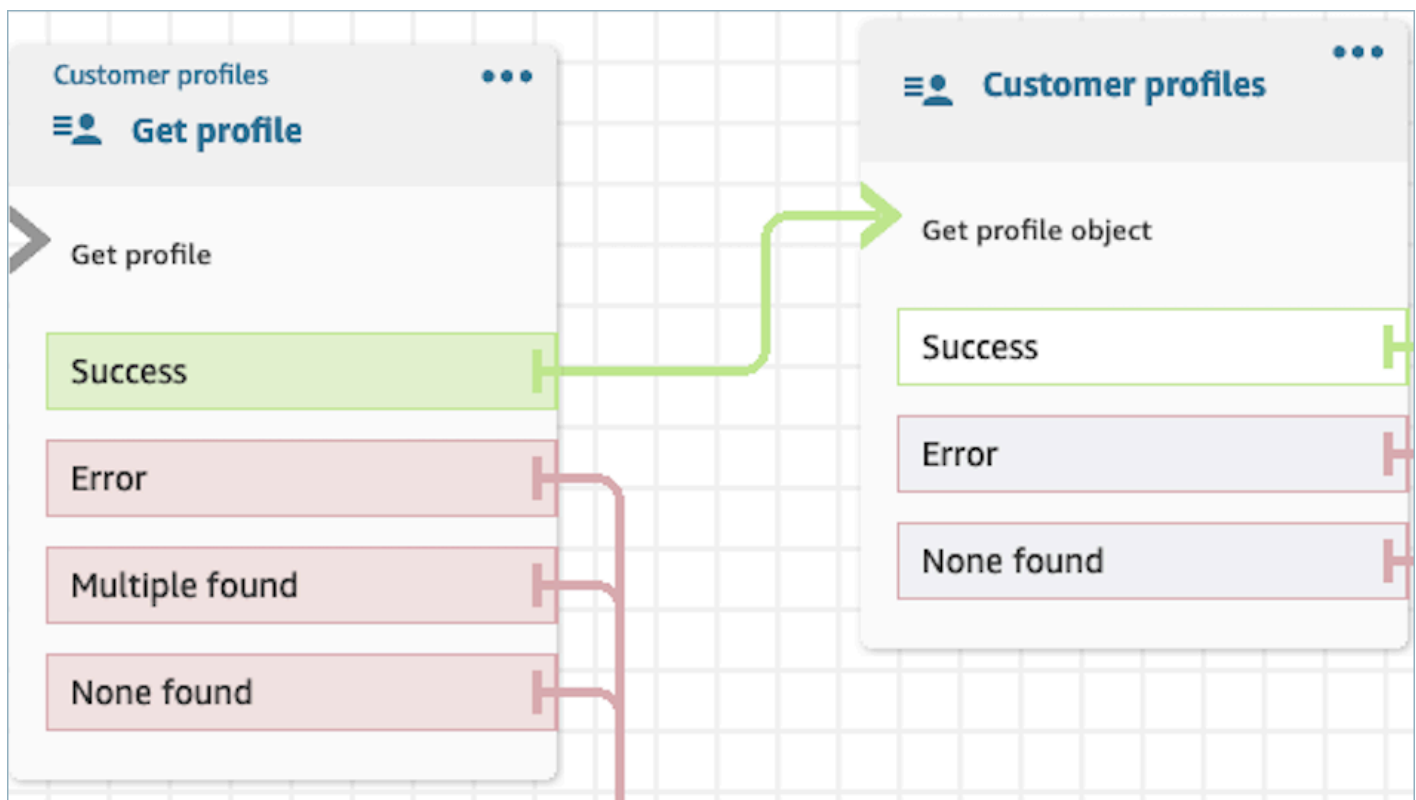

- You must indicate the object type from which you intend to retrieve information.
- You must choose one of the following options for object retrieval:
 - **Use latest profile object:** This option consistently retrieves the most recent object.
 - **Use search identifier:** This option involves searching for and retrieving the object using the provided search identifier.
- Define attributes to persist in subsequent blocks, storing them in contact attributes under **Response fields**.

Contacts can be routed down the following branches:

- **Success:** The profile object is successfully located, and **Response fields** are stored in contact attributes.
- **Error:** An error occurred during the attempt to retrieve the profile object. This may be due to a system error or misconfiguration of the **Get Profile** action.
- **None Found:** no object is found.

The displayed block below is configured to retrieve a profile object of type "Asset" associated with the **ProfileId** saved under the "Customer" namespace. In this specific scenario, the block is will search for an Asset using the Asset ID. Once the Asset is located, **Asset.Price** and **Asset.PurchaseDate** are stored in contact attributes, making them available for subsequent blocks.

ACTION
Get profile object

Profile ID

Set manually

Set dynamically

Namespace
Customer

Key
Profile ID

Object type

Set manually

Object type
Asset

Set dynamically

Get profile object

Use latest profile object

Use search identifier

Search identifier

Set manually

Search identifier
Asset ID

Set dynamically

Identifier value

Set manually

Set dynamically

Namespace
User defined

Key
ID

Response fields

Select the standard profile attributes to identify an incoming contact, and use in subsequent flow blocks.

Response fields
Price , PurchaseDate

Cancel Save

Properties: Get calculated attributes

⚠ Important

To use this action, your Amazon Connect instance must have permission for the following APIs: `ListCalculatedAttributeDefinitions` and `GetCalculatedAttributeForProfile` in either of the following Policies: **AmazonConnectServiceLinkedRolePolicy** or **AmazonConnectServiceCustomerProfileAccess**.

When configuring properties to **Get calculated attributes**, consider the following:

- **Mandatory Profile ID:** A Profile ID is required for this block to function. The **Get calculated attributes** action retrieves an object associated with the provided **ProfileID**. Ensure you provide the **ProfileID** by using a preceding **Get profile** block, as illustrated in the following image. Use the **Get profile** block to pinpoint the specific profile before moving forward to retrieve the profile's calculated attributes in the subsequent block.
- You have the option to manually input the Profile ID or utilize a pre-defined value stored in a pre-defined or user attribute.

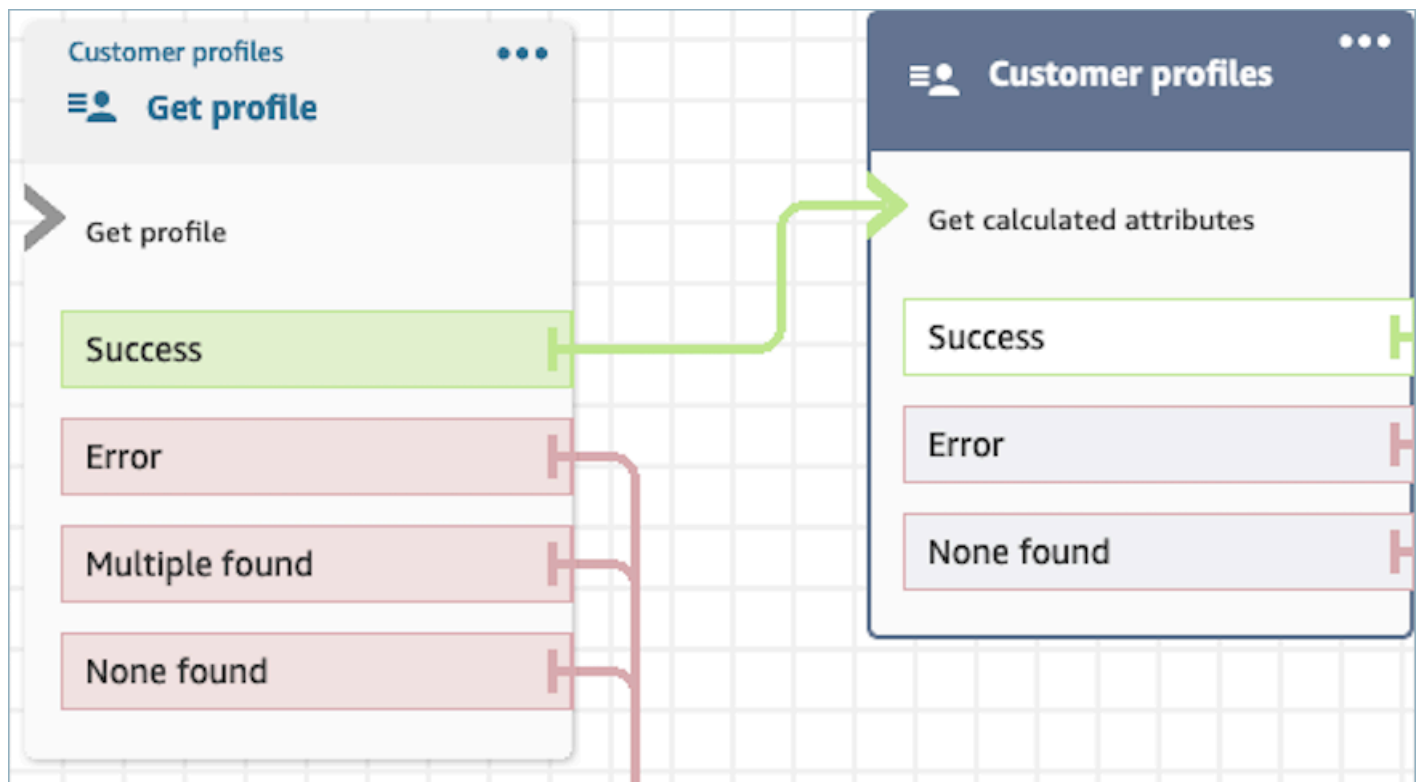

- Define attributes to persist in subsequent blocks, storing them in contact attributes under **Response fields**.
 - The options under **Response fields** are the Calculated Attribute definitions defined for your Customer Profiles domain
 - If the definition of calculated attributes uses a threshold, the calculated attribute value will be a Boolean and either return a True/False. Otherwise, they will return a numeric or string value. The return value of the calculated attribute can be used for branching purposes in a **Check Contact Attributes** block by using conditions such as **Equals** , **Is greater than** , **Is less than** , and **Contains**.

Contacts can be routed down the following branches:

- **Success:** A calculated attribute is found, and Response fields are stored in contact attributes.
- **Error:** An error occurred while attempting to retrieve the calculated attribute. This may be due to a system error or misconfiguration of the **Get calculated attribute** action.
- **None Found:** no calculated attribute is found.

The displayed block below is configured to get calculated attributes belonging to the provided **ProfileId** in contact attributes. The following **Response fields** will be retrieved and stored in contact attributes: **Average Call Duration**, and **Frequent Caller**.

Select an action

Action

Get calculated attributes



Profile ID

- Set manually
- Set dynamically

Namespace

Customer



Key

Profile ID



Calculated attributes

Calculated attributes

Average Call Duration , Frequent Caller

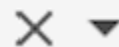

Average Call Duration X

Frequent Caller X

Properties: Associate contact to profile

Important

To use this action, your Amazon Connect instance must have permission for the following APIs: `ListCalculatedAttributeDefinitions` and `GetCalculatedAttributeForProfile` in either of the following Policies: **AmazonConnectServiceLinkedRolePolicy** or **AmazonConnectServiceCustomerProfileAccess**.

To use this action, you must also enable the Customer Profiles View permission in your security profile.

When configuring properties to **Associate contact to profile**, consider the following:

- Add a **Get profile** block before an **Associate contact to profile**, as shown in the following image. Use the **Get profile** block to find the profile first, then associate the contact and profile in the next block.
- **Mandatory Profile ID:** A Profile ID is required for this block to function. Ensure you provide the **ProfileID** by using a preceding **Get profile** block, as illustrated in the following image. Use the **Get profile** block to pinpoint the specific profile you wish to associate the contact to in the next block.
- You have the option to manually input the Profile ID or utilize a pre-defined value stored in a pre-defined or user attribute.

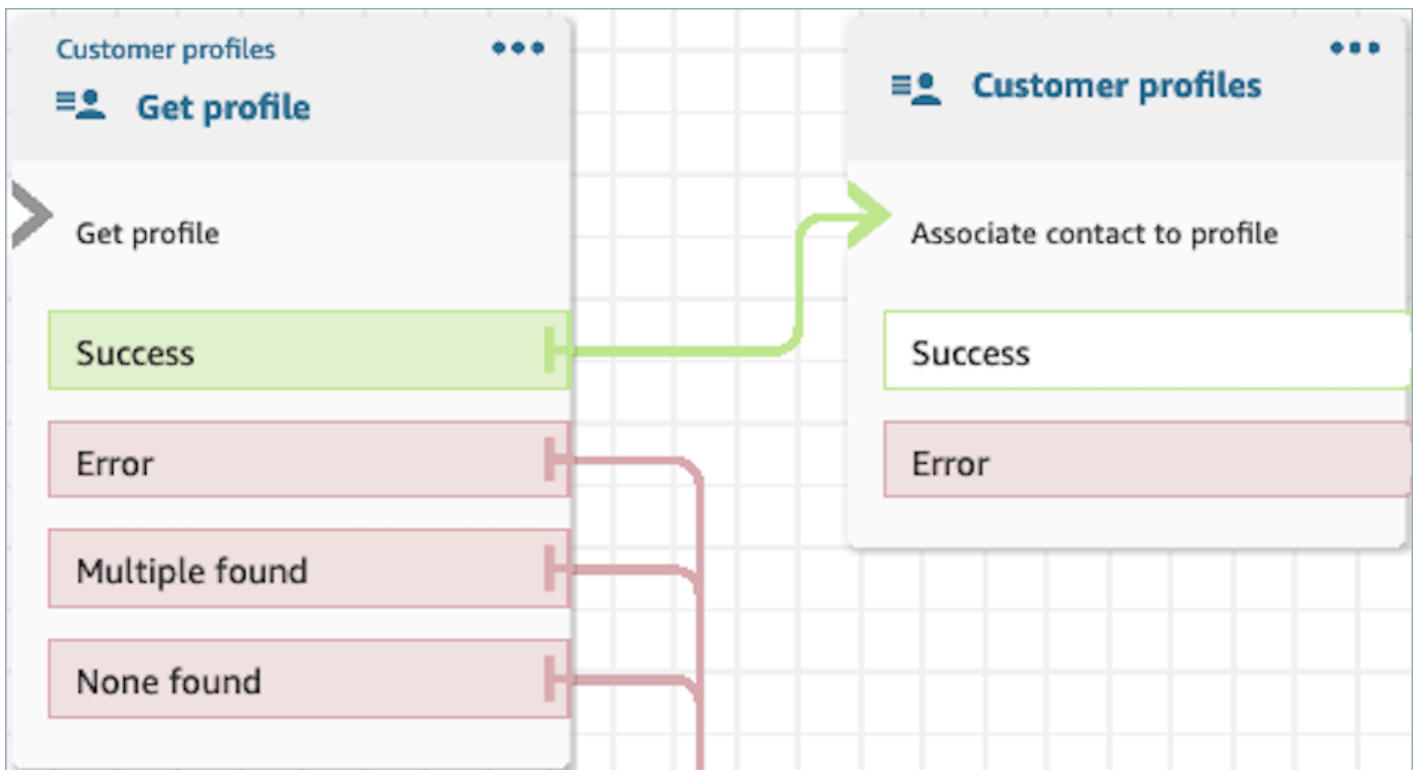

- You must provide a value for Contact ID.

Contacts can be routed down the following branches:

- **Success:** Associated the contact to profile.
- **Error:** An error was encountered while attempting to associate the contact to profile. This may be due to a system error or misconfiguration of the **Associate contact to profile** action.

The displayed block below is configured to associate the profile with **Profile ID** stored in contact attributes to the current Contact ID stored in contact attributes.

Select an action

Action

Associate contact to profile

To associate contact information with this profile, make sure you're using the ID you set previously through a Get profile action or a Lambda function.

Profile ID

- Set manually
- Set dynamically

Namespace

Customer

Key

Profile ID

Contact ID

- Set manually
- Set dynamically

Namespace

System

Key

Contact id

How to persist fields throughout the flow

Let's say you want customers to interact with your contact center and learn the status of their delivery order without directly communicating with an agent. Additionally, let's say you want to prioritize incoming calls from customers who have experienced more than 10 minutes delay in the past.

In these scenarios, the IVR needs to fetch the relevant information about the customer. This is achieved through the Customer Profiles block. Secondly, the IVR needs to leverage this customer data in other Flow blocks in order to personalize the experience and proactively service the customer.

1. Use **Play Prompt** to personalize the experience by greeting the customer by name and informing them of their status.

Block Type ✕

 **Play prompt**

Block Name

Enter a block name

0 / 50

Delivers an audio or chat message. [Learn more](#)

- Select from the prompt library (audio)
- Specify an audio file from an S3 bucket
- Text-to-speech or chat text
 - Set manually
- Set dynamically

Enter text to be spoken

Hi, \$.Customer.FirstName, I see your most recent Order of \$.Customer.Order.Name has delivery status \$.Customer.Order.Status.

- Set dynamically

Interpret as

Text ▼

2. Use **Check contact attributes** to conditionally route customers based on their Average Hold Time from previous interactions

Block Type ✕

Check contact attributes

Block Name

0 / 50

Branches based on a comparison to the value of a contact attribute. [Learn more](#)

Attribute to check

Namespace	▼
Customer	
Key	▼
Calculated Attributes	
Key	▼
Average Hold Time	

Conditions to check

condition ▼ ✕

Is greater than

value

10

[Add another condition](#)

No Match

Configured block

The following image shows an example of what this block looks like when it is configured. It shows four branches: **Success**, **Error**, **Multiple found**, and **None found**.

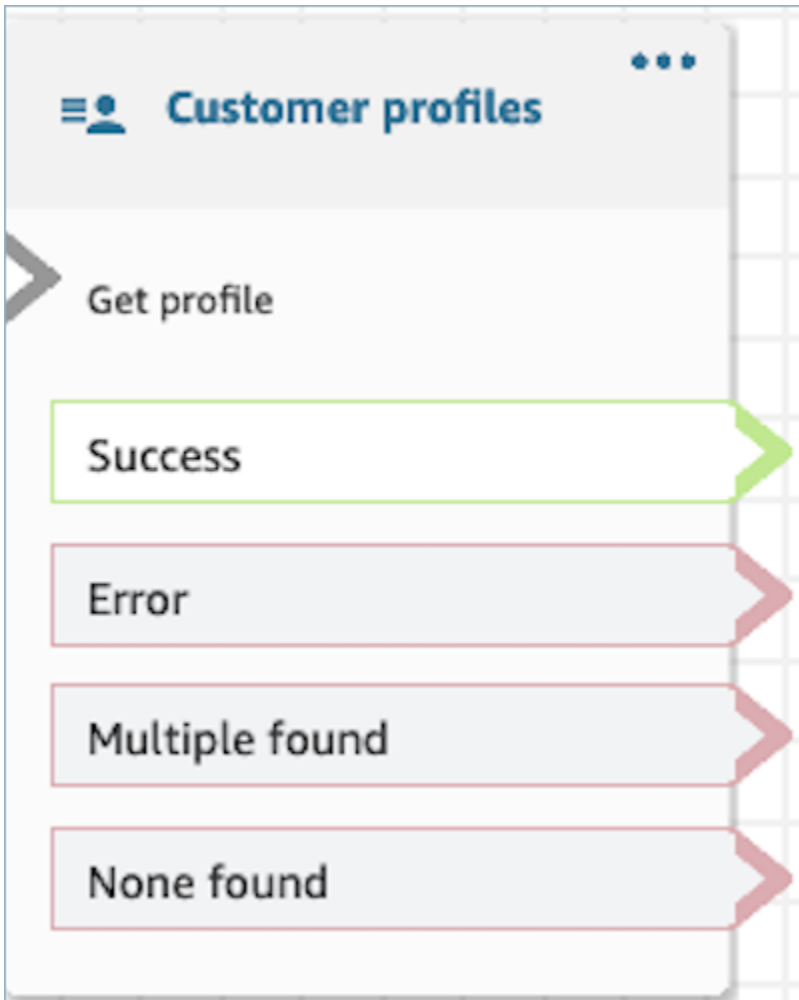

Flow block: Disconnect / hang up

Description

- Disconnects the contact.

Supported channels

The following table lists how this block routes a contact that is using the specified channel.

Channel	Supported?
Voice	Yes
Chat	Yes
Task	Yes

Flow types

You can use this block in the following [flow types](#):

- Inbound flow
- Customer queue flow
- Transfer to Agent flow
- Transfer to Queue flow

Flow block: Distribute by percentage

Description

- This block is useful for doing A/B testing. It routes customers randomly based on a percentage.
- Contacts are distributed randomly, so exact percentage splits may or may not occur.

Supported channels

The following table lists how this block routes a contact who is using the specified channel.

Channel	Supported?
Voice	Yes
Chat	Yes
Task	Yes

Flow types

You can use this block in the following [flow types](#):

- Inbound flow
- Customer queue flow
- Outbound Whisper flow
- Transfer to Agent flow
- Transfer to Queue flow

Properties

The following image shows the **Properties** page of the **Distribute by percentage** block. It is configured to route 50% of contacts to the test branch.

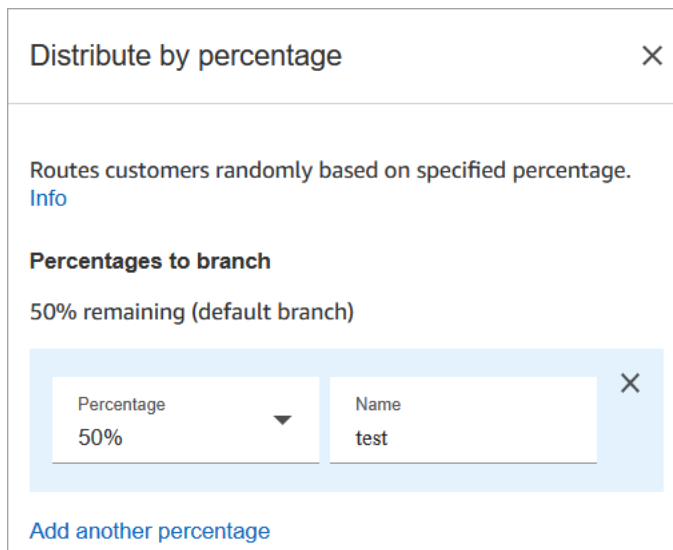

The screenshot shows the configuration interface for the 'Distribute by percentage' block. The title bar reads 'Distribute by percentage' with a close button (X). Below the title, there is a description: 'Routes customers randomly based on specified percentage.' followed by a blue 'Info' link. Underneath, the section 'Percentages to branch' is shown, with the text '50% remaining (default branch)'. A light blue box contains a configuration table with two columns: 'Percentage' and 'Name'. The 'Percentage' column has a dropdown menu currently set to '50%'. The 'Name' column has a text input field containing 'test'. There is a close button (X) in the top right corner of this configuration box. At the bottom left of the main configuration area, there is a blue link that says 'Add another percentage'.

Percentage	Name
50%	test

How it works

This block creates static allocation rules based on how you configure it. Internal logic generates a random number between 1-100. This number identifies which branch to take. It doesn't use current or historical volume as part of its logic.

For example, say a block is configure like this:

- 20% = A
- 40% = B
- 40% remaining = Default

When contact a is being routed through a flow, Amazon Connect generates the random number.

- If number is between 0-20, the contact is routed down the A branch.
- Between 21-60 it's routed down the B branch.
- Greater than 60 it's routed down the Default branch.

Configured block

The following image shows an example of what this block looks like when it is configured. It shows two branches: **50% test** and **50% default**.

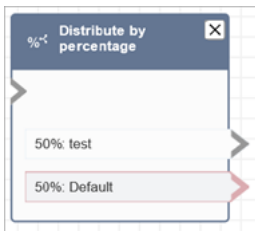

Sample flows

Amazon Connect includes a set of sample flows. For instructions that explain how to access the sample flows in the flow designer, see [Sample flows](#). Following are topics that describe the sample flows which include this block.

- [Sample AB test](#)

Flow block: End flow / Resume

Description

Important

The End flow / Resume block is a terminal flow block. It enables you to end a paused flow and return the contact without terminating the overall interaction. However, if you place the **End flow / Resume** block in an inbound flow or disconnect flow, it functions identically to the **Disconnect** block, and terminates the contact.

- Ends the current flow without disconnecting the contact.

- This block is often used for the **Success** branch of the **Transfer to queue** block. The flow doesn't end until the call is picked up by an agent.
- You also might use this block when a **Loop prompts** block is interrupted. You can return the customer to the **Loop prompts** block.
- You can also use this block to end a Paused flow and return the contact without terminating the overall interaction. For example, it's useful in flows where you are [pausing and resuming tasks](#).

Supported channels

The following table lists how this block routes a contact who is using the specified channel.

Channel	Supported?
Voice	Yes
Chat	Yes
Task	Yes

Flow types

Important

If you place the **End flow / Resume** block in an inbound flow or disconnect flow, it functions identically to the **Disconnect** block, and terminates the contact.

- All flows

Properties

The following image shows the **Properties** page of the **End flow / Resume** block.

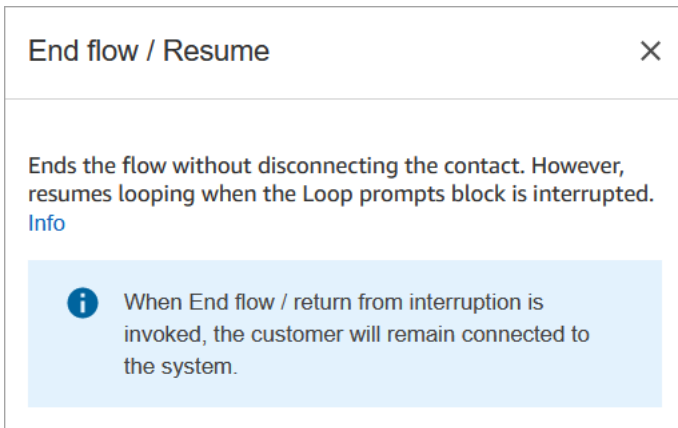

Configured block

The following image shows an example of what this block looks like when it is configured. It does not have any The End flow / Resume termination event branches.

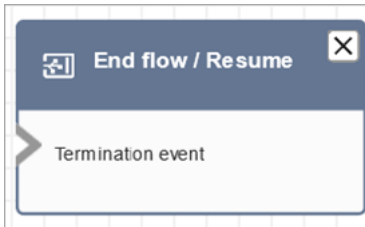

Flow block: Get customer input

Description

Captures interactive and dynamic input from customers. It supports interruptible prompts with DTMF input (input from a phone) and Amazon Lex bot.

Use cases for this block

This block is designed to be used in the following scenarios:

- Create interactive phone menus where customers can respond using touch-tone keypads. For example, "Press 1 for Sales, press 2 for Support."
- Enable voice-activated prompts by using this block with Amazon Lex bots. Customers can interrupt the prompts by speaking. This provides them with a more natural and responsive interaction.
- Collect customer information in a structured way. For example, asking customers to input their account number, order ID, or other relevant details.

- Route the customer to specific paths within the flow based on their input. This helps direct the customer to the appropriate department or service based on their needs.
- Gather feedback from customers by presenting options that allow them to express their satisfaction or concerns.
- Conduct surveys and poll customers to collect valuable feedback and insights.
- Guide customers through troubleshooting processes by asking specific questions related to their issues. You can provide tailored solutions based on their responses.

Contact types

The following table shows how this block routes a contact for each channel.

Channel	Supported?
Voice	Yes
Chat	Yes, when Amazon Lex is used, otherwise it takes the Error branch
Task	Yes

Flow types

You can use this block in the following [flow types](#):

Flow type	Supported?
Inbound flow	Yes
Customer queue flow	Yes
Customer hold flow	No
Customer whisper flow	No
Outbound whisper flow	No
Agent hold flow	No

Flow type	Supported?
Agent whisper flow	No
Transfer to agent flow	Yes
Transfer to queue flow	Yes

How to configure this block

You can configure the Get customer input block by using the Amazon Connect admin website, or by using the [GetParticipantInput](#) action in the Amazon Connect Flow language, or the [ConnectParticipantWithLexBot](#) and [Compare](#) actions.

Configuration sections

- [Select a prompt](#)
- [Configure for DTMF input](#)
- [Configure for Amazon Lex input](#)
- [Flow block branches](#)
- [Additional configuration tips](#)
- [Data generated by this block](#)

Select a prompt

The following image shows the **Properties** page of the **Get customer input** block. It is manually configured to play an audio prompt that says "Welcome to Example Corp."

The screenshot shows a configuration window titled 'Block Type' for the 'Get customer input' block. At the top, there is a 'Block Name' field with a placeholder 'Enter a block name' and a character count '0 / 50'. Below this, a description reads: 'Delivers an audio or chat message to solicit customer input. Based on response, the flow branches. [Learn more](#)'. There are four radio button options: 'Select from the prompt library (audio)', 'Specify an audio file from an S3 bucket', 'Text-to-speech or chat text' (which is selected), and 'Set manually' (which is also selected). Under 'Set manually', there is a text input field with the placeholder 'Enter text to be spoken' and the text 'Welcome to Example Corp.'. At the bottom, there is an 'Interpret as' dropdown menu currently set to 'Text'.

Choose from the following options to select a prompt to be played to the customer:

- **Select from the prompt library (audio):** You can choose from one of the pre-recorded prompts included with Amazon Connect, or use the Amazon Connect admin website to record and upload your own prompt.
- **Specify an audio file from an S3 bucket:** You can manually or dynamically specify an audio file from an S3 bucket.
- **Text-to-speech or chat text:** You can enter prompt to be played in plain text or SSML. These text-based prompts are played as audio prompts to customers using Amazon Polly. SSML-

enhanced input text gives you more control over how Amazon Connect generates speech from the text that you provide. You can customize and control aspects of speech, such as pronunciation, volume, and speed.

Configure for DTMF input

The following image shows the DTMF section of the **Properties** page. Two conditions have been added to determine the appropriate branching, depending whether the customer presses 1 or 2. It times out after 5 seconds if the customer doesn't enter anything.

The screenshot displays the configuration page for DTMF input. At the top, there are two tabs: 'DTMF' (selected) and 'Amazon Lex'. Below the tabs, a descriptive text reads: 'Plays an audio prompt and branches based on DTMF or Amazon Lex intents. The audio prompt is interruptible when using DTMF.' A configuration section titled 'Set timeout (Minimum one second)' contains a text input field with the value '5' and a unit label 'seconds'. Below this, there are two condition blocks, each with a light blue background and a close button (X). The first block is labeled 'Option 1' and the second is labeled 'Option 2'. At the bottom left, there is a link 'Add a condition'. At the bottom right, there are two buttons: 'Cancel' and 'Save'.

Choose the following options:

- **Set timeout:** Specify how long to wait while the user decides how they want to respond to the prompt. You must specify a minimum of 1 second. After this time elapses, a timeout error occurs. For the Voice channel, this is the timeout until the first DTMF digit is entered. Must be defined statically, and must be a valid integer larger than zero.

- **Add condition:** The number against which the customer input is compared.

Flow language representation when DTMF is used

The following code example shows how a DTMF configuration would be represented by the [GetParticipantInput](#) action in the Flow language.

```
{
  "Parameters": {
    "StoreInput": "False",
    "InputTimeLimitSeconds": "5",
    "Text": "Welcome to Example Corp. Please press 1 for sales, press 2 for support"
  },
  "Identifier": "Get Customer Input",
  "Type": "GetParticipantInput",
  "Transitions": {
    "NextAction": "d8701db7-3d31-4581-bd4c-cb49c38c6f43",
    "Conditions": [
      {
        "NextAction": "d8701db7-3d31-4581-bd4c-cb49c38c6f43",
        "Condition": {
          "Operator": "Equals",
          "Operands": [
            "1"
          ]
        }
      },
      {
        "NextAction": "d8701db7-3d31-4581-bd4c-cb49c38c6f43",
        "Condition": {
          "Operator": "Equals",
          "Operands": [
            "2"
          ]
        }
      }
    ],
    "Errors": [
      {
        "NextAction": "d8701db7-3d31-4581-bd4c-cb49c38c6f43",
        "ErrorType": "InputTimeLimitExceeded"
      }
    ]
  }
}
```

```

    {
      "NextAction": "d8701db7-3d31-4581-bd4c-cb49c38c6f43",
      "ErrorType": "NoMatchingCondition"
    },
    {
      "NextAction": "d8701db7-3d31-4581-bd4c-cb49c38c6f43",
      "ErrorType": "NoMatchingError"
    }
  ]
}
}

```

Configure for Amazon Lex input

- **Select a Lex bot:** After you create your Amazon Lex bot, choose the name of the bot from the drop-down list. Only built bots appear in the drop-down list.
- **Enter an ARN:** Specify the Amazon Resource Name of the Amazon Lex bot.
- **Session attributes:** Specify [Amazon Lex session attributes](#) that apply to the current contact's session only. The following image shows the session attributes configured for a max speech duration of 8000 milliseconds (8 seconds).

Session attributes

Destination key
x-amz-lex:max-speech-duration-ms:*:*

Set manually

Value
8000

Set dynamically

[Add an attribute](#)

• Intents

- **Add intent:** Choose to enter the name of the Amazon Lex bot intent to compare against.
- **Use sentiment override:** Branch based on sentiment score, before the Amazon Lex intent.

The sentiment score is based on the last utterance of the customer. It is not based on the entire conversation.

For example, a customer calls and they have a negative sentiment because their preferred appointment time isn't available. You can branch the flow based on their negative sentiment score, for example, if their negative sentiment is more than 80%. Or, a customer calls and has a positive sentiment of more than 80%, you can branch to upsell them on services.

The following image shows the Intents section of the Amazon Lex tab. It is configured to route the contact when their negative sentiment score is 80%.

Intents

[Add an intent](#)

Use sentiment override
Branch based on sentiment score, before the Lex intent. [Info](#)

Branch on negative sentiment score

Set manually

Negative sentiment score
80%

Set dynamically

Branch on positive sentiment score

If you add both negative and positive sentiment scores, the negative score is always evaluated first.

For information about how to use sentiment score, alternative intents, and sentiment label with contact attributes, see [Check contact attributes](#).

Configurable time-outs for voice input

To configure time-out values for voice contacts, use the following session attributes in the **Get customer input** block that calls your Lex bot. These attributes allow you to specify how long to wait for the customer to finish speaking before Amazon Lex collects speech input from callers, such as answering a yes/no question, or providing a date or credit card number.

Amazon Lex

- **Max Speech Duration**

```
x-amz-lex:audio:max-length-ms:[intentName]:[slotToElicit]
```

How long the customer speaks before the input is truncated and returned to Amazon Connect. You can increase the time when a lot of input is expected or you want to give customers more time to provide information.

Default = 12000 milliseconds (12 seconds). The maximum allowed value is 15000 milliseconds.

⚠ Important

If you set **Max Speech Duration** to more than 15000 milliseconds, the contact is routed down the **Error** branch.

- **Start Silence Threshold**

```
x-amz-lex:audio:start-timeout-ms:[intentName]:[slotToElicit]
```

How long to wait before assuming that the customer isn't going to speak. You can increase the allotted time in situations where you'd like to allow the customer more time to find or recall information before speaking. For example, you might want to give customers more time to get out their credit card so they can enter the number.

Default = 3000 milliseconds (3 seconds).

- **End Silence Threshold**

```
x-amz-lex:audio:end-timeout-ms:[intentName]:[slotToElicit]
```

How long to wait after the customer stops speaking before assuming the utterance has concluded. You can increase the allotted time in situations where periods of silence are expected while providing input.

Default = 600 milliseconds (0.6 seconds)

Amazon Lex (Classic)

- **Max Speech Duration**

```
x-amz-lex:max-speech-duration-ms:[intentName]:[slotToElicit]
```

How long the customer speaks before the input is truncated and returned to Amazon Connect. You can increase the time when a lot of input is expected or you want to give customers more time to provide information.

Default = 12000 milliseconds (12 seconds). The maximum allowed value is 15000 milliseconds.

 **Important**

If you set **Max Speech Duration** to more than 15000 milliseconds, the contact is routed down the **Error** branch.

- **Start Silence Threshold**

```
x-amz-lex:start-silence-threshold-ms:[intentName]:[slotToElicit]
```

How long to wait before assuming that the customer isn't going to speak. You can increase the allotted time in situations where you'd like to allow the customer more time to find or recall information before speaking. For example, you might want to give customers more time to get out their credit card so they can enter the number.

Default = 3000 milliseconds (3 seconds).

- **End Silence Threshold**

```
x-amz-lex:end-silence-threshold-ms:[intentName]:[slotToElicit]
```

How long to wait after the customer stops speaking before assuming the utterance has concluded. You can increase the allotted time in situations where periods of silence are expected while providing input.

Default = 600 milliseconds (0.6 seconds)

Configurable time-outs for chat input during a Lex interaction

Use the **Chat timeout** field under **Intents** to configure timeouts for chat input. Enter how long until inactive customers timeout in a Lex interaction.

- Minimum: 1 minute
- Maximum: 7 days

The following image shows the **Get customer input** block configured to timeout chats when the customer is inactive for 2 minutes.

The screenshot shows the 'Intents' configuration interface. At the top, there is a link 'Add an intent'. Below it, there is an unchecked checkbox for 'Use sentiment override' with the text 'Branch based on sentiment score, before the Lex intent.' and an 'Info' link. The 'Chat timeout' option is checked, and its configuration is highlighted with a red box. It consists of a 'Number' field set to '2' and a 'Units' dropdown menu set to 'Minutes'. At the bottom right, there are 'Cancel' and 'Save' buttons.

For information about setting up chat timeouts when all participants are human, see [Set up chat timeouts for chat participants](#).

Barge-in configuration and usage for Amazon Lex

You can allow customers to interrupt the Amazon Lex bot mid-sentence using their voice, without waiting for it to finishing speaking. Customers familiar with choosing from a menu of options, for example, can now do so without having to listen to the entire prompt.

Amazon Lex

- **Barge-in**

Barge-in is enabled globally by default. You can disable it in the Amazon Lex console. For more information, see [Enabling your bot to be interrupted by your user](#). Additionally, you can modify barge-in behavior, by using the allow-interrupt session attribute. For example, `x-amz-lex:allow-interrupt:*:*` allows interrupt for all intents and all slots. For more information, see [Configuring timeouts for capturing user input](#) in the *Amazon Lex V2 Developer Guide*.

Amazon Lex (Classic)

- **Barge-in**

```
x-amz-lex:barge-in-enabled:[intentName]:[slotToElicit]
```

Barge-in is disabled globally by default. You must set the session attribute in the **Get customer input** block that calls your Lex bot to enable it at the global, bot, or slot levels.

This attribute only controls Amazon Lex barge-in; it doesn't control DTMF barge-in. For more information, see [How flow blocks use Lex session attributes](#).

The following image shows the **Session attributes** section with barge-in enabled.

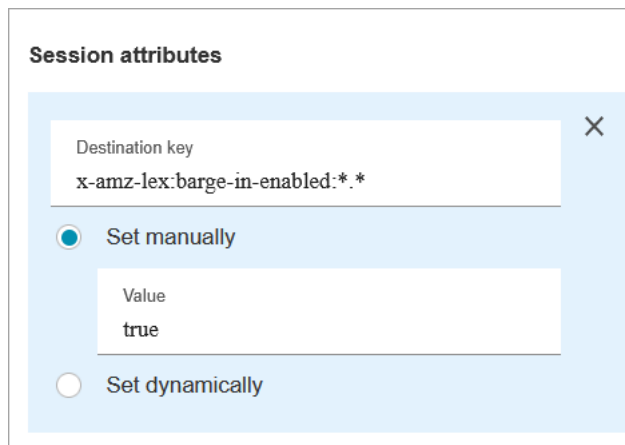

Configurable fields for DTMF input

Use the following session attributes to specify how your Lex bot responds to DTMF input.

- **End character**

```
x-amz-lex:dtmf:end-character:[IntentName]:[SlotName]
```

The DTMF end character that ends the utterance.

Default = #

- **Deletion character**

```
x-amz-lex:dtmf:deletion-character:[IntentName]:[SlotName]
```

The DTMF character that clears the accumulated DTMF digits and ends the utterance.

Default = *

- **End timeout**

```
x-amz-lex:dtmf:end-timeout-ms:[IntentName]:[SlotName]
```

The idle time (in milliseconds) between DTMF digits to consider the utterance as concluded.

Default = 5000 milliseconds (5 seconds)

- **Max number of allow DTMF digits per utterance**

```
x-amz-lex:dtmf:max-length:[IntentName]:[SlotName]
```

The maximum number of DTMF digits allowed in a given utterance. This cannot be increased.

Default = 1024 characters

For more information, see [How flow blocks use Lex session attributes](#).

Flow Language representation when Amazon Lex is used

The following code sample shows how an Amazon Lex configuration would be represented by the [ConnectParticipantWithLexBot](#) action in the Flow language:

```
{
  "Parameters": {
    "Text": "Welcome to Example Corp. Please press 1 for sales, press 2 for support",
    "LexV2Bot": {
      "AliasArn": "arn:aws:lex:us-west-2:23XXXXXXXXXX:bot-alias/3HL7SXXXXX/
TSTALXXXXX"
    },
    "LexTimeoutSeconds": {
      "Text": "300"
    }
  },
  "Identifier": "Get Customer Input",
  "Type": "ConnectParticipantWithLexBot",
  "Transitions": {
    "NextAction": "d8701db7-3d31-4581-bd4c-cb49c38c6f43",
    "Errors": [
      {
        "NextAction": "d8701db7-3d31-4581-bd4c-cb49c38c6f43",
        "ErrorType": "InputTimeLimitExceeded"
      },
      {
        "NextAction": "d8701db7-3d31-4581-bd4c-cb49c38c6f43",
        "ErrorType": "NoMatchingError"
      },
      {
        "NextAction": "Get Customer Input-ygqIfPM1n2",
        "ErrorType": "NoMatchingCondition"
      }
    ]
  }
}
```

```

    ]
  }
}

```

Fragmented action representation

The following code sample represents a fragmented [Compare](#) action for a Amazon Lex sentiment score returned from a Lex bot after the conversation.

```

{
  "Parameters": {
    "ComparisonValue": "$.Lex.SentimentResponse.Scores.Negative"
  },
  "Identifier": "Get Customer Input-ygqIfPM1n2",
  "Type": "Compare",
  "Transitions": {
    "NextAction": "Get Customer Input-xDRo1hbBRB",
    "Conditions": [
      {
        "NextAction": "d8701db7-3d31-4581-bd4c-cb49c38c6f43",
        "Condition": {
          "Operator": "NumberGreaterOrEqualTo",
          "Operands": [
            "0.08"
          ]
        }
      }
    ],
    "Errors": [
      {
        "NextAction": "Get Customer Input-xDRo1hbBRB",
        "ErrorType": "NoMatchingCondition"
      }
    ]
  }
}

```

Flow block branches

The following image shows an example of what this block looks like when it is configured for DTMF input. It shows two branches for input: **Pressed 1** and **Pressed 2**. It also shows branches for **Timeout**, **Default**, and **Error**.

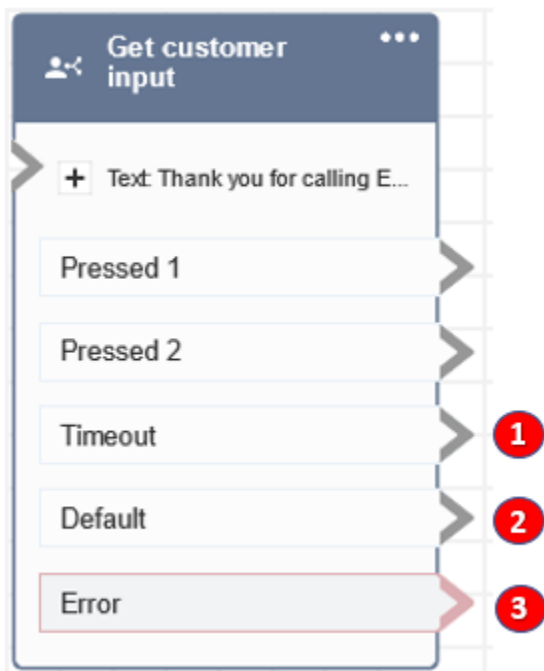

1. **Timeout:** What to do when no input is provided by the customer for the specified chat timeout in Amazon Lex or the **Set timeout** value specified for DTMF.
2. **Default:** If the customer enters input that doesn't match any condition in DTMF, or an intent executed in Amazon Lex bot. This the preceding image, the contact is routed down the **Default** branch if they enter a value other than 1 or 2.
3. **Error:** If the block is run but results in an error for DTMF, or an intent is not fulfilled in Amazon Lex bot.

Additional configuration tips

- The **Get customer input** block does not support using a voice prompt from an S3 bucket with Amazon Lex V2.
- For information about choosing a prompt from the Amazon Connect library or an S3 bucket, see the [Play prompt](#) block.
- You can configure this block to accept DTMF input or a chat response. You can also configure it work with Amazon Lex for example, a contact can be routed based on their utterance.
 - Session attributes available for the integration with Amazon Lex. This topic explains some of the session attributes available for the integration with Amazon Lex. For a list of all the available Amazon Lex session attributes, see [Configuring timeouts for capturing user input](#).

When you use text, either for text-to-speech or chat, you can use a maximum of 3,000 billed characters (6,000 total characters).

- Amazon Lex bots support both spoken utterances and keypad input when used in a flow.
- For both voice and DTMF, there can be only one set of session attributes per conversation. Following is the order of precedence:
 1. Lambda provided session attributes: Overrides to session attributes during customer Lambda invocation.
 2. Amazon Connect console provided session attributes: Defined in the **Get customer input** block.
 3. Service defaults: These are used only if no attributes are defined.
- You can prompt contacts to end their input with a pound key # and to cancel it using the star key *. When you use a Lex bot, if you don't prompt customers to end their input with #, they will end up waiting five seconds for Lex to stop waiting for additional key presses.
- To control time-out functionality, you can use Lex session attributes in this block, or in set them in your Lex Lambda function. If you choose to set the attributes in a Lex Lambda function, the default values are used until the Lex bot is invoked. For more information, see [Using Lambda Functions](#) in the *Amazon Lex Developer Guide*.
- When you specify one of the session attributes described in this article, you can use wildcards. They let you set multiple slots for an intent or bots.

Following are some examples of how you can use wildcards:

- To set all slots for a specific intent, such as PasswordReset, to 2000 milliseconds:

```
Name = x-amz-lex:max-speech-duration-ms:PasswordReset:*
```

```
Value = 2000
```

- To set all slots for all bots to 4000 milliseconds:

```
Name = x-amz-lex:max-speech-duration-ms:*:*
```

```
Value = 4000
```

Wildcards apply across bots but not across blocks in a flow.

For example, you have a Get_Account_Number bot. In the flow, you have two **Get customer input** blocks. The first block sets the session attribute with a wildcard. The second one doesn't

set the attribute. In this scenario, the change in behavior for the bot applies only to the first **Get customer input** block, where the session attribute is set.

- Because you can specify that session attributes apply to the intent and slot level, you can specify that the attribute is set only when you're collecting a certain type of input. For example, you can specify a longer **Start Silence Threshold** when you're collecting an account number than when you're collecting a date.
- If DTMF input is provided to a Lex bot using Amazon Connect, the customer input is made available as a [Lex request attribute](#). The attribute name is `x-amz-lex:dtmf-transcript` and the value can be a maximum of 1024 characters.

Following are different DTMF input scenarios:

Customer input	DTMF transcript
[DEL]	[DEL]
[END]	[END]
123[DEL]	[DEL]
123[END]	123

Where:

- [DEL] = Deletion character (Default is *)
- [END] = End character (Default is #)

Data generated by this block

This block does not generate any data.

Error scenarios

Let's say you have the following scenario with two flows, each one capturing DTMF input from customers:

1. One flow uses the **Get customer input** block to request DTMF input from customers.

2. After the DTMF input is entered, it uses the **Transfer to flow** block to move the contact to the next flow.
3. In the next flow, there's a **Store customer input** block to get more DTMF input from the customer.

There's setup time between the first and second flows. This means if the customer enters DTMF input very quickly for the second flow, some of the DTMF digits might be dropped.

For example, the customer needs to press 5, then wait for a prompt from the second flow, then type 123. In this case, 123 is captured without problem. However, if they don't wait for the prompt and enter 5123 very quickly, the Store customer input block may capture only 23 or 3.

To guarantee the **Store customer input** block in second flow captures all of the digits, the customer needs to wait for the prompt to be played, and then enter their type DTMF input.

Sample flows

Amazon Connect includes a set of sample flows. For instructions that explain how to access the sample flows in the flow designer, see [Sample flows](#). Following are topics that describe the sample flows which include this block.

- [Sample inbound flow \(first contact experience\)](#)
- [Sample interruptible queue flow with callback](#)
- [Sample queue configurations](#)
- [Sample recording behavior](#)

More resources

See the following topics to learn more about Amazon Lex and adding prompts.

- [Add an Amazon Lex bot to Amazon Connect](#)
- [How to use the same bot for voice and chat](#)
- [Add text-to-speech to prompts](#)

Flow block: Get queue metrics

Description

- Retrieves near real-time queue metrics with a 5-10 second delay for more granular routing decisions.
- You can route contacts based on queue or agent status, such as the number of contacts in queue or agents available.
- Queue metrics are aggregated across all channels by default and are returned as attributes.
- The current queue is used by default.
- For agent-based metrics (such as agents online, agents available, or agents staffed), if there are no agents, no metrics are returned.
- Following are the metrics that can be retrieved:
 - [Queue name](#)
 - Queue ARN
 - [Contacts in queue](#)
 - [Oldest contact in queue](#)
 - [Agents online](#)
 - [Agents available](#)
 - [Agents staffed](#)
 - [Agents after contact work](#)
 - [Agents busy](#)
 - [Agents missed](#) (Agent non-response)
 - [Agents non-productive](#)
- You can choose to return metrics by channel, for example, voice or chat. You can also filter by queue or agent. These options enable you to know how many chat and voice contacts are in a queue and if you have agents available to handle those contacts.
- You can route contacts based on queue status, such as number of contacts in queue or agents available. Queue metrics are aggregated across all channels and are returned as attributes. The current queue is used by default.
- After a **Get queue metrics** block, use a [Check contact attributes](#) to check metric values and define routing logic based on them, such as number of contacts in a queue, number of available agents, and oldest contact in a queue.

Supported channels

The following table lists how this block routes a contact who is using the specified channel.

Channel	Supported?
Voice	Yes
Chat	Yes
Task	Yes

Flow types

You can use this block in the following [flow types](#):

- All flows

Properties

The following image shows the **Properties** page of the **Get queue metrics** block. It is configured to retrieve metrics for the **Voice** channel.

The screenshot shows a configuration window titled "Get queue metrics" with a close button (X) in the top right corner. The window contains the following text and options:

Retrieves real-time metrics for a queue.

Retrieve metrics from a queue so you can make routing decisions. You can route contacts based on queue status, such as number of contacts in queue or agents available. Queue metrics are aggregated across all channels by default and are returned as attributes. The current queue is used by default. [Info](#)

Optional parameters

- Set channel
 - Set manually
 - Voice
 - Chat
 - Task
 - Set dynamically
- Set queue

You can retrieve metrics by channel, and/or by queue or agent.

- If you don't specify a channel, it returns metrics for all channels.
- If you don't specify a queue, it returns metrics for the current queue.
- Dynamic attributes can only return metrics for one channel.

For example, the following image shows the **Properties** page configured for the **Chat** channel and **BasicQueue**. If you choose these settings **Get queue metrics** would return metrics for only the **BasicQueue**, filtered to include only chat contacts.

Optional parameters

Set channel

- Set manually
 - Voice
 - Chat
 - Task
- Set dynamically

Set queue

- By queue
 - Set manually
 - Search for queue
 - BasicQueue
- Set dynamically
- By agent

Configuration tips

Specifying a channel in the Set contact attributes block

Dynamic attributes can only return metrics for one channel.

Before you use dynamic attributes in the **Get queue metrics** block, you need to set the attributes in the [Set contact attributes](#) block, and specify which channel.

When you set a channel dynamically using text, as shown in the following image, for the attribute value enter **Voice** or **Chat**. This value is not case-sensitive.

Using the Check contact attributes block after the Get queue metrics block

After a **Get queue metrics** block, add a [Check contact attributes](#) block to branch based on the returned metrics. Use the following steps:

1. After **Get queue metrics**, add a **Check contact attributes** block.
2. In the **Check contact attributes** block, set **Attribute to check** to **Queue metrics**.
3. In the **Value** dropdown box, you'll see a list of queue metrics that can be checked by the **Get queue metrics** block. Choose the metric that you want to use for the routing decision.

Why Get queue metrics block throws an error

The **Get queue metrics** block throws an error in the following scenario:

1. You add this block to your flow.
2. There are no active agents or contacts in queues in your Amazon Connect instance.
3. The Real-time metrics report returns empty metrics because no activity is taking place.
4. The **Get queue metrics** block throws an error because there are no metrics to display.

Configured block

The following image shows an example of what this block looks like when it is configured. It has two branches: **Success** and **Error**.

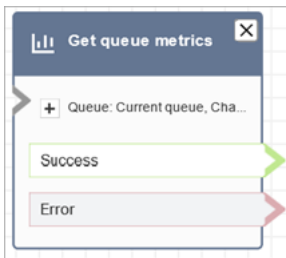

Scenarios

See these topics for scenarios that use this block:

- [How to reference contact attributes](#)

Flow block: Hold customer or agent

Description

- Places a customer or agent on or off hold. This is useful when, for example, you want to put the agent on hold while the customer enters their credit card information.
- If this block is triggered during a chat conversation, the contact is routed down the **Error** branch.

Supported channels

The following table lists how this block routes a contact who is using the specified channel.

Channel	Supported?
Voice	Yes
Chat	No - Error branch
Task	No - Error branch

Flow types

You can use this block in the following [flow types](#):

- Inbound flow
- Outbound Whisper flow
- Transfer to Agent flow
- Transfer to Queue flow

Properties

The following image shows the **Properties** page of the **Hold customer or agent** block. It shows that the dropdown list has three options: **Agent on hold**, **Customer on hold**, and **Conference all**.

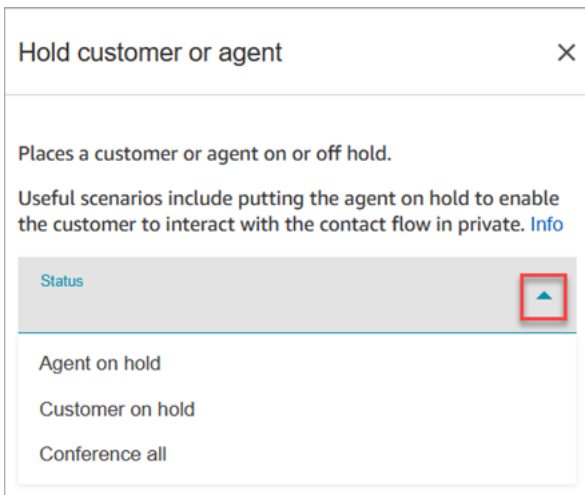

These options are defined as follows:

- **Agent on hold** = customer is on the call
- **Conference all** = agent and customer are on the call

- **Customer on hold** = agent is on the call

Configured block

The following image shows an example of what this block looks like when it is configured. It is configured for **Agent on hold**, and it has two branches: **Success** and **Error**.

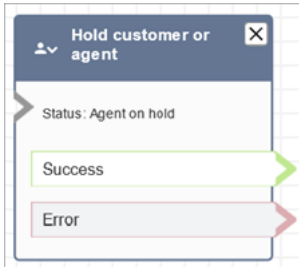

Samples flows

[Sample secure input with agent](#)

Flow block: Invoke AWS Lambda function

Description

- Calls AWS Lambda, and optionally returns key-value pairs.
- The returned key-value pairs can be used to set contact attributes.
- For an example, see [Tutorial: Create a Lambda function and invoke in a flow](#).

Supported channels

The following table lists how this block routes a contact who is using the specified channel.

Channel	Supported?
Voice	Yes
Chat	Yes
Task	Yes

Flow types

You can use this block in the following [flow types](#):

- Inbound flow
- Customer Queue flow
- Customer Hold flow
- Customer Whisper flow
- Agent Hold flow
- Agent Whisper flow
- Transfer to Agent flow
- Transfer to Queue flow

Properties

The following image shows the **Properties** page of the **AWS Lambda function** block.

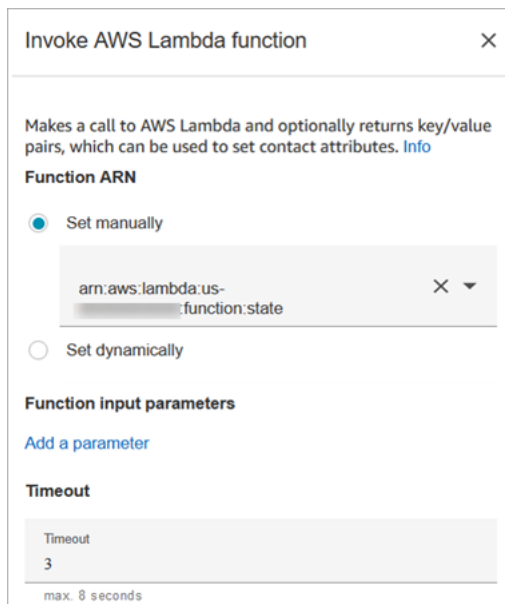

Invoke AWS Lambda function ×

Makes a call to AWS Lambda and optionally returns key/value pairs, which can be used to set contact attributes. [Info](#)

Function ARN

Set manually

arn:aws:lambda:us-
:function:state × ▼

Set dynamically

Function input parameters

[Add a parameter](#)

Timeout

Timeout
3

max: 8 seconds

Note the following properties:

- **Timeout:** Enter how long to wait for Lambda to time out.

If your Lambda invocation gets throttled, the request is retried. It is also retried if a general service failure (500 error) happens.

When a synchronous invocation returns an error, Amazon Connect retries up to three times, for a maximum of 8 seconds. At that point, the contact is routed down the **Error** branch.

- **Response validation:** The Lambda function response could be either a `STRING_MAP` or `JSON` and has to be set while configuring the **Invoke AWS Lambda function** block in the flow. If response validation is set to `STRING_MAP`, then the lambda function should return a flat object of key/value pairs of the string type. Otherwise, if response validation is set to `JSON`, the lambda function can return any valid JSON including nested JSON.

Configuration tips

- To use an AWS Lambda function in a flow, first add the function to your instance. For more information, see [Add a Lambda function to your Amazon Connect instance](#),
- After you add the function to your instance, you can select the function from the **Select a function** drop-down list in the block to use it in the flow.

Configured block

The following image shows an example of what this block looks like when it is configured. It has two branches: **Success** and **Error**.



Sample flows

Amazon Connect includes a set of sample flows. For instructions that explain how to access the sample flows in the flow designer, see [Sample flows](#). Following are topics that describe the sample flows which include this block.

[Sample Lambda integration](#)

Scenarios

See these topics for scenarios that use this block:

- [Invoke AWS Lambda functions](#)

Flow block: Invoke module

Description

Calls a published module, which enables you create reusable sections of a contact flow.

For more information, see [Flow modules for reusable functions](#).

Supported channels

The following table lists how this block routes a contact who is using the specified channel.

Channel	Supported?
Voice	Yes
Chat	Yes
Task	Yes

Flow types

You can use this block in the following [flow types](#):

- Inbound flow

Properties

The following image shows the **Properties** page of the **Invoke module** block.

Invoke module
✕

Select a module to invoke in a contact flow. [Info](#)

Module name

Set manually

Module name

TestModule

Set dynamically

Configured block

The following image shows an example of what this block looks like when it is configured. It has two branches: **Success** and **Error**.



Flow block: Loop

Description

- Counts the number of times customers are looped through the **Looping** branch.
- After the loops are completed, the **Complete** branch is followed.
- This block is often used with a **Get customer input** block. For example, if the customer doesn't succeed in entering their account number, you can loop to give them another opportunity to enter it.

Supported channels

The following table lists how this block routes a contact who is using the specified channel.

Channel	Supported?
Voice	Yes
Chat	Yes
Task	Yes

Flow types

You can use this block in the following [flow types](#):

- All flows

Properties

The following image shows the **Properties** page of the **Loop** block. It is configured to repeat three times, and then it branches.

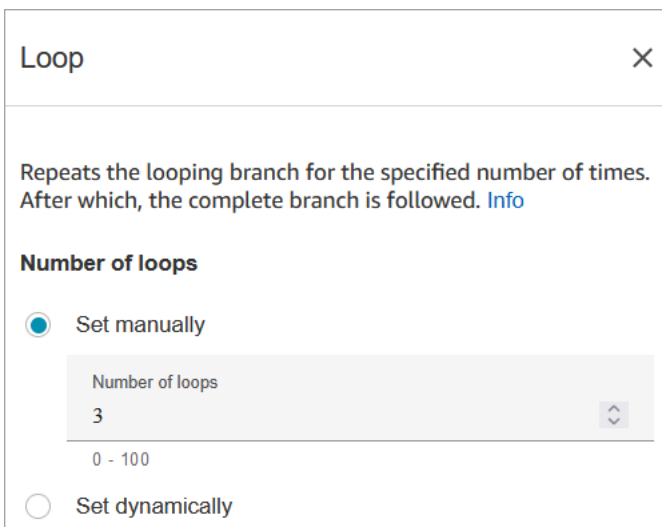

The screenshot shows a configuration window titled "Loop" with a close button (X) in the top right corner. Below the title, there is a descriptive text: "Repeats the looping branch for the specified number of times. After which, the complete branch is followed. [Info](#)".

Under the heading "Number of loops", there are two radio button options:

- Set manually
- Set dynamically

Under the "Set manually" option, there is a text input field labeled "Number of loops" containing the value "3". Below the input field, the range "0 - 100" is displayed. A small up/down arrow icon is visible to the right of the input field.

Configuration tips

- If you enter 0 for the loop count, the **Complete** branch is followed the first time this block runs.

Configured block

The following image shows an example of what this block looks like when it is configured. It has two branches: **Looping** and **Complete**.



Flow block: Loop prompts

Description

- Loops a sequence of prompts while a customer or agent is on hold or in queue.

Supported channels

The following table lists how this block routes a contact who is using the specified channel.

Channel	Supported?
Voice	Yes
Chat	No - Error branch
Task	No - Error branch

Flow types

You can use this block in the following [flow types](#):

- Customer Queue flow
- Customer Hold flow
- Agent Hold flow

Properties

The following image shows the **Properties** page of the **Loop prompts** block. It shows there are three types of prompts you can choose from the dropdown list: **Audio recording**, **Text to Speech**, **S3 file path**.

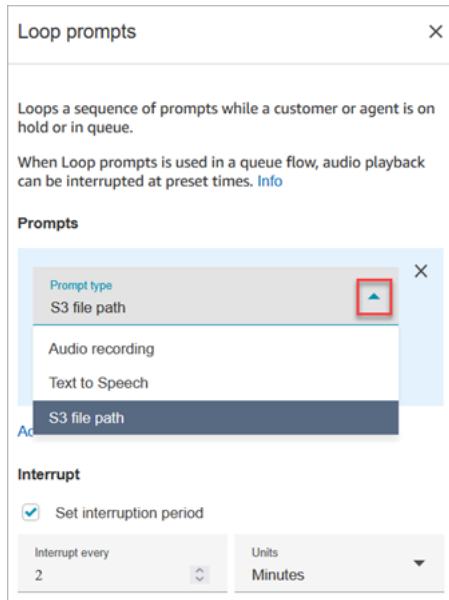

How the Interrupt option works

Let's say you have multiple prompts and you set **Interrupt** to 60 seconds. Following is what will happen:

- The block plays prompts in the order that they are listed for the entirety of the prompt length.
- If the combined play time for the prompts is 75 seconds, after 60 seconds the prompt is interrupted and reset to the 0 second point again.
- It's possible your customers would never hear potentially important information that is supposed to play after 60 seconds.

This scenario is especially possible when using the default audio prompts that Amazon Connect provides since these audio prompts can be as long as 4 minutes.

Configuration tips

- The following blocks are not allowed before the **Loop prompts** block:
 - [Get customer input](#)

- [Loop](#)
- [Play prompt](#)
- [Start media streaming](#)
- [Stop media streaming](#)
- [Store customer input](#)
- [Transfer to phone number](#)
- [Transfer to queue](#), including **Transfer to callback queue**
- For information about choosing a prompt from the Amazon Connect library or an S3 bucket, see the [Play prompt](#) block.
- When **Loop prompts** is used in a Queue flow, audio playback can be interrupted with a flow at preset times.
- Always use an interruption period that's greater than 20 seconds. This is the amount of time an available agent has to accept the contact. If the interruption period is less than 20 seconds, you might get contacts going down the **Error** branch. This is because Amazon Connect doesn't support dequeuing the customer when they are being routed to an active agent and are in the 20 second window to join.
- The internal counter for the loop is persisted for the call, not the flow. If you reuse the flow during a call, the loop counter isn't reset.
- If this block is triggered during a chat conversation, the contact is routed down the **Error** branch.
- Some existing flows have a version of the **Loop prompts** block that doesn't have an **Error** branch. In this case, a chat contact stops execution of the customer queue flow. The chat is routed when the next agent becomes available.

Configured block

The following image shows what this block looks like when it is configured to play a prompt from the Amazon Connect library. Choose + next to **Audio Recording** to view the full name of the file. The configured block has two branches: **Timeout** and **Error**.

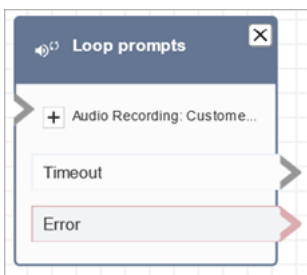

The following image shows what this block looks like when it is configured to play a prompt from Amazon S3. Choose + next to **S3 path** to view the full path. The configured block has two branches: **Timeout** and **Error**.



Sample flows

Amazon Connect includes a set of sample flows. For instructions that explain how to access the sample flows in the flow designer, see [Sample flows](#). Following are topics that describe the sample flows which include this block.

- [Sample interruptible queue flow with callback](#)

Scenarios

See these topics for scenarios that use this block:

- [Manage contacts in a queue](#)

Flow block: Play prompt

Description

Use this flow block to play an audio prompt or a text-to-speech message, or to send a chat response.

You can play prompts to customers (callers or customers using chat) and agents.

For calls, you have the following options:

- **Use pre-recorded prompts:** Amazon Connect provides a library of ready-made options.
- **Record your own prompts.** You have the following options:
 - Use the Amazon Connect library. Upload your recordings directly from the Amazon Connect admin website.

- Use Amazon S3. Store your prompts on S3 and access them dynamically during calls.
- **Text-to-speech.** Provide plain text or SSML (Speech Synthesis Markup Language) to have it spoken as audio.

For chats, you have the following option:

- **Text prompts only.** Send plain text messages to both customers and agents. Audio options, like pre-recorded prompts, aren't available for chat.

Use cases for this block

This flow block is designed to be used in the following scenarios:

- Play a greeting to customers. For example, "Welcome to our customer service line."
- Provide information that is retrieved from a database back to customers or agents. For example, "Your account balance is \$123.45."
- Play pre-recorded audio while a customer is in queue or on hold.
- Play pre-recorded audio in your own voice from your S3 buckets.

Requirements for prompts

- **Supported formats:** Amazon Connect supports .wav files to use for your prompt. You must use .wav files that are 8KHz, and mono channel audio with U-Law encoding. Otherwise, the prompt won't play correctly. You can use publicly available third-party tools to convert your .wav files to U-Law encoding. After converting the files, upload them to Amazon Connect.
- **Size:** Amazon Connect supports prompts that are less than 50MB and less than five minutes long.
- **When storing prompts in an S3 bucket:** For AWS Regions that are disabled by default (also called [opt-in](#) Regions) such as Africa (Cape Town), your bucket must be in the same Region.

Contact types

Contact type	Supported?
Voice	Yes

Contact type	Supported?
Chat	Yes If a chat contact is routed to this block, but the block is configured for calls, the contact is routed down the Error branch.
Task	Yes If a task contact is routed to this block, the contact is routed down the Success branch, but the prompt is not played.

Flow types

You can use this block in the following [flow types](#):

Flow type	Supported?
Inbound flow	Yes
Customer queue flow	Yes. You can play prompts from the Amazon Connect library but not prompts stored in Amazon S3.
Customer hold flow	No, use Loop prompts flow block instead
Customer whisper flow	Yes. You can play prompts from the Amazon Connect library but not prompts stored in Amazon S3.
Outbound whisper flow	Yes. You can play prompts from the Amazon Connect library but not prompts stored in Amazon S3.
Agent hold flow	No, use Loop prompts flow block instead

Flow type	Supported?
Agent whisper flow	Yes. You can play prompts from the Amazon Connect library but not prompts stored in Amazon S3.
Transfer to agent flow	Yes
Transfer to queue flow	Yes

How to configure this block

You can configure the **Play prompt** block by using the Amazon Connect admin website or by using the [MessageParticipant](#) action in the Amazon Connect Flow language.

Configuration sections

- [Prompts stored in the Amazon Connect prompts library](#)
- [Prompts stored in Amazon S3](#)
- [Text-to-speech or chat text](#)
- [Flow block branches](#)
- [Additional configuration tips](#)
- [Data generated by this block](#)

Prompts stored in the Amazon Connect prompts library

1. In the flow designer, open the configuration pane for the **Play prompt** block.
2. Choose **Select from the prompt library (audio)**.
3. Choose from one of the pre-recorded prompts included with Amazon Connect, or use the Amazon Connect admin website to [record and upload](#) your own prompt. There's no way to upload prompts in bulk.

The following image shows the **Properties** page of the **Play prompt** block configured to play an Audio prompt from the prompt library.

The following code sample shows how this same configuration would be represented by the [MessageParticipant](#) action in the Flow language:

```
{
  "Identifier": "12345678-1234-1234-1234-123456789012",
  "Type": "MessageParticipant",
  "Parameters": {
    "PromptId": "arn:aws:connect:us-west-2:1111111111:instance/aaaaaaa-bbbb-
cccc-dddd-eeeeeeeeeeee/prompt/abcdef-abcd-abcd-abcd-abcdefghijkl"
  },
  "Transitions": {
    "NextAction": "a625f619-81b0-46c3-a855-89151600bdb1",
    "Errors": [
      {
        "NextAction": "a625f619-81b0-46c3-a855-89151600bdb1",
        "ErrorType": "NoMatchingError"
      }
    ]
  }
}
```

Prompts stored in Amazon S3

Store as many prompts as you need in an S3 bucket and then refer to them by specifying the bucket path. For best performance, we recommend creating the S3 bucket in the same AWS Region as your Amazon Connect instance.

To specify an audio file from an S3 bucket

1. In the flow designer, open the configuration pane for the **Play prompt** block.
2. Choose **Specify an audio file from an S3 bucket**.
3. Choose **Set manually**, and then specify the S3 file path that points to audio prompt in S3. For example, `https://u1.s3.amazonaws.com/en.lob1/welcome.wav`.

The following image shows the **Properties** page of the **Play prompt** block configured to set the S3 file path manually.

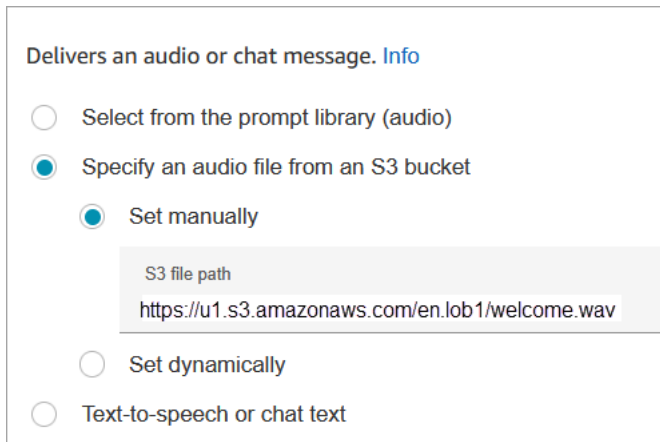

Delivers an audio or chat message. [Info](#)

Select from the prompt library (audio)

Specify an audio file from an S3 bucket

Set manually

S3 file path

`https://u1.s3.amazonaws.com/en.lob1/welcome.wav`

Set dynamically

Text-to-speech or chat text

The following code sample shows how this same configuration would be represented by the [MessageParticipant](#) action in the Flow language:

```
{
  "Identifier": "UniqueIdentifier",
  "Type": "MessageParticipant",
  "Parameters": {
    "Media": {
      "Uri": "https://u1.s3.amazonaws.com/en.lob1/welcome.wav",
      "SourceType": "S3",
      "MediaType": "Audio"
    }
  },
  "Transitions": {
    "NextAction": "Next action identifier on success",
    "Errors": [
      {
        "NextAction": "Next action identifier on failure",
        "ErrorType": "NoMatchingError"
      }
    ]
  }
}
```



```

    ]
  }
}

```

To use attributes to specify an audio file path from an S3 bucket

- You can specify the S3 bucket path using attributes, as shown in the following image:

Delivers an audio or chat message. [Info](#)

Select from the prompt library (audio)
 Specify an audio file from an S3 bucket
 Set manually

S3 file path

`${'Attributes'}['Language']/${'Attributes'}['LOB']/1.wav`

Set dynamically
 Text-to-speech or chat text

—OR—

- You can provide the S3 path with concatenation, as shown in the following example. This enables you to personalize the prompt, for example, by line of business and language. For example: `https://example.s3.amazonaws.com/${'Attributes'}['Language']/${'Attributes'}['LOB']/1.wav`

The following code sample shows how this same configuration would be represented by the [MessageParticipant](#) action in the Flow language:

```

{
  "Identifier": "UniqueIdentifier",
  "Type": "MessageParticipant",
  "Parameters": {
    "Media": {
      "Uri": "https://u1.s3.amazonaws.com/${'Attributes'}['Language']/${'Attributes'}['LOB']/1.wav",
      "SourceType": "S3",
      "MediaType": "Audio"
    }
  }
},

```

```

    "Transitions": {
      "NextAction": "Next action identifier on success",
      "Errors": [
        {
          "NextAction": "Next action identifier on failure",
          "ErrorType": "NoMatchingError"
        }
      ]
    }
  }
}

```

To specify the S3 path dynamically by using user-defined contact attributes

1. The following image shows a user-defined attribute named **S3filepath**.

Delivers an audio or chat message. [Info](#)

Select from the prompt library (audio)
 Specify an audio file from an S3 bucket
 Set manually
 Set dynamically

Namespace
 User defined

Attribute
 S3filepath

Text-to-speech or chat text

The following code sample shows how this same configuration would be represented by the [MessageParticipant](#) action in the Flow language:

```

{
  "Parameters": {
    "Media": {
      "Uri": "$.Attributes.MyFile",
      "SourceType": "S3",
      "MediaType": "Audio"
    }
  },
  "Identifier": "9ab5c4ee-7da8-44b3-b6c9-07f24e1846dc",
  "Type": "MessageParticipant",

```

```

"Transitions": {
  "NextAction": "a625f619-81b0-46c3-a855-89151600bdb1",
  "Errors": [
    {
      "NextAction": "a625f619-81b0-46c3-a855-89151600bdb1",
      "ErrorType": "NoMatchingError"
    }
  ]
}
}

```

The following image shows what this block looks like when the S3 path is set dynamically. It shows the S3 path, and it has two branches: **Success** and **Error**.

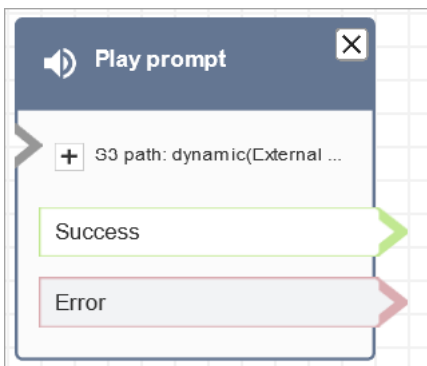

Text-to-speech or chat text

You can enter a prompt in plain text or SSML. These text based prompts are played as audio prompts to customers using Amazon Polly.

For example, the following image shows a **Play prompt** block that is configured to play the message **Thank you for calling** to the customer.

Delivers an audio or chat message. [Info](#)

Select from the prompt library (audio)
 Specify an audio file from an S3 bucket
 Text-to-speech or chat text

Set manually

Enter text to be spoken

<speaK>Thank you for calling.</speaK>

Set dynamically

Interpret as

SSML

The following code sample shows how this same configuration would be represented by the [MessageParticipant](#) action in the Flow language:

```
{
  "Parameters": {
    "Text": "<speaK>Thank you for calling</speaK>"
  },
  "Identifier": "9ab5c4ee-7da8-44b3-b6c9-07f24e1846dc",
  "Type": "MessageParticipant",
  "Transitions": {
    "NextAction": "a625f619-81b0-46c3-a855-89151600bdb1",
    "Errors": [
      {
        "NextAction": "a625f619-81b0-46c3-a855-89151600bdb1",
        "ErrorType": "NoMatchingError"
      }
    ]
  }
}
```

SSML-enhanced input text gives you more control over how Amazon Connect generates speech from the text you provide. You can customize and control aspects of speech such as pronunciation, volume, and speed.

For a list of SSML tags you can use with Amazon Connect, see [SSML tags supported by Amazon Connect](#).

For more information, see [Add text-to-speech to prompts](#).

The following image shows what a **Play prompt** block looks like when it's configured for text-to-speech. It shows the text to be played, and it has two branches: **Success** and **Error**.

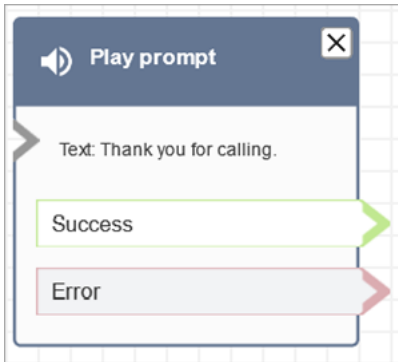

Flow block branches

This block supports the following output branches:

- **Success:** Indicates successfully played the provided audio or text message.
- **Error:** Indicates a failure to play provided audio or text message.
- **Okay:** Some existing flows have a version of the **Play prompt** block that doesn't have an **Error** branch. In this case, the **Okay** branch will always be taken at runtime. If you update the configuration of a **Play prompt** block that doesn't have an **Error** branch, an **Error** branch will be added to the block automatically in the editor.

Additional configuration tips

- For step-by-step instructions about how to set up a dynamic prompt using contact attributes, see [Dynamically select which prompts to play](#).
- When playing prompts from an S3 bucket, for best performance we recommend creating the bucket in the same AWS Region as your Amazon Connect instance.
- When you use text, either for text-to-speech or chat, you can use a maximum of 3,000 billed characters, which is 6,000 characters total. You can also specify text in a flow using a contact attribute.

Data generated by this block

This block does not generate any data.

Error scenarios

A contact is routed down the **Error** branch in the following situations:

- Amazon Connect is unable to download the prompt from S3. This may be due to an incorrect file path, or the S3 bucket policy is not set up correctly and Amazon Connect does not have access. For instructions about how to apply the policy, and a template you can use, see [Set up prompts to play from an S3 bucket](#).
- Incorrect audio file format. Only .wav files are supported.
- The audio file is larger than 50MB or longer than five minutes.
- The SSML is incorrect.
- The text-to-speech length exceeds 6000 characters.
- The the Amazon Resource Name (ARN) for the prompt is incorrect.

Sample flows

All of the sample flows use the **Play prompt** block. Take a look at the [Sample inbound flow \(first contact experience\)](#) to see a **Play prompt** for chat and one for audio.

More resources

See the following topics to learn more about prompts.

- [Create prompts](#)
- [Prompt actions](#) in the Amazon Connect API Reference Guide.

Flow block: Resume contact

Description

- Resumes a task contact from a paused state. This enables agents to free up an active slot so they can receive more critical tasks when their current task is stalled, for example, because of a missing approval or waiting on an external input.

- For more information how pausing and resuming tasks works in Amazon Connect, see [Concepts: Pause and resume tasks](#).

Supported channels

The following table lists how this block routes a contact who is using the specified channel.

Channel	Supported?
Voice	No - Error branch
Chat	No - Error branch
Task	Yes

Flow types

You can use this block on all flow types.

Properties

The following image shows the **Properties** page of the **Resume contact** block.

Block Type ✕

▶▶ Resume Contact

Block Name

Enter a block name

0 / 50

Resumes a contact from a paused state [Learn more](#)

Configuration tips

When you design a flow to resume unassigned, paused tasks that are dequeued, be sure to add a [Transfer to queue](#) block to the flow to queue the task after resuming. Otherwise, the task will stay in a de-queued state.

Configured block

The following image shows an example of what this block looks like when it is configured. It has an **Error event** branch.

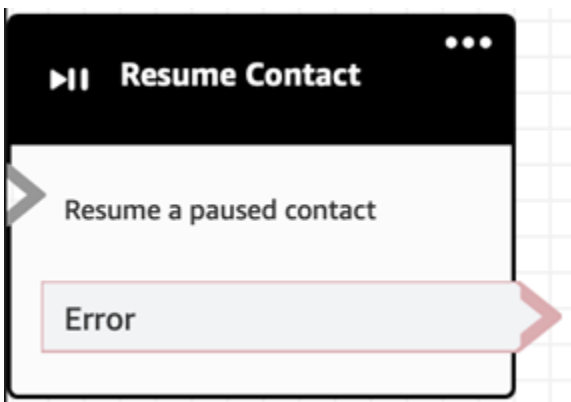

Flow block: Return (from module)

Description

- Use the **Return** block to mark the terminal action or terminal step of a [flow module](#).
- Use this block to exit the flow module after it has run successfully. Then continue running the flow in which the module is referenced.

Supported types of flows

This block is only available in [flow modules](#). It is not available in any other type of flow.

Flow type	Supported?
Inbound Flow (contactFlow)	No
Customer Queue Flow (customerQueue)	No
Customer Hold Flow (customerHold)	No
Customer Whisper Flow (customerWhisper)	No
Outbound Whisper Flow (outboundWhisper)	No
Agent Hold Flow (agentHold)	No
Agent Whisper Flow (agentWhisper)	No
Transfer To Agent Flow (agentTransfer)	No
Transfer To Queue Flow (queueTransfer)	No

Supported types of contacts

The following table lists how this block routes a contact who is using the specified channel.

Contact type	Supported?
Voice	Yes

Contact type	Supported?
Chat	Yes
Task	Yes

Flow block configuration

To use a Return block

1. In the Amazon Connect admin website choose **Routing, Flows**.
2. On the **Flows** page, choose the **Modules** tab, as shown in the following image:

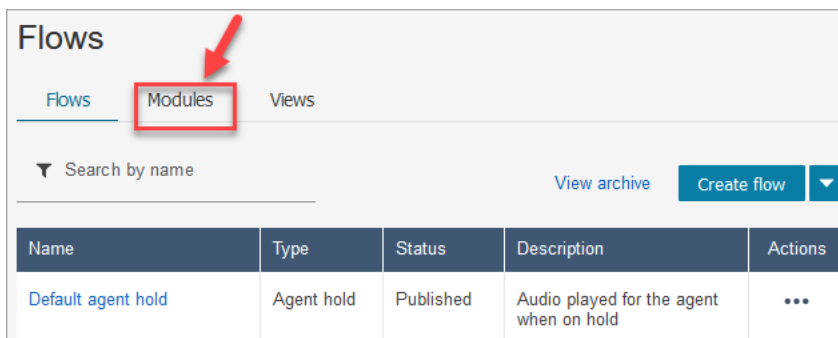

3. Choose **Create flow module** or choose the module you want to edit.
4. Select the **Return** block from the block dock and drag it onto the flow canvas.

Return block in the Amazon Connect admin website (for Tag action)

The following image shows what a **Return** block looks like on the flow editor canvas.

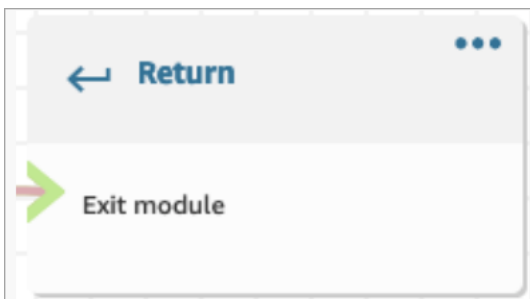

Return block in the Flow language

The **Return** flow block in the flow editor is stored as an `EndFlowModuleExecution` flow action in the Amazon Connect Flow Language.

For more information, see `EndFlowModuleExecution` in the *Amazon Connect API Reference*.

How to configure Return block properties

The following image shows the **Properties** pane of the **Return** block.

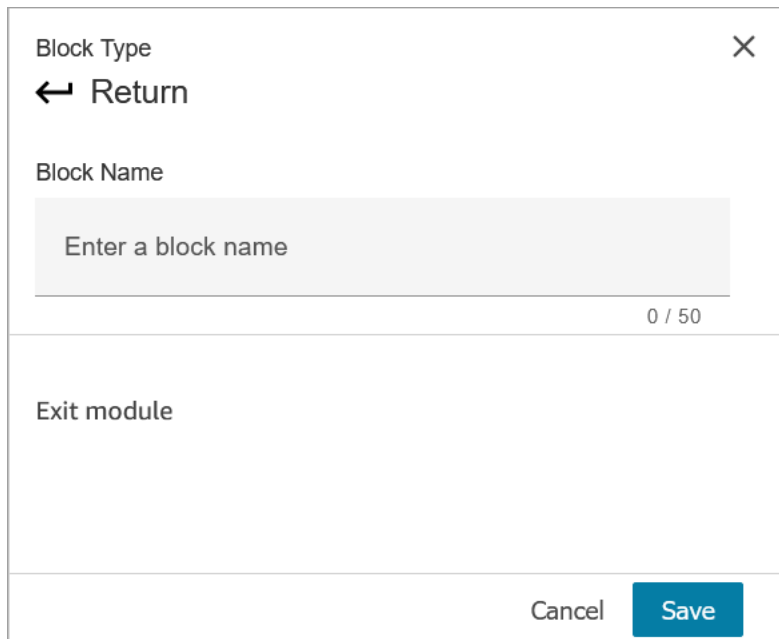

The screenshot shows a configuration window for a 'Return' block. It has a title bar with a close button. The 'Block Type' is set to 'Return'. Below that is a 'Block Name' field with a placeholder 'Enter a block name' and a character count '0 / 50'. There is an 'Exit module' section which is currently empty. At the bottom right, there are 'Cancel' and 'Save' buttons.

1. You don't need to configure this block because it is a terminal block for a flow module.
2. Choose **Save** and publish when you are ready!

The following code shows how this same configuration is represented as an `EndFlowModuleExecution` action in the Amazon Connect Flow Language.

```
{
  "Parameters": {},
  "Identifier": "the identifier of the Return block",
  "Type": "EndFlowModuleExecution",
  "Transitions": {}
},
```

Explanation of flow block outcomes

None. No conditions are supported.

Data generated by the block

No data is generated by this block.

How to use this data in different parts of a flow

No data is generated by this block that can be used in the flow.

Fragmented action representation, if any

This block does not support fragmented action.

Known error scenarios

Because this is a terminal block there are no error scenarios that the flow may encounter when this block is run.

What this block looks like in a flow log

```
{
  "ContactId": "string",
  "ContactFlowId": "string",
  "ContactFlowName": "string",
  "ContactFlowModuleType": "Return",
  "Identifier": "string",
  "Timestamp": "2024-01-19T20:23:24.633Z",
  "Parameters": {}
}
```

Flow block: Set callback number

Description

- Specify the attribute to set the callback number.

Supported channels

The following table lists how this block routes a contact who is using the specified channel.

Channel	Supported?
Voice	Yes
Chat	No - Invalid number branch

Channel	Supported?
Task	No - Invalid number branch

Flow types

You can use this block in the following [flow types](#):

- Inbound flow
- Customer Queue flow
- Transfer to Agent flow
- Transfer to Queue flow

Properties

The following image shows the **Properties** page of the **Set callback number** block.

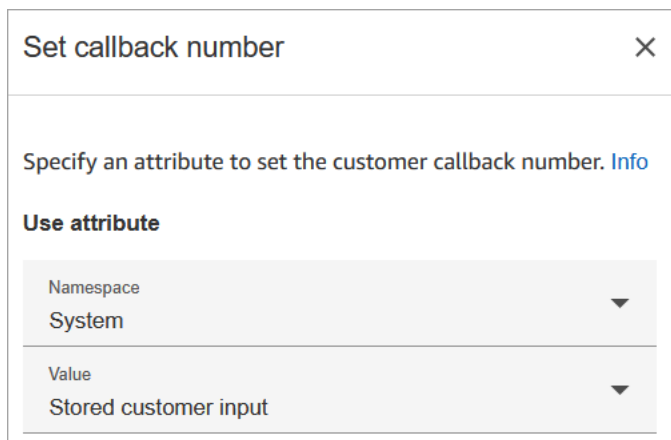

The screenshot shows the configuration interface for the 'Set callback number' block. At the top, the title 'Set callback number' is displayed with a close button (X). Below the title, there is a descriptive text: 'Specify an attribute to set the customer callback number. Info'. Underneath, there is a section titled 'Use attribute' which contains two dropdown menus. The first dropdown is labeled 'Namespace' and has 'System' selected. The second dropdown is labeled 'Value' and has 'Stored customer input' selected.

Configuration tips

- The [Store customer input](#) block often comes before this block. It stores the customer's callback number.

Configured block

The following image shows an example of what this block looks like when it is configured. It has the following branches: **Success**, **Invalid number**, and **Not dialable**.

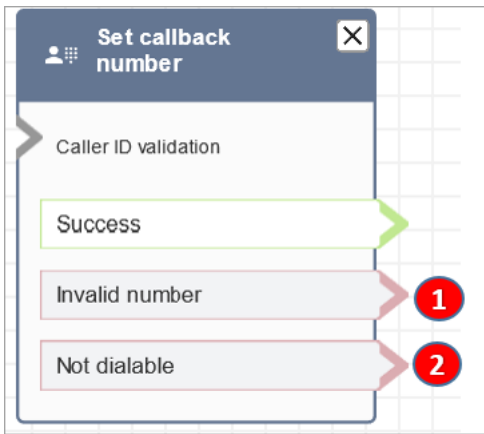

1. **Invalid number:** The customer entered phone number that is not valid.
2. **Not dialable:** Amazon Connect is unable to dial that number. For example, if your instance is not allowed to make calls to +447 prefix phone numbers, and the customer requested callback to a +447 prefix number. Even though number is valid, Amazon Connect cannot call it.

Sample flows

Amazon Connect includes a set of sample flows. For instructions that explain how to access the sample flows in the flow designer, see [Sample flows](#). Following are topics that describe the sample flows which include this block.

- [Sample queue configurations](#)
- [Sample queued callback](#): this sample only applies to previous instances of Amazon Connect.

Scenarios

See these topics for scenarios that use this block:

- [Set up queued callback by creating flows, queues, and routing profiles](#)
- [About queued callbacks in metrics](#)

Flow block: Set contact attributes

Description

Stores key-value pairs as contact attributes. You set a value that is later referenced in a flow.

For example, create a personalized greeting for customers routed to a queue based on the type of customer account. You could also define an attribute for a company name or line of business to include in the text to speech strings said to a customer.

The **Set contact attributes** block is useful, for example, for copying attributes retrieved from external sources to user-defined attributes.

For more information about contact attributes, see [Use Amazon Connect contact attributes](#).

Supported channels

The following table lists how this block routes a contact who is using the specified channel.

Channel	Supported?
Voice	Yes
Chat	Yes
Task	Yes

Flow types

You can use this block in the following [flow types](#):

- All flows

Properties

The following image shows the **Properties** page of the **Set contact attributes** block. It is configured to set a user-defined attribute on the **Current contact** with the key **greetingPlayed** and the value **true**.

Block Type

Set contact attributes

Block Name

Enter a block name

0 / 50

Define and store key-value pairs as contact attributes. [Info](#)

Contact attributes are accessible by other areas of Amazon Connect, such as the Contact Control Panel (CCP) and Contact Trace Records (CTRs). To restrict access to these areas, use flow attributes.

Set attributes on

Current contact

Current contact is the contact that this flow is running on. Related contact is the contact that has been optionally associated with the current contact allowing attribute sharing. Flow is the current flow.

Namespace

User defined

Key

greetingPlayed

Set manually

Value

true

Set dynamically

Add another attribute

Cancel Save

You can choose to set attributes on:

- **Current contact:** The attributes are set on the contact that this flow is running on. The attributes are accessible by other areas of Amazon Connect, such as other flows, modules, Lambdas, contact records, and the GetMetricDataV2 API.
- **Related contact:** The attributes are associated with a new contact that contains a copy of the original contact properties.

In the contact record, this is the **RelatedContactId**.

- **Flow:** The attributes are restricted to the flow in which they are configured.

Flow attributes are useful in situations where you don't want to persist the data throughout the contact, such as when you need to use sensitive information like the customer's credit card number to do a Lambda data dip.

- Flow attributes are temporary variables stored locally and only used in the flow. They aren't visible anywhere outside the flow, not even when the contact is transferred to another flow.
- They can be up to 32 KB (the maximum size of the contact record attributes section).
- They aren't passed to a Lambda unless they are explicitly configured as parameters: in the **Invoke AWS Lambda function** block, choose **Add a parameter**.

- They aren't passed to modules. You can set a flow attribute within a module, but it won't be passed out of the module.
- They don't appear in the contact record.
- They don't appear to the agent in the CCP.
- The `GetContactAttributes` API can't expose them.
- If you have logging enabled on the flow, the key and value appear in the Cloudwatch log.

How to reference attributes

- For the JSON syntax for each attribute, see [List of available contact attributes and their JSONPath reference](#).
- To reference attributes that contain special characters in their name, such as spaces, place brackets and single quotations around the attribute name. For example: `$.Attributes['user attribute name']`.
- To reference attributes in the same namespace, such as a system attribute, you use the attribute name, or the name you specified as the **Destination key**.
- To reference values in a different namespace, such as referencing an external attribute, you specify the JSONPath syntax to the attribute.
- To use contact attributes to access other resources, set a user-defined attribute in your flow and use the Amazon Resource Name (ARN) of the resource you want to access as the value for the attribute.

Lambda examples

- To reference a customer name from a Lambda function lookup, use `$.External.AttributeKey`, replacing `AttributeKey` with the key (or name) of the attribute returned from the Lambda function.
- To use an Amazon Connect prompt in a Lambda function, set a user-defined attribute to the ARN for the prompt, and then access that attribute from the Lambda function.

Amazon Lex examples

- To reference an attribute from an Amazon Lex bot, you use the format `$.Lex`. and then include the part of the Amazon Lex bot to reference, such as `$.Lex.IntentName`.

- To reference the customer input to an Amazon Lex bot slot, use `$.Lex.Slots.slotName`, replacing `slotName` with the name of the slot in the bot.

What happens when attributes exceed 32 KB

Attributes can be up to 32 KB, which is the maximum size of the contact record attributes section. When the attributes for a contact exceed 32 KB, the contact is routed down the **Error** branch. As a mitigation, consider the following options:

- Remove unnecessary attributes by setting their values to empty.
- If the attributes are only used in one flow and don't need to be referred to outside of that flow (for example, by a Lambda or another flow), then use flow attributes. This way you aren't needlessly persisting the 32 KB of information from one flow to another.

Configuration tips

- When using a user-defined destination key, you can name it anything you want but don't include the `$` and `.` (period) characters. They are not allowed because they are both used in defining the attribute paths in JSONPath.
- You can use the **Set contact attribute** block to set the language attribute required for an Amazon Lex V2 bot. (Your language attribute in Amazon Connect must match the language model used to build your Amazon Lex V2 bot.) The following image shows a language attribute set to Spanish.

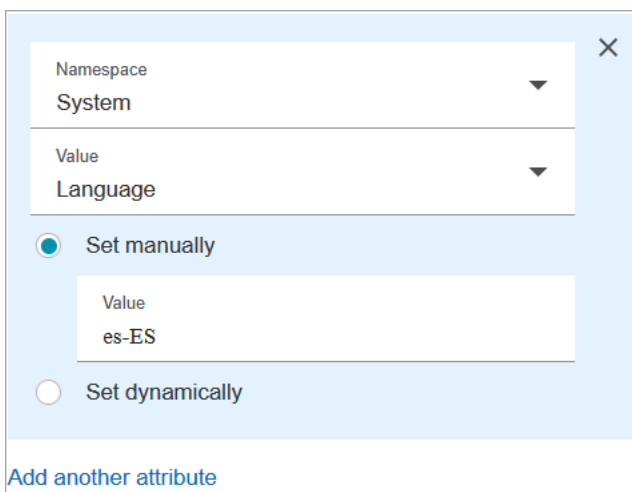

The image shows a configuration window for setting a contact attribute. It has a title bar with a close button (X). Inside, there are two dropdown menus: 'Namespace' with 'System' selected, and 'Value' with 'Language' selected. Below these are two radio buttons: 'Set manually' (which is selected) and 'Set dynamically'. Under 'Set manually', there is a text input field containing 'es-ES'. At the bottom left, there is a blue link that says 'Add another attribute'.

Or, you can use the [Set voice](#) block to set the language required for an Amazon Lex V2 bot.

For more information about how to use contact attributes, see [Use Amazon Connect contact attributes](#).

Configured block

The following image shows an example of what this block looks like when it is configured. It has two branches: **Success** and **Error**.



Sample flows

Amazon Connect includes a set of sample flows. For instructions that explain how to access the sample flows in the flow designer, see [Sample flows](#). Following are topics that describe the sample flows which include this block.

- [Sample inbound flow \(first contact experience\)](#)

Scenarios

See these topics for scenarios that use this block:

- [How to reference contact attributes](#)

Flow block: Set customer queue flow

Description

- Specifies the flow to invoke when a customer is transferred to a queue.

Supported channels

The following table lists how this block routes a contact who is using the specified channel.

Channel	Supported?
Voice	Yes
Chat	Yes
Task	Yes

Flow types

You can use this block in the following [flow types](#):

- Inbound flow
- Transfer to Agent flow
- Transfer to Queue flow

Properties

The following image shows the **Properties** page of the **Set customer queue flow** block.

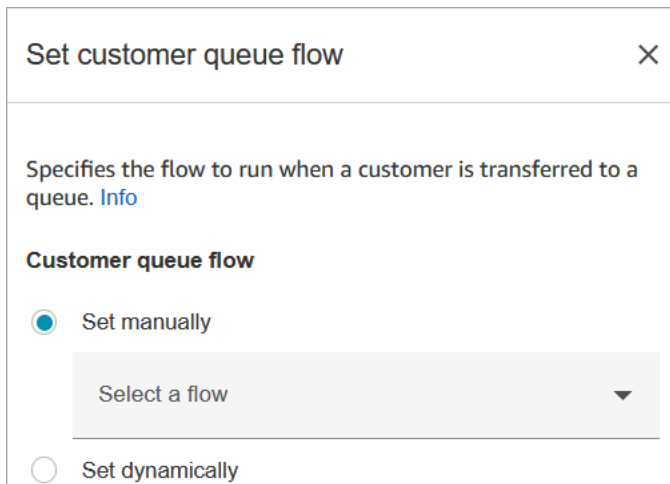

The screenshot shows a dialog box titled "Set customer queue flow" with a close button (X) in the top right corner. Below the title, there is a description: "Specifies the flow to run when a customer is transferred to a queue. [Info](#)". Underneath, the section "Customer queue flow" contains two radio buttons: "Set manually" (which is selected) and "Set dynamically". Below the "Set manually" radio button is a dropdown menu with the text "Select a flow" and a downward arrow.

For information about using attributes, see [Use Amazon Connect contact attributes](#).

Configured block

The following image shows an example of what this block looks like when it is configured. It has the following branches: **Success** and **Error**.

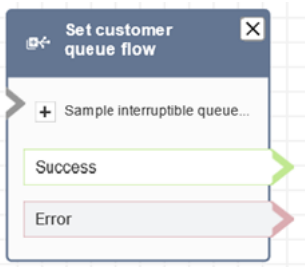

Sample flows

Amazon Connect includes a set of sample flows. For instructions that explain how to access the sample flows in the flow designer, see [Sample flows](#). Following are topics that describe the sample flows which include this block.

- [Sample queued callback](#)

Flow block: Set disconnect flow

Description

- Specifies which flow to run after a disconnect event during a contact.

A disconnect event is when:

- A chat, or task is disconnected.
- A task is disconnected as a result of a flow action.
- A task expires. The task is automatically disconnected if it is not completed in 7 days.

When the disconnect event occurs, the corresponding flow runs.

- Here are examples of when you might use this block:
 - Run post-contact surveys. For example, the agent asks the customer to remain on the line for a post-call survey. The agent hangs up and a disconnect flow is run. In the disconnect flow, the customer is asked a set of questions using the [Get customer input](#) block. Their answers are uploaded using an [Invoke AWS Lambda function](#) block to an external customer feedback database. The customer is thanked and disconnected.

For more information about creating post-contact surveys, see this blog: [Easily create and visualize post chat surveys with Amazon Connect and Amazon Lex](#). And check out this workshop: [Building a contact survey solution for Amazon Connect](#).

- In a chat scenario, if a customer stops responding to the chat, use this block to decide whether to run the disconnect flow and call a [Wait](#) block, or end the conversation.
- In task scenarios where a task may not be completed in 7 days, use this block to run a disconnect flow to determine whether the task should be re-queued, or completed/[disconnected](#) by a flow action.

Supported channels

The following table lists how this block routes a contact who is using the specified channel.

Channel	Supported?
Voice	Yes
Chat	Yes
Task	Yes

Flow types

You can use this block in the following [flow types](#):

- All flows

Properties

The following image shows the **Properties** page of the **Set disconnect flow** block.

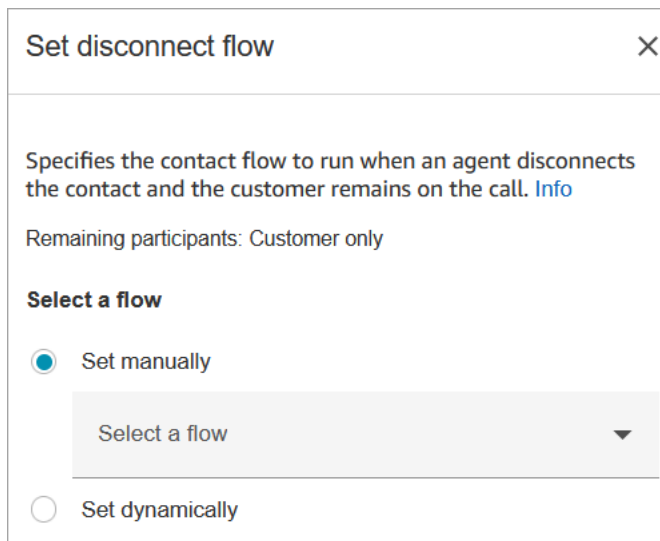

The screenshot shows a dialog box titled "Set disconnect flow" with a close button (X) in the top right corner. Below the title, there is a descriptive text: "Specifies the contact flow to run when an agent disconnects the contact and the customer remains on the call." followed by a blue "Info" link. Below this, it says "Remaining participants: Customer only". Under the heading "Select a flow", there are two radio buttons: "Set manually" (which is selected) and "Set dynamically". Below the "Set manually" option is a dropdown menu with the text "Select a flow" and a downward arrow.

Configured block

The following image shows an example of what this block looks like when it is configured. It has the following branches: **Success** and **Error**.

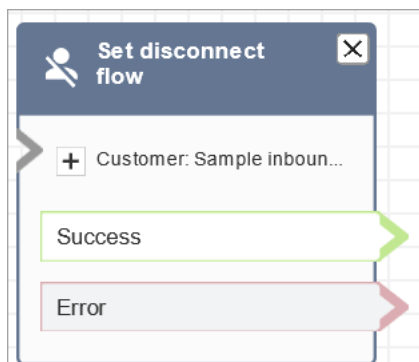

Sample flows

Amazon Connect includes a set of sample flows. For instructions that explain how to access the sample flows in the flow designer, see [Sample flows](#). Following are topics that describe the sample flows which include this block.

- [Sample inbound flow \(first contact experience\)](#)

Scenarios

See these topics for scenarios that use this block:

- [Example chat scenario](#)

- [Easily create and visualize post chat surveys with Amazon Connect and Amazon Lex](#)
- [Building a contact survey solution for Amazon Connect](#)

Flow block: Set event flow

Description

- Specifies which flow to run during a contact event.
- The following events are supported:
 - **Default flow for agent UI:** specifies the flow to be invoked when a contact comes into the Agent Workspace. You can use this event to set up a [step-by-step](#) guide to be played to the agent in this scenario.
 - **Disconnect flow for agent UI:** specifies the flow to be invoked when a contact that is open in the Agent Workspace ends. You can use this event to set up a [step-by-step](#) guide to be played to the agent in this scenario.
 - **Flow at contact pause:** Specifies the flow to be invoked when a contact comes to paused state. For more information, see [Concepts: Pause and resume tasks](#).
 - **Flow at contact resume:** Specifies the flow to be invoked when a contact comes to resume from paused state. For more information, see [Concepts: Pause and resume tasks](#).

Supported channels

The following table lists how this block routes a contact who is using the specified channel.

Channel	Supported?
Voice	Yes
Chat	Yes
Task	Yes

Flow types

You can use this block in the following [flow types](#):

- All flows

Properties

The following image shows the **Properties** page of the **Set event flow** block.

Set event flow



Specify a flow to run when a contact event or interaction occurs, such as an agent accepting or disconnecting from a call or placing a customer on hold [Info](#)

Select event

Select an event hook

Default flow for Agent UI

Select a flow

Set manually

 Select a flow

This field cannot be empty.

Set dynamically

Configured block

The following image shows an example of what this block looks like when it is configured. It has the following branches: **Success** and **Error**.

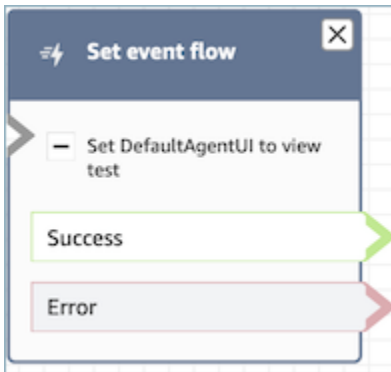

Scenarios

See these topics for scenarios that use this block:

- [How to invoke a guide at the start of a contact](#)

Flow block: Set hold flow

Description

- Links from one flow type to another.
- Specifies the flow to invoke when a customer or agent is put on hold.

If this block is triggered during a chat conversation, the contact is routed down the **Error** branch.

Supported channels

The following table lists how this block routes a contact who is using the specified channel.

Channel	Supported?
Voice	Yes
Chat	No - Error branch

Channel	Supported?
Task	No - Error branch

Flow types

You can use this block in the following [flow types](#):

- Inbound flow
- Customer Queue flow
- Outbound whisper flow
- Transfer to Agent flow
- Transfer to Queue flow

Properties

The following image shows the **Properties** page of the **Set hold flow** block. It shows the dropdown list of namespaces that you can use to set the hold flow dynamically.

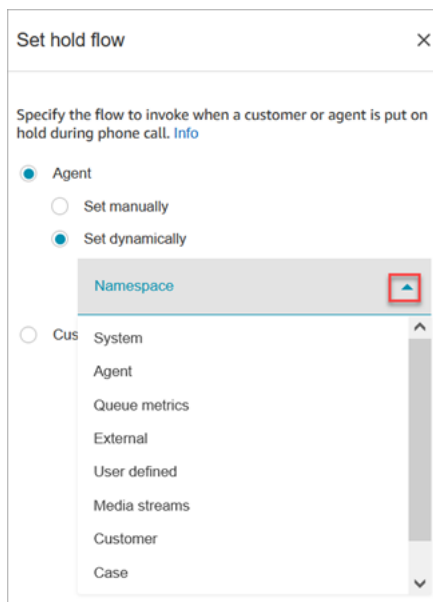

For information about using attributes, see [Use Amazon Connect contact attributes](#).

Configured block

The following image shows an example of what this block looks like when it is configured. It has the following branches: **Success** and **Error**.



Flow block: Set logging behavior

Description

- Enables flow logs so you can track events as contacts interact with flows.
- Flow logs are stored in Amazon CloudWatch. For more information, see [Flow logs stored in an Amazon CloudWatch log group](#).

Supported channels

The following table lists how this block routes a contact who is using the specified channel.

Channel	Supported?
Voice	Yes
Chat	Yes
Task	Yes

Flow types

You can use this block in the following [flow types](#):

- All flows

Properties

The following image shows the **Properties** page of the **Set logging behavior** block. It has two options: enable logging behavior, or disable it.

Scenarios

See these topics for more information about flow logs:

- [Track events as customers interact with flows](#)

Flow block: Set recording and analytics behavior

Description

- Sets options for recording and/or monitoring (listen-in) voice and chat conversations.
- It enables features in Contact Lens. For more information, see [Analyze conversations using conversational analytics](#).

Supported channels

The following table lists how this block routes a contact who is using the specified channel.

Channel	Supported?
Voice	Yes
Chat	Yes

Channel	Supported?
Task	No - Error branch

Flow types

You can use this block in the following [flow types](#):

- Inbound flow
- Customer Queue flow
- Outbound whisper flow
- Transfer to Agent flow
- Transfer to Queue flow

Tip

We recommend using the **Set recording behavior** block in an inbound or outbound whisper flow for the most accurate behavior.

Using this block in a queue flow does not always guarantee that calls are recorded. This is because the block might run after the contact is joined to the agent.

Properties

The following image shows the **Properties** page of the **Set recording and analytics behavior** block. It has two sections:

- **Call recording:** use this section to enable or disable call recording fro the agent customer, or both.
- **Analytics:** use this section to enable Contact Lens analytics.

The screenshot shows a configuration window titled "Set recording and analytics behavior" with a close button (X) in the top right corner. The window contains the following sections:

- Specify recording behavior and configure Contact Lens conversational analytics** (with an "Info" link).
- Call recording**: "Enables or disables call recording for the agent, customer, or both." It has three radio button options: "On" (selected), "Agent only", and "Customer only". Below these is an "Off" radio button.
- Analytics**: Contains three checked checkboxes:
 - Enable Contact Lens conversational analytics**: "Contact Lens conversational analytics provides ML-based speech and chat analytics such as transcripts, sentiment, contact categorization, sensitive data redaction, and contact summarization. These analytics help identify customer issues and improve agent performance. Info"
 - Enable speech analytics**: "ML-based speech analytics for post-call and real-time. You need agent and customer call recordings to enable speech analytics." It has two radio button options: "Post-call analytics" (selected, with a note "Recommended for best transcription accuracy.") and "Real-time and post-call analytics" (with a note "Enables real-time alerts and speech analytics on live calls.").
 - Enable chat analytics**: "ML-based chat analytics for post-chat. You need chat transcripts enabled on the Amazon Connect AWS management console to leverage chat analytics"

When configuring this block to [set up recording behavior](#), choose as follows:

- To record voice conversations, choose what you want to record: **Agent and Customer**, **Agent only**, or **Customer only**.
- To record chat conversations, you need to choose **Agent and Customer**.
- To enable monitoring of voice and/or chat conversations, you need to choose **Agent and Customer**.

For information about using this block to enable Contact Lens, including features such as sensitive data redaction, see [Enable Amazon Connect Contact Lens](#).

Configuration tips

- You can change call recording behavior in a flow, for example, change from "Agent and customer" to "Agent only." Perform the following steps:
 1. Add a second **Set recording and analytics behavior** block to the flow.
 2. Configure the second block to set call recording to **Off**.
 3. Add another **Set recording and analytics behavior** block.

4. Configure the third block to the new recording behavior you want, such as **Agent only**.

Note

The settings in the **Analytics** section are overwritten by each subsequent **Set recording and analytics behavior** block in the flow.

- **For calls:** Clearing **Enable Contact Lens conversational analytics** disables Contact Lens analytics.

For example, let's say you have two **Set recording and analytics behavior** blocks in your flow. The first block has **Enable Contact Lens conversational analytics** selected. The second block later in the flow has it unselected. The analytics appear only during the time analytics was enabled.

- **For chat:** Real-time chat starts analysis as soon as any block in the flow enables it. No block later in the flow disables the real time chat settings.
- If an agent puts a customer on hold, the agent is still recorded, but the customer is not.
- If you want to transfer a contact to another agent or queue, and you want to continue using Contact Lens to collect data, you need to add to the flow another **Set recording behavior** block with **Enable analytics** turn on. This is because a transfer generates a second contact ID and contact record. Contact Lens needs to run on that contact record as well.
- When you enable Contact Lens, the type of flow that the block is in, and where it is placed in the flow, determine **whether** agents receive the key highlights transcript, and **when** they receive it.

For more information and example use cases that explain how the block affects the agents experience with key highlights, see [Design a flow for key highlights](#).

Configured block

The following image shows an example of what this block looks like when it is configured. It has one branch: **Success**.

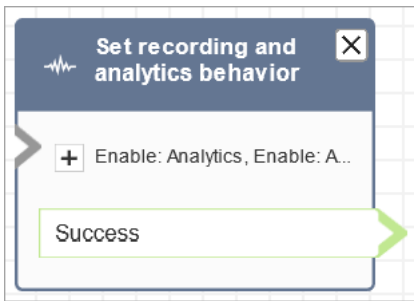

Sample flows

Amazon Connect includes a set of sample flows. For instructions that explain how to access the sample flows in the flow designer, see [Sample flows](#). Following are topics that describe the sample flows which include this block.

- [Sample inbound flow \(first contact experience\)](#)

Scenarios

See these topics for scenarios that use this block:

- [Set up recording behavior](#)
- [Set up live monitoring for voice and/or chat](#)
- [Review recorded conversations between agents and customers using Amazon Connect](#)
- [Analyze conversations using conversational analytics](#)

Flow block: Set routing criteria

- Sets routing criteria on a contact.
- Routing criteria can be set on contacts of any channel, such as Voice, Chat, and Task, to define how the contact should be routed within its queue. A routing criteria is a sequence of one or more routing steps.
- A routing step is a combination of one or more requirements that must be met in order for this contact to be routed to an agent. You can set an optional expiration duration for each routing

step. For example, you could create a routing step with a requirement to only offer this contact to a specific agent based on user ID, for a certain expiration duration. As another example, you could create a non-expiring routing step with the requirements: **Language:English >= 4 AND Technology:AWS Kinesis >= 2**.

- A requirement is a condition created using a predefined attribute name, its value, comparison operator and proficiency level. For example, **Technology:AWS Kinesis >= 2**.
- The following flow types support this block:
 - Inbound flow
 - Customer queue flow
 - Transfer to Agent flow
 - Transfer to Queue flow
- The Set Routing Criteria block needs to be used with the Transfer To Queue block, as the latter will transfer the contact to the Amazon Connect queue and activate the routing criteria specified on the contact.
- Routing criteria set on the contact will not take effect if the contact is transferred into an agent queue. For more information, see [Routing using agent proficiencies](#).

Prerequisites for Setting Routing Criteria using Predefined Attributes

To set the routing criteria on a contact, you must first complete the following:

1. Create [Predefined attributes](#).
2. [Assign proficiencies to agents](#) using predefined attributes that were previously created

How routing criteria works

When a contact is transferred to a standard queue, Amazon Connect will activate the first step specified in the routing criteria of the contact. An agent is joined to the contact only when it meets the requirements specified in the active routing step of the contact. If no such agent is found till the expiration duration of the step, then Amazon Connect will move to the next step specified in the routing criteria until one of them is satisfied. When all steps have expired, the contact will be offered to the longest available agent who has the queue in their routing profile. Note that a routing step will never expire in case expiration duration is not specified on the routing step.

You can use the following items in a routing criteria:

- Choose from the following:
 - One or more preferred agents, based on user ID or username.
 - A single attribute.
 - Two – eight attributes using the AND condition.
 - Two attributes using the OR condition. You can only use OR when setting attributes dynamically. For more information, see [Using the flow block](#).

In addition, attributes and routing criteria must have the following;

- Each attribute must have an associated proficiency level.
- Each proficiency level must use the ">=" comparison operator.
- Each step of the criteria must have a timed expiration timer.
- The last step of the criteria can have a timed or non-expiring expiration timer.

Using the flow block

You can set the desired routing criteria either manually in the contact flow block UI or dynamically based on the output from the Invoke AWS Lambda Function block.

Block Type

 Set routing criteria

Block Name

0 / 50

Target a contact within a queue to agents matching a specific location, expertise, or other requirement. [Learn more](#)

**How it works**

Set up to 5 steps of routing criteria. When it fails to meet the requirements in an earlier step, the routing criteria will move on to the next step sequentially until one of them is satisfied. When all criteria are exhausted, contact will be offered to any agent in queue.

- Set manually
- Set dynamically

Set routing criteria manually

Using this option, you can set routing criteria on contacts as specified in the **Set Routing Criteria** block manually. See the example of a flow below to where the predefined attribute is added to a routing step manually by picking the attribute and value from a dropdown list.

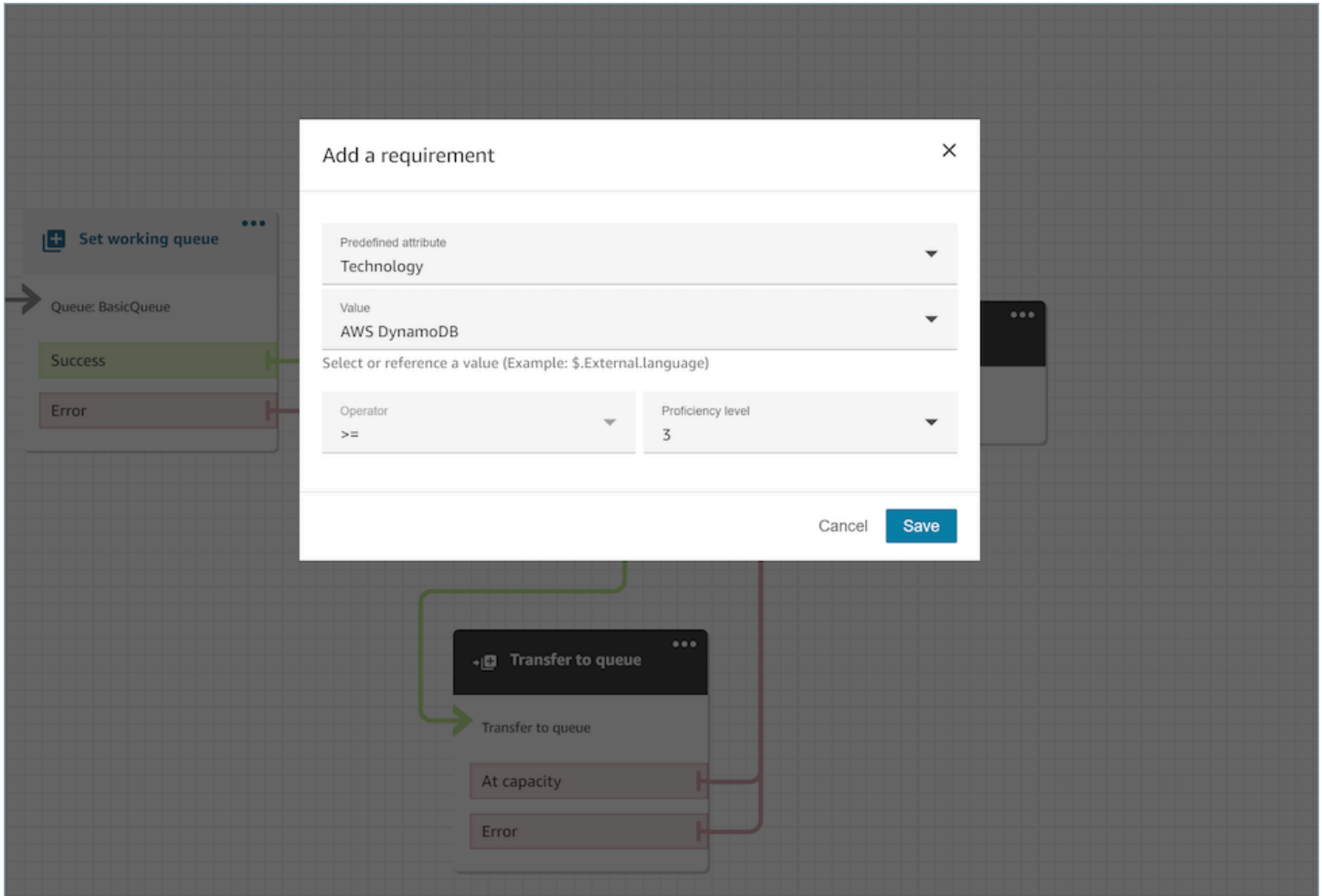

As needed, you can configure predefined attribute value dynamically using JSONPath reference even in this option. For example, you can specify `$.External.Language` JSONPath reference instead of hard coding a `AWS DynamoDB` value on the `Technology` requirement of all of the contacts. For more information on JSONPath reference, see [List of available contact attributes and their JSONPath reference](#).

Set routing criteria dynamically

You can set routing criteria on a contact dynamically based on the output from the **Invoke AWS Lambda function** block.

- In the **Invoke AWS Lambda function** block, configure the Lambda function to return the routing criteria in JSON format and set the response validation as JSON. For more information on using the **Invoke AWS Lambda function**, see the [Invoke AWS Lambda functions](#) documentation.
- In the **Set Routing Criteria** block, choose **Set dynamically** option with the above Lambda attributes - **Namespace** as `External` and **Key** as specified in above Lambda response. For example, the key would be `MyRoutingCriteria` as it points to the routing criteria in the sample Lambda response in the following section.

Sample Lambda function for setting routing criteria

The following Lambda example uses `AndExpression` to return routing criteria:

```
export const handler = async(event) => {
  return {
    "MyRoutingCriteria": {
      "Steps": [
        {
          "Expression": {
            "AndExpression": [
              {
                "AttributeCondition": {
                  "Name": "Language",
                  "Value": "English",
                  "ProficiencyLevel": 4,
                  "ComparisonOperator": "NumberGreaterOrEqualTo"
                }
              },
              {
                "AttributeCondition": {
                  "Name": "Technology",
                  "Value": "AWS Kinesis",
                  "ProficiencyLevel": 2,
                  "ComparisonOperator": "NumberGreaterOrEqualTo"
                }
              }
            ]
          }
        }
      ],
      "Expiry": {
        "DurationInSeconds": 30
      }
    }
  },
}
```

```

    {
      "Expression": {
        "AttributeCondition": {
          "Name": "Language",
          "Value": "English",
          "ProficiencyLevel": 1,
          "ComparisonOperator": "NumberGreaterOrEqualTo"
        }
      }
    }
  ]
}
};

```

The following Lambda example uses `OrExpression` to return routing criteria:

```

export const handler = async(event) => {
  return {
    "MyRoutingCriteria": {
      "Steps": [
        {
          "Expression": {
            "OrExpression": [
              {
                "AttributeCondition": {
                  "Name": "Technology",
                  "Value": "AWS Kinesis Firehose",
                  "ProficiencyLevel": 2,
                  "ComparisonOperator": "NumberGreaterOrEqualTo"
                }
              },
              {
                "AttributeCondition": {
                  "Name": "Technology",
                  "Value": "AWS Kinesis",
                  "ProficiencyLevel": 2,
                  "ComparisonOperator": "NumberGreaterOrEqualTo"
                }
              }
            ]
          }
        }
      ],
      "Expiry": {

```



```
        "DurationInSeconds": 30
    }
}
]
}
}
};
```

What are the statuses of a routing step and why are they needed?

1. **Inactive:** When the routing criteria is activated the first step immediately becomes Inactive. The routing engine executes the criteria one step at a time as per the expiration timer.
 - a. Every step starts as Inactive Until the previous step expires.
2. **Active:** When a step is actively being executed for a match the status is set to Active
3. **Expired:** When Amazon Connect does not find an agent during the duration of a step and the timer expires, the routing engine moves on to the next step. The previous step is considered Expired.
4. **Joined:** Whenever an agent is successfully matched with a contact for a particular step, the step status will be set as Joined
5. **Interrupted:** If a contact has been waiting for too long or an operations leader may decide to interrupt the flow and change the routing criteria. This can be done while a particular step is active, for example, a task has been waiting for 24 hours and a manager wants to change the criteria. The step status will then be set to Interrupted.
6. **Deactivated:** When a customer drops a call or a connection is dropped, routing will stop.

Use routing criteria to target a specific preferred agent

You can also use routing criteria to restrict a contact in a queue to a specific preferred agent or set of preferred agents, based on user ID instead of predefined attributes. For example, if you have identified that a specific customer recently contacted your contact center about the same topic, you might want to try and route that customer to the same agent who handled their issue last time. To do so, you can set a routing step to target that specific agent for a certain amount of time before the routing step expires. For example, you could call a custom Lambda function to fetch the desired user ID, and then use that data to configure the preferred agent by using the Set manually option in the Set routing criteria Flow block UI to specify that this contact should be routed to ``$.External.last_agent_id`` (a JSONPath reference) instead of hard coding a specific user

ID. For more information on JSONPath reference, see [List of available contact attributes and their JSONPath reference](#).

FAQ

If the preferred agent is not available, what happens?

If you have a routing step set targeting a specific preferred agent, the contact will be restricted to that agent until such time that the routing step expires. This is regardless of the following:

1. Agent is online or not.
2. Agent is online but busy with other contacts and cannot be routed an additional contact right now
3. Agent is online but in a custom nonproductive status
4. Agent was deleted from instance (their userID is still considered valid)

For example, imagine you have restricted a particular contact to target agent Jane Doe with expiry of 30 seconds, but Jane Doe is currently offline. The contact will nonetheless be restricted to Jane Doe for 30 seconds, after which the routing step will expire and contact can be offered to another available agent in queue.

What is the maximum number of agents can I target within a single preferred agent step?

You can target up to 10 agents.

Can I create a routing criteria that includes both routing steps based on preferred agent, and routing steps based on predefined attributes?

Yes. For example, you could create a two-step routing criteria, where step 1 targets the contact to a specific preferred agent by user ID based on the agent predicted as the best-fit agent by your custom matching learning model with a given expiry, and then step 2 targets the contact based on predefined attributes such requiring a minimum proficiency level in Spanish.

Scenarios

See these topics for scenarios that use this block:

- [How to reference contact attributes](#)

Flow block: Set Voice ID

Description

- Enables audio streaming and sets thresholds for voice authentication and detection of fraudsters in a watchlist. For more information about this feature, see [Voice ID](#).
- Sends audio to Amazon Connect Voice ID to verify the caller's identity and match against fraudsters in watch list, as soon as the call is connected to a flow.
- Use a [Play prompt](#) block before **Set Voice ID** to stream audio properly. You can edit it to include a simple message such as "Welcome."
- Use a [Set contact attributes](#) block after **Set Voice ID** to set the customer ID for the caller.

The `CustomerId` may be a customer number from your CRM, for example. You can create a Lambda function to pull the unique customer ID of the caller from your CRM system. Voice ID uses this attribute as the `CustomerSpeakerId` for the caller.

`CustomerId` can be an alphanumeric value. It supports only `_` and `-` (underscore and hyphen) special characters. It does not need to be UUID. For more information, see `CustomerSpeakerId` in the [Speaker](#) data type.

- Use a [Check Voice ID](#) block after **Set Voice ID** to branch based on the results of the enrollment check, authentication, or fraud detection.
- For information about how to use **Set Voice ID** in a flow, along with [Check Voice ID](#) and [Set contact attributes](#), see [Step 2: Create a new Voice ID domain and encryption key](#) in [Enable Voice ID](#).

Supported channels

The following table lists how this block routes a contact who is using the specified channel.

Channel	Supported?
Voice	Yes
Chat	No - Error branch
Task	No - Error branch

Flow types

You can use this block in the following [flow types](#):

- Inbound flow
- Customer queue flow
- Customer whisper flow
- Outbound whisper flow
- Agent whisper flow
- Transfer to Agent flow
- Transfer to Queue flow

Properties

The following image shows the **Properties** page of the **Set Voice ID** block. It shows the **Voice authentication** section. In this example, the **Authentication Threshold** is set to 90. This is the recommended threshold.

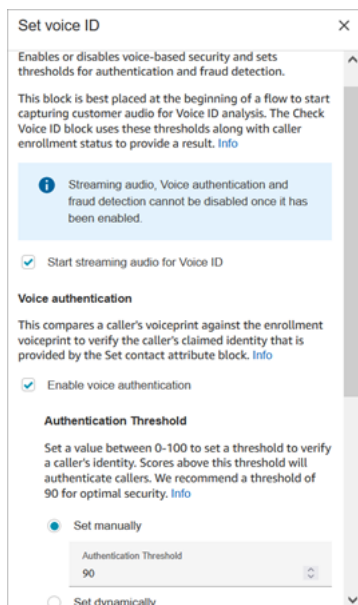

Start streaming audio for Voice ID

When this option is selected, Amazon Connect begins streaming audio from the customer's channel to Voice ID.

You can add this block several places in a flow, but after **Start streaming audio** is selected, it cannot be disabled, even if later in the flow there are other **Set Voice ID** blocks that do not have it enabled.

Voice authentication

Authentication threshold: When Voice ID compares the voiceprint of the caller to the enrolled voiceprint of the claimed identity, it generates an authentication score between 0-100. This score indicates the confidence of a match. You can configure a threshold for the score which indicates whether the caller is authenticated. The default threshold of 90 provides high security for most cases.

- If the authentication score is below the configured threshold, Voice ID treats the call as not authenticated.
- If the authentication score is above the configured threshold, Voice ID treats the call as authenticated.

For example, if the person is sick and calling from a mobile device in their car, the authentication score is going to be slightly lower than when the person is well and calling from a quiet room. If an imposter is calling, the authentication score is much lower.

Authentication response time

You can set the authentication response time between 5 and 10 seconds, which determines how quickly you want Voice ID authentication analysis to complete. Lowering it makes the response time faster at the tradeoff of lower accuracy. When you're using self-service IVR options where callers do not talk a lot, you may want to reduce this time. You can then increase the time if the call needs to be transferred to an agent.

The following image shows the Authentication Response time section of the block. The response time is set manually to 10 seconds.

Authentication Response time

Set the amount of time to collect audio before providing an authentication result. [Info](#)

Set manually

Response time(seconds)

10

Set dynamically

Choose **Set dynamically** to set the authentication threshold based on certain criteria. For example, you may want to raise the threshold based on the membership level of the customer, or the type of transaction or information they are calling about.

Fraud detection

The threshold you set for fraud detection is used to measure risk. Scores higher than the threshold are reported as higher risk. Scores lower than the threshold are reported as lower risk. Raising the threshold lowers false positive rates (makes result more certain), but raises false negative rates

Choose **Set dynamically** to set the fraud threshold based on certain criteria. For example, you may want to lower the threshold for high wealth customers, or the type of transaction or information they are calling about.

Fraud detection

This will check for impersonation attempts and presence of known fraudsters. [Info](#)

Enable fraud detection

Fraud threshold

Set a minimum score between 0-100 to establish a high risk threshold. Scores above this value will report as high risk. We recommend a threshold of 50 for optimal security. [Info](#)

Set manually

Threshold score

50

Set dynamically

Fraud watchlist

Specify an existing fraud watchlist in your Voice ID domain for this contact or use the default fraud watchlist for this domain. [Info](#)

Use default watchlist

Set manually

Set dynamically

The watch list you select is used when evaluating the voice session. Choose **Use default watch list** to use your domain's default watch list. For **Set manually**, the watch list ID must be 22 alphanumeric characters.

Similarly for the watch list, choose **Set dynamically** to set the watch list based on criteria given. For example, you may want to use a stricter watch list given the type of transaction or information they are calling about.

Configuration tips

- For the **Authentication threshold**, we recommend that you start with the default of 90 and adjust until you find a good balance for your business.

Every time you increase the value of the **Authentication threshold** beyond the default of 90, there's a tradeoff:

- The higher the threshold, the greater the false reject rate (FRR), that is, the likelihood that an agent will need to verify the customer's identity.

For example, if you set it too high, such as greater than 95, agents will need to verify every customer's identity.

- The lower the threshold, the greater the false acceptance rate (FAR), that is, the likelihood that Voice ID will incorrectly accept an access attempt by an unauthorized caller.
- When Voice ID verifies that the voice belongs to the enrolled customer, it returns a status of **Authenticated**. Add a [Check Voice ID](#) block to your flow branch based on the returned status.
- For the **Fraud threshold**, we recommend that you start with the default of 50 and adjust until you find a good balance for your business.

If the caller's score is above the threshold, it indicates there's a higher risk for fraud in that call.

- For the **Fraud watch list**, the format is validated when the flow is published.
 - If a watch list is dynamically set and the format is not valid, the contact is routed down the **Error** branch of the **Set Voice ID** block.
 - If a watch list ID is set manually or dynamically with a valid format but the watch list is not available in the Voice ID domain of the instance, the contact is routed down the **Error** branch of [Check Voice ID](#) block when the **Check Voice ID** block is used later in the flow.

Configured block

The following image shows an example of what this block looks like when it is configured. It has the following branches: **Success** and **Error**.



More information

See the following topic for more information about this block:

- [Use real-time caller authentication with Voice ID](#)
- [Flow block: Check Voice ID](#)
- [Use Voice ID](#)

Flow block: Set voice

Description

- Sets the text-to-speech (TTS) language and voice to use for the contact flow.
- The default voice is configured to Joanna (Conversational speaking style).
- You can choose **Override speaking style** to make it and other voices [Neural Voices](#). Neural voices make automated conversations sound more lifelike by improving the pitch, inflection, intonation, and tempo.

For a list of supported neural voices, see [Neural Voices](#) in the *Amazon Polly Developer Guide*.

- After this block is run, any TTS invocation resolves to the neural or standard voice selected.
- If this block is triggered during a chat conversation, the contact goes down the **Success** branch. It has no effect on the chat experience.

Supported channels

The following table lists how this block routes a contact who is using the specified channel.

Channel	Supported?
Voice	Yes
Chat	No - Success branch
Task	No - Success branch

Flow types

You can use this block in the following [flow types](#):

- All flows

Properties

The following image shows the **Properties** page of the **Set voice** block. It is configured for English, the voice is Joanna, and the speech style is Conversational.

Set voice ×

Sets the voice to interact with the customer. [Info](#)

Language
English (United States) ▼

Voice
Joanna ▼

Override speaking style - Neural: Conversational

i You can optionally change the speaking style to override the console settings.

Standard (Legacy)

Neural speaking style

Speech Style
Conversational ▼

Set language attribute
Use currently selected language as an attribute.

i Tip

For voices that support only neural speaking styles but not standard, the **Override speaking style** is automatically selected. You do not have the option to clear it.

Use an Amazon Lex V2 bot with Amazon Connect

If you're using an Amazon Lex V2 bot, your language attribute in Amazon Connect must match the language model used to build your Lex bot. This is different than Amazon Lex (Classic).

- If you build an Amazon Lex V2 bot with a different language model—for example, en_AU, fr_FR, es_ES, and more—under **Voice**, choose a voice that corresponds to that language, and then must choose **Set language attribute**, as shown in the following image.
- If you're not using an en-US voice with an Amazon Lex V2 bot and don't choose **Set language attribute**, the [Get customer input](#) block results in an error.
- For bots with multiple languages (for example, en_AU and en_GB) choose **Set language attribute** for one of the languages, as shown in the following image.

Configuration tips

- For the **Joanna** and **Matthew** neural voices, in American English (en-US), you can also specify a [Newscaster speaking style](#).

Configured block

The following image shows an example of what this block looks like when it is configured. It has the following branch: **Success**.

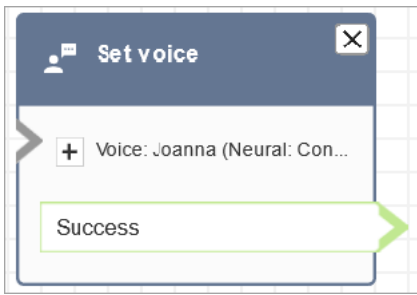

Scenarios

See these topics for scenarios that use this block:

- [Add text-to-speech to prompts](#)

Flow block: Set whisper flow

Description

A *whisper flow* is what a customer or agent experiences when they are joined in a voice or chat conversation. For example:

- An agent and customer are joined in a **chat**. An agent whisper might display text to the agent telling them the name of the customer, for example, which queue the customer was in, or let the agent know they're talking to club member.
- An agent and customer are joined in a **call**. A customer whisper might tell the customer that the call is being recorded for training purposes, for example, or thank them for being a club member.
- An agent and customer are joined in a **chat**. Using a contact attribute, an agent whisper flow records which agent is being connected to the conversation. This attribute is then used in a disconnect flow to route the contact back to the same agent if the customer has a follow-up question after the agent disconnects.

A whisper flow has the following characteristics:

- It's a one-sided interaction: either the customer hears or sees it, or the agent does.
- It can be used to create personalized and automated interactions.
- It runs when a customer and agent are being connected.

For voice conversations, the **Set whisper flow** block overrides the [default agent whisper flow](#) or [customer whisper flow](#) by linking to a whisper flow you create.

Important

For chat conversations, you need to include a **Set whisper flow** block for default agent or customer whispers to play. For instructions, see [Set the default whisper flow for a chat conversation](#).

How the Set whisper flow block works

- For inbound conversations (voice or chat), the **Set whisper flow** block specifies the whisper to be played to customer or the agent when they are joined.
- For outbound voice calls, it specifies the whisper to be played to customer.
- A whisper is one direction, which means only the agent or customer hears or sees it, depending on the type of whisper you selected. For example, if a customer whisper says "This call is being recorded," the agent does not hear it.
- A whisper flow is triggered after the agent accepts the contact (either auto-accept or manual accept). The agent whisper flow runs first, before the customer is taken out of queue. After this is completed, the customer is taken out of queue and the customer whisper flow runs. Both flows run to completion before the agent and customer can talk or chat with each other.
- If an agent disconnects while the agent whisper is running, the customer remains in queue in order to be re-routed to another agent.
- If a customer disconnects while the customer whisper is running, the contact ends.
- If an agent whisper flow or customer whisper flow includes a block that chat does not support, such as [Start/Stop](#) media streaming or [Set voice](#), chat skips these blocks and triggers an error branch. However, it doesn't prevent the flow from progressing.
- Whisper flows don't appear in transcripts.
- Whispers can be a maximum of 2 minutes long. After that point, the contact or agent is disconnected.

Supported channels

The following table lists how this block routes a contact who is using the specified channel.

Channel	Supported?
Voice	Yes
Chat	Yes
Task	Yes

Flow types

You can use this block in the following [flow types](#):

- Inbound flow
- Customer Queue flow
- Transfer to Agent flow
- Transfer to Queue flow

Properties

The following image shows the **Properties** page of the **Set whisper flow** block. It shows the whisper to the agent is set manually to **Default agent whisper**. Use the dropdown box to choose a different whisper flow.

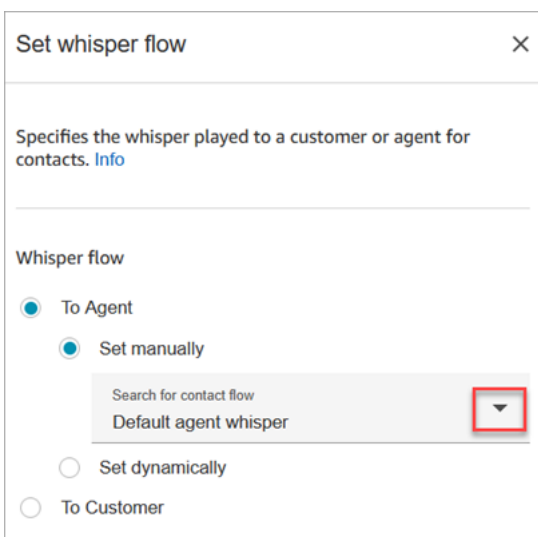

If you choose to **Select a flow**, you can only select from flows that are type **Agent Whisper** or **Customer Whisper**.

For information about using attributes, see [Use Amazon Connect contact attributes](#).

Configuration tips

- In a single block, you can set either a customer whisper or an agent whisper, but not both. Instead, use multiple **Set whisper flow** blocks in your flow.
- If you use a [Play prompt](#) block instead of a **Set whisper** block in an agent whisper flow or customer whisper flow, in a voice conversation the prompt is audible to both the agent and the customer. In a chat, however, only the agent or customer sees the **Play prompt** text.
- Make sure your whispers are able to complete within two minutes. Otherwise, calls will be disconnected before being established.
- If agents appear to be stuck in the "Connecting..." state before being forcefully disconnected from calls, make sure that your configured whisper flows meet the two minute maximum.

Configured block

The following image shows an example of what this block looks like when it is configured. It has the following branches: **Success** and **Error**.

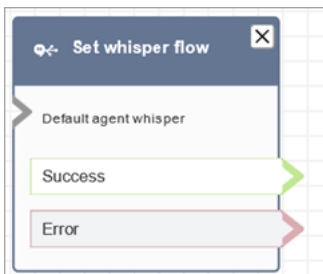

Flow block: Set working queue

Description

- This block specifies the queue to be used when **Transfer to queue** is invoked.
- A queue must be specified before invoking **Transfer to queue** except when used in a customer queue flow. It's also the default queue for checking attributes, such as staffing, queue status, and hours of operation.

Supported channels

The following table lists how this block routes a contact who is using the specified channel.

Channel	Supported?
Voice	Yes
Chat	Yes
Task	Yes

Flow types

You can use this block in the following [flow types](#):

- Inbound flow
- Transfer to Agent flow
- Transfer to Queue flow

Properties

The following image shows the **Properties** page of the **Set working queue** block. It is set to the **BasicQueue**.

Set working queue

Specify the queue that the contact will be transferred to.
Select a queue to perform actions on, such as transferring a contact to it or retrieving metrics about it. [Info](#)

By queue

Set manually

Search for queue
BasicQueue

Set dynamically

By agent

Note the following properties:

- **By queue > Set dynamically.** To set the queue dynamically, you must specify the Amazon Resource Name (ARN) for the queue rather than the queue name. To find the ARN for a

queue, open the queue in the queue editor. The ARN is included as the last part of the URL displayed in the browser address bar after /queue. For example, aaaaaaaaa-bbbb-cccc-dddd-111111111111.

Configured block

The following image shows an example of what this block looks like when it is configured. It has the following branches: **Success** and **Error**.

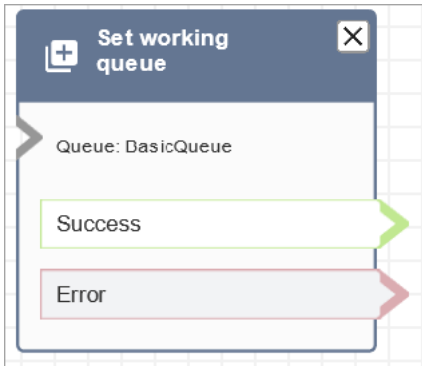

Sample flows

Amazon Connect includes a set of sample flows. For instructions that explain how to access the sample flows in the flow designer, see [Sample flows](#). Following are topics that describe the sample flows which include this block.

- [Sample queue customer](#)
- [Sample queue configurations](#)

Scenarios

See these topics for scenarios that use this block:

- [Set up agent-to-agent transfers](#)
- [Transfer contacts to a specific agent](#)

Flow block: Show view

Description

- Use this flow block to create [step-by-step guides](#) for agents who are using the Amazon Connect agent workspace. These guides are workflows that provide your agents with instructions to help them interact consistently with your customers.
- When a contact is routed to a flow that includes a **Show view** block, a UI template, called a [View](#) renders on the agent workspace. This UI template represents a step-by-step guide.

Use cases for this block

This flow block is designed to guide agents through the steps to:

- Perform common tasks for customers, such as making reservations, managing payments, and submitting new orders.
- Send emails based on a template that notifies a customer about a submitted refund request. The email structure is always the same, but specific values can vary, such as order number, refund amount, and payment account. You can configure the Show view block for the agent to provide these types of information.
- Create new CRM entries in the existing agent workspace. Use contact attributes to pre-populate the form with relevant information, such as the customer's name and phone number.

Contact types

Contact type	Supported?
Voice	Yes
Chat	Yes
Task	No

Flow types

You can use this block in the following [flow types](#):

Flow type	Supported?
Inbound flow	Yes
Customer hold flow	No
Customer whisper flow	No
Outbound whisper flow	No
Agent hold flow	No
Agent whisper flow	No
Transfer to agent flow	No
Transfer to queue flow	No

How to configure this block

You can configure the **Show view** block by using the Amazon Connect admin website or by using the [ShowView](#) action in the Amazon Connect Flow language.

Configuration sections

- [Choose the view resource](#)
- [How to use the Set manually option](#)
- [How to use the Set dynamically option](#)
- [How to use the Set JSON option](#)
- [Flow block branches](#)
- [Additional configuration tips](#)
- [Data generated by this block](#)

Choose the view resource

Amazon Connect includes a set of views that you can add your agent's workspace. You specify the view in the **View** box, as shown in the following image:

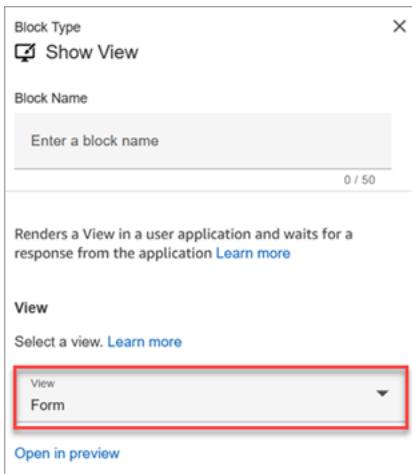

The screenshot shows a configuration window titled "Block Type" with a close button (X) in the top right corner. The window contains the following elements:

- A checked checkbox labeled "Show View".
- A "Block Name" label above a text input field containing the placeholder text "Enter a block name". Below the input field is a character count "0 / 50".
- A descriptive text: "Renders a View in a user application and waits for a response from the application [Learn more](#)".
- A "View" label above the text "Select a view. [Learn more](#)".
- A dropdown menu with "View" as the selected option and "Form" as the visible option. The dropdown is highlighted with a red border.
- A link "Open in preview" at the bottom left.

Following is a brief description of these AWS managed views. For detailed information about each one, see [AWS managed views](#).

- **Detail view.** Display information to agents and providing them with a list of actions that they can take. A common use case of the Detail view is to surface a screen-pop to the agent at the start of a call.
- **List view.** Display information as a list of items with titles and descriptions. Items can act as links with actions attached. It also optionally supports the standard back navigation and persistent context header.
- **Form view.** Provide your agents with input fields to gather required data and submit data to backend systems. This view consists of multiple Sections with a predefined Section style with a header. The body consists of various input fields arranged in a column or a grid layout format.
- **Confirmation view.** A page to show agents after a form has been submitted or an action has been completed. In this pre-built template you can provide a summary of what has happened, any next steps, and prompts. The Confirmation view supports a persistent attribute bar, an icon or image, headline, and sub-headline, along with a back to home navigation button.
- **Cards view.** Allows you to guide your agents by presenting them with a list of topics to choose from as soon as they accept the contact.

The properties of the **Show view** block are dynamically populated depending on which **View** resource you choose. For example, if you choose **Form**, you would configure **Next** and **Previous** actions, which are displayed. These are just a couple of the actions on the view.

The image shows a screenshot of a configuration interface with two sections: 'Next' and 'Previous'. Each section contains three radio button options: 'Set manually' (selected), 'Set dynamically', and 'Set JSON'. The 'Next' section has a 'Next' label above a horizontal line, and the 'Previous' section has a 'Previous' label above a horizontal line.

The following sections explain how to configure the **Form** actions manually, dynamically, or by using the JSON option.

How to use the Set manually option

1. On the **Properties** page, in the **View** section, choose **Form** from the dropdown menu, and set **Use version** to 1, the default. The following image shows a **Properties** page configured with these options.

View

Select a view. [Learn more](#)

View
Form

Open in preview

Version

Use version

Version
1

Use alias

- The **Properties** page displays a set of fields based on the Form view. Choose **Set manually** and enter text to be rendered on the View UI components. The following image shows the **Next** and **Previous** UI components. The display name of the components have been set manually to **Next** and **Previous**. That's what will appear on the agent workspace when the step-by-step guide is rendered.

Next

Set manually

Next
Next

Set dynamically

Set JSON

Previous

Set manually

Previous
Previous

Set dynamically

Set JSON

How to use the Set dynamically option

1. On the **Properties** page, in the **View** section, choose **Form** from the dropdown menu, and set **Use version** to 1, the default. The following image shows a **Properties** page configured with these options.

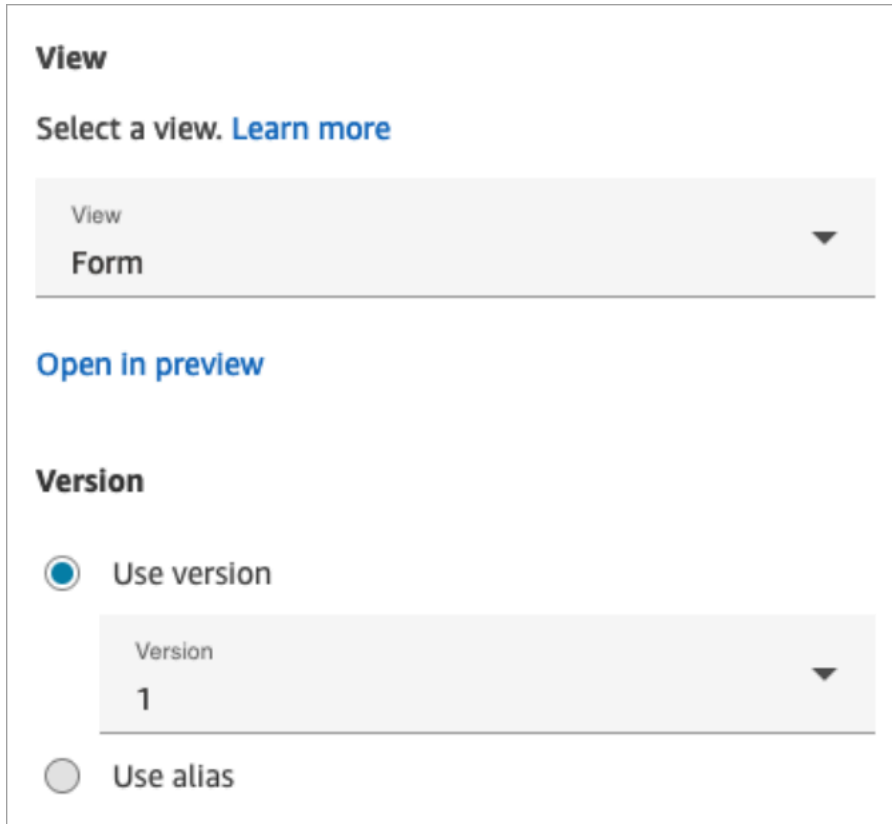

The screenshot shows the 'View' section of the Amazon Connect Properties page. It features a dropdown menu labeled 'View' with 'Form' selected. Below this is a link 'Open in preview'. The 'Version' section has two radio buttons: 'Use version' (selected) and 'Use alias'. Below the 'Use version' radio button is a dropdown menu labeled 'Version' with '1' selected.

2. The **Properties** page displays a set of fields based on the Form view. Choose **Set dynamically**. In the **Namespace** dropdown menu, choose the contact attribute, and then choose the key. The following image shows a **Heading** that will be rendered dynamically in the step-by-step guide to show the customer's last name.



The screenshot shows the 'Heading' section of the Amazon Connect Properties page. It features three radio buttons: 'Set manually', 'Set dynamically' (selected), and 'Set JSON'. Below the 'Set dynamically' radio button are two dropdown menus: 'Namespace' with 'Customer' selected, and 'Key' with 'Last name' selected.

How to use the Set JSON option

This section walks through an example of how to use the **Set JSON** option.

1. In the **View** section of the **Properties** page of the Show view block, choose **Form** from the dropdown menu and set **Version** to **1**, the default. These options are shown in the following image.

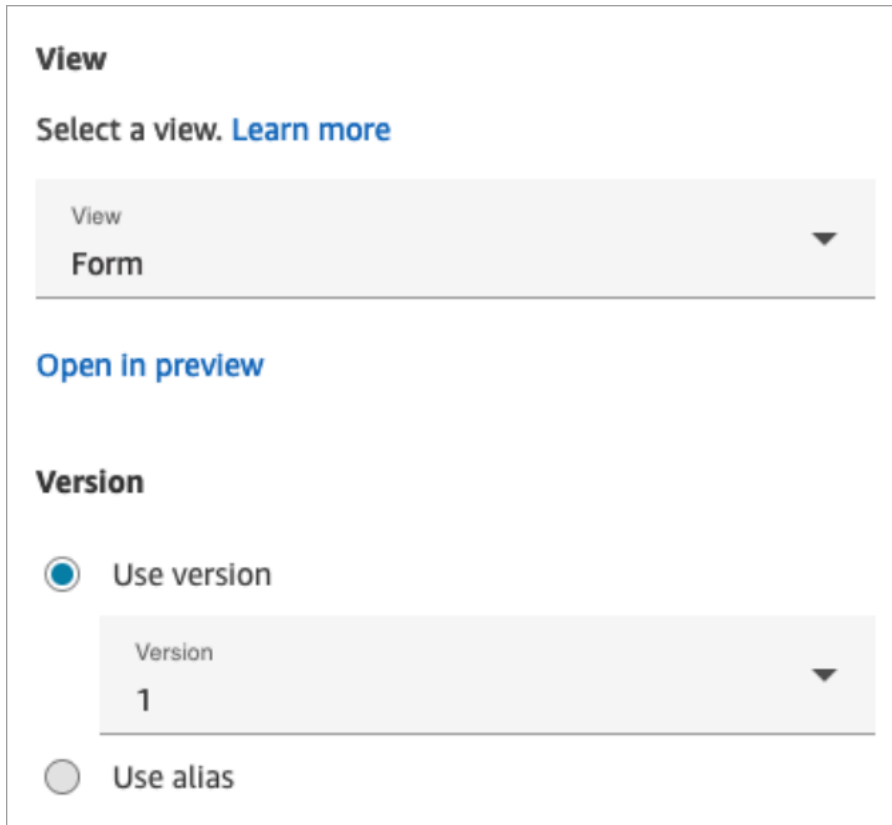

The image shows a screenshot of the 'View' and 'Version' settings in the Properties page of the Show view block. The 'View' section has a dropdown menu with 'Form' selected. Below it is a link 'Open in preview'. The 'Version' section has a radio button selected for 'Use version' and a dropdown menu with '1' selected. There is also a radio button for 'Use alias'.

2. When you choose the **Form** view, the input schema of the view is displayed on the **Properties** page. The schema has the following sections where you can add information: **Sections**, **AttributeBar**, **Back**, **Cancel**, **Edit**, **ErrorText**, and more.
3. The following image shows the **AttributeBar** parameter, and the **Set using JSON** option. To view all of the JSON you pasted in, click the corner of the box and pull down.

AttributeBar

Set manually

Set dynamically

Set JSON

```
AttributeBar
[
  {
    "Label": "Example",
    "Value": "Attribute"
  },
  {
    "Label": "Example 2",
    "Value": "Attribute 2"
  },
  {
    "Label": "Example 3",
    "Value": "Case:123456",
    "LinkType": "case",
    "ResourceId": "123456",
    "Copyable": true
  },
  {
    "Label": "Example 4",
    "Value": "Attribute 2",
    "LinkType": "external",
    "ResourceId":
"https://www.example.com"
  }
]
```

Click the corner and pull down to expand the box

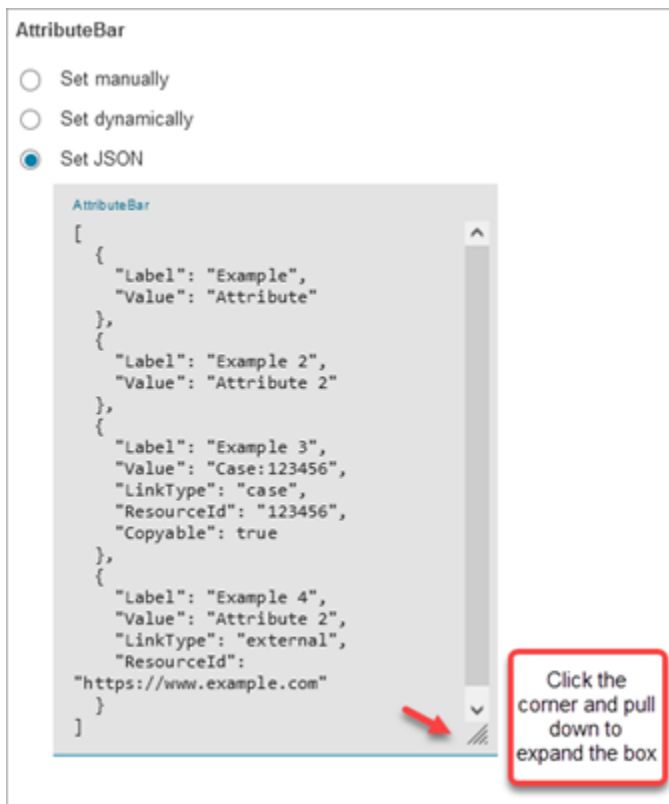
The screenshot shows a configuration window titled "AttributeBar". It has three radio buttons: "Set manually", "Set dynamically", and "Set JSON" (which is selected). Below the radio buttons is a text area containing a JSON array of objects. The JSON is formatted with syntax highlighting. A red arrow points to a small corner handle icon at the bottom right of the text area. A red-bordered callout box with white text points to this icon, containing the instruction "Click the corner and pull down to expand the box".

Tip

Fix any errors if the JSON is invalid. The following image shows an example error message because there's an extra comma.

```

AttributeBar
[
  {
    "Label": "Example",
    "Value": "Attribute",
  },
  {
    "Label": "Example 2",
    "Value": "Attribute 2"
  },
  {
    "Label": "Example 3",
    "Value": "Case:123456",
    "LinkType": "case",
    "ResourceId": "123456",
    "Copyable": true
  },
  {
    "Label": "Example 4",
    "Value": "Attribute 2",
    "LinkType": "external",
    "ResourceId":
      "https://www.example.com"
  }
]

```

Invalid JSON

4. Choose **Save** and publish when you are ready.

The following code sample shows how this same configuration would be represented by the [ShowView](#) action in the Flow language:

```

{
  "Parameters": {
    "ViewResource": {
      "Id": "arn:aws:connect:us-west-2:aws:view/form:1"
    },
    "InvocationTimeLimitSeconds": "2",
    "ViewData": {
      "Sections": "Sections",
      "AttributeBar": [
        {
          "Label": "Example",
          "Value": "Attribute"
        },
        {
          "Label": "Example 2",
          "Value": "Attribute 2"
        }
      ]
    }
  }
}

```

```

    },
    {
      "Label": "Example 3",
      "Value": "Case 123456",
      "LinkType": "case",
      "ResourceId": "123456",
      "Copyable": true
    },
    {
      "Label": "Example 3",
      "Value": "Case 123456",
      "LinkType": "case",
      "ResourceId": "https:example.com"
    }
  ],
  "Back": {
    "Label": "Back"
  },
  "Cancel": {
    "Label": "Cancel"
  },
  "Edit": "Edit",
  "ErrorText": "ErrorText",
  "Heading": "$.Customer.LastName",
  "Next": "Next",
  "Previous": "Previous",
  "SubHeading": "$.Customer.FirstName",
  "Wizard": {
    "Heading": "Progress tracker",
    "Selected": "Step Selected"
  }
}
},
"Identifier": "53c6be8a-d01f-4dd4-97a5-a001174f7f66",
"Type": "ShowView",
"Transitions": {
  "NextAction": "7c5ef809-544e-4b5f-894f-52f214d8d412",
  "Conditions": [
    {
      "NextAction": "7c5ef809-544e-4b5f-894f-52f214d8d412",
      "Condition": {
        "Operator": "Equals",
        "Operands": [
          "Back"
        ]
      }
    }
  ]
}

```

```
    ]
  }
},
{
  "NextAction": "7c5ef809-544e-4b5f-894f-52f214d8d412",
  "Condition": {
    "Operator": "Equals",
    "Operands": [
      "Next"
    ]
  }
},
{
  "NextAction": "7c5ef809-544e-4b5f-894f-52f214d8d412",
  "Condition": {
    "Operator": "Equals",
    "Operands": [
      "Step"
    ]
  }
}
],
"Errors": [
  {
    "NextAction": "b88349e3-3c54-4915-8ea0-818601cd2d03",
    "ErrorType": "NoMatchingCondition"
  },
  {
    "NextAction": "7c5ef809-544e-4b5f-894f-52f214d8d412",
    "ErrorType": "NoMatchingError"
  },
  {
    "NextAction": "b88349e3-3c54-4915-8ea0-818601cd2d03",
    "ErrorType": "TimeLimitExceeded"
  }
]
}
}
```

Flow block branches

The following image shows an example of a configured **Show view** block. This block supports conditional branches—that is, the branches depend on which view is selected. It also supports **Error** and **Timeout** branches.

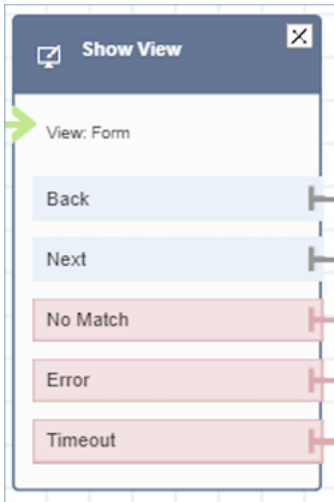

- **Conditional branches:** These branches are based on which view is selected on the **Show view** block. The previous image shows the block is configured for the **Form** view, and the following actions: **Back**, **Next**, and **No Match**.
 - For this particular configuration, at runtime, the chat contact is routed down the **Back** or **Next** branches depending on what the agent clicks on the view. **No match** is only possible if the user has an action component with a custom Action value.
- **Error:** Failure to run (that is, failure to render the view on agent workspace or to capture the view output action) results in taking the **Error** branch.
- **Timeout:** Specifies how long this step in the step-by-step guide should take the agent to complete. If it takes longer than Timeout for agent to complete the step (for example, the agent didn't provide required information in the specified amount of time) then that step takes the Timeout branch.

When a step times out, the step-by-step guide can follow logic defined in the flow to determine next step. For example, the next step could be to retry asking for information, or stop guide experience.

The customer is connected to the agent at this point, so there is no change in the customer's experience because of Timeout.

Additional configuration tips

Assign the following security profile permission to agents so they can use the step-by-step guides:

- **Agent Applications - Custom views - All:** This permission enables agents to see step-by-step guides in their agent workspace.

Assign the following security profile permission to managers and business analysts so they can create the step-by-step guides:

- **Channels and flows - Views:** This permission enables managers to create step-by-step guides.

For information about how to add more permissions to an existing security profile, see [Update security profiles](#).

Data generated by this block

At runtime, the **Show view** block generates data that is the output when the View resource runs. Views generate two main pieces of data:

- Action taken on the rendered View-UI (on agent workspace) and the `ViewResultData` which is the Output data.

When using a **Show view** block, **Action** represents a branch and set to `$.Views.Action` contact attribute under Views namespace.

- Output data is set to `$.Views.ViewResultData` contact attribute under Views namespace.

The values of Action and the Output data are determined by which the component(s) the agent interacted with during their use of the view resource.

How to use this data in different parts of flow

- When the block receives a response back from the client application, to reference the output data in flows use `$.Views.Action` and `$.Views.ViewResultData`.
- When using a view with the **Show view** block, Action represents a branch that is captured in the contact attribute under the Views namespace as `$.Views.Action`, and View Output data is set to the `$.Views.ViewResultData` contact attribute.

- You can refer to the data generated by the **Show view** block by using the JSON path in contact attributes (you can specify contact attributes in the Set manually or Set JSON options) or by using the attribute selector dropdown when you choose **Set dynamically**.

Error scenarios

A contact is routed down the **Error** branch in the following situations:

- Amazon Connect is unable to capture the user action on a View UI component on agent workspace. This may be due to an intermittent network issue or an issue in the media-service side.

Flow log entry

Amazon Connect flow logs provide you with real-time details about events in your flow as customers interact with it. For more information, see [Track events as customers interact with flows](#).

Following sample ShowView input (ingress log)

```
{
  "ContactId": "string",
  "ContactFlowId": "string",
  "ContactFlowName": "string",
  "ContactFlowModuleType": "ShowView",
  "Timestamp": "2023-06-06T16:08:26.945Z",
  "Parameters": {
    "Parameters": {
      "Cards": [
        {
          "Summary": {
            "Id": "See",
            "Heading": "See cancel options"
          }
        },
        {
          "Summary": {
            "Id": "Change",
            "Heading": "Change Booking"
          }
        }
      ],
    }
  }
}
```

```
    "Summary": {
      "Id": "Get",
      "Heading": "Get Refund Status"
    }
  },
  {
    "Summary": {
      "Id": "Manage",
      "Heading": "Manage rewards"
    }
  }
],
"NoMatchFound": {
  "Label": "Do Something Else",
  "type": "bubble"
}
},
"TimeLimit": "300",
"ViewResourceId": "cards"
}
}
```

Following sample ShowView output (egress log)

```
{
  "Results": "string",
  "ContactId": "string",
  "ContactFlowId": "string",
  "ContactFlowName": "string",
  "ContactFlowModuleType": "ShowView",
  "Timestamp": "2023-06-06T16:08:35.201Z"
}
```

Sample flows

You can download a sample flow from Step 2 in the following blog: [Getting started with step-by-step guides](#). We recommend performing the steps in the blog to learn how to create flows that are configured with AWS-managed Views and how to run these flows for inbound media contacts.

More resources

See the following topics to learn more about step-by-step guides and Views.

- [Step-by-step Guides](#)
- For step-by-step instructions about how to set up a customer-managed Views, see [Customer-managed Views](#).
- For setting up a plug-and-play step-by-step guide experience in your instance, see [Getting started with step-by-step guides](#).
- [AWS-managed Views - Common Configuration](#)
- [Views - UI Components](#)
- [View actions](#) in the *Amazon Connect API Reference*.

Flow block: Start media streaming

Description

Captures what the customer hears and says during a contact. You can then perform analysis on the audio streams to:

- Determine customer sentiment.
- Use the audio for training purposes.
- Identify and flag abusive callers.

Supported channels

The following table lists how this block routes a contact who is using the specified channel.

Channel	Supported?
Voice	Yes
Chat	No - Error branch
Task	No - Error branch

Flow types

You can use this block in the following [flow types](#):

- Inbound flow
- Customer Queue flow
- Customer Whisper flow
- Outbound Whisper flow
- Transfer to Agent flow
- Transfer to Queue flow

Properties

The following image shows the **Properties** page of the **Start media streaming** block. It has two options: start the stream from the customer or to the customer.

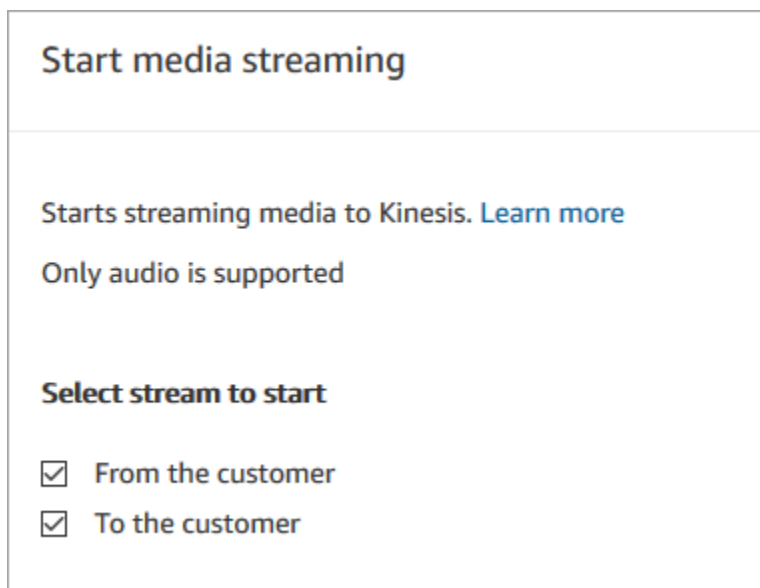

Configuration tips

- You must enable live media streaming in your instance to successfully capture customer audio. For instructions, see [Set up live media streaming of customer audio](#).
- Customer audio is captured until a **Stop media streaming** block is invoked, even if the contact is passed to another flow.
- You must use a **Stop media streaming** block to stop media streaming.
- If this block is triggered during a chat conversation, the contact is routed down the **Error** branch.

Configured block

The following image shows an example of what this block looks like when it is configured. It has the following branches: **Success** and **Error**.



Sample flows

Amazon Connect includes a set of sample flows. For instructions that explain how to access the sample flows in the flow designer, see [Sample flows](#). Following are topics that describe the sample flows which include this block.

[Example flow for testing live media streaming](#)

Flow block: Stop media streaming

Description

- Stops capturing customer audio after it is started with a **Start media streaming** block.
- You must use a **Stop media streaming** block to stop media streaming.

Supported channels

The following table lists how this block routes a contact who is using the specified channel.

Channel	Supported?
Voice	Yes
Chat	No - Error branch
Task	No - Error branch

Flow types

You can use this block in the following [flow types](#):

- Inbound flow
- Customer Queue flow
- Customer Whisper flow
- Outbound Whisper flow
- Agent Whisper flow
- Transfer to Agent flow
- Transfer to Queue flow

Properties

This block doesn't have any properties.

Configuration tips

- You must enable live media streaming in your instance to successfully capture customer audio. For instructions, see [Set up live media streaming of customer audio](#).
- Customer audio is captured until a **Stop media streaming** block is invoked, even if the contact is passed to another flow.
- If this block is triggered during a chat conversation, the contact is routed down the **Error** branch.

Configured block

The following image shows an example of what this block looks like when it is configured. It has the following branches: **Success** and **Error**.



Sample flows

Amazon Connect includes a set of sample flows. For instructions that explain how to access the sample flows in the flow designer, see [Sample flows](#). Following are topics that describe the sample flows which include this block.

[Example flow for testing live media streaming](#)

Flow block: Store customer input

Description

This block is similar to **Get customer input**, but this one stores the input as a contact attribute (in the [Stored customer input](#) system attribute) and allows you to encrypt it. This way, you can encrypt sensitive input such as credit card numbers. This block:

- Plays a prompt to get a response from the customer. For example, "Please enter your credit card number" or "Please enter the phone number we should use to call you back."
- Plays an interruptible audio prompt or play text-to-speech for a customer to respond to.
- Stores numerical input as in the [Stored customer input](#) system attribute.
- Allows you to specify a custom terminating keypress.
- If during a call the customer doesn't enter any input, the contact is routed down the **Success branch** branch with a value of Timeout. Add a **Check contact attributes** block to check for timeouts.

Supported channels

The following table lists how this block routes a contact who is using the specified channel.

Channel	Supported?
Voice	Yes
Chat	No - Error branch
Task	No - Error branch

Flow types

You can use this block in the following [flow types](#):

- Inbound flow
- Customer Queue flow
- Transfer to Agent flow
- Transfer to Queue flow

Properties

The following image shows the **Properties** page of the **Store customer input** block. It shows the **Prompt** section configured to play the **Audio prompt**.

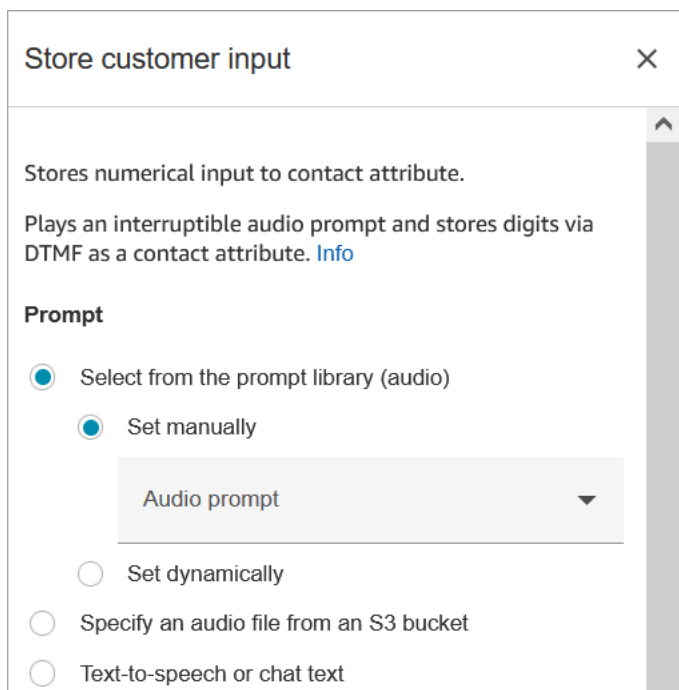

The following image shows the **Customer input** section of the page. It is configured to allow up to 20 digits. It is set to timeout after 5 seconds of no input.

Customer input

Custom

Maximum Digits
20

Timeout before first entry (in seconds)
5

Encrypt entry (recommended)

Specify terminating keypress

Disable cancel key

Phone number

Note the following properties:

- For information about choosing a prompt from the Amazon Connect library or an S3 bucket, see the [Play prompt](#) block.
- **Maximum Digits:** Define the maximum number of digits that a customer can enter.
- **Timeout before first entry:** Specify how long to wait for a customer to start entering their reply by voice or DTMF. For example, you might enter 20 seconds, to give the customer time to get their credit card.

After the contact starts entering digits, Amazon Connect waits 5 seconds for each digit, by default. You cannot change this default setting.

- **Encrypt entry:** Encrypt the customer's entry, such as their credit card information. For step-by-step instructions to get the keys that you use to input this information, see [Creating a secure IVR solution with Amazon Connect](#).
- **Specify terminating keypress:** Define a custom terminating keypress that is used when your contacts complete their DTMF inputs. The terminating keypress can be up to five digits long, with #, * and 0-9 characters, instead of just #.

Note

To use a star (*) as part of the terminating keypress, you must also choose **Disable cancel key**.

- **Disable cancel key:** By default, when a customer enters * as input, it deletes all of the DTMF input that came before it. However, if you choose **Disable cancel key**, Amazon Connect treats the * as any other key.

If you send the DTMF input to an [Invoke AWS Lambda function](#) block, the **Disable cancel key** property affects the input, as follows:

- When **Disable cancel key** is selected, all the characters entered—including any *—are sent to the **Invoke Lambda function** block.
- When **Disable cancel key** is not selected, only the * is sent to the **Invoke Lambda function** block.

For example, let's say you chose **Disable cancel key**, and a customer entered `1#2#3*4###`, where `##` is the terminating keypress. The **Invoke Lambda function** block then receives the entire `1#2#3*4#` as input. You could program the Lambda function to ignore the character before the * character. So, the customer input would be interpreted as `1#2#4#`.

- **Phone number:** This option is useful for queued callback scenarios.
 - **Local format:** If all of your customers are calling from the same country that your instance is in, choose that country from the dropdown list. Amazon Connect then auto-populates the country code for customers so that they don't have to enter it.
 - **International format:** If you have customers calling from different countries, choose **International format**. Amazon Connect then requires customers to enter their country code.

Problems with DTMF input?

Let's say you have the following scenario with two contact flows, each one capturing DTMF input from customers:

1. One flow uses the **Get customer input** block to request DTMF input from customers.
2. After the DTMF input is entered, it uses the **Transfer to flow** block to move the contact to the next contact flow.
3. In the next flow, there's a **Store customer input** block to get more DTMF input from the customer.

There's setup time between the first and second flows. This means if the customer enters DTMF input very quickly for the second flow, some of the DTMF digits might be dropped.

For example, the customer needs to press 5, then wait for a prompt from the second flow, then type 123. In this case, 123 is captured without problem. However, if they don't wait for the prompt and enter 5123 very quickly, the **Store customer input** block may capture only 23 or 3.

To guarantee the **Store customer input** block in second contact flow captures all of the digits, the customer needs to wait for the prompt to be played, and then enter their type DTMF input.

Configured block

The following image shows an example of what this block looks like when it is configured. It has the following branches: **Success**, **Error**, and **Invalid number**.



1. **Invalid number:** What to do if the customer enters an invalid number.

Sample flows

Amazon Connect includes a set of sample flows. For instructions that explain how to access the sample flows in the flow designer, see [Sample flows](#). Following are topics that describe the sample flows which include this block.

- [Sample secure input with agent](#)
- [Sample secure input with no agent](#)
- [Sample queue configurations](#)
- [Sample queued callback](#)

Scenarios

[Creating a secure IVR solution with Amazon Connect](#)

Flow block: Transfer to agent (beta)

Description

- Ends the current flow and transfers the customer to an agent.

Note

If the agent is already with someone else, the contact is disconnected.
If the agent is in After Contact Work, they are automatically removed from ACW at the time of transfer.

- The **Transfer to Agent** block is a beta feature and works only for voice interactions.
- We recommend using the [Set working queue](#) block for agent-to-agent transfers instead of using this block. The **Set working queue** block supports omnichannel transfers such as voice and chat. For instructions, see [Set up agent-to-agent transfers](#).

Supported channels

The following table lists how this block routes a contact who is using the specified channel.

Channel	Supported?
Voice	Yes
Chat	No - Error branch
Task	No - Error branch

To transfer chats and tasks to agents, use the [Set working queue](#) block. Because [Set working queue](#) works for all channels, we recommend using it for voice calls too, instead of using **Transfer to agents (beta)**. For instructions, see [Set up agent-to-agent transfers](#).

Flow types

You can use this block in the following [flow types](#):

- Transfer to Agent flow

- Transfer to Queue flow

Properties

The following image shows the **Properties** page of the **Transfer to agent** block. It does not have any options on it.

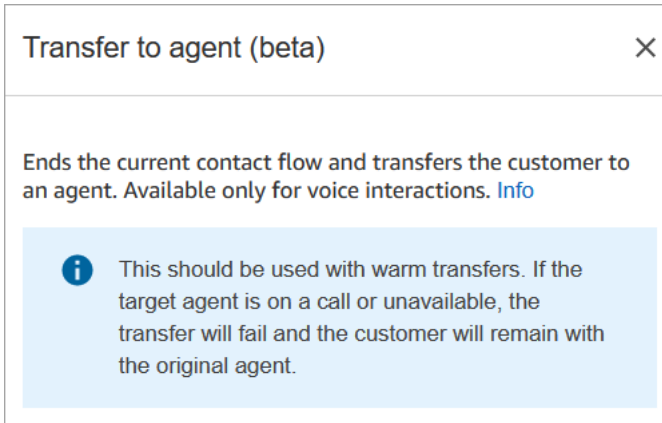

Configured block

The following image shows an example of what this block looks like when it is configured. It displays the status **Transferred**. It does not have any branches.



Scenarios

See these topics for scenarios that use this block:

- [Set up contact transfers](#)

Flow block: Transfer to flow

Description

- Ends the current flow and transfers the customer to a different flow.

Supported channels

The following table lists how this block routes a contact who is using the specified channel.

Channel	Supported?
Voice	Yes
Chat	Yes
Task	Yes

Flow types

You can use this block in the following [flow types](#):

- Inbound flow
- Transfer to Agent flow
- Transfer to Queue flow

Properties

The following image shows the **Properties** page of the **Transfer to flow** block. You choose the flow from the dropdown box.

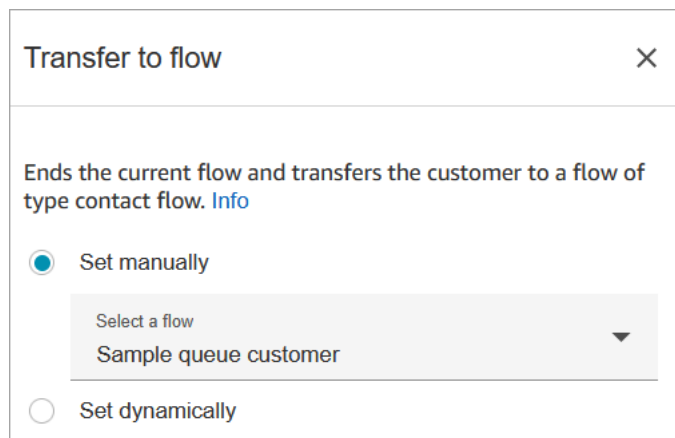

The screenshot shows a dialog box titled "Transfer to flow" with a close button (X) in the top right corner. Below the title, there is a description: "Ends the current flow and transfers the customer to a flow of type contact flow. [Info](#)". There are two radio buttons: "Set manually" (which is selected) and "Set dynamically". Below the "Set manually" radio button is a dropdown menu with the text "Select a flow" and "Sample queue customer" as the selected item. A small downward arrow is visible on the right side of the dropdown menu.

Only published flows appear in the dropdown list.

Configured block

The following image shows an example of what this block looks like when it is configured. It has the following branch: **Error**.

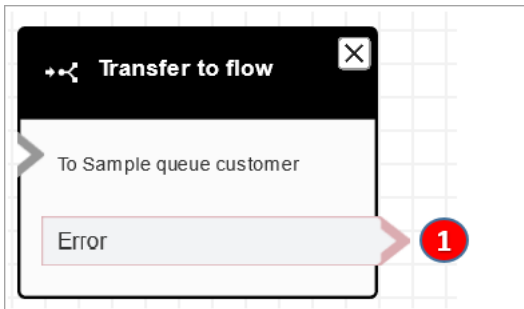

1. The contact is routed down the **Error** branch if the flow you have specified to transfer to isn't a valid flow, or it's not a valid flow type (Inbound, Transfer to Agent, or Transfer to Queue).

Sample flows

Amazon Connect includes a set of sample flows. For instructions that explain how to access the sample flows in the flow designer, see [Sample flows](#). Following are topics that describe the sample flows which include this block.

- [Sample AB test](#)

Scenarios

See these topics for scenarios that use this block:

- [Set up contact transfers](#)

Flow block: Transfer to phone number

Description

- Transfers the customer to a phone number external to your instance.
- If this block is triggered during a chat conversation, the contact is routed down the **Error** branch.

Supported channels

The following table lists how this block routes a contact who is using the specified channel.

Channel	Supported?
Voice	Yes
Chat	No - Error branch
Task	No - Error branch

Flow types

You can use this block in the following [flow types](#):

- Inbound flow
- Customer Queue flow
- Transfer to Agent flow
- Transfer to Queue flow

Properties

The following image shows the **Properties** page of the **Transfer to phone number** block. It shows the **Transfer via** section. The **Country code** is set to +1 (US). **Set timeout** = 30 seconds.

Transfer to phone number
✕

Transfer a call to a phone number for voice interactions.
[Info](#)

Transfer via

Phone number

Set manually

Country code

+1

Phone number

Set dynamically

Set timeout

Set manually

Timeout (in seconds)

30

Set dynamically

The following image shows the **Resume flow after disconnect** section is set to **Yes**.

Resume contact flow after disconnect

Adds success, call failed and timeout output branches

Yes

No

Optional parameters

Send DTMF

Caller ID number

Caller ID name

Note the following properties:

- **Resume flow after disconnect:** This works only if the external party disconnects, and the customer doesn't disconnect. (If the customer disconnects, the whole call disconnects.)

- **Send DTMF:** This property is useful to bypass some of the DTMF of the external party. For example, if you know you'll need to press 1, 1, 362 to reach the external party, you can enter that here.

If you specify a comma in **Send DTMF** it pauses for 750ms.

- **Caller ID number:** You can choose a number from your instance to appear as the caller ID. This is useful in cases where you want to use a number that's different from the one the flow is actually using to make the call.

Important

If you are using Amazon Connect outside of the United States, we recommend choosing **Caller ID number** and then selecting an Amazon Connect number. Otherwise, local regulations may cause telephony providers to block or redirect non-Amazon Connect phone numbers. This will result in service-related events, such as rejected calls, poor audio quality, delay, latency, and displaying the incorrect caller ID.

In Australia: The caller ID must be an Amazon Connect provided DID (Direct Inward Dialing) phone number. If a toll free number or a number not provided by Amazon Connect is used in the caller ID, local telephony suppliers may reject outbound calls due to local anti-fraud requirements.

In the UK: The caller ID must be a valid E164 phone number. If the phone number is not provided in the caller ID, local telephony suppliers may reject outbound calls due to local anti-fraud requirements.

- **Caller ID name:** You can set a caller ID name, but there's no guarantee it will appear correctly to the customer. For more information, see [Outbound caller ID number](#).

Note

When [Transfer to phone number](#) block is used without specifying a custom caller ID, the caller ID of the caller is passed as the caller ID. For example, if you transfer to an external number and no custom caller ID is used to specify that the call is coming from your organization, then the contact's caller ID is displayed to the external party.

Configuration tips

- [Submit a service quota increase request](#) requesting that your business be allowed to make outbound calls to the country you specified. If your business is not on the allowlist for making the call, it will fail. For more information, see [Countries you can call by default](#).
- If the country you want to select is not listed, you can submit a request to add countries you want to transfer calls to using the [Amazon Connect service quotas increase form](#).
- You can choose to end the flow when the call is transferred, or choose to **Resume flow after disconnect**, which returns the caller to your instance and resumes the flow after the transferred call ends.

Configured block

The following image shows an example of what this block looks like when it is configured. It shows the number you are transferring to. It has the following branches: **Success**, **Call Failed**, **Timeout**, **Error**.



Scenarios

See these topics for scenarios that use this block:

- [Set up contact transfers](#)
- [Set up outbound caller ID](#)

Flow block: Transfer to queue

Description

Use this block to transfers current contact to the destination queue.

The functionality of this block depends on where it is used:

- When used in a Customer Queue flow, this block transfers a contact already in a queue to another queue.
- When used in a callback scenario, Amazon Connect calls the agent first. After the agent accepts the call in the CCP, Amazon Connect calls the customer.
- In all other cases, this block places the current contact in a queue and ends current flow.
- This block cannot be used in a callback scenario when using the chat channel. If you attempt to do so, an error branch is followed. In addition, an error is created in the CloudWatch log.

Use cases for this block

This block is designed to be used in the following scenarios:

- Place the contact in a queue to be connected to an agent.
- You want to move the current customer from a generic queue to a specialized queue. You may want to do this when customers have waited too long in the queue, for example, or you have other business requirements.
- Offer callback options to the customer instead of having them wait to be connected to an agent.

Contact types

The following table lists how this block routes a contact who is using the specified channel.

Contact type	Supported?
Voice	Yes
Chat	Yes
Task	Yes

Flow types

You can use this block in the following [flow types](#):

Flow type	Supported?
Inbound flow	Yes
Customer queue flow	Yes
Customer hold flow	No
Customer whisper flow	No
Outbound whisper flow	No
Agent hold flow	No
Agent whisper flow	No
Transfer to agent flow	Yes
Transfer to queue flow	Yes

How to configure this block

You can configure the **Transfer to queue** block using the Amazon Connect admin website. Or you can use the Amazon Connect Flow language. Depending on the use case you use one of the following actions:

- If the flow block is used in CustomerQueue flow type, it is represented as [DequeueContactAndTransferToQueue](#) action in the Flow Language.
- If the flow block is used to configure callbacks, it is represented as [CreateCallbackContact](#) action.
- If the flow block is used to configure callbacks, it is represented as [TransferContactToQueue](#) action.

Configuration sections

- [Transfer to queue](#)

- [Transfer to callback queue \(scheduling callbacks\)](#)
- [Flow block branches](#)
- [Additional configuration tips](#)
- [Data generated by the block](#)

Transfer to queue

Use this configuration tab to transfer the contact to a queue. There are two possible scenarios:

- **Contacts are not in any queue yet:** If contacts are not in a queue yet, this configuration simply puts the contacts in the destination queue that you've specified. For contacts not in a queue yet, you must use "Set Working Queue" flow block before "Transfer to Queue" flow block. The following image shows the **Transfer to queue** tab on the **Properties** page for transferring contacts to queue. You don't need to choose any options.

The following code sample shows how this same configuration would be represented by the [TransferContactToQueue](#) action in the Flow language:

```
{
  "Parameters": {},
```

```
"Identifier": "a12c905c-84dd-45c1-8f53-4287d1752d59",
>Type": "TransferContactToQueue",
>Transitions": {
>  "NextAction": "",
>  "Errors": [
>    {
>      "NextAction": "0a1dc9a4-8657-4941-a980-772046b94f1e",
>      "ErrorType": "QueueAtCapacity"
>    },
>    {
>      "NextAction": "6e84a9b5-1ed0-40b1-815d-a3bdd4b2dc8a",
>      "ErrorType": "NoMatchingError"
>    }
>  ]
> }
}
```

There are two possible outcomes in this case:

- **At capacity:** If the destination queue cannot accept additional contacts when number of contacts currently in a queue exceeds the maximum contacts allowed for queue, then the contact is routed down the **At Capacity** branch.
- **Error:** If transfer to queue fails for any other reason apart from capacity constraint (for example, the queue ARN that is specified for the transfer is not valid, the queue does not exist in the current instance, or queue is disabled for routing), then the contact is routed down the **Error** branch.
- **Contact already in a queue:** If contacts are already waiting in a queue, then running the **Transfer to queue** block would move contacts from one queue to another. The following image shows how to configure the block to transfer contacts to queue. In this case, the **BasicQueue** is set manually.

Transfer to queue
✕

Ends the current contact flow and transfers the contact to a queue. [Info](#)

Transfer to queue
Transfer to callback queue

When you use Transfer to callback queue, you must use a 'Set customer callback number' block before this block in the flow to set the callback number for the customer.

Initial delay

99

in seconds

Max number of retries

1

Minimum time between attempts

minutes

10

seconds

0

Optional parameters

Set working queue

- By queue
- Set manually
- Search for queue

BasicQueue
- Set dynamically
- By agent

The following code sample shows how this same configuration would be represented by the [DequeueContactAndTransferToQueue](#) action in the Flow language:

```
{
  "Parameters": {
    "QueueId": "arn:aws:connect:us-west-2:1111111111:instance/aaaaaaa-bbbb-
cccc-dddd-eeeeeeeeeeee/queue/abcdef-abcd-abcd-abcd-abcdefghijkl"
  },
  "Identifier": "180c3ae1-3ae6-43ee-b293-546e5df0286a",
  "Type": "DequeueContactAndTransferToQueue",
  "Transitions": {
    "NextAction": "",
    "Errors": [
      {
        "NextAction": "0a1dc9a4-8657-4941-a980-772046b94f1e",
        "ErrorType": "QueueAtCapacity"
      }
    ]
  }
}
```

```
    {
      "NextAction": "6e84a9b5-1ed0-40b1-815d-a3bdd4b2dc8a",
      "ErrorType": "NoMatchingError"
    }
  ]
}
```

There are three possible outcomes in this case:

- **Success:** Indicates the contact successfully transferred to the destination queue.
- **At capacity:** If the destination queue cannot accept additional contacts when the number of contacts currently in a queue exceeds maximum contacts allowed for queue, then the contact is routed down the **At Capacity** branch. The contact remains in the current working queue.
- **Error:** If transfer to queue fails for any other reason apart from capacity constraint (for example, the queue ARN that is specified for the transfer is not valid, the queue does not exist in the current instance, or queue is disabled for routing), then the contact is routed down the **Error** branch. The contact remains in the current working queue.

Transfer to callback queue (scheduling callbacks)

Use this configuration tab to schedule callbacks for contacts at later time. The following image shows a **Properties** page that is configured for scheduling callbacks.

Transfer to queue
✕

Ends the current contact flow and transfers the contact to a queue. [Info](#)

Transfer to queue
Transfer to callback queue

When you use Transfer to callback queue, you must use a 'Set customer callback number' block before this block in the flow to set the callback number for the customer.

Initial delay

99

in seconds

Max number of retries

1

Minimum time between attempts

minutes

10

seconds

0

Optional parameters

Set working queue

- By queue
- Set manually
- Set dynamically
- By agent

Search for queue

BasicQueue

▼

The following properties are available under the **Transfer to callback queue** tab:

- **Initial delay:** Specify how much time has to pass between a callback contact being initiated in the flow, and the customer is put in queue for the next available agent.
- **Maximum number of retries:** If this were set to 1, then Amazon Connect would try to callback the customer at most two times: the initial callback, and 1 retry.

Tip

We strongly recommend that you double-check the number entered in **Maximum number of retries**. If you accidentally enter a high number, such as 20, it's going to result in unnecessary work for the agent and too many calls for the customer.

- **Minimum time between attempts:** If the customer doesn't answer the phone, this is how long to wait until trying again.

- **Set working queue:** You can transfer a callback queue to a different queue. This is useful if you set up a special queue just for callbacks. You can then view that queue to see how many customers are waiting for callbacks.

Tip

If you want to specify the **Set working queue** property, you need to add a **Set customer callback number** block before this block.

If you don't set a working queue, Amazon Connect uses the queue that was set previously in the flow.

Flow block branches

This block supports the following output branches:

- **Success:** Indicates successfully played the provided audio or text message.
- **Error:** Indicates a failure to play provided audio or text message.

When this block is configured to **transfer to queue**, it looks similar to the following image. It has two branches: **At capacity** and **Error**. If a contact is routed down the **At capacity** branch, it remains in the current working queue.

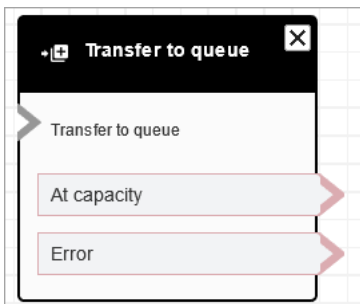

When this block is configured to **transfer to callback queue**, it looks similar to the following image. It has two branches: **Success** and **Error**. If a contact is routed down the **Success** branch, it's transferred to the specified queue.

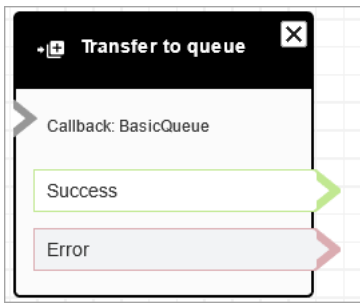

Additional configuration tips

- When you use this block in a Customer Queue flow, you must add a **Loop prompts** block before this one.
- To use this block in most flows, you must add a **Set working queue** block first. The one exception to this rule is when this block is used in a Customer Queue flow.
- Queue-to-queue transfers can be done only 11 times because there is a maximum limit of 12 contacts in a contact chain. Every transfer adds a new contact to the chain.

Data generated by the block

This block does not generate any data.

Error scenarios

A contact is routed down the **Error** branch in the following situations:

When the Transfer to queue block runs, it checks the queue capacity to determine whether the queue is at capacity (full). This check for queue capacity compares the current number of contacts in the queue to the Maximum contacts in queue limit, if one is set for the queue. If no limit is set, the queue is limited to the number of concurrent contacts set in the service quota for the instance.

Sample flows

Amazon Connect includes a set of sample flows. For instructions that explain how to access the sample flows in the flow designer, see [Sample flows](#). Following are topics that describe the sample flows which include this block.

- [Sample queue configurations](#)
- [Sample customer queue priority](#)
- [Sample queued callback](#)

More resources

See the following topics to learn more about the transferring contacts to a queue and queued callback.

- [Manage contacts in a queue](#)
- [Set up queued callback by creating flows, queues, and routing profiles](#)
- [About queued callbacks in metrics](#)

Flow block: Wait

Description

This block pauses the flow for the specified wait time.

For example, if a contact stops responding to a chat, the block pauses the contact flow for the specified wait time (**Timeout** time), then branches accordingly, such as to disconnect.

Supported channels

The following table lists how this block routes a contact who is using the specified channel.

Channel	Supported?
Voice	No - Error branch
Chat	Yes
Task	Yes - It always branches to Time Expired or Error . It never branches to Bot participant disconnected or Participant not found . The Participant Type setting does not affect this behavior.

Flow types

You can use this block in the following [flow types](#):

- Inbound flow
- Customer Queue flow

Properties

The following image shows the **Properties** page of the **Wait** block. It is configured pause the flow for 5 hours.

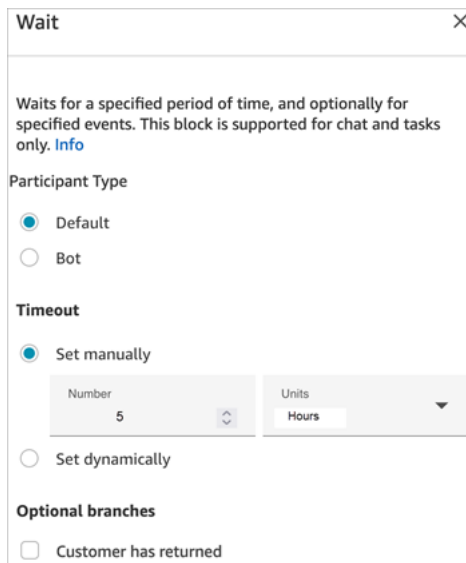

The screenshot shows the 'Wait' block configuration dialog. It includes a description: 'Waits for a specified period of time, and optionally for specified events. This block is supported for chat and tasks only. Info'. Under 'Participant Type', 'Default' is selected. Under 'Timeout', 'Set manually' is selected, with 'Number' set to 5 and 'Units' set to 'Hours'. 'Set dynamically' is unselected. Under 'Optional branches', 'Customer has returned' is unselected.

It has the following properties:

- **Participant Type:** Runs the **Wait** block for the specified participant type.
 - **Default** - A customer contact.
 - **Bot** - A custom participant, such as a third-party bot. For more information about using this option, see [Customize chat flow experiences by integrating custom participants](#).
- **Timeout:** Run this branch if the customer hasn't sent a message after a specified amount of time. Maximum is 7 days.
 - Manually set timeout: You can provide the **Number** and **Units**.
 - Dynamically set timeout: The unit of measurement is in seconds.
- **Customer return:** Route the contact down this branch when the customer returns and sends a message. With this branch you can route the customer to the previous (same) agent, previous (same) queue, or override and set a new working queue or agent. This optional branch is available only when **Participant Type** = **Default**.

Configuration tips

You can add multiple **Wait** blocks to your contact flows. For example:

- If the customer comes back in 5 minutes, connect them to the same agent. This is because that agent has all of the context.
- If the customer doesn't come back after 5 minutes, send a text saying "We missed you."
- If the customer comes back in 12 hours, connect to a flow that puts them in a priority queue. However, it doesn't route them to the same agent.

Configured block

The following image shows an example of what this block looks like when it is configured with **Participant Type = Default**. It has the following branches: **Time Expired** and **Error**.

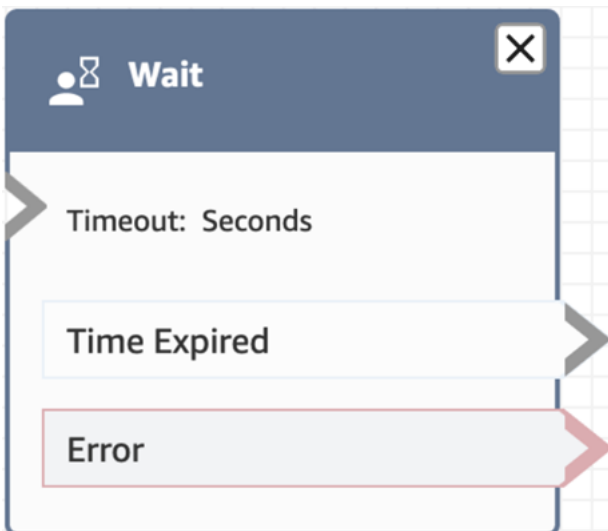

The following image shows an example of what this block looks like when it is configured with **Participant Type = Bot**. It has the following branches: **Bot participant disconnected**, **Participant not found**, **Time Expired**, and **Error**.

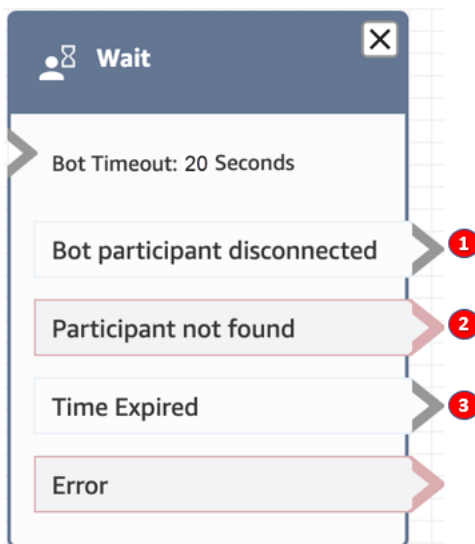

1. **Bot participant disconnected:** The custom participant, such as a third-party bot, has successfully disconnected to the contact.
2. **Participant not found:** No custom participant was found to be associated to the contact.
3. **Time Expired:** The timeout specified has lapsed before the custom participant disconnected.

Sample flows

Amazon Connect includes a set of sample flows. For instructions that explain how to access the sample flows in the flow designer, see [Sample flows](#). Following are topics that describe the sample flows which include this block.

- [Sample disconnect flow](#)

Scenarios

See these topics for scenarios that use this block:

- [Example chat scenario](#)

Create a flow

The starting point for creating all flows is the flow designer. It's a drag-and-drop work surface that enables you to link together blocks of actions. For example, when a customer first enters your contact center, you can ask for some input and then play a prompt such as "Thank you."

For descriptions of the available flow blocks, see [Flow block definitions](#).

Contents

- [Before you begin: develop a naming convention](#)
- [Choose a flow type](#)
- [Create an inbound flow](#)
- [Tag flows and flow modules](#)
- [Use the mini-map to navigate a flow](#)
- [Customize the name of a block](#)
- [Undo and redo actions in the flow designer](#)
- [Add notes to a block](#)
- [Copy and paste flows](#)
- [Archive, delete, and restore flows](#)
- [Generate logs](#)
- [Flow version control: Roll back a flow](#)
- [Contact initiation methods and flow types](#)

Before you begin: develop a naming convention

Chances are you're going to create tens or hundreds of flows. To help you stay organized, it's important to develop a naming convention. After you start creating flows, we strongly recommend against renaming them.

Choose a flow type

Amazon Connect includes a set of nine flow types. **Each type has only those blocks for a specific scenario.** For example, the flow type for transferring to a queue contains only the appropriate flow blocks for that type of flow.

Important

- When you create a flow, you need to choose the right type for your scenario. Otherwise, the blocks you need may not be available.

- You can't import flows of different types. This means if you start with one type and need to switch to another to get the right blocks, you have to start over.

The following flow types are available.

Type	When to use
<p>Inbound flow</p>	<p>This is the generic flow type that's created when you choose the Create flow button, and don't select a type using the drop-down arrow. It creates an inbound flow.</p> <p>This flow works with voice, chat, and tasks.</p>
<p>Customer queue flow</p>	<p>Use to manage what the customer experiences while in queue, before being joined to an agent. Customer queue flows are interruptible and can include actions such as an audio clip apologizing for a delay and offering an option to receive a callback, leveraging the Transfer to queue block.</p> <p>This flow works with voice, chat, and tasks.</p>
<p>Customer hold flow</p>	<p>Use to manage what the customer experiences while the customer is on hold. With this flow, one or more audio prompts can be played to a customer using the Loop prompts block while waiting on hold.</p> <p>This flow works with voice.</p>
<p>Customer whisper flow</p>	<p>Use to manage what the customer experiences as part of an inbound call immediately before being joined with an agent. The agent and customer whispers are played to completion, then the two are joined.</p>

Type	When to use
<p>Outbound whisper flow</p>	<p>This contact flow works with voice and chat.</p> <p>Use to manage what the customer experiences as part of an outbound call before being connected with an agent. In this flow, the customer whisper is played to completion, then the two are joined. For example, this flow can be used to enable call recordings for outbound calls with the Set recording behavior block.</p> <p>This contact flow works with voice and chat.</p>
<p>Agent hold flow</p>	<p>Use to manage what the agent experiences when on hold with a customer. With this flow, one or more audio prompts can be played to an agent using the Loop prompts block while the customer is on hold.</p> <p>This flow works with voice.</p>
<p>Agent whisper flow</p>	<p>Use to manage what the agent experiences as part of an inbound call immediately before being joined with a customer. The agent and customer whispers are played to completion, then the two are joined.</p> <p>This flow works with voice, chat, and tasks.</p>

Type	When to use
Transfer to agent flow	<p>Use to manage what the agent experiences when transferring to another agent. This type of flow is associated with transfer to agent quick connects, and often plays messaging, then completes the transfer using the Transfer to agent block.</p> <p>This flow works with voice, chat, and tasks.</p> <div data-bbox="829 621 1507 1125" style="border: 1px solid #f08080; padding: 10px;"><p>⚠ Important</p><p>Do not place any sensitive information in this flow. When a cold transfer occurs, the transferring agent disconnects before transfer is completed, and this flow is run on the caller. This means information in the flow is played to the caller, not the agent.</p></div>
Transfer to queue flow	<p>Use to manage what the agent experiences when transferring to another queue. This type of flow is associated with transfer to queue quick connects, and often plays messaging, then completes the transfer using the Transfer to queue block.</p> <p>This flow works with voice, chat, and tasks.</p>

Create an inbound flow

Use these steps to create an inbound flow.

1. In the left navigation menu, choose **Routing, Flows**.

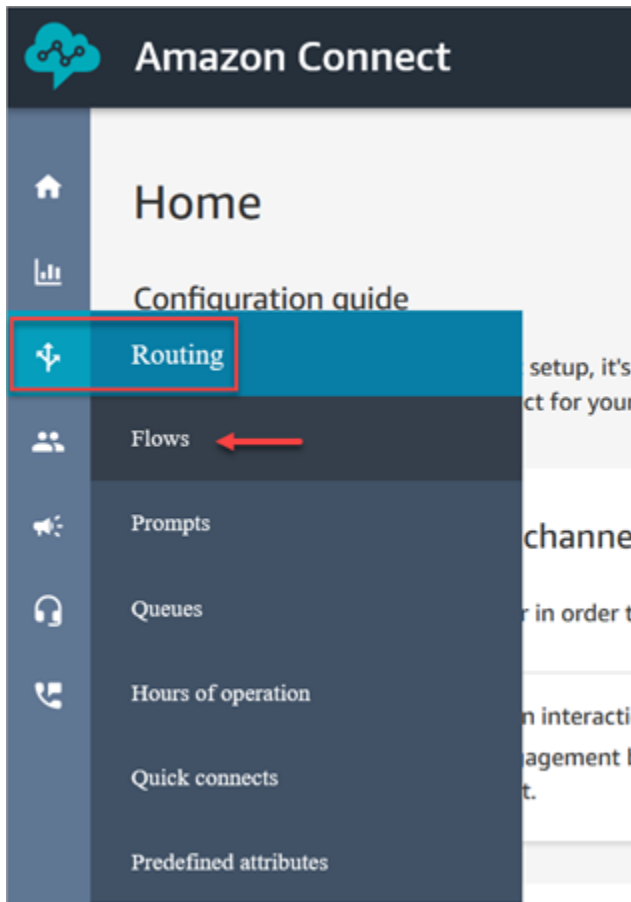

2. Choose **Create flow**. This opens the flow designer and creates an inbound flow (Type = Flow).
3. Type a name and a description for your flow.
4. Search for a flow block using the **Search** bar, or expand the relevant group to locate the block. For descriptions of the flow blocks, see [Flow block definitions](#).
5. Drag and drop contact blocks onto the canvas. You can add blocks in any order or sequence, as connections between elements aren't required to be strictly linear.

Tip

You can move blocks around the canvas so the layout aligns to your preferences. To select multiple blocks at the same time, press the **Ctrl** key on your laptop (or the **Cmd** key on a Mac), choose the blocks you want, and then use your mouse to drag them as a group within the flow. You can also use the **Ctrl/Cmd** key to start at one point on the canvas and drag your pointer across the canvas to select all blocks included in the frame.

6. Double-click the title of the block. In the configuration pane, configure settings for that block and then choose **Save** to close the pane.
7. Back on the canvas, click on the first (the originating) block.
8. Choose the circle for the action to perform, such as Success.
9. Drag the arrow to the connector of the group that performs the next action. For groups that support multiple branches, drag the connector to the appropriate action.
10. Repeat the steps to create a flow that meets your requirements.
11. Choose **Save** to save a draft of the flow. Choose **Publish** to activate the flow immediately.

 **Note**

All connectors must be connected to a block in order to successfully publish your flow.

Tag flows and flow modules

You can add resource tags to your flows and flow modules. Use the following steps to add a resource tag from the flow designer.

1. Open the tag section on flow designer page for a chosen flow or flow module.

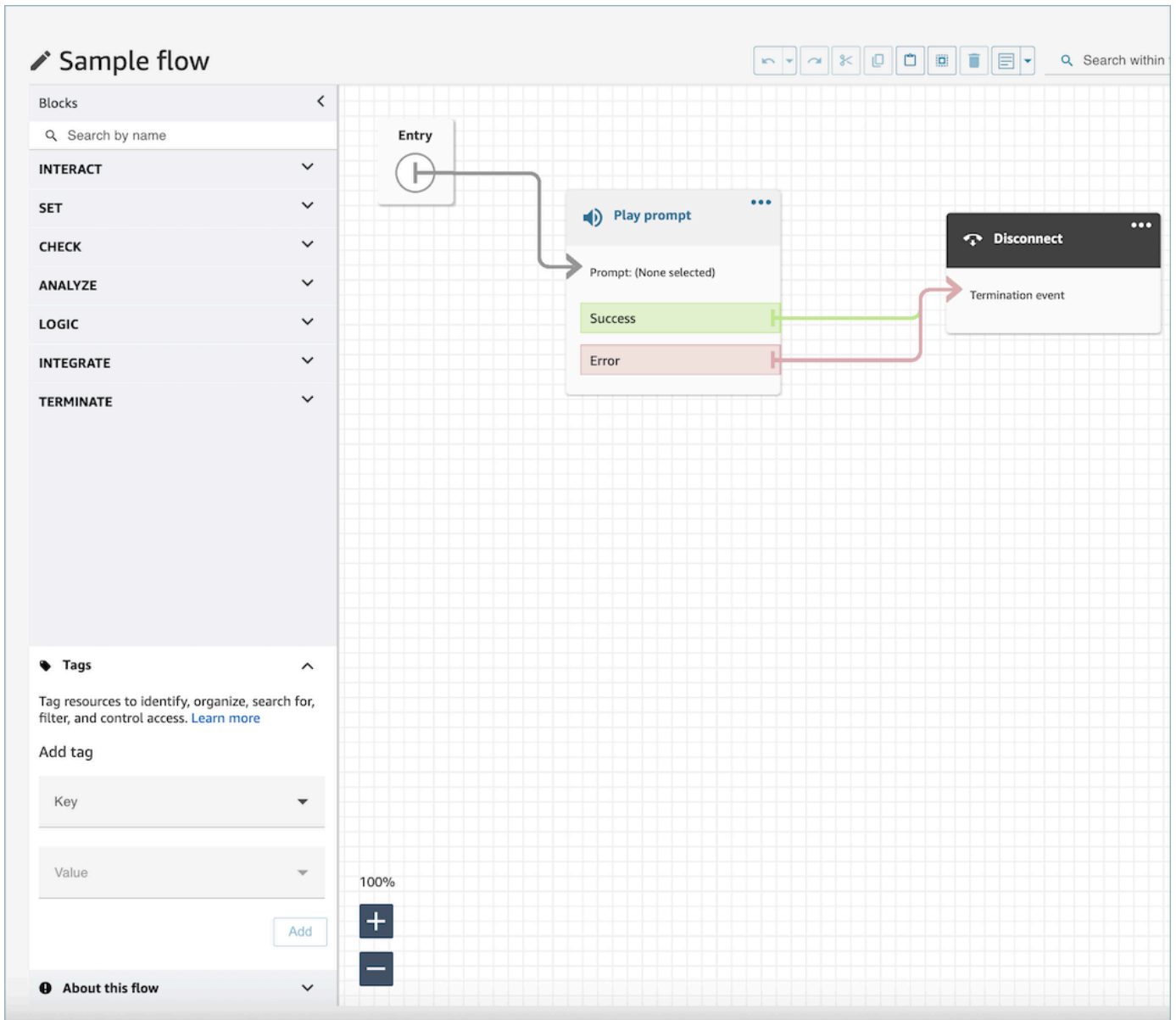

2. Enter a **Key** and **Value** combination to tag the resource.

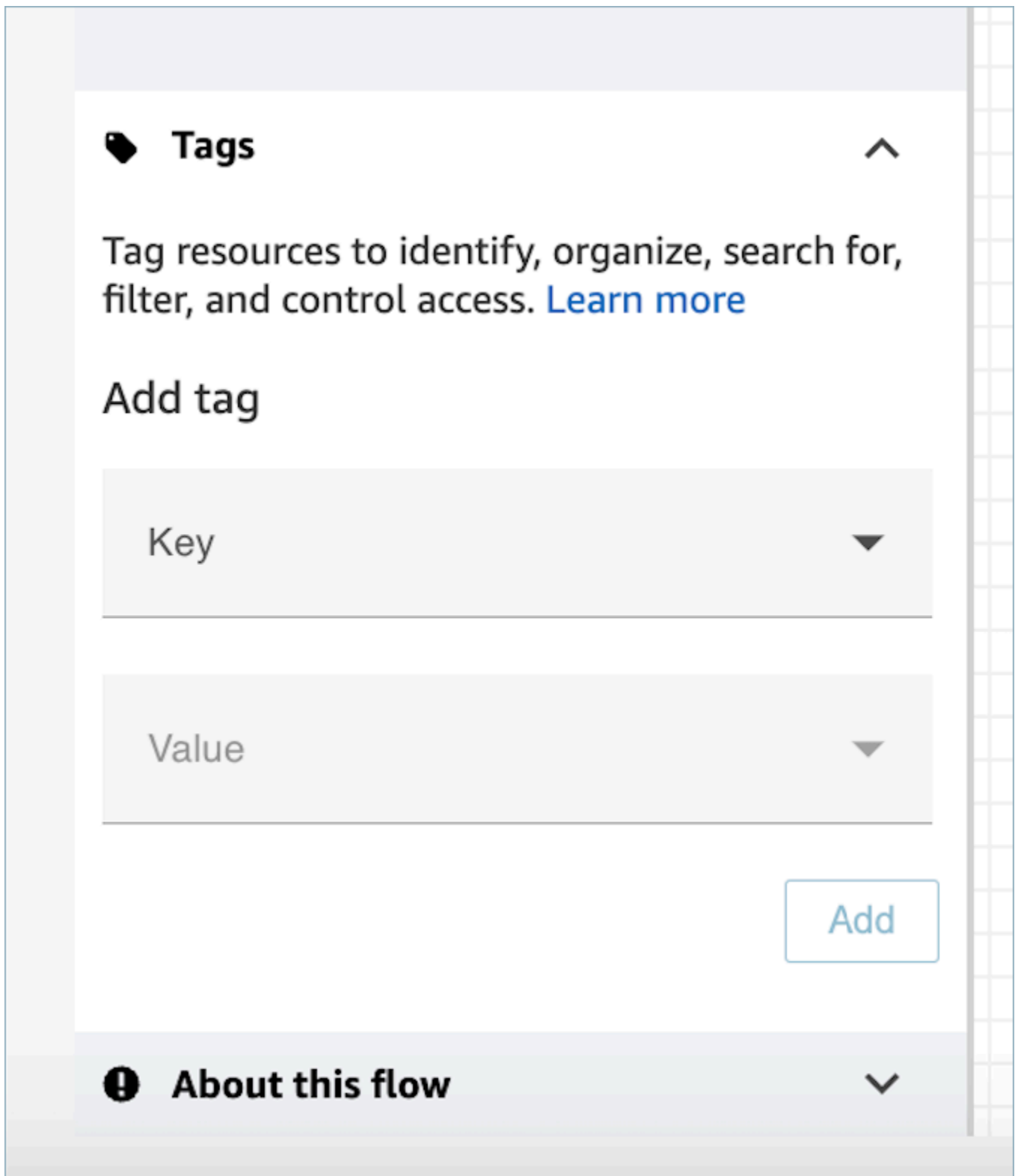

Tags ^

Tag resources to identify, organize, search for, filter, and control access. [Learn more](#)

Add tag

Key ▼

Value ▼

Add

! **About this flow** ▼

3. Choose **Add**. Tags are not persisted until you save or publish the flow.

For more information, see [Tag-based access control](#)

Use the mini-map to navigate a flow

In the lower left corner of the flow designer, there's a miniaturized view of the entire flow. Use this view to help you easily navigate the flow. The drag-to-move mini-map has visual highlights that enable you to quickly move to any point in the flow.

The following image shows the location of the mini-map in the flow designer. The arrow points to the toggle that you use to hide or show the mini-map.

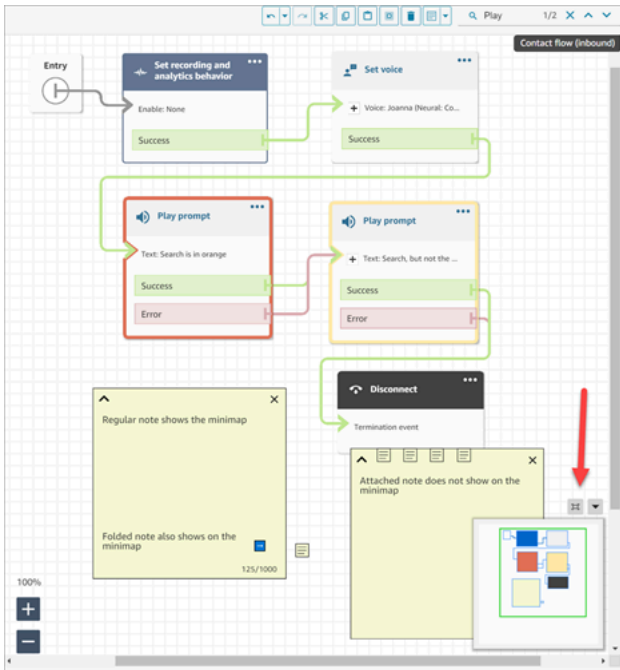

The following GIF shows an example of how you can use the mini-map to navigate a large flow. Click or tap the mini-map to move the view to the desired location on the flow designer.

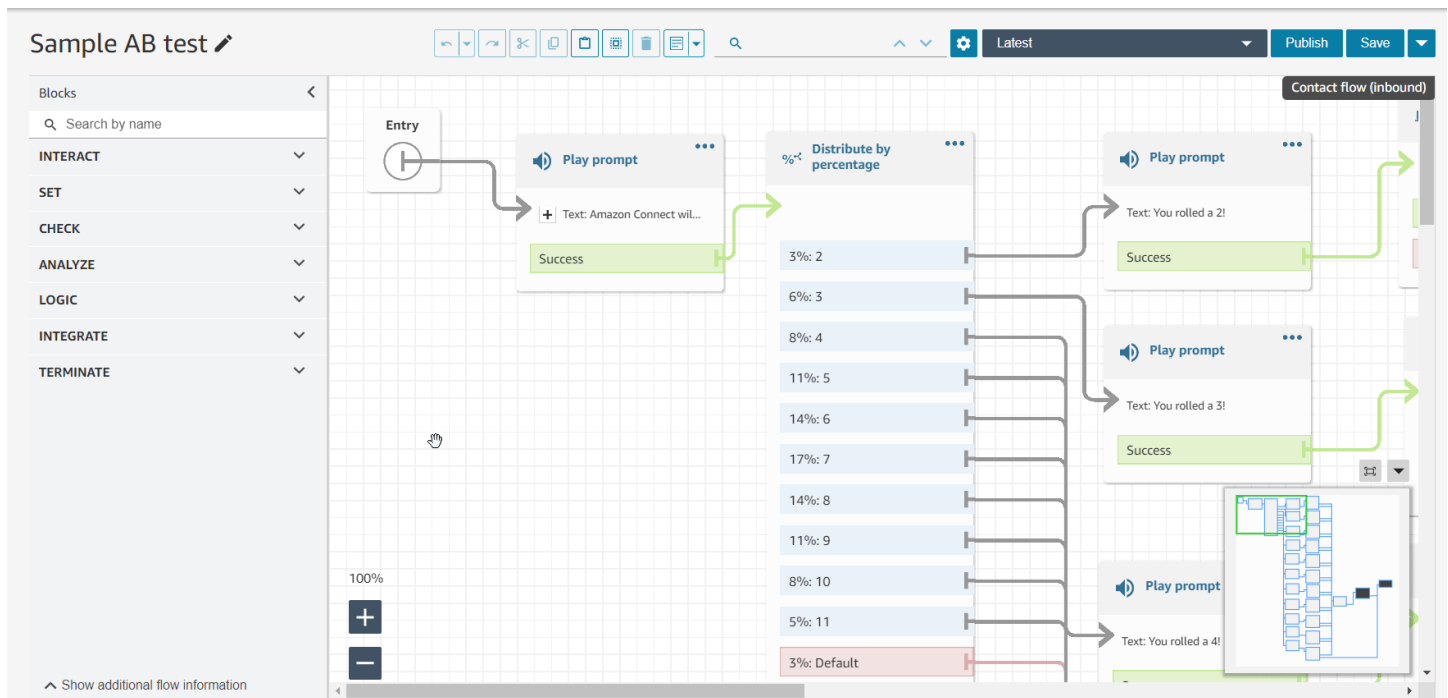

Note the following functionality:

- It shows your current view in green outline.
- It highlights selected blocks in blue, notes in yellow, search results in orange, and termination blocks in black.
- It allows continuous movement of the view when you drag on the mini-map.
- It returns the view to the **Entry** block and trims unused space when you choose **Reset**.

Customize the name of a block

To help you distinguish blocks in a flow, you can customize the names of blocks. For example, when there are multiple **Play prompt** blocks, and you want to distinguish between them at a glance you can assign each block their own name.

Custom flow block names appear in CloudWatch logs under the `Identifier` field. This makes it easier for you to review the logs to diagnose issues.

⚠ Important

- The following characters are not allowed in the block name or `Identifier` field: (% : (\ /) = \$, ; [] { })

- The following strings are not allowed in the block name or `Identifier` field: `__proto__`, `constructor`, `__defineGetter__`, `__defineSetter__`, `toString`, `hasOwnProperty`, `isPrototypeOf`, `propertyIsEnumerable`, `toLocaleString`, and `valueOf`.

There are two ways you can specify a custom block name:

- On the block, choose `...`, and then choose **Add block name**, as shown in the following GIF.

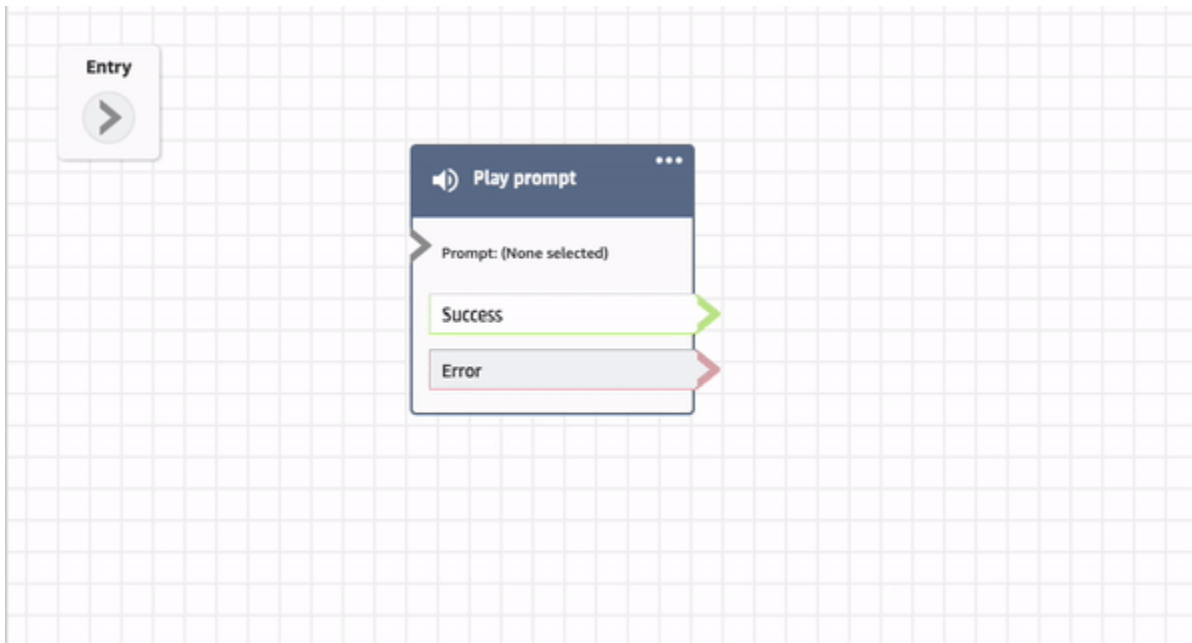

- You can also customize the name of the block on the **Property** page, as shown in the following GIF.

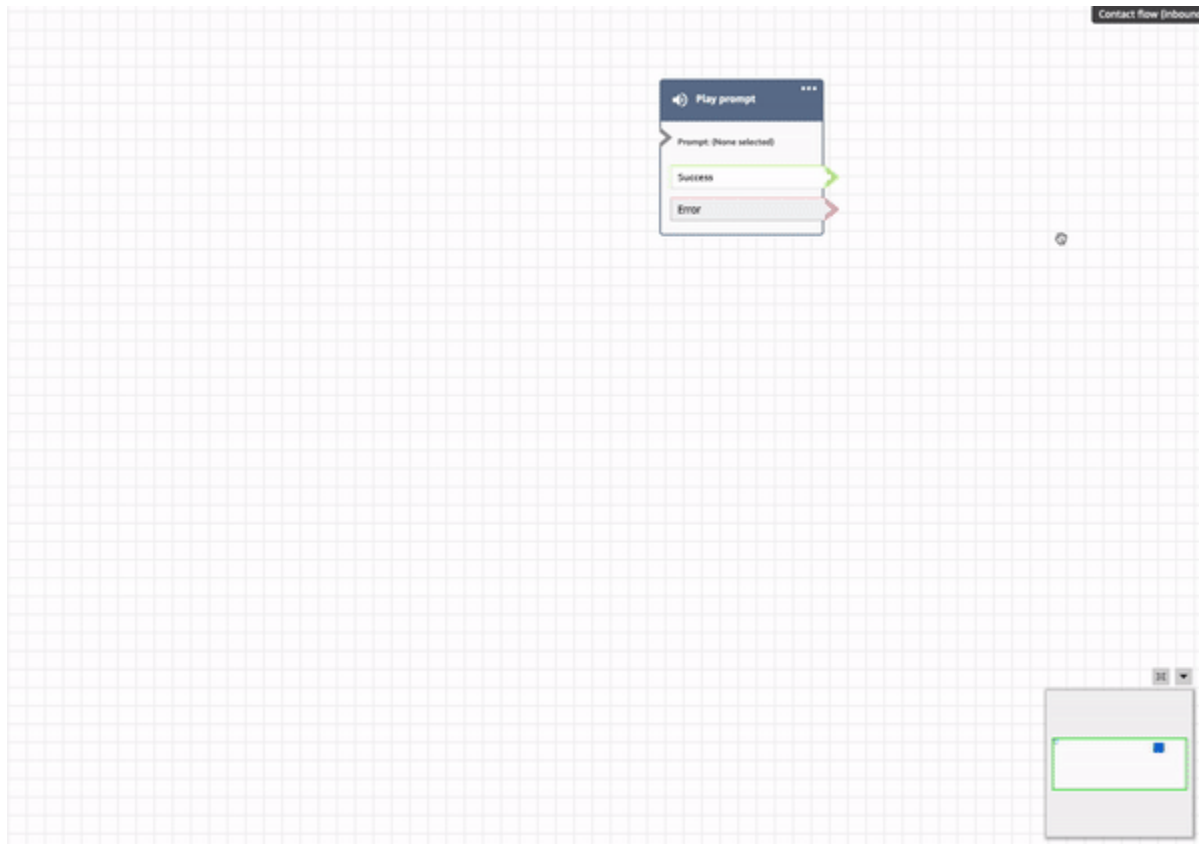

Undo and redo actions in the flow designer

You can undo and redo actions in the flow designer. Choose the undo and redo items on the toolbar. Or, with your cursor on the flow designer canvas, use the shortcut keys: Ctrl+Z to undo, Ctrl+Y to redo.

Tip

On a Mac, Ctrl+Y opens the history page instead of performing a redo.

To access a history of your actions that you can undo, choose the **Undo** dropdown button on the toolbar, as shown in the following image.

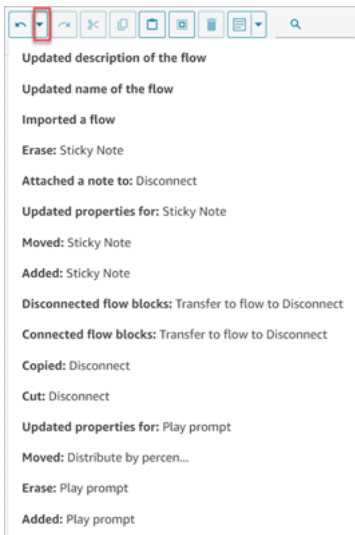

Limits

Action	Limit
History limit	Up to 100 actions can be undone.
Dragging unconnected connector	This action cannot be undone.
Folding of notes	This action cannot be undone.
Page reload	The undo history is not retained after a page is reloaded.

Add notes to a block

To add notes to a block, on the toolbar choose **Annotation**. Or, with your cursor on the flow designer canvas, use the shortcut keys: Ctrl + Alt + N. A yellow box opens for you to type up to 1000 characters. This enables you to leave comments that others can view.

The following image shows the flow designer toolbar, the annotation box, and an annotation that is attached to a block.

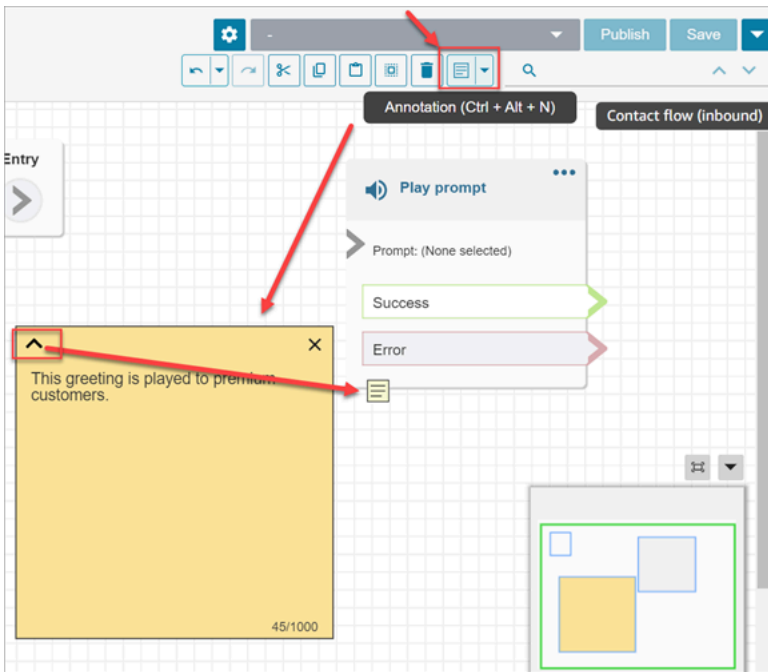

The following GIF shows how to move notes around the flow designer and attach them to a block.

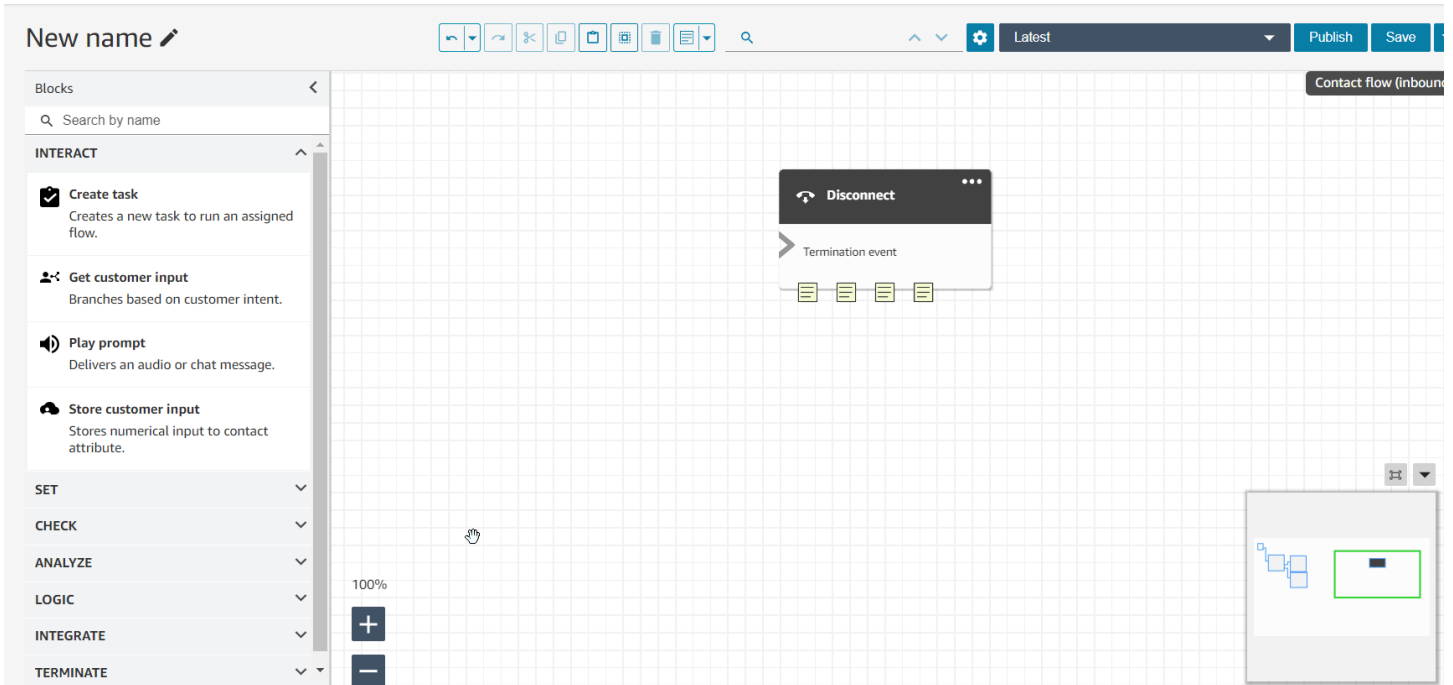

The following image shows the dropdown menu that allows you to view a list of all the notes in a flow. Choose a note to navigate to it. Use the search box to search notes across the flow.

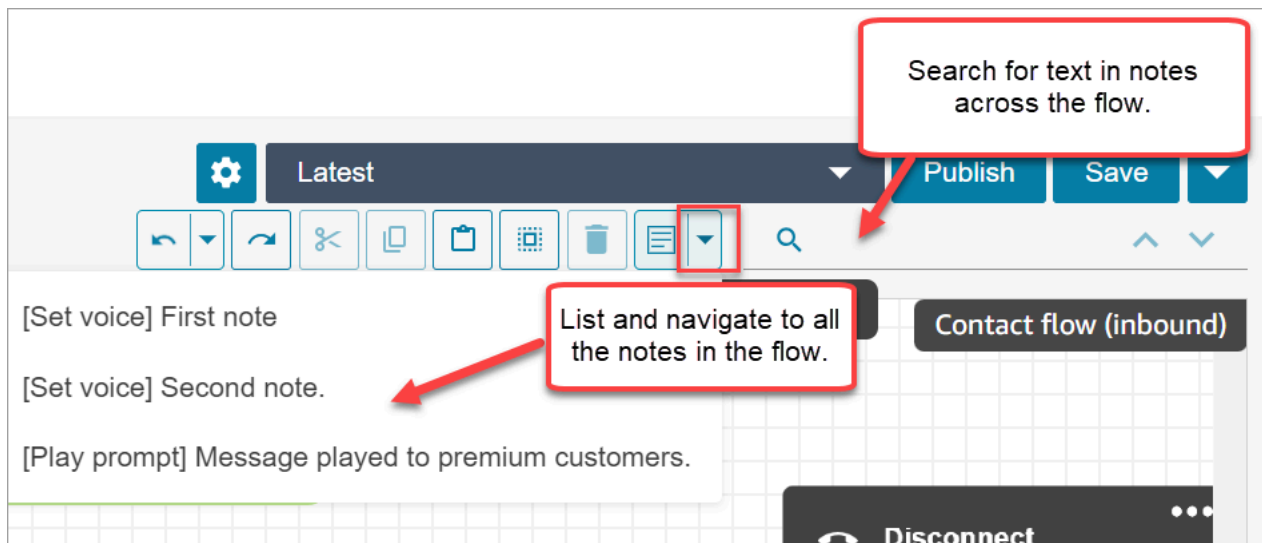

Note the following functionality:

- Unicode and emojis are supported.
- You can copy and paste, undo, and redo into the note box.
- You can search notes across the flow.
- When a block is deleted, the notes are deleted. When a block is restored, the notes are restored.

Limits

Item	Limit
Character limit	1000 characters per note
Attachment limit	5 notes per block
Note limit	100 notes per flow

Copy and paste flows

You can select, cut, copy, and paste a complete flow or multiple blocks within or across flows. The following information is copied:

- All configured settings in the selected flow blocks.
- The layout arrangements.

- The connections.

The following image shows the copy item on the flow designer toolbar.

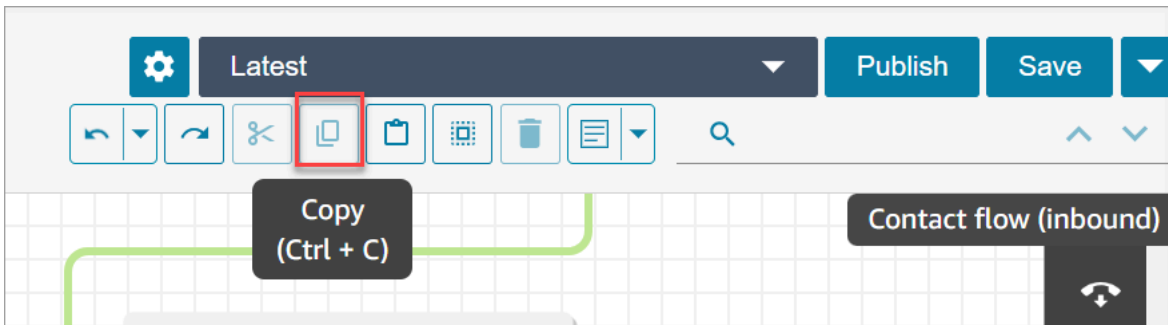

Or, if desired, use the shortcut keys.

Windows: CTRL+C to copy, CTRL+V to paste, and CTRL+X to cut

1. To select multiple blocks at the same time, press the **Ctrl** key, and choose the blocks you want.
2. With your cursor on the flow designer canvas, press **Ctrl+C** to copy the blocks.
3. Press **CTRL+V** to paste the blocks.

Mac: Cmd+C to copy, Cmd+V to paste, and Cmd+X to cut

1. To select multiple blocks at the same time, press the **Cmd** key, and choose the blocks you want.
2. Press **Cmd+C** to copy the blocks.
3. Press **Cmd+V** to paste the blocks.

Tip

Amazon Connect uses the clipboard for this feature. Paste won't work if you edit the JSON in your clipboard and introduce a typo or other error, or if you have multiple items saved to your clipboard.

Archive, delete, and restore flows

Flows and modules must be archived before you can delete them from your Amazon Connect instance. Archived flows and modules can be restored.

Warning

Deleted flows and modules cannot be restored. They are permanently deleted from your Amazon Connect instance.

Important things to know

- **Use caution when archiving flows or modules.** Amazon Connect does not validate whether the flow or module you are archiving is being used in other published flows. It does not warn you that the flow is in use.
- Default flows cannot be archived or deleted. If you attempt to archive a default flow, you'll get message similar to the following image.

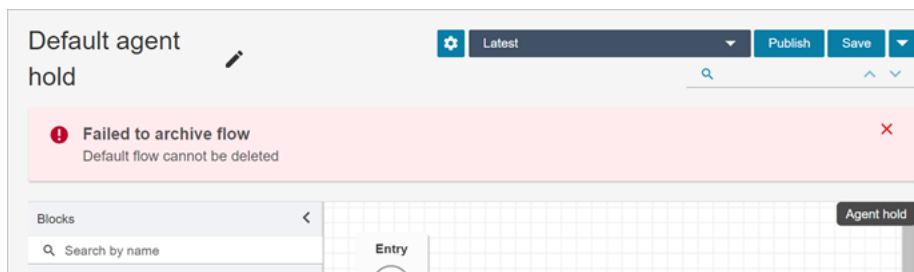

- Flows and modules that are associated with queues, quick connects, or phone numbers cannot be archived. You need to disassociate the resources from the flows before you can archive them.
- Archived flows and modules count towards your **Flows per instance** and **Modules per instance** service quotas. You must delete them to not have them counted. For more information about quotas, see [Amazon Connect service quotas](#).

Archive a flow or module

There are two ways you can archive flows or modules.

Option 1: Open the flow or module and then archive it

1. Log in to Amazon Connect with a user account that has the **Numbers and flows - Flows - Edit** permission in its security profile. If you are archiving a flow module, you need **Flow modules - Edit** permission.
2. On the navigation menu, choose **Routing, Flows**.
3. Open the flow or module you want to archive.
4. On the flow designer page, choose the dropdown menu, and then choose **Archive**, as shown in the following image.

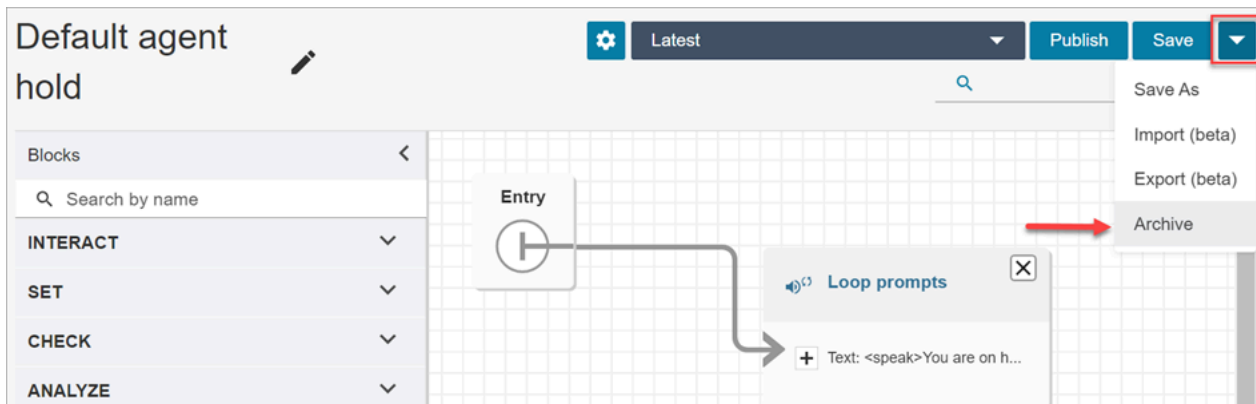

5. Confirm you want to archive the flow or module.
6. To locate the archived flow or module, choose **View archive**.

Option 2: Search for flow or module and then archive it

- On the **Flows** page, search for the flow or module you want archive, and then choose **Archive** from the ... menu, as shown in the following image.

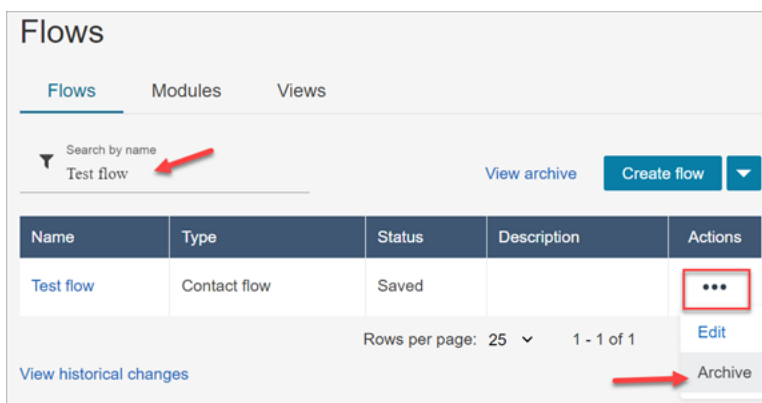

Restore an archived flow or module

There are two ways you can restore flows or modules.

Option 1: View list of archived flows or modules, and choose Restore

1. Log in to the Amazon Connect admin website with a user account that has the **Numbers and flows - Flows - Edit** permission in its security profile. If you are restoring a flow module, you need **Flow modules - Edit** permission.
2. On the navigation menu, choose **Routing, Flows**.
3. On the **Flows** page, choose **View archive**.
 - To restore archived modules, on the **Flows** page, choose the **Modules** tab, and then choose **View archive**.
4. On the **Flows Archive** page, next to the flow or module you want to restore, under **Actions**, choose ... and then choose **Restore**. This option is shown in the following image.

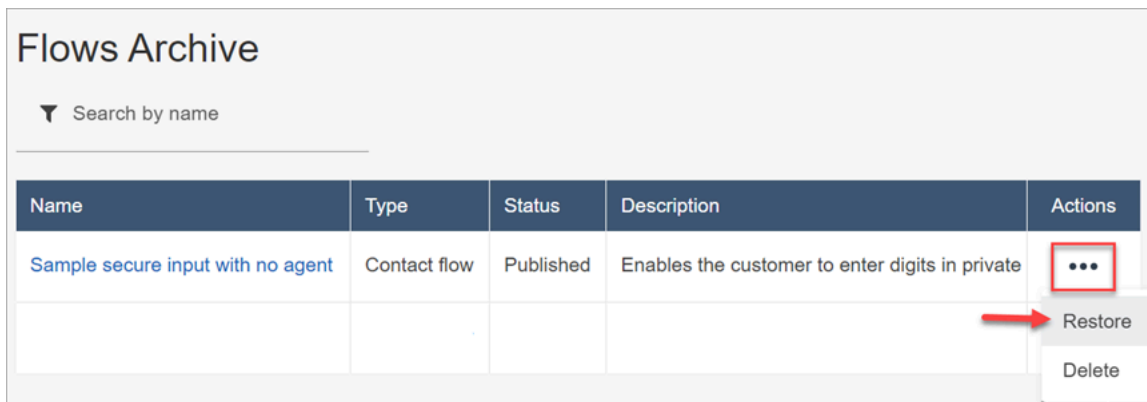

Option 2: Restore the archived flow or module from the flow designer

1. Open the archived flow or module in the flow designer.
2. From the dropdown menu, choose **Restore**, as shown in the following image.

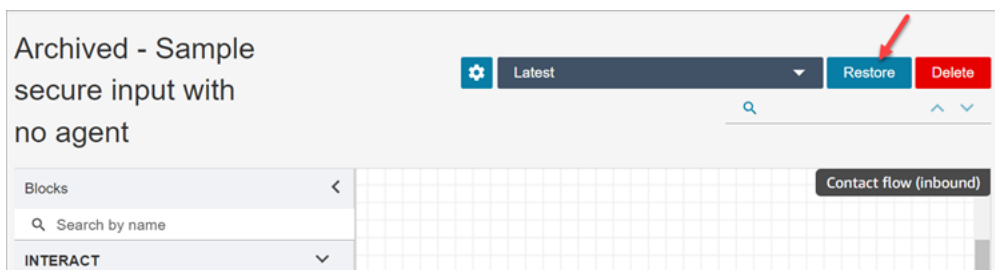

Delete an archived flow or module

You can delete archived flows and modules manually by using the Amazon Connect admin website, or programmatically by using the [DeleteContactFlow](#) API.

Warning

Deleted flows and modules cannot be restored. They are permanently deleted from your Amazon Connect instance.

Option 1: View list of archived flows or modules, and choose Delete

1. Log in to the Amazon Connect admin website with a user account that has the **Numbers and flows - Flows - Remove** permission in its security profile. If you are deleting a flow module, you need **Flow modules - Remove** permission.
2. On the navigation menu, choose **Routing, Flows**.
3. On the **Flows** page, choose **View archive**.
 - To delete modules, on the **Flows** page, choose the **Modules** tab, and then choose **View archive**.
4. On the **Flows Archive** page, next to the flow or module you want to delete, under **Actions**, choose ... and then choose **Delete**.
5. Confirm that you want to delete the flow or module.

Option 2: Delete the archived flow or module from the flow designer

1. Open the archived flow or module in the flow designer.
2. From the dropdown menu, choose **Delete**.
3. Confirm that you want to delete the flow or module.

Generate logs

After your flow is published live, you can use flow logs to help analyze flows and quickly find errors your customers encounter. If needed, you can roll back to a previous version of the flow.

For more information about using flow logs, see [Track events as customers interact with flows](#).

Flow version control: Roll back a flow

View a previous version of a flow

This procedure is especially useful if you want to research how a flow has been changed over time.

1. In the flow designer, open the flow you want to view.
2. Choose the **Latest: Published** dropdown to view a list of previously published versions of the flow.

For default flows that are provided with your Amazon Connect instance, the oldest flow in the list is the original version. The date matches when your Amazon Connect instance was created. For example, in the following image, the original default flow is dated 07/21/22.

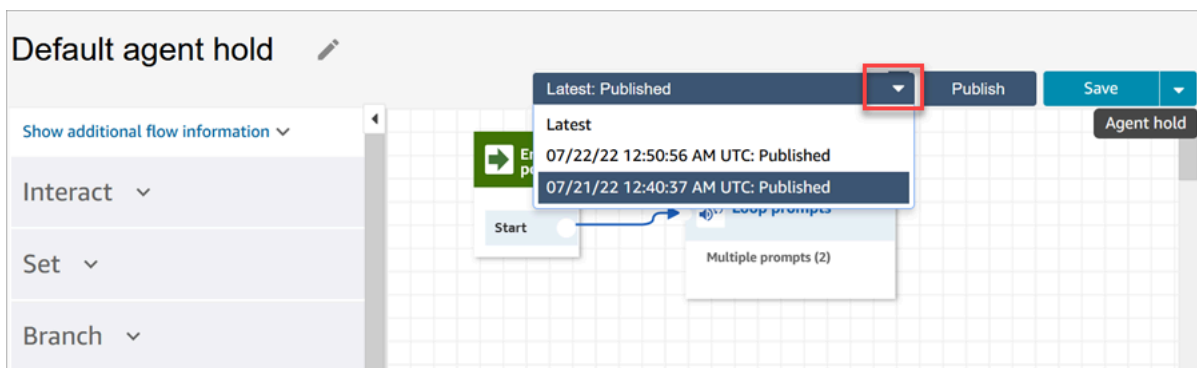

Note

For users with tag-based access controls configured on their security profile, the dropdown will be restricted to **Latest: Published** and **Latest: Saved** versions. To learn more about tag-based access controls in Amazon Connect, see [Tag-based access control](#).

3. Choose the version of the flow to open and view it. You can view all the blocks and how they are configured.
4. Next, you can do one of the following:
 - To return to the most recently published version, choose it from the **Latest: Published** dropdown list.
 - Make changes to the previous version and choose **Save as** from the dropdown to save it with a new name. Or choose **Save** from the dropdown to assign the same name.

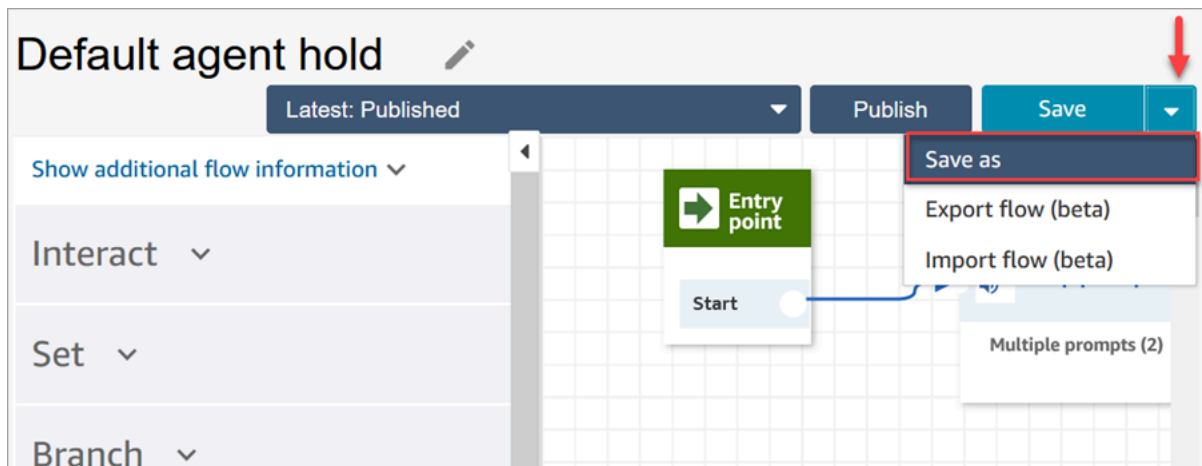

- Or, choose **Publish** to return the previous version to production.

Roll back a flow

1. In the flow designer, open the flow you want to roll back.
2. Use the drop-down to choose the version of the flow you want to roll back to. If you choose **Latest**, it reverts the flow to the most recent published version. If there isn't a published version, it reverts to the most recent saved version.

Note

To see a consolidated view of all changes across all flows, click the **View historical changes** link at the bottom of the **Flows** page. You can filter to a specific flow by date or user name.

3. Choose **Publish** to push that version into production.

Contact initiation methods and flow types

Every contact in your Amazon Connect contact center is initiated by one of the following methods:

- Inbound
- Outbound
- Transfer
- Callback
- API

- Queue_Transfer
- Disconnect

You can create flows appropriate for a given initiation method when you know which [types of flows](#) the initiation method uses.

For each initiation method, this topic explains which types of flows are run.

Inbound

The customer initiated a voice (phone) contact with your contact center.

- When the contact successfully connects with the phone number of your contact center, an [Inbound flow](#) is presented to caller.
- During the transition in the **Inbound flow**, if the customer is put in a queue, a [Customer queue flow](#) is played to customer.
- After the agent becomes available to handle the caller and accept the contact, a [Agent whisper flow](#) is played to the agent.
- After a [Agent whisper flow](#) completes, a [Customer whisper flow](#) is played to customer.
- After the both whisper flows are played successfully to the agent and the customer respectively, the caller gets connected to agent for interaction.

To summarize, for a simple inbound call, the following flow types are played before caller is connected to agent:

1. **Inbound flow**
2. **Customer queue flow**
3. **Agent whisper flow**
4. **Customer whisper flow**

Outbound

An agent initiated voice (phone) contact to an external number, by using their CCP to make the call.

- As soon as the destination party picks the call, they are presented with an [Outbound whisper flow](#).

- After an **Outbound whisper flow** successfully completes, the agent and the contact are connected for interaction.

To summarize, an **Outbound flow** type is the only one involved in an outbound call initiated from Amazon Connect.

Transfer

The contact was transferred by an agent to another agent or to a queue, using quick connects in the CCP. This results in a new contact record being created.

Before the agent transfers the contact to another agent or queue, all the flows involved in an INBOUND contact are run.

- Agent to Agent transfer using Agent Quick Connect
 - After the agent transfers the inbound contact to another agent:
 - A [Agent transfer flow](#) is played to the source agent.
 - After the destination agent accepts the call, a [Agent whisper flow](#) is played to destination agent, and then a [Customer whisper flow](#) is played to source agent.
 - After all three flows are successfully run, the interaction begins between the source and destination agents.
 - During this whole process, the inbound caller is on hold and a [Customer hold flow](#) is played to the inbound caller during hold time.

After the source agent is connected with destination agent, the source agent can do one of the following actions:

- Choose **Join**. This joins all parties on the call: source agent, destination agent, and the customer are joined in a conference call.
- Choose **Hold all**. This puts the destination agent and the customer on hold.
- Put destination agent on hold, so only the source agent can talk to the customer.
- Choose **End call**. The source agent leaves the call but the destination agent and the customer are directly connected and continue talking.

To summarize for an agent to agent transfer call, the following flow types are run:

1. Agent transfer flow

2. Agent whisper flow (played to the destination agent)

3. **Customer whisper flow** (played to the source agent) during whole this process
 4. **Customer hold flow** played to the original caller
- Agent to Queue transfer using Queue Quick Connect
 - After the agent transfers the inbound call to another queue:
 - A [Queue transfer flow](#) is played to source agent.
 - After the agent from the transferred queue accepts the call, an [Agent whisper flow](#) is played to destination agent, and then a [Customer whisper flow](#) is played to source agent.
 - After these flows run, the source and destination agent interaction begins.
 - During this whole process, the inbound caller is on hold. A [Customer hold flow](#) is played to the inbound caller during the hold time.

After the source agent is connected with destination agent, the source agent can do one of the following:

- Choose **Join**. This joins all parties on the call: source agent, destination agent, and the customer are joined in a conference call.
- Choose **Hold all**. This puts destination agent and the customer on hold.
- Put destination agent on hold, so only the source agent can talk to the customer.
- Choose **End call**. The source agent leaves the call but the destination agent and the customer are directly connected and continue talking.

To summarize for agent to queue transfer call, the following flows are played:

1. **Queue transfer flow**
2. **Agent whisper flow** (played to the destination agent)
3. **Customer whisper flow** (played to the source agent) during whole this process
4. **Customer hold flow** played to the original caller

Callback

The customer is contacted as part of a callback flow.

- As soon as agent accepts the callback contact, an [Agent whisper flow](#) is played to the agent.
- After the customer accepts the callback call, an [Outbound whisper flow](#) is played to customer.
- After these two flows are played, the agent and customer are connected and can interact.

To summarize, for callback contacts, the following flow types are played:

- **Agent whisper flow**
- **Outbound whisper flow**

API

The contact was initiated with Amazon Connect by API. This could be:

1. An outbound contact you created and queued to an agent using the [StartOutboundVoiceContact](#) API.
2. A live chat that was initiated by the customer with your contact center where you called the [StartChatContact](#) API.
3. A task that was initiated by calling the [StartTaskContact](#) API.

Following is an example of an API initiated contact method:

- After the outbound contact is successfully initiated using the [StartOutboundVoiceContact](#) API, an [Inbound flow](#) provided in the API request is played to the customer.
- Depending on the configuration of the [Inbound flow](#), additional flows are played. For example, an [Inbound flow](#) transfers a customer to an agent for conversation. In this case, a [Customer queue flow](#) is played to customer while they waiting in queue for an agent.
- When the available agent accepts the call, an [Agent whisper flow](#) is played to agent.
- A [Customer whisper flow](#) is played to customer.
- After both whisper flows are played successfully to the agent and customer respectively, the caller is connected to agent for interaction.

To summarize API initiation methods, the following flows are played before the customer is connected to agent:

- **Inbound flow**
- **Customer queue flow**
- **Agent whisper flow**
- **Customer whisper flow**

Queue_Transfer

While the customer was in one queue (listening to a [Customer queue flow](#)), they were transferred into another queue using a flow block.

- The customer who is waiting in the queue for an agent is presented only with a [Customer queue flow](#). No additional flows are involved.

Disconnect

When a [Set disconnect flow](#) block runs, it specifies which flow to run after a disconnect event during a contact.

- You can specify only an [Inbound contact flow](#) in this block. Since it occurs after the disconnect event, no additional flow is presented to customer.

Override the default contact flows

For all of the initiation methods discussed in this topic, if you don't specify flows for **Agent whisper flow**, **Customer whisper flow**, **Customer queue flow**, or **Outbound whisper flow**, then the default flow of that type runs instead. For a list of default flows, see [Default flows](#).

To override the defaults and use your own flows, use the following blocks:

- [Set customer queue flow](#)
- [Set hold flow](#)
- [Set whisper flow](#)

For more information, see [Default flows](#).

Attach a claimed or ported phone number to a flow

After you publish a flow, you can attach a [claimed](#) or [ported](#) phone number to it. When a contact calls the phone number that you associate with a flow, they are connected to that flow.

To associate a claimed or ported phone number with a published flow

1. Log in to your Amazon Connect instance (https://instance_name.my.connect.aws/) with an Admin account or a user account that has **Phone number - Edit** permissions in its [security profile](#). (To find the name of your instance, see [Find your Amazon Connect instance ID/ARN](#).)
2. On the navigation menu, choose **Channels, Phone numbers**.
3. Locate the phone number to associate with the flow in the list. Click the phone number to open the **Edit Phone number** page. The following image shows a sample phone number that you would click.



4. On the **Edit Phone number** page, do the following:
 - a. (Optional) Edit the description for the phone number.
 - b. For **Flow / IVR**, select the flow. Note that only published flows are included in this list.
 - c. Choose **Save**.

Flow modules for reusable functions

Flow modules are reusable sections of a flow. You can create them to extract repeatable logic across your flows, and create common functions. For example:

1. You can create a module that sends SMS text messages to customers.
2. You can invoke the module in flows that handle situations where customers want to reset their passwords, check their bank balances, or receive a one-time password.

Following are the benefits of using modules:

- Simplify managing common functionality across flows. For example, an SMS module could validate the format of phone number, confirm SMS opt-in preferences, and integrate with an SMS service, such as Amazon Pinpoint.

- Makes it more efficient to maintain flows. For example, you can quickly propagate changes across all flows that invoke a flow module.
- Helps separate flow designer responsibilities. For example, you can have both technical module designers and non-technical flow designers.

Where you can use modules

You can use modules in any flow that is [type](#) **Inbound flow**.

The following types of flows do not support modules: **Customer queue, Customer hold, Customer whisper, Outbound whisper, Agent hold, Agent whisper, Transfer to agent, Transfer to queue.**

Limitations

- Modules do not allow overriding flow local data of the invoking flow. This means you can't use the following with modules:
 - External attributes
 - Amazon Lex attributes
 - Customer Profiles attributes
 - Amazon Q in Connect attributes
 - Queue metrics
 - Stored customer input
- Modules do not allow invoking another module.

To pass any data to a module, or to get any data from a module, you need to pass and retrieve attributes.

For example, you want data that is written from Lambda (an External attribute) and pass it to the module so you can make a decision. Your Lambda identifies whether the customer is a VIP member. You need that information inside the module because if they are a VIP member, you want to play a prompt thanking them for their membership. Since default Lambda is not available inside a module, you use attributes to pass and retrieve data.

Security profile permissions for modules

Before you can add modules to Inbound flows, you must have permissions in your security profile. By default, the **Admin** and **CallCenterManager** security profiles have these permissions.

Create a module

For information about the number of modules that you can create for each Amazon Connect instance, see [Amazon Connect service quotas](#).

1. Log in to the Amazon Connect console with an account assigned to a security profile that has permissions to create modules.
2. On the navigation menu, choose **Routing, Contact flows**.
3. Choose **Modules, Create flow module**.
4. Add the blocks that you want to your module. When finished, choose **Publish**. This makes the module available to use in other flows.

Add a module to a flow

1. Log in to the Amazon Connect console with an account assigned to a security profile that has permissions to create flows. You don't need permissions to create modules.
2. On the navigation menu, choose **Routing, Contact flows**.
3. Choose **Create flow** or select an existing flow that is an **Inbound** type.
4. To add a module, go to the **Integrate** section, and choose **Invoke flow module**.
5. When you're finished creating your flow, choose **Publish**.

Example module

This module shows how to get a random fun fact by invoking a Lambda function. The module uses a contact attribute (`$.Attributes.FunFact`) to retrieve the fun fact. Flows that invoke this module can play a FunFact to customers, depending on their incoming contact type.

The inbound flows in your instance can invoke this common module and get the fun fact.

Following is an image of the FunFact module:

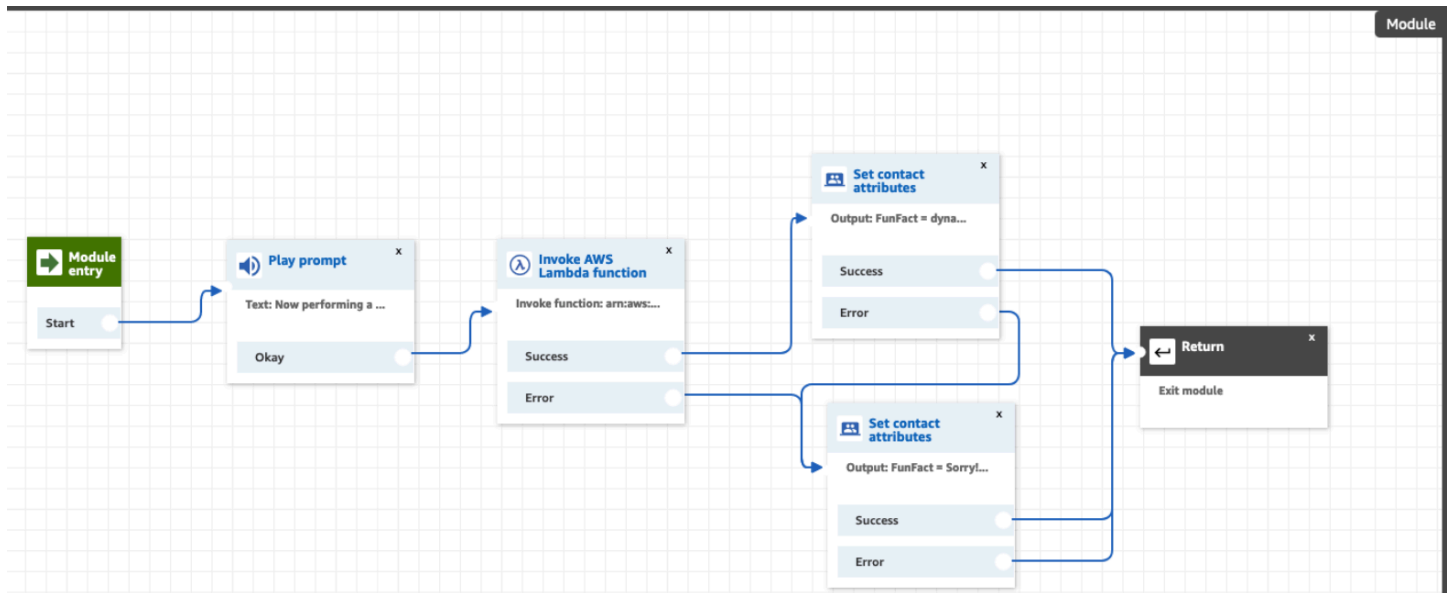

Following is an image of the FunFactSampleFlow that invokes the module:

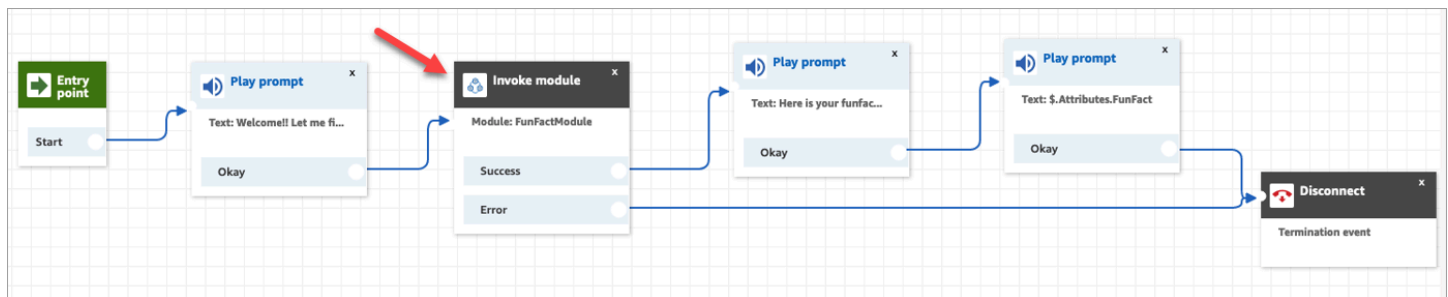

Create prompts

Prompts are audio files played in call flows. For example, hold music is a prompt. Amazon Connect comes with a set of prompts that you can add to your flows. Or, you can add your own recordings.

We recommend that you align your prompts and routing policies with each other to ensure a smooth call flow for customers.

You can create and manage prompts by using the Amazon Connect admin site as described in the topics in this section. Or you can use the [Prompt actions](#) documented in the *Amazon Connect API Reference Guide*.

Contents

- [How to create prompts](#)
- [Supported file types](#)

- [Maximum length for prompts](#)
- [Bulk upload of prompts not supported in UI, API, or CLI](#)
- [Add text-to-speech to prompts](#)
- [Create dynamic text strings in Play prompt block](#)
- [Dynamically select which prompts to play](#)
- [Set up prompts to play from an S3 bucket](#)
- [Choose the voice for audio prompts](#)
- [Use SSML tags to personalize text-to-speech](#)
- [SSML tags aren't interpreted in chats](#)
- [SSML tags supported by Amazon Connect](#)

How to create prompts

This topic explains how to use the Amazon Connect admin website to create prompts. To create prompts programmatically, see [CreatePrompt](#) in the *Amazon Connect API Reference Guide*.

1. Log in to Amazon Connect using an account that has the following security profile permission:
 - **Numbers and flows, Prompts - Create**
2. On the navigation menu, choose **Routing, Prompts**.
3. On the **Prompts** page, choose **Add prompt**.
4. On the **Add Prompt** page, enter a name for the prompt.
5. In the **Description** box, describe the message. We recommend using this box to provide a detailed description of the prompt. It is helpful for accessibility.
6. Choose the following actions:
 - **Upload**—Select **Choose File** to upload a .wav file that you have legal permission to use.
 - **Record**—Choose **Start recording** and speak into your microphone to record a message. Choose **Stop recording** when you're finished. You can choose **Crop** to cut sections of the recorded prompt or choose **Clear recording** to record a new prompt.
7. In the **Prompt Settings** section, enter any tags you want to use to manage the prompt.

For example, you may have a department that manages prompts for greetings. You can tag those prompts so users can focus on only those recordings that pertain to them.

- Optionally, add Tags to identify, organize, search for, filter, and control who can access this hours of operation record. For more information, see [Tag resources in Amazon Connect](#).

Use the filters on the **Prompts** page to filter the list of prompts by **Name**, **Description**, and **Tags**. To copy the full Amazon Resource Name (ARN) of a prompt with just one click, choose the **Copy** icon. When you [set up dynamic prompts in a flow](#), you'll need to enter the full ARN of the prompt.

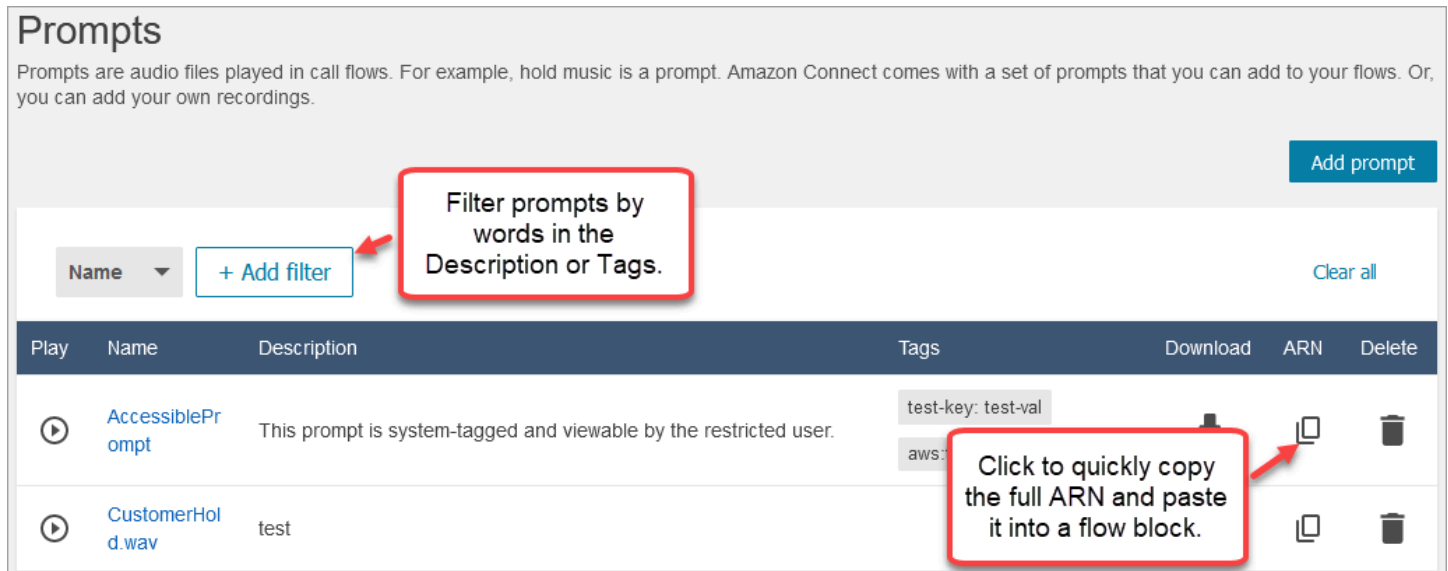

The screenshot shows the 'Prompts' page in the Amazon Connect console. At the top, there's a header 'Prompts' with a sub-header explaining that prompts are audio files. Below this is a filter section with a 'Name' dropdown, a '+ Add filter' button, and a 'Clear all' link. A red box highlights the '+ Add filter' button with the text 'Filter prompts by words in the Description or Tags.' Below the filter section is a table with columns: Play, Name, Description, Tags, Download, ARN, and Delete. The table contains two rows: 'AccessiblePr ompt' and 'CustomerHol d.wav'. A red box highlights the 'Copy' icon (two overlapping documents) in the ARN column of the 'AccessiblePr ompt' row with the text 'Click to quickly copy the full ARN and paste it into a flow block.'

Supported file types

You can upload a pre-recorded .wav file to use for your prompt, or record one in the web application.

We recommend using 8 KHz .wav files that are less than 50 MB and less than 5 minutes long. If you use higher rated audio libraries, such as 16 KHz or 16 bit files, Amazon Connect has to down sample them into 8 KHz samples because of PSTN limitations. This may result in low quality audio. For more information, see the following Wikipedia article: [G.711](#).

Maximum length for prompts

Amazon Connect supports prompts that are less than 50 MB and less than 5 minutes long.

Bulk upload of prompts not supported in UI, API, or CLI

Currently, bulk uploading of prompts is not supported through the Amazon Connect console or programmatically using the API or CLI.

Add text-to-speech to prompts

You can enter text-to-speech prompts in the following flow blocks:

- [Get customer input](#)
- [Loop prompts](#)
- [Play prompt](#)
- [Store customer input](#)

Amazon Polly converts text-to-speech

To convert text-to-speech, Amazon Connect uses Amazon Polly, a service that converts text into lifelike speech using SSML.

Amazon Polly default voices such as Amazon Polly Neural and Standard voices are **free**. You are charged only for using custom voices such as unique [Brand Voices](#) that are associated with your account.

Amazon Polly best sounding voice

Amazon Polly periodically releases improved voices and speaking styles. You can choose to automatically resolve your text-to-speech to the most lifelike and natural sounding variant of a voice. For example, if your flows use Joanna, Amazon Connect automatically resolves to Joanna's conversational speaking style.

Note

If no Neural version is available, Amazon Connect defaults to the standard voice.

To automatically use the best sounding voice

1. Open the Amazon Connect console at <https://console.aws.amazon.com/connect/>.
2. If prompted to login, enter your AWS account credentials.
3. Choose the name of the instance from the **Instance alias** column.

Amazon Connect > Instances

Amazon Connect virtual contact center instances

Instances Refresh Delete Add an instance

Find resources

Instance alias	Access URL	Channels	Create date	Status
mytest67	https://mytest67.my.connect.aws	Inbound, outbound telephony	1/12/2022	Active

4. In the navigation pane, choose **Flows**.
5. In the Amazon Polly section, choose **Use the best available voice**.

How to add text-to-speech

1. In a flow, add the block that will play the prompt. For example, add a [Play prompt](#) block.
2. In the **Properties**, choose **Text-to-speech**.
3. Enter plain text. For example, the following image shows *Thank you for calling*.

Prompt

Select from the prompt library (audio)

Specify an audio file from an S3 bucket

Text-to-speech or chat text

Set manually

Thank you for calling.

Use attribute

Interpret as

Text

Or enter SSML, as shown in the following image:

Delivers an audio or chat message. [Info](#)

Select from the prompt library (audio)

Specify an audio file from an S3 bucket

Text-to-speech or chat text

Set manually

Enter text to be spoken

```
<speaK>Thank you for calling.</speaK>
```

Set dynamically

Interpret as

SSML ▼

SSML-enhanced input text gives you more control over how Amazon Connect generates speech from the text you provide. You can customize and control aspects of speech such as pronunciation, volume, and speed.

For a list of SSML tags you can use with Amazon Connect, see [SSML tags supported by Amazon Connect](#).

For more information about Amazon Polly, see [Using SSML](#) in the Amazon Polly Developer Guide.

Create dynamic text strings in Play prompt block

Use a [Play prompt](#) block to use an audio file to play as a greeting or message to callers. You can also use contact attributes to specify the greeting or message delivered to callers. To use the values of a contact attribute to personalize a message for a customer, include references to stored or external contact attributes in the text-to-speech message.

For example, if you retrieved the customer's name from a Lambda function, and it returns values from your customer database for `FirstName` and `LastName`, you could use these attributes to say the customer's name in the text-to-speech block by including text similar to the following:

- Hello \$.External.FirstName \$.External.LastName, thank you for calling.

This message is shown in the following image of the text-to-speech box of the [Play prompt](#) block.

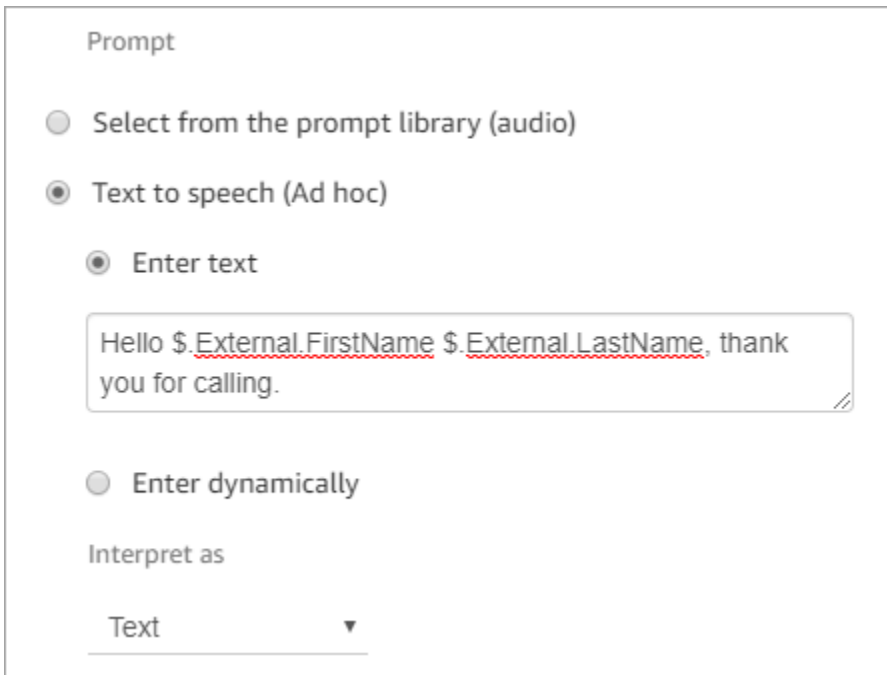

Prompt

Select from the prompt library (audio)

Text to speech (Ad hoc)

Enter text

Hello \$.External.FirstName \$.External.LastName, thank you for calling.

Enter dynamically

Interpret as

Text ▼

Alternatively, you could store the attributes returned from the Lambda function using a **Set contact attributes** block, and then reference the user-defined attribute created in the text-to-speech string.

If you are referencing a user-defined attribute that was previously set as a contact attribute in the flow using the API, you can reference the attribute using the `$.Attributes.nameOfAttribute` syntax.

For example, if the contact in question has attributes "FirstName" and "LastName" set previously, reference them as follows:

- Hello `$.Attributes.FirstName` `$.Attributes.LastName`, thank you for calling.

Dynamically select which prompts to play

You can dynamically select which prompt to play by using an attribute.

1. Add [Set contact attributes](#) blocks to your flow. Configure each one to play the appropriate audio prompt. For example, the first one might play the .wav file when your contact center is open. The second one might play the .wav file for when it's closed.

The following image shows how you might configure a [Set contact attributes](#) block. In this example, the user-defined attribute is named **CompanyWelcomeMessage**. You can name your attribute anything you want.

Set contact attributes

Define and store key-value pairs as contact attributes. [Learn more](#)

Contact attributes are accessible by other areas of Amazon Connect, such as the Contact Control Panel (CCP) and Contact Trace Records (CTRs).

Attribute to save

Destination Type ✕
User Defined ▼

Destination Attribute
CompanyWelcomeMessage →

Use text

Value
prompt/d8dbed8f-9483-448e-8c4d-d27685dc9320

Use attribute →

Paste the entire ARN of the .wav file you want to play, for example:

```
arn:aws:connect:us-west-2:111111111111:instance/22222222-8449-4c02-8da1-259cdc85c061/prompt/d8dbed8f-9483-448e-8c4d-d27685dc9320
```

- In the [Play prompt](#) block, choose **User Defined**, and then enter the name of the attribute that you created in step 1, as shown in the following image.

Play prompt
✕

Delivers an audio or chat message. [Learn more](#)

Prompt

Select from the prompt library (audio)

Select a prompt

Select dynamically

Type

User Defined

Attribute

CompanyWelcomeMessage

Text-to-speech or chat text

Enter the name of the user-defined attribute created in Step 1.

3. Connect the [Set contact attributes](#) blocks to the **Play prompt** block. The following example shows how it might look if you added one of each block to test how this works.

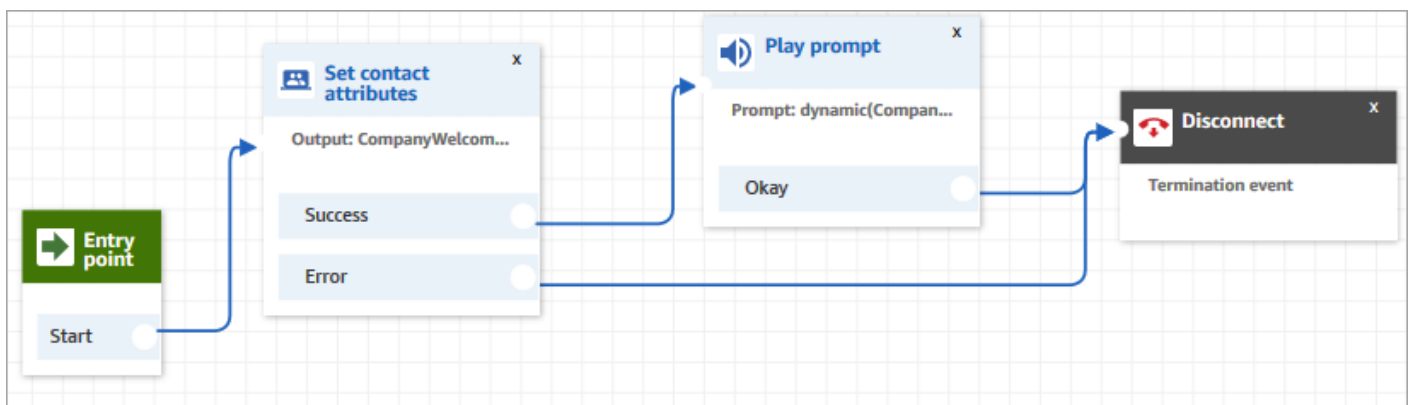

Set up prompts to play from an S3 bucket

When you configure prompts on the [Get customer input](#), [Loop prompts](#), [Play prompt](#), or [Store customer input](#) blocks, you can choose an S3 bucket as the source location. You can store as many

voice prompts as needed in an S3 bucket and access them in real time by using contact attributes. For examples, see the [Play prompt](#) block.

Requirements

- **Supported formats:** Amazon Connect supports .wav files to use for your prompt. You must use .wav files that are 8KHz, and mono channel audio with U-Law encoding. Otherwise, the prompt won't play correctly. You can use publicly available third-party tools to convert your .wav files to U-Law encoding. After converting the files, upload them to Amazon Connect.
- **Size:** Amazon Connect supports prompts that are less than 50MB and less than five minutes long.
- **For Regions that are disabled by default** (also called [opt-in](#) Regions) such as Africa (Cape Town), your bucket must be in the same Region.

Update the S3 bucket policy

To allow Amazon Connect to play prompts from an S3 bucket, when you set up your S3 bucket, you must update the bucket policy to grant `connect.amazonaws.com` (the Amazon Connect service principal) permission to call `s3:ListBucket` and `s3:GetObject`.

To update the S3 bucket policy:

1. Go to the Amazon S3 admin console.
2. Choose the bucket that has your prompts.
3. Choose the **Permissions** tab.
4. In the **Bucket policy** box, choose **Edit**, and paste the following policy as your template. Replace the bucket name, Region, AWS account ID, and [instance ID](#) with your own information, and then choose **Save changes**.

```
{
  "Version": "2012-10-17",
  "Statement": [
    {
      "Sid": "statement1",
      "Effect": "Allow",
      "Principal": {
        "Service": "connect.amazonaws.com"
      },
    },
  ],
}
```

```

    "Action": [
      "s3:ListBucket",
      "s3:GetObject"
    ],
    "Resource": [
      "arn:aws:s3:::customer-prompt-example-bucket",
      "arn:aws:s3:::customer-prompt-example-bucket/*"
    ],
    "Condition": {
      "StringEquals": {
        "aws:SourceAccount": "account-id",
        "aws:SourceArn": "arn:aws:connect:region:account-
id:instance/instance-id"
      }
    }
  ]
}

```

5. Encryption: Amazon Connect cannot download and play prompts from an S3 bucket if an AWS managed key is enabled on that S3 bucket. However, you can use a customer managed key to allow the Amazon Connect service principal ("connect.amazonaws.com") that enables your Amazon Connect instance to access the S3 bucket. See the following code snippet:

```

{
  "Sid": "Enable Amazon Connect",
  "Effect": "Allow",
  "Principal": {
    "Service": "connect.amazonaws.com"
  },
  "Action": "kms:decrypt",
  "Resource": [
    "arn:aws:kms:region:account-ID:key/key-ID"
  ]
}

```

The following image shows where you place the code on the **Key policy** tab on the AWS Key Management Service console.

The screenshot shows the AWS KMS console for a customer managed key with ID `d339e7f6`. The 'Key policy' tab is active, showing a JSON policy with the following content:

```

1 {
2   "Version": "2012-10-17",
3   "Id": "key-consolePolicy-3",
4   "Statement": [
5     {
6       "Sid": "Enable Amazon Connect",
7       "Effect": "Allow",
8       "Principal": {
9         "Service": "connect.amazonaws.com"
10      },
11      "Action": "kms:decrypt",
12      "Resource": "arn:aws:kms:us-west-2:545169615520:key/d339e7f6"
13    },
14    {
15      "Sid": "Enable IAM User Permissions",
16      "Effect": "Allow",
17      "Principal": {
18        "AWS": "arn:aws:iam::545169615520:root"
19      },
20      "Action": "kms:*",
21      "Resource": "*"
22    }
23  ]
24 }

```

For information on how to find the key ID, see [Finding the key ID and key ARN](#) in the *AWS Key Management Service Developer Guide*.

After you set up your S3 bucket with the required bucket policy, configure [Get customer input](#), [Loop prompts](#), [Play prompt](#), or [Store customer input](#) to play a prompt from the bucket.

i Tip

For more information about S3 buckets, including examples and limitations, see the [Play prompt](#) block.

Choose the voice for audio prompts

You select the text-to-speech voice and language in the [Set voice](#) block.

You can also use SSML in Amazon Lex bots to modify the voice used by a chat bot when interacting with your customers. For more information about using SSML in Amazon Lex bots, see [Managing Messages](#) and [Managing Conversation Context](#) in the Amazon Lex Developer Guide.

i Tip

If you enter text that isn't supported for the Amazon Polly voice you are using, it won't be played. However, any other supported text in the prompt will be played. For a list of supported languages, see [Languages Supported by Amazon Polly](#).

Use SSML tags to personalize text-to-speech

When you add a prompt to a flow, you can use SSML tags to provide a more personalized experience for your customers. SSML tags are a way to control how Amazon Polly generates speech from the text you provide.

The default setting in a flow block for interpreting text-to-speech is **Text**. To use SSML for text to speech in your flow blocks, set the **Interpret as** field to **SSML** as shown in the following image.

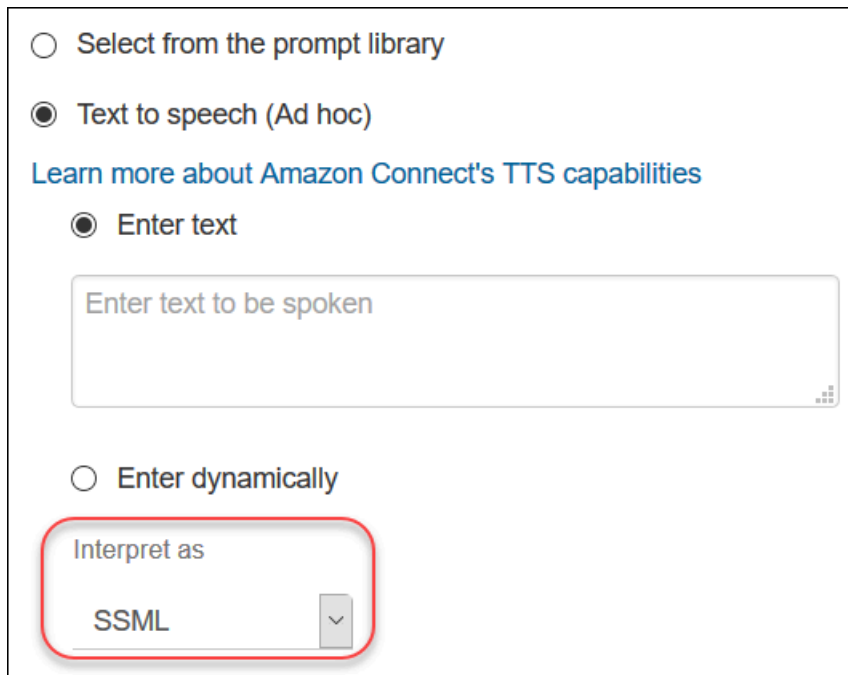

Select from the prompt library

Text to speech (Ad hoc)

[Learn more about Amazon Connect's TTS capabilities](#)

Enter text

Enter text to be spoken

Enter dynamically

Interpret as

SSML

SSML tags aren't interpreted in chats

If you create text-to-speech text and apply SSML tags, they won't be interpreted in a chat conversation. For example, in the following image both the text **and tags** will be printed in the chat conversation.

Prompt

Select from the prompt library (audio)

Text-to-speech or chat text

Enter text

`< speak > Thank you for calling our customer support center < / speak >`

Enter dynamically

Interpret as

SSML

SSML tags supported by Amazon Connect

Amazon Connect supports the following SSML tags.

Tip

If you use an unsupported tag in your input text, it's automatically ignored when it's processed.

Tag	Use to...
Speak	All SSML-enhanced text must be enclosed within a pair of speak tags.
break	Add a pause to your text. The maximum duration for a pause is 10 seconds.
lang	Specify another language for specific words.
mark	Put a custom tag within the text.

Tag	Use to...
p	Add a pause between paragraphs in your text.
phoneme	Make a phonetic pronunciation for specific text.
prosody	Control the volume, rate, or pitch of your selected voice.
s	Add a pause between lines or sentences in your text.
say-as	Combine with the interpret-as attribute to tell Amazon Polly how to say certain characters, words, and numbers.
sub	Combine with the alias attribute to substitute a different word (or pronunciation) for selected text such as an acronym or abbreviation.
w	Customize the pronunciation of words by specifying the word's part of speech or alternate meaning.
amazon:effect name="whispered"	Indicate that the input text should be spoken in a whispered voice rather than as normal speech.

If you use an unsupported tag in your input text it is automatically ignored when it is processed.

To learn more about the SSML tags, see [Supported SSML Tags](#) in the Amazon Polly Developer Guide.

Neural and Conversational Speaking Styles

For the **Joanna** and **Matthew** neural voices, in American English (en-US), you can also specify a [Newscaster speaking style](#).

Set up contact transfers

Amazon Connect enables you to set up different kinds of transfers:

- [Agent-to-agent transfers](#): For example, if you want agents to be able to transfer calls or tasks to other agents.
- [Transfers to a specific agent](#): For example, if you want to route contacts to the last agent the customer interacted with, or route contacts to agents who have specific responsibilities.
- [Transfers to queues](#): For example, if you want to transfer the contact to a sales, support, or escalation queue. To do this, create a [queue quick connect](#). This works with voice, chat, and task contacts.
- [Transfers to phone numbers](#): For example, if you want to transfer the contact to a phone number, such as an on-call pager. To do this, create an phone number quick connect.

Overview of steps

To set up call transfers and quick connects

1. Choose a flow type based on what you want to do: Transfer to agent or Transfer to queue. Phone number transfers do not require a specific type of contact flow.
2. Create and publish the flow.
3. Create a quick connect for the type of transfer to enable: **Agent**, **Queue**, or **Phone number**.

When you create the **Agent** or **Queue** quick connect, select a flow that matches the type of transfer to enable. **Phone number** quick connects require only a phone number, and do not allow you to set a queue or flow.

4. Add the quick connect that you created to any queue used in a flow for which to enable contact transfer, such as the queue used in the flow for incoming contacts.
5. Make sure the queue is in a routing profile assigned to the agents who transfers contacts.

Create quick connects

Quick connects are a way for you to create a list of destinations for common transfers. For example, you might create a quick connect for Tier 2 support. If agents in Tier 1 support can't solve the issue, they will transfer the contact to Tier 2.

How many quick connects can I create? To view your quota of **Quick connects per instance**, open the Service Quotas console at <https://console.aws.amazon.com/servicequotas/>.

Types of quick connects

The type of a quick connect specifies the destination. You can specify one of the following destinations.

Phone number quick connect

Contacts are transferred to a phone number (such as an on-call pager).

User quick connect

Contacts are transferred to a specific user, such as an agent, as part of a flow.

Important

User and Queue quick connects only appear in the CCP when an agent goes to transfer a contact.

Queue quick connect

Contacts are transferred to a queue as part of a flow.

Important

User and Queue quick connects only appear in the CCP when an agent goes to transfer a contact.

Step 1: Create quick connects

Following are the instructions to add quick connects manually using the Amazon Connect console. To add quick connects programmatically, use the [CreateQuickConnect](#) API.

To add quick connects

1. Log in to the Amazon Connect admin website at https://instance_name.my.connect.aws/. To find the name of your instance, see [Find your Amazon Connect instance ID/ARN](#).
2. On the navigation menu, choose **Routing, Quick connects**.

3. For each quick connect, do the following:
 - a. Choose **Add new**.
 - b. Enter a unique name. If desired, also enter a description.
 - c. Choose a type.
 - d. Enter the destination (for example, a phone number, the name of an agent, or the name of a queue).
 - e. Enter a flow, if applicable.
 - f. Enter a description.
4. When you're finished adding quick connects, choose **Save**.

Step 2: Enable agents to see quick connects

To enable your agents to see the quick connects in the CCP when they transfer a contact

1. After you create the quick connect, go to **Routing, Queues** and then choose the appropriate queue for the contact to be routed to.
2. On the Edit queue page, in the Quick connect box, search for the quick connect you created.
3. Select the quick connect and then choose **Save**.

Tip

Agents see the quick connects of the queues in their routing profile, including the Default outbound queue.

Example: Create a phone number quick connect to a mobile phone

In this example, you create a phone number quick connect to a person's mobile phone. This might be for a supervisor, for example, so agents can call them if needed.

Create a quick connect for a person's mobile phone number

1. On the navigation menu, choose **Routing, Quick connects, Add quick connect**.
2. On the **Add quick connect** page, enter a name for the quick connect, for example, **John Doe's cell phone**.

3. For **Type**, select **Phone number**.
4. For **Phone number**, enter the mobile phone number, starting with the country code. In the US, the country code is 1, as shown in the following image.

The screenshot shows the 'Add quick connect' dialog box. It has a title bar with 'Add quick connect', 'Cancel', and 'Save' buttons. Below the title bar is a section titled 'Quick connect details' with two input fields: 'Name' (containing 'John Doe's cell phone', 21 / 127 characters) and 'Description' (empty, 0 / 250 characters). Below this is a 'Type' section with a 'Search type' dropdown (set to 'Phone number', 15 / 25 characters) and a 'Phone number' section containing a 'Country code' dropdown (set to '+1') and a 'Phone number' text input (containing '555-555-1212', 15 / 25 characters). All input fields are marked as 'Required'.

5. Choose **Save**.

Add the quick connect to a queue. Agents working this queue will see the quick connect in their CCP.

1. Go to **Routing, Queues**, and choose the queue you want to edit.
2. On the **Edit queue** page, in **Outbound caller ID number**, choose a number claimed for your contact center. This is required to make outbound calls.
3. At the bottom of the page, in the **Quick connect** box, search for the quick connect you created, for example, **John Doe's cell phone**.
4. Select the quick connect. In the following image of the **Edit queue** page, a phone number has been selected for the **Outbound caller ID number**, and **John Doe's cell phone** has been selected as the quick connect.

BasicQueue

Description

A simple, basic voice queue.

222 of 250 characters remaining.

Show additional queue information ▾

Hours of operation

Basic Hours x ▾

Outbound caller ID name

Enter the callback name

The name that will show up on the customer's phone

Outbound caller ID number

+1 [redacted] x ▾

Outbound whisper flow (optional)

Search for contact flow ▾

Quick connects (optional)

x John Doe's cell phone

5. Choose **Save**.

Test the quick connect

1. Open the Contact Control Panel.
2. Choose **Quick connects**.
3. Select the quick connect you created, and then choose **Call**.

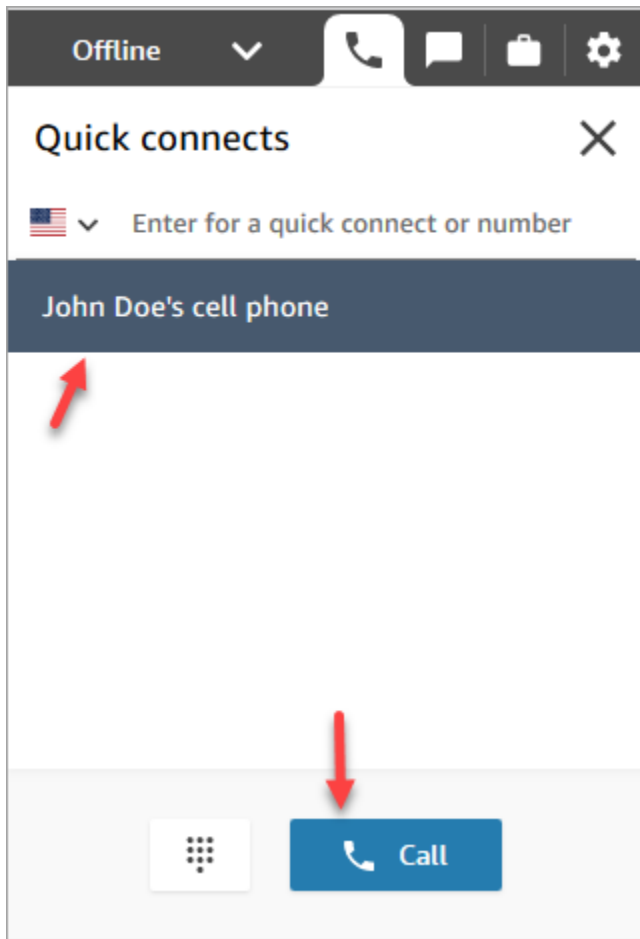

Delete quick connects

There are two ways you can delete a quick connect:

- Use Amazon Connect console. This topic provides instructions.
- Use the [DeleteQuickConnect](#) API.

To delete a quick connect

1. Log in to your Amazon Connect instance (https://instance_name.my.connect.aws/) with an Admin account or a user account that has **Quick connects - Delete** permissions in its [security profile](#). (To find the name of your instance, see [Find your Amazon Connect instance ID/ARN.](#))
2. On the navigation menu, choose **Routing, Quick connects**.
3. Select the quick connect, and then choose the **Delete** icon.

If you don't see the delete option, check the following:

- You are using the latest Amazon Connect user interface. The following image shows a banner at the top of the **Quick connects** page. Choose **Try it now** to use the latest Amazon Connect user interface.

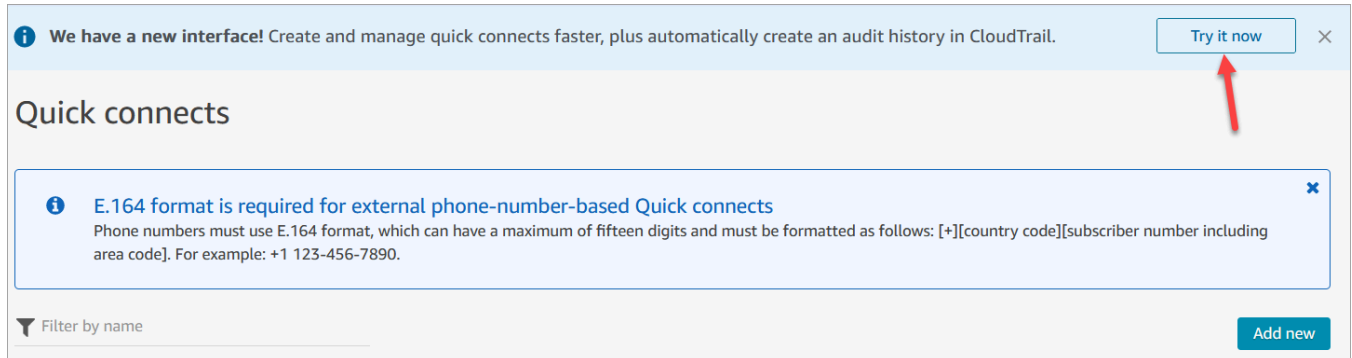

- You have **Quick connects - Delete** permission in your security profile.

How quick connects work

This article explains how each type of quick connect works: agent, queue, and phone number quick connects. It explains which flows are used, and what appears on the agent's Contact Control Panel (CCP).

Tip

For all three types of quick connects, when the quick connect is invoked, the contact that the agent is working on hears the [Default customer hold](#) flow unless you specify a different customer hold flow.

User quick connects

Let's say an agent named John is talking to a customer. During the conversation he needs to transfer the call to an agent named Maria. This is a user quick connect.

Here's what John and Maria do, and what flow blocks are triggered:

1. John chooses the **Quick Connect** button on his CCP. (On the earlier CCP, the button is named **Transfer**). He selects **Maria** from the list of quick connects.

When John does this, his CCP banner changes to **Connected**. However, the call isn't actually connected to Maria yet.

- In our example scenario, Amazon Connect triggers an agent transfer flow that looks like the following image. It has the following blocks connected by **Success** branches: a **Play prompt**, a **Set whisper flow**, another **Set whisper flow**, and then a **Transfer to agent** block.

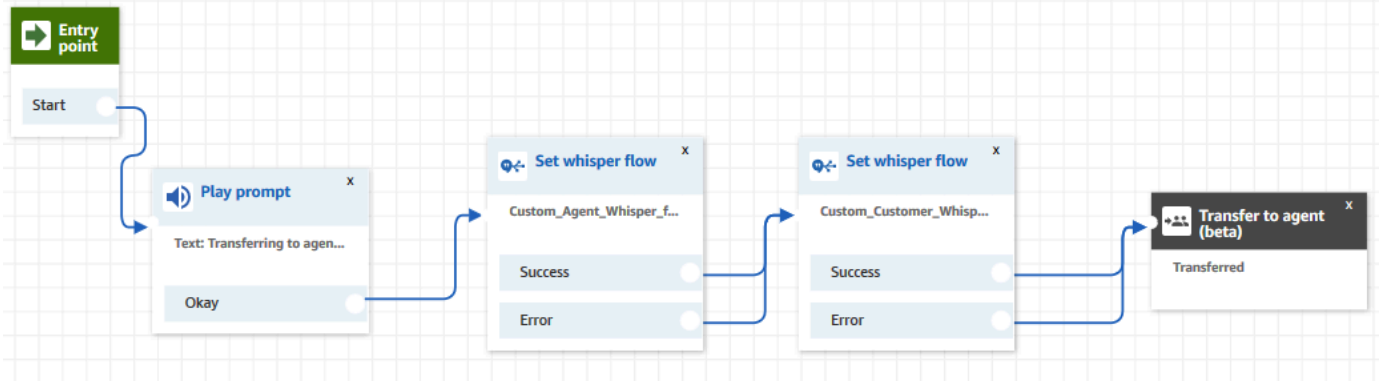

The call is not yet connected to Maria.

- John hears the first **Play prompt**, "Transferring to agent."
- Maria receives a notification in her CCP to either accept or reject the call.
- Maria accepts the incoming call. The banner in her CCP changes to **Connecting**.
- The first [Set whisper flow](#) block is triggered. This block sets the custom agent whisper flow. It plays the Custom_Agent_Whisper to Maria, for example, "This is an internal call transferred from another agent."

Note

If you don't create and then select a custom agent whisper flow, Amazon Connect plays the [default agent whisper flow](#), which says the queue name.

- The next [Set whisper flow](#) block is triggered. It plays the Custom_Customer_Whisper to John, for example, "Your call is now connecting to an agent."

Note

If you don't create and then select a custom customer whisper flow, Amazon Connect plays the [default customer whisper flow](#), which plays a beep.

8. Maria's CCP banner shows she's **Connected**. John and Maria are connected and can start talking.
9. Now John can do one of the following on his CCP:
 - Choose **Join**. This joins all parties on the call. John, Maria, and the customer have a conference call.
 - Choose **Hold all**. This puts Maria and the customer on hold.
 - Put Maria on hold, so he only talks to the customer.
 - Choose **End call**. He leaves the call but Maria and the customer are directly connected and continue talking.

Queue quick connects

Let's say John is talking to a customer. The customer needs help resetting his password, so John needs to transfer him to the PasswordReset queue. This is a queue quick connect.

Another agent, Maria, is assigned to handle contacts in the PasswordReset queue. Her status in the CCP is **Available**.

Here's what John and Maria do, and what flow blocks are triggered:

1. John chooses the **Quick Connect** button on his CCP. (On the earlier CCP, the button is named **Transfer**). He chooses to transfer the contact to the PasswordReset queue. As soon as John chooses the PasswordReset quick connect, his CCP banner shows **Connecting**.

Important

Even though the status of the transferred call (internal-transfer) shows on John's CCP banner as **Connecting**, the contact is not yet transferred to the PasswordReset queue.

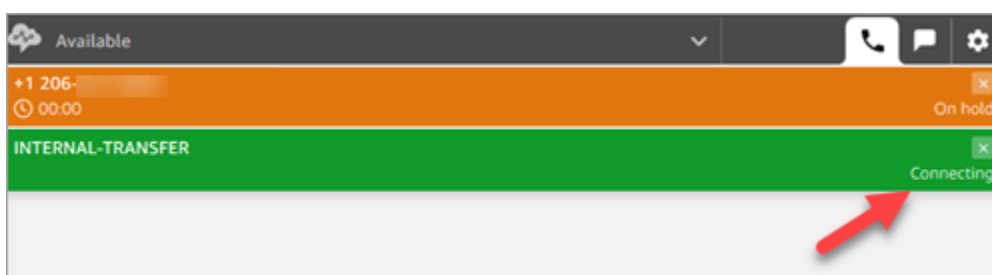

2. Amazon Connect invokes the queue transfer flow that's associated with the PasswordReset quick connect. In this flow, the [Transfer to queue](#) block transfers the contact to the PasswordReset queue since it's specified in the block. The contact is now in the PasswordReset queue.
3. Maria is notified in her CCP to accept or reject the incoming call.
4. Maria accepts the incoming call and her CCP banner changes to **Connecting**.
5. The [Agent whisper flow](#) is played to Maria. It says "Connecting you to PasswordReset queue."
6. The [Customer whisper flow](#) is played to John. It says "Connecting you to PasswordReset queue."
7. Maria's CCP banner changes to **Connected**. John and Maria are connected and can start talking.
8. Now John can do one of the following from his CCP:
 - Choose **Join**. This joins all parties on the call. John, Maria, and the customer have a conference call.
 - Choose **Hold all**. This puts Maria and the customer on hold.
 - Put Maria on hold, so he only talks to the customer.
 - Choose **End call**. He leaves the call but Maria and the customer are directly connected and continue talking.

Phone number quick connects

There are no flows involved in a phone number quick connect. When an agent invokes an phone number quick connect, the call is directly connected the destination without invoking any flows.

Because no flow is involved in phone number quick connects, you can't set the outbound caller ID. Instead, the caller ID that you specified when you [created the queue](#) is used.

Set up agent-to-agent transfers

We recommend using these instructions to set up agent-to-agent voice, chat, and task transfers. You use a [Set working queue](#) block to transfer the contact to the agent's queue. The **Set working queue** block supports an omnichannel experience, whereas the [Transfer to agent \(beta\)](#) block does not.

Step 1: Create the quick connect

Following are the instructions to add quick connects manually using the Amazon Connect admin website. To add quick connects programmatically, use the [CreateQuickConnect](#) API.

Create a quick connect

1. On the navigation menu, choose **Routing, Quick connects, Add a new destination**.
2. Enter a name for the connect. Choose the type, and then specify the destination (such as a phone number or the name of an agent), flow (if applicable), and description.

Important

A description is required when you create a quick connect. If you don't add one, you'll get an error when you try to save the quick connect.

3. To add more quick connects, choose **Add new**.
4. Choose **Save**.
5. Go to the next procedure to enable your agents to see the quick connects in the Contact Control Panel (CCP).

Enable your agents to see the quick connects in the CCP when they transfer a contact

1. After you create the quick connect, go to **Routing, Queues** and then choose the appropriate queue for the contact to be routed to.
2. On the **Edit queue** page, in the **Quick connect** box, search for the quick connect you created.
3. Select the quick connect and then choose **Save**.

Tip

Agents see all of the quick connects for the queues in their routing profile.

Step 2: Set up the "Transfer to agent" flow

In this step, you create a flow that's type **Transfer to agent** and use a [Set working queue](#) block to transfer the contact to the agent.

1. On the navigation menu, choose **Routing, Flows**.
2. Use the drop-down to choose **Create transfer to agent flow**.
3. Type a name and a description for your flow.
4. In the left navigation menu, expand **Set**, and then drag the **Set working queue** block to the canvas.
5. Configure the **Set working queue** block as shown in the following image. Choose **By agent**, **Set dynamically**, **Namespace = Agent**, **Value = User name**.

Set working queue

Specify the queue that the contact will be transferred to.
Select a queue to perform actions on, such as transferring a contact to it or retrieving metrics about it. [Info](#)

By queue

By agent

Set manually

Set dynamically

Namespace
Agent

Value
User name

1. Choose **By agent**.
2. Choose **Set dynamically**.
3. For **Namespace**, use the dropdown box to select **Agent**.
4. For **Value**, use the dropdown box to select **User name**.
6. Add a [Transfer to queue](#) block. You don't need to configure this block. The following image shows the **Success** branch of the **Set working queue** block connecting to the **Transfer to queue** block.

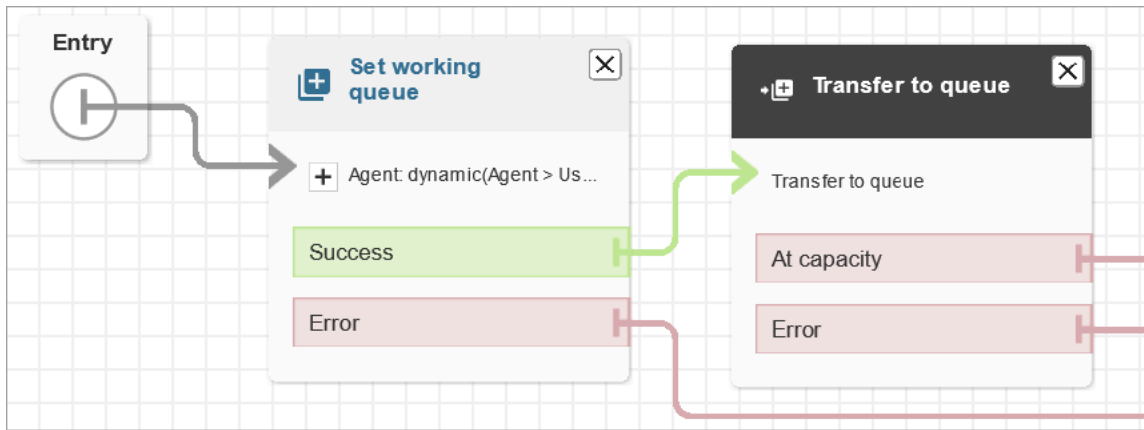

7. Save and publish this flow.
8. To show your agents how to transfer chats to another agent, see [Transfer chats to another queue](#).

To show your agents how to transfer tasks to another agent, see [Transfer a task](#).

Resume a flow after transfer

Let's say you need to transfer a contact to an external department that's not using Amazon Connect. For example, maybe you need to transfer the caller to a shipping provider to check the status of their delivery. After the contact is disconnected from the phone number, you want them to be returned to your agent, for example, when the delivery company couldn't resolve their issue.

- For advanced creation, send tracking information as DTMF digits when the call is transferred, so that the shipment information is retrieved with the transferred call before the customer is connected.

To set up a flow for this scenario

1. Add a **Transfer to phone number** block to your contact flow.
2. In the **Transfer to phone number** block, enter the following settings:
 - **Transfer to**
 - **Phone number**—Sets the phone number to transfer the call to.
 - **Set dynamically**—Specify a contact attribute (choose a namespace and then a value) to set the phone number to transfer the call to.
 - **Set timeout**

- **Timeout (in seconds)**—The number of seconds to wait for the recipient to answer the transferred call.
- **Set dynamically**—Specify a contact attribute (choose a namespace and then a value) to use to set the **Timeout** duration.
- **Resume flow after disconnect**—When you select this option, after the call is transferred, the caller is returned to the flow when the call with the third party ends. Additional branches for **Success**, **Call failed**, and **Timeout** are added to the block when you select this option so that you can appropriately route contacts when there is an issue with the transfer.
- **Optional parameters**
 - **Send DTMF**—Select **Send DTMF** to include up to 50 Dual-Tone Multi-frequency (DTMF) characters with the transferred call. You can enter the characters to include, or use an attribute. Use the DTMF characters to navigate an automated IVR system that answers the call.
 - **Caller ID number**—Specify the caller ID number used for transferred call. You can select a number from your instance, or use an attribute to set the number.
 - **Caller ID name**—Specify the caller ID name used for the transferred call. You can enter a name, or use an attribute to set the name.

In some cases, the caller ID information is provided by the carrier of the party you are calling. The information may not be up-to-date with that carrier, or the number may get passed differently between systems because of hardware or configuration differences. If that is the case, the person you call may not see the phone number, or may see the name of a previously registered owner of the number, instead of the name you specify in the block.

3. Connect **Transfer to phone number** to the rest of your flow.

When the block executes:

1. The call is transferred to the phone number.
2. Optionally, when the conversation with the external party ends, the contact is returned to the flow.
3. The contact then follows the **Success** branch from the block to continue the flow.

4. If the call is not successfully transferred, one of the other branches is followed: **Call failed**, **Timeout**, or **Error**, depending on the reason the caller did not return to the flow.

Manage contacts in a queue

For inbound contacts, you can define advanced routing decisions to minimize queue wait times, or route contacts to specific queues, using blocks in your flow. For example:

- Use a **Check queue status** block to check staffing or agent availability for a queue before sending a contact to that queue.
- Or, use a **Get queue metrics** block to retrieve queue metrics.
- Then use a **Check contact attributes** block to check specific queue metric attributes, and define conditions to determine which queue to route the contact to based on attribute values. For more information about using queue metrics, see [Route based on number of contacts in a queue](#).

After determining which queue to transfer the contact to, use a **Transfer to queue** block in a flow to transfer the contact to that queue. When the **Transfer to queue** block runs, it checks the queue capacity to determine whether or not the queue is at capacity (full). This check for queue capacity compares the current number of contacts in the queue to the [Maximum contacts in queue](#) limit, if one is set for the queue. If no limit is set, the queue is limited to the number of concurrent contacts set in the [service quota](#) for the instance.

After the contact is placed in a queue, the contact remains there until an agent takes the contact, or until the contact is handled based on the routing decisions in your customer queue flow.

To change the queue associated with the call after it is already placed in a queue, use a **Loop prompts** block with a **Transfer to queue** block in a customer queue flow. In the block choose which queue to transfer the call to, or use an attribute to set the queue.

To manage contacts in a queue using a Transfer to queue block

1. In Amazon Connect, on the navigation menu choose **Routing, Flows**.
2. Choose the down arrow next to **Create flow**, then choose **Create customer queue flow**.
3. Under **Interact**, add a **Loop prompts** block to provide a message to the caller when the call is transferred, then every X seconds or minutes while the call is in the queue.
4. Select the **Loop prompts** block to display the settings for the block.

5. Choose **Add another prompt to the loop**.
6. Under **Prompts**, do one of the following:
 - Choose **Audio recording** in the drop-down menu, then select the audio recording to use as the prompt.
 - Choose **Text to Speech** in the drop-down menu, then enter text to use for the prompt in the **Enter text to be spoken** field.
7. To set an interrupt, choose **Interrupt every**, enter a value for the interrupt interval, and then choose a unit, either **Minutes** or **Seconds**. We recommend that you use an interval greater than 20 seconds to ensure that queued contacts that are being connected to an agent are not interrupted.
8. Choose **Save**.
9. Connect the block to the **Entry point** block in the contact flow.
10. Under **Terminate/Transfer**, drag a **Transfer to queue** block onto the designer.
11. Select the title of the block to display the settings for the block, then choose the **Transfer to queue** tab.
12. Under **Queue to check**, choose **Select a queue**, then select the queue to transfer calls to.

Alternatively, choose **Set dynamically**, then reference an attribute to specify the queue. If you use an attribute to set the queue, the value must be the queue ARN.
13. Choose **Save**.
14. Connect the **Loop prompt** block to the **Transfer to queue** block.
15. Add additional blocks to complete the flow that you require, such as the blocks to check queue status or metrics, then choose **Save**.

The flow is not active until you publish it.

Important

To successfully complete the call transfer to another queue, you must include a block after the **Transfer to queue** block and connect the **Success** branch to it. For example, use an **End flow / Resume** block to end the flow. The flow does not end until the call is picked up by an agent.

Transfer contacts to a specific agent

Agent queues enable you to route contacts directly to a specific agent. Following are a couple of scenarios where you might want to do this:

- Route contacts to the last agent the customer interacted with. This provides a consistent customer experience.
- Route contacts to agents who have specific responsibilities. For example, you might route all billing questions to Jane.

Note

A queue is created for all users in your Amazon Connect instance, but only users who are assigned permissions to use the Contact Control Panel (CCP) can use it to receive contacts. The Agent and Admin security profiles are the only default security profiles that include permissions to use the CCP. If you route a contact to someone who doesn't have these permissions, the contact can never be handled.

To route a contact directly to a specific agent

1. In Amazon Connect, choose **Routing, Contact flows**.
2. In the flow designer, open an existing flow, or create a new one.
3. Add a block in which you can select a queue to transfer a contact to, such as a **Set working queue** block.
4. Select the title of the block to open the block settings.
5. Select **By agent**.
6. Under **Select an agent**, enter the user name of the agent, or select the agent's user name from the drop-down list.
7. Choose **Save**.
8. Connect the **Success** branch to the next block in your flow.

You can also choose to use an attribute to select the queue created for the agent user account. To do so, after you choose **By agent**, choose **Use attribute**.

Use contact attributes to route contacts to a specific agent

When you use contact attributes in a flow to route calls to an agent, the attribute value must be either the agent's user name, or the agent's user ID.

To determine the user ID for an agent so that you can use the value as an attribute, use one of these options:

- Use the **Network** tab of the browser debugger to retrieve the agent ID. For example:
 1. In a Chrome browser, press F12 and go to the **Network** tab.
 2. In Amazon Connect, in the navigation menu, choose **Users, User management**, and then select an agent. Monitor the content of the **Network** tab. In the **Name** list, choose the GUID.
 3. Choose the **Preview** tab. The agent ID is displayed next to the **Id** field. The following image shows the location of the agent ID in the **Preview** tab.

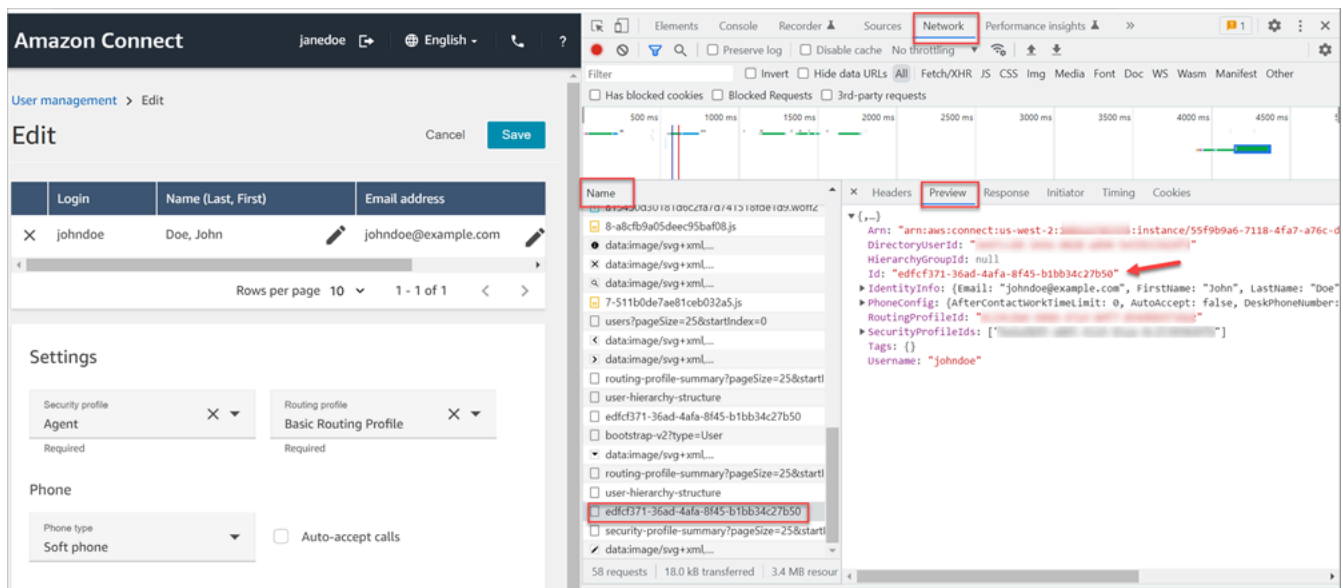

- Use the [ListUsers](#) operation to retrieve the users from your instance. The agent's user ID is returned with the results from the operation as the value of the **Id** in the [UserSummary](#) object.
- Find the user ID for an agent by using [Amazon Connect agent event streams](#). The agent events, which are included in the agent event data stream, include the agent ARN. The user ID is included in the agent ARN after **agent/**.

In the following agent event data, the agent ID is **87654321-4321-4321-4321-123456789012**.

```
{
  "AWSAccountId": "123456789012",
```

```

    "AgentARN": "arn:aws:connect:us-
west-2:123456789012:instance/12345678-1234-1234-1234-123456789012/
agent/87654321-4321-4321-4321-123456789012",
    "CurrentAgentSnapshot": {
      "AgentStatus": {
        "ARN": "arn:aws:connect:us-
west-2:123456789012:instance/12345678-1234-1234-1234-123456789012/agent-
state/76543210-7654-6543-8765-765432109876",
        "Name": "Available",
        "StartTimestamp": "2019-01-02T19:16:11.011Z"
      },
      "Configuration": {
        "AgentHierarchyGroups": null,
        "FirstName": "IAM",
        "LastName": "IAM",
        "RoutingProfile": {
          "ARN": "arn:aws:connect:us-
west-2:123456789012:instance/12345678-1234-1234-1234-123456789012/routing-profile/
aaaaaaaa-bbbb-cccc-dddd-111111111111",
          "DefaultOutboundQueue": {
            "ARN": "arn:aws:connect:us-
west-2:123456789012:instance/12345678-1234-1234-1234-123456789012/queue/aaaaaaaa-bbbb-
cccc-dddd-222222222222",
            "Name": "BasicQueue"
          },
          "InboundQueues": [{
            "ARN": "arn:aws:connect:us-
west-2:123456789012:instance/12345678-1234-1234-1234-123456789012/queue/aaaaaaaa-bbbb-
cccc-dddd-222222222222",
            "Name": "BasicQueue"
          }],
          "Name": "Basic Routing Profile"
        },
        "Username": "agentUserName"
      },
      "Contacts": []
    },
  },

```

Set up recording behavior

Managers can monitor live conversations, and review and download recordings of past agent conversations. To set this up, you need to add the [Set recording and analytics behavior](#) block to

your flows, assign managers the appropriate permissions, and show them how to monitor live conversations and access past recordings in Amazon Connect.

When is a conversation recorded?

- The call recording feature has options for choosing whether to record the agent only, customer only, or agent and customer conversations.
- A conversation is recorded only when the contact is connected to an agent. The contact is not recorded before then, when they are connected to the flow.
- Audio is NOT transmitted to Amazon Connect or recorded when the agent is not on a call. On November 9, 2023, Amazon Connect deployed an optimization to improve agent productivity that pre-configures the microphone media stream of the agent's browser before the contact arrives. This reduces setup time for both incoming and outgoing calls. As a result, the microphone icon in the agent's browser appears to be on, even when the agent is not on a call.
- When call recording is enabled, the recording begins when the call is connected to an agent and stops when the agent disconnects.
- When a customer is on hold, the agent is still recorded.
- The transfer conversation between agents is recorded.
- Any transfers to external numbers are not recorded after the agent leaves the call.
- If the agent mutes their own microphone, for example, to consult with a coworker sitting next to them, their side-bar conversation is not recorded. The customer is still recorded since their microphone hasn't been muted.
- To record the customer when they are not connected to an agent, for example, if all of their interaction is with a Lex bot, use media streaming.

Where are recordings and transcripts stored?

Agents and contacts are stored on separate, stereo audio channels.

- The agent audio is stored in the right channel.
- All incoming audio, including the customer and anyone conferenced in, is stored in the left channel.

Recordings are stored in the Amazon S3 bucket that are [created for your instance](#). Any user or application with the appropriate permissions can access the recordings in the Amazon S3 bucket.

Encryption is enabled by default for all call recordings using Amazon S3 server-side encryption with KMS. The encryption is at the object level. The reports and recording objects are encrypted; there's no encryption at the bucket level.

You shouldn't disable encryption.

Important

- For voice conversations to be stored in an Amazon S3 bucket, you need to enable recording in the flow block using the [Set recording and analytics behavior](#) block.
- For chat conversations, if there's an S3 bucket for storing chat transcripts, then all chats are recorded and stored there. If no bucket exists, then no chats are recorded. However, if you want to monitor chat conversations, you still need to add the [Set recording and analytics behavior](#) block to the flow.
- If a recording is moved from one S3 bucket to another for any reason, such as the retention period has expired, then the recording will no longer be accessible by Amazon Connect.

Tip

We recommend using the contact ID to search for recordings. Even though many call recordings for specific contact IDs may be named with the contact ID prefix itself (for example, 123456-aaaa-bbbb-3223-2323234.wav), there is no guarantee that the contact IDs and name of the contact recording file *always* match. By using **Contact ID** for your search on the [Contact search](#) page, you can find the correct recording by referring to the audio file on the contact record.

When are recordings available?

When call recording is enabled, the recording is placed in your S3 bucket shortly after the contact is disconnected. Then you can [review the recording](#).

Important

You can also access the recording from the customer's [contact record](#). The recording is available in the contact record, however, only after the contact has left the [After Contact Work \(ACW\) state](#).

Tip

Amazon Connect uses the Amazon S3 [PutObject](#) and [MultipartUpload](#) APIs to upload the call recording to your S3 bucket. If you are using [S3 Event Notifications](#) when call recordings are uploaded successfully to your bucket, make sure you enable the notification for **All object create events**, or for both `s3:ObjectCreated:Put` and `s3:ObjectCreated:CompleteMultipartUpload` event types.

Prevent agents from accessing recordings

To prevent agents from accessing recordings outside of their agent hierarchy, assign them the **Restrict contact access** security profile permission. For more information, see [Assign permissions to review recordings of past conversations](#).

Headset requirements for listening to recordings

You need to use an output device (headset or other device) that supports stereo output so you can hear both the agent and customer audio.

Agent and customer recordings are presented in two separate channels. With a full headset, each side will play one channel. But for a one-ear headset, there isn't a mechanism to mix two channels into one.

How to set up recording behavior

To view a sample flow with the **Set recording behavior** block configured, see [Sample recording behavior](#).

Note

We recommend using the **Set recording behavior** block in an inbound or outbound whisper flow for the most accurate behavior.

Using this block in a queue flow does not always guarantee that calls are recorded. This is because the block might run after the contact is joined to the agent.

To set up recording behavior in your flows

1. Log in to your Amazon Connect instance using an account that has permissions to edit flows.
2. On the navigation menu, choose **Routing, Flows**.

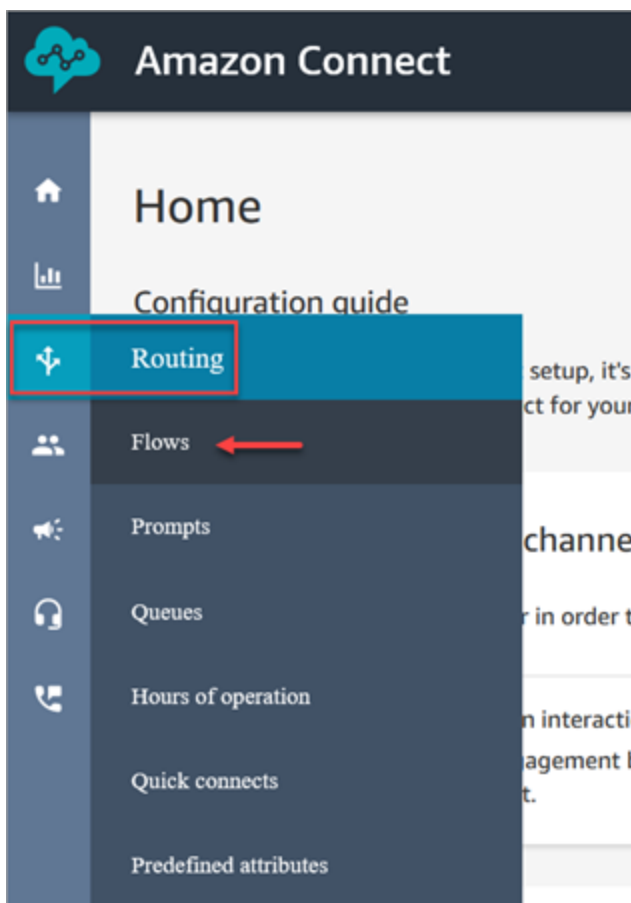

3. Open the flow that handles customer contacts you want to monitor.
4. In the flow, before the contact is connected to an agent, add a [Set recording and analytics behavior](#) block to the flow.
5. To configure the [Set recording and analytics behavior](#) block, choose from the following:

- To record voice conversations, choose what you want to record: **Agent and Customer, Agent only, or Customer only.**
 - To record chat conversations, you need to choose **Agent and Customer.**
 - To enable monitoring of voice and/or chat conversations, you need to choose **Agent and Customer.**
6. Choose **Save** and then **Publish** to publish the updated flow.

To set up recording behavior for outbound calls

1. Create a flow, using the outbound whisper flow type.
2. Add a [Set recording and analytics behavior](#) block to that flow.
3. Set up a queue that will be used for making outbound calls. In the **Outbound whisper flow** box, choose the flow that has [Set recording and analytics behavior](#) in it.

How to set up users to monitor conversations or review recordings

To learn what permissions managers need, and how they can monitor live conversations and review recordings of past conversations, see:

- [Set up live monitoring for voice and/or chat](#)
- [Review recorded conversations between agents and customers using Amazon Connect](#)

How to set up S3 Object Lock for immutable call recordings

You can use Amazon S3 Object Lock in combination with your call recording bucket to help prevent call recordings from being deleted or overwritten for a fixed amount of time, or indefinitely.

Object Lock adds another layer of protection against object changes and deletion. It can also help meet regulatory requirements for Write-Once-Read-Many (WORM) storage.

Important things to know

- You can enable Amazon S3 Object Lock on new and existing buckets.
- You must enable versioning on your call recording bucket.
- After you enable Amazon S3 Object Lock, you cannot remove it.

- We recommend using a dedicated call recording bucket because all objects will be locked after the default Object Lock retention policy is applied.
- Ensure that your retention policy is appropriate for your requirements. After the policy is configured, your call recordings will be protected from deletion for the duration specified.
- We strongly recommended you thoroughly test the policy in a non-production environment before implementing it in production.

Step 1: Create an S3 bucket with Object Lock enabled

For a tutorial on creating a new S3 bucket with Object Lock enabled, see [Protect Data on Amazon S3 Against Accidental Deletion or Application Bugs Using S3 Versioning, S3 Object Lock, and S3 Replication](#).

Step 1A: Enable Object Lock for an existing Amazon S3 bucket

For information about enabling Object Lock on an existing bucket, see [Enable Object Lock on an existing Amazon S3 bucket](#), in the *Amazon S3 User Guide*.

Step 2: Configure Amazon Connect to use the S3 bucket for call recordings

1. Open the Amazon Connect console at <https://console.aws.amazon.com/connect/>.
2. On the instances page, choose the instance alias.

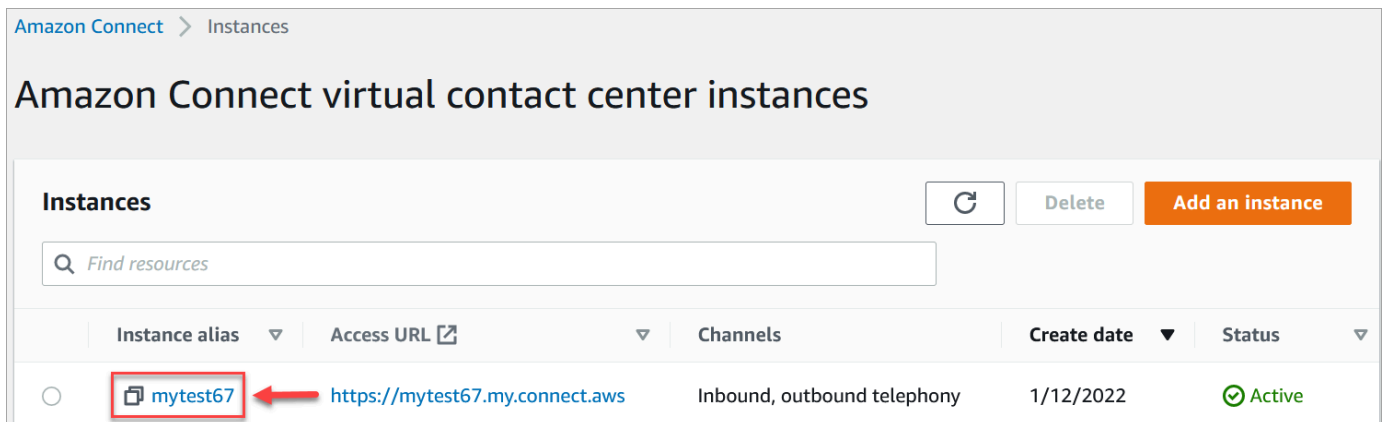

3. In the navigation pane, choose **Data storage**.
4. In the **Call recordings** section, choose **Edit**.
5. Choose **Select an existing S3 bucket**, and then in the **Name** dropdown box choose the bucket that you enable Object Lock for.
6. Choose **Save**.

Step 3: Test Object Lock is enabled

1. Make a test call to your contact center to generate a call recording.
2. Log in to Amazon Connect at <https://your-instance.my.connect.aws/home>, with an Admin account, or an account that has [permissions to search for contacts](#).
3. Choose **Analytics and optimization, Contact search**. Search for your call recording to find the contact ID. Copy the contact ID. You're going to use it in the next step to locate the call recording in your S3 bucket.
4. Open the Amazon S3 console, select the bucket you created in Step 1, and follow the path prefix. The path to the call recording includes the year, month, and day the recording was made. After you're in the correct path prefix, search for the contact ID of the call recording.

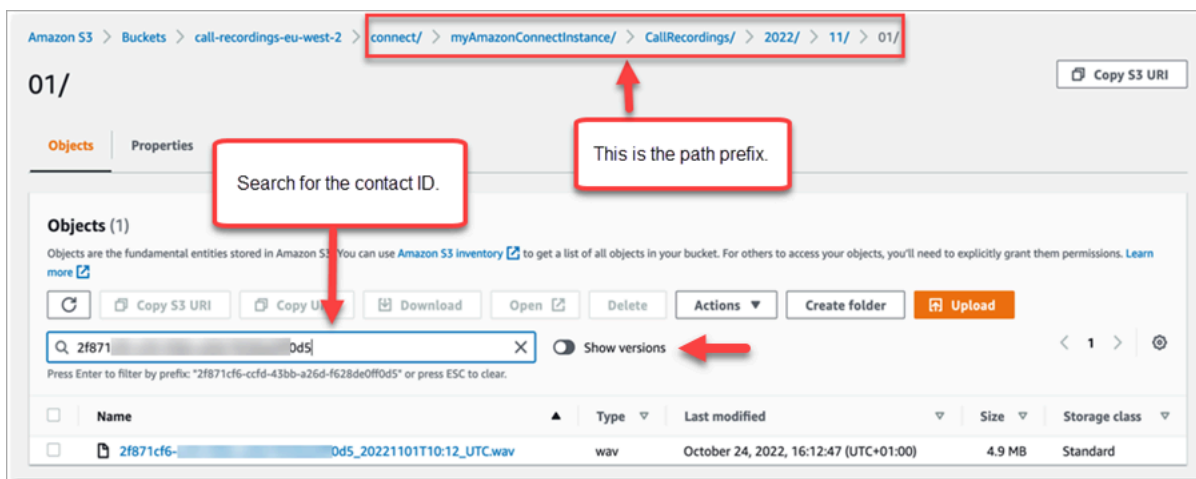

5. Select the **Show versions** toggle next to the **Search** box. This option allows you to attempt to delete the object instead of only applying a delete marker. Applying a delete marker is the standard behavior when you delete an object from an S3 bucket with versioning enabled.
6. Select the call recording (the box to the left of the recording name), and then choose **Delete**. In the confirmation box, enter **permanently delete** and select **Delete objects**.
7. Review the **Delete objects: status** notification to confirm that the delete operation has been blocked due to the Object Lock policy.

callback was initiated from, so the call does not lose the place in queue, regardless of where you transfer it.

Amazon Connect evaluates the routing profiles first so if the two queues have the same priority, the oldest call is pushed first across all queues with the same priorities. For example, if your original call arrived at 10:00 and left a callback request at 10:05, Amazon Connect looks for the call start time of 10:00, not 10:05.

Steps to set up queued callback

Use the steps provided in the following overview to set up queued callback.

- [Set up a queue](#) specifically for callbacks. In your real-time metrics reports, you can look at that queue and see how many customers are waiting for callbacks.
- [Set up caller ID](#). When setting your callback queue, specify the caller ID name and phone number that appears to customers when you call back.
- [Add the callback queue to a routing profile](#). Set this up so that contacts waiting for a call are routed to agents.
- [Create a flow for queued callbacks](#). You offer the option for a callback to the customer.
- [Associate a phone number with the inbound flow](#).
- (Optional) Create an outbound whisper flow. When a queued call is placed, the customer hears this message after they pick up and before they connect to the agent. For example, "Hello, this is your scheduled callback..."
- (Optional) Create an agent whisper flow. This is what the agent hears right after they accept the contact, before they are joined to the customer. For example, "You're about to be connected to Customer John, who requested a refund for..."

The routing process

1. When a customer leaves their number it's put in a queue and then routed to the next available agent.
2. After an agent accepts the callback in the CCP, Amazon Connect calls the customer.

If no agents are available to work on callbacks, the callbacks can stay in queue for up to 7 days after they are created before Amazon Connect automatically removes them.

Tip

To manually remove a callback from the queue, use the [StopContact](#) API.

3. If there is no answer when the Amazon Connect calls the customer, it retries based on the number of times you've specified.
4. If the call goes to **voicemail**, it's considered connected.
5. If the customer calls again while in the callback queue, it's treated as a new call and will be handled as usual. To avoid duplicate callback requests in a callback queue, see this blog: [Preventing duplicate callback requests in Amazon Connect](#).

How queued callbacks affect queue limits

- Queued callbacks count towards the queue size limit, but they are routed to the error branch. For example, if you have a queue that handles callbacks and incoming calls, and that queue reaches the size limit:
 - The next callback is routed to the error branch.
 - The next incoming call gets a reorder tone (also known as a fast busy tone), which indicates no transmission path to the called number is available.
- Consider setting up your queued callbacks to be lower priority than your queue for incoming calls. This way, your agents only work on queued callbacks when the incoming call volume is low.

Create a flow for queued callbacks

To see what a flow looks like with queued callback, in new Amazon Connect instances see [Sample queue configurations](#). In previous instances, see [Sample queued callback](#).

The following procedure shows how to:

- Request a callback number from a customer.
- Store the callback number in an attribute.
- Reference the attribute in a **Set callback number** block to set the number to dial the customer.
- Transfer the customer to the callback queue.

At the basic level, here's what this queued callback flow looks like, without any of the alternative branches or error handling configured. The following image shows a flow with the following blocks: **Get customer input**, **Store customer input**, **Set callback number**, **Play prompt**, **Transfer to queue**, and **Disconnect/hang up**.

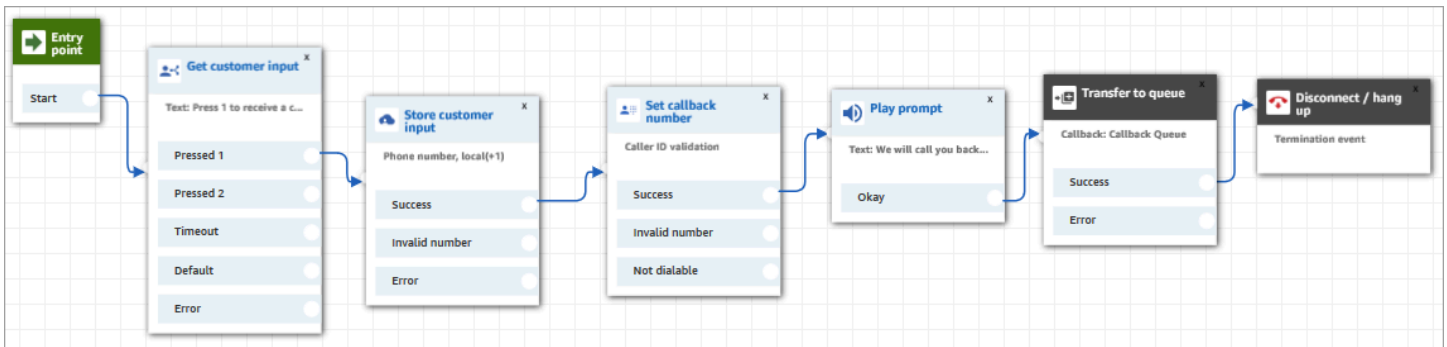

Following are the steps to create this flow.

To create a flow for queued callbacks

1. In Amazon Connect, choose **Routing, Contact flows**.
2. Select an existing flow, or choose **Create flow** to create a new one.

i Tip

You can create this flow using different flow types: Customer queue flow, Transfer to agent, Transfer to queue.

3. Add a [Get customer input](#) block.
4. Configure the block to prompt the customer for a callback. The following image shows a message in the **Text-to-speech** box: **Press 1 to receive a callback. Press 2 to stay in queue.**

Select from the prompt library (audio)

Text-to-speech or chat text

Enter text

Press 1 to receive a callback. Press 2 to stay in queue.

- At the bottom of the block, choose **Add another condition**, and add options 1 and 2, as shown in the following image.

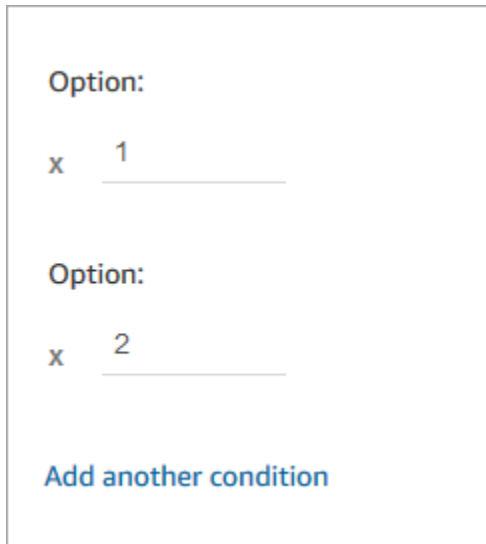

- Add a [Store customer input](#) block.
- Configure the block to prompt customers for their callback number, such as "Please enter your phone number." The following image shows the **Properties** page of the **Store customer input** block.

Store customer input

Stores numerical input to contact attribute.

Plays an interruptible audio prompt and stores digits via DTMF as a contact attribute.

Prompt

Select from the prompt library (audio)

Text to speech (Ad hoc)

Enter text

Please enter your phone number.

Enter dynamically

Interpret as

Text

8. In the **Customer input** section, select **Phone number**, and then choose one of the following:
 - **Local format:** Your customers are calling from phone numbers that are in the same country as the AWS Region where you created your Amazon Connect instance.
 - **International format/Enforce E.164:** Your customers are calling from phone numbers in countries or regions other than the one where you created your instance.
9. Add a [Set callback number](#) block to your flow.
10. Configure the block to set **Type** to **System**, as shown in the following image. For **Attribute**, choose **Store customer input**. This attribute stores the customer's phone number.

Set callback number

Specifies the number to be used to call the customer back in the Contact Control Panel (CCP), or when Transfer to queue is invoked with the callback option.

Use attribute

Type ▼

System

Attribute ▼

Stored customer input

11. Add a [Transfer to queue](#) block.
12. In the **Transfer to queue** block, configure the **Transfer to callback queue** tab as shown in the following image. Set **Initial delay** to 99. Set **Max number of retries** to 2. Set **Minimum time between attempts** to 10 minutes.

Transfer to queue
Transfer to callback queue

When you use Transfer to callback queue, you must use a 'Set customer callback number' block before this block in the flow to set the callback number for the customer.

Initial delay

99

in seconds

Max number of retries	Minimum time between attempts	
2	10	0
<hr/>	<hr/>	<hr/>
	minutes	seconds

The following properties are available:

- **Initial delay:** Specify how much time has to pass between a callback contact being initiated in the flow, and the customer is put in queue for the next available agent. In the previous example, the time is 99 seconds.
- **Maximum number of retries:** If this is set to 2, then Amazon Connect tries to call back the customer a maximum of three times: the initial callback, and two retries.

A retry only happens if it rings but there's no answer. If the callback goes to voicemail, it's considered connected and Amazon Connect does not retry again.

Tip

We strongly recommend that you double-check the number entered in **Maximum number of retries**. If you accidentally enter a high number, such as 20, it's going to result in unnecessary work for the agent and too many calls for the customer.

- **Minimum time between attempts:** If the customer doesn't answer the phone, this is how long to wait until trying again. In the previous example, we wait 10 minutes between attempts.
13. In the **Optional parameters** section, choose **Set working queue** if you want to transfer the contact to a queue that you set up specifically for callbacks. This option is shown in the following image.

Optional parameters:

- Set working queue
 - By queue
 - Select a queue
 - Callback Queue
 - Use attribute
 - By agent

Creating a queue just for callbacks lets you view in your real-time metrics reports how many customers are waiting for callbacks.

If you don't set a working queue, Amazon Connect uses the queue that was set previously in the flow.

14. To save and test this flow, configure the other branches and add error handling. To see an example of how this is done, see [Sample queue configurations](#). For previous instances, see [Sample queued callback](#).
15. For information about how callbacks appear in real-time metrics reports and contact records, see [About queued callbacks in metrics](#).

Learn more about queued callbacks

See the following topics to learn more about queued callbacks:

- [About queued callbacks in metrics](#)
- [How Initial delay affects Scheduled and In queue metrics](#)
- [What counts as a "Failed Callback Attempt"](#)
- [Example: Metrics for a queued callback](#)

Import/export flows

Use the procedures described in this topic to import/export a flows from the previous flow designer to the new one, from one instance to another, or from one Region to another as you expand your customer service organization.

Note

To copy and paste flows and blocks in the updated flow designer, the flow must be in the new flow language. To convert a legacy flow into the new format, you have two options:

- Option 1: In the flow designer, opt in to the updated flow designer. Your legacy flows are automatically converted.
- Option 2: Manually import the legacy flow using the updated flow designer.

This option is most useful for scenarios where you have stored your flows in JSON offline. For example, for configuration control, you may have flow configurations in an offline data store. To copy a part of that flow and paste it into the updated flow designer, you need to import it into the updated flow designer. The importing process converts it

to the new flow language. After that, you can copy and paste within the updated flow designer. If you want to keep using your offline data store as a source of truth, update the flow with the new format.

To migrate tens or hundreds of flows, use the APIs described in [Migrate flows to a different instance](#).

The Flow Import/Export feature is currently in Beta status. Updates and improvements that we make could result in issues in future releases importing flows that are exported during the beta phase.

Export limitations

You can export flows that meet the following requirements:

- The flow has fewer than 100 blocks.
- The total size of the flow is less than 1MB.

We recommend dividing large flows in to smaller ones to meet these requirements.

Flows are exported to JSON files

A flow is exported to a JSON file. It has the following characteristics:

- The JSON includes a section for each block in the flow.
- The name used for a specific block, parameter, or other element of the flow may be different than the label used for it in the flow designer.

By default, flow export files are created without a file name extension, and saved to the default location set for your browser. We suggest saving your exported flows to folder that contains only exported flows.

How to import/export flows

To export a flow

1. Log in to your Amazon Connect instance using an account that is assigned a security profile that includes view permissions for flows.

2. Choose **Routing, Contact flows**.
3. Open the flow to export.
4. Choose **Save, Export flow**.
5. Provide a name for the exported file, and choose **Export**.

To import a flow

1. Log in to your Amazon Connect instance. The account must be assigned a security profile that includes edit permissions for flows.
2. On the navigation menu, choose **Routing, Contact flows**.
3. Do one of the following:
 - To replace an existing flow with the one you are importing, open the flow to replace.
 - Create a new flow of the same type as the one you are importing.
4. Choose **Save, Import flow**.
5. Select the file to import, and choose **Import**. When the flow is imported into an existing flow, the name of the existing flow is updated, too.
6. Review and update any resolved or unresolved references as necessary.
7. To save the imported flow, choose **Save**. To publish, choose **Save and Publish**.

Resolve resources in imported contact flows

When you create a flow, the resources you include in the flow, such as queues and voice prompts, are referenced within the flow using the name of the resource and the Amazon Resource Name (ARN). The ARN is a unique identifier for a resource that is specific to the service and Region in which the resource is created. When you export a flow, the name and ARN for each resource referenced in the flow is included in the exported flow.

When you import a flow, Amazon Connect attempts to resolve the references to the Amazon Connect resources used in the flow, such as queues, by using the ARN for the resource.

- When you import a flow into the same Amazon Connect instance that you exported it from, the resources used in the flow will resolve to the existing resources in that instance.
- If you delete a resource, or change the permissions for a resource, Amazon Connect may not be able to resolve the resource when you import the flow.

- When a resource cannot be found using the ARN, Amazon Connect attempts to resolve the resource by finding a resource with the same name as the one used in the flow. If no resource with the same name is found, a warning is displayed on the block that contains a reference to the unresolved resource.
- If you import a flow into a different Amazon Connect instance than the one it was exported from, the ARNs for the resources used are different.
- If you create resources in the instance with the same name as the resource in the instance where the flow was exported from, the resources can be resolved by name.

You can also open the blocks that contain unresolved resources, or resources that were resolved by name, and change the resource to another one in the Amazon Connect instance.

You can save a flow with unresolved or missing resources. You can publish a flow with unresolved or missing resources only for optional parameters. If any required parameter has an unresolved resource, you cannot publish the flow until the resources are resolved.

Add an Amazon Lex bot to Amazon Connect

In this article we guide you through the steps to add an Amazon Lex bot to Amazon Connect.

With Amazon Lex, you can build conversational interactions (bots) that feel natural to your customers. Amazon Connect with Amazon Lex bots can also capture customer input as digits that customers enter on their numeric keypad when used in an Amazon Connect flow. This way customers can choose how they want to enter sensitive information such as account numbers.

To follow along with this walkthrough, you need the following:

- An active AWS account.
- An Amazon Connect instance.

Tip

You can also use Amazon Lex to power interactive messages for Amazon Connect chat. Interactive messages are rich messages that present a prompt and pre-configured display options that a customer can select from. These messages are powered by Amazon Lex and

configured through Amazon Lex using a Lambda. For more information, see [Add interactive messages to chat](#).

Create an Amazon Lex bot

In this step you'll create a custom bot to demonstrate the Press or Say integration with Amazon Connect. The bot prompts callers to press or say a number that matches the menu option for the task to complete. In this case, the input is checking their account balance.

Amazon Lex

1. Open the [Amazon Lex console](#).
2. Choose **Create bot**.
3. On the **Configure bot settings** page, choose **Create - Create a blank bot** and provide the following information:
 - **Bot name** — For this walkthrough, name the bot **AccountBalance**.
 - **IAM permissions** — Select a role if you have one created. Otherwise, choose **Create a role with basic Amazon Lex permissions**.
 - **COPPA** — Choose whether the bot is subject to the Child Online Privacy Protection Act.
 - **Session timeout** — Choose how long the bot should wait to get input from a caller before ending the session.
4. Choose **Next**.
5. Provide language and voice specific information:
 - **Language** — Select language and locale from the list of [Languages and locales supported by Amazon Lex](#).
 - **Voice interaction** — Select the voice for your bot to use when speaking to callers. The default voice for Amazon Connect is Joanna.
6. Choose **Done**. The AccountBalance bot is created, and the **Intent** page is displayed.

Amazon Lex (Classic)

1. Open the [Amazon Lex console](#).
2. If you are creating your first bot, choose **Get Started**. Otherwise, choose **Bots, Create**.

3. On the **Create your bot** page, choose **Custom bot** and provide the following information:
 - **Bot name** — For this walkthrough, name the bot **AccountBalance**.
 - **Output voice** — Select the voice for your bot to use when speaking to callers. The default voice for Amazon Connect is Joanna.
 - **Session timeout** — Choose how long the bot should wait to get input from a caller before ending the session.
 - **COPPA** — Choose whether the bot is subject to the Child Online Privacy Protection Act.
4. Choose **Create**.

Configure the Amazon Lex bot

In this step you'll determine how the bot responds to customers by providing intents, sample utterances, slots for input, and error handling.

For this example, you'll configure the bot with two intents: one to look up account information, and another to speak with an agent.

Create AccountLookup intent

Amazon Lex

1. After you created the bot, you are on the **Intents** page the Amazon Lex console. If you're not there, you can get there by choosing **Bots, AccountBalance, Bot versions, Draft version, Intents**. Choose **Add intent, Add empty intent**.
2. In the **Intent name** box, enter **AccountLookup**.
3. Scroll down the page to **Sample utterances**. In this step you enter utterances that allow the customer to elicit the AccountLookup intent. Enter the following utterances, and choose **Add utterance** after each one.
 - **Check my account balance**
 - **One:** This assigns the utterance of "one" or key press of "1" to the **AccountLookup** intent.

The following image shows where to add the utterance in the **Sample utterances** section.

▼ **Sample utterances (1)** [Info](#)

Representative phrases that you expect a user to speak or type to invoke this intent. Amazon Lex extrapolates based on the sample utterances to interpret any user input that may vary from the samples. The priority order of the sample utterances is not used to determine intent classification output.

Filter Sort by added (ascending) ▼

Preview Plain Text

Check my account balance

Enter the utterance in this box.

One **Add utterance**

Maximum 250 characters. Valid characters: A-Z, a-z, 0-9, @, #, \$

4. Scroll to the **Slots** section, and choose **Add slot**. Complete the box as follows:
 - a. **Required for this intent** = selected.
 - b. **Name** = **AccountNumber**.
 - c. **Slot type** = **AMAZON.Number**.
 - d. **Prompts** = the text to be spoken when the call is answered. For example, ask callers to enter their account number using their keypad: **Using your touch-tone keypad, please enter your account number**. Choose **Add**.

The following image shows a completed **Add slot** section.

Add slot ✕

A slot is used to capture information from the user to fulfill the intent.

Required for this intent
The bot will prompt for this slot during the conversation if a value is not provided by the user.

Name Slot type

Prompts

5. Scroll to the **Closing responses** section. Add a message for the bot to say to customers. For example, **Your account balance is \$1,234.56**. (For this walkthrough, we aren't going to actually get the data, which is what you would do in reality.)

The following image shows a completed **Closing responses** section.

Closing responses [Info](#)

You can define the response when closing the intent.

▼ Response sent to the user after the intent is fulfilled
Message: Your account balance is \$1,234.56

Message

Your account balance is \$1,234.56 ←

► Variations - optional

More response options

Add custom payloads, SSML, and card groups.

Draft version ▼ | **English (US)** **Not built**

Bot version | Language

Save intent | **Build** | **Test**

ⓘ You have changes that are not yet built.

6. Choose **Save intent**.

Amazon Lex (Classic)

1. In the Amazon Lex console choose the + icon next to **Intents**, and choose **Create new intent**.
2. Name the intent **AccountLookup**.
3. Add a sample utterance, such as *Check my account balance*, and choose the + icon.
4. Add a second utterance, such as *One* and choose the + icon. This assigns the utterance of "one" or key press of "1" to the **AccountLookup** intent.

Tip

You must add an utterance of "one" in the bot, and not the number "1". This is because Amazon Lex doesn't support numeric input directly. To get around this,

later in this walkthrough you'll use numeric input to interact with a Lex bot invoked from a flow.

- Under **Slots**, add a slot named **AccountNumber**.

The following image shows the location of the **Slots** section on the page.

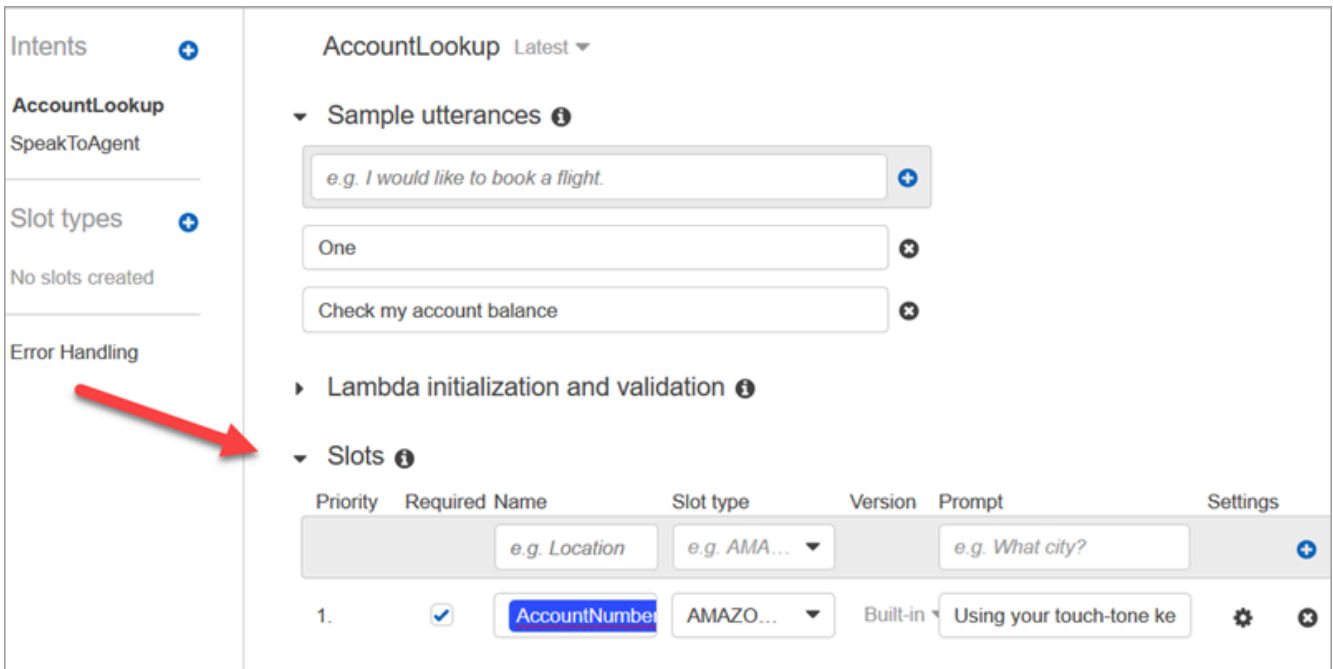

- For **Slot type**, use the drop-down to choose **AMAZON.NUMBER**.
- For **Prompt**, add the text to be spoken when the call is answered. For example, ask callers to enter their account number using their keypad: *Using your touch-tone keypad, please enter your account number.*
- Choose the + icon.
- Make sure that the **Required** check box is selected.
- In the **Response** section, add a message for the bot to say to customers. For example, **Your account balance is \$1,234.56.**
- Choose **Save Intent**.

Create SpeakToAgent intent

Amazon Lex

- Navigate to the **Intents** page: choose **Back to intents list**.

2. Choose **Add intent, Add empty intent**.
3. In the **Intent name** box, enter **SpeakToAgent**, and then choose **Add**.
4. Scroll down to **Sample utterances** section. Enter the following utterances, which allow the customer to elicit the SpeakToAgent intent:
 - **Speak to an agent**
 - **Two**
5. Scroll down to the **Closing responses** section. Add a message for the bot to say to customers. For example, **Okay, an agent will be with you shortly**.
6. Choose **Save intent**.

Amazon Lex (Classic)

1. In the Amazon Lex console choose the **+** icon next to **Intents**, and choose **Create new intent**.
2. Name the intent **SpeakToAgent**.
3. Select **SpeakToAgent**.
4. Add a sample utterance, such as *Speak to an agent*, and choose **+**.
5. Add a second utterance, such as *Two*, and choose **+**.
6. Add a message that lets callers know that their call is being connected to an agent. For example, "Okay, an agent will be with you shortly."
7. Choose **Save Intent**.

Build and test the Amazon Lex bot

After you create your bot, make sure it works as intended.

Amazon Lex

1. At the bottom of the page, choose **Build**. It may take a minute or two. The following image shows where the **Build** button is located.

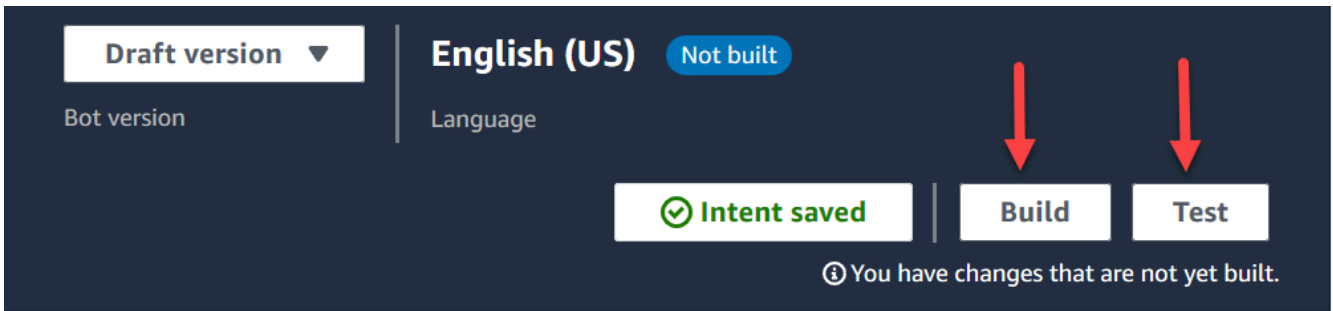

2. When it's finished building, choose **Test**.
3. Let's test the **AccountLookup** intent: In the **Test Draft version** pane, in the **Type a message** box, type **1** and press Enter. Then type a fictitious account number and press Enter. The following image shows where you enter intent.

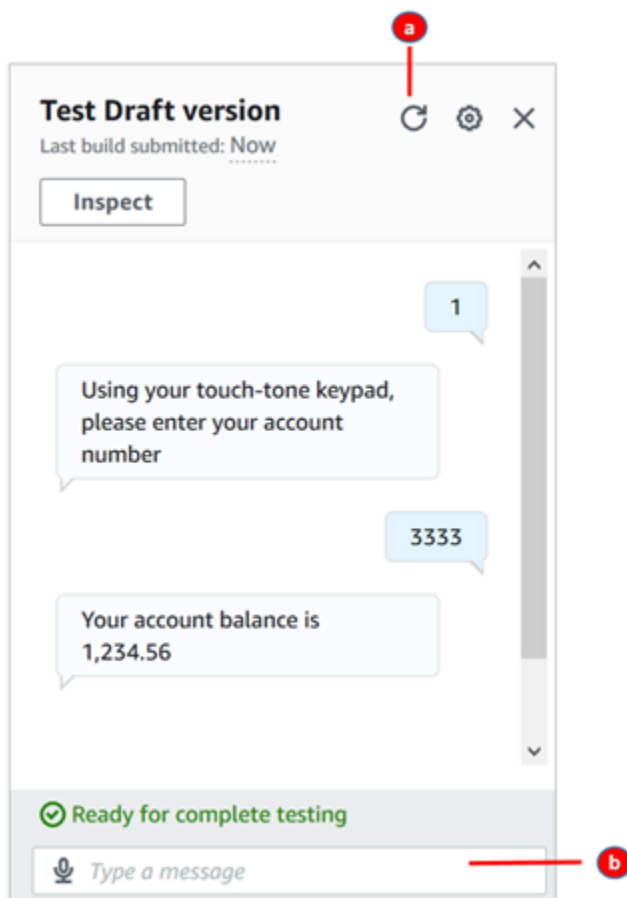

- a. Clear the test box.
 - b. Type the intents you want to test.
4. To confirm that the **SpeakToAgent** intent is working, clear the test box, and then type **2** and press Enter. The following image shows what the test looks like after you clear it and then enter 2.

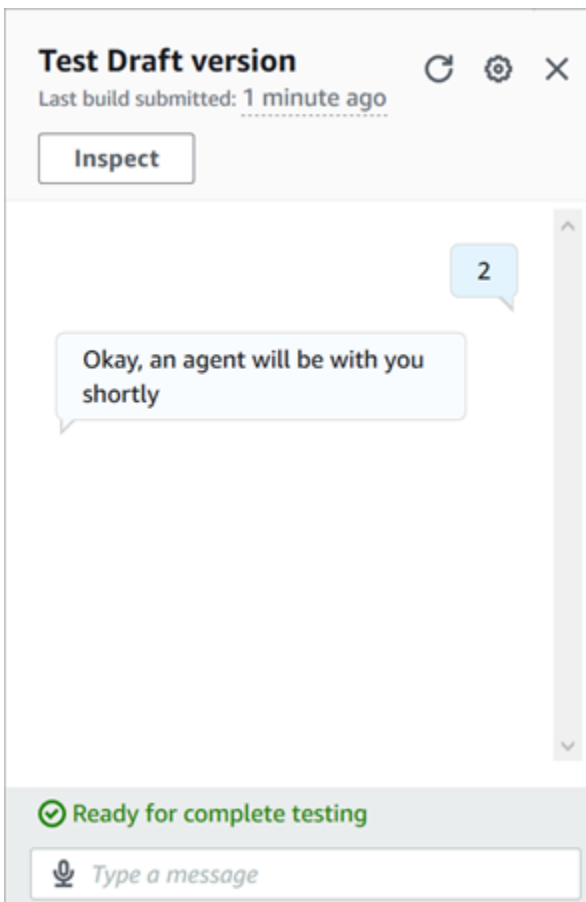

5. Close the **Test Draft version** pane.

Amazon Lex (Classic)

1. Choose **Build**. It may take a minute or two.
2. When it's finished building, choose **Test Chatbot**, as shown in the following image.

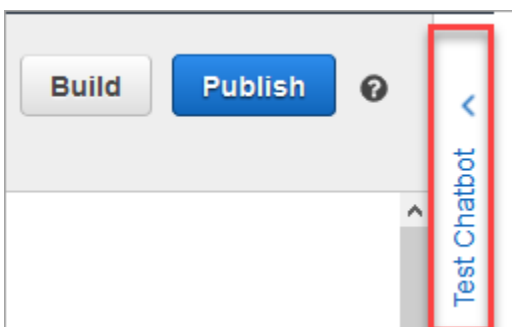

3. Let's test the **AccountLookup** intent: In the **Test Chatbot** pane, in the **Chat with your bot** box, type **1**. Then type a fictitious account number. In the following image, the arrow points to the box where you type 1.

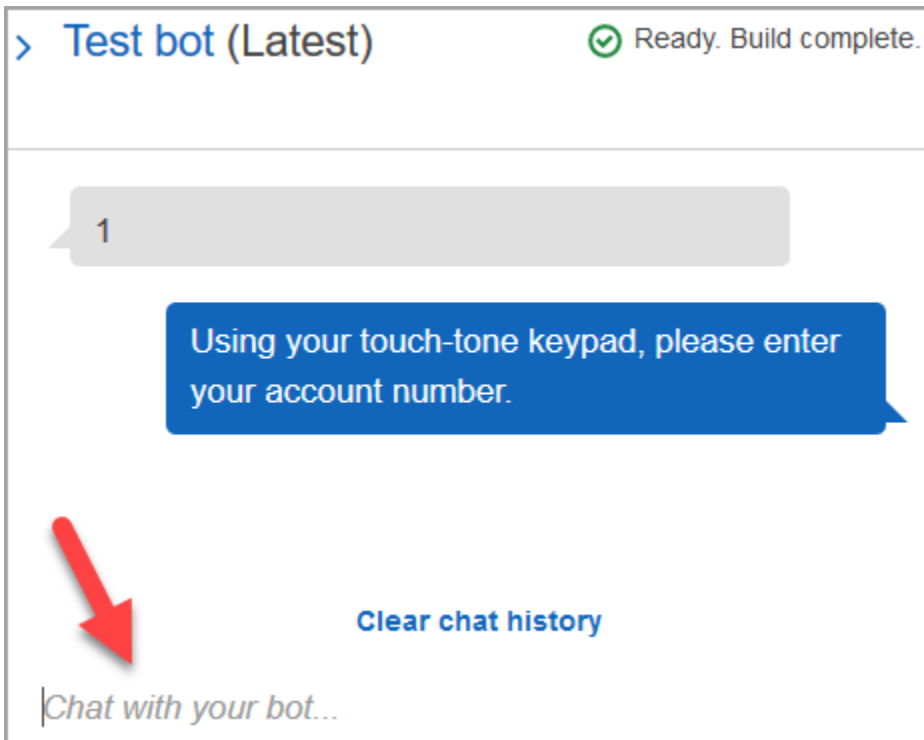

4. Choose **Clear chat history**.
5. To confirm that the **SpeakToAgent** intent is working, type **2**.

Create a bot version (Optional)

In this step you create a new bot version to use in an alias. It's how you create an alias that can be used in a production environment. Test aliases are subject to lower throttling limits. Although this is a test walkthrough, creating a version is a best practice.

Amazon Lex

1. If you're on the **Intents** page, choose **Back to intents list**.
2. On the left menu, choose **Bot versions**.
3. Choose **Create version**.
4. Review the details of the **AccountBalance** bot, and then choose **Create**.

This creates a version of your bot (Version 1). You can switch versions on a non-test alias without having to track which version is getting published.

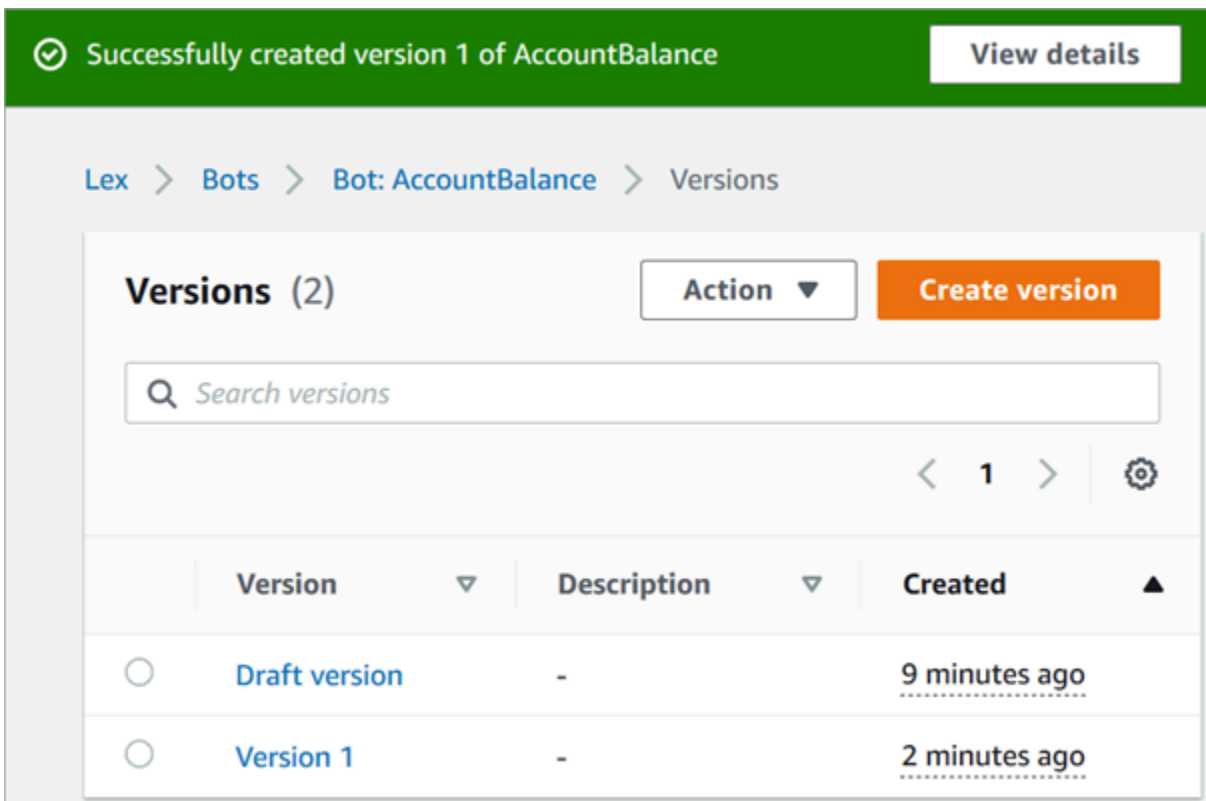

Create an alias for the bot

Amazon Lex

1. In the left menu, choose **Aliases**.
2. On the **Aliases** page, choose **Create alias**.
3. In the **Alias name** box, enter a name, such as **Test**. Later in this walkthrough you'll use this alias to specify this version of the bot in your flow.

⚠ Important

In a production environment, always use a different alias than **TestBotAlias** for Amazon Lex and **\$LATEST** for Amazon Lex classic. **TestBotAlias** and **\$LATEST** support a limited number of concurrent calls to an Amazon Lex bot. For more information, see [Runtime quotas](#).

4. For **Associated version**, choose the version you just created, such as **Version 1**.
5. Choose **Create**.

Amazon Lex (Classic)

1. Choose **Publish**.
2. Provide an alias for your bot. Use the alias to specify this version of the bot in the flow, for example, **Test**.

Important

In a production environment, always use a different alias than **TestBotAlias** for Amazon Lex and **\$LATEST** for Amazon Lex classic. **TestBotAlias** and **\$LATEST** support a limited number of concurrent calls to an Amazon Lex bot. For more information, see [Runtime Service Quotas](#).

3. Choose **Publish**.

Add the Amazon Lex bot to your Amazon Connect instance

Amazon Lex

1. Open the [Amazon Connect console](#).
2. Select the Amazon Connect instance that you want to integrate with your Amazon Lex bot.

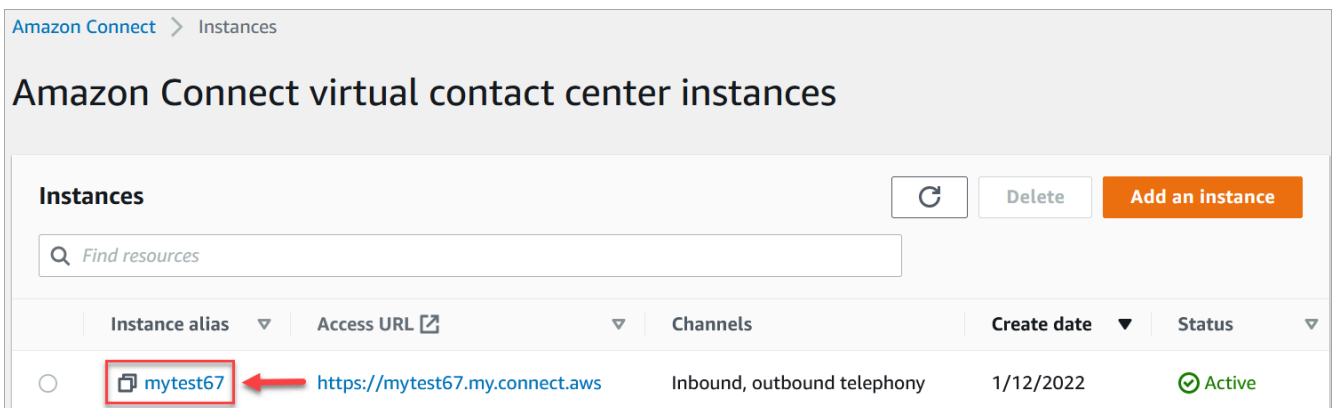

3. On the navigation menu, choose **Flows**.
4. Under **Amazon Lex**, use the dropdown to select the Region of your Amazon Lex bot, and then select your Amazon Lex bot, **AccountBalance**.
5. Select the Amazon Lex bot alias name from the dropdown (**Test**), and then choose **+ Add Lex Bot**. The following image shows Amazon Lex section after it has been configured.

Amazon Lex

Integrate Amazon Lex bots into your contact flow using natural language understanding technology that

Note: By adding Lex bots, you are granting Amazon Connect permissions to invoke the bot. For more information, see [new Lex bot](#) 

Region	Canada: Central ▼
Bot	AccountBalance ▼
Alias	Test ▼

[+ Add Lex Bot](#)

Note

Amazon Connect uses Amazon Lex resource-based policies to make calls to your Amazon Lex bot. When you associate an Amazon Lex bot with your Amazon Connect instance, the resource-based policy on the bot is updated to give Amazon Connect permission to invoke the bot. For more information on Amazon Lex resource-based policies, see [How Amazon Lex works with IAM](#).

Amazon Lex (Classic)

1. Open the [Amazon Connect console](#).
2. Select the Amazon Connect instance that you want to integrate with your Amazon Lex bot.
3. On the navigation menu, choose **Contact flows**.

4. Under **Amazon Lex**, select the Region of your Amazon Lex classic bot from the dropdown, and then select your Amazon Lex classic bot. It's name will have the suffix "(Classic)". Then choose **Add Lex Bot**.

Create a flow and add your Amazon Lex bot

Important

If you're using an Amazon Lex V2 bot, your language attribute in Amazon Connect must match the language model used to build your Lex bot. This is different than Amazon Lex (Classic). Use a [Set voice](#) block to indicate the Amazon Connect language model, or use a [Set contact attributes](#) block.

Next, create a new flow that uses your Amazon Lex bot. When you create the flow, you configure the message played to callers.

1. Log in to your Amazon Connect instance with an account that has permissions for contact flows and Amazon Lex bots.
2. On the navigation menu, choose **Routing, Flows, Create Flow**, and type a name for the flow.
3. Under **Interact**, drag a [Get customer input](#) block onto the designer, and connect it to the **Entry point block**.
4. Choose the **Get customer input** block to open it. Choose **Text to speech or chat text, Enter text**.
5. Type a message that provides callers with information about what they can do. For example, use a message that matches the intents used in the bot, such as "To check your account balance, press or say 1. To speak to an agent, press or say 2." The following image shows this message on the Properties page of the **Get customer input** block.

Get customer input

Delivers an audio or chat message to solicit customer input.

Based on response, the contact flow branches. [Learn more](#)

Select from the prompt library (audio)

Text-to-speech or chat text

Enter text

To check your account balance, press or say 1. To speak to an agent, press or say 2.

Enter dynamically

Interpret as

Text v

6. Select the **Amazon Lex** tab, as shown in the following image.

Get customer input

Delivers an audio or chat message to solicit customer input.

DTMF Amazon Lex

Plays an audio prompt and branches based on DTMF or Amazon Lex intents. The audio prompt is interruptible when using DTMF.

Lex bot

Select a Lex bot

Name

AccountBalance (CA: Central) x ▾

Alias

Test x ▾

7. In the **Name** dropdown, select the **AccountBalance** bot you created earlier.
 - a. If you selected an Amazon Lex bot, under **Alias** use the dropdown menu to select the bot alias, **Test**.
 - b. Amazon Lex Classic bots have the suffix "(Classic)" appended to their names. If you have selected a Classic bot, enter the alias you want to use in the **Alias** field.
 - c. For Amazon Lex V2 bots, you also have the option of manually setting a bot alias ARN. Choose **Set manually**, then either type the ARN of the bot alias you want to use or set the ARN using a dynamic attribute.
8. Under **Intents**, choose **Add an intent**.
9. Type **AccountLookup** and choose **Add another intent**. The following image shows the **Intents** section configured with this information.

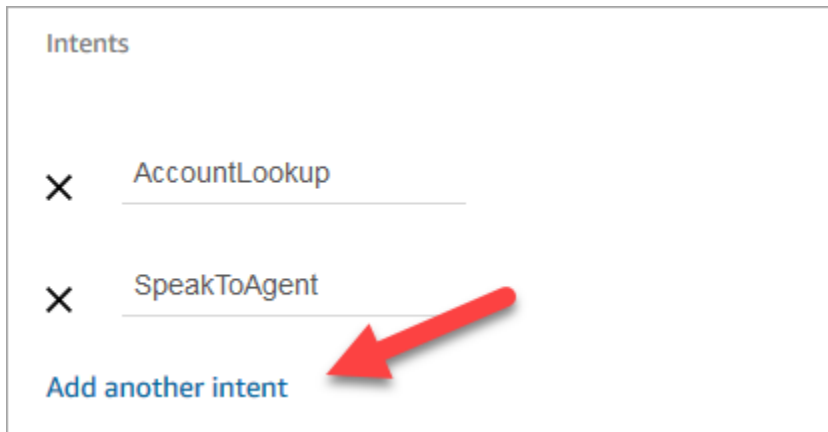

10. Type **SpeakToAgent** and choose **Save**.

Finish the flow

In this step you finish adding parts to the flow that run after the caller interacts with the bot:

1. If the caller presses 1 to get their account balance, use a **Prompt** block to play a message and disconnect the call.
2. If the caller presses 2 to speak to an agent, use a **Set queue** block to set the queue and transfer the caller to the queue, which ends the flow.

Here are the steps to create the flow:

1. Under **Interact**, drag a **Play prompt block** to the designer, and connect the **AccountLookup** node of the **Get customer input** block to it. After the customer gets their account balance from the Amazon Lex bot, the message in the **Play prompt** block plays.
2. Under **Terminate/Transfer**, drag a **Disconnect** block to the designer, and connect the **Play prompt** block to it. After the prompt message plays, the call is disconnected.

To complete the **SpeakToAgent** intent:

1. Add a **Set working queue** block and connect it to the **SpeakToAgent** node of the **Get customer input** block.
2. Add a **Transfer to queue** block.
3. Connect the Success node of the **Set customer queue flow** block to the **Transfer queue**.
4. Choose **Save**, then **Publish**.

Your finished flow will look something like the following image. The flow starts with the **Get customer input** block. That block branches to **Play prompt** or **Set customer queue**.

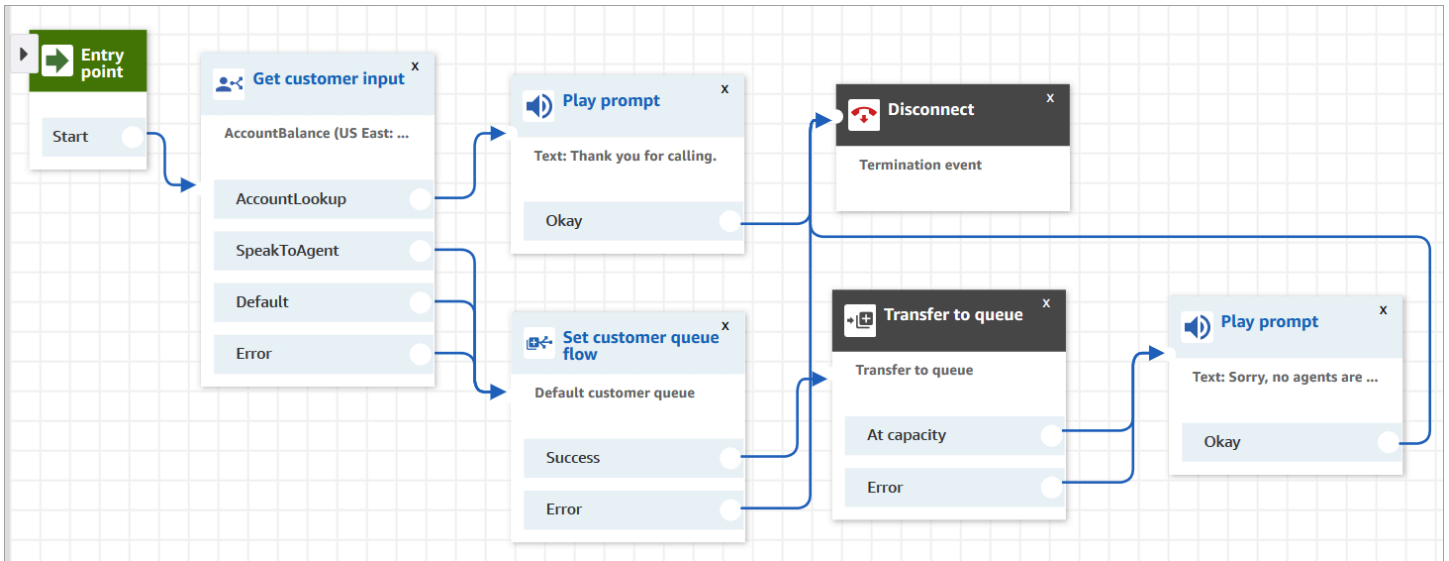

Tip

If your business uses multiple locales in a single bot, add a [Set contact attributes](#) block to the beginning of your flow. Configure this block to use the `$.LanguageCode` system attribute.

Assign the flow to a phone number

When customers call in to your contact center, the flow to which they are sent is the one assigned to the telephone number that they called. To make the new flow active, assign it to a phone number for your instance.

1. Open the Amazon Connect console.
2. Choose **Routing, Phone numbers**.
3. On the **Manage Phone numbers** page, select the phone number to assign to the flow.
4. Add a description.
5. In the **Flow/IVR** menu, choose the flow that you just created.
6. Choose **Save**.

Try it!

To try the bot and flow, call the number you assigned to the flow. Follow the prompts.

Add interactive messages to chat

Interactive messages are rich messages that present a prompt and pre-configured display options for a customer to choose. These messages are powered by Amazon Lex and configured through Amazon Lex using a Lambda.

Tip

If you have integrated with Apple Messages for Business, see [Interactive Message Types](#) on the Apple website.

Validation limits

The string field limits (for example, title, subtitle, etc.) are expected to be enforced by the client (that is, a custom built interface or the hosted communications widget). The [SendMessage](#) API checks only that the total size of the string is less than 20KB.

- When you use the hosted communications widget without customizing it, if the string exceeds field limits, it is truncated on the user interface and an ellipsis (...) is appended. You can determine how to enforce field limits by customizing the widget.
- If you are integrating with other platforms (such as Apple Messages for Business), review the limits in this topic for Amazon Connect, and review the limits in the documentation for the other platform. For example, quick replies are not supported on older versions of iOS.

All other field limits must be followed for the message to be successfully sent.

Message display templates

Amazon Connect provides the following message display templates for you to use to render information to customers in a chat:

- [List picker](#)
- [Time picker](#)

- [Panel](#)
- [Quick reply](#)
- [Carousel](#)
- [Apple form template](#)
- [Apple pay template](#)
- [iMessage app template](#)
- [Rich formatting in titles and subtitles](#)

These templates define how the information is going to render, and what information is surfaced in the chat interface. When interactive messages are sent through chat, flows validate that the message format follows one of these templates.

List picker template

Use the list picker template to present the customer with a list of up to six choices. Each choice can have its own image.

The following images show two examples of how the list picker template renders information in a chat.

- One image shows three buttons, each one with the name of a fruit in text: apple, orange, banana.
- The second image shows a picture of a store and then under it, three buttons, each one with the name, image, and price of the fruit.

List picker

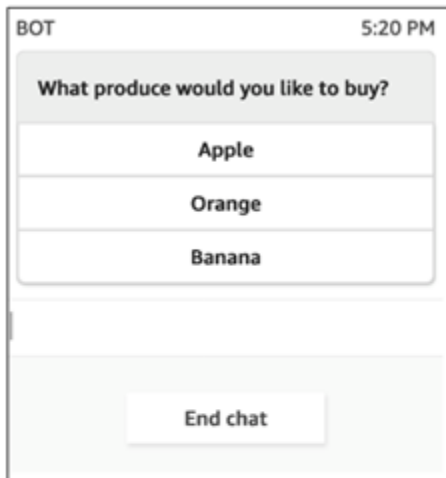

List picker with images

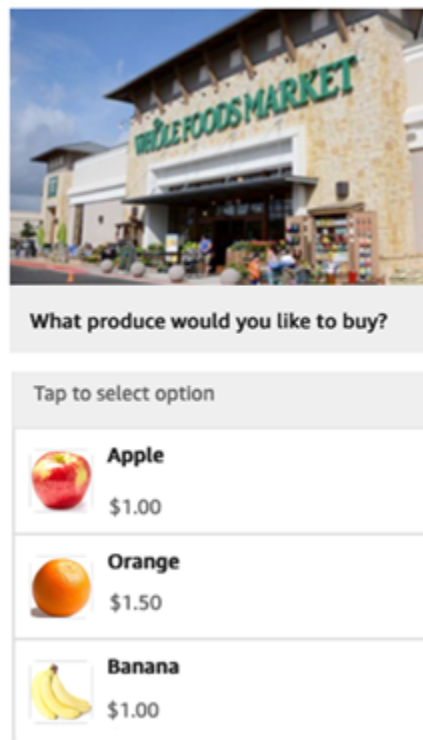

The following code is the list picker template that you can use in your Lambda. Note the following:

- **Bold text** is a mandatory parameter.
- In some cases, if the parent element exists in the request and it isn't mandatory/bold, but the fields in it are, then the fields are mandatory. For example, see `data.replyMessage` structure in the following template. If the structure exists, `title` is mandatory. Otherwise complete `replyMessage` is optional.

```
{
  "templateType": "ListPicker",
  "version": "1.0",
  "data": {
    "replyMessage": {
      "title": "Thanks for selecting!",
      "subtitle": "Produce selected",
      "imageType": "URL",
      "imageData": "https://interactive-msg.s3-us-west-2.amazonaws.com/fruit_34.3kb.jpg",
      "imageDescription": "Select a produce to buy"
    }
  },
}
```

```

    "content":{
      "title":"What produce would you like to buy?",
      "subtitle":"Tap to select option",
      "imageType":"URL",
      "imageData":"https://interactive-msg.s3-us-west-2.amazonaws.com/
fruit_34.3kb.jpg",
      "imageDescription":"Select a produce to buy",
      "elements":[
        {
          "title":"Apple",
          "subtitle":"$1.00",
          "imageType":"URL",
          "imageData":"https://interactive-message-testing.s3-us-
west-2.amazonaws.com/apple_4.2kb.jpg"
        },
        {
          "title":"Orange",
          "subtitle":"$1.50",
          "imageType":"URL",
          "imageData":"https://interactive-message-testing.s3-us-
west-2.amazonaws.com/orange_17.7kb.jpg",
        },
        {
          "title":"Banana",
          "subtitle":"$10.00",
          "imageType":"URL",
          "imageData":"https://interactive-message-testing.s3-us-
west-2.amazonaws.com/banana_7.9kb.jpg",
          "imageDescription":"Banana"
        }
      ]
    }
  }

```

List picker limits

The following table lists the limits for each of the list picker elements, should you choose to build your own Lambda from scratch. The mandatory parameters are in bold.

To send unlimited options, implement action buttons in your application. For more information, see [Implementation of action buttons in interactive message list picker/panel](#).

Parent field	Field	Required	Minimum characters	Maximum characters	Other requirement
	templateType	Yes			Valid template type
	data	Yes			
	version	Yes			Must be "1.0"
data	content	Yes			
	replyMessage	No			
content	title	Yes	1	400	Should be a description for promptless templates
	elements	Yes	1 item	10 items	This is an array of elements. Maximum 10 elements in the array. To send unlimited elements, use the action buttons feature.
	subtitle	No	0	400	
	imageType	No	0	50	Must be "URL"
	imageData	No	0	200	Must be a valid publicly accessible URL

Parent field	Field	Required	Minimum characters	Maximum characters	Other requirement
	imageDescription	No	0	50	
	referenceId	No			String. Only required for action button feature.
	listId	No			String. Only required for action button feature.
	preIndex	No			Number. Only required for action button feature.
	nextIndex	No			Number. Only required for action button feature.
	templateIdentifier	No			Number. Should be an UUID. This field is required if List Picker/Panel is being used in a Carousel.
elements	title	Yes	1	400	
	subtitle	No	0	400	

Parent field	Field	Required	Minimum characters	Maximum characters	Other requirement
	imageType	No	0	50	Must be "URL"
	imageData	No	0	200	Must be a valid publicly accessible URL
	imageDescription	No	0	50	Cannot exist without an image
	actionDetail	No			Only required for action button feature. Must be "PREVIOUS_OPTIONS" or "SHOW_MORE".
replyMessage	title	Yes	1	400	
	subtitle	No	0	400	
	imageType	No	0	50	Must be "URL"
	imageData	No	0	200	Must be a valid publicly accessible URL
	imageDescription	No	0	50	Cannot exist without an image

Time picker template

The time picker template is useful for enabling customers to schedule appointments. You can provide up to 40 timeslots to the customer in a chat.

The following images show two examples of how the time picker template renders information in a chat.

- One image shows one date, and under it, one time slot.
- The second image shows one date, and under it, two time slots.

Time picker with 1 timeslot

The screenshot shows a chat window with a bot header 'BOT' and a timestamp '10:34 AM'. The main content area is titled 'Schedule appointment' and includes the instruction 'Tap to select option'. Below this is a date picker showing 'Saturday, October 31' with left and right navigation arrows. Underneath the date is a single time slot button labeled '10:00 AM PDT'. At the bottom of the chat window is a text input field with the placeholder 'Type a message' and an 'End chat' button.

Time picker with 2 time slots

The screenshot shows a chat window with a bot header 'BOT' and a timestamp '10:34 AM'. The main content area is titled 'Schedule appointment' and includes the instruction 'Tap to select option'. Below this is a date picker showing 'Sunday, November 15' with left and right navigation arrows. Underneath the date are two time slot buttons labeled '5:00 AM PST' and '8:00 AM PST'. At the bottom of the chat window is a text input field with the placeholder 'Type a message' and an 'End chat' button.

The following code is the time picker template that you can use in your Lambda. Note the following:

- **Bold text** is a mandatory parameter.
- In some cases, if the parent element exists in the request and it isn't mandatory/bold, but the fields in it are, then the fields are mandatory. For example, see `data.replyMessage` structure in the following template. If the structure exists, `title` is mandatory. Otherwise complete `replyMessage` is optional.

```

{
  "templateType":"TimePicker",
  "version":"1.0",
  "data":{
    "replyMessage":{
      "title":"Thanks for selecting",
      "subtitle":"Appointment selected",
    },
    "content":{
      "title":"Schedule appointment",
      "subtitle":"Tap to select option",
      "timeZoneOffset":-450,
      "location":{
        "latitude":47.616299,
        "longitude":-122.4311,
        "title":"Oscar",
        "radius":1,
      },
      "timeslots":[
        {
          "date" : "2020-10-31T17:00+00:00",
          "duration": 60,
        },
        {
          "date" : "2020-11-15T13:00+00:00",
          "duration": 60,
        },
        {
          "date" : "2020-11-15T16:00+00:00",
          "duration": 60,
        }
      ],
    }
  }
}

```

Time picker limits

The following table lists the limits for each of the time picker elements. Use this information if you choose to build your own Lambda from scratch. The mandatory parameters are in bold.

Parent field	Field	Required	Minimum characters	Maximum characters	Other requirement
	templateType	Yes			Valid template type
	data	Yes			
	version	Yes			Must be "1.0"
data	replyMessage	No			
	content	Yes			
replyMessage	title	Yes	1	400	Should be description for promptless templates
	subtitle	No	0	400	
content	title	Yes	1	400	Should be description for promptless templates
	subtitle	No	0	200	
	timezone offset	No	-720	840	This is an optional field when not set. Our sample client defaults to the user's timezone. If set, this displays per

Parent field	Field	Required	Minimum characters	Maximum characters	Other requirement
					the timezone entered. The field should be an integer representing the number of minutes from GMT, specifying the timezone of the event's location.
	location	No			
	timeslots	Yes	1	40	This is an array of timeslots. Maximum of 40 elements in the array.
location	longitude	Yes	-180	180	Must be double
	latitude	Yes	-90	90	Must be double
	title	Yes	1	400	
	radius	No	0	200	

Parent field	Field	Required	Minimum characters	Maximum characters	Other requirement
	timeslotsdate	Yes			Should be in ISO-8601 time format: YYYY-MM-DDTHH.MM+00.00 For example: "2020-08-14T21:21+00.00"
	duration	Yes	1	3600	

Panel template

By using the panel template, you can present the customer with up to 10 choices under one question. However, you can include only one image, rather than an image with each choice.

The follow image shows an example of how the panel template renders information in a chat. It shows an image at the top of the message, and under the image it shows a prompt that asks *How can I help? Tap to select option*. Under the prompt three options are displayed to the customer: **Check self-service options, Talk to an agent, End chat**.

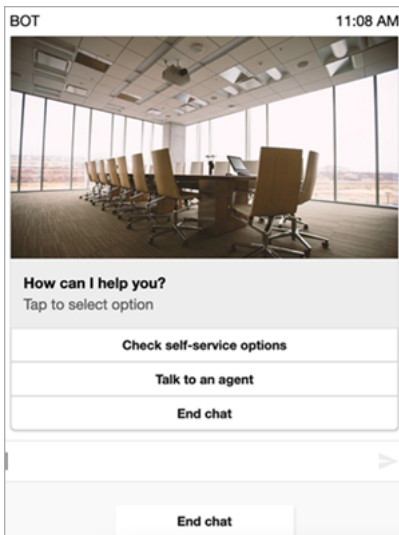

The following code is the panel template that you can use in your Lambda. Note the following:

- **Bold text** is a mandatory parameter.
- In some cases, if the parent element exists in the request and it isn't mandatory/bold, but the fields in it are, then the fields are mandatory. For example, see `data.replyMessage` structure in the following template. If the structure exists, `title` is mandatory. Otherwise, complete `replyMessage` is optional.

```
{
  "templateType": "Panel",
  "version": "1.0",
  "data": {
    "replyMessage": {
      "title": "Thanks for selecting!",
      "subtitle": "Option selected",
    },
    "content": {
      "title": "How can I help you?",
      "subtitle": "Tap to select option",
      "imageType": "URL",
      "imageData": "https://interactive-msg.s3-us-west-2.amazonaws.com/company.jpg",
      "imageDescription": "Select an option",
      "elements": [
        {
          "title": "Check self-service options",
        },
      ],
    },
  },
}
```

```

    {
      "title": "Talk to an agent",
    },
    {
      "title": "End chat",
    }
  ]
}
}
}

```

Panel limits

The following table lists the limits for each of the panel elements, should you choose to build your own Lambda from scratch. The mandatory parameters are in bold.

To send unlimited options, implement action buttons in your application. For more information, see [Implementation of action buttons in interactive message list picker/panel](#).

Parent field	Field	Required	Minimum characters	Maximum characters	Other requirement
	templateType	Yes			Valid template type
	data	Yes			
	version	Yes			Must be "1.0"
data	replyMessage	No			
	content	Yes			
content	title	Yes	1	400	Should be a description for promptless templates
	subtitle	No	0	400	

Parent field	Field	Required	Minimum characters	Maximum characters	Other requirement
	elements	Yes	1 item	10 items	This is an array of elements. Maximum 10 elements in the array.
	imageType	No	0	50	Must be "URL"
	imageData	No	0	200	Must be a valid publicly accessible URL
	imageDescription	No	0	50	Cannot exist without an image
	referenceId	No			String. Only required for action button feature.
	listId	No			String. Only required for action button feature.
	preIndex	No			Number. Only required for action button feature.
	nextIndex	No			Number. Only required for action button feature.

Parent field	Field	Required	Minimum characters	Maximum characters	Other requirement
	templatel dentifier	No			Number. Should be an UUID. This field is required if List Picker/Panel is being used in a Carousel.
elemen	title	Yes	1	400	
	actionDetail	No			Only required for action button feature. Must be "PREVIOUS _OPTIONS" or "SHOW_MOR E".
replyMes age	title	Yes	1	400	
	subtitle	No	0	400	

Quick reply template

Use quick reply messages to get simple responses from customers and them to customers in an in-line list. You can present customers with up to 5 options in one quick reply message. Images are not supported for quick replies.

The following image shows an example of how the quick reply template renders information in a chat.

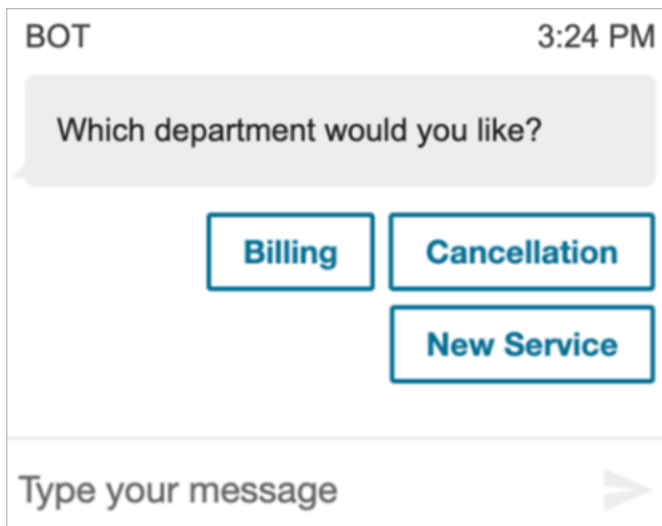

The following code is the quick reply template that you can use in your Lambda.

```
{
  "templateType": "QuickReply",
  "version": "1.0",
  "data": {
    "content": {
      "title": "Which department would you like?",
      "elements": [
        {
          "title": "Billing"
        },
        {
          "title": "Cancellation"
        },
        {
          "title": "New Service"
        }
      ]
    }
  }
}
```

Quick reply limits

The following table lists the limits for each of the quick reply elements. Use this information if you choose to build your own Lambda from scratch. The mandatory parameters are in bold.

Field	Required	Minimum characters	Maximum characters	Other requirements
template type				Valid template type
data	Yes			
version	Yes			Must be "1.0"
content	Yes			
title	Yes	1	400	Should be a description for promptless templates
elements	Yes	2 item	10 items	This is an array of elements. Minimum 2 elements and maximum 10 elements in the array.
title	Yes	1	200	

Carousel template

Use carousels to display up to 5 list pickers or panels to customers in a single message. Similar to the list picker and time picker, you can add more options to the carousel by using the `SHOW_MORE` feature.

The following GIF shows an example of how the carousel template renders information in a chat. Customers scroll through the carousel of images by using the left and right arrows.

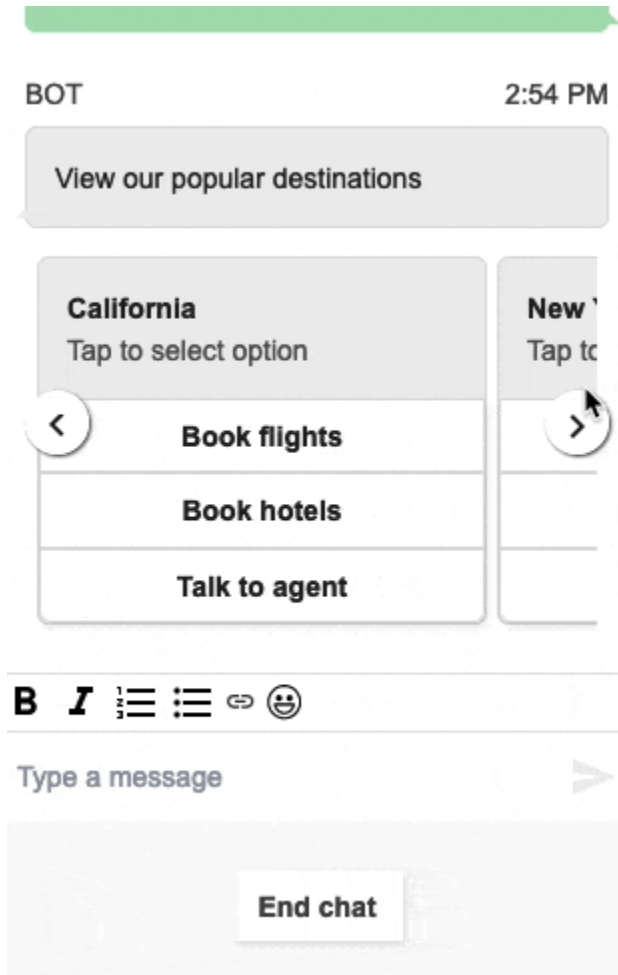

The following image shows two **Learn More** hyperlinks, which are examples of carousel picker hyperlink elements.

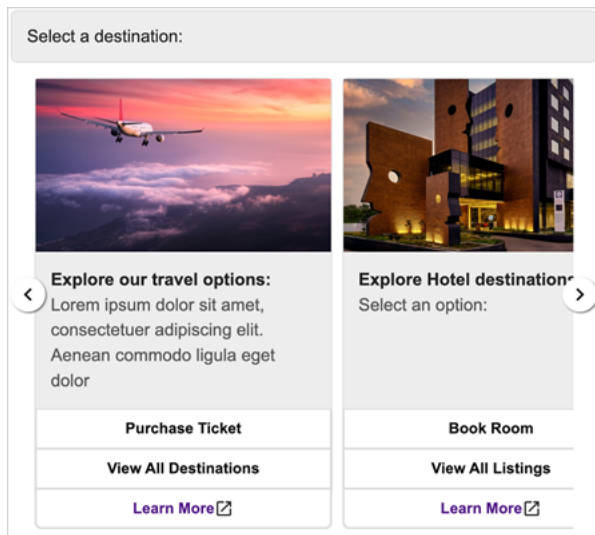

The following code is the carousel template that you can use in your Lambda.

```
{
  "templateType": "Carousel",
  "version": "1.0",
  "data": {
    "content": {
      "title": "View our popular destinations",
      "elements": [
        {
          "templateIdentifier": "template0",
          "templateType": "Panel",
          "version": "1.0",
          "data": {
            "content": {
              "title": "California",
              "subtitle": "Tap to select option",
              "elements": [
                {
                  "title": "Book flights"
                },
                {
                  "title": "Book hotels"
                },
                {
                  "title": "Talk to agent"
                }
              ]
            }
          }
        },
        {
          "templateIdentifier": "template1",
          "templateType": "Panel",
          "version": "1.0",
          "data": {
            "content": {
              "title": "New York",
              "subtitle": "Tap to select option",
              "elements": [
                {
                  "title": "Book flights"
                },
                {
                  "title": "Book hotels"
                }
              ]
            }
          }
        }
      ]
    }
  }
}
```

```
        },
        {
          "title": "Talk to agent"
        }
      ]
    }
  }
}
}
```

For hosted communications widget users:

- The selections on the carousel template result in a JSON string response structured like the following example, to be sent back to Lambda (other interactive message types return regular string response with only `selectionText` value):

```
{
  templateIdentifier: "template0",
  listTitle: "California",
  selectionText: "Book hotels"
}
```

- In carousels, you can provide hyperlinks in the list picker/panel elements. To create a hyperlink instead of a button, include the following additional fields for the element that should be a hyperlink:

```
{
  title: "Book flights",
  ...
  type: "hyperlink",
  url: "https://www.example.com/Flights"
}
```

Carousel limits

The following table lists the limits for each of the carousel elements. Use this information if you choose to build your own Lambda from scratch. The mandatory parameters are in bold.

Parent field	Field	Required	Minimum characters	Maximum characters	Other requirement
	templateType	Yes			Valid template type
	data	Yes			
	version	Yes			Must be "1.0"
data	content	Yes			
	content title	Yes	1	400	Should be a description for promptless templates
	elements	Yes	2 item	5 items	This is an array of either list pickers or panel templates . Only one interactive message type is accepted per carousel. Each element should include the top-level field templateIdentifier . Minimum 2 templates and maximum 5 templates in the array.

Parent field	Field	Required	Minimum characters	Maximum characters	Other requirement
					<div style="border: 1px solid #ccc; border-radius: 10px; padding: 10px; background-color: #e6f2ff;"> <p> Note</p> <p>For the best customer experience, we recommend that each template has consistent use of images/ number of elements.</p> </div>
	<p>omitTitleFromCarouselResponse</p>	<p>No</p>			<p>Boolean - Optionally respond with "<i>Selection Text</i>" instead of the default "<i>PickerTitle : Selection Text</i>".</p>

Parent field	Field	Required	Minimum characters	Maximum characters	Other requirement
	carouselVertical	No			Boolean - Optionally render Carousel elements with vertical scroll.

Apple form template

Note

This template is applicable only for Apple Messages for Business contact flows.

A business can send a form interactive message to their end customers through a single message, containing multiple pages of requested inputs. When the message is received on an end-customer's Apple device, they can open the form and navigate through the pages, providing a response for each page, before submitting all responses at the end of the form.

For example, businesses can use Apple forms for various purposes, including triaging flows, customer surveys, and account creation / sign-ups.

Warning

Interactive message content and end customer responses are stored in contact record transcript and are viewable by other chat participants and contact analysts with access to transcripts. To prevent PII from appearing in your contact record transcript **after the contact has ended**, you will want to use the [Set recording and analytics behavior block](#) in your step-by-step guide contact flow, [enable Contact Lens](#), and enable the redaction of sensitive data. For full details on how to enable PII redaction, see [Enable redaction of sensitive data](#).

The types of pages supported are:

- **ListPicker**: a list of options that the user must select from with image support.
- **WheelPicker**: similar to ListPicker but selection is made through scrollable wheel of options.
- **DatePicker**: a calendar view where user can pick a date.
- **Input**: a text field that the user must fill in.

The following code is an example of an Apple forms template you can use in your Lambda.

Note

- **Bold text** is a mandatory parameter.
- In some cases, if the parent element exists in the request and it isn't mandatory/bold, but the fields in it are, then the fields are mandatory.

Simple survey form example:

```
{
  "templateType": "AppleForm",
  "version": "1.0",
  "data": {
    "content": {
      "title": "Survey",
      "pages": [
        {
          "pageType": "DatePicker",
          "title": "Date you visited",
          "subtitle": "When did you last visit?",
          "minDate": "2024-01-02"
        },
        {
          "pageType": "ListPicker",
          "title": "Rating",
          "subtitle": "How do you rate the experience?",
          "items": [
            {
              "title": "Good",
              "imageType": "URL",
              "imageData": "https://mybucket.s3.us-west-2.amazonaws.com/good.jpg"
            },
            {
```

```
    "title": "Okay",
    "imageType": "URL",
    "imageData": "https://mybucket.s3.us-west-2.amazonaws.com/okay.jpg"
  },
  {
    "title": "Poor",
    "imageType": "URL",
    "imageData": "https://mybucket.s3.us-west-2.amazonaws.com/poor.jpg"
  }
]
},
{
  "pageType": "ListPicker",
  "title": "Dine type",
  "subtitle": "Select all dine types that apply",
  "multiSelect": true,
  "items": [
    {
      "title": "Pickup"
    },
    {
      "title": "Dine-in"
    },
    {
      "title": "Delivery"
    }
  ]
},
{
  "pageType": "WheelPicker",
  "title": "Visits",
  "subtitle": "How often do you visit?",
  "items": [
    {
      "title": "Often"
    },
    {
      "title": "Sometimes"
    },
    {
      "title": "Rarely"
    }
  ]
},
},
```

```

    {
      "pageType": "Input",
      "title": "Additional notes",
      "subtitle": "Anything else you'd like to mention about your visit?",
      "multiLine": true
    }
  ]
}
}
}
}

```

Apple form limits

InteractiveMessage

Field	Type	Required	Description / Notes
version	string	Yes	Version number. Allowed value: "1.0"
templateType	TemplateType	Yes	Interactive message template type. Allowed values: ["ListPicker", "TimePicker", "Panel", "QuickReply", "Carousel", "ViewResource", "AppleForm"]
data	InteractiveMessageData	Yes	Interactive message data

InteractiveMessageData

Field	Type	Required	Description / Notes
content	InteractiveMessageContent	Yes	Main interactive message content
replyMessage	ReplyMessage	No	Message display configuration for after response to interactive message is sent

AppleFormContent

Field	Type	Required	Description / Notes
title	String	Yes	Top-level title of the form. Displayed in Apple receive message bubble and transcript rendering
subtitle	String	No	Used as subtitle in ReceivedMessage
imageType	String	No	Valid values: "URL" Used for image in ReceivedMessage
imageData	String	No	S3 image url Used for image in ReceivedMessage
pages	AppleFormPage[]	Yes	List of form pages
showSummary	Boolean	No	Whether to display a summary page of responses to review before submission Default: False (no confirmation/summary page)
splashPage	AppleFormSplashPage	No	Initial splash page to display before actual pages Default: No splash page

AppleFormSplashPage

Field	Type	Required	Description / Notes
title	String	Yes	Title of splash page
subtitle	String	No	Subtitle / body of splash page
imageType	ImageType	No	Present when displaying image within splash page Allowed value: "URL" Default: No image displayed

Field	Type	Required	Description / Notes
imageData	String	No	For imageType="URL", this is the URL value Default: No image displayed
buttonTitle	String	Yes	Text of Continue button. Required by Apple, default text with localization not supported

AppleFormPage

- Base model for form pages. Specific page types extend from this model

Field	Type	Required	Description / Notes
pageType	ApplePageType	Yes	Enum for page type. Allowed values: ["Input", "DatePicker", "WheelPicker", "ListPicker"]
title	String	Yes	Page title
subtitle	String	Yes	Page subtitle. Used in confirmation page

AppleFormDatePickerPage

AppleFormDatePickerPage extends [AppleFormPage](#)

Field	Type	Required	Description / Notes
pageType	ApplePageType	Yes	Value: "DatePicker"
labelText	String	No	Text displayed next to the date input. See example screenshots in Appendix
helperText	String	No	Helper text displayed under the date input. See example screenshots in Appendix Default: No helper text
dateFormat	String	No	ISO 8601 date format. Default: yyyy-MM-dd

Field	Type	Required	Description / Notes
startDate	String	No	Initial / default selected date in valid date format Default: Current date for end user when message is sent
minDate	String	No	Min date allowed to be selected in valid date format Default: No min
maxDate	String	No	Max date allowed to be selected in valid date format Default: Current date for end user when message is sent

AppleFormListPickerPage

AppleFormListPickerPage extends [AppleFormPage](#)

Field	Type	Required	Description / Notes
pageType	ApplePageType	Yes	Value: "ListPicker"
multiSelect	Boolean	No	Enables selecting multiple items Default: false (single selection)
items	AppleFormListPickerPageItem[]	Yes	List of list page items

AppleFormListPickerPageItem

AppleFormListPickerPageItem extends [AppleFormPage](#)

Field	Type	Required	Description / Notes
title	String	Yes	Display text of item

Field	Type	Required	Description / Notes
imageType	ImageType	No	Present when displaying image within item Allowed value: "URL" Default: No image displayed
imageData	String	No	For imageType="URL", this is the URL value Default: No image displayed

Note

Similar image model to existing interactive message models (ListPicker), except `imageDescription` is not included, which is used for image alt text in chat widget / web chats and ignored for Apple interactive messages.

AppleFormWheelPickerPage

AppleFormWheelPickerPage extends [AppleFormPage](#)

Field	Type	Required	Description / Notes
pageType	ApplePageType	Yes	Value: "WheelPicker"
items	AppleFormWheelPickerPageItem[]	Yes	List of wheel picker items
labelText	String	No	Text displayed next to the input. See example screenshots in Appendix

AppleFormWheelPickerPageItem

AppleFormWheelPickerPageItem extends [AppleFormPage](#)

Field	Type	Required	Description / Notes
title	String	Yes	Display text of picker item

AppleFormInputPage

AppleFormInputPage extends [AppleFormPage](#)

Field	Type	Required	Description / Notes
pageType	ApplePageType	Yes	Value: "Input"
labelText	String	No	Text displayed next to the input box. See example screenshots in Appendix
helperText	String	No	Additional text displayed under input box Default: No helper text
placeholderText	String	No	Placeholder text to display initially when there's no input Default: "(Optional)" or "(Required)" placeholder text
prefixText	String	No	Prefix text to display next to input. Ex: '\$' when input is monetary value Default: No prefix text
required	Boolean	No	Whether end user is required to provide input Default: false
multiLine	Boolean	No	Whether multi-line input can be provided Default: false (single line)
maxCharCount	Number	No	Max char count of input. Enforced on Apple client Default: No limit
regex	String	No	Regex string to place constraints on input provided Default: No regex constraints
keyboardType	String	No	Determines what type of keyboard is displayed when end user is providing input Allowed values: Same as Apple.

Field	Type	Required	Description / Notes
			See docs . Some of the allowed values: numberPad, phonePad, emailAddress
textContentType	String	No	Helps with auto-fill suggestions on Apple device. Allowed values: Same as Apple. See docs . Some of the allowed values: telephoneNumber, fullStreetAddress, familyName

Apple Pay template

Note

This template is applicable only for Apple Messages for Business contact flows.

Use the Apple Pay template to provide an easy and secure way for customers to buy goods and services through Apple Messages for Business with Apple Pay.

The following code is the Apple Pay template that you can use in your Lambda:

Note

- **Bold text** is a mandatory parameter.
- In some cases, if the parent element exists in the request and it isn't mandatory/bold, but the fields in it are, then the fields are mandatory.

```
{
  "templateType": "ApplePay",
  "version": "1.0",
  "data": {
    "content": {
      "title": "Halibut",
      "subtitle": "$63.99 at Sam's Fish",
      "imageType": "URL",

```

```

"imageData": "https://interactive-msg.s3-us-west-2.amazonaws.com/fish.jpg",
"payment": {
  "endpoints": {
    "orderTrackingUrl": "https://sams.example.com/orderTrackingUrl/",
    "paymentGatewayUrl": "https://sams.example.com/paymentGateway/",
    "paymentMethodUpdateUrl": "https://sams.example.com/paymentMethodUpdate/",
    "shippingContactUpdateUrl": "https://sams.example.com/
shippingContactUpdate/",
    "shippingMethodUpdateUrl": "https://sams.example.com/shippingMethodUpdate/",
    "fallbackUrl": "https://sams.example.com/paymentGateway/"
  },
  "merchantSession": {
    "epochTimestamp": 1525730094057,
    "expiresAt": 1525730094057,
    "merchantSessionIdentifier": "PSH40080EF4D6.....9N0E9FD",
    "nonce": "fe72cd0f",
    "merchantIdentifier": "merchant.com.sams.fish",
    "displayName": "Sam's Fish",
    "signature": "308006092a8.....09F0W8EGH00",
    "initiative": "messaging",
    "initiativeContext": "https://sams.example.com/paymentGateway/",
    "signedFields": [
      "merchantIdentifier",
      "merchantSessionIdentifier",
      "initiative",
      "initiativeContext",
      "displayName",
      "nonce"
    ],
  },
},
"paymentRequest": {
  "applePay": {
    "merchantCapabilities": [
      "supports3DS",
      "supportsDebit",
      "supportsCredit"
    ],
    "merchantIdentifier": "merchant.com.sams.fish",
    "supportedNetworks": [
      "amex",
      "visa",
      "discover",
      "masterCard"
    ]
  }
}

```

```
},
"countryCode": "US",
"currencyCode": "USD",
"lineItems": [
  {
    "amount": "59.00",
    "label": "Halibut",
    "type": "final"
  },
  {
    "amount": "4.99",
    "label": "Shipping",
    "type": "final"
  }
],
"requiredBillingContactFields": [
  "postalAddress"
],
"requiredShippingContactFields": [
  "postalAddress",
  "phone",
  "email",
  "name"
],
"shippingMethods": [
  {
    "amount": "0.00",
    "detail": "Available within an hour",
    "identifier": "in_store_pickup",
    "label": "In-Store Pickup"
  },
  {
    "amount": "4.99",
    "detail": "5-8 Business Days",
    "identifier": "flat_rate_shipping_id_2",
    "label": "UPS Ground"
  },
  {
    "amount": "29.99",
    "detail": "1-3 Business Days",
    "identifier": "flat_rate_shipping_id_1",
    "label": "FedEx Priority Mail"
  }
],
```

```

    "total": {
      "amount": "63.99",
      "label": "Sam's Fish",
      "type": "final"
    },
    "supportedCountries" : [
      "US",
      "CA",
      "UK",
      "JP",
      "CN"
    ]
  }
},
"requestIdentifier" : "6b2ca008-1388-4261-a9df-fe04cd1c23a9"
}
}
}
}

```

Apple Pay limits

Parent field	Field	Require	Minimum characters	Maximum characters	Other requirement
	templateType	Yes			Valid template type
	data	Yes			
	version	Yes			Must be "1.0"
data	content	Yes			
content	title	Yes	1	512	The title of the received message bubble
	subtitle	No	0	512	Subtitle to be displayed under title of

Parent field	Field	Require	Minimum characters	Maximum characters	Other requirement
					the received message bubble
	imageData	No	0	200	Must be a valid publicly accessible URL
	imageType	No	0	50	Must be "URL"
	payment	Yes			A dictionary containing fields giving the specifics of an Apple Pay request.
	requestIdentifier	No			String, An identifier for the ApplePay request. If not specified, an UUID will be generated and used.
payment	endpoints	Yes			A dictionary containing the endpoints for payment processing, contact updates, and order tracking.
	merchantSession	Yes			A dictionary containing the payment session provided by Apple Pay after requesting a new payment session.
	paymentRequest	Yes			A dictionary with information about the payment request

Parent field	Field	Require	Minimum characters	Maximum characters	Other requirement
endpoints	paymentGatewayUrl	Yes			String. Called by Apple Pay to process the payment through the payment provider. The URL should match the URL in the initiativeContext field of the merchant session
	fallbackUrl	No			A URL that opens in a web browser so the customer can complete the purchase if their device is unable to make payments using Apple Pay. If specified, fallbackUrl need to match paymentGatewayUrl.
	orderTrackingUrl	No			Called by Messages for Business after completing the order; provides you with an opportunity to update the order information in your system.

Parent field	Field	Require	Minimum characters	Maximum characters	Other requirement
	paymentMethodUpdateUrl	No			Called by Apple Pay when the customer changes the payment method. If you don't implement this endpoint and you include this key in the dictionary, the customer sees an error message.
	shippingContactUpdateUrl	No			Called by Apple Pay when the customer changes their shipping address information. If you don't implement this endpoint and you include this key in the dictionary, the customer sees an error message.
	shippingMethodUpdateUrl	No			Called by Apple Pay when the customer changes the shipping method. If you don't implement this endpoint and you include this key in the dictionary, the customer sees an error message.

Parent field	Field	Require	Minimum characters	Maximum characters	Other requirement
merchantSession	displayName	Yes	1	64	String. The canonical name for your store, suitable for display. Do not localize the name.
	initiative	Yes			String. Must be "messaging"
	initiativeContext	Yes			String. Pass your payment gateway URL.
	merchantIdentifier	Yes			String. A unique identifier that represents a merchant for Apple Pay.
	merchantSessionIdentifier	Yes			String. A unique identifier that represents a merchant's session for Apple Pay.
	epochTimestamp	Yes			String. The time representation in number of seconds that have elapsed since 00:00:00 UTC, Thursday, January 1, 1970.

Parent field	Field	Require	Minimum characters	Maximum characters	Other requirement
	expiresAt	Yes			String. The expiration time representation in number of seconds that have elapsed since 00:00:00 UTC, Thursday, January 1, 1970.
	nonce	No			Binary. A single-use string that checks the integrity of the interaction.
	signature	No			Binary. A hash of the public key used to sign the interactions.
	signedFields	No			List of strings contains the signed properties.
paymentRequest	applePay	Yes			A dictionary that describes the Apple Pay configuration.
	countryCode	Yes			String. The merchant's two-letter ISO 3166 country code.
	currencyCode	Yes			String. The three-letter ISO 4217 currency code for the payment.

Parent field	Field	Require	Minimum characters	Maximum characters	Other requirement
	lineItems	No			An array of line items explaining payments and additional charges. Line items are not required. However, the array cannot be empty if the lineItems key is present.
	total	Yes			A dictionary containing the total. The total amount must be greater than zero to pass validation.
	requiredBillingContactFields	No			The list of the customer's required billing information needed to process the transaction. For the list of possible strings, see requiredBillingContactFields . Require only the contact fields needed to process the payment. Requesting unnecessary fields adds complexity to the transaction, which can increase the chances of the customer canceling the payment request.

Parent field	Field	Require	Minimum characters	Maximum characters	Other requirement
	requiredShippingContactFields	No			The list of shipping or contact information required from the customer to fulfill the order. For example, if you need the customer's email or phone number, then include this key. For the list of possible strings, see requiredShippingContactFields .
	shippingMethods	No			An array that lists the available shipping methods. The Apple Pay payment sheet displays the first shipping method from the array as the default shipping method.
	supportedCountries	No			An array of countries to support. List each country with their ISO 3166 country code.
applePay	merchantIdentifier	Yes			A unique identifier that represents a merchant for Apple Pay.

Parent field	Field	Require	Minimum characters	Maximum characters	Other requirement
	merchantCapabilities	Yes			An array of payment capabilities supported by the merchant. The array must include supports3DS, and may optionally include supportsCredit, supportsDebit, and supportsEMV.
	supportedNetworks	Yes			An array of payment networks supported by the merchant. The array must include one or more of the following values: amex, discover, jcb, masterCard, privateLabel, or visa
lineItem	amount	Yes			The monetary amount of the line item.
	label	Yes			A short, localized description of the line item.
	type	No			A value that indicates whether the line item is final or pending.
total	amount	Yes			The total amount of the payment.

Parent field	Field	Require	Minimum characters	Maximum characters	Other requirement
	label	Yes			A short, localized description of the payment.
	type	No			A value that indicates whether the payment is final or pending.
shippingMethods	amount	Yes			String. The nonnegative cost associated with this shipping method.
	detail	Yes			String. Additional description of the shipping method.
	label	Yes			String. A short description of the shipping method.
	identifier	Yes			String. A client-defined value used to identify this shipping method.

iMessage App template

Note

This template is applicable only for Apple Messages for Business contact flows.

Use the iMessage Apps template to present the customer with your custom built iMessage App.

The following code is an example iMessage App template that you can use in your Lambda.

```

{
  templateType: AppleCustomInteractiveMessage,
  version: "1.0",
  data: {
    content: {
      appIconUrl: "https://interactive-message-testing.s3-us-west-2.amazonaws.com/
apple_4.2kb.jpg",
      appId: "123456789",
      appName: "Package Delivery",
      title: "Bubble Title CIM",
      bid: "com.apple.messages.MSMessageExtensionBalloonPlugin:{team-id}:{ext-
bundle-id}",
      dataUrl: "?
deliveryDate=26-01-2024&destinationName=Home&street=1infinitemloop&state=CA&city=Cupertino&count
      subtitle: "Bubble package",
    },
    replyMessage: {
      title: "Custom reply message title",
      subtitle: "Custom reply message subtitle",
      imageType: "URL",
      imageData: "https://interactive-msg.s3-us-west-2.amazonaws.com/
fruit_34.3kb.jpg",
    }
  }
}

```

iMessage App limits

Parent Field	Field	Required	Type	Other Notes
	templateType	Yes	TemplateType	Valid template type, "AppleCustomInteractiveMessage"
	data	Yes	InteractiveMessageData	Contains content and receivedMessage dictionaries
	version	Yes	string	Must be "1.0"

Parent Field	Field	Required	Type	Other Notes
data	content	Yes	InteractiveMessageContent	Interactive Content of the iMessage App
	replyMessage	Yes	ReplyMessage	Message display configuration for after response to interactive message is sent
content	appContent	Yes	string	AWS S3 URL
	appId	Yes	string	Business iMessage App Id
	appName	Yes	string	Business iMessage App name
	bid	Yes	string	Business iMessage App Bid. Pattern: com.apple.messages.MSMessageExtensionBalloonPlugin:{team-id}:{ext-bundle-id}
	dataUrl	Yes	string	Data that is passed into the iMessage App
	useLiveLayout	No	boolean	Default True
	title	Yes	string	title of the iMessage App bubble
	subtitle	No	string	subtitle of the iMessage App bubble
replyMessage	title	No	string	
	subtitle	No	string	
	imageType	No	string	Must be a valid publicly accessible URL
	imageData	No	string	Cannot exist without an image

Rich formatting in titles and subtitles

You can add rich formatting to the titles and subtitles of your chat messages. For example, you can add links, italics, bold, numbered lists, and bulleted lists. You use [markdown](#) to format your text.

The following image of a chat box shows an example list picker with rich formatting in the title and subtitle.

- The title **How can we help? aws.amazon.com** is bold and contains a link.
- The subtitle contains italics and bold text, a bulleted list, and a numbered list. It also shows a plain link, text link, and sample code.
- The bottom of the chat box shows three list picker elements.

The image shows a chat message from a bot (BOT) at 1:05 PM. The message content is as follows:

How can we help? aws.amazon.com
 This is some *emphasized text* and some **strongly emphasized text**

This is a bulleted list:

- item 1
- item 2
- item 3

This is a numbered list:

1. item 1
2. item 2
3. item 3

Questions? Visit <https://plainlink.com/faq>

This is a link

This is `<code />`

At the bottom of the chat box, there are three list picker elements:

- Check self-service options
- Talk to an agent
- End chat

Annotations in the image point to specific features:

- "The title is bold and contains a link." points to the title.
- "The subtitle contains italics and bold text." points to the first line of the subtitle.
- "The subtitle contains a bulleted list and a numbered list." points to the bulleted and numbered lists in the subtitle.
- "You can format links a variety of ways." points to the link in the subtitle.
- "You can format text as code." points to the code block in the subtitle.

How to format text with markdown

You can write title and subtitle strings in a multi-line format, or in a single line with ``\r\n`` line break characters.

- **Multi-line format:** The following code sample shows how to author lists in markdown in a multi-line format.

```
const MultiLinePickerSubtitle = `This is some *emphasized text* and some **strongly
emphasized text**

This is a bulleted list (multiline):
* item 1
* item 2
* item 3

This is a numbered list:
1. item 1
2. item 2
3. item 3

Questions? Visit https://plainlink.com/faq

[This is a link](https://aws.amazon.com)

This is ``
`

const PickerTemplate = {
  templateType: "ListPicker|Panel",
  version: "1.0",
  data: {
    content: {
      title: "How can we help?",
      subtitle: MultiLinePickerSubtitle,
      elements: [ /* ... */ ]
    }
  }
}
```

- **Single line format:** The following example shows how to author a subtitle in a single line by using `\r\n`` line break characters.

```
const SingleLinePickerSubtitle = "This is some *emphasized text* and some **strongly
emphasized text**\r\nThis is a bulleted list:\n* item 1\n* item 2\n* item 3\n\nThis
is a numbered list:\n1. item 1\n2. item 2\n3. item 3\n\nQuestions? Visit https://
plainlink.com/faq\r\n[This is a link](https://aws.amazon.com)\r\nThis is `<code/>`";
```

```
const PickerTemplate = {
  templateType: "ListPicker|Panel",
  version: "1.0",
  data: {
    content: {
      title: "How can we help?",
      subtitle: SingleLinePickerSubtitle,
      elements: [ /* ... */ ]
    }
  }
}
```

The following example shows how format italics and bold text with markdown:

This is some *emphasized text* and some **strongly emphasized text**

The following example shows how to format text as code with markdown:

This is `<code />`

How to format links with markdown

To create a link, use the following syntax:

```
[aws](https://aws.amazon.com)
```

The following examples show two ways you can add links with markdown:

```
Questions? Visit https://plainlink.com/faq
```

```
[This is a link](https://aws.amazon.com)
```

Invoke AWS Lambda functions

Amazon Connect can interact with your own systems and take different paths in flows dynamically. To achieve this, invoke AWS Lambda functions in a flow, fetch the results, and call your own services or interact with other AWS data stores or services. For more information, see the [AWS Lambda Developer Guide](#).

To invoke a Lambda function from a flow, complete the following tasks.

Tasks

- [Create a Lambda function](#)
- [Add a Lambda function to your Amazon Connect instance](#)
- [Invoke a Lambda function from a flow](#)
- [Configure your Lambda function to parse the event](#)
- [Verify the function response](#)
- [Consume the Lambda function response](#)
- [Tutorial: Create a Lambda function and invoke in a flow](#)

Create a Lambda function

Create a Lambda function, using any runtime, and configure it. For more information, see [Get started with Lambda](#) in the *AWS Lambda Developer Guide*.

If you create the Lambda function in the same Region as your contact center, you can use the Amazon Connect console to add the Lambda function to your instance as described in the next task, [Add a Lambda function to your Amazon Connect instance](#). This automatically adds resource permissions that allow Amazon Connect to invoke the Lambda function. Otherwise, if the Lambda function is in a different Region, you can add it to your flow using the flow designer and add the resource permissions using the [add-permission](#) command, with a principal of `connect.amazonaws.com` and the ARN of your Amazon Connect instance. For more information, see [Using Resource-Based Policies for AWS Lambda](#) in the *AWS Lambda Developer Guide*.

Add a Lambda function to your Amazon Connect instance

Before you can use an Lambda function in a flow, you need to add it to your Amazon Connect instance.

Add a Lambda function to your instance

1. Open the Amazon Connect console at <https://console.aws.amazon.com/connect/>.
2. On the instances page, choose your instance name in the **Instance Alias** column. This instance name appears in the URL you use to access Amazon Connect.

Amazon Connect > Instances

Amazon Connect virtual contact center instances

Instances Refresh Delete Add an instance

Find resources

Instance alias	Access URL	Channels	Create date	Status
mytest67	https://mytest67.my.connect.aws	Inbound, outbound telephony	1/12/2022	Active

- In the navigation pane, choose **Flows**.
- In the **AWS Lambda** section, use the **Function** drop-down box to select the function to add to your instance.

Tip

The drop-down lists only those functions in the same Region as your instance. If no functions are listed, choose **Create a new Lambda function**, which opens the AWS Lambda console.

To use a Lambda in a different Region or account, in the [Invoke AWS Lambda function](#), under **Select a function**, you can enter the ARN of a Lambda. Then set up the corresponding resource-based policy on that Lambda to allow the flow to call it.

To call `lambda:AddPermission`, you need to:

- Set the principal to **connect.amazonaws.com**
- Set the source account to be the account your instance is in.
- Set the source ARN to the ARN of your instance.

For more information, see [Granting function access to other accounts](#).

- Choose **Add Lambda Function**. Confirm that the ARN of the function is added under **Lambda Functions**.

Now you can refer to that Lambda function in your flows.

Invoke a Lambda function from a flow

1. Open or create a flow.
2. Add an [Invoke AWS Lambda function](#) block (in the **Integrate** group) to the grid. Connect the branches to and from the block.
3. Choose the title of the [Invoke AWS Lambda function](#) block to open its properties page.
4. Under **Select a function**, choose from the list of functions you've added to your instance.
5. (Optional) Under **Function input parameters**, choose **Add a parameter**. You can specify key-value pairs that are sent to the Lambda function when it is invoked. You can also specify a **Timeout** value for the function.
6. In **Timeout (max 8 seconds)**, specify how long to wait for Lambda to time out. After this time, the contact routes down the Error branch.

For every Lambda function invocation from a flow, you pass a default set of information related to ongoing contact, as well as any additional attributes defined in the **Function input parameters** section for the **Invoke AWS Lambda function** block added.

The following is an example JSON request to a Lambda function:

```
{
  "Details": {
    "ContactData": {
      "Attributes": {
        "exampleAttributeKey1": "exampleAttributeValue1"
      },
      "Channel": "VOICE",
      "ContactId": "4a573372-1f28-4e26-b97b-XXXXXXXXXXXX",
      "CustomerEndpoint": {
        "Address": "+1234567890",
        "Type": "TELEPHONE_NUMBER"
      },
      "CustomerId": "someCustomerId",
      "Description": "someDescription",
      "InitialContactId": "4a573372-1f28-4e26-b97b-XXXXXXXXXXXX",
      "InitiationMethod": "INBOUND | OUTBOUND | TRANSFER | CALLBACK",
      "InstanceARN": "arn:aws:connect:aws-region:1234567890:instance/c8c0e68d-2200-4265-82c0-XXXXXXXXXXXX",
      "LanguageCode": "en-US",
      "MediaStreams": {
```

```

    "Customer": {
      "Audio": {
        "StreamARN": "arn:aws:kinesisvideo::eu-
west-2:111111111111:stream/instance-alias-contact-dddddddd-bbbb-dddd-eeee-
fffffffffffffff/99999999999999",
        "StartTimestamp": "1571360125131", // Epoch time value
        "StopTimestamp": "1571360126131",
        "StartFragmentNumber": "100" // Numeric value for fragment
number
      }
    },
    "Name": "ContactFlowEvent",
    "PreviousContactId": "4a573372-1f28-4e26-b97b-XXXXXXXXXXXX",
    "Queue": {
      "ARN": "arn:aws:connect:eu-west-2:111111111111:instance/cccccccc-
bbbb-dddd-eeee-fffffffffffffff/queue/aaaaaaaa-bbbb-cccc-dddd-eeeeeeeeeeee",
      "Name": "PasswordReset"
      "OutboundCallerId": {
        "Address": "+12345678903",
        "Type": "TELEPHONE_NUMBER"
      }
    },
    "References": {
      "key1": {
        "Type": "url",
        "Value": "urlvalue"
      }
    },
    "SystemEndpoint": {
      "Address": "+1234567890",
      "Type": "TELEPHONE_NUMBER"
    },
    "Parameters": {"exampleParameterKey1": "exampleParameterValue1",
      "exampleParameterKey2": "exampleParameterValue2"
    },
    "Name": "ContactFlowEvent"
  }
}

```

The request is divided into two parts:

- **Contact data**—This is always passed by Amazon Connect for every contact. Some parameters are optional.

This section may include attributes that have been previously associated with a contact, such as when using a **Set contact attributes** block in a flow. This map may be empty if there aren't any saved attributes.

The following image shows where these attributes would appear in the properties page of a **Set contact attributes**.

The image shows a screenshot of the Amazon Connect interface. In the background, a flow canvas is visible with a 'Set contact attributes' block highlighted by a red box. The block's output is 'exampleAttributeK...'. Below the block, there are 'Success' and 'Error' status indicators. In the foreground, a 'Set contact attributes' configuration dialog is open. The dialog has a title bar with a close button (X). Below the title bar, there is a description: 'Define and store key-value pairs as contact attributes. [Learn more](#)'. A light blue box contains the text: 'Contact attributes are accessible by other areas of Amazon Connect, such as the Contact Control Panel (CCP) and Contact Trace Records (CTRs)'. Below this, the 'Attribute to save' section is visible. It includes a 'Destination Type' dropdown menu set to 'User Defined'. Below that, the 'Destination Attribute' field contains the text 'exampleAttributeKey1'. Underneath, there are two radio button options: 'Use text' (which is selected) and 'Use attribute'. The 'Use text' option has a 'Value' field containing 'exampleAttributeValue1'. A red box highlights the 'Destination Attribute' field and the 'Value' field.

- Parameters—These are parameters specific to this call that were defined when you created the Lambda function. The following image shows where these parameters would appear in the properties page of the **Invoke AWS Lambda function** block.

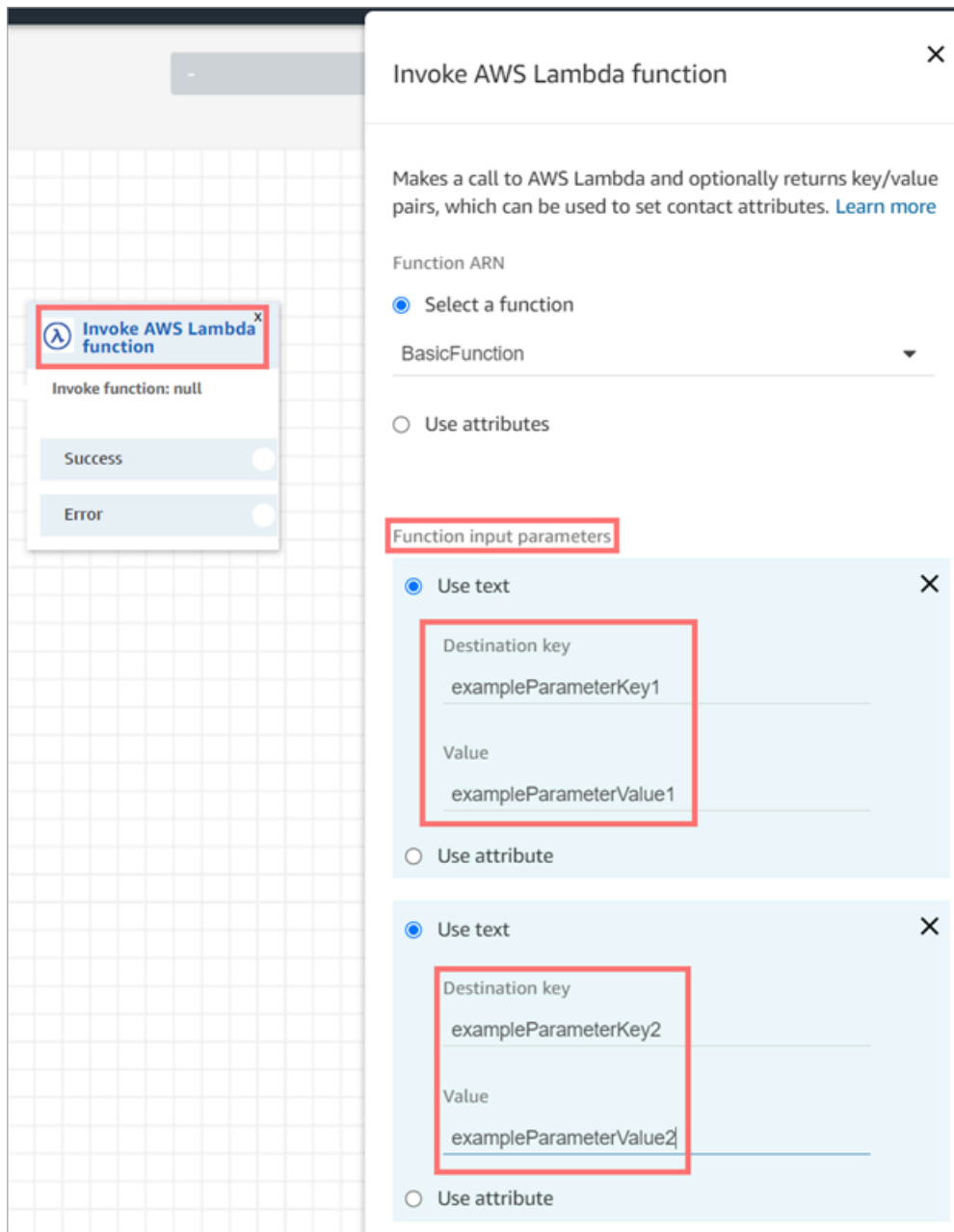

The Invoke Lambda block can receive input parameters in JSON format, accommodating both primitive data types and nested JSON. The following is an example of a JSON input that can be used in the Invoke Lambda block.

```
{
  "Name": "Jane",
  "Age":10,
  "isEnrolledInSchool": true,
  "hobbies": {
    "books":["book1", "book2"],
    "art":["art1", "art2"]
  }
}
```

Invocation retry policy

If your Lambda invocation in a flow gets throttled, the request will be retried. It will also be retried if a general service failure (500 error) happens.

When a synchronous invocation returns an error, Amazon Connect retries up to 3 times, for a maximum of 8 seconds. At that point, the flow will progress down the Error branch.

To learn more about how Lambda retries, see [Error Handling and Automatic Retries in AWS Lambda](#).

Invoke multiple Lambda functions

Customers hear silence while a Lambda function executes. We recommend adding a **Play prompt** block between functions to keep customers engaged and aware of the long interaction.

Configure your Lambda function to parse the event

To successfully pass attributes and parameters between your Lambda function and Amazon Connect, configure your function to correctly parse the JSON request sent from the **Invoke AWS Lambda function** block or **Set contact attributes**, and define any business logic that should be applied. How the JSON is parsed depends on the runtime you use for your function.

For example, the following code shows how to access `exampleParameterKey1` from **Invoke AWS Lambda function** block and `exampleAttributeKey1` from **Set contact attributes** block using Node.JS:

```
exports.handler = function(event, context, callback) {
  // Example: access value from parameter (Invoke AWS Lambda function)
```

```
let parameter1 = event['Details']['Parameters']['exampleParameterKey1'];

// Example: access value from attribute (Set contact attributes block)
let attribute1 = event['Details']['ContactData']['Attributes']['exampleAttributeKey1'];

// Example: access customer's phone number from default data
let phone = event['Details']['ContactData']['CustomerEndpoint']['Address'];

// Apply your business logic with the values
// ...
}
```

Verify the function response

Tip

Referencing an array is not supported in a flow. Arrays can be used only in another Lambda function.

The Lambda function response could be either a `STRING_MAP` or `JSON` and has to be set while configuring the **Invoke AWS Lambda function** block in the flow. If response validation is set to `STRING_MAP`, then the Lambda function should return a flat object of key/value pairs of the string type. Otherwise, if response validation is set to `JSON`, the Lambda function can return any valid JSON including nested JSON.

Invoke AWS Lambda function ✕

Makes a call to AWS Lambda and optionally returns key/value pairs, which can be used to set contact attributes. [Info](#)

Function ARN

Set manually

Add a function ✕ ▾

ConnectLambda

Set dynamically

Function input parameters

[Add a parameter](#)

Timeout

Timeout

3

max. 8 seconds

Response validation

Validates lambda responses to support any valid JSON or flat object of key/value pairs of string type. [Info](#)

STRING MAP

Lambda returns a flat object of key/value pairs of string type.

JSON

Cancel Save

The Lambda response can be up to 32kb. If you fail to reach Lambda, the function throws an exception, the response is not understood, or the Lambda function takes more time than the limit, the flow jumps to the Error label.

Test the output returned from your Lambda function to confirm that it will be correctly consumed when returned to Amazon Connect. The following example shows a sample response in Node.JS:

```
exports.handler = function(event, context, callback) {
  // Extract data from the event object
  let phone = event['Details']['ContactData']['CustomerEndpoint']['Address'];

  // Get information from your APIs

  let customerAccountId = getAccountIdByPhone(phone);
  let customerBalance = getBalanceByAccountId(customerAccountId);

  let resultMap = {
    AccountId: customerAccountId,
    Balance: '$' + customerBalance,
  }

  callback(null, resultMap);
}
```

This example shows an example response using Python:

```
def lambda_handler(event, context):
  // Extract data from the event object
  phone = event['Details']['ContactData']['CustomerEndpoint']['Address']

  // Get information from your APIs
  customerAccountId = getAccountIdByPhone(phone)
  customerBalance = getBalanceByAccountId(customerAccountId)

  resultMap = {
    "AccountId": customerAccountId,
    "Balance": '$%s' % customerBalance
  }

  return resultMap
```

The output returned from the function must be a flat object of key/value pairs, with values that include only alphanumeric, dash, and underscore characters. The size of the returned data must be less than 32 KB of UTF-8 data.

The following example shows the JSON output from these Lambda functions:

```
{
  "AccountId": "a12345689",
  "Balance": "$1000"
}
```

If response validation is set to JSON, then Lambda function can return even a nested JSON, for example:

```
{
  "Name": {
    "First": "John",
    "Last": "Doe"
  },
  "AccountId": "a12345689",
  "OrderIds": ["x123", "y123"]
}
```

You may return any result as long as they are simple key-value pairs.

Consume the Lambda function response

There are two ways to use the function response in your flow. You can either directly reference the variables returned from Lambda, or store the values returned from the function as contact attributes and then reference the stored attributes. When you use an external reference to a response from a Lambda function, the reference will always receive the response from the most recently invoked function. To use the response from a function before a subsequent function is invoked, the response must be saved as a contact attribute, or passed as a parameter to the next function.

1. Access variables directly

If you access the variables directly, you can use them in flow blocks, but they are not included in contact records. To access these variables directly in a flow block, add the block after the **Invoke AWS Lambda function** block, and then reference the attributes as shown in the following example:

```
Name - $.External.Name
Address - $.External.Address
CallerType - $.External.CallerType
```

The following image shows the properties page of the **Play prompt** block. The variables are specified in the text-to-speech block.

Select from the prompt library (audio)
 Text-to-speech or chat text

Enter text

Your id is <say-as interpret-as="characters">\$.External.AccountId</say-as>.

 Your balance is <say-as interpret-as="cardinal">\$.External.Balance</say-as>

Enter dynamically

Interpret as

SSML

Make sure that the name specified for the source attribute matches the key name returned from Lambda.

2. Store variables as contact attributes

If you store the variables as contact attributes, you can use them throughout your flow, and they are included in contact records.

To store the values returned as contact attributes and then reference them, use a **Set contact attributes** block in your flow after the **Invoke AWS Lambda function** block. Choose **Use attribute, External** for the **Type**. Following the example we're using, set **Destination Attribute** to MyAccountId, and set the **attribute** to AccountId, and do the same for MyBalance and **Balance**. This configuration is shown in the following image.

```
1 import json
2
3 def lambda_handler(event, context):
4     phone = event['Details']['ContactData']['CustomerEndpoint']['Address']
5     customerAccountId = getAccountIdByPhone(phone)
6     customerBalance = getBalanceByAccountId(customerAccountId)
7
8     resultMap = {
9         "AccountId": customerAccountId,
10        "Balance": '%s' % customerBalance
11    }
12
13    return resultMap
14
```

Latest: Published

Set contact attributes

Define and store key-value pairs as contact attributes. [Learn more](#)

Destination Type: User Defined

Destination Attribute: MyAccountId

Use text

Use attribute

Type: External

Attribute: AccountId

Destination Type: User Defined

Destination Attribute: MyBalance

Use text

Use attribute

Multiple attributes (2)

- Success
- Error

Consume the response

Add Address as a **Source attribute** and use returnedContactAddress as the **Destination key**. Then add CallerType as a **Source attribute** and use returnedContactType for the **Destination key**, as shown in the following image.

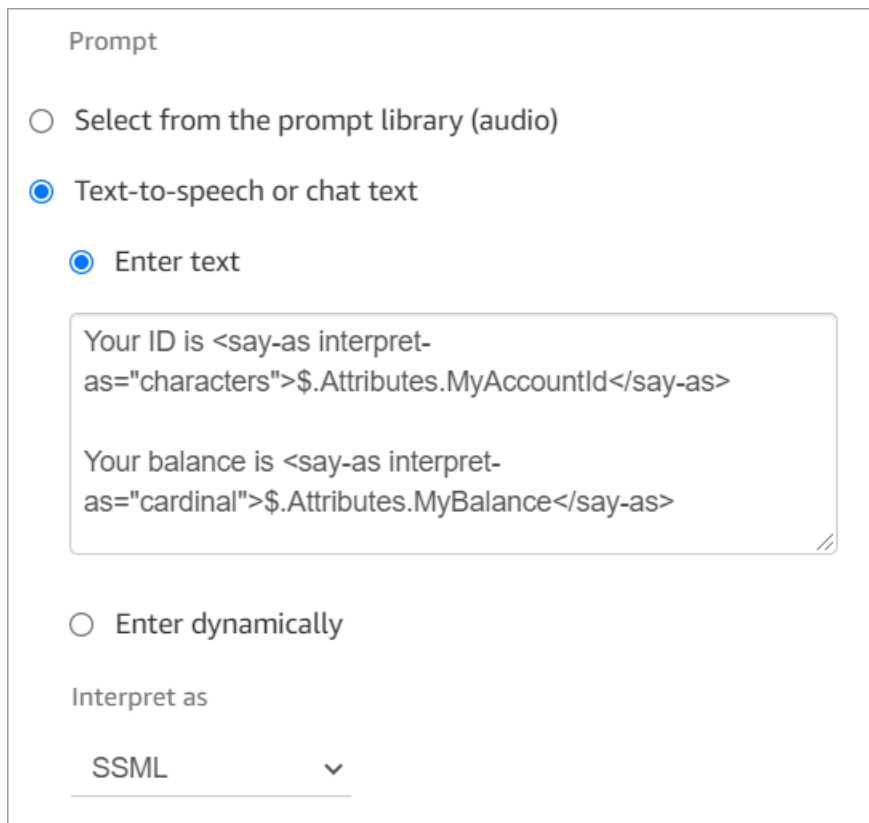

The image shows a configuration window for a prompt. At the top, it is labeled "Prompt". There are three radio button options: "Select from the prompt library (audio)", "Text-to-speech or chat text", and "Enter text". The "Text-to-speech or chat text" option is selected. Underneath, there is a text input field containing two lines of SSML code: "Your ID is <say-as interpret-as='characters'>\$.Attributes.MyAccountId</say-as>" and "Your balance is <say-as interpret-as='cardinal'>\$.Attributes.MyBalance</say-as>". Below the text input field, there is another radio button option "Enter dynamically", which is not selected. At the bottom, there is a label "Interpret as" followed by a dropdown menu currently showing "SSML".

Make sure that the name specified for the source external attribute matches the key name returned from Lambda.

Tutorial: Create a Lambda function and invoke in a flow

Step 1: Create the Lambda example

1. Sign in to the AWS Management Console and open the AWS Lambda console at <https://console.aws.amazon.com/lambda/>.
2. In AWS Lambda, choose **Create function**.
3. Choose **Author from scratch**, if it's not selected already. Under **Basic information**, for **Function name**, enter **MyFirstConnectLambda**. For all other options, accept the defaults. These options are shown in the following image of the AWS Lambda console.

Lambda > Functions > Create function

Create function Info

Choose one of the following options to create your function.

Author from scratch Info
Start with a simple Hello World example.

Use a blueprint
Build a Lambda application from sample code and configuration presets for common use cases.

Container image
Select a container image to deploy for your function.

Browse serverless app repository
Deploy a sample Lambda application from the AWS Serverless Application Repository.

Basic information

Function name Info
Enter a name that describes the purpose of your function.

Use only letters, numbers, hyphens, or underscores with no spaces.

Runtime Info
Choose the language to use to write your function. Note that the console code editor supports only Node.js, Python, and Ruby.

Architecture Info
Choose the instruction set architecture you want for your function code.
 x86_64
 arm64

Permissions Info
By default, Lambda will create an execution role with permissions to upload logs to Amazon CloudWatch Logs. You can customize this default role later when adding triggers.
[▶ Change default execution role](#)

[▶ Advanced settings](#)

[Cancel](#) [Create function](#)

4. Choose **Create function**.
5. In the **Code source** box, in the **index.js** tab, delete the template code from the code editor.
6. Copy and paste the following code into the code editor as shown in the following image:

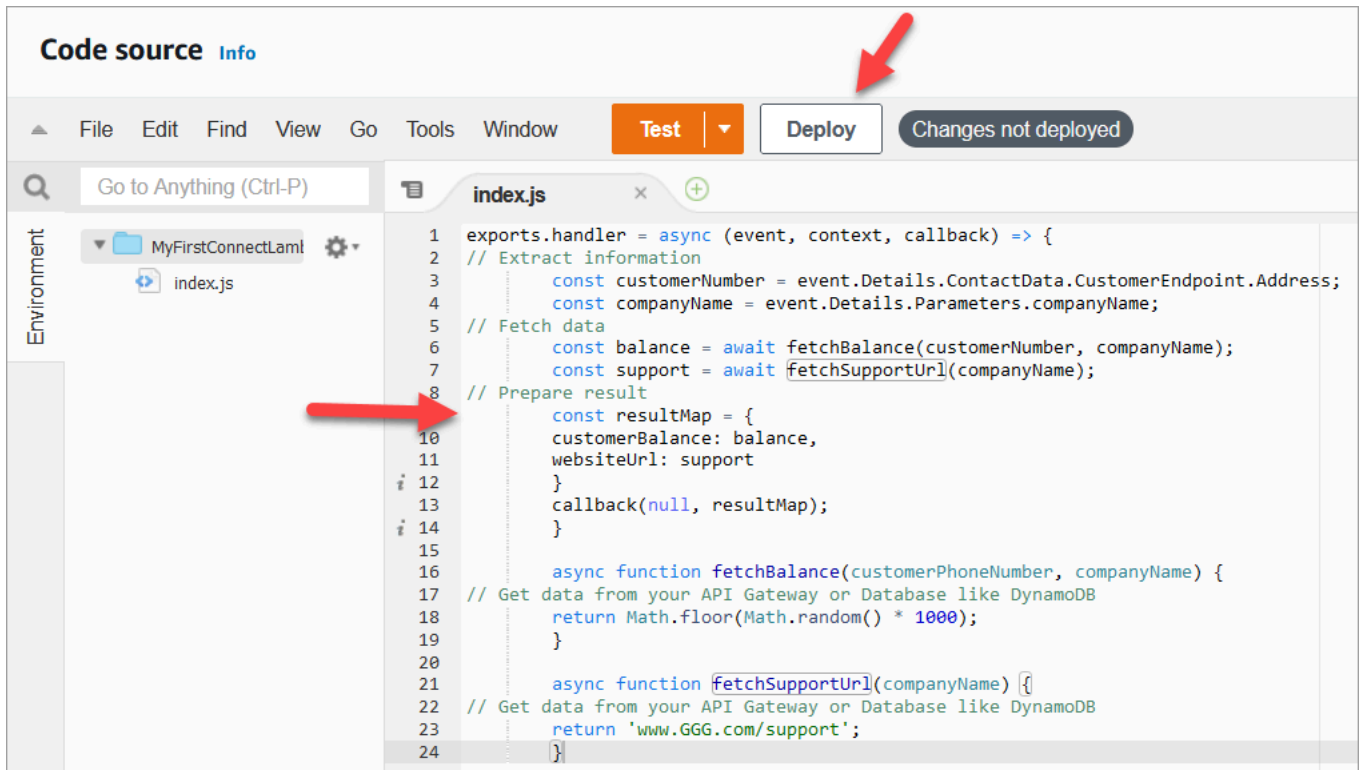

```

exports.handler = async (event, context, callback) => {
  // Extract information
  const customerNumber = event.Details.ContactData.CustomerEndpoint.Address;
  const companyName = event.Details.Parameters.companyName;
  // Fetch data
  const balance = await fetchBalance(customerNumber, companyName);
  const support = await fetchSupportUrl(companyName);
  // Prepare result
  const resultMap = {
    customerBalance: balance,
    websiteUrl: support
  }
  callback(null, resultMap);
}

async function fetchBalance(customerPhoneNumber, companyName) {
  // Get data from your API Gateway or Database like DynamoDB
  return Math.floor(Math.random() * 1000);
}

async function fetchSupportUrl(companyName) {
  // Get data from your API Gateway or Database like DynamoDB
  return 'www.GGG.com/support';
}

```

```
}

```

This code is going to generate a random result for the customerBalance.

7. Choose **Deploy**.
8. After you choose **Deploy**, choose **Test** to launch the test editor.
9. In the **Configure test event** dialog box, select **Create new event**. For **Event name**, enter **ConnectMock** as the test name.
10. In the **Event JSON** box, delete the sample code and enter the following code instead.

```
{
  "Details": {
    "ContactData": {
      "Attributes": {},
      "Channel": "VOICE",
      "ContactId": "4a573372-1f28-4e26-b97b-XXXXXXXXXXXX",
      "CustomerEndpoint": {
        "Address": "+1234567890",
        "Type": "TELEPHONE_NUMBER"
      },
    },
    "InitialContactId": "4a573372-1f28-4e26-b97b-XXXXXXXXXXXX",
    "InitiationMethod": "INBOUND | OUTBOUND | TRANSFER | CALLBACK",
    "InstanceARN": "arn:aws:connect:aws-region:1234567890:instance/c8c0e68d-2200-4265-82c0-XXXXXXXXXXXX",
    "PreviousContactId": "4a573372-1f28-4e26-b97b-XXXXXXXXXXXX",
    "Queue": {
      "ARN": "arn:aws:connect:eu-west-2:111111111111:instance/cccccccc-bbbb-dddd-eeee-ffffffffffff/queue/aaaaaaaa-bbbb-cccc-dddd-eeeeeeeeeeee",
      "Name": "PasswordReset"
    },
    "SystemEndpoint": {
      "Address": "+1234567890",
      "Type": "TELEPHONE_NUMBER"
    }
  },
  "Parameters": {
    "companyName": "GGG"
  },
  "Name": "ContactFlowEvent"
}
```

- Choose **Save**.
- Choose **Test**. You should see the following something similar to the following image:

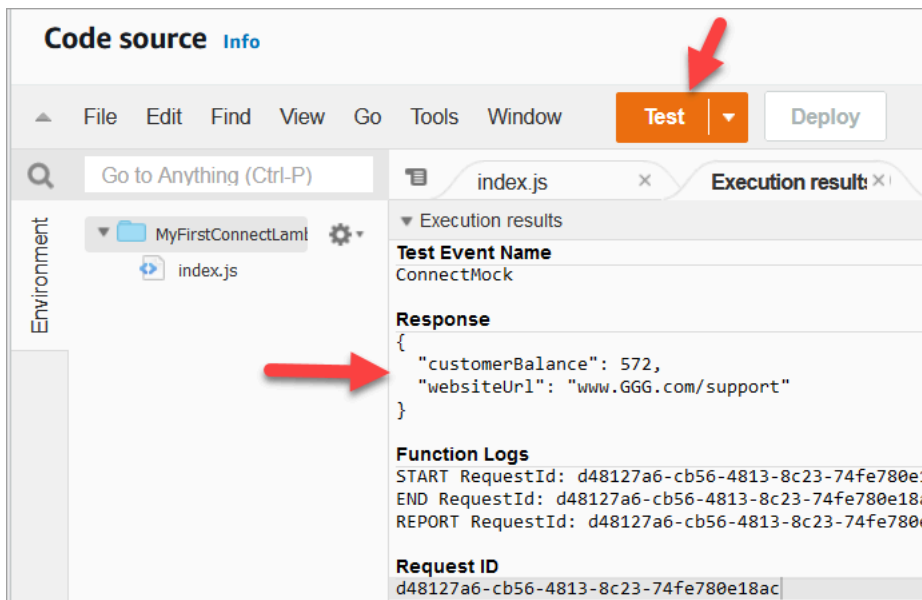

Your balance will be different. The code generates a random number.

Step 2: Add your Lambda to Amazon Connect

- Go to the Amazon Connect console, at <https://console.aws.amazon.com/connect/>.
- Choose your Amazon Connect instance alias.

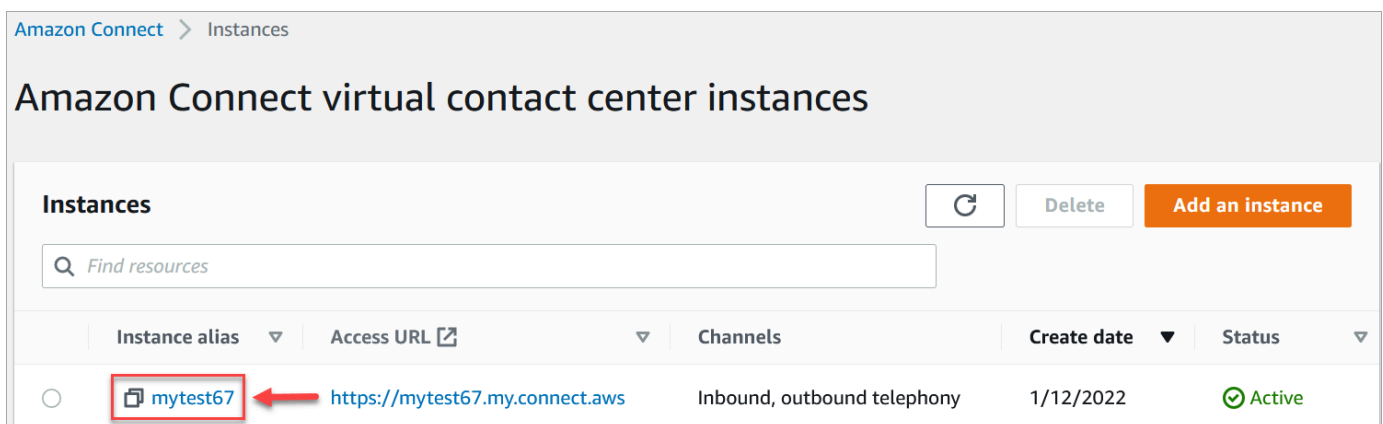

- On the navigation menu, choose **Flows**.
- In the AWS Lambda section, use the **Lambda Functions** dropdown box to select **MyFirstConnectLambda**.

Amazon Connect ×

Instances

Overview

Telephony

Data storage

Data streaming

Contact flows

Analytics tools

Approved origins

Customer Profiles

Tasks

AWS Lambda

By using AWS Lambda function, you can retrieve data from data contact can be routed to the appropriate contact flow branch. E permission to invoke them [Create a new Lambda function](#)

Lambda Functions

Choose an option

+ Add Lambda Function

Lambda Functions

Function Arn	Arn
MyFirstConnectLambda	arn:aws:lambda:us-wes...

5. Choose **Add Lambda Function**.

Step 3: Create the contact flow

The following image is an example of the flow you are going to build using the steps in this procedure. It contains the following blocks: **Set contact attributes**, **Play prompt**, **Invoke AWS Lambda function**, another **Set contact attributes** block, another **Play prompt** block, and finally a **Disconnect** block.

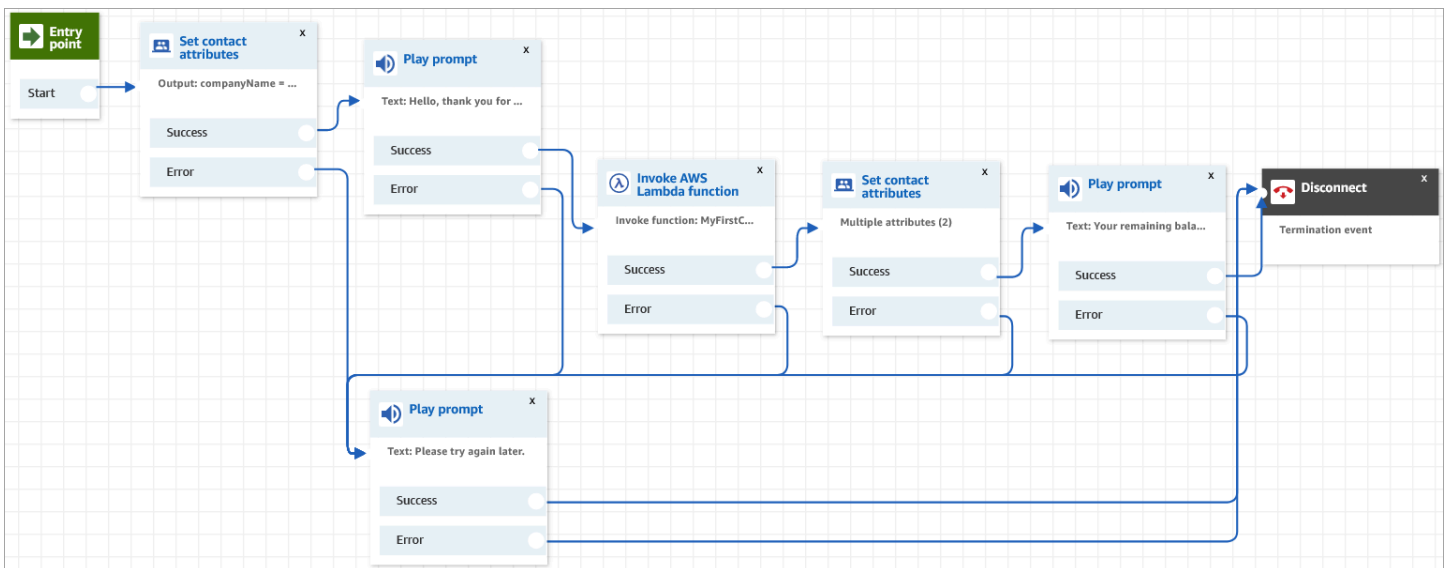

1. Log in to the Amazon Connect admin website at https://instance_name.my.connect.aws/.

2. On the navigation menu, go to **Routing, Flows, Create a contact flow**.
3. Drag a [Set contact attributes](#) block onto the grid, and configure its properties page shown in the following image:

Set contact attributes

Define and store key-value pairs as contact attributes. [Info](#)

i Contact attributes are accessible by other areas of Amazon Connect, such as the Contact Control Panel (CCP) and Contact Trace Records (CTRs).

Namespace
User defined

Attribute
companyName

Set manually

Value
GGG

Set dynamically

[Add another attribute](#)

- a. **Namespace = User defined.**
 - b. **Attribute = companyName.**
 - c. Choose **Set manually**. **Value = GGG.**
 - d. Choose **Save**.
4. Drag a [Play prompt](#) block onto the grid, and configure its properties page as shown in the following image:

Play prompt

Delivers an audio or chat message. [Info](#)

Select from the prompt library (audio)

Specify an audio file from an S3 bucket

Text-to-speech or chat text

Set manually

Enter text to be spoken

Hello, thank you for calling
\$.Attributes.companyName.inc.

Set dynamically

Interpret as
SSML

- a. Choose **Text-to-speech or chat text**, **Set manually**, and set **Interpret as** to **SSML**. Enter the following text in the box for the text to be spoken:

Hello, thank you for calling \$.Attributes.companyName inc.
 - b. Choose **Save**.
5. Drag another [Play prompt](#) block onto the grid, and configure its properties page as shown in the following image:

Play prompt



Delivers an audio or chat message. [Info](#)

- Select from the prompt library (audio)
- Specify an audio file from an S3 bucket
- Text-to-speech or chat text
- Set manually

Enter text to be spoken
Please try again later.

- Set dynamically

Interpret as
Text

- a. Choose **Text-to-speech or chat text**, **Set manually**, and set **Interpret as** to **Text**. Enter the following text in the box for the text to be spoken:

Please try again later.
 - b. Choose **Save**.
6. Drag a [Invoke AWS Lambda function](#) block onto the grid, and configure its properties page as shown in the following image:

Invoke AWS Lambda function

Makes a call to AWS Lambda and optionally returns key/value pairs, which can be used to set contact attributes. [Info](#)

Function ARN

Set manually

MyFirstConnectLambda

Set dynamically

Function input parameters

Destination Key ×

companyName

Value

Set manually

Set dynamically

Namespace

User defined

Attribute

companyName

- a. Choose **Select manually**, and then choose **MyFirstConnectLambda** from the dropdown.
 - b. In the **Destination Key** box, enter **companyName**. (This is sent to Lambda.)
 - c. Choose **Set dynamically** box
 - d. For **Namespace**, select **User Defined**.
 - e. For **Attribute**, enter **companyName**.
 - f. Choose **Save**.
7. Drag a [Set contact attributes](#) block onto the grid, choose **Add another attribute**, and configure its properties page as shown in the following image:

Set contact attributes

Define and store key-value pairs as contact attributes. [Info](#)

i Contact attributes are accessible by other areas of Amazon Connect, such as the Contact Control Panel (CCP) and Contact Trace Records (CTRs).

Namespace
×

User defined

Attribute

MyBalance

Set manually

 Set dynamically

Namespace
×

External

Attribute

customerBalance

Namespace
×

User defined

Attribute

Set manually

 Set dynamically

Namespace
×

External

Attribute

websiteUrl

[Add another attribute](#)

- a. **Namespace = User Defined. Attribute = MyBalance.**
- b. **Choose Set dynamically.**
- c. **Namespace = External.**
- d. **Attribute = customerBalance.** This is the result from Lambda.
- e. **Choose Add another attribute.**
- f. **Namespace = User-defined.**
- g. **Attribute = MyURL.**
- h. **Select Set dynamically. Namespace =External.**

- i. **Attribute = websiteUrl.** This is the result from Lambda.
 - j. Choose **Save**.
8. Drag a [Play prompt](#) block onto the grid, and configure its properties page as shown in the following image:

- a. Choose **Text-to-speech or chat text**, and set **Interpret as** to **SSML**. Enter the following text in the box:

```
Your remaining balance is <say-as interpret-as="characters">$.Attributes.MyBalance</say-as>.
Thank you for calling $.Attributes.companyName.
Visit $.Attributes.MyURL for more information.
```
 - b. Choose **Save**.
9. Drag a [Disconnect / hang up](#) block onto the grid.
10. Connect the all blocks so your flow looks like the image shown at the top of this procedure.
11. Enter **MyFirstConnectFlow** as the name, and then choose **Publish**.
12. On the navigation menu, go to **Channels, Phone numbers**.

13. Select your phone number.
14. Select **MyFirstConnectFlow** and choose **Save**.

Now try it out. Call the number. You should hear a greeting message, your balance, and the website to visit.

Set up live media streaming of customer audio

In Amazon Connect, you can capture customer audio during an interaction with your contact center by sending the audio to a Kinesis video stream. Depending on your settings, audio can be captured for the entire interaction—until the interaction with the agent is complete—or only one direction:

- What the customer hears, including what the agent says and system prompts.
- What the customer says, including when they are on hold.

The customer audio streams also include interactions with an Amazon Lex bot, if you're using one in your flow.

You can perform analysis on the audio streams to determine customer sentiment, use the audio for training purposes, or to later review the audio to identify and flag abusive callers.

Contents

- [Plan for live media streaming](#)
- [Enable live media streaming in your instance](#)
- [How to access Kinesis Video Streams data](#)
- [Example flow for testing live media streaming](#)
- [Contact attributes for live media streaming](#)

Plan for live media streaming

Important

If you want to use the audio streaming feature, you need to retain the streams that are created by Amazon Connect. Don't delete them, unless you're going to stop using the streaming feature.

You can send all audio to and from the customer to Kinesis Video Streams. Media streaming leverages Kinesis Video Streams multi-track support so that what the customer says is on a separate track from what the customer hears.

Audio sent to Kinesis uses a sampling rate of 8 kHz.

Do you need to increase your service quotas?

When you enable media streaming in Amazon Connect, one Kinesis video stream is used per active call. By default we allocate 50 streams per instance to your account. We automatically create additional streams as needed to keep pace with active calls, unless your account reaches the [Kinesis Video Streams service quota](#).

Contact AWS Support to request an increase to **Number of Streams**.

To request an increase to your service quota, in the AWS Support Center, choose **Create Case** and then choose **Service Quota Increase**.

Tip

We make sure that **PutMedia** requests always stay within the 5 TPS quota. You don't need to request an increase.

How long do you need to store audio?

Customer audio is stored in Kinesis for the time defined by your retention settings in an Amazon Connect instance. For instructions for setting this value, see [Enable live media streaming in your instance](#).

Do you need to change the audio streams?

We recommend that you refrain from modifying the streams. Doing so can cause unexpected behavior.

Who requires IAM permissions to retrieve data?

If your business is using IAM permissions, your AWS admin will need to grant permissions to people who are going to retrieve data from Kinesis Video Streams. They'll need to grant them full access permissions for Kinesis Video Streams and AWS Key Management Service.

Enable live media streaming in your instance

Live media streaming (customer audio streams) is not enabled by default. You can enable customer audio streams from the settings page for your instance.

To enable live media streaming

1. Open the Amazon Connect console at <https://console.aws.amazon.com/connect/>.
2. On the instances page, choose the instance alias. The instance alias is also your **instance name**, which appears in your Amazon Connect URL. The following image shows the **Amazon Connect virtual contact center instances** page, with a box around the instance alias.
3. In the navigation pane, choose **Data storage**.
4. Under **Live media streaming**, choose **Edit**. Choose **Enable live media streaming**.
5. Enter a prefix for the Kinesis Video Streams created for your customer audio. This prefix makes it easier for you to identify the stream with the data.
6. Choose the KMS key to use to encrypt the data sent to Kinesis. The KMS key must be in the same Region as the instance.
7. Specify a number and unit for the **Data retention period**.

Important

If you select **No data retention**, data is not retained and is available to be consumed for only 5 minutes. This is the default minimum time that Kinesis retains data. Because Amazon Connect uses Kinesis for streaming, [Kinesis Video Streams quotas](#) apply.

8. Choose **Save** under **Live media streaming**, and then choose **Save** at the bottom of the page.

After you enable live media streaming, add **Start media streaming** and **Stop media streaming** blocks to your flow. Configure those blocks to specify what audio you want to capture. For instructions and an example, see [Example flow for testing live media streaming](#).

How to access Kinesis Video Streams data

To help you get started with development using live media streaming, Amazon Connect includes the following Kinesis Video Streams repository that contains a basic example of how to consume

audio data from your Kinesis Video Streams: <https://github.com/amazon-connect/connect-kvs-consumer-demo>

This demo builds upon the high level abstractions provided by the Kinesis Video Streams Parser Library to read the AUDIO_TO_CUSTOMER and AUDIO_FROM_CUSTOMER tracks published by Amazon Connect. It stores this data as a raw PCM file. This file can be transformed, transcoded, or played back.

Example flow for testing live media streaming

Here's how you can set up a flow to test live media streaming:

1. Add a **Start media streaming** block at the point where you want to enable customer audio streaming.
2. Connect the **Success** branch to the rest of your flow.
3. Add a **Stop media streaming** block to where you want to stop streaming.
4. Configure both blocks to specify what you want to stream: **From the customer** and/or **To the customer**.

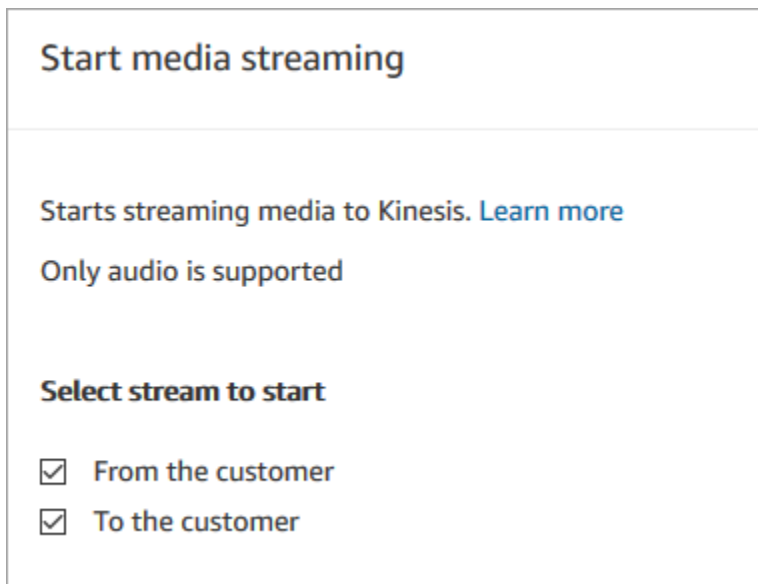

Start media streaming

Starts streaming media to Kinesis. [Learn more](#)

Only audio is supported

Select stream to start

From the customer

To the customer

Customer audio is captured until a **Stop media streaming** block is invoked, even if the contact is passed to another flow.

Use the contact attributes for media streaming in your flow so that the contact record includes the attributes. You can then view the contact record to determine the media streaming data associated with a specific contact. You can also pass the attributes to an AWS Lambda function.

The following example flow shows how you might use media streaming with attributes for testing purposes. This flow includes a **Start media streaming** block but it is missing the **Stop media streaming** block.

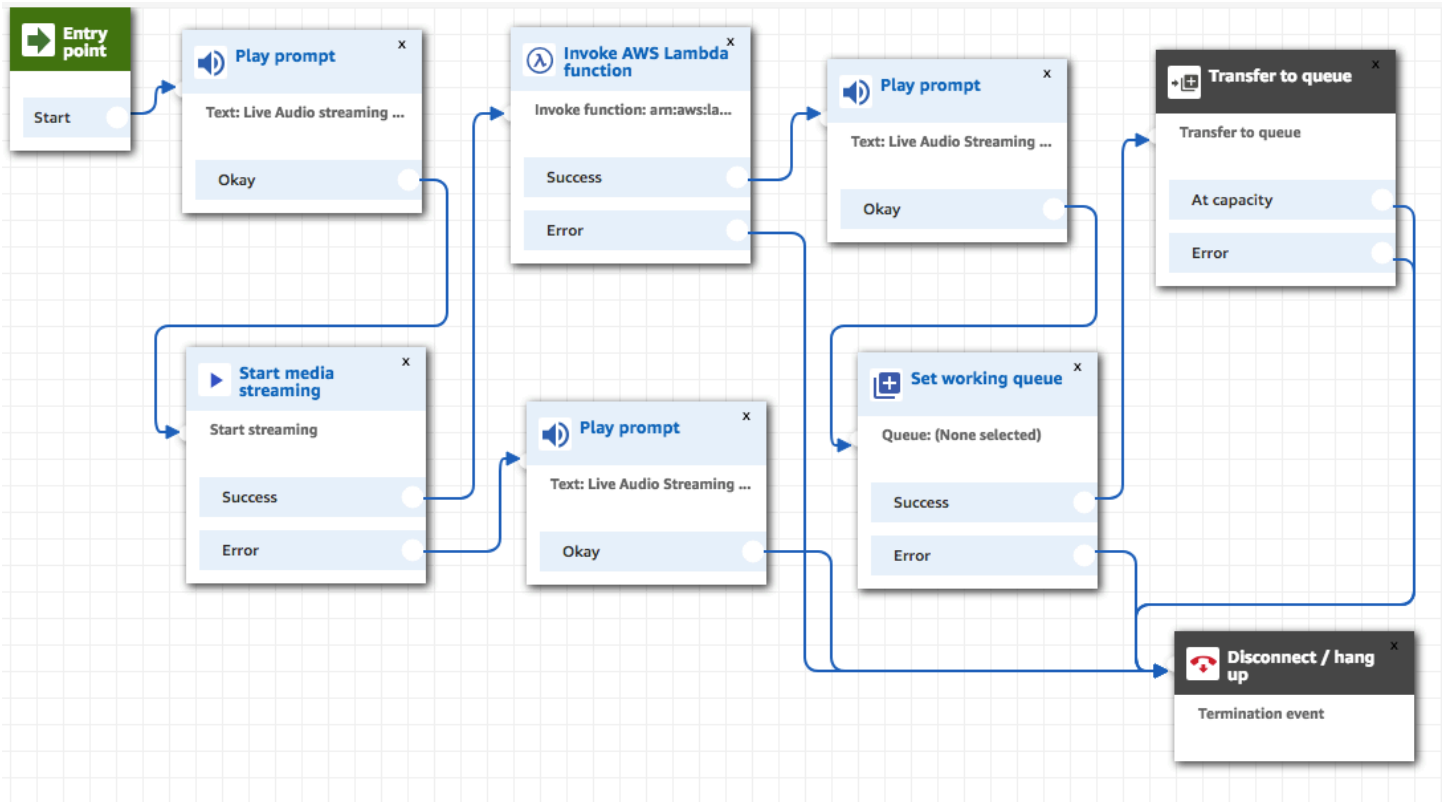

After the audio is successfully streamed to Kinesis Video Streams, the contact attributes are populated from the **Invoke AWS Lambda function** block. You can use the attributes to identify the location in the stream where the customer audio starts. For instructions, see [Contact attributes for live media streaming](#).

Contact attributes for live media streaming

The attributes are displayed when you select **Media streams** for the **Type** in a flow block that supports attributes, such as the **Start media streaming** block. They include the following:

Customer audio stream ARN

The ARN of the Kinesis video stream that includes the customer data to reference.

JSONPath format: \$.MediaStreams.Customer.Audio.StreamARN

Customer audio start timestamp

The time at which the customer audio stream started.

JSONPath format: \$.MediaStreams.Customer.Audio.StartTimestamp

Customer audio stop timestamp

The time at which the customer audio stream stopped.

JSONPath format: \$.MediaStreams.Customer.Audio.StopTimestamp

Customer audio start fragment number

The number that identifies the Kinesis Video Streams fragment in which the customer audio stream started.

JSONPath format: \$.MediaStreams.Customer.Audio.StartFragmentNumber

For more information about Amazon Kinesis Video Streams fragments, see [Fragment](#) in the *Amazon Kinesis Video Streams Developer Guide*.

Encrypt customer input

You can encrypt sensitive data that is collected by flows. To do this, you need to use public-key cryptography.

When configuring Amazon Connect, you first provide the public key. This is the key used when encrypting data. Later, you provide the X.509 certificate, which includes a signature that proves you possess the private key.

In a flow that collects data, you provide an X.509 certificate to encrypt data that's captured using the **Stored customer input** system attribute. You must upload the key in .pem format to use this feature. The encryption key is used to verify the signature of the certificate used within the flow.

Note

You can have up to two encryption keys active at one time to facilitate rotation.

To decrypt the data in the **Stored customer input** attribute, use the AWS Encryption SDK. For more information, see the [AWS Encryption SDK Developer Guide](#).

For a detailed walkthrough, see [Creating a secure IVR solution with Amazon Connect](#). It shows how to:

- Configure Amazon Connect to collect a credit card number.
- Encrypt the credit card digits.
- Send it to our backend AWS Lambda for decryption, using the customer supplied decryption key.

It provides two commands using OpenSSL:

- One to generate an RSA key pair and a self-signed X.509 certificate
- Another to extract the public key from the RSA key pair

How to decrypt data encrypted by Amazon Connect

The following code sample shows how to decrypt data using the AWS Encryption SDK.

```
package com.amazonaws;

import com.amazonaws.encryptionsdk.AwsCrypto;
import com.amazonaws.encryptionsdk.CryptoResult;
import com.amazonaws.encryptionsdk.jce.JceMasterKey;
import org.bouncycastle.jce.provider.BouncyCastleProvider;

import java.io.IOException;
import java.nio.charset.Charset;
import java.nio.file.Files;
import java.nio.file.Paths;
import java.security.GeneralSecurityException;
import java.security.KeyFactory;
import java.security.Security;
import java.security.interfaces.RSAPrivateKey;
import java.security.spec.PKCS8EncodedKeySpec;
import java.util.Base64;

public class AmazonConnectDecryptionSample {

    // The Provider 'AmazonConnect' is used during encryption, this must be used during
    // decryption for key
    // to be found
    private static final String PROVIDER = "AmazonConnect";

    // The wrapping algorithm used during encryption
```

```

private static final String WRAPPING_ALGORITHM = "RSA/ECB/
OAEPWithSHA-512AndMGF1Padding";

/**
 * This sample show how to decrypt data encrypted by Amazon Connect.
 * To use, provide the following command line arguments: [path-to-private-key]
[key-id] [cyphertext]
 * Where:
 * path-to-private-key is a file containing the PEM encoded private key to use for
decryption
 * key-id is the key-id specified during encryption in your flow
 * cyphertext is the result of the encryption operation from Amazon Connect
 */
public static void main(String[] args) throws IOException, GeneralSecurityException
{
    String privateKeyFile = args[0]; // path to PEM encoded private key to use for
decryption
    String keyId = args[1]; // this is the id used for key in your flow
    String cypherText = args[2]; // the result from flow

    Security.addProvider(new BouncyCastleProvider());

    // read the private key from file
    String privateKeyPem = new
String(Files.readAllBytes(Paths.get(privateKeyFile)), Charset.forName("UTF-8"));
    RSAPrivateKey privateKey = getPrivateKey(privateKeyPem);

    AwsCrypto awsCrypto = new AwsCrypto();
    JceMasterKey decMasterKey =
        JceMasterKey.getInstance(null,privateKey, PROVIDER, keyId,
WRAPPING_ALGORITHM);
    CryptoResult<String, JceMasterKey> result =
awsCrypto.decryptString(decMasterKey, cypherText);

    System.out.println("Decrypted: " + result.getResult());
}

public static RSAPrivateKey getPrivateKey(String privateKeyPem) throws IOException,
GeneralSecurityException {
    String privateKeyBase64 = privateKeyPem
        .replace("-----BEGIN RSA PRIVATE KEY-----\n", "")
        .replace("-----END RSA PRIVATE KEY-----", "")
        .replaceAll("\n", "");
    byte[] decoded = Base64.getDecoder().decode(privateKeyBase64);

```

```
KeyFactory kf = KeyFactory.getInstance("RSA");
PKCS8EncodedKeySpec keySpec = new PKCS8EncodedKeySpec(decoded);
RSAPrivateKey privKey = (RSAPrivateKey) kf.generatePrivate(keySpec);
return privKey;
}
}
```

Track events as customers interact with flows

Amazon Connect flow logs provide you with real-time details about events in your flows as customers interact with them. You can also use flow logs to help debug your flows as you are creating them. If needed, you can always [roll back](#) to a previous version of a flow.

Tip

To learn how to troubleshoot flow errors in Amazon Connect, check out this workshop: [Troubleshooting flow errors in Amazon Connect](#).

Contents

- [Flow logs stored in an Amazon CloudWatch log group](#)
- [Enable flow logs](#)
- [Search flow logs](#)
- [What data is gathered in flow logs](#)
- [Track customers between flows](#)
- [Create alerts for flow log events](#)

Flow logs stored in an Amazon CloudWatch log group

Flow logs are stored in an Amazon CloudWatch log group, in the same AWS Region as your Amazon Connect instance. This log group is created automatically when [Enable flow logging](#) is turned on for your instance.

For example, the following image shows the CloudWatch log groups for two test instances.

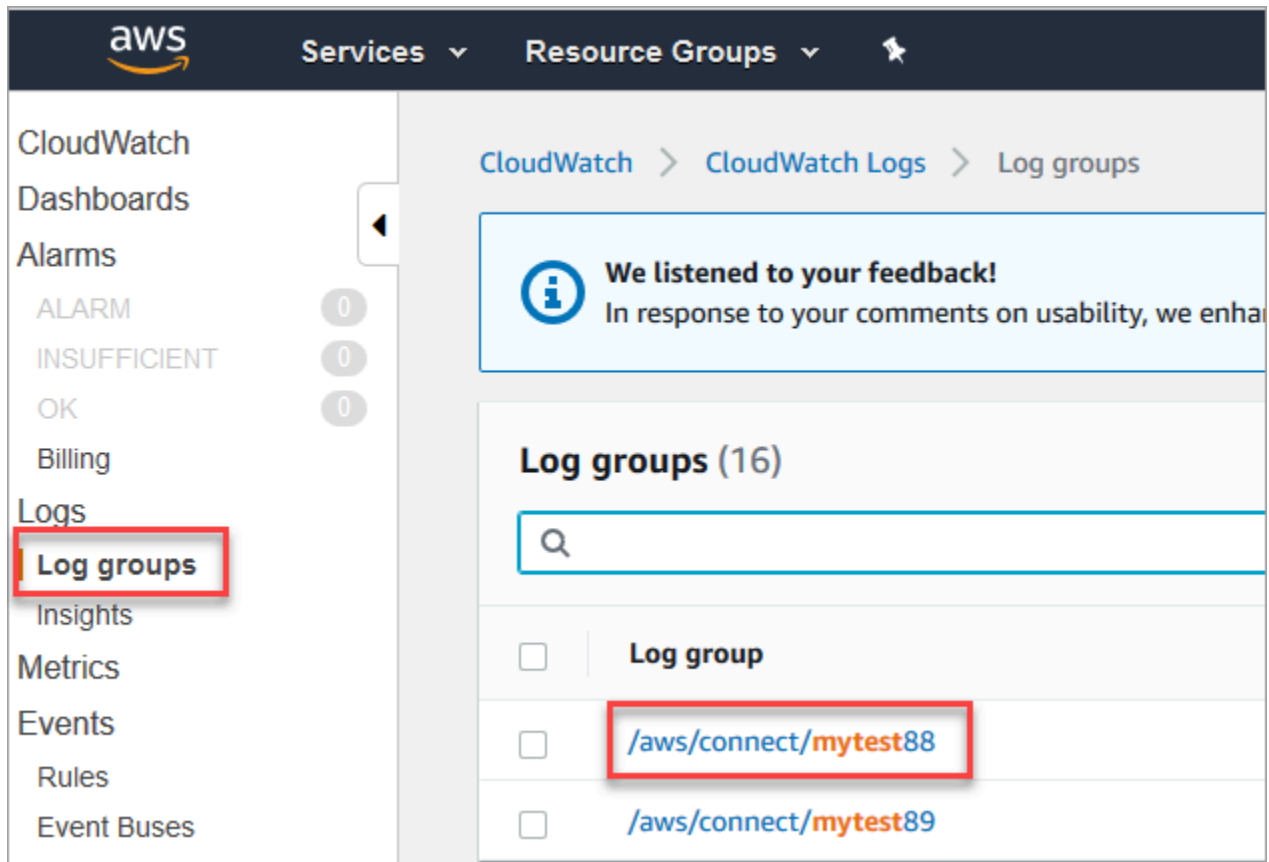

A log entry added as each block in your flow is triggered. You can configure CloudWatch to send alerts when unexpected events occur during active flows.

What happens if my log group is deleted? You need to manually re-create the CloudWatch log group. Otherwise, Amazon Connect won't publish more logs.

Pricing for flow logging

You are not charged for generating flow logs, but you are charged for using CloudWatch for generating and storing the logs. Free tier customers are charged only for usage that exceeds service quotas. For details about Amazon CloudWatch pricing, see [Amazon CloudWatch Pricing](#).

Enable flow logs

Tip

Amazon Connect delivers flow logs at least once. They may be delivered again for multiple reasons. For example, a service retry due to an unavoidable failure.

Step 1: Enable logging for your instance

By default when you create a new Amazon Connect instance, an Amazon CloudWatch log group is created automatically to store the logs for your instance.

Use the following procedure to check that logging is enabled for your instance.

1. Open the Amazon Connect console at <https://console.aws.amazon.com/connect/>.
2. On the instances page, choose the instance alias. The instance alias is also your **instance name**, which appears in your Amazon Connect URL. The following image shows the **Amazon Connect virtual contact center instances** page, with a box around the instance alias.

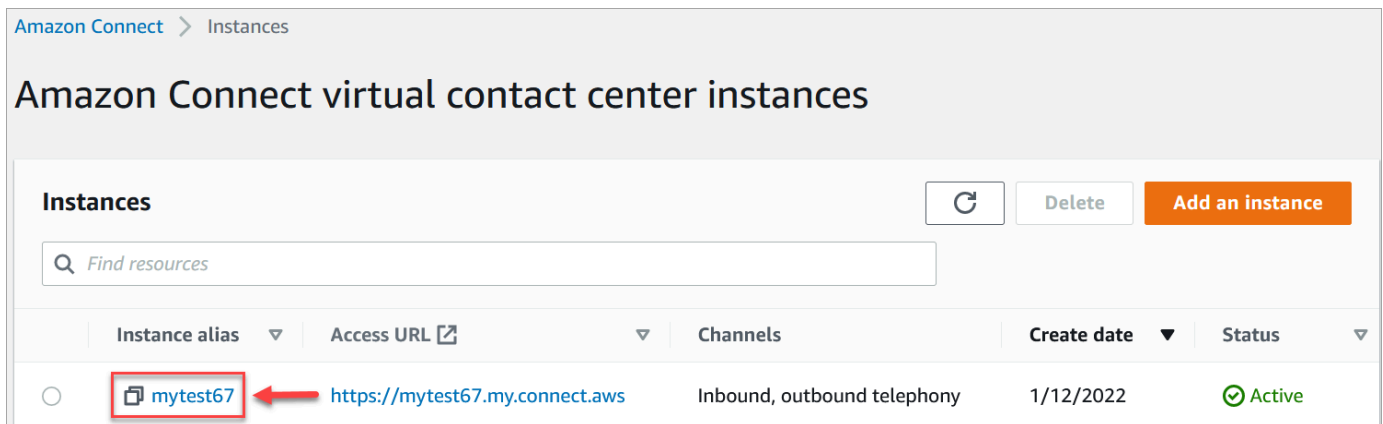

3. In the navigation pane, choose **Flows**.
4. Select **Enable Flow logs** and choose **Save**.

Step 2: Add the Set logging behavior block

Logs are generated only for flows that include a [Set logging behavior](#) block with logging set to enabled.

You control which flows, or parts of flows, logs are generated for by including multiple **Set logging behavior** blocks and configuring them as needed.

When you use a **Set logging behavior** block to enable or disable logging for a flow, logging is also enabled or disabled for any subsequent flow that a contact is transferred to, even if the flow does not include a **Set logging behavior** block. To avoid logging that persists between flows, enable or disable a **Set logging behavior** block as needed for that specific flow.

To enable or disable flow logs for a flow

1. In the flow designer, add a [Set logging behavior](#) block and connect it to another block in the flow.
2. Open the properties for the block. Choose **Enable** or **Disable**.
3. Choose **Save**.
4. If you add a **Set logging behavior** block to a flow that is already published, you must publish it again to start generating logs for it.

Search flow logs

Before you can search flow logs, you must first [enable flow logging](#).

Logs will be created for conversations that occur after logging is enabled.

To search flow logs

1. Open Amazon CloudWatch console, go to **Logs, Log groups**. The following image shows a sample log group named **mytest88**.

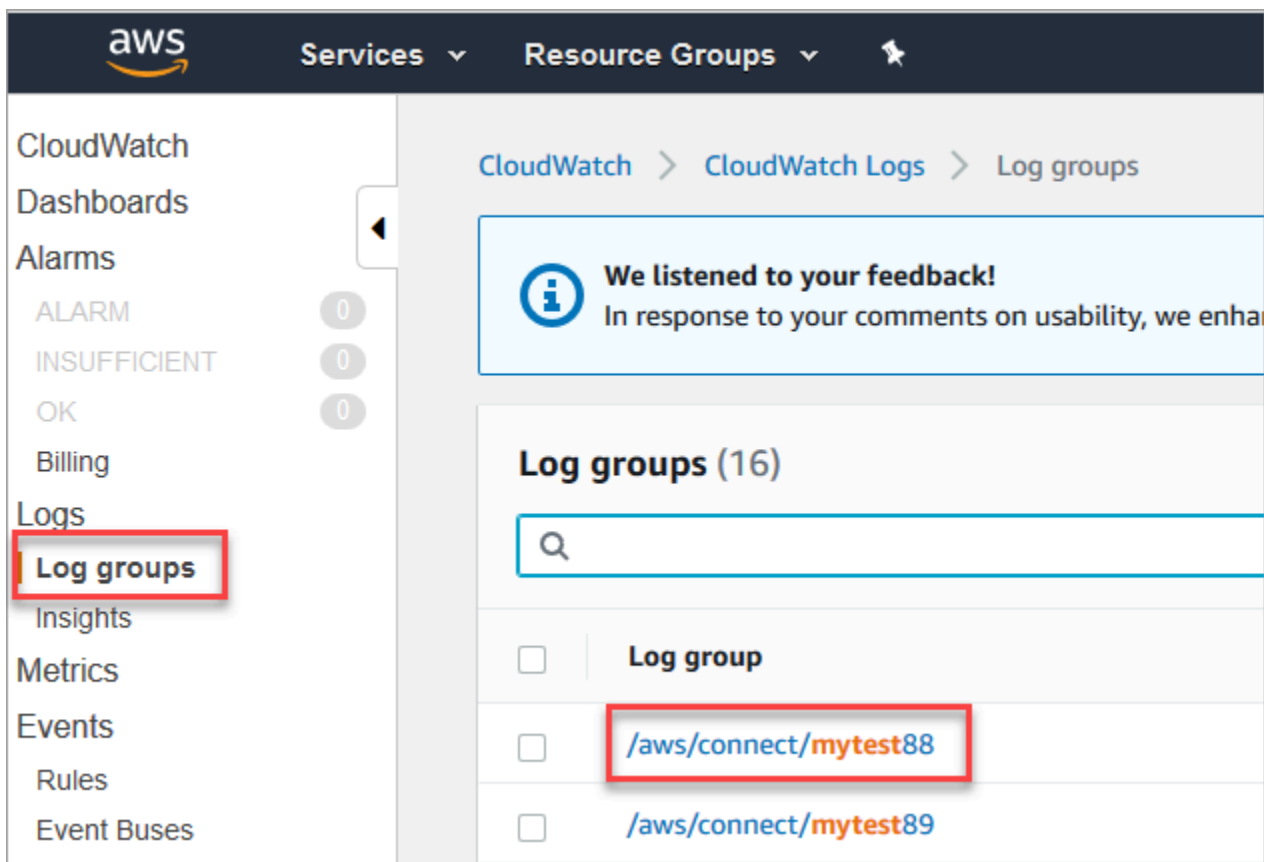

2. Choose the log group for your instance.

A list of log streams will be displayed.

3. To search all the log streams in the instance, choose **Search log group**, as shown in the following image.

The screenshot shows the Amazon CloudWatch console interface for a log group. At the top, the breadcrumb navigation is 'CloudWatch > CloudWatch Logs > Log groups > /aws/connect/mytest88'. The main header displays the log group name '/aws/connect/mytest88' and three buttons: 'Actions', 'View in Logs Insights', and 'Search log group'. A red arrow points to the 'Search log group' button. Below this is a 'Log group details' section with a grid of information:

Retention Never expire	Creation time 1 year ago	Stored bytes 34.67 KB	ARN arn:aws:logs:us-west-2: [redacted] log-group:/aws/connect/mytest88:*
KMS key ID -	Metric filters 0	Subscription filters 0	Contributor Insights rules -

Below the details is a navigation bar with tabs: 'Log streams' (selected), 'Metric filters', 'Subscription filters', 'Contributor Insights', and 'Tags'. The 'Log streams (21)' section contains a search box with the placeholder 'Filter log streams or try prefix search', a refresh button, a 'Delete' button, a 'Create log stream' button, and a 'Search all' button. Below the search box is a table of log streams:

<input type="checkbox"/>	Log stream	Last event time
<input type="checkbox"/>	2020/06/29/18/stream-QAyFdAi_xjF_JcmyYx-2qA==	2020-06-29 11:20:26 (UTC-07:00)
<input type="checkbox"/>	2020/06/11/20/stream-DCuAoTMdE3LA7YbwAvKUH...	2020-06-11 13:23:55 (UTC-07:00)

4. In the search box, enter the string you want to search for, for example, all or a portion of the contact ID.
5. After a couple of moments (longer depending on how big your log is), Amazon CloudWatch returns results. The following image shows a sample contact ID **fb3304c2**, and the result.

CloudWatch > CloudWatch Logs > Log groups > /aws/connect/mytest88 > All events

Log events

You can use the filter bar below to search for and match terms, phrases, or values in your log events. [Learn more about filter patterns](#)

View as text

1m 30m 1h 12h Custom

Timestamp	Message	Log stream name
2020-02-13T11:05:17.777-08:00	{"ContactId": "fb3304c2-6105-49...	2020/02/13/19/stream-KdoOxBc55SykRkVOvR...
2020-02-13T11:05:17.778-08:00	{"ContactId": "fb3304c2-6105-49...	2020/02/13/19/stream-KdoOxBc55SykRkVOvR...
2020-02-13T11:05:17.780-08:00	{"ContactId": "fb3304c2-6105-49...	2020/02/13/19/stream-KdoOxBc55SykRkVOvR...
2020-02-13T11:05:20.853-08:00	{"ContactId": "fb3304c2-6105-49...	2020/02/13/19/stream-KdoOxBc55SykRkVOvR...
2020-02-13T11:05:32.408-08:00	{"Results": "Networkissue", "Con...	2020/02/13/19/stream-KdoOxBc55SykRkVOvR...

6. You can open each event to see what happened. The following image shows the event for when a **Play prompt** block runs in a flow.

2020-02-13T11:05:17.780-08:00 {"ContactId": "fb3304c2-6105-49... 2020/02/13/19/stream-KdoOxBc55SykRkVOvR...

```

{
  "ContactId": "fb3304c2-...",
  "ContactFlowId": "arn:aws:connect:us-west-2:...:instance/1442a628-...:flow/f4059b9b3e0c/contact-flow/e5a493ea-3567-4cfd-...",
  "ContactFlowModuleType": "PlayPrompt",
  "Timestamp": "2020-02-13T19:05:17.780Z",
  "Parameters": {
    "TextToSpeechType": "text",
    "Text": "Welcome to the IT Help desk!",
    "Voice": "Joanna",
    "GlobalEngine": "Standard"
  }
}

```

What data is gathered in flow logs

Log entries for flows include details about the block associated with the log entry, the contact ID, and the action taken after the steps in the block were completed. Any contact interaction that occurs outside of the flow is not logged, such as time spent in a queue or interactions with an agent.

You can set the properties of the block to disable logging during the parts of your flow that interact with or capture sensitive data or customers' personal information.

If you use Amazon Lex or AWS Lambda in your flows, the logs show the entry and exit of the flow going to them, and include any information about the interaction that is sent or received during entry or exit.

Because the logs also include the flow ID, and the flow ID stays the same when you change a flow, you can use the logs to compare the interactions with different versions of the flow.

The following example log entry shows a **Set working queue** block of an inbound flow.

```
{
  "ContactId": "11111111-2222-3333-4444-555555555555",
  "ContactFlowId": "arn:aws:connect:us-west-2:0123456789012:instance/
nnnnnnnnnn-3333-4444-5555-111111111111/contact-flow/123456789000-aaaa-bbbbbbbbbb-
cccccccccccc",
  "ContactFlowModuleType": "SetQueue",
  "Timestamp": "2021-04-13T00:14:31.581Z",
  "Parameters": {
    "Queue": "arn:aws:connect:us-west-2:0123456789012:instance/
nnnnnnnnnn-3333-4444-5555-111111111111/queue/aaaaaaaa-bbbb-cccc-dddd-eeeeeeeeeeee"
  }
}
```

Track customers between flows

In many cases, customers interact with multiple flows in your contact center, being passed from one flow to another to appropriately assist them with their specific issue. Flow logs help you track customers between different flows, by including the ID of the contact in each log entry.

When a customer is transferred to a different flow, the ID for the contact associated with their interaction is included with the log for the new flow. You can query the logs for the contact ID to trace the customer interaction through each flow.

In larger, high-volume contact centers, there can be multiple streams for flow logs. If a contact is transferred to a different flow, the log may be in a different stream. To make sure that you are finding all of the log data for a specific contact, you should search for the contact ID in the entire CloudWatch log group instead of in a specific log stream.

For a diagram that shows when a new contact record is created, see [Events in the contact record](#).

Create alerts for flow log events

You can configure CloudWatch to define a filter pattern that looks for specific events in your flow logs and then creates an alert when an entry for that event is added to the log.

For example, you can set an alert for when a flow block goes down an error path as a customer interacts with the flow. Log entries are typically available in CloudWatch within a short time, giving you near real-time notification of events in flows.

Use Amazon Connect contact attributes

One way to make your customers feel cared for is to create personalized experiences for them in your contact center. For example, you can deliver one welcome message for customers who are using a phone and another for customers using chat. To do this, you need a way to store information about the contact and then make a decision based on the value.

Contents

- [What is a contact attribute?](#)
- [List of available contact attributes and their JSONPath reference](#)
- [How to reference contact attributes](#)
- [Display contact information to the agent in the CCP](#)
- [Route based on number of contacts in a queue](#)
- [Route based on contact's channel](#)
- [Use Amazon Lex and attributes](#)
- [Lambda functions and attributes](#)

What is a contact attribute?

In Amazon Connect, each interaction with a customer is a **contact**. The interaction can be a phone call (voice), a chat, or an automated interaction using an Amazon Lex bot.

Each contact can have some data that is specific to a particular interaction. This data can be accessed as a contact attribute. For example:

- The name of the customer
- The name of the agent

- The channel used for the contact, such as phone or chat
- And more

A contact attribute represents this data as a key-value pair. You might think of it as a field name together with the data entered into that field.

For example, here are a couple of key-value pairs for the customer name:

Key	Value
firstname	Jane
lastname	Doe

The advantage of contact attributes is that they enable you to store temporary information about the contact so you can use it in the flow.

For example, in your welcome messages, you can say their name or thank them for being a member. To do this, you need a way of retrieving data about that specific customer and using it in a flow.

Common use cases

Here are some common use cases for where contact attributes are used:

- Use the customer phone number to schedule a queued callback.
- Identify which agent is interacting with a customer so that a post call survey can be associated with a contact.
- Identify the number of contacts in a queue to decide if the contact should be routed to a different queue.
- Get the corresponding media streaming ARN to store in a database.
- Use the customer phone number to identify the status of a customer (for example, are they a member), or the status of their order (shipped, delayed, etc.) to route them to the appropriate queue.
- Based on a customer interaction with a bot, identify the slot (for example, the type of flowers to order) to be used in a flow.

Types of contact attributes

To make it faster for you to find and choose the attributes you want to use, attributes are grouped into **types**. For each flow block, we only surface those types of attributes that work with it.

Another way to think about types of contact attributes is to categorize them based on where the value comes from. The values for contact attributes have the following sources:

- Amazon Connect provides the value, such as the agent's name, during the contact interaction. This is known as providing the value at runtime.
- An external process, such as Amazon Lex or AWS Lambda, provides the value.
- [User-defined](#). In the flow, you can specify the value for an attribute.

[Flow attributes](#) are similar to user-defined attributes. However, unlike user-defined attributes, flow attributes are restricted to the flow in which they are configured.

The following illustration lists the types of available contact attributes, and maps them to the three sources for the values: Amazon Connect, external process such as Amazon Lex, and user-defined.

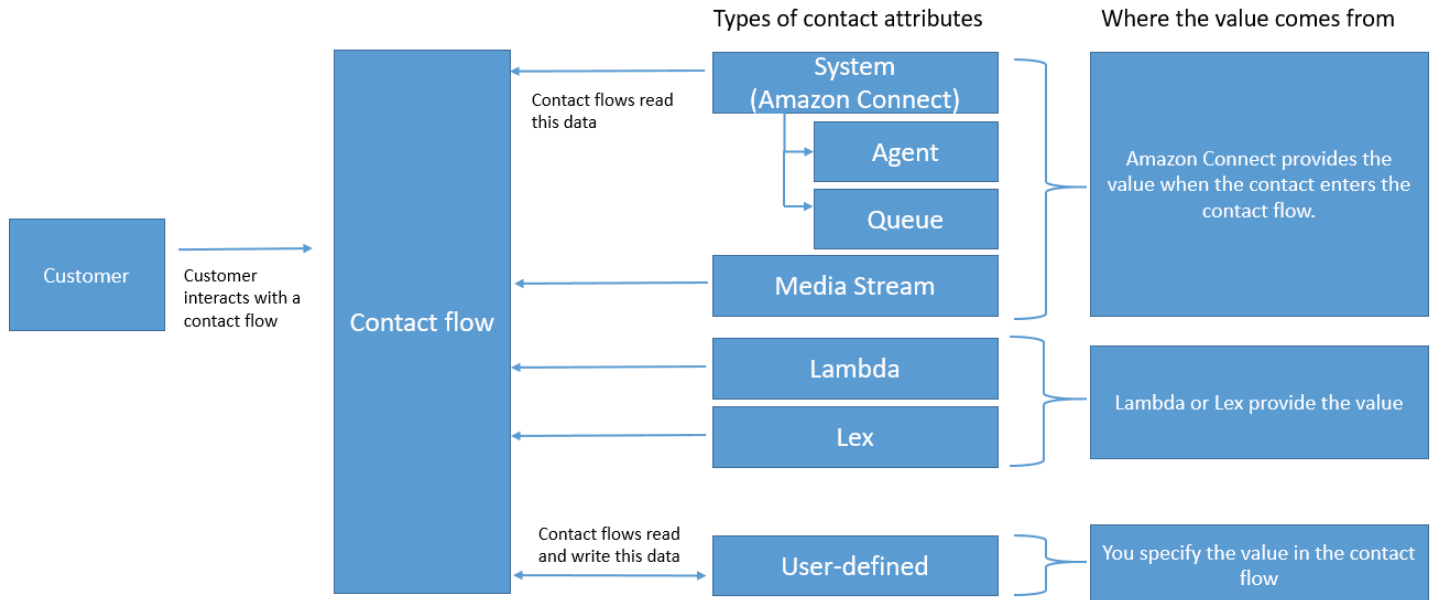

Contact attributes in the contact record

In contact records, contact attributes are shared across all contacts with the same InitialContactId.

For example, while carrying out transfers, a contact attribute updated in the transfer flow updates the attribute's value in the contact attributes of both contact records (that is, the Inbound and Transfer contact attributes).

"\$" is a special character

Amazon Connect treats the "\$" character as a special character. You can't use it in a key when setting an attribute.

For example, let's say you're creating an interact block with text-to-speech. You set an attribute like this:

```
{"$one":"please read this text"}
```

When Amazon Connect reads this text, it reads "dollar sign one" to the contact instead of "please read this text." Also, if you were to include \$ in a key and try to reference the value later using Amazon Connect, it wouldn't retrieve the value.

Amazon Connect does log and pass the full key:value pair ({"_\$one":"please read this text"}) to integrations such as Lambda.

What happens if an attribute doesn't exist

Be sure to implement logic to handle if the attribute doesn't exist and the contact is routed down the error branch.

Let's say you add an attribute to the Store customer input block. The **Namespace** is **Agent** and the **Key** is **User name**, as shown in the following example.

The screenshot shows a configuration window titled 'Block Type' with a close button (X) in the top right corner. The main title is 'Store customer input' with a cloud icon. Below this is a 'Block Name' field with a placeholder 'Enter a block name' and a character count '0 / 50'. A description follows: 'Stores numerical input to contact attribute. Plays an interruptible audio prompt and stores digits via DTMF as a contact attribute. Info'. Under the 'Prompt' section, there are three radio button options: 'Select from the prompt library (audio)' (selected), 'Set manually', and 'Set dynamically'. Below these are two dropdown menus: 'Namespace' with 'Agent' selected, and 'Key' with 'User name' selected. A red arrow points to the 'User name' option in the 'Key' dropdown.

If the flow runs and the agent user name is not available, then the contact is routed down the error branch.

List of available contact attributes and their JSONPath reference

The following tables describe the contact attributes available in Amazon Connect.

The JSONPath reference for each attribute is provided so you can [create dynamic text strings](#).

System attributes

These are predefined attributes in Amazon Connect. You can reference system attributes, but you cannot create them.

Not all blocks in a flow support using System attributes. For example, you cannot use a System attribute to store customer input. Instead, use a [user-defined attribute](#) to store the data input by a customer.

Attribute	Description	Type	JSONPath Reference
AWS Region	When used, this returns the AWS Region where the contact is being handled. For example, us-west-2, us-east-1, and so on.	System	\$.AwsRegion or \$['AwsRegion']
Customer number	<p>The customer's phone number.</p> <p>When used in an outbound whisper flow, this is the number that the agents dialed to reach the customer. When used in inbound flows, this is the number from which the customer placed the call. This attribute is included in contact records. When used in a Lambda function, it's included in the input object under CustomerEndpoint.</p>	System	\$.CustomerEndpoint.Address
Customer ID	The customer's identification number. For example, the CustomerId may be a customer	System	\$.CustomerId

Attribute	Description	Type	JSONPath Reference
	<p>number from your CRM. You can create a Lambda function to pull the unique customer ID of the caller from your CRM system. Voice ID uses this attribute as the <code>CustomerSpeakerId</code> for the caller.</p>		
Dialed number	<p>The number the customer dialed to call your contact center.</p> <p>This attribute is included in contact records. When used in a Lambda function, it's included in the input object under <code>SystemEndpoint</code>.</p>	System	<code>\$.SystemEndpoint.Address</code>

Attribute	Description	Type	JSONPath Reference
Customer callback number	<p>The number that Amazon Connect uses to call back the customer.</p> <p>This number can be the one used for a queued callback, or when an agent is dialing from the CCP. Transfer to callback queue functionality, or for an agent dialing from the CCP.</p> <p>The default value is the number that the customer used to call your contact center. However, it can be overwritten with the Set callback number block.</p> <p>This attribute is not included in contact records, and it's not accessible in Lambda input. However, you can copy the attribute to a user-defined attribute with the Set contact attribute block, which is included in contact</p>	System	not applicable

Attribute	Description	Type	JSONPath Reference
	records. You can also pass this attribute as a Lambda input parameter in an Invoke AWS Lambda function block, which is not included in contact records.		

Attribute	Description	Type	JSONPath Reference
Stored customer input	<p>An attribute created from the most recent invocation of a Store customer input block.</p> <p>The attribute values created from the most recent Store customer input block invocation. This attribute is not included in contact records, and is not accessible in Lambda input. You can copy the attribute to a user-defined attribute with the Set contact attribute block, which is included in contact records. You can also pass this attribute as a Lambda input parameter in an Invoke AWS Lambda function block,</p>	System	not applicable
Queue name	The name of the queue.	System	\$.Queue.Name
Queue ARN	The ARN for the queue.	System	\$.Queue.ARN

Attribute	Description	Type	JSONPath Reference
Queue outbound number	The Outbound caller ID number for the selected queue. This attribute is only available in outbound whisper flows.	System	
Text to speech voice	The name of the Amazon Polly voice to use for text-to-speech in a contact flow.	System	\$.TextToSpeechVoiceId
Contact id	The unique identifier of the contact.	System	\$.ContactId
Initial Contact id	The unique identifier for the contact associated with the first interaction between the customer and your contact center. Use the initial contact ID to track contacts between flows.	System	\$.InitialContactId
Task Contact id	The unique identifier for the task contact. Use the task contact ID to track tasks between flows.	System	\$.Task.ContactId

Attribute	Description	Type	JSONPath Reference
Previous Contact id	The unique identifier for the contact before it was transferred. Use the previous contact ID to trace contacts between flows.	System	\$.PreviousContactId
Channel	The method used to contact your contact center: VOICE, CHAT, TASK.	System	\$.Channel
Instance ARN	The ARN for your Amazon Connect instance.	System	\$.InstanceARN

Attribute	Description	Type	JSONPath Reference
Initiation method	<p>How the contact was initiated. Valid values include: INBOUND, OUTBOUND, TRANSFER, CALLBACK, QUEUE_TRANSFER, EXTERNAL_OUTBOUND, MONITOR, DISCONNECT, and API. For more information, see InitiationMethod in the <i>Contact records data model</i> topic.</p> <p>Initiation method doesn't work in Agent whisper flows or Customer whisper flows.</p>	System	\$.InitiationMethod
Name	The name of the task.	System	\$.Name
Description	A description of the task.	System	\$.Description

Attribute	Description	Type	JSONPath Reference
References	Links to other documents that are related to a contact.	System	\$.References. <i>ReferenceKey</i> .Value and \$.References. <i>ReferenceKey</i> .Type where <i>ReferenceKey</i> is the user-defined Reference name.
Language	The language of content. Use the standard java.util.Locale. For example, en-US for United States English, jp-JP for Japanese, etc.	System	\$.LanguageCode
System Endpoint Type	The type of the system endpoint. Valid value is TELEPHONE_NUMBER.	System	\$.SystemEndpoint.Type
Customer Endpoint type	The type of the customer endpoint. Valid value is TELEPHONE_NUMBER.	System	\$.CustomerEndpoint.Type

Attribute	Description	Type	JSONPath Reference
Queue Outbound Caller ID number	The outbound caller ID number defined for the queue. This can be useful for reverting the caller ID after setting a custom caller ID.	System	\$.Queue.OutboundCallerId.Address
Queue Outbound Caller ID number type	The type of the outbound caller ID number. Valid value is TELEPHONE_NUMBER.	System	\$.Queue.OutboundCallerId.Type
Tags	The tags used to organize, track, or control access for this resource. For more information about tags, see Tag resources in Amazon Connect and Set up granular billing for a detailed view of your Amazon Connect usage .	System	\$.Tags

Agent attributes

The following table lists the agent attributes available in Amazon Connect.

Attribute	Description	Type	JSONPath Reference
Agent User name	The user name an agent uses to log in to Amazon Connect.	System	\$.Agent.UserName
Agent First name	The agent's first name as entered in their Amazon Connect user account.	System	\$.Agent.FirstName
Agent Last name	The agent's last name as entered in their Amazon Connect user account.	System	\$.Agent.LastName
Agent ARN	The ARN of the agent.	System	\$.Agent.ARN

Note

When you use an agent contact attribute in a **Transfer to agent** flow, the agent attributes reflect the target agent, not the one who initiated the transfer.

Agent attributes are available only in the following types of flows:

- Agent whisper
- Customer whisper
- Agent hold
- Customer hold
- Outbound whisper
- Transfer to agent. In this case, the agent attributes reflect the target agent, not the one who initiated the transfer.

Agent attributes are not available in the following flow types:

- Customer queue
- Transfer to queue
- Inbound flow

Queue attributes

These system attributes are returned when you use a **Get queue metrics** block in your flow.

If there is no current activity in your contact center, null values are returned for these attributes.

Attribute	Description	Type	JSONPath Reference
Queue name	The name of the queue for which metrics were retrieved.	System	\$.Metrics.Queue.Name
Queue ARN	The ARN of the queue for which metrics were retrieved.	System	\$.Metrics.Queue.ARN
Contacts in queue	The number of contacts currently in the queue.	System	\$.Metrics.Queue.Size
Oldest contact in queue	For the contact that has been in the queue the longest, the length of time that the contact has been in the queue, in seconds.	System	\$.Metrics.Queue.OldestContactAge
Agents online	The number of agents currently	System	\$.Metrics.Agents.Offline.Count

Attribute	Description	Type	JSONPath Reference
	online, which means logged in and in any state other than offline.		
Agents available	The number of agents whose state is set to Available.	System	\$.Metrics.Agents.Available.Count
Agents staffed	The number of agents currently staffed, which is agents logged in and in Available, ACW, or Busy states.	System	\$.Metrics.Agents.Staffed.Count
Agents in After contact work	The number of agents currently in the ACW state.	System	\$.Metrics.Agents.AfterContactWork.Count
Agents busy	The number of agents currently active on a contact.	System	\$.Metrics.Agents.Busy.Count
Agents missed count	The number of agents in the Missed state, which is the state an agent enters after a missed contact.	System	\$.Metrics.Agents.Missed.Count
Agents in non-productive state	The number of agents in a non-productive (NPT) state.	System	\$.Metrics.Agents.NonProductive.Count

Telephony call metadata attributes (call attributes)

Telephony metadata provides additional information related to call origination from telephony carriers.

Attribute	Description	Type	JSONPath Reference
P-Charge-Info	The party responsible for the charges associated with the call.	System	\$.Media.Sip.Headers.P-Charge-Info
From	The identity of the end user associated with the request.	System	\$.Media.Sip.Headers.From
To	Information about the called party or the recipient of the request.	System	\$.Media.Sip.Headers.To
ISUP-OLI	Originating Line Indicator (OLI). Shows the type of line placing call (for example, PSTN, 800 service call, wireless/cellular PCS, payphone).	System	\$.Media.Sip.Headers.ISUP-OLI
JIP	Jurisdiction Indication Parameter (JIP). Indicates geographic location of caller/switch. Example value: 212555	System	\$.Media.Sip.Headers.JIP

Attribute	Description	Type	JSONPath Reference
Hop-Counter	Hop Counter. Example value: 0	System	\$.Media.Sip.Headers.Hop-Counter
Originating-Switch	Originating Switch. Example value: 710	System	\$.Media.Sip.Headers.Originating-Switch
Originating-Trunk	Originating Trunk. Example value: 0235	System	\$.Media.Sip.Headers.Originating-Trunk
Call-Forwarding-Indicator	Call Forwarding Indicators (for example, Diversion header). Indicates domestic or international origin of call. Example value: sip:+15555555555@public-vip.us2.telphony-provider.com;reason=unconditional	System	\$.Media.Sip.Headers.Call-Forwarding-Indicator
Calling-Party-Address	Calling Party Address (number). NPAC dip shows true line type and native geographic switch. Example value: 15555555555;noa=4	System	\$.Media.Sip.Headers.Calling-Party-Address

Attribute	Description	Type	JSONPath Reference
Called-Party-Address	Called Party Address (number). Example value: 15555555555;noa=4	System	\$.Media.Sip.Headers.Called-Party-Address

Note

The availability of telephony metadata is not consistent across all telephony providers and may not be available in all cases. This may result in empty values.

Media streams attributes

The following table lists the attributes that you can use to identify the location in the live media stream where the customer audio starts and stops.

Attribute	Description	Type	JSONPath Reference
Customer audio stream ARN	The ARN of the Kinesis Video stream used for Live media streaming that includes the customer data to reference.	Media streams	\$.MediaStreams.Customer.Audio.StreamARN
Customer audio start timestamp in the Kinesis video stream used for Live media streaming.	When the customer audio stream started.	Media streams	\$.MediaStreams.Customer.Audio.StartTimestamp

Attribute	Description	Type	JSONPath Reference
Customer audio stop timestamp	When the customer audio stream stopped the Kinesis video stream used for Live media streaming.	Media streams	\$.MediaStreams.Customer.Audio.StopTimestamp
Customer audio start fragment number	The number that identifies the Kinesis Video Streams fragment, in the stream used for Live media streaming, in which the customer audio stream started.	Media streams	\$.MediaStreams.Customer.Audio.StartFragmentNumber

Amazon Lex contact attributes

The following table lists the attributes that are returned from Amazon Lex bots. These are also known as *session attributes*.

Attribute	Description	Type	JSONPath Reference
Alternate Intents	List of alternate intents available from Amazon Lex. Each intent has a corresponding confidence score and slots to fill.	Lex	\$.Lex.AlternateIntents.x.IntentName \$.Lex.AlternateIntents.x.IntentConfidence \$.Lex.AlternateIntents.x.Slots \$.Lex.AlternateIntents.y.IntentName

Attribute	Description	Type	JSONPath Reference
			\$.Lex.AlternateIntents.y.IntentConfidence \$.Lex.AlternateIntents.y.Slots \$.Lex.AlternateIntents.z.IntentName \$.Lex.AlternateIntents.z.IntentConfidence \$.Lex.AlternateIntents.z.Slots
Intent Confidence Score	The intent confidence score returned by Amazon Lex.	Lex	\$.Lex.IntentConfidence.Score
Intent name	The user intent returned by Amazon Lex.	Lex	\$.Lex.IntentName
Sentiment Label	The inferred sentiment that Amazon Comprehend has the highest confidence in.	Lex	\$.Lex.SentimentResponse.Label

Attribute	Description	Type	JSONPath Reference
Sentiment scores	The likelihood that the sentiment was correctly inferred.	Lex	\$.Lex.SentimentResponse.Scores.Positive \$.Lex.SentimentResponse.Scores.Negative \$.Lex.SentimentResponse.Scores.Mixed \$.Lex.SentimentResponse.Scores.Neutral
Session attributes	Map of key-value pairs representing the session-specific context information.	Lex	\$.Lex.SessionAttributes.attributeKey
Slots	Map of intent slots (key/value pairs) Amazon Lex detected from the user input during the interaction.	Lex	\$.Lex.Slots.slotName
Dialog state	The last dialog state returned from an Amazon Lex bot. The value is 'Fulfilled' if an intent was returned to the flow.	N/A (no type appears in the UI)	\$.Lex.DialogState

Case contact attributes

The following table lists the attributes that are used with Amazon Connect Cases.

Attribute	Description	Type	JSONPath Reference	Where the data comes from
Case ID	Unique Identifier of the case in UUID format (for example, 689b0bea-aa29-4340-896d-4ca3ce9b6226)	text	\$.Case.case_id	Amazon Connect
Case Reason	The reason for opening the case	single-select	\$.Case.case_reason	Agent
Customer	The API is a customer profile ID. On the Cases: Fields page, the customer's name is displayed.	text	\$.Case.customer_id	Amazon Connect
Date/Time Closed	The date and time the case was last closed. It does not guarantee that a case is closed. If a case is reopened, this field contains the date/time stamp of the last time the status was changed to closed.	date-time	\$.Case.last_closed_datetime	Amazon Connect

Attribute	Description	Type	JSONPath Reference	Where the data comes from
Date/Time Opened	The date and time the case was opened.	date-time	\$.Case.created_datetime	Amazon Connect
Date/Time Updated	The date and time the case was last updated.	date-time	\$.Case.last_update_datetime	Amazon Connect
Reference number	<p>A friendly number for the case in 8-digit numeric format.</p> <p>Reference numbers (unlike the Case ID) are not guaranteed to be unique. We recommend that you identify the customer and then collect the reference number to correctly find the right case.</p>	text	\$.Case.reference_number	Agent
Status	Current status of the case	text	\$.Case.status	Agent
Summary	Summary of the case	text	\$.Case.summary	Agent
Title	Title of the case	text	\$.Case.title	Agent

Lambda contact attributes

Lambda attributes are returned as key-value pairs from the most recent invocation of an **Invoke AWS Lambda function** block. External attributes are overwritten with each invocation of the Lambda function.

To reference external attributes in JSONPath, use:

- `$.External.attributeName`

where `AttributeName` is the attribute name, or the key of the key-value pair returned from the function.

For example, if the function returns a contact ID, reference the attribute with `$.External.ContactId`. When referencing a contact ID returned from Amazon Connect, the JSONPath is `$.ContactId`.

Note

Note the inclusion of `.External` in the JSONPath reference when the attribute is external to Amazon Connect. Make sure to match the case for attribute names returned from external sources.

For more information about using attributes in Lambda functions, see [Invoke AWS Lambda functions](#).

These attributes are not included in contact records, not passed to the next Lambda invocation, and not passed to the CCP for screenpop information. However, they can be passed as Lambda function inputs on an **Invoke AWS Lambda function** block, or copied to user-defined attributes using the **Set contact attributes** block. When used in **Set contact attributes** blocks, the attributes that are copied are included in contact records, and can be used in the CCP.

User-defined attributes

For all other attributes Amazon Connect defines the key and value. For user-defined attributes, however, you provide a name for the key and the value.

Use user-defined attributes in situations where you want to store values in a contact flow, and then refer to those values later. For example, if you integrate Amazon Connect and a CRM or other

system, you might want to get input from the customer such as their member number. Then you can use that member number retrieve information about the member from the CRM, and/or use the member number throughout the flow, etc.

Attribute	Description	Type	JSONPath Reference
Any name you choose	<p>A user-defined attribute has two parts:</p> <ul style="list-style-type: none"> • Destination key: this is any name you choose for the key. However, the \$ and . (period) characters are not allowed because they are both used in defining the attribute paths in JSONPath. • Value: this is can be any value you choose. You can enter several paragraphs worth of text if you want! (For the Max size of the contact record attributes section, see Amazon Connect feature specifications.) 	User-defined	\$.Attributes.name_of_our_destination_key

To create user-defined attributes, use the [Set contact attributes](#) block.

Flow attributes

Flow attributes are like a type user-defined attribute, however, they are restricted to the flow where they are set.

Flow attributes are useful in situations where you don't want to persist the data throughout the contact, such as when you need to use sensitive information like the customer's credit card number to do a Lambda data dip.

- Flow attributes are temporary variables stored locally and only used in the flow. They aren't visible anywhere outside the flow, not even when the contact is transferred to another flow.
- They can be up to 32 KB (the maximum size of the contact record attributes section).
- They aren't passed to a Lambda unless they are explicitly configured as parameters: in the **Invoke AWS Lambda function** block, choose **Add a parameter**.
- They aren't passed to modules. You can set a flow attribute within a module, but it won't be passed out of the module.
- They don't appear in the contact record.
- They don't appear to the agent in the CCP.
- The `GetContactAttributes` API can't expose them.
- If you have logging enabled on the flow, the key and value appear in the Cloudwatch log.

Attribute	Description	Type	JSONPath Reference
Any name you choose	<p>A flow attribute has two parts:</p> <ul style="list-style-type: none"> • Destination key: this is any name you choose for the key. However, the \$ and . (period) characters are not allowed because they are both used in defining the 	Flow	<code>\$.FlowAttributes.name_of_your_destination_key</code>

Attribute	Description	Type	JSONPath Reference
	attribute paths in JSONPath. <ul style="list-style-type: none"> Value: this can be any value you choose. 		

Apple Messages for Business attributes

Use the following contact attributes to route Apple Messages for Business customers. For example, if you have different lines of business using Apple Messages for Business, you can branch to different flows based on the `AppleBusinessChatGroup` contact attribute. Or, if you want to route Apple Messages for Business messages differently from other chat messages, you can branch based on `MessagingPlatform`.

Attribute	Description	Type	JSON
<code>MessagingPlatform</code>	The messaging platform from where the customer request originated. Exact value: AppleBusinessChat	User-defined	<code>\$.Attributes.MessagingPlatform</code>
<code>AppleBusinessChatCustomerId</code>	The customer's opaque ID provided by Apple. This remains constant for the AppleID and a business. You can use this to identify if the message is from a new customer or a returning customer.	User-defined	<code>\$.Attributes.AppleBusinessChatCustomerId</code>

Attribute	Description	Type	JSON
AppleBusinessChatIntent	You can define the intent or purpose of the chat. This parameter is included in a URL that initiates a chat session in Messages when a customer chooses the Business Chat button.	User-defined	\$.Attributes.AppleBusinessChatIntent
AppleBusinessChatGroup	You define the group which designates the department or individuals best qualified to handle the customer's particular question or problem. This parameter is included in a URL that initiates a chat session in Messages when a customer chooses the Business Chat button.	User-defined	\$.Attributes.AppleBusinessChatGroup

Attribute	Description	Type	JSON
AppleBusinessChatLocale	Defines the language and AWS Region preferences that the user wants to see in their user interface . It consists of a language identifier (ISO 639-1) and a Region identifier (ISO 3166). For example, en_US .	User-defined	\$.Attributes.AppleBusinessChatLocale
AppleFormCapability	Whether the customer device supports forms. If true, the customer device is supported. If false, the device is not supported.	User-defined	\$.Attributes.AppleFormCapability
AppleAuthenticationCapability	Whether the customer device supports Authentication (OAuth2). If true, the customer device is supported. If false, their device is not supported.	User-defined	\$.Attributes.AppleAuthenticationCapability

Attribute	Description	Type	JSON
AppleTimePickerCapability	<p>Whether the customer device supports time pickers.</p> <p>If true, the customer device is supported.</p> <p>If false, the device is not supported.</p>	User-defined	\$.Attributes.AppleTimePickerCapability
AppleListPickerCapability	<p>Whether the customer device supports list pickers.</p> <p>If true, the customer device is supported.</p> <p>If false, the device is not supported.</p>	User-defined	\$.Attributes.AppleListPickerCapability
AppleQuickReplyCapability	<p>Whether the customer device supports quick replies.</p> <p>If true, the customer device is supported.</p> <p>If false, the device is not supported.</p>	User-defined	\$.Attributes.AppleQuickReplyCapability

Customer Profiles attributes

The following table lists the attributes that are used with Amazon Connect Customer Profiles.

The total size of Customer Profiles contact attributes is limited to 14,000 (56 attributes assuming max size of 255 each) characters for the entire flow. This includes all values persisted as **Response** fields in Customer Profiles blocks during the flow.

Attribute	Description	Type	JSONPath Reference
profileSearchKey	The name of the attribute you want to use to search for a profile.	User-defined	Not applicable
profileSearchValue	The value of the key you want to search for, such as customer name or account number.	User-defined	Not applicable
Profile ID	The unique identifier of a customer profile.	text	\$.Customer.ProfileId
Profile ARN	The ARN of a customer profile.	text	\$.Customer.ProfileARN
First Name	The customer's first name.	text	\$.Customer.FirstName
Middle Name	The customer's middle name.	text	\$.Customer.MiddleName
Last Name	The customer's last name.	text	\$.Customer.LastName
Account Number	A unique account number that you have given to the customer.	text	\$.Customer.AccountNumber
Email Address	The customer's email address, which has	text	\$.Customer.EmailAddress

Attribute	Description	Type	JSONPath Reference
	not been specified as a personal or business address.		
Phone Number	The customer's phone number, which has not been specified as a mobile, home, or business number.	text	\$.Customer.PhoneNumber
Additional Information	Any additional information relevant to the customer's profile.	text	\$.Customer.AdditionalInformation
Party Type	The customer's party type.	text	\$.Customer.PartyType
Business Name	The name of the customer's business.	text	\$.Customer.BusinessName
Birth Date	The customer's birth date.	text	\$.Customer.BirthDate
Gender	The customer's gender.	text	\$.Customer.Gender
Mobile Phone Number	The customer's mobile phone number.	text	\$.Customer.MobilePhoneNumber
Home Phone Number	The customer's home phone number.	text	\$.Customer.HomePhoneNumber

Attribute	Description	Type	JSONPath Reference
Business Phone Number	The customer's business phone number.	text	\$.Customer.BusinessPhoneNumber
Business Email Address	The customer's business email address.	text	\$.Customer.BusinessEmailAddress
Address	A generic address associated with the customer that is not mailing, shipping, or billing.	text	\$.Customer.Address1 \$.Customer.Address2 \$.Customer.Address3 \$.Customer.Address4 \$.Customer.City \$.Customer.County \$.Customer.Country \$.Customer.PostalCode \$.Customer.Province \$.Customer.State

Attribute	Description	Type	JSONPath Reference
Shipping Address	The customer's shipping address.	text	<code>\$.Customer.ShippingAddress1</code> <code>\$.Customer.ShippingAddress2</code> <code>\$.Customer.ShippingAddress3</code> <code>\$.Customer.ShippingAddress4</code> <code>\$.Customer.ShippingCity</code> <code>\$.Customer.ShippingCounty</code> <code>\$.Customer.ShippingCountry</code> <code>\$.Customer.ShippingPostalCode</code> <code>\$.Customer.ShippingProvince</code> <code>\$.Customer.ShippingState</code>

Attribute	Description	Type	JSONPath Reference
Mailing Address	The customer's mailing address.	text	<code>\$.Customer.MailingAddress1</code> <code>\$.Customer.MailingAddress2</code> <code>\$.Customer.MailingAddress3</code> <code>\$.Customer.MailingAddress4</code> <code>\$.Customer.MailingCity</code> <code>\$.Customer.MailingCounty</code> <code>\$.Customer.MailingCountry</code> <code>\$.Customer.MailingPostalCode</code> <code>\$.Customer.MailingProvince</code> <code>\$.Customer.MailingState</code>

Attribute	Description	Type	JSONPath Reference
Billing Address	The customer's billing address	text	\$.Customer.BillingAddress1 \$.Customer.BillingAddress2 \$.Customer.BillingAddress3 \$.Customer.BillingAddress4 \$.Customer.BillingCity \$.Customer.BillingCounty \$.Customer.BillingCountry \$.Customer.BillingPostalCode \$.Customer.BillingProvince \$.Customer.BillingState
Attributes	A key value pair of attributes of a customer profile.	text	\$.Customer.Attributes.x
Object Attributes	A key value pair of custom object attributes of a customer profile.	text	\$.Customer.ObjectAttributes.y

Attribute	Description	Type	JSONPath Reference
Calculated Attributes	A key value pair of calculated attributes of a customer profile.	text	\$.Customer.CalculatedAttributes.z

Attribute	Description	Type	JSONPath Reference
Asset	A customer's standard Asset.	text	\$.Customer.Asset.AssetId \$.Customer.Asset.ProfileId \$.Customer.Asset.AssetName \$.Customer.Asset.SerialNumber \$.Customer.Asset.ModelNumber \$.Customer.Asset.ModelName \$.Customer.Asset.ProductSKU \$.Customer.Asset.PurchaseDate \$.Customer.Asset.UsageEndDate \$.Customer.Asset.Status \$.Customer.Asset.Price \$.Customer.Asset.Quantity \$.Customer.Asset.Description

Attribute	Description	Type	JSONPath Reference
			\$.Customer.Asset.AdditionalInformation \$.Customer.Asset.DataSource \$.Customer.Asset.Attributes.x

Attribute	Description	Type	JSONPath Reference
Order	A customer's standard Order.	text	\$.Customer.Order.OrderId \$.Customer.Order.ProfileId \$.Customer.Order.CustomerEmail \$.Customer.Order.CustomerPhone \$.Customer.Order.CreatedDate \$.Customer.Order.UpdatedDate \$.Customer.Order.ProcessedDate \$.Customer.Order.ClosedDate \$.Customer.Order.CancelledDate \$.Customer.Order.CancelReason \$.Customer.Order.Name \$.Customer.Order.AdditionalInformation \$.Customer.Order.Gateway

Attribute	Description	Type	JSONPath Reference
			\$.Customer.Order.Status
			\$.Customer.Order.StatusCode
			\$.Customer.Order.StatusUrl
			\$.Customer.Order.CreditCardNumber
			\$.Customer.Order.CreditCardCompany
			\$.Customer.Order.FulfillmentStatus
			\$.Customer.Order.TotalPrice
			\$.Customer.Order.TotalTax
			\$.Customer.Order.TotalDiscounts
			\$.Customer.Order.TotalItemsPrice
			\$.Customer.Order.TotalShippingPrice
			\$.Customer.Order.TotalTipReceived
			\$.Customer.Order.Currency

Attribute	Description	Type	JSONPath Reference
			\$.Customer.Order.TotalWeight
			\$.Customer.Order.BillingName
			\$.Customer.Order.BillingAddress1
			\$.Customer.Order.BillingAddress2
			\$.Customer.Order.BillingAddress3
			\$.Customer.Order.BillingAddress4
			\$.Customer.Order.BillingCity
			\$.Customer.Order.BillingCounty
			\$.Customer.Order.BillingCountry
			\$.Customer.Order.BillingPostalCode
			\$.Customer.Order.BillingProvince
			\$.Customer.Order.BillingState
			\$.Customer.Order.ShippingName

Attribute	Description	Type	JSONPath Reference
			\$.Customer.Order.ShippingAddress1
			\$.Customer.Order.ShippingAddress2
			\$.Customer.Order.ShippingAddress3
			\$.Customer.Order.ShippingAddress4
			\$.Customer.Order.ShippingCity
			\$.Customer.Order.ShippingCounty
			\$.Customer.Order.ShippingCountry
			\$.Customer.Order.ShippingPostalCode
			\$.Customer.Order.ShippingProvince
			\$.Customer.Order.ShippingState
			\$.Customer.Order.Attributes.y

Attribute	Description	Type	JSONPath Reference
Case	A customer's standard Case.	text	<ul style="list-style-type: none">\$.Customer.Case.CaseId\$.Customer.Case.ProfileId\$.Customer.Case.Title\$.Customer.Case.Summary\$.Customer.Case.Status\$.Customer.Case.Reason\$.Customer.Case.CreatedBy\$.Customer.Case.CreatedDate\$.Customer.Case.UpdatedDate\$.Customer.Case.ClosedDate\$.Customer.Case.AdditionalInformation\$.Customer.Case.DataSource\$.Customer.Case.Attributes.z

Outbound campaign attributes

You can use data in Amazon Pinpoint [segments](#) list to customize experiences in Amazon Connect flows. To reference data in a segment list, use **Attributes_***CoLumnName*. For more information, see [Adding personalized content to message templates](#).

Note

Use `$.Attributes.attributes_`*CoLumnName* to reference these attributes.

How to reference contact attributes

The way you reference contact attributes depends on how they were created and how you are accessing them.

- For the JSON syntax for each attribute, see [List of available contact attributes and their JSONPath reference](#).
- To reference attributes that contain special characters in their name, such as spaces, place brackets and single quotations around the attribute name. For example: `$.Attributes.['user attribute name']`.
- To reference attributes in the same namespace, such as a system attribute, you use the attribute name, or the name you specified as the **Destination key**.
- To reference values in a different namespace, such as referencing an external attribute, you specify the JSONPath syntax to the attribute.
- To use contact attributes to access other resources, set a user-defined attribute in your flow and use the Amazon Resource Name (ARN) of the resource you want to access as the value for the attribute.

Lambda examples

- To reference a customer name from a Lambda function lookup, use `$.External.AttributeKey`, replacing `AttributeKey` with the key (or name) of the attribute returned from the Lambda function.
- To use an Amazon Connect prompt in a Lambda function, set a user-defined attribute to the ARN for the prompt, and then access that attribute from the Lambda function.

Amazon Lex examples

- To reference an attribute from an Amazon Lex bot, you use the format \$.Lex. and then include the part of the Amazon Lex bot to reference, such as \$.Lex.IntentName.
- To reference the customer input to an Amazon Lex bot slot, use \$.Lex.Slots.slotName, replacing slotName with the name of the slot in the bot.

Set contact attribute example

Use a [Set contact attributes](#) block to set a value that is later referenced in a flow. For example, create a personalized greeting for customers routed to a queue based on the type of customer account. You could also define an attribute for a company name or line of business to include in the text to speech strings said to a customer. The **Set contact attributes** block is useful for copying attributes retrieved from external sources to user-defined attributes.

To set a contact attribute with a [Set contact attributes](#) block

1. In Amazon Connect, choose **Routing, Contact flows**.
2. Select an existing flow, or create a new one.
3. Add a **Set contact attributes** block.
4. Edit the **Set contact attributes** block, and choose **Use text**.
5. For the **Destination key**, provide a name for the attribute, such as *Company*. This is the value you use for the **Attribute** field when using or referencing attributes in other blocks. For the **Value**, use your company name.

You can also choose to use an existing attribute as the basis for creating the new attribute.

Display contact information to the agent in the CCP

You can use contact attributes to capture information about the contact and then present it to the agent through the Contact Control Panel (CCP). For example, you might want to do this to customize the agent experience when using the CCP integrated with a customer relationship management (CRM) application.

Also use them when integrating Amazon Connect with a custom application using the Amazon Connect Streams API or Amazon Connect API. You can use all user-defined attributes, in addition

to the customer number and the dialed number, in the CCP using the Amazon Connect Streams JavaScript library. For more information, see [Amazon Connect Streams API](#) or Amazon Connect API.

When you use the Amazon Connect Streams API, you can access user-defined attributes by invoking `contact.getAttributes()`. You can access endpoints using `contact.getConnections()`, where a connection has a `getEndpoint()` invocation on it.

To access the attribute directly from a Lambda function, use `$.External.AttributeName`. If the attribute is stored to a user-defined attribute from a **Set contact attributes** block, use `$.Attributes.AttributeName`.

For example, included with your Amazon Connect instance, there is a flow named "Sample note for screenpop." In this flow, a **Set contact attributes** block is used to create an attribute from a text string. The text, as an attribute, can be passed to the CCP to display a note to an agent.

Route based on number of contacts in a queue

Amazon Connect includes queue attributes that can help you define routing conditions in your flows based on real-time metrics about the queues and agents in your contact center. For example, here are some common usage scenarios:

- Check the number of contacts or available agents in a queue, and how long the oldest contact has been in a queue, then route accordingly.
- To route to the queue with the fewest contacts in it:
 1. Get metrics for multiple queues.
 2. Use a **Set contact attributes** block to store the metric attributes for each queue.
 3. compare queue metric attributes using a **Check contact attributes** block, and route the contact to the queue with the fewest calls in it, or to a callback if all queues are busy.

Using a Check contact attributes block to route a contact to a queue

1. In Amazon Connect, choose **Routing, Contact flows**.
2. Open an existing flow or create a new one.
3. Optionally, under **Interact**, add a **Play prompt** block to the designer to play a greeting to your customers. Add a connector between the **Entry point** block and the **Play prompt** block.
4. Under **Set**, drag a **Get queue metrics** block to the designer, and connect the **Okay** branch of the **Play prompt** block to it.

5. Choose the title of the **Get queue metrics** block to open the properties for the block. By default, the block retrieves metrics for the current working queue. To retrieve metrics for a different queue, choose **Set queue**.
6. Choose **Select a queue**, then select the queue to retrieve metrics for from the drop-down, then choose **Save**.

You can also determine which queue to retrieve metrics for using contact attributes.

7. Under **Check**, drag a **Check contact attributes** block to the designer.
8. Choose the title of the block to display the settings for the block. Then, under **Attribute to check**, select **Queue metrics** in the **Type** drop-down menu.
9. Under **Attribute**, choose **Contacts in queue**.
10. To use conditions to route the contact, choose **Add another condition**.

By default, the **Check contact attributes** block includes a single condition, **No match**. The **No match** branch is followed when there are no matches for any of the conditions you define in the block.

11. Under **Conditions to check**, select **Is less than** as the operator for the condition in the drop-down menu, then in the value field enter 5.
12. Choose **Add another condition**, then choose **Is greater or equal** from the drop-down menu, and enter 5 in the value field.
13. Choose **Save**.

You now see two new output branches for the **Check contact attributes** block.

You can now add additional blocks to the flow to route the contact as desired. For example, connect the < 5 branch to a **Transfer to queue** block to transfer calls to the queue when there are fewer than five calls currently in the queue. Connect the > 5 branch to a **Set customer callback number** block and then transfer the call to a callback queue using a **Transfer to queue** block so the customer doesn't have to stay on hold.

Route contacts based on queue metrics

Many contact centers route customers based on the number of contacts waiting in a queue. This topic explains how to configure a flow that looks similar to the following image. It shows the following three flow blocks connected by Success branches: **Set contact attributes**, **Get queue metrics**, and **Check contact attributes**.

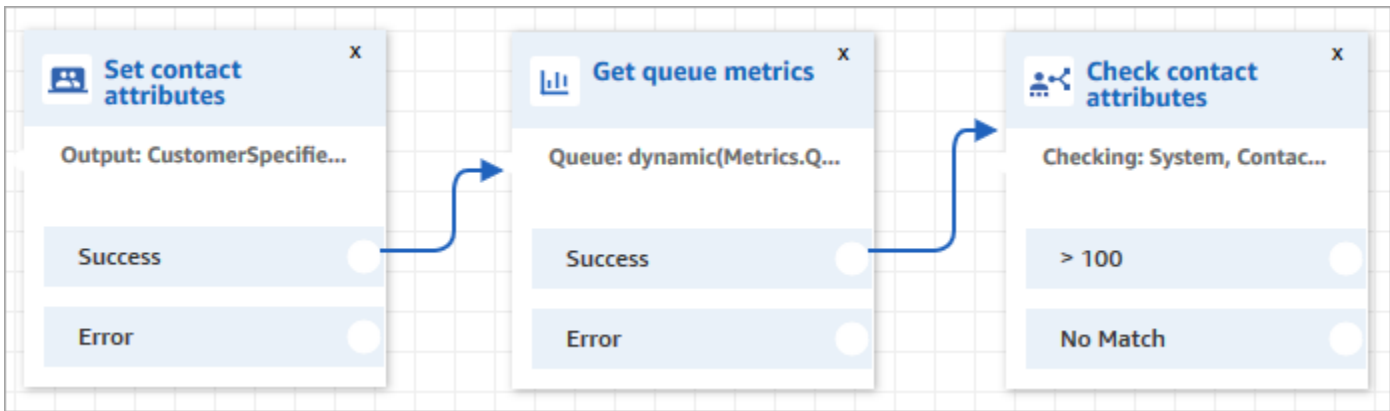

1. Add a [Set contact attributes](#) block to your flow.
2. In the [Set contact attributes](#), specify the channel. If you set a channel dynamically using text, for the attribute value enter **Voice** or **Chat**, as shown in the following image. This value is not case-sensitive.

Set contact attributes

Define and store key-value pairs as contact attributes. [Info](#)

i Contact attributes are accessible by other areas of Amazon Connect, such as the Contact Control Panel (CCP) and Contact Trace Records (CTRs).

Namespace: User defined

Attribute: CustomerSpecified

Set manually

Value: chat

Set dynamically

[Add another attribute](#)

3. Add a [Get queue metrics](#) block to your flow.

In the [Get queue metrics](#) block, dynamic attributes can only return metrics for one channel

Add a [Check contact attributes](#) block after the [Get queue metrics](#) block

After a [Get queue metrics](#) block, add a [Check contact attributes](#) block to branch based on the returned metrics. Use the following steps:

1. After **Get queue metrics**, add a **Check contact attributes** block.
2. In the **Check contact attributes** block, set **Attribute to check** to **Queue metrics**.
3. In the **Attributes to check** dropdown box, you'll see that the following queue metrics are returned by the **Get queue metrics** block. Choose the metric that you want to use for the routing decision.

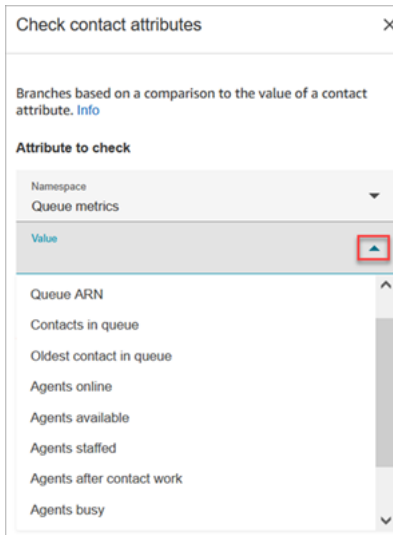

4. Choose **Add a condition** to enter the comparison for your routing decision. The following image shows the block configured to check whether contacts in queue is greater than 5.

The screenshot shows the 'Check contact attributes' configuration window with the 'Conditions to check' section. The 'Attribute to check' is 'Queue metrics' and the 'Attribute' is 'Contacts in queue'. The condition is set to 'Is greater than' with a value of 5. There is a 'No Match' button and an 'Add another condition' link.

Route based on contact's channel

You can personalize the customer's experience based on the channel that they use to contact you. Here's what you do:

1. Add a **Check contact attributes** block to the beginning of your flow.
2. Configure the block as shown in the following image. In the **Attribute to check** section, set **Type** to **System**, set **Attribute** to **Channel**. In the **Conditions to check** section, set it to **Equals CHAT**.

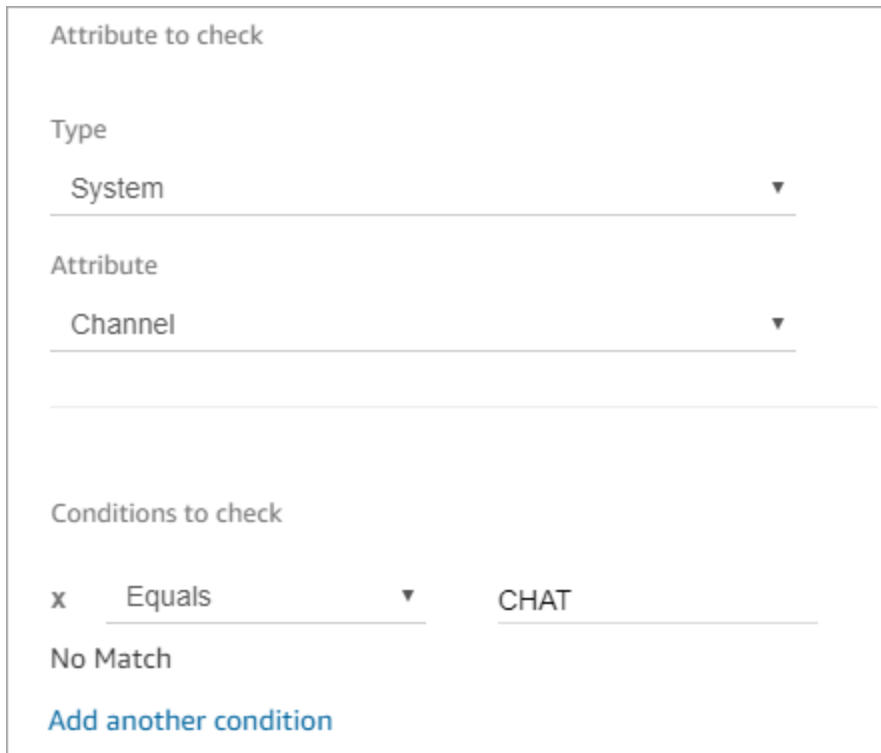

The image shows the configuration interface for the 'Check contact attributes' block. It is divided into two main sections: 'Attribute to check' and 'Conditions to check'.

Attribute to check

- Type:** A dropdown menu with 'System' selected.
- Attribute:** A dropdown menu with 'Channel' selected.

Conditions to check

- A condition is added with the operator 'Equals' and the value 'CHAT'.
- The 'No Match' option is visible below the condition.
- A link 'Add another condition' is present at the bottom.

3. The following image of the configured Check contact attributes block shows two branches: **CHAT** and **No Match**. If the customer is contacting you through chat, specify what should happen next. If the customer is contacting you through a call (No Match), specify the next step in the flow.

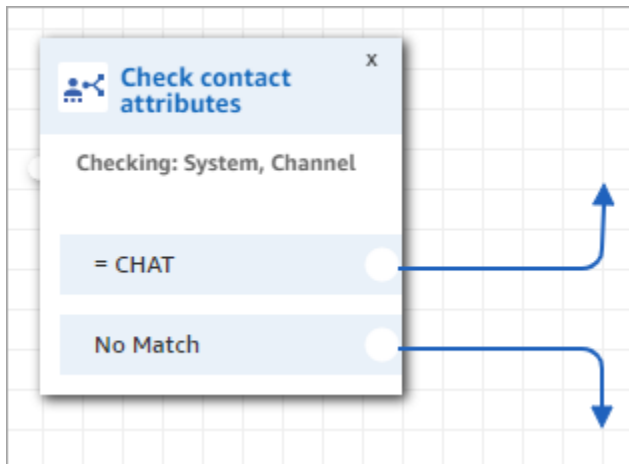

Use Amazon Lex and attributes

When you reference attributes in a **Get customer input** block, and choose Amazon Lex as the method of collecting the input, the attribute values are retrieved and stored from the output from the customer interaction with the Amazon Lex bot. You can use an attribute for each intent or slot used in the Amazon Lex bot, as well as the sessions attributes associated with the bot. An output branch is added to the block for each intent you include. When a customer chooses an intent when interacting with the bot, the branch associated with that intent is followed in the flow.

For a list of Amazon Lex attributes you can use and receive back from the Lex bot, see [Amazon Lex contact attributes](#).

Using an Amazon Lex bot to get customer input

1. Open an existing or create a new flow.
2. Under **Interact**, drag a **Get customer input** block to the designer.
3. Choose the title of the block to display the block settings, then select **Text to speech (Ad hoc)**.
4. Choose **Enter text**, then enter text in the **Enter text to be spoken** field that is used as a message or greeting to your customers. For example, "Thank you for calling" followed by a request to enter information to fulfill the intents you defined in your Amazon Lex bot.
5. Choose the **Amazon Lex** tab, then from the drop-down menu, choose the Amazon Lex bot to use to get customer input.
6. By default, the **Alias** field is populated with \$LATEST. To use a different alias of the bot, enter the alias value to use.

⚠ Important

In a production environment, always use a different alias than **TestBotAlias** for Amazon Lex and **\$LATEST** for Amazon Lex classic. **TestBotAlias** and **\$LATEST** support a limited number of concurrent calls to an Amazon Lex bot. For more information, see [Runtime quotas](#) or [Runtime Service Quotas \(Amazon Lex Classic\)](#).

7. Optionally, to pass an attribute to Amazon Lex to use as a session attribute, choose **Add an attribute**. Specify the value to pass using either text or an attribute.
8. To create a branch from the block based on the customer intent, choose **Add an intent**, then enter the name of the intent exactly the same as the intent name in your bot.
9. Choose **Save**.

How to use Lex alternate intent attributes

Usually you configure flows to branch on the winning Lex intent. However, in some situations, you might want to branch on an alternate intent. That is, what the customer might have meant.

The following image shows the **Properties** page of the **Check contact attributes** block. It is configured to check a Lex attribute.

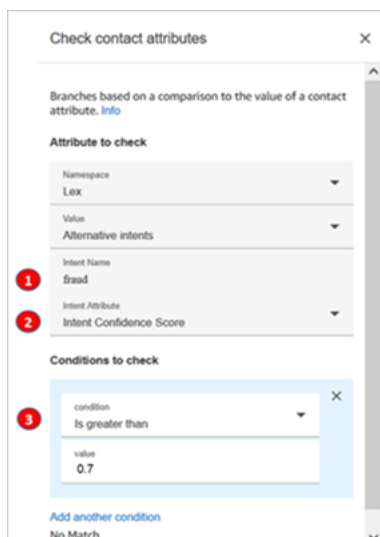

1. **Intent name** is the name of an alternate intent in Lex. It's case sensitive and must match what's in Lex exactly.

2. **Intent Attribute** is what Amazon Connect is going to check. In this example, it's going to check the **Intent Confidence Score**.
3. **Conditions to check:** If Lex is 70% certain the customer meant the alternate intent instead of the winning intent, branch.

How flow blocks use Lex session attributes

When a customer starts a conversation with your bot, Amazon Lex creates a *session*. With *session attributes*, also known as *Lex attributes*, you can pass information between the bot and Amazon Connect during the session. For a list of Amazon Lex attributes that you can use, see [Amazon Lex contact attributes](#).

Life cycle of session attributes

Each conversation contains one set of session attributes. In cases where an AWS Lambda function is invoked to do some processing, Amazon Lex runs the attributes in the following order:

- Service defaults: These attributes are only used if no attributes are defined.
- Session attributes provided by Amazon Connect: These attributes are defined in the [Get customer input](#) block.
- Session attributes provided by Lambda override everything prior: When an AWS Lambda function is invoked and it does some processing, it overrides any session attributes set in the [Get customer input](#) block.

Let's say a customer utters that they want a **car**. That's the first session attribute to go through processing. When asked what kind of car, they say **luxury car**. This second utterance overrides any Lambda processing that took place on the first utterance.

For an example of how to create a Lambda function that processes session attributes, see [Step 1: Create a Lambda Function](#) in the *Amazon Lex Developer Guide*. For information about Amazon Lex V2, see [Setting session attributes](#).

For the structure of the event data that Amazon Lex provides to a Lambda function, see [Lambda Function Input Event and Response Format](#) in the *Amazon Lex Developer Guide*. For information about Amazon Lex V2, see [Interpreting the input event format](#).

Flow blocks that support Lex session attributes

You can use Lex session attributes in the following flow blocks when a Lex bot is called:

- [Change routing priority/age](#)
- [Check contact attributes](#)
- [Get customer input](#)
- [Invoke AWS Lambda function](#)
- [Loop](#)
- [Set callback number](#)
- [Set contact attributes](#)
- [Set customer queue flow](#)
- [Set disconnect flow](#)
- [Set hold flow](#)
- [Set logging behavior](#)
- [Set whisper flow](#)
- [Set working queue](#)
- [Transfer to flow](#)
- [Transfer to phone number](#)
- [Wait](#)

More information

For more information about using Amazon Lex session attributes, see [Managing Conversation Context](#) in the *Amazon Amazon Lex V1 Developer Guide*.

How to use the same bot for voice and chat

You can use the same bot for voice and chat. However, you may want the bot to respond differently based on the channel. For example, you want to return SSML for voice so a number is read as a phone number, but you want to return normal text to chat. You can do this by passing the **Channel** attribute.

1. In the **Get customer input** block, choose the **Amazon Lex** tab.
2. Under **Session attributes**, choose **Add an attribute**. In the **Destination key** box, enter **phoneNumber**. Choose **Set dynamically**. In the **Namespace** box, choose **System**, and in the **Value** box, choose **Customer Number**, as shown in the following image.

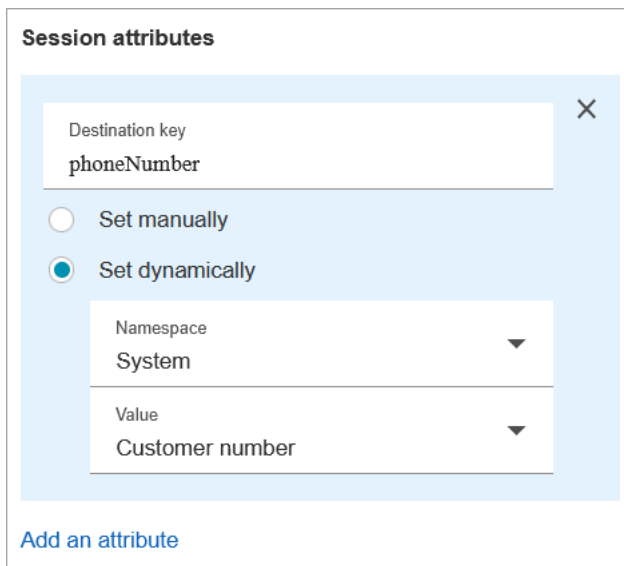

The screenshot shows a dialog box titled "Session attributes" with a close button (X) in the top right corner. Inside the dialog, there is a text input field labeled "Destination key" containing the text "phoneNumber". Below this field are two radio buttons: "Set manually" (which is unselected) and "Set dynamically" (which is selected). Underneath the radio buttons are two dropdown menus. The first dropdown menu is labeled "Namespace" and has "System" selected. The second dropdown menu is labeled "Value" and has "Customer number" selected. At the bottom left of the dialog, there is a blue link that says "Add an attribute".

3. Choose **Add an attribute** again.
4. Choose **Set dynamically**. In the **Destination key** box, enter **callType**. In the **Namespace** box, choose **System**, and in the **Value** box choose **Channel**, as shown in the following image.

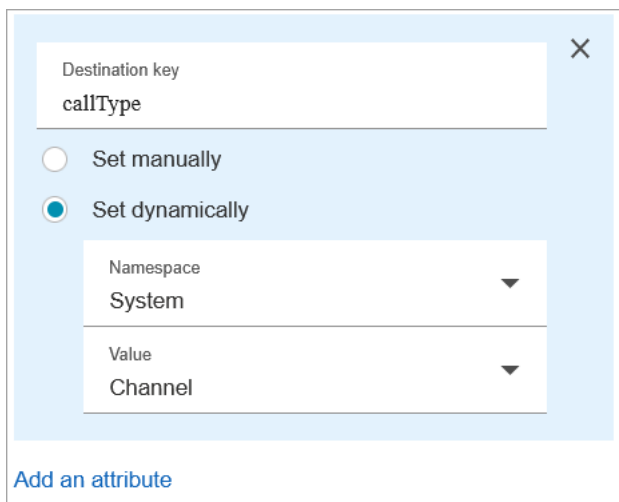

The screenshot shows a dialog box titled "Session attributes" with a close button (X) in the top right corner. Inside the dialog, there is a text input field labeled "Destination key" containing the text "callType". Below this field are two radio buttons: "Set manually" (which is unselected) and "Set dynamically" (which is selected). Underneath the radio buttons are two dropdown menus. The first dropdown menu is labeled "Namespace" and has "System" selected. The second dropdown menu is labeled "Value" and has "Channel" selected. At the bottom left of the dialog, there is a blue link that says "Add an attribute".

5. Choose **Save**.
6. In your Lambda function, you can access this value in the `SessionAttributes` field in the incoming event.

Lambda functions and attributes

Retrieve data from a system that your organization uses internally, such as an ordering system or other database with a Lambda function, and store the values as attributes that can then be referenced in a flow.

The Lambda function returns a response from your internal system in the form of key-value pairs of data. You can reference the values returned in the External namespace. For example, `$.External.attributeName`. To use the attributes later in a flow, you can copy the key-value pairs to user-defined attributes by using a **Set contact attributes** block. You can then define logic to branch your contact based on attribute values by using a **Check contact attributes** block. Any contact attribute retrieved from a Lambda function is overwritten when you invoke any other Lambda function. Make sure you store external attributes if you want to reference them later in a flow.

To store an external value from a Lambda function as a contact attribute

1. In Amazon Connect, choose **Routing, Contact flows**.
2. Select an existing flow, or create a new one.
3. Add an **Invoke AWS Lambda function** block, then choose the title of the block to open the settings for the block.
4. Add the **Function ARN** to your AWS Lambda function that retrieves customer data from your internal system.
5. After the **Invoke AWS Lambda function** block, add a **Set contact attributes** block and connect the **Success** branch of the **Invoke AWS Lambda function** block to it.
6. Edit the **Set contact attributes** block, and select **Use attribute**.
7. For **Destination key**, type a name to use as a reference to the attribute, such as `customerName`. This is the value you use in the **Attribute** field in other blocks to reference this attribute.
8. For **Type**, choose **External**.
9. For **Attribute**, enter the name of the attribute returned from the Lambda function. The name of the attribute returned from the function will vary depending on your internal system and the function you use.

After this block executes during a flow, the value is saved as a user-defined attribute with the name specified by the **Destination key**, in this case `customerName`. It can be accessed in any block that uses dynamic attributes.

To branch your flow based on the value of an external attribute, such as an account number, use a **Check contact attributes** block, and then add a condition to compare the value of the attribute to. Next, branch the flow based on the condition.

1. In the **Check contact attributes** block, for **Attribute to check** do one of the following:
 - Select **External** for the **Type**, then enter the key name returned from the Lambda function in the **Attribute** field.

⚠ Important

Any attribute returned from an AWS Lambda function is overwritten when you invoke any other Lambda function.. To reference the attributes later in a flow, store them as user-defined attributes.

- Select **User Defined** for the **Type**, and in the **Attribute** field, type the name that you specified as the **Destination key** in the **Set contact attributes** block.
2. Choose **Add another condition**.
 3. Under **Conditions to check**, choose the operator for the condition, then enter a value to compare to the attribute value. The block creates a branch for each comparison you enter, letting you route the contact based on the conditions specified. If no condition is matched, the contact takes the **No Match** branch from the block.

Migrate flows to a different instance

Amazon Connect lets you efficiently migrate flows to another instance. For example, you might want to expand into new Regions, or move flows from your development environment to your production environment.

To migrate a few flows, use the [import/export feature](#) in the flow designer.

To migrate hundreds of flows, you need developer skills. You use the following procedure:

1. Source instance
 - [ListContactFlow](#): Retrieve the Amazon Resource Number (ARN) for the flows that you want to migrate.
 - [DescribeContactFlow](#): Get information about each flow that you want to migrate.
2. Destination instance
 - [CreateContactFlow](#): Create the flows.
 - [UpdateContactFlowContent](#): Update the flow content.

You must also build an ARN-to-ARN mapping for queues, flows, and prompts between the source and target Amazon Connect instances, and replace every ARN in the source flow with the corresponding ARN from the target instance. Otherwise `UpdateContactFlowContent` fails with `InvalidContactFlow` error.

You can update the information in the flows that you migrate. For more information, see [Flow language](#) in the *Amazon Connect API Reference Guide*.

Real-time and historical metrics, dashboards, and reports

In Amazon Connect, data about contacts are captured in contact records. This data can include the amount of time a contact spends in each state: customer on hold, customer in queue, agent interaction time.

The basis for most historical and real-time metrics in Amazon Connect is the data in the contact record. When you create metrics reports, the values displayed for **most** (not all) metrics in the report are calculated using the data in the contact records.

Contact records are available within your instance for 24 months from the time when the associated contact was initiated. You can also stream contact records to Amazon Kinesis to retain the data longer, and perform advanced analysis on it.

Tip

For detailed information about the activity of agents in your contact center, use [Amazon Connect agent event streams](#).

Contents

- [Dashboards: View performance insights](#)
- [Real-time metrics reports](#)
- [Historical metrics reports](#)
- [Login/Logout reports](#)
- [Amazon Connect agent event streams](#)
- [Amazon Connect contact events](#)
- [Contact records data model](#)
- [View a contact record in the UI](#)
- [About agent status](#)
- [About contact states](#)
- [About queued callbacks in metrics](#)
- [Save custom reports](#)
- [Share custom reports](#)
- [View a shared report](#)

- [Publish reports](#)
- [Manage saved reports \(admin\)](#)
- [Monitoring your instance using CloudWatch](#)
- [Logging Amazon Connect API calls with AWS CloudTrail](#)
- [EventBridge events emitted by Amazon Connect](#)
- [Analytics data lake](#)

Dashboards: View performance insights

Understanding your contact center at the most granular level is key to improving performance and lowering costs. You can use the Amazon Connect visual dashboards to understand the performance of your contact center.

Amazon Connect dashboards show real-time and historical metrics information and insights about your contact center performance.

- Real-time dashboards are updated every 15 seconds
- You can select historical data up to 3 months in the past.

You can customize the dashboards (for example, re-size and re-arrange the visuals), specify a custom time range and custom benchmark comparison time range for each dashboard, and select filters for data to include for each report. You can also download the entire data set or individual widgets as CSV, download the dashboard as a PDF, save your own version to your saved dashboards, share with individuals, and publish to the entire instance.

Topics

- [Get started](#)
- [Save, download, and share your dashboard](#)
- [Use the required filters](#)
- [Contact Lens conversational analytics dashboard](#)
- [Flows performance dashboard](#)
- [Outbound campaigns performance dashboard](#)
- [Queue performance dashboard](#)
- [Assign security profile permissions for dashboards](#)

Get started

1. Ensure users are assigned the appropriate security profile permissions:
 - **Access metrics - Access permission** or the **Dashboard - Access permission**. For information about the difference in behavior, see [Assign security profile permissions for dashboards](#).
 - Viewing the data on each dashboard requires the appropriate permissions. For example, to view flows data, you need **Flows - View** permissions. See the topics about each dashboard for the specific permissions.
2. In the Amazon Connect admin website, navigate to **Analytics and Optimization, Dashboards and reports**. Choose the Amazon Connect dashboard you want to view.

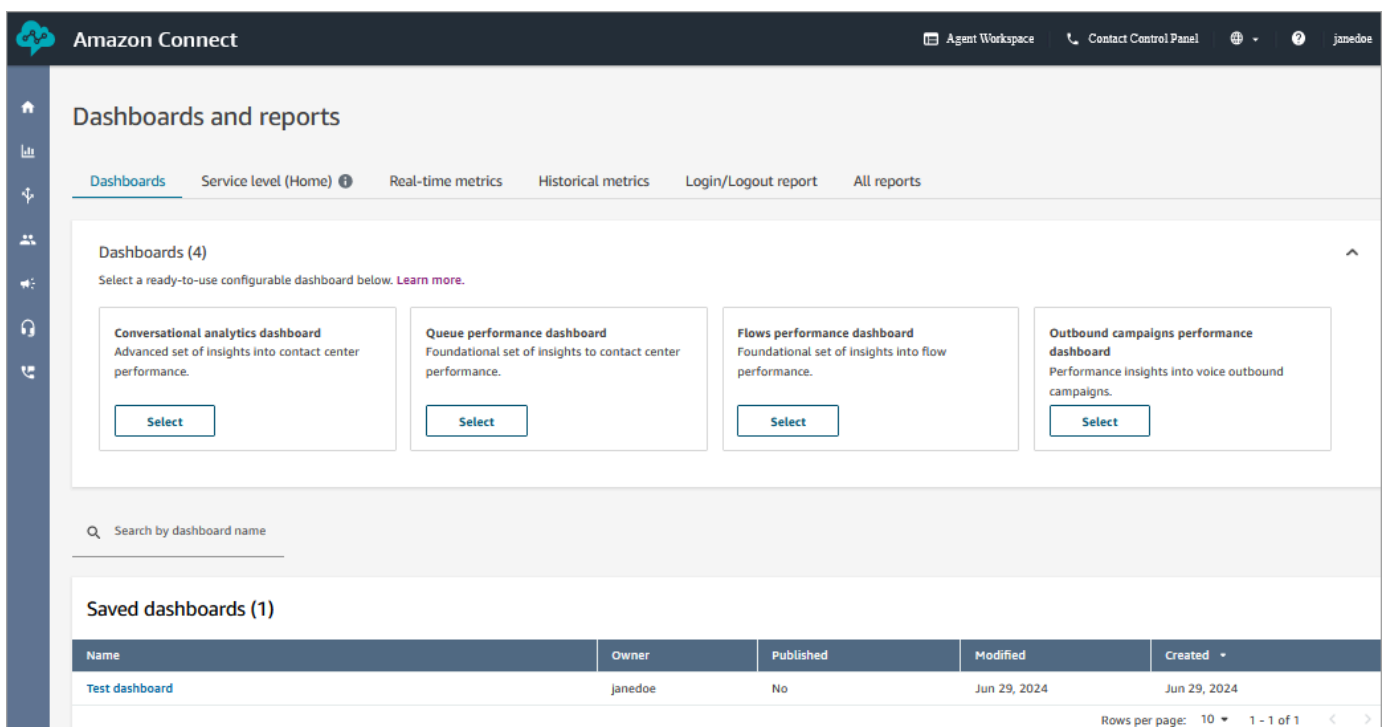

3. You can customize the dashboard and then choose **Save as** to save it with a new name. It appears in the **Saved dashboards** section.

Save, download, and share your dashboard

Use the following actions on your dashboards to save, download, and share them.

1. Save: You can save your dashboard and change your dashboard name by choosing **Actions > Save** and typing a new name and choosing **Save**. Your saved dashboard appears in your **Saved dashboards** in the **Dashboards and reports** page, the **Dashboards** tab.

2. **Save as:** You can re-name and save your dashboard by choosing **Actions > Save as** and typing a new name and choosing save. Your saved dashboard appears in your **Saved dashboards** in the **Dashboards and reports** page, the **Dashboards** tab.
3. **Download CSV:** You can download the entire dashboard data set to CSV by choosing **Actions > Download CSV**. You can also download each widget's data set individually by choosing the download arrow button in the top right of each widget.
4. **Download PDF:** You can download the entire dashboard as a PDF by choosing **Actions > Download PDF**.
5. **Share:** You can share and publish the dashboard like other Amazon Connect reports by choosing **Actions > Share**. For more information about sharing and publishing, see [Share reports](#), [View shared reports](#), and [Publishing reports](#).

Other actions: You can move charts around by choosing and holding the top left corner icon with your mouse and moving. You can re-size widgets by choosing and dragging the bottom right icon with your mouse.

Category	Contacts %	Contacts	AHT	Avg. queue answ...	Contacts transfe...
LoadTestChatSe...	100%	7,302	00:17:15	00:00:23	8,035
LoadTestChatPat...	100%	7,302	00:17:15	00:00:23	8,035
LoadTestChatSe...	100%	7,302	00:17:15	00:00:23	8,035
LoadTestChatHel...	100%	7,302	00:17:15	00:00:23	8,035
LoadTestChatQu...	9%	641	00:17:22	00:00:21	642

Use the required filters

All dashboards have the following required filters:

1. Time range: You can select a real-time time range within the "Time range: Today" option and choose a trailing window of time. For additional windows, select "Custom." You can select historical time ranges by altering your Time range to "Day," "Week," or "Month."
2. "Compare to" benchmark time range: You can customize a comparison time period to benchmark your Time range selection against, such as an exact week over week comparison called "Compare to: Prior week same day, time range, and time." This benchmark time range powers the benchmarking in all of the widgets in the dashboard. Your benchmark time range must be a date in the past compared to your time range.

Each dashboard has additional filters specific to that feature. For example, the following image of the Contact Lens conversational analytics dashboard shows the available filters. **Contact category** is specific to Contact Lens.

The screenshot displays the Amazon Connect interface for the Conversational analytics dashboard. The top navigation bar includes the Amazon Connect logo, "Agent Workspace", "Contact Control Panel", and the user's IAM role "IAM@d-9267286abd". The dashboard title is "Conversational analytics dashboard" with a breadcrumb "Dashboards and reports > Conversational analytics dashboard". The last update time is "Nov 13, 2023, 8:26:46 AM".

The main content area features a "Performance overview" section with the following data:

Metric	Value	Change
Contacts handled	184,258	↓ 12% 209,774
Avg. handle time	00:13:38	↑ 00:02:15 00:15:53
Avg. queue answer time	00:01:21	↑ 00:06:45 00:08:07
Contacts t	369	↓ 5% 38

At the top of the dashboard, there are filter controls: "Time range: Today" (with options for 15m, 30m, 2h, 8h, and Custom), "Compare to: Prior week same day, time range, and time", and an "Add filter" dropdown menu. The "Add filter" menu is open, showing the following options: Contact Category, Agent, Queue, Channel, Routing Profile, and Agent Hierarchy.

Contact Lens conversational analytics dashboard

With Amazon Connect Contact Lens, you can analyze conversations between customers and agents by using speech and chat transcriptions, natural language processing, and intelligent search capabilities. Amazon Connect Contact Lens performs sentiment analysis, detects issues, and enables you to automatically categorize contacts. For more information, see [Amazon Connect Contact Lens](#).

The Contact Lens conversation analytics dashboard helps you understand:

- why customers are contacting your contact center
- the trends of contact drivers over time
- the performance of each of those call drivers (for example, average handle time for call driver "Where's my stuff?")

You can view key metrics for categories such as contacts handled and average handle time compared to a custom-defined benchmark time-range with color indicators (for example, green = good, red = bad) for quick insights within seconds (for example, "Am I performing better or worse than last week and by how much?") using the summary widgets at the top.

Data visualizations such as **Movers and shakers** display the largest changes compared to a custom-defined benchmark time period in the past (that is, week over week). while **Contacts handled and average handle time trend** shows you the number of contacts handled alongside the average handle time over a period of intervals in time in a time series chart.

Contents

- [Enable access to the dashboard](#)
- [Performance overview charts](#)
- [Contact categories](#)
- [Movers and shakers](#)
- [Top contact categories average handle time](#)
- [Contact count by queue](#)
- [Contacts handled and average handle time trend](#)
- [Dashboard functionality limitations](#)

Enable access to the dashboard

1. Ensure users are assigned the appropriate security profile permissions:
 - **Access metrics - Access permission** or the **Dashboard - Access permission**. For information about the difference in behavior, see [Assign security profile permissions for dashboards](#).
 - **Contact Lens - conversational analytics**: This permission enables users to view data in the Contact Lens dashboard.

2. In the AWS console, ensure that **Analytics tools, Enable Contact Lens** is selected, as shown in the following image.

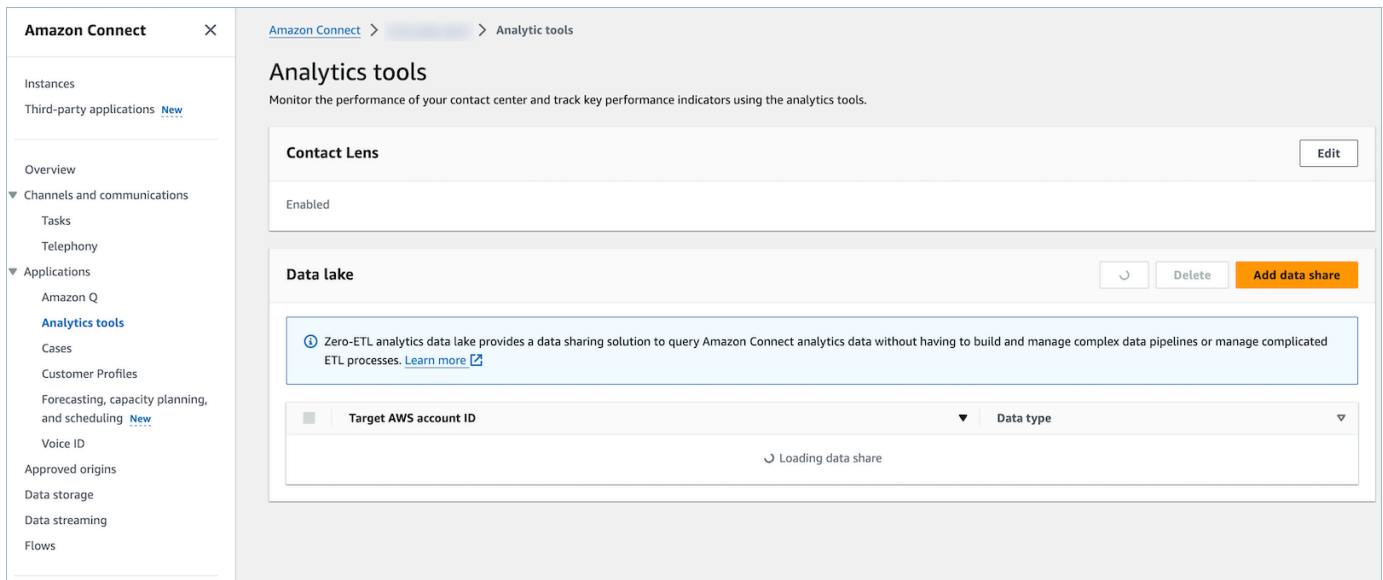

3. In your flow, enable Contact Lens conversational analytics so it analyzes your contacts. For instructions, see [Enable Amazon Connect Contact Lens](#).

Performance overview charts

There are two performance overview charts that provide aggregated metrics based on your filters. The second chart is further filtered only by contacts analyzed by Contact Lens conversational analytics. Each metric within the charts is compared to your "compare to" benchmark time range filter. For example, Contacts handled during your time range selection was 165,522, which is down ~12% compared to your benchmark number of contacts handled, 187,949 contacts. The percentages are rounded up or down. The colors that appear for the metrics indicate positive (green) or negative (red) compared to your benchmark. There are no colors for contacts handled.

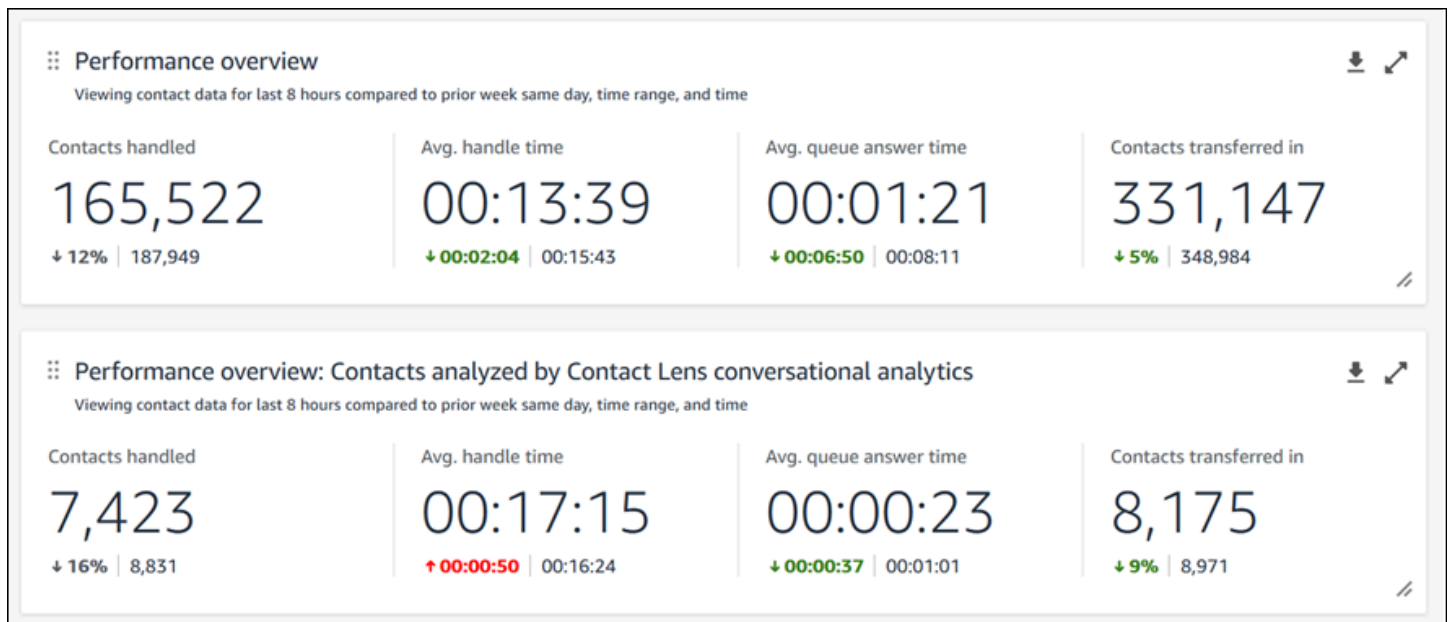





Contact categories

The contact categories chart shows you Contact Category information. To see all data, click on the pop-out icon in the top right of the chart. To deep dive further into the contacts, click on the Contact Category and it will take you to Contact Search pre-filtered for that category along with the dashboard filters.

1. **Contacts %:** the count of contacts analyzed by Contact Lens conversational analytics that have a given category divided by the total number of contacts analyzed by Contact Lens conversational analytics.
2. **Contacts:** count of contacts analyzed by Contact Lens conversational analytics that have a given category.
3. **AHT:** the average handle time for the contacts that have a given category.
4. **Avg. queue answer time:** the average queue answer time for the contacts that have a given category.
5. **Contacts transferred in:** the count of contacts transferred in for the contacts that have a given category.

☰ Contact categories ⬇️ ↗️

Category	Contacts %	▼ Contacts	AHT	Avg. queue answ...	Contacts transfe...
LoadTestChatSe...	100% 	7,302	00:17:15	00:00:23	8,035
LoadTestChatPat...	100% 	7,302	00:17:15	00:00:23	8,035
LoadTestChatSe...	100% 	7,302	00:17:15	00:00:23	8,035
LoadTestChatHel...	100% 	7,302	00:17:15	00:00:23	8,035
LoadTestChatQu...	9% 	641	00:17:22	00:00:21	642

Movers and shakers

The movers and shakers chart shows you the categories with the highest percent change in distribution compared to your benchmark time range. In other words, it shows you the count of categories that were generated more or less frequently compared to the total number of contacts analyzed by Contact Lens conversational analytics. For example, if 20 out of 100 contacts analyzed by Contact Lens have Category A, your contacts % for Category A was 20%. If during the comparison benchmark time period 10 out of 100 contacts analyzed by Contact Lens conversational analytics had Category A, your Prior contacts % for Category A was 10%. The % Change would be $(20\% - 10\%) / (10\%) = 100\%$. To see all data, click on the pop-out icon in the top right of the chart. To deep dive further into the contacts, click on the Contact Category and it will take you to Contact Search pre-filtered for that category along with the dashboard filters.

1. Change %: $(\text{Contacts \%} - \text{Prior contacts \%}) / (\text{Prior contacts \%})$. This number is rounded. The chart is sorted by highest absolute Change %.
2. Contacts %: the count of contacts analyzed by Contact Lens conversational analytics in the time range specified in your dashboard filter that have a given category divided by the total number of contacts analyzed by Contact Lens conversational analytics.
3. Contacts: the count of contacts analyzed by Contact Lens conversational analytics in the time range specified in your dashboard filter.
4. Prior contacts %: the count of contacts analyzed by Contact Lens conversational analytics in the "compare to" benchmark time range specified in your dashboard filter that have a given category divided by the total number of contacts analyzed by Contact Lens conversational analytics.
5. Prior contacts: the count of contacts analyzed by Contact Lens conversational analytics in the "compare to" benchmark time range specified in your dashboard filter.

☰ Top 5 movers and shakers ⌵ ↗

Category	Change %	Contacts %	Contacts	Prior contacts %	Prior contacts
LoadTestChatQu...	4%	9%	618	8%	708
LoadTestChatHel...	0%	100%	7,060	100%	8,372
LoadTestChatSe...	0%	100%	7,060	100%	8,373
LoadTestChatPat...	0%	100%	7,060	100%	8,373
LoadTestChatSe...	0%	100%	7,060	100%	8,373

✍

Top contact categories average handle time

The top contact categories average handle time displays the prior AHT (using the "compare to" benchmark time range) to the current time range AHT for each of your top 10 categories (sorted by count of contacts with a category from left to right). To see all data, click on the pop-out icon in the top right of the chart.

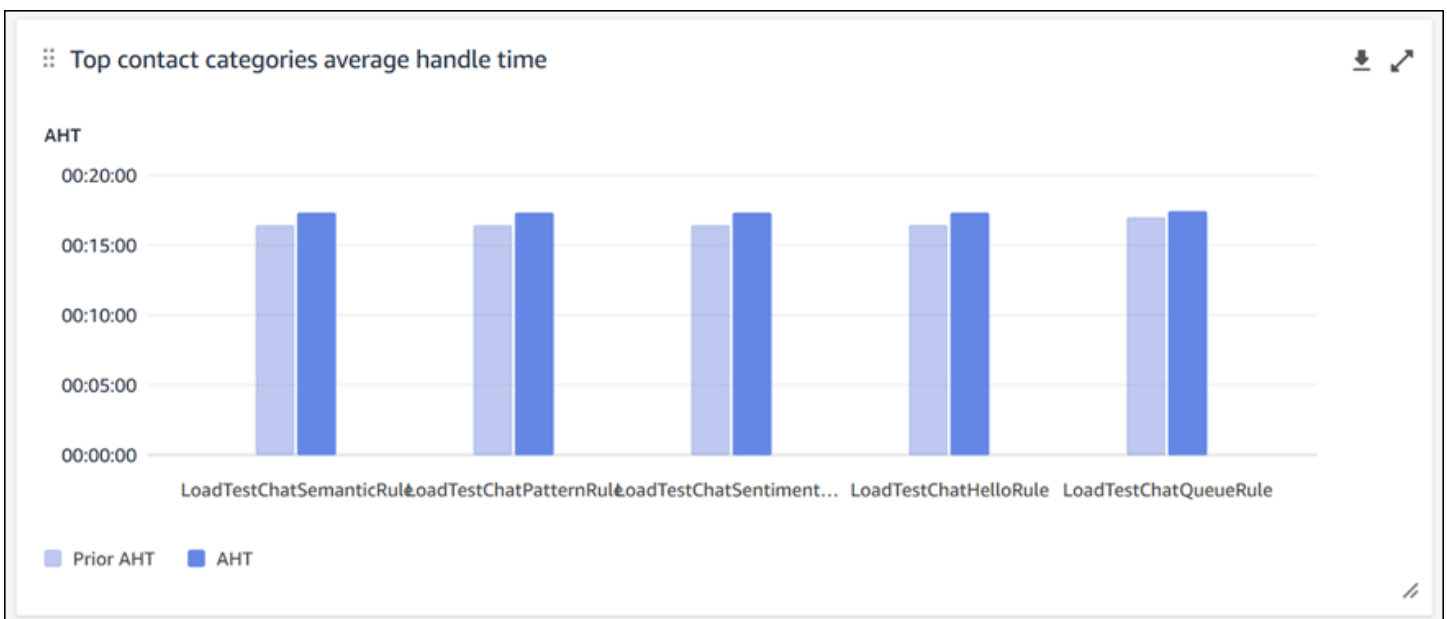

Contact count by queue

The contact count by queue chart displays the count of contacts for each queue, sorted by the highest number of contacts from left to right. You can configure this widget further by filtering for contact categories directly from this chart. This filter will override the page-level contact category filter at the top of the dashboard.

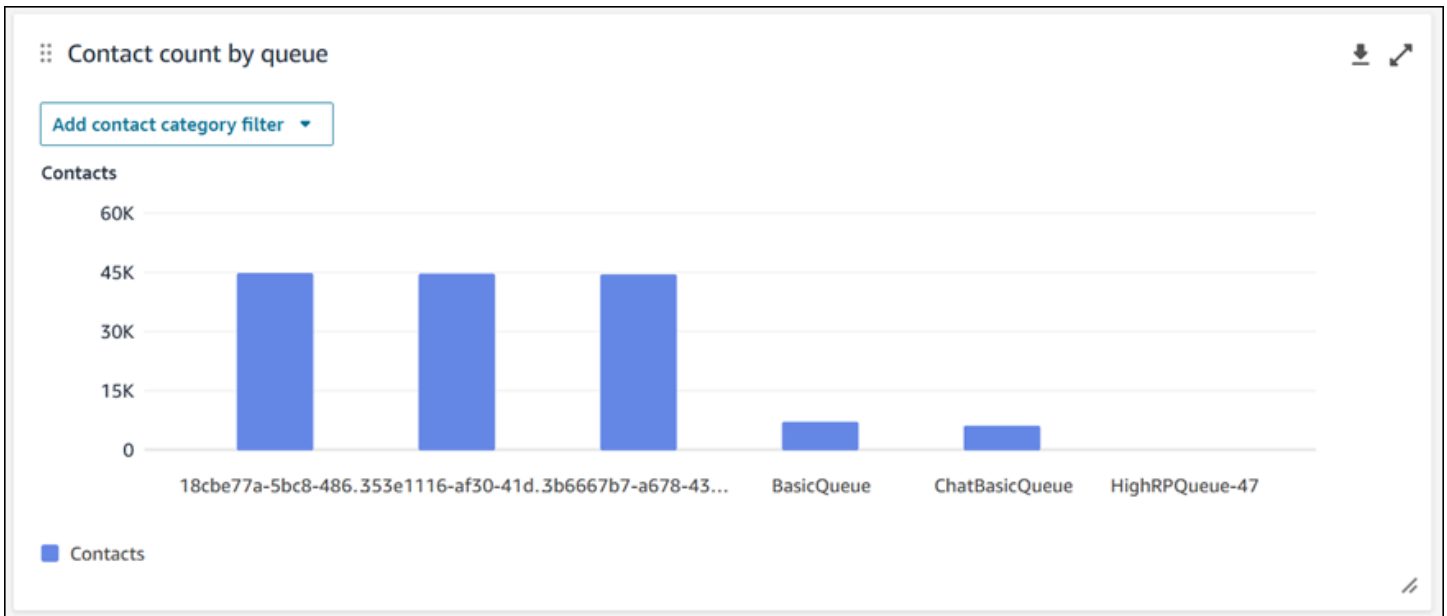

Contacts handled and average handle time trend

The Contacts handled and average handle time trend is a time-series chart that displays the count of contacts handled (blue bars) and the average handle time (red line) over a given time period broken down by intervals (15min, daily, weekly, monthly). You can configure different time range intervals by using the "Interval" button directly in the widget. The intervals that you may select depend on the page-level time range filter. For example, if you have a "Today" time range filter at the top of your dashboard, you can only see an interval of 15min for the last 24 hours. If you have a "Day" time range filter at the top of your dashboard, you can see a trailing 8 day interval trend, or a 15min interval trend for the trailing 24 hours.

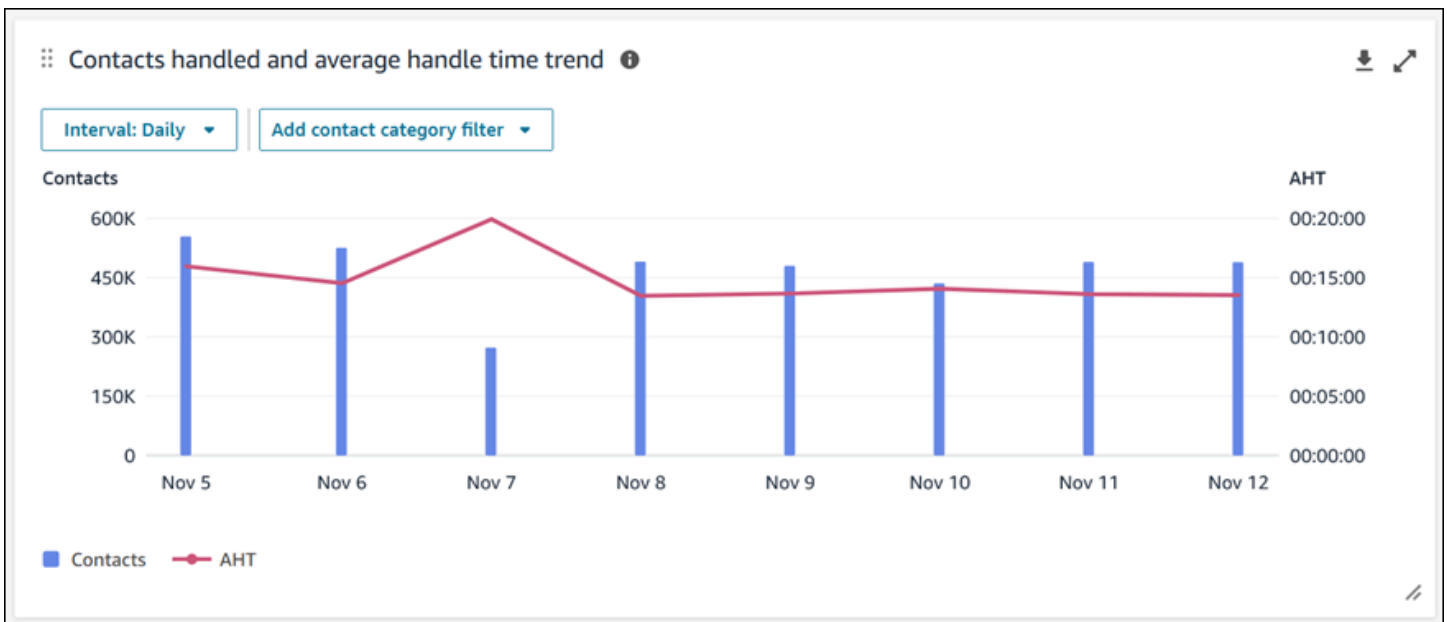

Dashboard functionality limitations

The following limitations apply to the Contact Lens conversational analytics dashboard:

- Tag-based access controls are not supported on the dashboard.
- If you have a routing profile or agent hierarchy filter selected, the hyperlinks on contact categories leading to contact search will be disabled within the Contact categories and Movers and Shakers charts.

Flows performance dashboard

The flows performance dashboard helps you understand the performance of your flows and flow modules or groups of flows and flow modules compared over configurable periods of time using key metrics such as flows started, contacts dropped, and average flow duration.

Contents

- [Enable access to the dashboard](#)
- [Performance overview chart](#)
- [Comparison to prior period charts](#)
- [Flow outcomes over time comparison chart](#)
- [Flow duration over time comparison chart](#)
- [Flow and flow module overview tables](#)
- [Dashboard functionality limitations](#)

Enable access to the dashboard

Ensure users are assigned the appropriate security profile permissions:

- **Access metrics - Access permission** or the **Dashboard - Access permission**. For information about the difference in behavior, see [Assign security profile permissions for dashboards](#).
- **Flows and Flow modules - View** permissions: These permissions are required to see data in your dashboard.

Performance overview chart

The performance overview chart provides aggregated metrics based on your filters. Each metric within the charts is compared to your "compare to" benchmark time range filter. For example, Flows started during your time range selection was 200,000 which is down 15% compared to your benchmark number of Flows started, 235,000. The percentages are rounded up or down. The colors that appear for the dropped in flow metric indicate negative (red) compared to your benchmark.

Metrics include:

- **Flows started:** The count of flows that started execution within the specified start time and end time.
- **Transferred from flow to queue or agent:** The count of flows that started execution within the specified start time and end time and ended with a contact transferring from the flow to a queue or agent.
- **Dropped in flow:** The count of flows that started execution within the specified start time and end time and ended with a contact dropping from the flow prior to the flow reaching a terminal block.
- **Disconnected in flow:** The count of flows that started execution within the specified start time and end time and ended with a contact reaching a disconnect terminal block
- **Avg duration – transferred to queue:** The average flow duration for the specified start time and end time of selected flows where the flow outcome is transferred to queue.
- **Avg duration – disconnected:** The average flow duration for the specified start time and end time of selected flows where the flow outcome is disconnected participant.

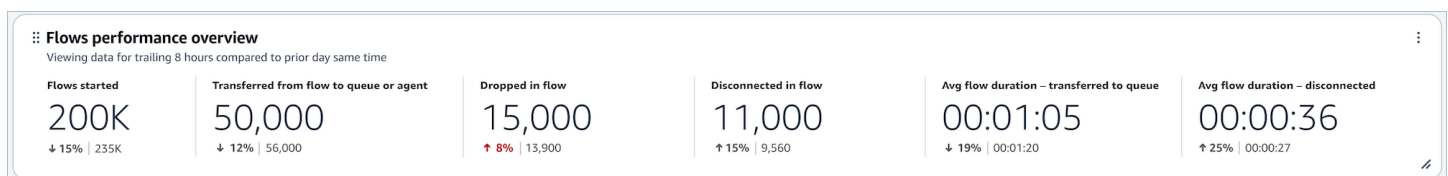

Comparison to prior period charts

The top flows by dropped in flow count, dropped in flow rate, transferred to queue or agent count, and transferred to queue or agent rate display the current period metric and the "Compare to" period metric for the top ten flows sorted (from highest to lowest) by the current period metric.

These charts allow you to identify the flows contributing most to overall dropped or transferred contacts. To see all data, choose the pop-out icon in the top right of the chart.

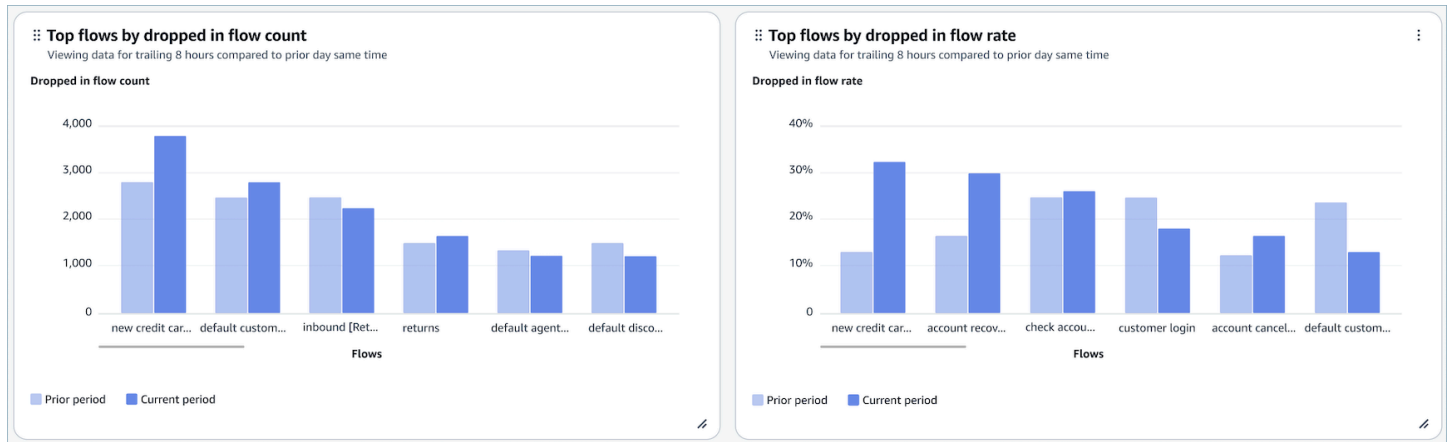

Flow outcomes over time comparison chart

The Flow outcomes over time comparison chart is a time-series chart that displays the breakdown of Flow outcome rate metrics for a single flow or multiple flows over a given time period and broken down by intervals (15min, daily, weekly, monthly).

You can configure different time range intervals by using the "Interval" button directly in the widget. The intervals that you can select depend on the page-level time range filter. For example:

- If you have a "Today" time range filter at the top of your dashboard, you can only see an interval of 15min for the last 24 hours.
- If you have a "Day" time range filter at the top of your dashboard, you can see a trailing 8 day interval trend, or a 15min interval trend for the trailing 24 hours.



Flow duration over time comparison chart

The Flow duration over time comparison chart is a time-series chart that displays the breakdown of Flow duration metrics for a single flow or multiple flows over a given time period and broken down by intervals (15min, daily, weekly, monthly).

You can configure different time range intervals by using the "Interval" button directly in the widget. The intervals that you select depend on the page-level time range filter.

For example:

- If you have a "Today" time range filter at the top of your dashboard, you can only see an interval of 15min for the last 24 hours.
- If you have a "Day" time range filter at the top of your dashboard, you can see a trailing 8 day interval trend, or a 15min interval trend for the trailing 24 hours.

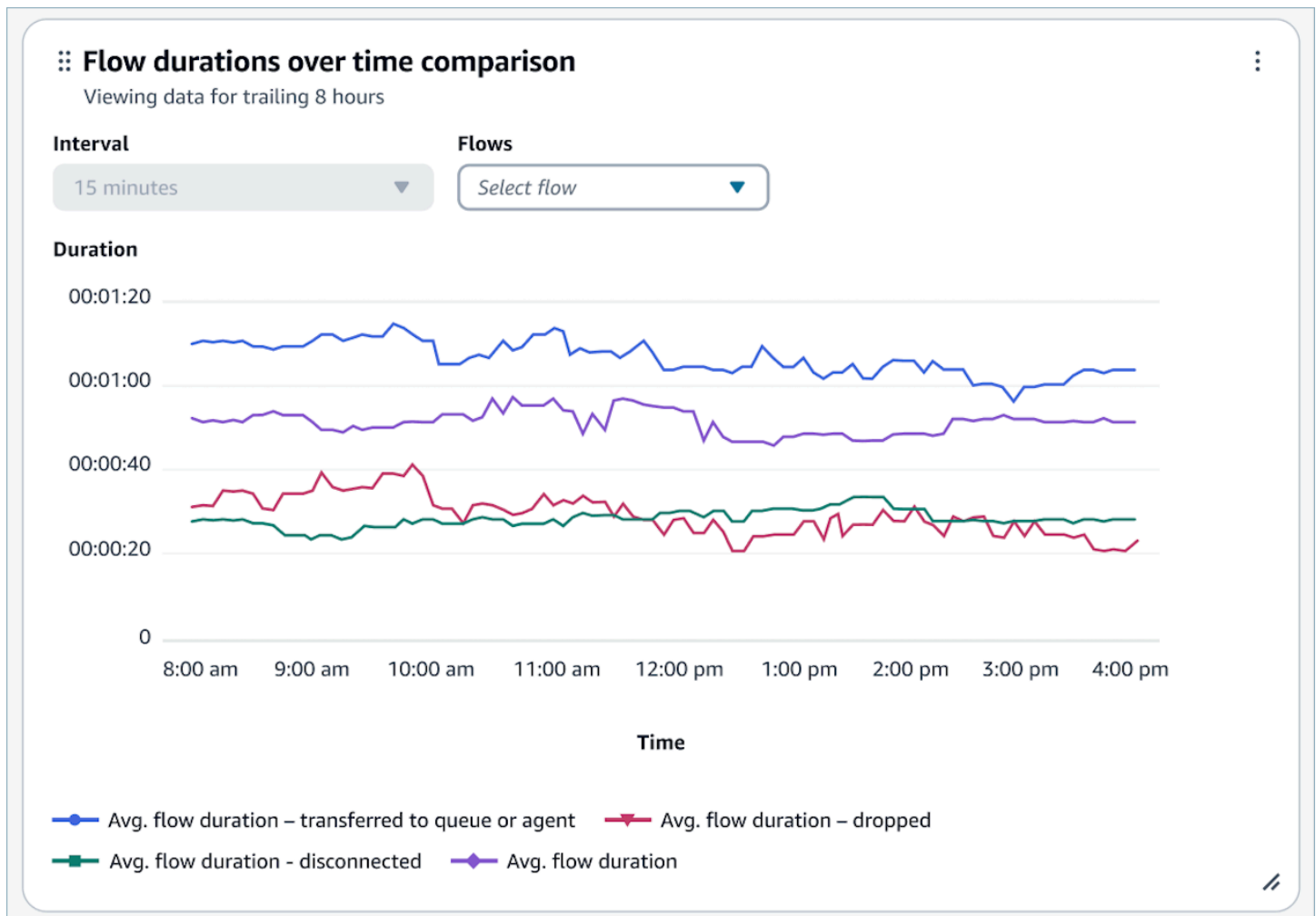

Flow and flow module overview tables

Snapshot flow and flow module metrics table aggregated over the selected time range.

Metrics include:

- **Flow / flow module starts:** The count of flows that started execution within the specified start time and end time. For a given start and end time it will show the count of those flows whose start time is between the start and end interval specified.
- **Flow outcomes:** The count of flows that started execution within the specified start time and end time and ended with a specified mutually exclusive and exhaustive flow outcome.
- **Avg Flow Durations by outcome:** The average flow duration for the specified start time and end time with a specified mutually exclusive and exhaustive flow outcome.

Flows
Viewing data for trailing 8 hours

Flows

Select flow

Flow name	Flow starts	Dropped	Disconnected participant	Ended flow execution	Transferred to queue	Transferred to agent	Transferred to phone	Transferred to flow	Avg.
new credit card r...	40,000	3,929	1,200	0	8,741	0	0	26,130	0C
account recovery...	27,500	1,134	492	0	1,845	0	0	24,029	0C
check account...	18,432	956	2,119	0	7,232	0	0	8,125	0C
login	17,556	899	510	0	322	0	0	15,825	0C
account cancel...	16,512	538	679	0	8,407	0	0	6,888	0C

Flow modules
Viewing data for trailing 8 hours

Flow modules

Select flow module

Flow module name	Flow starts	Dropped	Disconnected participant	Ended flow execution	Transferred to queue	Transferred to agent	Transferred to phone	Returned to flow	Avg.
customer authen...	30,240	3,931	5,443	0	6,653	0	0	14,213	00:0
send confirmatio...	22,004	2,861	3,961	0	4,841	0	0	10,342	00:0
customer registr...	8,181	1,064	1,473	0	1,800	0	0	3,845	00:0
new welcome m...	5,877	764	1,058	0	1,293	0	0	2,762	00:0
account update	4,694	610	845	0	1,033	0	0	2,206	00:0

Dashboard functionality limitations

The following limitations apply to the Flows performance dashboard:

- Tag-based access controls are not currently supported by the dashboard. You can restrict access through the Dashboard permissions pertaining to a security profile.
- No support for metrics on flows that are type Customer hold and Agent hold. For customer hold metrics, see [Historical metrics definitions](#).

Outbound campaigns performance dashboard

You use the outbound campaigns performance dashboard to understand the performance of your outbound campaigns across voice contacts. You can view and compare voice campaigns performance over a configurable period of time using key metrics such as dials attempted, human answered rate, and campaign contact abandoned rate.

Contents

- [Enable access to the dashboard](#)
- [Campaign performance overview chart](#)
- [Campaign progress over time chart](#)

- [Campaign delivery breakdown chart](#)
- [Call classification stacked bar chart](#)
- [Campaign metrics table](#)
- [Dashboard functionality limitations](#)

Enable access to the dashboard

Ensure users are assigned the appropriate security profile permissions:

- **Access metrics - Access permission** or the **Dashboard - Access permission**. For information about the difference in behavior, see [Assign security profile permissions for dashboards](#).
- **Outbound Campaign - Campaigns - View** permission: This permission is required to view outbound campaigns data on the dashboard.

Campaign performance overview chart

The Campaign performance overview chart provides aggregated metrics based on your filters. Each metric within the chart is compared to your "compare to" benchmark time range filter.

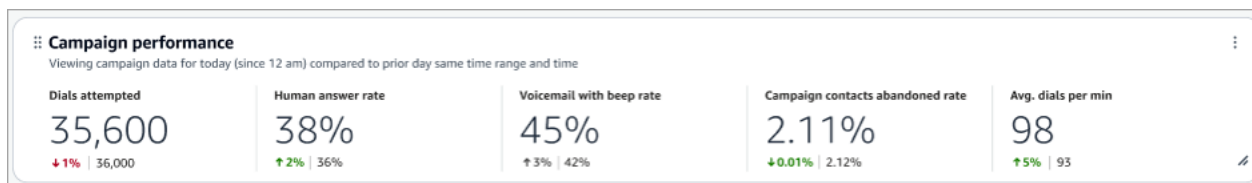

This chart shows the following information:

- Dials attempted during your time range selection was 35,600 which is down 1% compared to your benchmark of Prior day same time range and time with 36,000.
- The percentages are rounded up or down.
- The colors that appear for the metrics indicate positive (green) or negative (red) compared to your benchmark.

The chart includes the following metrics:

- **Dials attempted:** The count of outbound voice campaign contacts dialed by the Amazon Connect voice dialer within the selected time range filter.

- **Human answered:** The percentage of outbound voice campaign contacts dialed by the Amazon Connect voice dialer that were answered by a human. This metric is only available with answering machine detection enabled.
- **Voicemail with beep rate:** The count of outbound voice campaign contacts that were answered by a voicemail with a beep divided by total Dials attempted. This metric is only available with answering machine detection enabled.
- **Campaign contacts abandoned after 2 seconds rate:** The percentage of outbound voice campaign contacts that were connected to a human but did not get connected to an agent within 2 seconds, divided by the count of human answered outbound voice campaign contacts dialed by the Amazon Connect voice dialer. This metric is only available with answering machine detection enabled.
- **Avg. dials per minute:** The average of outbound voice campaign contacts dialed per minute by the Amazon Connect voice dialer within the selected time range filter.

Note

By default, data for deleted campaigns won't appear in the dashboard. The Performance overview chart includes data from deleted campaigns when there is no campaign filter selected. You can apply a campaign filter to filter out deleted campaign data.

Campaign progress over time chart

The Campaign progress chart is a time-series chart that displays the Dials attempted metric per campaign over a specific time period broken down by intervals (15min, daily, weekly, monthly).

To configure different time range intervals, choose **Interval**, as shown in the following image.

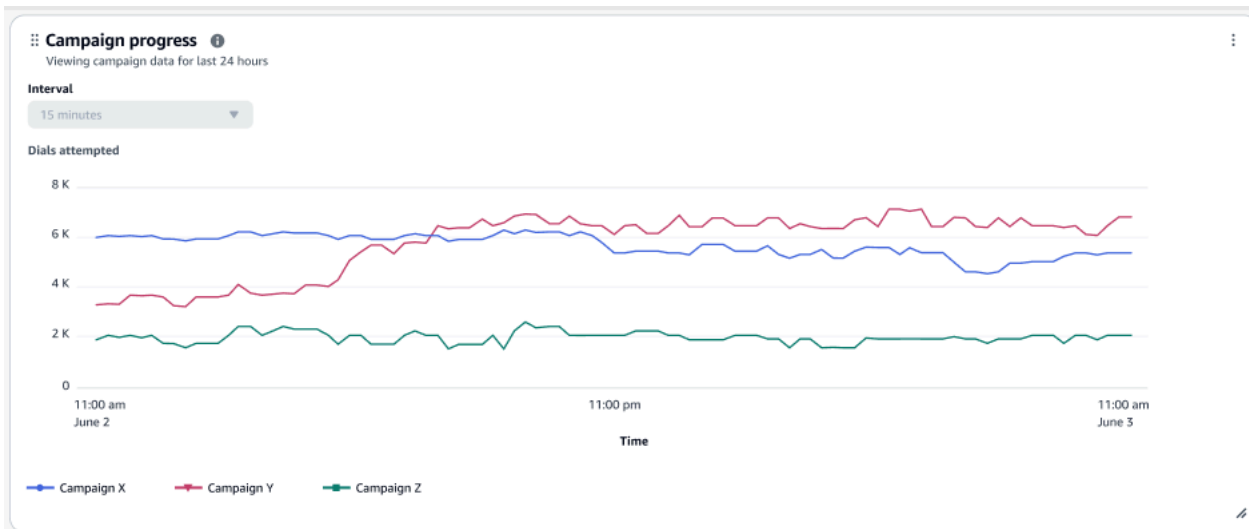

The available intervals depend on the page-level time range filter at the top of the page. For example:

- If you have a **Trailing** time range filter at the top of your dashboard, you can only see an interval of 15min for the last 24 hours.
- If you have a **Day** time range filter at the top of your dashboard, you can see a trailing 8 day interval trend, or a 15min interval trend for the trailing 24 hours.

This widget holds up to 5 campaigns sorted in alphabetical order. If you are filtering for more than 5 campaigns, additional campaigns will not display in the visualization. You can select specific campaign(s) you want to see in this visual by using the campaign filter.

Campaign delivery breakdown chart

The Campaign delivery breakdown chart shows the Dials attempted metric in its current period broken down by campaign, compared to the Prior dials attempted metric from the "compare to" benchmark time range selected.

This chart is sorted by Dials attempted in descending order from left to right. This widget holds up to 10 campaigns. If you are filtering for more than 10 campaigns, additional campaigns will not display in the visualization. You can select specific campaign(s) you want to see in this visual by using the campaign filter.

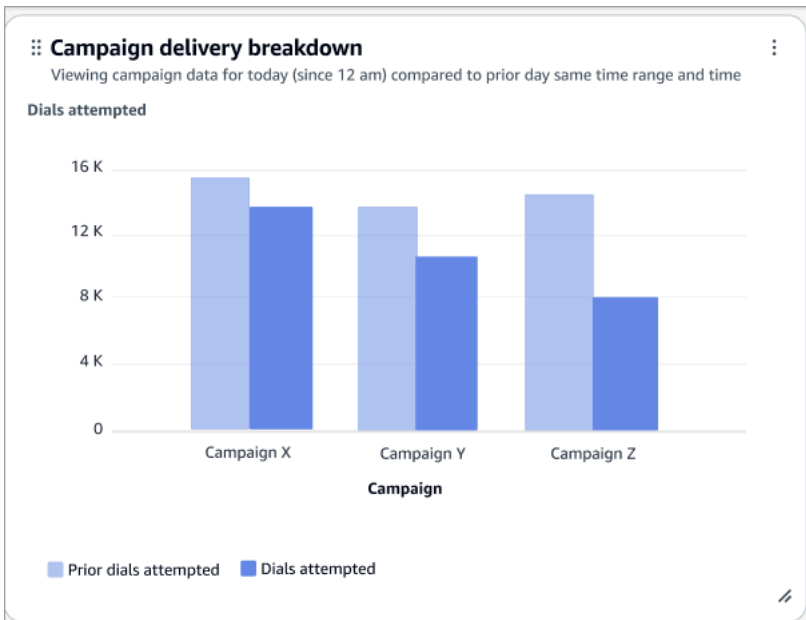

Call classification stacked bar chart

The Call classification by campaign chart drills down to the call outcomes of each dial attempted. This chart is most effective with answering machine detection enabled.

This chart shows the count of each call classification across a campaign. The classifications displayed can include the following AMD (Answering Machine Detection) statuses: Human answered, Voicemail with beep, Voicemail with no beep, AMD unanswered, AMD unresolved, AMD not applicable, with any remaining classifications grouped under Other.

For the full list of available call classifications, see DisconnectReason for outbound campaigns and AnsweringMachineDetectionStatus under [ContactTraceRecord](#).

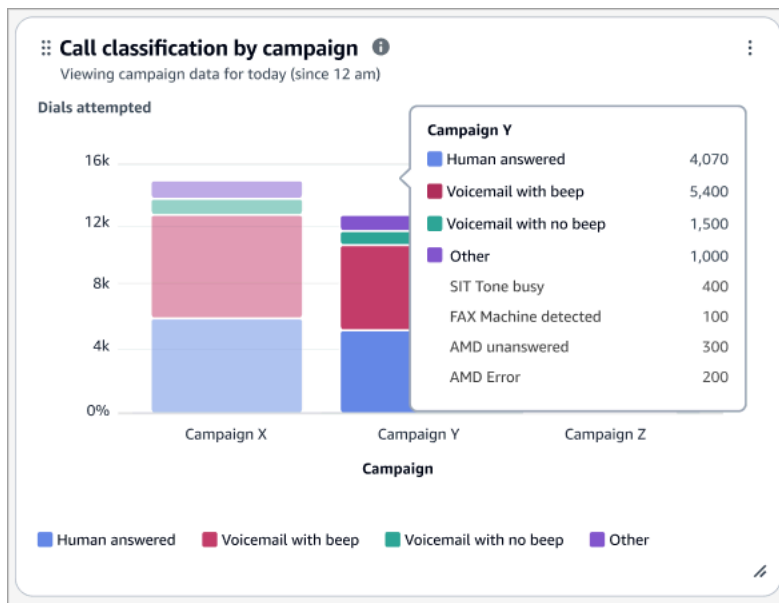

Campaign metrics table

A detailed view of outbound campaigns metrics aggregated over the selected time range.

Campaign metrics ⓘ
Viewing campaign data for today (since 12 am)

Campaign name ▲	Dials attempted ▼	Human answered ▼	Voicemail with beep ▼	Voicemail with no beep ▼	Campaign contacts abandoned ▼	Avg. dials per min ▼
Campaign X	11,000	4,070	5,400	1,500	30	23
Campaign Y	12,000	4,510	6,900	500	90	25
Campaign Z	12,600	4,950	6,300	1,300	50	26

This table includes the following metrics.

- **Dials attempted:** The count of outbound voice campaign contacts dialed by the Amazon Connect voice dialer broken down across each campaign(s).
- **Human answered:** The count of outbound voice campaign contacts that were answered by a human. This metric is only available with answering machine detection enabled.
- **Voicemail with beep:** The count of outbound voice campaign contacts that reached a voicemail with beep. This metric is only available with answering machine detection enabled.
- **Voicemail with no beep:** The count of outbound voice campaign contacts that reached a voicemail with no beep. This metric is only available with answering machine detection enabled.
- **Campaign contacts abandoned after 2 seconds:** The count of outbound voice campaign contacts that were connected to a human but did not get connected to an agent within 2 seconds. This metric is only available with answering machine detection enabled.

- **Avg. dials per minute:** The average of outbound voice campaign contacts dialed per minute by the Amazon Connect voice dialer within the selected time range filter.

Dashboard functionality limitations

The following limitations apply to the Outbound campaigns performance dashboard:

- Tag-based access controls are not currently supported by the dashboard. You can restrict access through the Dashboard permissions pertaining to a security profile.
- Data for this dashboard is available starting from June 25, 2024 0:00:00 GMT. This may impact dashboard functionalities such as monthly benchmarks where data won't be available prior to June 25, 2024 0:00:00 GMT for comparison.

Queue performance dashboard

The queue performance dashboard helps you understand the performance of your queues or groups of queues compared over configurable periods of time using key metrics such as contacts handled, service level, and average handle time.

Contents

- [Enable access to the dashboard](#)
- [Performance overview chart](#)
- [Contacts handled and average handle time trend](#)
- [Dashboard functionality limitations](#)

Enable access to the dashboard

Ensure users are assigned the appropriate security profile permissions:

- **Access metrics - Access permission** or the **Dashboard - Access permission**. For information about the difference in behavior, see [Assign security profile permissions for dashboards](#).

Performance overview chart

The performance overview chart that provides aggregated metrics based on your filters. Each metric within the chart is compared to your "compare to" benchmark time range filter.

The following image shows an example performance overview chart:

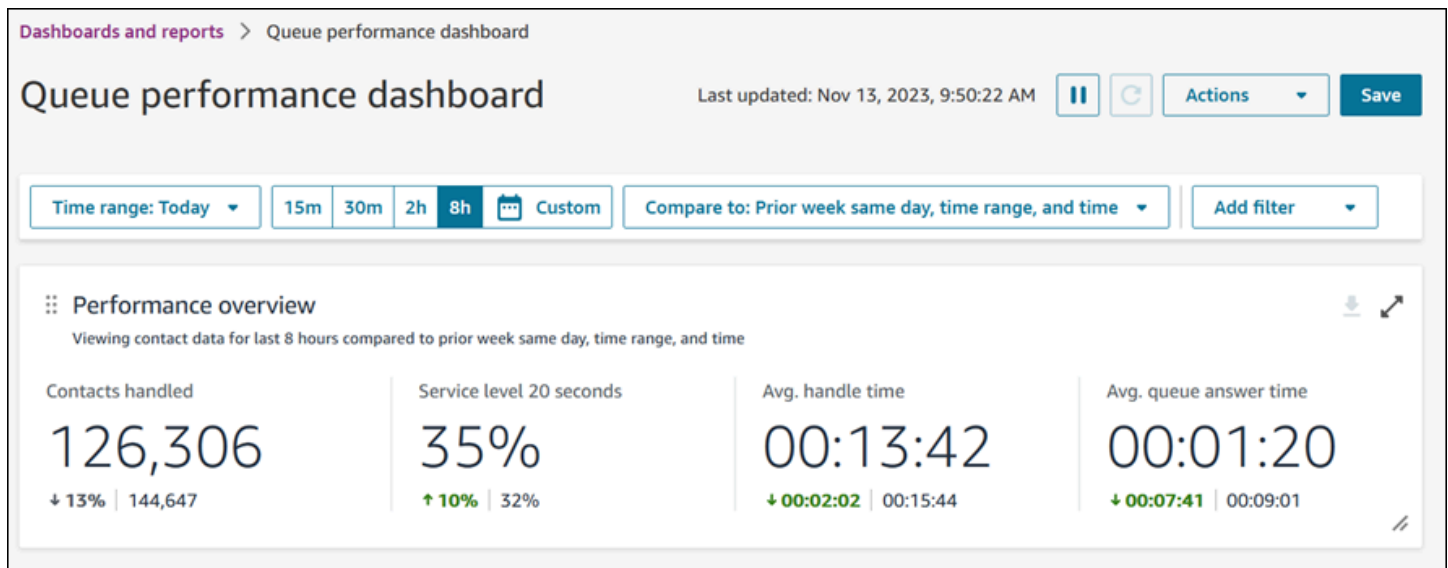

- **Contacts handled** during your time range selection was 126,306, which is down ~13% compared to your benchmark number of contacts handled, 144,647 contacts.
- The percentages are rounded up or down.
- The colors that appear for the metrics indicate positive (green) or negative (red) compared to your benchmark.
- There are no colors for **Contacts handled**.

Contacts handled and average handle time trend

The **Contacts handled and average handle time trend** is a time-series chart that displays the count of contacts handled (blue bars) and the average handle time (red line) over a given time period broken down by intervals (15min, daily, weekly, monthly).

To configure different time range intervals, choose **Interval**, as shown in the following image.

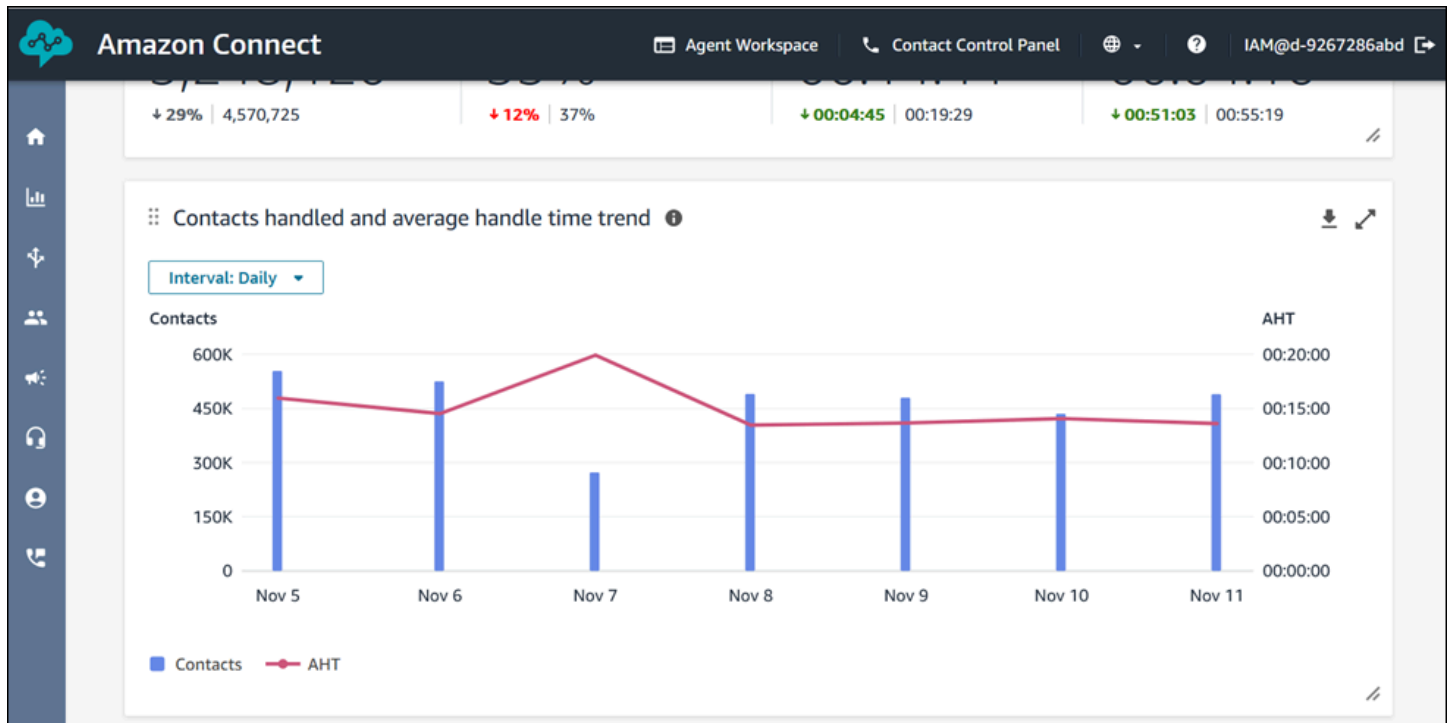

The available intervals depend on the page-level time range filter, which is set at the top of the page. For example:

- If you have a "Today" time range filter at the top of your dashboard, you can only see an interval of 15min for the last 24 hours.
- If you have a "Day" time range filter at the top of your dashboard, you can see a trailing 8 day interval trend, or a 15min interval trend for the trailing 24 hours.

Dashboard functionality limitations

The following limitations apply to the Queue performance dashboard:

- Tag-based access controls are not supported on the dashboard.

Assign security profile permissions for dashboards

To view dashboards, you need to be assigned to a security profile that has either the **Access metrics – Access** permission or the **Dashboards – Access** permission. Note the following behavior when you assign these permissions:

1. When **Access metrics – Access** is selected, the **Real-time metrics, Historical metrics, Agent activity audit,** and **Dashboards** permissions are also automatically assigned.
2. When **Access metrics – Access** is assigned, you have access to all real-time and historical metrics reports and dashboards.

The following image shows the **Analytics and Optimization** section of the **Security profile permissions** page. The **Access** option is selected for **Access metrics, Real-time metrics, Historical metrics, Agent activity audit,** and **Dashboards**.

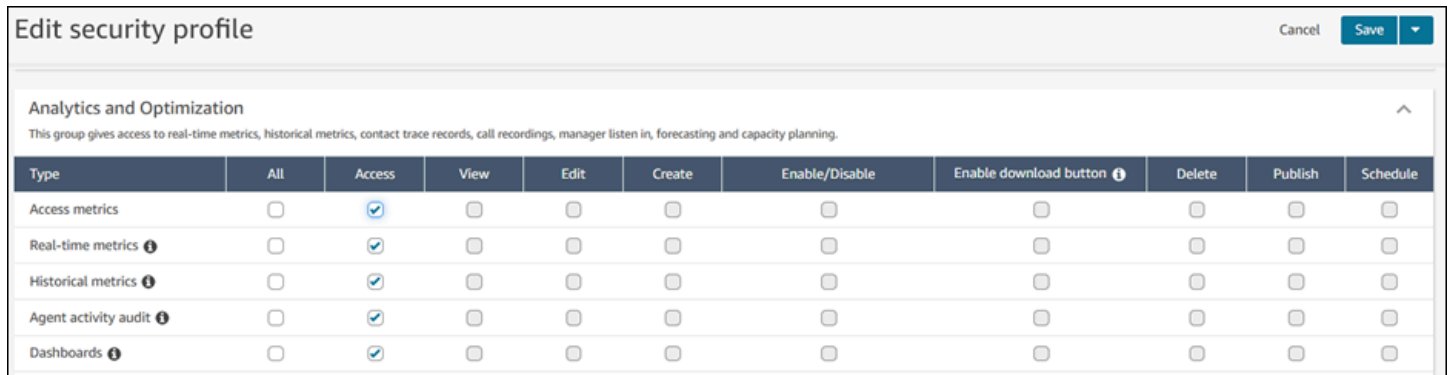

Type	All	Access	View	Edit	Create	Enable/Disable	Enable download button ⓘ	Delete	Publish	Schedule
Access metrics	<input type="checkbox"/>	<input checked="" type="checkbox"/>	<input type="checkbox"/>	<input type="checkbox"/>	<input type="checkbox"/>	<input type="checkbox"/>	<input type="checkbox"/>	<input type="checkbox"/>	<input type="checkbox"/>	<input type="checkbox"/>
Real-time metrics ⓘ	<input type="checkbox"/>	<input checked="" type="checkbox"/>	<input type="checkbox"/>	<input type="checkbox"/>	<input type="checkbox"/>	<input type="checkbox"/>	<input type="checkbox"/>	<input type="checkbox"/>	<input type="checkbox"/>	<input type="checkbox"/>
Historical metrics ⓘ	<input type="checkbox"/>	<input checked="" type="checkbox"/>	<input type="checkbox"/>	<input type="checkbox"/>	<input type="checkbox"/>	<input type="checkbox"/>	<input type="checkbox"/>	<input type="checkbox"/>	<input type="checkbox"/>	<input type="checkbox"/>
Agent activity audit ⓘ	<input type="checkbox"/>	<input checked="" type="checkbox"/>	<input type="checkbox"/>	<input type="checkbox"/>	<input type="checkbox"/>	<input type="checkbox"/>	<input type="checkbox"/>	<input type="checkbox"/>	<input type="checkbox"/>	<input type="checkbox"/>
Dashboards ⓘ	<input type="checkbox"/>	<input checked="" type="checkbox"/>	<input type="checkbox"/>	<input type="checkbox"/>	<input type="checkbox"/>	<input type="checkbox"/>	<input type="checkbox"/>	<input type="checkbox"/>	<input type="checkbox"/>	<input type="checkbox"/>

If only **Dashboards** is selected, you have access only to dashboards and no other analytics pages or reports. The following image shows the **Analytics and Optimization** section, with only **Dashboards – Access** selected.

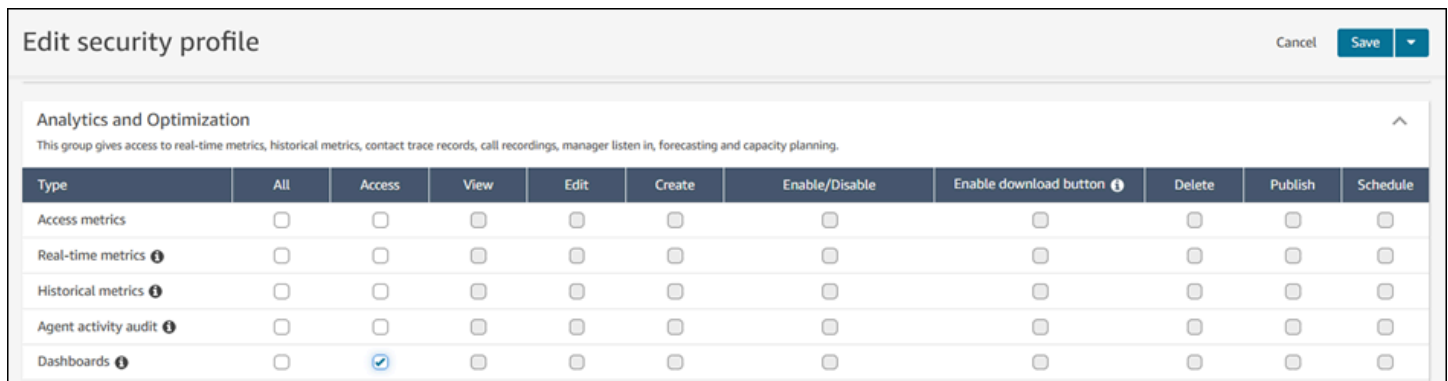

Type	All	Access	View	Edit	Create	Enable/Disable	Enable download button ⓘ	Delete	Publish	Schedule
Access metrics	<input type="checkbox"/>	<input type="checkbox"/>	<input type="checkbox"/>	<input type="checkbox"/>	<input type="checkbox"/>	<input type="checkbox"/>	<input type="checkbox"/>	<input type="checkbox"/>	<input type="checkbox"/>	<input type="checkbox"/>
Real-time metrics ⓘ	<input type="checkbox"/>	<input type="checkbox"/>	<input type="checkbox"/>	<input type="checkbox"/>	<input type="checkbox"/>	<input type="checkbox"/>	<input type="checkbox"/>	<input type="checkbox"/>	<input type="checkbox"/>	<input type="checkbox"/>
Historical metrics ⓘ	<input type="checkbox"/>	<input type="checkbox"/>	<input type="checkbox"/>	<input type="checkbox"/>	<input type="checkbox"/>	<input type="checkbox"/>	<input type="checkbox"/>	<input type="checkbox"/>	<input type="checkbox"/>	<input type="checkbox"/>
Agent activity audit ⓘ	<input type="checkbox"/>	<input type="checkbox"/>	<input type="checkbox"/>	<input type="checkbox"/>	<input type="checkbox"/>	<input type="checkbox"/>	<input type="checkbox"/>	<input type="checkbox"/>	<input type="checkbox"/>	<input type="checkbox"/>
Dashboards ⓘ	<input type="checkbox"/>	<input checked="" type="checkbox"/>	<input type="checkbox"/>	<input type="checkbox"/>	<input type="checkbox"/>	<input type="checkbox"/>	<input type="checkbox"/>	<input type="checkbox"/>	<input type="checkbox"/>	<input type="checkbox"/>

Real-time metrics reports

Real-time metrics reports show real-time or near-real time metrics information about activity in your contact center. Metrics such as **Online** show the number of agents currently online in real-time, updating every 15 seconds. Metrics such as **Handled** and **Abandoned** reflect near real-time values for your contact center.

You can customize the reports, specify a time range for each report, select metrics for each report, and select filters for data to include or exclude from each report.

You can also use the [Amazon Connect Service APIs](#) to create custom reports, such as real-time reports that are filtered by teams of agents.

Contents

- [Real-time metrics definitions](#)
- [Permissions required to view real-time metrics reports](#)
- [Real-time metrics tag-based access control](#)
- [How often real-time metrics refresh](#)
- [Use one-click drill-downs for Routing profiles and Queues tables](#)
- [Visualize: Queue dashboard](#)
- [View how many contacts are waiting in queue](#)
- [Create a real-time metrics report](#)
- [No metrics or too few rows in a queues report?](#)
- [List queues grouped by routing profile](#)
- [List agents grouped by routing profile](#)
- [Sort agents by activity in a real-time metrics report](#)
- [Change the "Agent activity" status in a real-time metrics report](#)
- [Download a real-time metrics report](#)

Real-time metrics definitions

The following metrics are available to include in real-time metrics reports in Amazon Connect. The metrics available to include in a report depend on the report type.

Tip

Developers can use the [GetCurrentMetricData](#) API to get a subset of the following real-time metrics from the specified Amazon Connect instance.

Abandoned

The count of contacts disconnected by the customer while in the queue during the specified time range. Contacts queued for callback are not counted as abandoned. When you create a customized real-time metrics report, to include this metric, choose a **Queues** report for the type. On the **Filters** tab, choose **Queues**, then on the **Metrics** tab you'll have the option to include **Abandoned**.

Abandonment rate

The percentage of contacts that were disconnected by the customer while in the queue. Contacts queued for callback are not counted as abandoned.

Active

The count of active slots. This number is incremented for each contact where the contact state is either Connected, On Hold, After contact work, Paused, or Outbound ring.

In the [GetCurrentMetricData](#) API, this metric can be retrieved by using SLOTS_ACTIVE.

ACW

The count of contacts that are in an **AfterContactWork** state. (After contact work is also known as After call work.) After a conversation between an agent and customer ends, the contact is moved into the ACW state.

In the [GetCurrentMetricData](#) API, this metric can be retrieved by using AGENTS_AFTER_CONTACT_WORK. The name of this metric is confusing because in the Amazon Connect admin website, ACW counts the number of *contacts* that are in an ACW state, not the number of agents.

To learn more about agent status and contact states, see [About agent status](#) and [About contact states](#).

Agent Activity

If an agent is handling a single contact, this metric may have the following values: Available, Incoming, On contact, Rejected, Missed, Error, After contact work, or a custom status.

If an agent is handling concurrent contacts, Amazon Connect uses the following logic to determine the state:

- If at least one contact is in Error, Agent Activity = **Error**.

- Else if at least one contact is Missed contact, Agent Activity = **Missed**.
- Else if at least one contact is Rejected contact, Agent Activity = **Rejected**.
- Else if at least one contact is Connected, On Hold, Paused, or Outbound contact/Outbound callback, Agent Activity = **On contact**.
- Else if at least one contact is After contact work, Agent Activity = **After Contact Work**.
- Else if at least one contact is Incoming/Inbound Callback, Agent Activity = **Incoming**.
- Else if agent status is a custom status, Agent Activity is the custom status.
- Else if agent status is Available, Agent Activity = **Available**.
- Else if agent status is Offline, Agent Activity = **Offline**. (After an agent moves to Offline, they disappear from the real-time metrics page in approximately 5 minutes.)

If a manager is using the Manager Monitor feature to monitor a particular agent as they interact with a customer, then the manager's Agent Activity will display as Monitoring. The Agent Activity of the agent who is being monitored is still On Contact.

Agent First Name

The first name of the agent, as entered in their Amazon Connect user account.

Agent Hierarchy

The hierarchy the agent is assigned to, if any.

Agent hung up

The count of contacts disconnected where the agent disconnected before the customer.

Agent Last Name

The last name of the agent, as entered in their Amazon Connect user account.

Agent Name

The name of the agent, displayed as follows: **Agent Last Name, Agent First Name**.

Agent non-response

The count of contacts routed to an agent but not answered by that agent, including contacts abandoned by the customer.

If a contact is not answered by a given agent, we attempt to route it to another agent to handle; the contact is not dropped. Because a single contact can be missed multiple times (including by the same agent), it can be counted multiple times: once for each time it is routed to an agent but not answered.

This metric was previously named **Missed**.

Agent non-response without customer abandons

If a contact is not answered by a given agent, Amazon Connect attempts to route it to another agent to handle; the contact is not dropped. Because a single contact can be missed multiple times (including by the same agent), it can be counted multiple times: once for each time it is routed to an agent but not answered.

AHT (Average Handle Time)

The average time, from start to finish, that a contact is connected with an agent (average handle time). It includes talk time, hold time, After Contact Work (ACW) time, and agent pause duration (which applies only to tasks).

AHT is calculated by averaging **the amount of time between the contact being answered by an agent and the completion of work on that contact by an agent**.

API contacts handled

The count of contacts that were initiated by an API operation, such as `StartOutboundVoiceContact`, and handled by an agent.

Availability

For each agent, the number of available slots they have that can be routed contacts.

The number of available slots for an agent are based on their [routing profile](#). For example, let's say an agent's routing profile specifies they can handle either one voice contact **or** up to three chat contacts simultaneously. If they are currently handling one chat, they have two available slots left, not three.

What causes this number to go down? A slot is considered unavailable when:

- A contact in the slot is: connected to the agent, in After Contact Work, inbound ringing, outbound ringing, missed, or in an error state.

- A contact in the slot is connected to the agent and on hold.

Amazon Connect doesn't count an agent's slots when:

- The agent has set their status in the CCP to a custom status, such as Break or Training. Amazon Connect doesn't count these slots because agents can't take inbound contacts when they've set their status to a custom status.
- The agent can't take contacts from that channel per their routing profile.

In the [GetCurrentMetricData](#) API, this metric can be retrieved by using SLOTS_AVAILABLE.

Available

The number of agents who can take an inbound contact. An agent can only take inbound contacts when they manually set their status to Available in the CCP (or in some cases when their manager changes it).

This is different from how many more inbound contacts an agent could take. If you want to know how many more contacts an agent can have routed to them, look at the Availability metric. It indicates how many slots the agent has free.

What causes this number to go down? An agent is considered **unavailable** when:

- The agent has set their status in the CCP to a custom status, such as Break or Training. Amazon Connect doesn't count these slots because agents can't take inbound contacts when they've set their status to a custom status.
- The agent has at least one contact ongoing.
- The agent has a contact in a missed or error state, which prevents the agent from taking any more contacts until they are flipped back to routable.

In the [GetCurrentMetricData](#) API, this metric can be retrieved by using AGENTS_AVAILABLE.

Average Active Time

The average time, from start to finish, that an agent was working on a contact (average active time). It includes talk time, hold time, and After Contact Work (ACW) time. It applies to both inbound and outbound calls.

Average Active Time does not include any time spent in a custom status; Contact handle time (CHT) does include the time spent in custom status.

Average Agent Pause Time

Average time that the contact was paused after being connected to agent during an inbound or outbound contact.

$SUM(\text{agent_pause_time}) / \text{Number of Contacts that were paused}$

Average API Connecting Time

The average time between when a contact is initiated using an Amazon Connect API, and the agent is connected.

Avg abandon time

Average time, in seconds, that abandoned contacts were in the queue before being abandoned.

Avg ACW

Average time, in seconds, that contacts spent in the **After contact work** state, during the specified time range.

This is not the average amount of time agents spent on contacts.

To learn more about agent status and contact states, see [About agent status](#) and [About contact states](#).

Avg callback connecting time

The average time between when callback contacts are initiated by Amazon Connect reserving the agent for the contact, and the agent is connected.

No equivalent to this metric is available in the GetCurrentMetricData API.

The following image shows the five parts that go into calculating **Avg callback connecting time**: Amazon Connect assign work item to agent, agent accepts work item, connection build time, network connection time, rings for customer. It also shows what is in the agent event stream: Connecting, Connected or no answer.

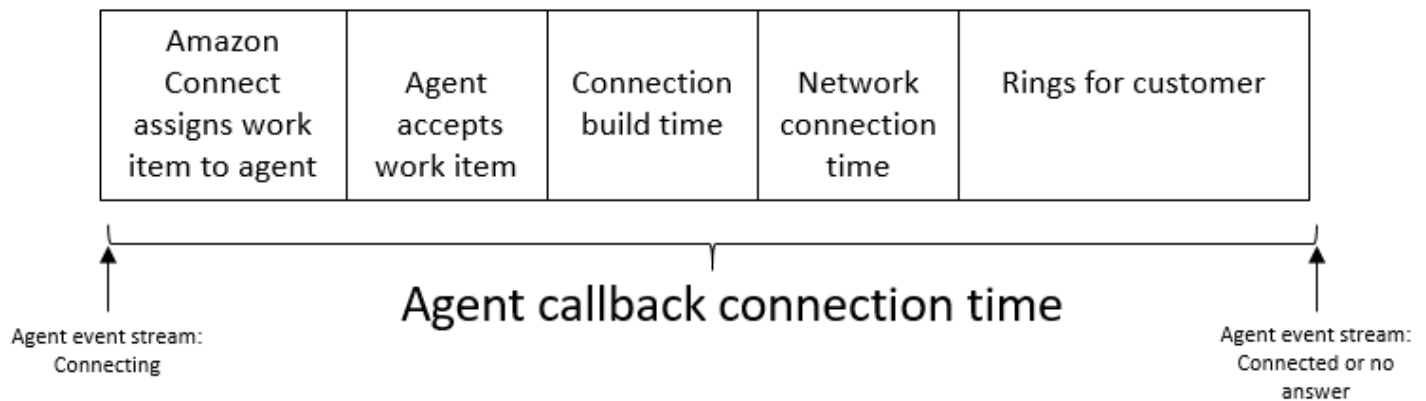

Average customer hold time

Average time that customers spent on hold while connected to an agent. This is calculated by averaging CustomerHoldDuration (from the contact record).

Average greeting time agent

This metric represents the average first response time of agents on chat, indicating how quickly they engage with customers after joining the chat. It is calculated by dividing the total time it takes for an agent to initiate their first response by the number of chat contacts.

Note

This metric is available only for contacts analyzed by Contact Lens conversational analytics.

Avg hold time

Average time, in seconds, that a contact in the queue was on hold.

This metric doesn't apply to tasks so you'll notice a value of 0 on the report for them.

Avg incoming connecting time

The average time between when contacts are initiated Amazon Connect reserving the agent for the contact, and the agent is connected.

In the agent event stream, this time is calculated by averaging the duration between the contact state of STATE_CHANGE event changes from CONNECTING to CONNECTED/MISSED/ERROR.

No equivalent to this metric is available in the `GetCurrentMetricData` API.

The following image shows the three parts that go into calculating **Avg incoming connecting time**: connection build time, network connection time, and requesting agent to accept. It also shows what is in the agent event stream: Connecting, Connected, Missed, or Rejected.

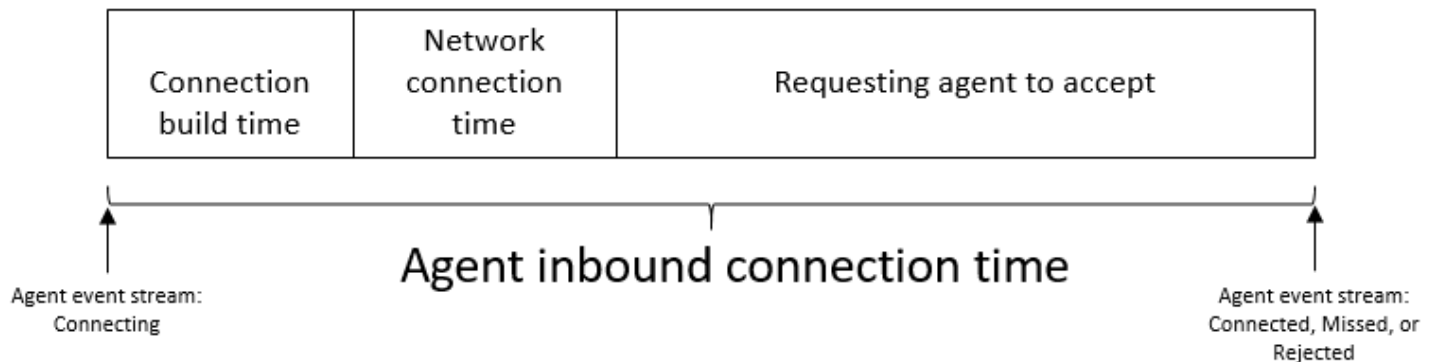

Avg interaction time

Average time, in seconds, that contacts were connected to and interacting with agents. This does not include hold time, agent pause duration (which applies only to tasks), or time spent waiting in the queue.

Avg interaction and hold time

Average time, in seconds, that contacts in the queue spent interacting with agents and on hold. This is calculated as follows:

Avg hold time + Avg interaction time

Average interaction time

Total time that agents spent interacting with customers on inbound and outbound contacts. This does not include [Customer hold time](#) or [After contact work time](#).

Average interruptions agent

This metric quantifies the average frequency of agent interruptions during customer interactions by dividing the total number of agent interruptions by the total number of contacts.

Note

This metric is available only for contacts analyzed by Contact Lens conversational analytics.

Average non-talk time

Average of total non-talk time in a voice conversation. Non-talk time refers to the combined duration of hold time and periods of silence exceeding three seconds, during which neither the agent nor the customer is engaged in conversation. To calculate non-talk time, we add up all the intervals in which both participants remained silent and then divide this total by the number of contacts.

Note

This metric is available only for contacts analyzed by Contact Lens conversational analytics.

Average talk time

Average time that was spent talking during a voice contact across either the customer or the agent. This is calculated by summing up all the intervals in which either an agent, a customer, or both were engaged in conversation, and then dividing it by the total number of contacts.

Note

This metric is available only for contacts analyzed by Contact Lens conversational analytics.

Avg queue answer time

Average time, in seconds, that a contact was in the queue before being answered by an agent. This is calculated using the amount of time that the contact was in the queue, not any time that the contact spent in prior steps of the flow, such as listening or responding to prompts.

Average resolution time

The average time, beginning from the time a contact was initiated to the time it resolved. The resolution time for a contact is defined as: beginning from `InitiationTimestamp`, and ending at `AfterContactWorkEndTimestamp` or `DisconnectTimestamp`, whichever one is later.

Avg outbound connecting time

The average time between when outbound contacts are initiated by Amazon Connect reserving the agent for the contact, and the agent is connected.

No equivalent to this metric is available in the `GetCurrentMetricData` API.

The following image shows the four parts that go into calculating **Avg outbound connecting time**: agent call customer, connection build time, network connection time, rings for customer. It also shows what is in the agent event stream: `Connecting`, `Connected` or `No answer`.

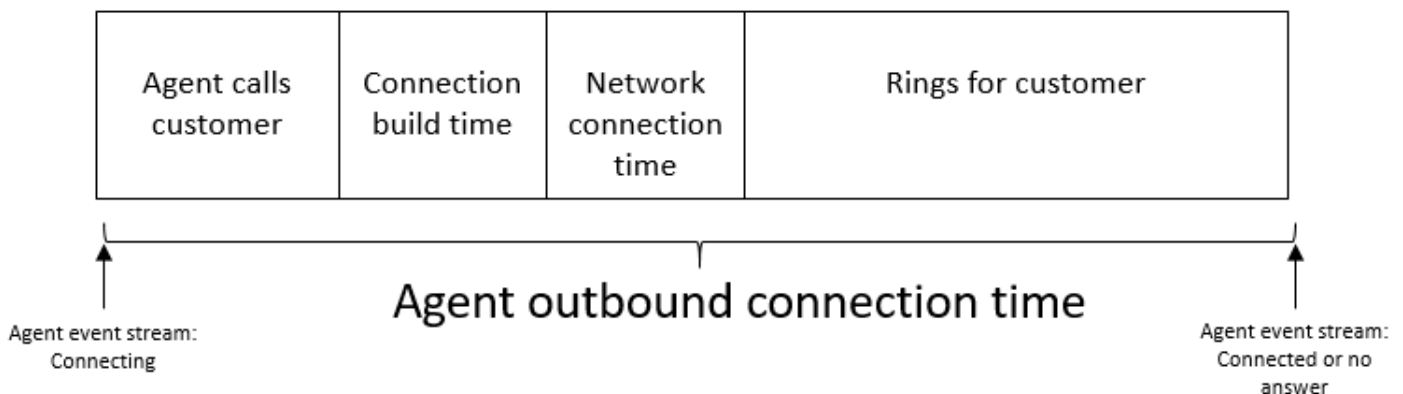

Callback attempts

The number of contacts where a callback was attempted, but the customer did not pick up.

Callback contacts handled

The count of contacts handled by an agent that were queued callbacks.

Capacity

Displays the maximum capacity that's set in the routing profile currently assigned to the agent. This column can be filtered by channel.

If an agent's routing profile is configured to handle either one voice **or** up to three chats, then their maximum capacity equals three, when not filtered by channel.

Consult

Deprecated May 2019. When used in a report, it returns a dash (-).

The count of contacts in the queue that were handled by an agent, and the agent consulted with another agent or a call center manager during the contact.

Contact State

The state of the contacts the agent is currently handling. The state can be: **Connected, On Hold, After contact work, Paused, Incoming, Calling, or Missed contact.**

For queued callbacks, the contact state can also **Callback incoming** or **Callback dialing.**

If a manager is using the Manager Monitor feature to monitor a particular agent as they interact with a customer, the manager's contact state is Monitoring; the agent's contact state is Connected.

Contacts Abandoned in X

The count of contacts disconnected without being connected to an agent for 0 to X seconds.

The preset values for X are: 15, 20, 25, 30, 45, 60, 90, 120, 180, 240, 300, and 600 but you can define a custom duration for this metric such as minutes, hours, or days. The maximum duration for a custom value is 7 days. That's because in Amazon Connect you can't have a contact that goes longer than 7 days.

In the [GetMetricDataV2](#) API, this metric can be retrieved by using SUM_CONTACTS_ABANDONED_IN_X.

Contacts answered in X

The count of contacts that were answered by an agent between 0 and X seconds of being placed in the queue, based on the value of EnqueueTimestamp.

The preset values for X are: 15, 20, 25, 30, 45, 60, 90, 120, 180, 240, 300, and 600 but you can define a custom duration for this metric such as minutes, hours, or days. The maximum duration for a custom value is 7 days. That's because in Amazon Connect you can't have a contact that goes longer than 7 days.

In the [GetMetricDataV2](#) API, this metric can be retrieved by using `SUM_CONTACTS_ANSWERED_IN_X`.

Contacts transferred out

The count of contacts transferred out from queue to queue, and transferred out by an agent using the CCP.

Duration

Amount of time that the agent has been in the current Agent Activity State.

Error

A count of agents in Error state. An agent is included in this metric if they miss a call or reject a chat/task (most common). They could also be counted if there is a connection failure.

In the [GetCurrentMetricData](#) API, this metric can be retrieved by using `AGENTS_ERROR`.

Handled

The count of contacts in the queue that were answered by an agent.

Handled in

The count of incoming contacts handled by an agent during the specified time range that were initiated using one of the following methods: inbound call, transfer to agent, transfer to queue, or queue-to-queue transfer.

Handled out

The count of contacts handled by an agent during the specified time range that were initiated by an agent placing an outbound call using the CCP. All calls made by agents are counted in, as long as they use the CCP, a custom CCP or other client app that use the Amazon Connect Streams API.

Hold abandons

The count of contacts that disconnected while the customer was on hold. A disconnect could be because the customer hung up while on hold, or that there was a technical issue with the contact while on hold.

In queue

The count of contacts currently in the queue. The queue is updated when the contact is routed to the agent, before the agent accepts the contact.

To learn how this is different from Scheduled contacts in a callback scenario, see [How Initial delay affects Scheduled and In queue metrics](#).

In the [GetCurrentMetricData](#) API, this metric can be retrieved by using CONTACTS_IN_QUEUE.

Max queued

The longest time that a contact spent waiting in the queue. This includes all contacts added to the queue, even if they were not connected with an agent, such as abandoned contacts.

NPT (Non-Productive Time)

The count of agents who have set their status in the CCP to a custom status. That is, their CCP status is other than **Available** or **Offline**.

Tip

Although agents aren't routed any *new inbound* contacts while their CCP status is set to a custom status, it's possible for them to change their CCP status to a custom status while still handling a contact. For example, let's say an agent is being routed contacts very quickly. To go on break, they set their status to **Break** proactively, while still finishing up the last contact. This allows them to go on break and avoid accidentally missing a contact that's routed to them in the sliver of time between the last contact ending and setting their status to Break.

Because agents can be **On call** or doing **ACW**, for example, while their CCP is set to a custom status, this means it's possible for agents to be counted as **On call** and **NPT** at the same time.

In the [GetCurrentMetricData](#) API, this metric can be retrieved by using AGENTS_NON_PRODUCTIVE.

Non-talk time percent

The non-talk time in a voice conversation as a percent of the total conversation duration. To calculate non-talk time percent, Amazon Connect totals all the intervals in which participants remained silent (non-talk time), and then divides this total by the total conversation duration.

Note

This metric is available only for contacts analyzed by Contact Lens conversational analytics.

Occupancy

Percentage of time that an agent was active on contacts. This percentage is calculated as follows:

$(\text{Agent on contact (wall clock time)} / (\text{Agent on contact (wall clock time)} + \text{Agent idle time}))$

Where:

- $(\text{Agent on contact} + \text{Agent idle time}) = \text{total amount of agent time}$
- So $(\text{Agent on contact}) / (\text{total amount of agent time}) = \text{percentage of time agents were active on contacts.}$

Important

Occupancy doesn't account for concurrency. That is, an agent is considered 100% occupied for a given interval if they are handling at least one contact for that entire duration.

Oldest

Length of time in the queue for the contact that has been in the queue the longest.

In the [GetCurrentMetricData](#) API, this metric can be retrieved by using OLDEST_CONTACT_AGE.

On contact

The count of agents currently on a contact. An agent is "on a contact" when they are handling at least one contact that is either connected, on hold, in After contact work, paused, or outbound ring.

In the [GetCurrentMetricData](#) API, this metric can be retrieved by using AGENTS_ON_CONTACT. This metric used to be named On call. You can still use AGENTS_ON_CALL to retrieve data for this metric.

Online

The count of agents who have set their status in the CCP to something other than **Offline**. For example, they may have set their status to *Available*, or to a custom value such as *Break* or *Training*.

The Online metric doesn't tell you how many agents can be routed contacts. For that metric, see [Available](#).

This metric can be confusing so let's look at an example. Say you see this in a Queues report:

- Online = 30
- On Call = 1
- NPT = 30
- ACW = 0
- Error = 0
- Available = 0

This means 30 agents have set their status in the CCP to a custom status. 1 of those 30 agents is currently on a contact.

In the [GetCurrentMetricData](#) API, this metric can be retrieved by using `AGENTS_ONLINE`.

Queue

The name of the queue associated with the contact the agent is currently handling.

Queued

The count of contacts added to the queue during the specified time range.

Routing Profile

The routing profile for the agent.

Scheduled

The count of customers in the queue for which there is a callback scheduled.

To learn how this is different from In queue contacts in a callback scenario, see [How Initial delay affects Scheduled and In queue metrics](#).

In the [GetCurrentMetricData](#) API, this metric can be retrieved by using CONTACTS_SCHEDULED.

SL X

Percentage of contacts removed from the queue between 0 and X after being added to it (Service Level). A contact is removed from the queue when one of the following occurs: an agent answers the call, the customer abandons the call, or the customer requests a call back.

For X, you can choose from pre-set times in seconds: 15, 20, 25, 30, 45, 60, 90, 120, 180, 240, 300, and 600.

Custom service levels

You can also create custom service level metrics. You can also choose from additional durations, such as minutes, hours, or days.

You can add up to 10 custom service levels per report.

The maximum duration for a custom service level is 7 days. That's because in Amazon Connect you can't have a contact that goes longer than 7 days.

Staffed

The count of agents who are online in the CCP, and not in NPT (a custom status).

Another way of thinking about this is, there are two scenarios in which **Staffed** is not incremented:

- The agent's status in the CCP is set to **Offline**.
- The agent's status in the CCP is set to a custom status.

For example, let's say an agent sets their status in the CCP to a custom status such as Break and they make an outbound call. Now the agent is **On call**, but **Staffed** is 0.

If the agent sets their status in the CCP to **Available** and makes an outbound call, the agent is **On call** and **Staffed** is 1.

This metric is available on the Queues report.

In the [GetCurrentMetricData](#) API, this metric can be retrieved by using AGENTS_STAFFED.

Transferred in

The count of contacts transferred into the queue during the specified time range.

Transferred in by agent

The count of contacts transferred in by an agent using the CCP.

Transferred in from queue

The count of contacts transferred into the queue from another queue during a **Customer queue flow**.

Transferred out

The count of contacts transferred out of the queue during the specified time range.

Transferred out by agent

The count of contacts transferred out by an agent using the CCP.

Transferred out from queue

The count of contacts transferred out of the queue to another queue during a **Customer queue flow**.

Permissions required to view real-time metrics reports

To view real-time metrics reports, you need to be assigned to a security profile that has either the **Access metrics - Access** permission or the **Real-time metrics - Access** permission. Note the following behavior when you assign these permissions:

- When **Access metrics - Access** is selected, the **Real-time metrics**, **Historical metrics**, and **Agent activity audit** permissions are also automatically assigned.
- When **Access metrics - Access** is assigned, you have access to all real-time and historical metrics reports.

The following image shows the **Analytics and Optimization** section of the **Security profile permissions** page. The **Access** option is selected for **Access metrics**, **Real-time metrics**, **Historical metrics**, and **Agent activity audit**.

Analytics and Optimization ⓘ										
Type	All	Access	View	Edit	Create	Enable/Disable	Enable download button	Delete	Publish	Schedule
Access metrics	<input type="checkbox"/>	<input checked="" type="checkbox"/>	<input type="checkbox"/>	<input type="checkbox"/>	<input type="checkbox"/>	<input type="checkbox"/>	<input type="checkbox"/>	<input type="checkbox"/>	<input type="checkbox"/>	<input type="checkbox"/>
Real-time metrics ⓘ	<input type="checkbox"/>	<input checked="" type="checkbox"/>	<input type="checkbox"/>	<input type="checkbox"/>	<input type="checkbox"/>	<input type="checkbox"/>	<input type="checkbox"/>	<input type="checkbox"/>	<input type="checkbox"/>	<input type="checkbox"/>
Historical metrics ⓘ	<input type="checkbox"/>	<input checked="" type="checkbox"/>	<input type="checkbox"/>	<input type="checkbox"/>	<input type="checkbox"/>	<input type="checkbox"/>	<input type="checkbox"/>	<input type="checkbox"/>	<input type="checkbox"/>	<input type="checkbox"/>
Agent activity audit ⓘ	<input type="checkbox"/>	<input checked="" type="checkbox"/>	<input type="checkbox"/>	<input type="checkbox"/>	<input type="checkbox"/>	<input type="checkbox"/>	<input type="checkbox"/>	<input type="checkbox"/>	<input type="checkbox"/>	<input type="checkbox"/>
Contact search	<input type="checkbox"/>	<input type="checkbox"/>	<input type="checkbox"/>	<input type="checkbox"/>	<input type="checkbox"/>	<input type="checkbox"/>	<input type="checkbox"/>	<input type="checkbox"/>	<input type="checkbox"/>	<input type="checkbox"/>
Search contacts by conversation characteristics	<input type="checkbox"/>	<input type="checkbox"/>	<input type="checkbox"/>	<input type="checkbox"/>	<input type="checkbox"/>	<input type="checkbox"/>	<input type="checkbox"/>	<input type="checkbox"/>	<input type="checkbox"/>	<input type="checkbox"/>
Search contacts by keywords	<input type="checkbox"/>	<input type="checkbox"/>	<input type="checkbox"/>	<input type="checkbox"/>	<input type="checkbox"/>	<input type="checkbox"/>	<input type="checkbox"/>	<input type="checkbox"/>	<input type="checkbox"/>	<input type="checkbox"/>
Configure searchable contact attributes	<input type="checkbox"/>	<input type="checkbox"/>	<input type="checkbox"/>	<input type="checkbox"/>	<input type="checkbox"/>	<input type="checkbox"/>	<input type="checkbox"/>	<input type="checkbox"/>	<input type="checkbox"/>	<input type="checkbox"/>

If only **Real-time metrics** is selected, you have access only to real-time metrics and no other analytics pages or reports. The following image shows the **Analytics and Optimization** section, with only **Real-time metrics - Access** selected.

Analytics and Optimization ⓘ										
Type	All	Access	View	Edit	Create	Enable/Disable	Enable download button	Delete	Publish	Schedule
Access metrics	<input type="checkbox"/>	<input type="checkbox"/>	<input type="checkbox"/>	<input type="checkbox"/>	<input type="checkbox"/>	<input type="checkbox"/>	<input type="checkbox"/>	<input type="checkbox"/>	<input type="checkbox"/>	<input type="checkbox"/>
Real-time metrics ⓘ	<input type="checkbox"/>	<input checked="" type="checkbox"/>	<input type="checkbox"/>	<input type="checkbox"/>	<input type="checkbox"/>	<input type="checkbox"/>	<input type="checkbox"/>	<input type="checkbox"/>	<input type="checkbox"/>	<input type="checkbox"/>
Historical metrics ⓘ	<input type="checkbox"/>	<input type="checkbox"/>	<input type="checkbox"/>	<input type="checkbox"/>	<input type="checkbox"/>	<input type="checkbox"/>	<input type="checkbox"/>	<input type="checkbox"/>	<input type="checkbox"/>	<input type="checkbox"/>
Agent activity audit ⓘ	<input type="checkbox"/>	<input type="checkbox"/>	<input type="checkbox"/>	<input type="checkbox"/>	<input type="checkbox"/>	<input type="checkbox"/>	<input type="checkbox"/>	<input type="checkbox"/>	<input type="checkbox"/>	<input type="checkbox"/>
Contact search	<input type="checkbox"/>	<input type="checkbox"/>	<input type="checkbox"/>	<input type="checkbox"/>	<input type="checkbox"/>	<input type="checkbox"/>	<input type="checkbox"/>	<input type="checkbox"/>	<input type="checkbox"/>	<input type="checkbox"/>
Search contacts by conversation characteristics	<input type="checkbox"/>	<input type="checkbox"/>	<input type="checkbox"/>	<input type="checkbox"/>	<input type="checkbox"/>	<input type="checkbox"/>	<input type="checkbox"/>	<input type="checkbox"/>	<input type="checkbox"/>	<input type="checkbox"/>
Search contacts by keywords	<input type="checkbox"/>	<input type="checkbox"/>	<input type="checkbox"/>	<input type="checkbox"/>	<input type="checkbox"/>	<input type="checkbox"/>	<input type="checkbox"/>	<input type="checkbox"/>	<input type="checkbox"/>	<input type="checkbox"/>
Configure searchable contact attributes	<input type="checkbox"/>	<input type="checkbox"/>	<input type="checkbox"/>	<input type="checkbox"/>	<input type="checkbox"/>	<input type="checkbox"/>	<input type="checkbox"/>	<input type="checkbox"/>	<input type="checkbox"/>	<input type="checkbox"/>

Real-time metrics tag-based access control

You can use resource tags and access control tags to apply granular access to users, queues, and routing profiles for real-time metrics. For example, you can control who has access to view specific users, queues, and routing profiles on the **Real-time metrics** page.

You can configure tag-based access controls by using the Amazon Connect admin website or the [TagResource](#) API.

Contents

- [Important things to know](#)
- [How to enable tag-based access control for real-time metrics](#)
- [How to view hundreds of agents, queues, and routing profiles on the real-time metrics report](#)
- [How to transition to tag-based access control](#)
- [Required security profile permissions](#)
- [Example report with tag-based access controls applied](#)

Important things to know

- Amazon Connect can display up to 100 resources at a time on a real-time metrics table. For example, in an Agents table it can display up to 100 agents at a time. In a Queues table it can display up to 100 queues, and so on.
- Very often fewer than 100 agents will appear on a real-time metrics table at any given time when tagging is enabled. Here's why:
 - Amazon Connect can return a maximum of 100 agents at a time.
 - When tagging is enabled, Amazon Connect selects the first 100 agents who have the appropriate tags, and then displays only those agents in that group of 100 **who are active** (Online or On Contact). Because not all of the 100 tagged agents may be active, it is very likely fewer than 100 tagged agents will be displayed in the table.
 - For example, you have 200 tagged agents. In the first group of 100 tagged agents only 50 are online. Amazon Connect selects the first 100 tagged agents but displays only 50 because they are currently active. It does not select the first 100 active agents.
 - For instructions that explain how to view the status of hundreds of agents when tagging is enabled, see [How to view hundreds of agents, queues, and routing profiles on the real-time metrics report](#).
- You can filter and group tables only by the primary resource (agent, queue, or routing profile). You cannot filter and group tables by non-primary resources. For example, you cannot filter by queue in an Agent table and you cannot group by queue in a Routing profile table.
- The drill-down button is disabled within tables except for **View queue graphs**. For example, you cannot choose **View agents** in a Queue table.
- Access to the homepage service level dashboard is disabled.
- Access to view **Agent Queues** is disabled.
- The **Agent Adherence** table is not supported.

How to enable tag-based access control for real-time metrics

1. Apply resource tags, for example, to agents, queues, and routing profiles. For a list of which resources support tagging, see [Tag resources in Amazon Connect](#).
2. Apply access control tags. In this step, you need to provide tag information in the condition element of an IAM policy. For more information, see [Tag-based access control](#).

Note

You must configure user resource tags and access control tags before tag-based access control is applied to users for the agent activity audit report.

3. Assign the required security profile permissions to users who are going to view the real-time metrics reports with tagging enabled. They need permissions to access the reports, and permissions to access the resources. For more information, see [Required security profile permissions](#).

How to view hundreds of agents, queues, and routing profiles on the real-time metrics report

Amazon Connect displays up to 100 resources at a time on the real-time metrics report. For agents in particular when tags are applied it's very likely that fewer than 100 agents will be displayed. We recommend the following workaround to view the status of hundreds of agents, queues, and routing profiles when tags are applied.

1. Add one table for each group of 100 resources. For example, you have 500 agents. You would create 5 Agent tables.
2. For each table, manually filter to add up to 100 resources. For example, to add agents to the first table, you would choose to filter by **Agents**, and then choose 100 agents to include in the table, as shown in the following image. In table 2, add the next group of 100 agents, and so on.

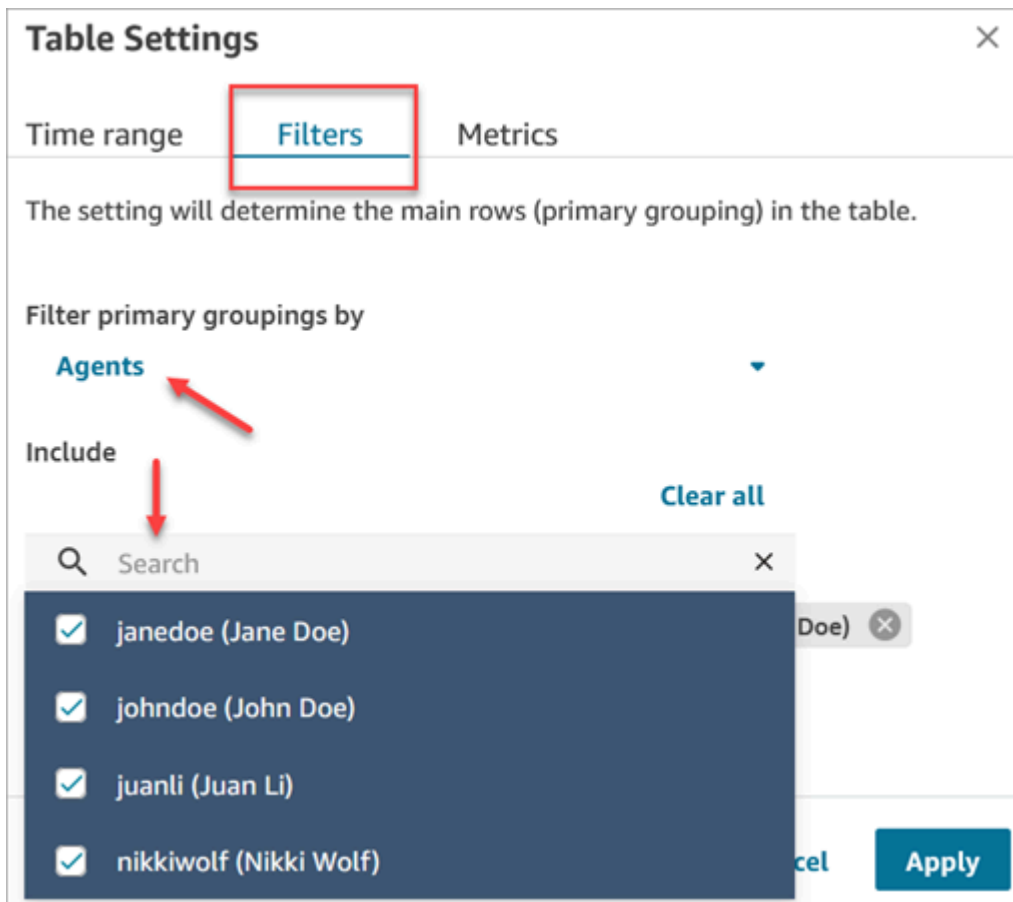

3. You will be able to view the data for all 500 resources across the 5 tables. When tags are applied to agents, each table will likely display fewer than 100 agents because not all of them may be active at the same time.

How to transition to tag-based access control

If you open a saved report that contains tables with users, queues, or routing profiles that you don't have access to anymore due to tag-based access control, or if groupings or non-primary filters are applied to tables, you won't see data in those tables.

To view the data, perform one of the following steps:

- Edit your table filters to include the agents, queues, or routing profiles that you have access to.
- Create a new report that includes the resources you have access to.
- Remove the groupings and non-primary filters from the table.

Required security profile permissions

To view real-time metrics reports that have tag-based access controls applied to them, you need to be assigned to a security profile that has permissions to:

- [Access metrics](#).
- [Access the resources you want to view](#), such as routing profiles, queues, and agents.

Permissions to access metrics

You need one of the following **Analytics and Optimization** security profile permissions:

- **Access metrics - Access**
- **Real-time metrics - Access**, as shown in the following image of the **Analytics and Optimization** section of the security profiles page.

Analytics and Optimization ⓘ			
Type	All	Access	View
Access metrics	<input type="checkbox"/>	<input type="checkbox"/>	<input type="checkbox"/>
Real-time metrics ⓘ	<input type="checkbox"/>	<input checked="" type="checkbox"/>	<input type="checkbox"/>
Historical metrics ⓘ	<input type="checkbox"/>	<input type="checkbox"/>	<input type="checkbox"/>
Agent activity audit ⓘ	<input type="checkbox"/>	<input type="checkbox"/>	<input type="checkbox"/>
Contact search	<input type="checkbox"/>	<input type="checkbox"/>	<input type="checkbox"/>
Search contacts by conversation characteristics	<input type="checkbox"/>	<input type="checkbox"/>	<input type="checkbox"/>
Search contacts by keywords	<input type="checkbox"/>	<input type="checkbox"/>	<input type="checkbox"/>
Configure searchable contact attributes	<input type="checkbox"/>	<input type="checkbox"/>	<input type="checkbox"/>

When you enable **Access metrics - Access**, permissions are also automatically granted to **Real-time metrics**, **Historical metrics**, and **Agent activity audit**. The following image shows all of these permissions granted.

Note

When users have all of these permissions, they can see all data for historical metrics for which tag-based access controls are not currently applied.

Analytics and Optimization ⓘ		
Type	All	Access
Access metrics	<input type="checkbox"/>	<input checked="" type="checkbox"/>
Real-time metrics ⓘ	<input type="checkbox"/>	<input checked="" type="checkbox"/>
Historical metrics ⓘ	<input type="checkbox"/>	<input checked="" type="checkbox"/>
Agent activity audit ⓘ	<input type="checkbox"/>	<input checked="" type="checkbox"/>
Contact search	<input type="checkbox"/>	<input type="checkbox"/>
Search contacts by conversation characteristics	<input type="checkbox"/>	<input type="checkbox"/>
Search contacts by keywords	<input type="checkbox"/>	<input type="checkbox"/>
Configure searchable contact attributes	<input type="checkbox"/>	<input type="checkbox"/>

Permissions to access resources

The following image shows an example of security profile permissions that grant users the ability to view routing profiles, queues, and Amazon Connect user accounts. **Routing profiles - View**, **Queues - View**, and **Users - View** are selected.

Security profile permissions		
Routing ⓘ		
Type	All	View
Routing profiles	<input type="checkbox"/>	<input checked="" type="checkbox"/>
Quick connects	<input type="checkbox"/>	<input type="checkbox"/>
Hours of operation	<input type="checkbox"/>	<input type="checkbox"/>
Queues	<input type="checkbox"/>	<input checked="" type="checkbox"/>
Task templates	<input type="checkbox"/>	<input type="checkbox"/>
Numbers and flows ⓘ		
Users and permissions ⓘ		
Type	All	View
Users	<input type="checkbox"/>	<input checked="" type="checkbox"/>
Agent hierarchy	<input type="checkbox"/>	<input type="checkbox"/>
Security profiles	<input type="checkbox"/>	<input type="checkbox"/>
Agent status	<input type="checkbox"/>	<input type="checkbox"/>

Example report with tag-based access controls applied

Without tag-based access controls, all queues, routing profiles, and agents appear on the **Real-time metrics** page, as shown in the following image.

Many queues, routing profiles, and agents are displayed.

Queues									
Name	Agents							Contacts	
	Online	On contact	NPT	ACW	Error	Available	Availability	Active	In queue
Summary	3	0	0	0	0	3	4	0	
queue1	1	0	0	0	0	1	1	0	
queue2	1	0	0	0	0	1	1	0	
BasicQueue	1	0	0	0	0	1	2	0	

Routing profiles									
Name	Agents							Contacts	
	Online	On contact	NPT	ACW	Error	Available	Availability	Active	In queue
Summary	3	0	0	0	0	3	4	0	
routingProfile1	1	0	0	0	0	1	1	0	
routingProfile2	1	0	0	0	0	1	1	0	
Basic Routing Profile	1	0	0	0	0	1	2	0	

Agents									
Agent Login	Channels	Agent				Agent Hierarchy	Routing Profile	Capacity	
		Activity	Next activity	Duration	Availability				
user1	Voice	Available	-	00:08:52	-	routingProfile1	1		
user2	Voice	Available	-	00:08:34	-	routingProfile2	1		
userUnderTest	All channels	Available	-	05:57:26	-	Basic Routing Profile	2		
	Chat total								
	Task								
admin	All channels	Offline	-	00:00:24	-	Basic Routing Profile	2		
	Voice								
	Chat total								
	Task								

With tag-based access controls, a limited set of queues, routing profiles, and agents appear on the **Real-time metrics** page, as shown in the following image.

Only tagged queues, routing profiles, and agents are displayed.

Queues									
Name	Agents							Contacts	
	Online	On contact	NPT	ACW	Error	Available	Availability	Active	In queue
queue1	1	0	0	0	0	1	1	0	

Routing profiles									
Name	Agents							Contacts	
	Online	On contact	NPT	ACW	Error	Available	Availability	Active	In queue
routingProfile1	1	0	0	0	0	1	1	0	

Agents									
Agent Login	Channels	Agent				Agent Hierarchy	Routing Profile	Capacity	
		Activity	Next activity	Duration	Availability				
user1	Voice	Available	-	00:06:15	-				

How often real-time metrics refresh

Data in real-time metrics reports is refreshed as follows:

- The **Real-time metrics** page refreshes every 15 seconds, as long as the page is active. For example, if you have multiple tabs open in your browser and navigate to a different tab, the real-time metric page won't be updated until you return to it.
- Metrics such as **Active** and **Availability** refresh as activity occurs, with a small system delay for processing the activity.

- Agent near real-time metrics, such as **Missed** and **Occupancy**, refresh as activity occurs, with a small delay for processing.
- Contact near real-time metrics refresh about a minute after a contact ends.

Use one-click drill-downs for Routing profiles and Queues tables

In real-time metrics reports, for **Routing profiles** and **Queues** tables, you can open pre-filtered tables that display the associated queues, routing profiles, or agents. These one-click filters provide a way for you to drill into the performance data.

Example 1: Queues table -> Routing profiles table -> Agents table

For example, at a **Queues** table, choose the dropdown and then choose **View routing profiles**, as shown in the following image.

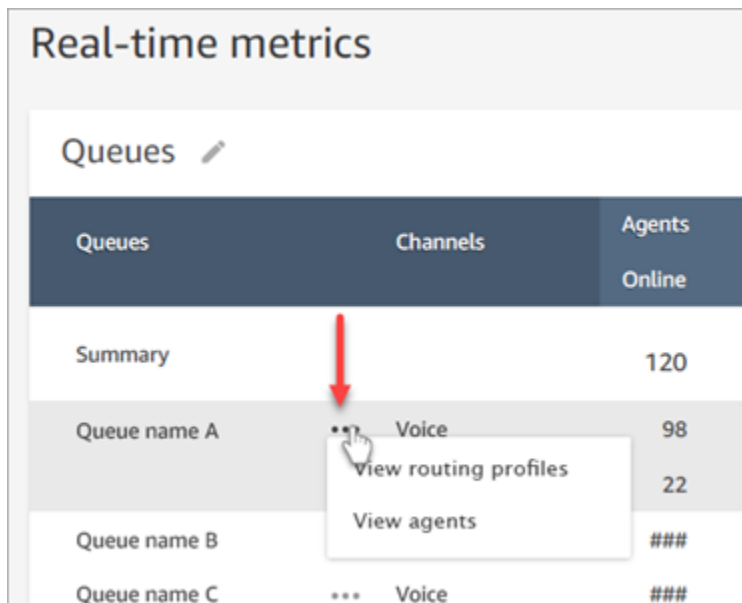

The screenshot shows a table titled "Real-time metrics" with a sub-header "Queues". The table has three columns: "Queues", "Channels", and "Agents". The "Agents" column is further divided into "Online" and "Offline" (indicated by "###"). A red arrow points to a dropdown menu for "Queue name A". The dropdown menu has three options: "Voice" (98), "View routing profiles" (22), and "View agents" (###).

Queues	Channels	Agents
Summary		120
Queue name A	*** Voice	98
	View routing profiles	22
	View agents	###
Queue name B		###
Queue name C	*** Voice	###

Below the **Queues** table, a **Routing profiles** table appears, as shown in the following image. It is filtered to display only the routing profiles associated with the queue. On the **Routing profiles** table, you can choose quick filters to display queues or agents *only associated with that routing profile*.

The screenshot displays the 'Real-time metrics' dashboard. It features two main tables: 'Queues' and 'Routing profiles'. The 'Queues' table has columns for 'Queues', 'Channels', and 'Agents' (Online, On contact). A callout box highlights 'Queue name A' and points to a dropdown menu with the text 'Routing profiles for Queue name A'. The 'Routing profiles' table has columns for 'Routing profiles', 'Channels', and 'Agents' (Online, On contact). A callout box points to a dropdown menu with the text 'Choose to display queues or agents only associated with this routing profile.'

Queues				
Queues	Channels	Agents		
		Online	On contact	
Summary		120	112	
Queue name A	Voice	98	98	
	Chat	22	14	
Queue name B		###	###	
Queue name C		###	###	

Routing profiles				
Routing profiles	Channels	Agents		
		Online	On contact	
Summary			112	
RP name A	Voice	98		
	Chat	22	14	
RP name B	Voice	###	###	

Example 2: Queues table -> Agents table

At the **Queues** table, choose **View agents**. Below the **Queues** table, an **Agents** table appears. It is filtered to display all the agents working that queue, as shown in the following image. The agents may be associated with different routing profiles.

Real-time metrics

Queues ✎

Queues	Channels	Agents	
		Online	On contact
Summary		120	112
Queue name A	... Voice	98	98
	View routing profiles	22	14
Queue name B	View agents	###	###
Queue name C	... Voice	###	###

Lists agents working this queue. The agents are assigned to different routing profiles.

Agents ✎

Agent login	Channels	Agents				Routing profile
		Activity	Duration	Agent hierarchy		
loginname_a	All channels	On contact	01:15:01	US/ West/ Dept A	RP name A	
	Voice					
	Chat total					
	Chat					
loginname_b	Voice	On contact	00:02:32	US/ West/ Dept A	RP name B	
loginname_c	All channels	Error	00:28:13	US/ West/ Dept A	RP name B	
	Voice					

Example 3: Queues table -> Steps table

At the **Queues** table, choose **View Steps**. Below the **Queues** table, a **Steps** table appears. It is filtered to display all the routing steps that are being used on active contacts in that queue, as shown in the following image.

Real-time Metrics

Queues

Name	Agents	
	Online	On contact
BasicQueue	0	0

Note: Only queues for which routing profiles are defined during the report time range.

View agents
View routing profiles
View queue graphs
View steps

Routing step expressions - Queues: BasicQueue 45 / 127

Time range: trailing previous 2 hours

Name	Contacts			Performance							
	Available	Availability	Active	Step Joined %	Step Expired %	Step Contact Queued	In queue	Oldest	Handled	Abandoned	AHT
Location:WA 1	0	0	0	-	-	-	1	00:00:36	-	-	-

Rows per page 10 0-0 of 0

Visualize: Queue dashboard

You can visualize historical queue data using time series graphs to help identify patterns, trends, and outliers such as Service Level, Contacts Queued, and Average Handle Time.

To view queue data

1. On the **Real-time Metrics** page, display the Queues table.
2. Select **View queue graphs** from the dropdown menu. The following image shows the dropdown menu for a queue named **test queue**.

Real-time Metrics

Queues

Name	Agents	
	Online	On contact
test queue	1	0

Note: Only queues for which routing profiles are defined during the report time range.

New table

View agents
View routing profiles
View queue graphs

3. After you select **View queue graphs**, you are directed to the queue visualization dashboard.
4. The Queue dashboard automatically refreshes every 15 minutes. You can:

- Configure a time range of up to 24 hours.
- Select the channel of your choice.
- Customize the service level thresholds.

The following image shows an example Queue dashboard. It displays a graph of service level data for the queue. **Time range** is set to **Previous 24 hours to future 24 hours**. **Channel** is set to **All channels**. **Service level** is set to **60 seconds**.

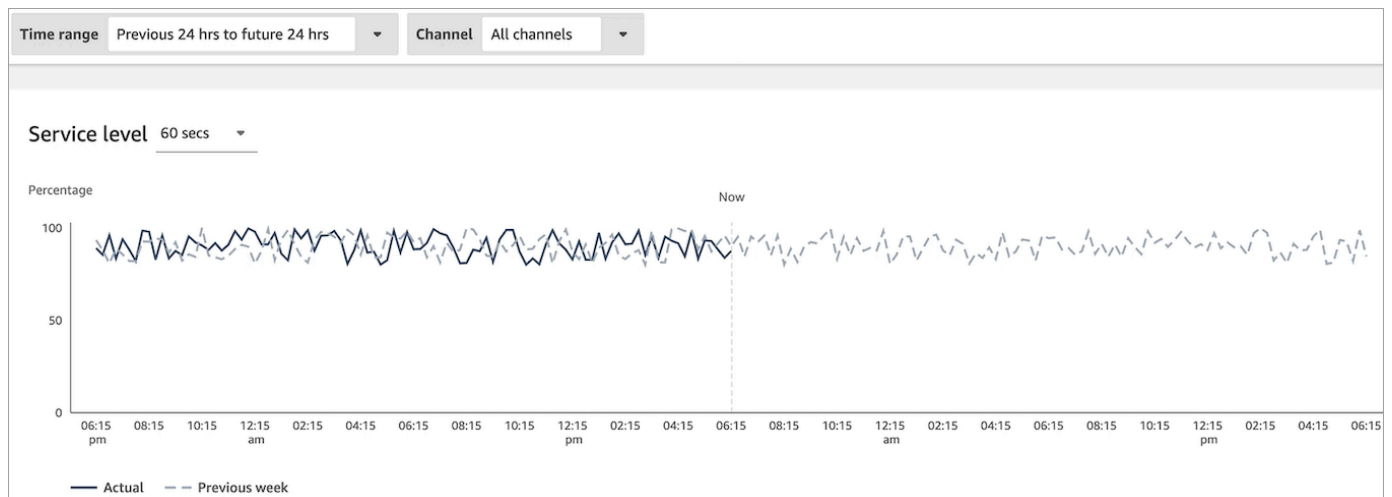

View how many contacts are waiting in queue

To see the number of customers waiting in queue

1. Go to **Analytics and optimization, Real-time metrics, Queues**.
2. On the **Real-time metrics** page, **Queues** table, view the data in the **In queue** column.

In queue shows the count of all customers who are in waiting a queue for an agent, including the callback customers.

Real-time metrics													
Last Update: Feb 17, 2021 12:05:41 PM													
Save													
Queues													
Queues	Agents						Contacts			Performance			
	Online	On contact	NPT	ACW	Error	Available	Availability	Active	In queue	Oldest	Scheduled	Queued	Handled
Summary	1	0	0	0	0	1	2	0	1	00:00:02	0	-	-
BasicQueue	0	0	0	0	0	0	0	0	1	00:00:02	0	-	-
Jane Doe's queue	1	0	0	0	0	1	2	0	0	00:00:00	0	-	-

View how many contacts are in an agent's queue

To see how many contacts are in an agent's personal queue, add an **Agent queues** table to your **Real-time metrics, Queues** report. Then view these two metrics:

- **In Queue**—how many contacts are in an agent's personal queue.
- **Queued**—the number of contacts added to their personal queue during the specified time range.

Use the following procedure.

1. Go to **Analytics and optimization, Real-time metrics, Queues**.
2. Choose **New table, Agent queues** as shown in the following image.

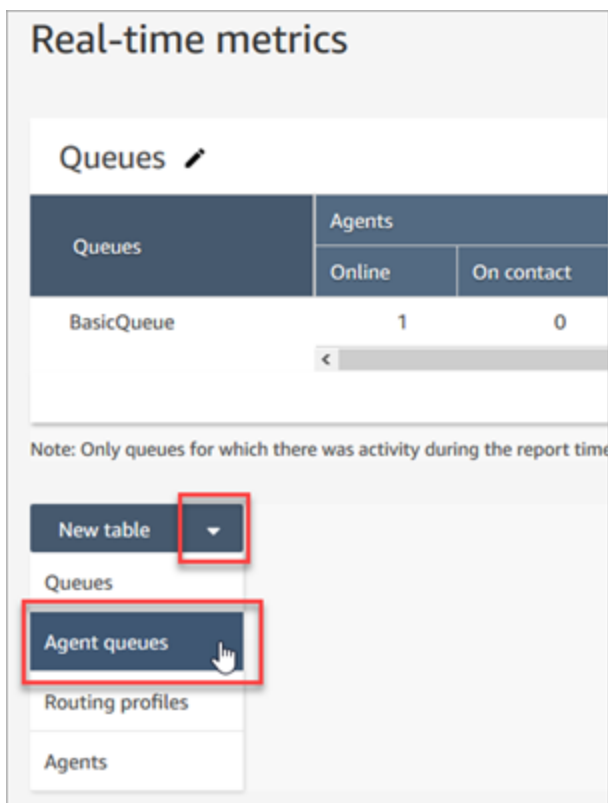

The **In queue** column displays how many contacts are in the agent's queue.

3. Review the metrics in then **In queue** and **Queue** columns.

Tip

An agent is included in the **Agent queues** table only if they are online or there is at least one contact in the their queue.

Add In Queue and Queue to the Agent queue table

If **In queue** or **Queue** don't appear in your **Agent queue** table, use the following steps to add them.

1. On the **Agent queues** table, choose **Settings**, as shown in the following image.

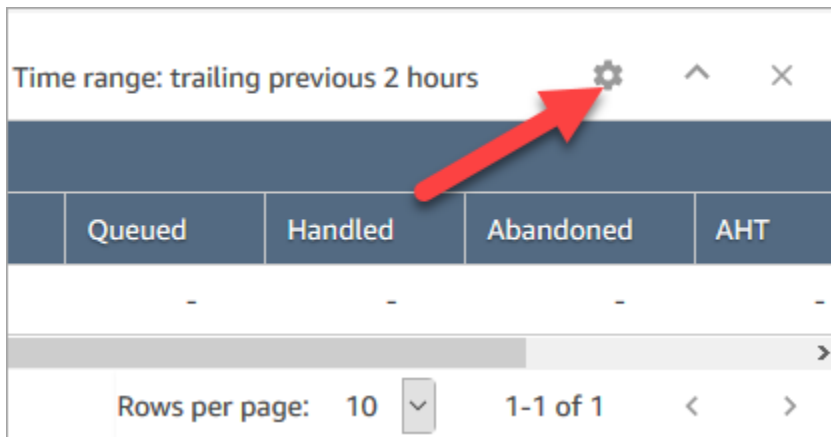

Time range: trailing previous 2 hours			
Queued	Handled	Abandoned	AHT
-	-	-	-

2. Choose the **Metrics** tab.
3. Scroll to the **Performance** section and choose **In queue** and **Queued**, and then **Apply**, as shown in the following table.

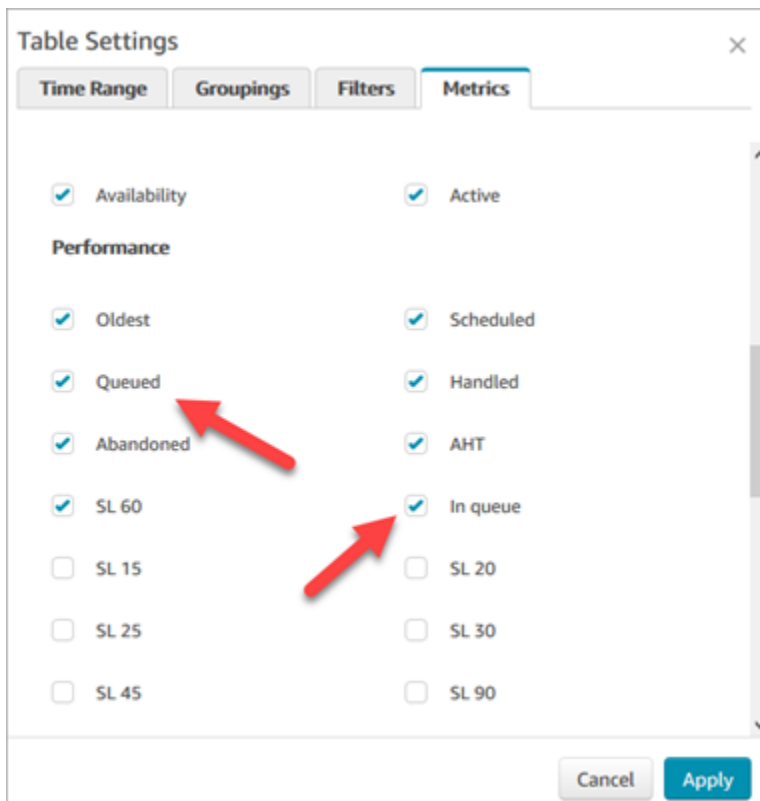

The changes appear in your table immediately.

4. Choose **Save** to add this report to your list of Saved reports.

View how many contacts are waiting for a callback

To see only the number of customers who are waiting for a call back, you need to create a queue that only takes callback contacts. To learn how to do this, see [Set up routing](#).

Currently there isn't a way to see the phone numbers of the contacts waiting for callbacks.

Create a real-time metrics report

You can create a real-time metrics report to view real-time or near-real time metrics data for activity in your contact center. You must have permission to access metric data. The **CallCenterManager** and **QualityAnalyst** security profiles include this permission. For more information, see [Security profiles](#).

To create a real-time metrics report

1. Log in to the Amazon Connect admin website at https://instance_name.my.connect.aws/.

2. Choose **Analytics and optimization, Real-time metrics**.
3. Choose one of the following report types. They group and order the data in different ways and include different metrics by default.
 - **Queues**
 - **Agents**
 - **Routing profiles**
4. To add another report to the page, choose **New table** and then choose a report type. You can add multiple reports of the same report type.

There's no limit to the number of tables you can add, but you might start experiencing performance issues if you add a lot of them.

5. To customize a report, choose the gear icon from its table.
6. On the **Time Range** tab, do the following:
 - a. For **Trailing windows for time**, select the time range, in hours, for the data to include in the report.
 - b. (Optional) If you select **Midnight to now**, the time range is from midnight to the current time, based on the **Time Zone** that you select. If you select a time zone other than the one you are currently in, the time range starts at midnight for the calendar day in that time zone, not your current time zone.
7. (Optional) On the **Filters** tab, specify filters to scope the data to be included in the report. The available filters depend on the report type. The following are the possible filters:
 - **Agents**—Includes data only for the agents that you select from **Include**.
 - **Agent Hierarchies**—Includes data only for the agent hierarchies that you select from **Include**.
 - **Queues**—Includes data only for the queues that you select from **Include**.
 - **Routing profiles**—Includes data only for the routing profiles that you select from **Include**.
8. On the **Metrics** tab, choose the metrics and fields to include in the report. The available metrics and fields depend on the report type and filters that you select. For more information, see [Real-time metrics definitions](#).
9. When you are finished customizing the report, choose **Apply**.
10. (Optional) To save your report for future reference, choose **Save**, provide a name for the report, and then choose **Save**.

To view your saved real-time metrics reports, choose **Analytics and optimization, Dashboards and reports**, and then choose the **Real-time metrics** tab.

No metrics or too few rows in a queues report?

It's possible to run a manually configured queues report and have no metrics returned, or fewer rows than expected.

This is because a queues report only includes data for a maximum of 100 queues, using one row per queue. If a queue doesn't have any activity* during the time range for the report, it's excluded from the report rather than included with null values. This means that if you create a report, and there is no activity for any of the queues included in the report, your report will not include any data.

This applies to the `GetCurrentMetricsData` API as well. This means that if a queue is not considered active, if you query for its metrics using the API you won't get any data.

Tip

*Here's how we define whether a queue is active: there's at least one contact in queue or there's at least one online agent for that queue. Otherwise, it's considered inactive. Real-time metrics reports do not include agents who have been inactive for approximately the past 5 minutes. For example, after the agent changes their CCP status to **Offline**, their username continues to appear in the Real-time metrics report for another approximately 5 minutes. At the 5 minute point, the agent no longer appears in the report.

In the following situations, you could end up with no metrics or fewer rows than expected:

1. You're attempting to run a report with no filters or groupings, and have more than 100 queues in your instance. The report pulls metrics for the first 100 queues, and then displays only those that are active.
2. You're attempting to run a report with filters and groupings, but it still has more than 100 queues matching that criteria. To process this request, Amazon Connect applies all the specified filters and groupings. This pulls the first 100 queues matching that criteria. Then out of those queues, it displays only the active ones.

For example, let's say you have 300 queues in your instance. Of these, 200 match your criteria; 100 are active and by coincidence all happen to be Queues #100-#200. When you run the report, you'd get just 1 row (Queue #100) since the other 99 queues that were returned (Queues #1-#99) were considered inactive and were not displayed.

3. You're running a report with fewer than 100 queues. While you may expect to see metrics for all filtered queues, only active queues are shown on the real-time metrics report page. Try changing the settings for the report, such as changing the time range.

List queues grouped by routing profile

1. Go to **Analytics and optimization, Real-time metrics, Queues**.
2. Click **Settings**.

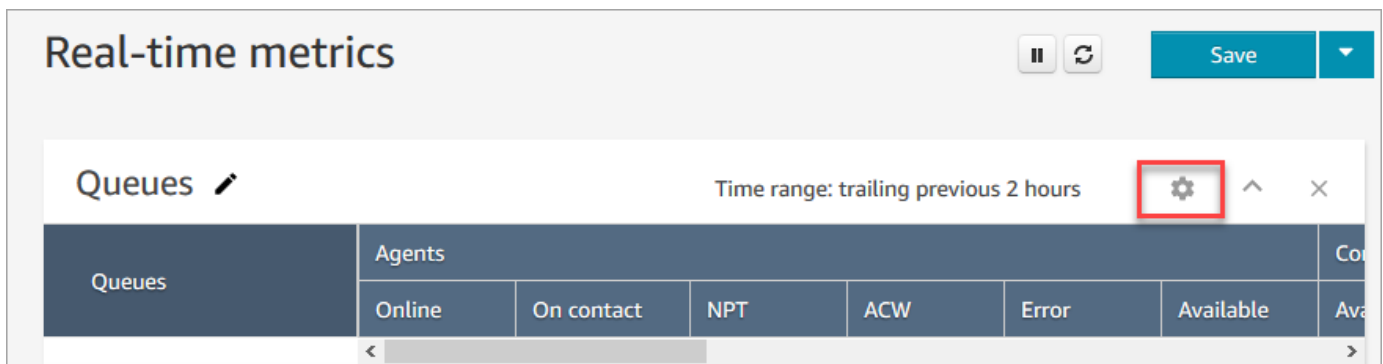

3. On the **Groupings** tab, choose **Queues grouped by routing profiles**.
4. Choose **Apply**.

List agents grouped by routing profile

1. Go to **Analytics and optimization, Real-time metrics, Queues**.
2. Choose **New table, Agents**.
3. Click **Settings**, as shown in the following image.

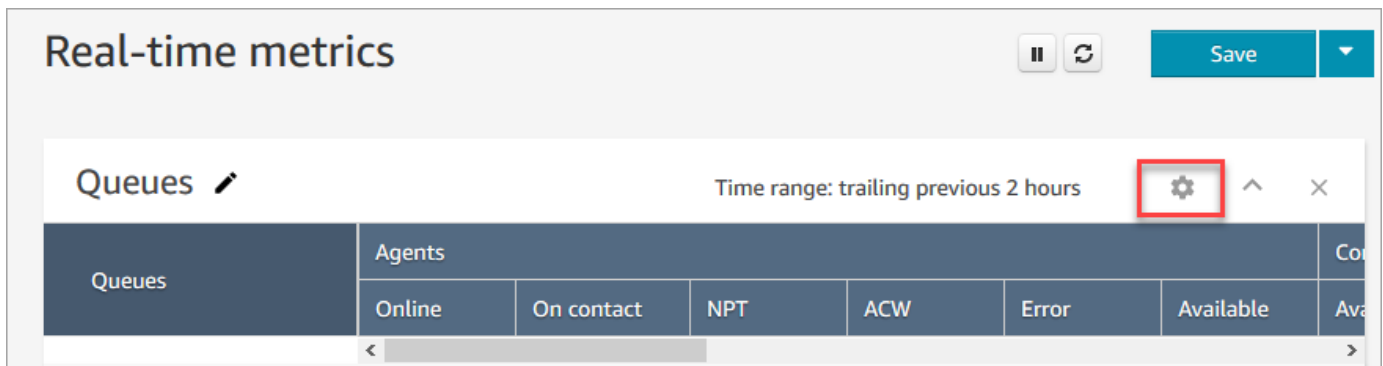

- On the **Filters** tab, choose **Routing profiles** from the **Filter primary groupings by** dropdown list. In **Include**, select the routing profiles you want included in the table, as shown in the following image.

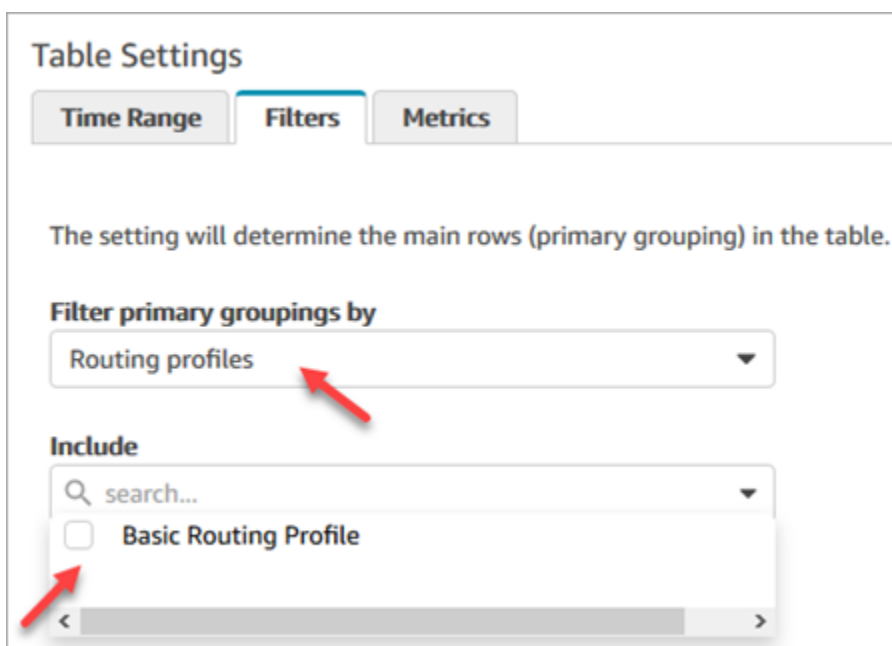

- Choose **Apply**.

Sort agents by activity in a real-time metrics report

On the real-time metrics **Agents** report, you can sort agents by **Activity** when agents are enabled to use the same channel.

For example, the following image shows that you can sort agents by the **Activity** column because all the agents are enabled to use the same channel: voice.

Channels	Agent			
	Activity	Duration	Agent Hierarchy	Routing Profile
Voice	Available ▾	00:02:51	-	Basic Routing Profile
Voice	Available ▾	00:10:59	-	All
Voice	Offline ▾	00:00:15	-	transfer-test

However, if one or more agents are enabled to handle voice, chat, and tasks—or any two of the channels—you can't sort them by the **Activity** column because of the multiple channels. In this case, there's no option to sort by the **Activity** column, as shown in the following image:

Agents ✎				
Agent Login	Channels	Agent		
		Activity	Duration	Ag
Ac: [redacted]	Voice	General Admin ▾	00:10:18	
Ag: [redacted]	Voice	Manager ▾	00:05:18	
Al: [redacted]	Voice	TOC [redacted] ▾	04:47:06	
BAg: [redacted]	All channels	Web & Smart ▾	00:06:59	
	Voice			
	Chat			
Bsy: [redacted]	Voice	TOC [redacted] ▾	00:33:29	

Note

The real-time metrics Agents report doesn't support secondary sorting. For example, you can't sort by **Activity**, and then sort by **Duration**.

Change the "Agent activity" status in a real-time metrics report

Agents manually set their status in the Contact Control Panel (CCP). However, on the real-time metrics report, managers can manually change the **Agent Activity** status of an agent. This overrides what the agent has set in the CCP.

The value that's displayed in the **Agent Activity** column can be either:

- The agent's availability status, such as **Offline**, **Available**, or **Break**.
- The contact state, such as **Incoming** or **On contact**.

When you choose the **Agent Activity** column, you can select and change an agent's *availability status*, such as **Offline**, **Available**, or **Break**. The following image shows an example where only the **Available** status is in the dropdown list of the **Activity** column.

The screenshot shows the 'Agents' page with a table. The table has columns for 'Agent Login', 'Channels', and 'Agent'. The 'Agent' column is further divided into 'Activity' and 'Next activity'. For the agent 'John', the 'Activity' is 'Offline'. A dropdown menu is open, showing 'Available' as the selected option. A red box highlights the dropdown arrow.

Agent Login	Channels	Agent	
		Activity	Next activity
John	All channels	Offline	
	Voice	Available	
	Chat total		

This change appears in the agent event stream.

However, when a *contact state* is displayed in the **Agent Activity** column, such as **Incoming** or **On contact**, you cannot change it to **Available** or **Offline**, for example, even though those options are displayed in the dropdown menu, as shown in the following image. This means you can't set the agent's next status while they are on a contact.

The screenshot shows the 'Agents' page with a table. The table has columns for 'Agent Login', 'Channels', and 'Agent'. The 'Agent' column is further divided into 'Activity' and 'Next activity'. For the agent 'johndoe', the 'Activity' is 'On contact'. A dropdown menu is open, showing 'Available' and 'Offline' as options. A red arrow points to the 'Available' option.

Agent Login	Channels	Agent	
		Activity	Next activity
johndoe	All channels	On contact	-
	Voice	Available	
	Chat total		
	Task		

You'll get an error message that says *Error changing agent status*, as shown in the following image.

The screenshot shows the 'Agents' page with a table. The table has columns for 'Agent Login', 'Channels', and 'Agent'. The 'Agent' column is further divided into 'Activity', 'Next activity', and 'Duration'. For the agent 'johndoe', the 'Activity' is 'On contact'. A dropdown menu is open, showing 'Available' and 'Offline' as options. A red arrow points to the error message 'Error changing agent status:' above the table.

Agent Login	Channels	Agent		
		Activity	Next activity	Duration
johndoe	All channels	On contact	-	00:00:31
	Voice	Available		
	Chat total			
	Task			

Note

The Real-time metrics report does not display who changed the agent's status.

Required permissions to change an agent's activity status

For someone such as a manager to be able to change an agent's activity status, they need to be assigned a security profile that has the following permissions:

- View - Agent Status
- Access metrics

The **Agent status - View** permission is shown in the following image of the **Users and permissions** section of the security profile page.

Users and permissions ⓘ			
Type	All	View	Edit
Users	<input type="checkbox"/>	<input type="checkbox"/>	<input type="checkbox"/>
Agent hierarchy	<input type="checkbox"/>	<input type="checkbox"/>	<input type="checkbox"/>
Security profiles	<input type="checkbox"/>	<input type="checkbox"/>	<input type="checkbox"/>
Agent status	<input type="checkbox"/>	<input checked="" type="checkbox"/>	<input type="checkbox"/>

The **Access metrics - Access** permission is shown in the following image of the **Analytics and Optimization** section of the security profile page.

Analytics and Optimization ⓘ			
Type	All	Access	View
Access metrics	<input type="checkbox"/>	<input checked="" type="checkbox"/>	<input type="checkbox"/>
Real-time metrics ⓘ	<input type="checkbox"/>	<input checked="" type="checkbox"/>	<input type="checkbox"/>
Historical metrics ⓘ	<input type="checkbox"/>	<input checked="" type="checkbox"/>	<input type="checkbox"/>
Agent activity audit ⓘ	<input type="checkbox"/>	<input checked="" type="checkbox"/>	<input type="checkbox"/>

Download a real-time metrics report

You can download the data included in your report as a comma-separated value (CSV) file so that you can use it with other applications. If there is no data for one of the selected metrics, the field in the downloaded CSV file contains a dash.

All exported times are in seconds.

To download a real-time metrics report as a CSV file

1. Create the report.
2. Choose the down arrow next to **Save** in the top-right corner of the page and choose **Download CSV**.
3. When prompted, confirm whether to open or save the file.

The following image shows real-time metrics in a Queue table. All times in the online report are in hours:minutes:seconds (hh:mm:ss). Below the image of the Queue table, there is an image of the same data in a downloaded CSV file opened with Excel. All times in the downloaded report are in seconds.

Queue	Agent on contact time	Agent idle time	Average after contact work time
BasicQueue	186:15:05	49:24:56	46:32:42
DeviceIssue	00:02:02	00:17:24	00:02:01
NetworkIssue	172:40:41	00:17:24	86:20:25
PasswordReset	00:02:40	00:17:24	00:00:21

All times in the online report are in hh:mm:ss.

	A	B	D
1	Queue	Agent on contact time	Agent idle time
2	BasicQueue	670505	177896
3	DeviceIssue	122	1044
4	NetworkIssue	621641	1044
5	PasswordReset	160	1044

All times in the downloaded report are in seconds.

You can convert the seconds to minutes using an Excel formula. Alternatively, if you have a short report, you can copy and paste the data from Amazon Connect to Excel and it will preserve the format.

Historical metrics reports

Historical metrics reports include data about past, completed activity and performance in your contact center. Amazon Connect includes built-in historical reports that you can start using right away. You can also build your own custom reports.

When creating and analyzing your historical metrics reports, keep in mind that there are two categories of metrics:

Contact record-driven metrics

These metrics are based on formed contact record records. For a given interval, contact records whose disconnect date falls in the interval are selected to calculate metrics. For example, if a contact starts at 05:23 and ends at 06:15, this contact contributes 52 minutes of metrics for the 06:00-06:30 interval.

Example contact record-driven metrics are **Service level**, **Agent interaction time**, and **After contact work time**.

Agent activity-driven metrics

These metrics are based on agent activities, like agent status changes, agent conversation changes. The metrics reflect on the actual time the activity happens. For example, if agent handles a contact from 05:23 to 06:15, the **Agent on contact time** has 7 minutes for the 05:00-05:30 interval, 30 minutes for the 05:30-06:00 interval, and 15 minutes for the 06:00-06:30 interval.

For example, an agent activity-driven metric is **Non-Productive Time**.

You can customize the report settings to get the view of the data that is most meaningful for your organization. You can change the time frame for the report, which metrics are included in the report, and how data is grouped in the report. After you have customized a report, you can save it for future reference. You can generate a report using a recurring schedule that you define.

Contents

- [Historical metrics definitions](#)
- [Permissions required to view historical metrics reports](#)
- [Apply tag-based access control to historical metrics reports](#)
- [Create a historical metrics report](#)
- [Historical report limits](#)
- [Schedule a historical metrics report](#)
- [Update a historical metrics report](#)
- [Download a historical metrics report](#)
- [Show agent queues in a Queues table](#)
- [How many contacts in queue on a specific date](#)
- [Agent activity audit report](#)

Historical metrics definitions

The following metrics are available to include in historical metrics reports in Amazon Connect unless otherwise noted.

Developers can use the [GetMetricDataV2](#) and [GetMetricData](#) APIs to get a subset of the following historical metrics from the specified Amazon Connect instance.

Tip

We recommend using the [GetMetricDataV2](#) API. It provides more flexibility, features, and the ability to query longer time ranges than `GetMetricData`. Use it to retrieve historical agent and contact metrics for the last 3 months, at varying intervals. You can also use it to build custom dashboards to measure historical queue and agent performance. For example, you can track the number of incoming contacts for the last 7 days, with data split by day, to see how contact volume changed per day of the week.

Abandonment rate

The percent of queued contacts that were disconnected without being connected to an agent. Contacts queued for callback are not counted as abandoned.

In the [GetMetricDataV2](#) API, this metric can be retrieved by using ABANDONMENT_RATE.

Type: String (*hh:mm:ss*)

Min value: 0.00%

Max value: 100.00%

Category: contact record-driven metric

Adherence

This metric is available only in AWS Regions where [Forecasting, capacity planning, and scheduling](#) is available.

The percentage of time that an agent correctly follows their schedule. This is measured by tracking if an agent is in an *Available* agent status when they should be in productive state. This percentage is calculated as follows:

$$\text{Adherence \%} = ((\text{Total Adherent Minutes}) / \text{Total Scheduled Adherence Minutes})$$

An agent is considered adherent if the agent is in an *Available* status, when the shift activity is *Productive*, or if the agent is in *Non-Productive* status (for example, a custom status), when the shift activity is *Non-Productive*. Otherwise the agent is considered non-adherent. This means that if a shift activity is named *Lunch* but marked as productive, the agent is considered adherent if they are in the *Available* agent status.

In the [GetMetricDataV2](#) API, this metric can be retrieved by using AGENT_SCHEDULE_ADHERENCE.

Type: String

Min value: 0.00%

Max value: 100.00%

Category: Agent activity-driven metric

Note

Any time you change the schedule, Schedule Adherence is re-calculated up to 30 days in the past from the current date (not the date of the schedule), if schedules are changed.

Adherent time

This metric is available only in AWS Regions where [Forecasting, capacity planning, and scheduling](#) is available.

The total time an agent was in an *Available* status when their shift activity is productive or was in non-productive status when the shift activity is non-productive.

In the [GetMetricDataV2](#) API, this metric can be retrieved by using AGENT_ADHERENT_TIME.

Type: String

Category: Agent activity-driven metric

After contact work time

The total time that an agent spent doing ACW for a contact. In some businesses, also known as Call Wrap Up time.

You specify the amount of time an agent has to do ACW in their [agent configuration settings](#). When a conversation with a contact ends, the agent is automatically allocated to do ACW for the contact. They stop doing ACW for a contact when they indicate they are ready for another contact in the CCP.

In the [GetMetricData](#) API, this metric can be retrieved by using AFTER_CONTACT_WORK_TIME.

In the [GetMetricDataV2](#) API, this metric can be retrieved by using SUM_AFTER_CONTACT_WORK_TIME.

Type: String (*hh:mm:ss*)

Category: contact record-driven metric

Agent answer rate

Percentage of contacts routed to an agent that were answered.

In the [GetMetricDataV2](#) API, this metric can be retrieved by using AGENT_ANSWER_RATE.

Type: String

Min value: 0.00%

Max value: 100.00%

Category: Agent activity-driven metric

Agent API connecting time

The total time between when a contact is initiated using an Amazon Connect API, and the agent is connected.

In the [GetMetricDataV2](#) API, this metric can be retrieved by using `SUM_CONNECTING_TIME_AGENT` with a [MetricFilters](#) parameter set as follows:

- `MetricFilterKey = INITIATION_METHOD`
- `MetricFilterValues = API`

Type: String (*hh:mm:ss*)

Category: Agent activity-driven metric

Agent callback connecting time

The total time between when a callback contact is initiated by Amazon Connect reserving the agent for the contact, and the agent is connected.

In the [GetMetricDataV2](#) API, this metric can be retrieved by using `SUM_CONNECTING_TIME_AGENT` with a [MetricFilters](#) parameter set as follows:

- `MetricFilterKey = INITIATION_METHOD`
- `MetricFilterValues = API`

Type: String (*hh:mm:ss*)

Category: Agent activity-driven metric

Agent first name

The first name of the agent, as entered in their Amazon Connect user account. This metric is available only when grouping by agent.

Type: String

Length: 1-255

Agent idle time

After the agent sets their status in the CCP to **Available**, this is the amount of time they weren't handling contacts + any time their contacts were in an Error state.

Agent idle time includes the amount of time from when Amazon Connect starts routing the contact to the agent to when the agent picks up or declines the contact. After an agent accepts the contact, the agent is no longer considered idle.

Note

This metric can't be grouped or filtered by queue. For example, when you create a historical metrics report and filter by one or more queues, Agent idle time is not displayed.

In the [GetMetricDataV2](#) API, this metric can be retrieved by using SUM_IDLE_TIME_AGENT.

Type: String (*hh:mm:ss*)

Category: Agent activity-driven metric

Agent incoming connecting time

The total time between when a contact is initiated by Amazon Connect reserving the agent for the contact, and the agent is connected.

In the agent event stream, this is the duration between the contact state of STATE_CHANGE event changes from CONNECTING to CONNECTED/MISSED/ ERROR.

In the [GetMetricDataV2](#) API, this metric can be retrieved by using SUM_CONNECTING_TIME_AGENT with a [MetricFilters](#) parameter set as follows:

- MetricFilterKey = INITIATION_METHOD
- MetricFilterValues = API

Type: String (*hh:mm:ss*)

Category: Agent activity-driven metric

Agent interaction and hold time

Sum of [Agent interaction time](#) and [Customer hold time](#).

In the [GetMetricDataV2](#) API, this metric can be retrieved by using SUM_INTERACTION_AND_HOLD_TIME.

Type: String (*hh:mm:ss*)

Category: contact record-driven metric

Agent interaction time

Total time that agents spent interacting with customers on inbound and outbound contacts. This does not include [Customer Hold Time](#), [After Contact Work Time](#), or agent pause duration (which applies only to tasks).

In the [GetMetricDataV2](#) API, this metric can be retrieved by using SUM_INTERACTION_TIME.

Type: String (*hh:mm:ss*)

Category: contact record-driven metric

Agent last name

The last name of the agent, as entered in their Amazon Connect user account. This metric is available only when grouping by agent.

Type: String

Length: 1-255

Agent name

The name of the agent, displayed as follows: **Agent last name, Agent first name**. This metric is available only when grouping by agent.

Agent non-response

The count of contacts routed to an agent but not answered by that agent, including contacts abandoned by the customer.

If a contact is not answered by a given agent, we attempt to route it to another agent to handle; the contact is not dropped. Because a single contact can be missed multiple times (including by the same agent), it can be counted multiple times: once for each time it is routed to an agent but not answered.

This metric appears as **Contacts missed** in scheduled reports and exported CSV files.

In the [GetMetricData](#) API, this metric can be retrieved by using CONTACTS_MISSED.

In the [GetMetricDataV2](#) API, this metric can be retrieved by using AGENT_NON_RESPONSE.

Type: Integer

Category: Agent activity-driven metric

Agent non-response without customer abandons

The count of contacts routed to an agent but not answered by that agent, excluding contacts abandoned by the customer.

If a contact is not answered by a given agent, Amazon Connect attempts to route it to another agent to handle; the contact is not dropped. Because a single contact can be missed multiple times (including by the same agent), it can be counted multiple times: once for each time it is routed to an agent but not answered.

In the [GetMetricDataV2](#) API, this metric can be retrieved by using AGENT_NON_RESPONSE_WITHOUT_CUSTOMER_ABANDONS.

Data for this metric is available starting from October 1, 2023 0:00:00 GMT.

Type: Integer

Category: Agent activity-driven metric

Agent on contact time

Total time that an agent spent on a contact, including [Customer Hold Time](#) and [After Contact Work Time](#). This does **not** include time spent on a contact while in a custom status or **Offline** status. (Custom status = the agent's CCP status is other than **Available** or **Offline**. For example, Training would be a custom status.)

Tip

If you want to include the time spent in a custom status and **Offline** status, see [Contact handle time](#).

In the [GetMetricDataV2](#) API, this metric can be retrieved by using SUM_CONTACT_TIME_AGENT.

Type: String (*hh:mm:ss*)

Category: Agent activity-driven metric

Agent outbound connecting time

Total time between when an outbound contact is initiated by Amazon Connect reserving the agent for the contact, and the agent is connected.

In the [GetMetricDataV2](#) API, this metric can be retrieved by using SUM_CONNECTING_TIME_AGENT with a [MetricFilters](#) parameter set as follows:

- MetricFilterKey = INITIATION_METHOD
- MetricFilterValues = API

Type: String (*hh:mm:ss*)

Category: Agent activity-driven metric

Agent talk time percent

The talk time by an agent in a voice conversation as a percent of the total conversation duration. To calculate this metric, Amazon Connect totals all the intervals in which an agent was engaged in conversation (talk time agent), and then divides this total by the total conversation duration.

In the [GetMetricDataV2](#) API, this metric can be retrieved by using PERCENT_TALK_TIME_AGENT.

Note

This metric is available only for contacts analyzed by Contact Lens conversational analytics.

- Type: Percent
- Category: Contact Lens driven metric

API contacts

The count of contacts that were initiated using an Amazon Connect API operation, such as `StartOutboundVoiceContact`. This includes contacts that were not handled by an agent.

Type: Integer

Category: contact record-driven metric

API contacts handled

The count of contacts that were initiated using an Amazon Connect API operation, such as `StartOutboundVoiceContact`, and handled by an agent.

In the [GetMetricData](#) API, this metric can be retrieved by using `API_CONTACTS_HANDLED`.

In the [GetMetricDataV2](#) API, this metric can be retrieved by using `CONTACTS_HANDLED` with a [MetricFilters](#) parameter set as follows:

- `MetricFilterKey = INITIATION_METHOD`
- `MetricFilterValues = API`

Type: Integer

Category: contact record-driven metric

Average active time

The average time, from start to finish, that an agent was working on a contact (average active time). It includes talk time, hold time, and After Contact Work (ACW) time. It applies to both inbound and outbound calls.

Average Active Time does not include any time spent in a custom status; Contact handle time (CHT) does include it.

In the [GetMetricDataV2](#) API, this metric this metric can be retrieved by using `AVG_ACTIVE_TIME`.

Type: String (*hh:mm:ss*)

Category: contact record-driven metric

Average agent pause time

Average time that contact got paused after being connected to agent during inbound and outbound contacts.

In the [GetMetricDataV2](#) API, this metric this metric can be retrieved by using `AVG_AGENT_PAUSE_TIME`.

Type: String (*hh:mm:ss*)

Category: contact record-driven metric

Average after contact work time

Average amount of time that an agent spent doing After Contact Work (ACW) for contacts. This is calculated by averaging [AfterContactWorkDuration](#) (from the contact record) for all contacts included in the report, based on the selected filters.

In the [GetMetricDataV2](#) API, this metric this metric can be retrieved by using `AVG_AFTER_CONTACT_WORK_TIME`.

Type: String (*hh:mm:ss*)

Category: contact record-driven metric

Average agent API connecting time

The average time between when a contact is initiated using an Amazon Connect API, and the agent is connected.

In the [GetMetricDataV2](#) API, this metric can be retrieved by using `AVG_AGENT_CONNECTING_TIME` with a [MetricFilters](#) parameter set as follows:

- `MetricFilterKey = INITIATION_METHOD`
- `MetricFilterValues = API`

Type: String (*hh:mm:ss*)

Category: Agent activity-driven metric

Average agent callback connecting time

The average time between when a callback contact is initiated by Amazon Connect reserving the agent for the contact, and the agent is connected.

In the [GetMetricDataV2](#) API, this metric can be retrieved by using `AVG_AGENT_CONNECTING_TIME` with a [MetricFilters](#) parameter set as follows:

- `MetricFilterKey = INITIATION_METHOD`
- `MetricFilterValues = CALLBACK`

Type: String (*hh:mm:ss*)

Category: Agent activity-driven metric

Average agent greeting time

This metric represents the average first response time of agents on chat, indicating how quickly they engage with customers after joining the chat. It is calculated by dividing the total time it takes for an agent to initiate their first response by the number of chat contacts.

In the [GetMetricDataV2](#) API, this metric can be retrieved by using `AVG_GREETING_TIME_AGENT`.

Note

This metric is available only for contacts analyzed by Contact Lens conversational analytics.

Type: String (*hh:mm:ss*)

Category: Contact Lens driven metric

Average agent incoming connecting time

The average time between when contact is initiated by Amazon Connect reserving the agent for the contact, and the agent is connected. This is the ring time for configurations where the agent is not set to auto-answer.

No equivalent to this metric is available in the `GetMetricData` API.

In the [GetMetricDataV2](#) API, this metric can be retrieved by using `AVG_AGENT_CONNECTING_TIME` with a [MetricFilters](#) parameter set as follows:

- `MetricFilterKey = INITIATION_METHOD`
- `MetricFilterValues = INBOUND`

Type: String (*hh:mm:ss*)

Category: Agent activity-driven metric

Average agent interaction and customer hold time

Average of the sum of the agent interaction and customer hold time. This is calculated by averaging the sum of the following values from the contact record: [AgentInteractionDuration](#) and [CustomerHoldDuration](#).

In the [GetMetricData](#) API, this metric can be retrieved by using `INTERACTION_AND_HOLD_TIME`.

In the [GetMetricDataV2](#) API, this metric can be retrieved by using `AVG_INTERACTION_AND_HOLD_TIME`.

Type: String (*hh:mm:ss*)

Category: contact record-driven metric

Average agent interaction time

Average time that agents interacted with customers during inbound and outbound contacts. This does not include [Customer Hold Time](#) or [After Contact Work Time](#).

In the [GetMetricData](#) API, this metric can be retrieved by using `INTERACTION_TIME`.

In the [GetMetricDataV2](#) API, this metric can be retrieved by using `AVG_INTERACTION_TIME`.

Type: String (*hh:mm:ss*)

Category: contact record-driven metric

Average agent interruptions

This metric quantifies the average frequency of agent interruptions during customer interactions by dividing the total number of agent interruptions by the total number of contacts.

In the [GetMetricDataV2](#) API, this metric can be retrieved by using `AVG_INTERRUPTIONS_AGENT`.

 **Note**

This metric is available only for contacts analyzed by Contact Lens conversational analytics.

Type: String (*hh:mm:ss*)

Category: Contact Lens driven metric

Average agent interruption time

Average of total agent interruption time while talking to a contact. Calculating the average duration of agent interruptions during contact conversations involves summing the interruption intervals within each conversation and dividing the total by the number of conversations that experienced at least one interruption.

In the [GetMetricDataV2](#) API, this metric can be retrieved by using `AVG_INTERRUPTION_TIME_AGENT`.

 **Note**

This metric is available only for contacts analyzed by Contact Lens conversational analytics.

Type: String (*hh:mm:ss*)

Category: Contact Lens driven metric

Average agent outbound connecting time

The average time between when an outbound contact is initiated by Amazon Connect reserving the agent for the contact, and the agent is connected.

In the [GetMetricDataV2](#) API, this metric can be retrieved by using `AVG_AGENT_CONNECTING_TIME` with a [MetricFilters](#) parameter set as follows:

- `MetricFilterKey = INITIATION_METHOD`

- `MetricFilterValues = OUTBOUND`

Type: String (*hh:mm:ss*)

Category: Agent activity-driven metric

Average agent talk time

Average time that was spent talking in a conversation by an agent. This is calculated by summing up the durations of all intervals during which the agent was speaking and then dividing that sum by the total number of contacts.

In the [GetMetricDataV2](#) API, this metric can be retrieved by using `AVG_TALK_TIME_AGENT`.

Note

This metric is available only for contacts analyzed by Contact Lens conversational analytics.

Type: String (*hh:mm:ss*)

Category: Contact Lens driven metric

Average case resolution time

The average amount of time spent to resolve a case during the provided time interval.

In the [GetMetricDataV2](#) API, this metric can be retrieved by using `AVG_CASE_RESOLUTION_TIME`.

Type: String (*hh:mm:ss*)

Category: Case driven metric

Average contact duration

The average duration of a contact is calculated by taking the difference between their initiation time and their disconnect time (from the contact record) and dividing it by the total number of contacts. This metric reflects the average amount of time a contact spends from the moment they initiate the interaction to when they disconnect.

In the [GetMetricDataV2](#) API, this metric can be retrieved by using `AVG_CONTACT_DURATION`.

Type: String (*hh:mm:ss*)

Category: Contact record-driven metric

Average contacts per case

The average number of contacts (calls, chat, and tasks) for cases created during the provided time interval.

In the [GetMetricDataV2](#) API, this metric can be retrieved by using `AVG_CASE_RELATED_CONTACTS`.

Type: String

Category: Case driven metric

Average conversation duration

The average conversation duration of voice contacts with agents is determined by calculating the total time from the start of the conversation until the last word spoken by either the agent or the customer. This value is then divided by the total number of contacts to provide an average representation of the conversation time spent on the call.

In the [GetMetricDataV2](#) API, this metric can be retrieved by using `AVG_CONVERSATION_DURATION`.

Note

This metric is available only for contacts analyzed by Contact Lens conversational analytics.

Type: String (*hh:mm:ss*)

Category: Contact Lens driven metric

Average customer hold time

Average time that customers spent on hold while connected to an agent. This is calculated by averaging [CustomerHoldDuration](#) (from the contact record).

In the [GetMetricData](#) API, this metric can be retrieved by using `HOLD_TIME`.

In the [GetMetricDataV2](#) API, this metric can be retrieved by using `AVG_HOLD_TIME`.

This average only includes contacts that went on hold.

Type: String (*hh:mm:ss*)

Category: contact record-driven metric

This metric doesn't apply to tasks so you'll notice a value of 0 on the report for them.

Average customer hold time all contacts

Average hold time for all contacts handled by an agent. The calculation includes contacts that were never put on hold.

In the [GetMetricDataV2](#) API, this metric can be retrieved by using `AVG_HOLD_TIME_ALL_CONTACTS`.

Type: String (*hh:mm:ss*)

Category: contact record-driven metric

Average customer talk time

Average time that was spent talking in a conversation by a customer. This is calculated by summing up the durations of all intervals during which the customer was speaking and then dividing that sum by the total number of contacts.

In the [GetMetricDataV2](#) API, this metric can be retrieved by using `AVG_TALK_TIME_CUSTOMER`.

Note

This metric is available only for contacts analyzed by Contact Lens conversational analytics.

Type: String (*hh:mm:ss*)

Category: Contact Lens driven metric

Average flow time

The average duration of flow for the specified start time and end time.

In the [GetMetricDataV2](#) API, this metric can be retrieved by using `AVG_FLOW_TIME`.

Data for this metric is available starting from April 22, 2024 0:00:00 GMT.

Type: String (*hh:mm:ss*)

Category: Flow driven metric

Average handle time

The average time, from start to finish, that a contact was connected with an agent (average handled time). It includes talk time, hold time, After Contact Work (ACW) time, custom status time, and agent pause duration (which applies only to tasks).

AHT is calculated by averaging the amount of time between the contact being answered by an agent and the conversation ending. It applies to both inbound and outbound calls.

In the [GetMetricData](#) API, this metric can be retrieved by using `HANDLE_TIME`.

In the [GetMetricDataV2](#) API, this metric can be retrieved by using `AVG_HANDLE_TIME`.

Type: String (*hh:mm:ss*)

Category: contact record-driven metric

Average holds

This metric determines the average number of times a voice contact was put on hold while interacting with an agent. It is calculated by dividing the total number of holds by the total number of contacts, providing an average representation of the number of holds experienced per contact.

In the [GetMetricDataV2](#) API, this metric can be retrieved by using `AVG_HOLDS`.

Type: String (*hh:mm:ss*)

Category: contact record-driven metric

Average non-talk time

Average of total non-talk time in a voice conversation. Non-talk time refers to the combined duration of hold time and periods of silence exceeding 3 seconds, during which neither the agent

nor the customer is engaged in conversation. To calculate non-talk time, we add up all the intervals in which both participants remained silent and then divide this total by the number of contacts.

In the [GetMetricDataV2](#) API, this metric can be retrieved by using `AVG_NON_TALK_TIME`.

 **Note**

This metric is available only for contacts analyzed by Contact Lens conversational analytics.

Type: String (*hh:mm:ss*)

Category: Contact Lens driven metric

Average outbound after contact work time

Average time that agents spent doing After Contact Work (ACW) for an outbound contact.

In the [GetMetricDataV2](#) API, this metric can be retrieved by using `AVG_AFTER_CONTACT_WORK_TIME` with a [MetricFilters](#) parameter set as follows:

- `MetricFilterKey` = `INITIATION_METHOD`
- `MetricFilterValues` = `OUTBOUND`

Type: String (*hh:mm:ss*)

Category: contact record-driven metric

Average outbound agent interaction time

Average time that agents spent interacting with a customer during an outbound contact.

In the [GetMetricDataV2](#) API, this metric can be retrieved by using `AVG_INTERACTION_TIME` with a [MetricFilters](#) parameter set as follows:

- `MetricFilterKey` = `INITIATION_METHOD`
- `MetricFilterValues` = `OUTBOUND`

Type: String (*hh:mm:ss*)

Category: contact record-driven metric

Average queue abandon time

Average time that contacts waited in the queue before being abandoned. This is calculated by averaging the difference between [EnqueueTimestamp](#) and [DequeueTimestamp](#) (from the contact record) for abandoned contacts.

A contact is considered abandoned if it was removed from a queue but not answered by an agent or queued for callback.

In the [GetMetricData](#) API, this metric can be retrieved by using ABANDON_TIME.

In the [GetMetricDataV2](#) API, this metric can be retrieved by using AVG_ABANDON_TIME.

Type: String (*hh:mm:ss*)

Category: contact record-driven metric

Average queue answer time

Average time that contacts waited in the queue before being answered by an agent. In some businesses, this is also known as average speed of answer (ASA).

Average queue answer time also includes the time during the agent whisper, because the contact remains in queue until the agent whisper is completed.

This is the average of [Duration](#) (from the contact record).

In the [GetMetricData](#) API, this metric can be retrieved by using QUEUE_ANSWER_TIME.

In the [GetMetricDataV2](#) API, this metric can be retrieved by using AVG_QUEUE_ANSWER_TIME.

Type: String (*hh:mm:ss*)

Category: contact record-driven metric

Average resolution time

The average time, beginning from the time a contact was initiated to the time it resolved. The resolution time for a contact is defined as: beginning from [InitiationTimestamp](#), and ending at [AfterContactWorkEndTimestamp](#) or [DisconnectTimestamp](#), whichever one is later.

In the [GetMetricDataV2](#) API, this metric can be retrieved by using `AVG_RESOLUTION_TIME` .

Type: String (*hh:mm:ss*)

Category: contact record-driven metric

Average talk time

Average time that was spent talking during a voice contact across either the customer or the agent. This is calculated by summing up all the intervals in which either an agent, a customer, or both were engaged in conversation, and then dividing it by the total number of contacts.

In the [GetMetricDataV2](#) API, this metric can be retrieved by using `AVG_TALK_TIME`.

Note

This metric is available only for contacts analyzed by Contact Lens conversational analytics.

Type: String (*hh:mm:ss*)

Category: Contact Lens driven metric

Callback attempts

The number of contacts where a callback was attempted, but the customer did not pick up.

In the [GetMetricDataV2](#) API, this metric can be retrieved by using `SUM_RETRY_CALLBACK_ATTEMPTS`.

Type: Integer

Category: contact record-driven metric

Callback contacts

The count of contacts that were initiated from a queued callback.

- Type: Integer
- Category: contact record-driven metric

Callback contacts handled

The count of contacts that were initiated from a queued callback and handled by an agent.

In the [GetMetricData](#) API, this metric can be retrieved by using CALLBACK_CONTACTS_HANDLED.

In the [GetMetricDataV2](#) API, this metric can be retrieved by using CONTACTS_HANDLED with a [MetricFilters](#) parameter set as follows:

- MetricFilterKey = INITIATION_METHOD
- MetricFilterValues = CALLBACK

Type: Integer

Category: contact record-driven metric

Cases created

The count of all cases created.

In the [GetMetricDataV2](#) API, this metric can be retrieved by using CASES_CREATED.

Type: Integer

Category: Case driven metric

Cases reopened

The number of times cases have been reopened.

In the [GetMetricDataV2](#) API, this metric can be retrieved by using REOPENED_CASE_ACTIONS.

Type: Integer

Category: Case driven metric

Cases resolved

The number of times cases have been resolved.

In the [GetMetricDataV2](#) API, this metric can be retrieved by using RESOLVED_CASE_ACTIONS.

Type: Integer

Category: Case driven metric

Cases resolved on first contact

The percent of cases that were resolved on the first contact (only including calls or chats). Cases that have been reopened and subsequently closed in the specified interval will contribute to this metric. If cases are reopened but not closed in the specified interval it will not contribute to this metric.

In the [GetMetricDataV2](#) API, this metric can be retrieved by using PERCENT_CASES_FIRST_CONTACT_RESOLVED.

Type: String

Min value: 0.00%

Max value: 100.00%

Category: Case driven metric

Contacts abandoned

The count of queued contacts disconnected without being connected to an agent. Contacts queued for callback are not counted as abandoned. When you create customized historical reports, to include this metric, on the **Groupings** tab choose either **Queue** or **Phone Number**.

In the [GetMetricData](#) and [GetMetricDataV2](#) APIs, this metric can be retrieved by using CONTACTS_ABANDONED.

- Type: Integer
- Category: contact record-driven metric

Contacts disconnected

Sum of contacts disconnected in a queue. The metric can be filtered by Disconnect Reason.

In the [GetMetricDataV2](#) API, this metric can be retrieved by using SUM_CONTACTS_DISCONNECTED.

- Type: Integer
- Category: contact record-driven metric

Contact flow time

Total time a contact spent in a flow.

Outbound contacts don't start in a flow, so outbound contacts aren't included.

In the [GetMetricDataV2](#) API, this metric can be retrieved by using SUM_CONTACT_FLOW_TIME.

- Type: String (*hh:mm:ss*)
- Category: contact record-driven metric

Contact handle time

Total time that an agent spent on contacts, including [Customer Hold Time](#) and [After contact work time](#). This includes any time spent on contacts while in a custom status. (Custom status = the agent's CCP status is other than **Available** or **Offline**. For example, Training would be a custom status.)

Note

Contact handle time includes any time the agent was **Offline** and made an outbound call, even if the call was personal.

Tip

If you want to exclude the amount of time spent in a custom status, see [Agent on contact time](#).

In the [GetMetricDataV2](#) API, this metric can be retrieved by using SUM_HANDLE_TIME

- Type: String (*hh:mm:ss*)
- Category: contact record-driven metric

Contacts abandoned in X seconds

The count of queued contacts disconnected without being connected to an agent for 0 to X seconds. The possible values for X are: 15, 20, 25, 30, 45, 60, 90, 120, 180, 240, 300, and 600.

In the [GetMetricDataV2](#) API, this metric can be retrieved by using CONTACTS_ABANDONED_IN_X. The API enables you to create custom duration to get this metric. Choose from additional durations, such as minutes, hours, or days. The maximum duration for a custom value is 7 days. That's because in Amazon Connect you can't have a contact that goes longer than 7 days.

- Type: Integer
- Category: contact record-driven metric

Contacts agent hung up first

The count of contacts disconnected where the agent disconnected before the customer.

In the [GetMetricData](#) API, this metric can be retrieved by using CONTACTS_AGENT_HUNG_UP_FIRST.

In the [GetMetricDataV2](#) API, this metric can be retrieved by using CONTACTS_HANDLED with a [MetricFilters](#) parameter set as follows:

- MetricFilterKey = DISCONNECT_REASON
- MetricFilterValues = AGENT_DISCONNECT

Type: Integer

Category: contact record-driven metric

Contacts answered in X seconds

The count of contacts that were answered by an agent between 0 and X seconds of being placed in the queue, based on the value of [EnqueueTimestamp](#). The possible values for X are: 15, 20, 25, 30, 45, 60, 90, 120, 180, 240, 300, and 600.

In the [GetMetricDataV2](#) API, this metric can be retrieved by using SUM_CONTACTS_ANSWERED_IN_X. The API enables you to create custom duration to get this

metric. Choose from additional durations, such as minutes, hours, or days. The maximum duration for a custom value is 7 days. That's because in Amazon Connect you can't have a contact that goes longer than 7 days.

- Type: Integer
- Category: contact record-driven metric

Contacts created

The count of contacts in a queue. The metric can be filtered by initiation methods.

In the [GetMetricDataV2](#) API, this metric can be retrieved by using CONTACTS_CREATED.

- Type: Integer
- Category: contact record-driven metric

Contacts consulted

Deprecated May 2019. When used in a report, it returns a dash (-).

The count of contacts handled by an agent who consulted with another agent in Amazon Connect. The agent interacts with the other agent, but the customer is not transferred to the other agent.

In the [GetMetricData](#) API, this metric can be retrieved by using CONTACTS_CONSULTED.

- Type: Integer
- Category: contact record-driven metric

Contacts handled

The count of contacts that were connected to an agent.

It doesn't matter how the contact got to the agent. It could be a customer calling your contact center, or an agent calling the customer. It could be a contact transferred from one agent to another. It could be a contact where the agent answered it, but then they weren't sure what to do and they transferred the contact away again. As long as the agent was connected to the contact, it increments **Contacts handled**.

Tip

Contacts handled is a contact record-driven metric, meaning it gets incremented when a contact disconnects. If you want to see the count of contacts handled as soon as a contact is connected to an agent, see [Contacts handled \(connected to the agent timestamp\)](#).

In the [GetMetricData](#) and [GetMetricDataV2](#) APIs, this metric can be retrieved by using CONTACTS_HANDLED.

Type: Integer

Category: contact record-driven metric

Contacts handled (connected to the agent timestamp)

The count of contacts that were connected to an agent, updated as soon as a contact is connected to an agent. **Contacts handled** is aggregated on the CONNECTED_TO_AGENT timestamp.

In the [GetMetricDataV2](#) API, this metric can be retrieved by using CONTACTS_HANDLED_BY_CONNECTED_TO_AGENT.

Data for this metric is available starting from January 12, 2024 0:00:00 GMT.

Type: Integer

Category: contact event-driven metric

Tip

Contact events are from a near real-time stream of contact (voice calls, chat, and task) events (for example, call is queued) in your Amazon Connect contact center. For more information, see [Amazon Connect contact events](#). If you want to see the count of contacts handled when a contact disconnects, see [Contacts handled](#).

Contacts handled incoming

The count of incoming contacts that were handled by an agent, including inbound contacts and transferred contacts. This includes contacts for all channels, such as voice, chat, tasks.

Note

Incoming **new** chats are not included in this metric. Only transferred chats (both agent transfers and queue transfers) are included.

In the [GetMetricData](#) API, this metric can be retrieved by using CONTACTS_HANDLED_INCOMING.

In the [GetMetricDataV2](#) API, this metric can be retrieved by using CONTACTS_HANDLED with a [MetricFilters](#) parameter set as follows:

- MetricFilterKey = INITIATION_METHOD
- MetricFilterValues = INBOUND, TRANSFER, QUEUE_TRANSFER

Type: Integer

Category: contact record-driven metric

Contacts handled outbound

The count of outbound contacts that were handled by an agent. This includes contacts that were initiated by an agent using the CCP.

In the [GetMetricData](#) API, this metric can be retrieved by using CONTACTS_HANDLED_OUTBOUND.

In the [GetMetricDataV2](#) API, this metric can be retrieved by using CONTACTS_HANDLED with a [MetricFilters](#) parameter set as follows:

- MetricFilterKey = INITIATION_METHOD
- MetricFilterValues = OUTBOUND

Type: Integer

Category: contact record-driven metric

Contacts hold agent disconnect

The count of contacts that were disconnected by the agent while the customer was on hold.

In the [GetMetricDataV2](#) API, this metric can be retrieved by using CONTACTS_ON_HOLD_AGENT_DISCONNECT.

- Type: Integer
- Category: contact record-driven metric

Contacts hold customer disconnect

The count of contacts that were disconnected by the customer while the customer was on hold.

In the [GetMetricDataV2](#) API, this metric can be retrieved by using CONTACTS_ON_HOLD_CUSTOMER_DISCONNECT.

- Type: Integer
- Category: contact record-driven metric

Contacts hold disconnect

The count of contacts disconnected while the customer was on hold. This includes both contacts disconnected by the agent and contacts disconnected by the customer.

In the [GetMetricData](#) and [GetMetricDataV2](#) APIs, this metric can be retrieved by using CONTACTS_HOLD_ABANDONS.

- Type: Integer
- Category: contact record-driven metric

Contacts incoming

The count of incoming contacts, including inbound contacts and transferred contacts.

- Type: Integer
- Category: contact record-driven metric

Contacts put on hold

The count of contacts put on hold by an agent one or more times.

In the [GetMetricDataV2](#) API, this metric can be retrieved by using CONTACTS_PUT_ON_HOLD.

- Type: Integer
- Category: contact record-driven metric

Contacts queued

The count of contacts placed in the queue.

Tip

Contacts queued is a contact record-driven metric, meaning it gets incremented when a contact disconnects. If you want to see the count of contacts queued as soon as a contact is enqueued, see [Contacts queued \(enqueue timestamp\)](#).

In the [GetMetricData](#) and [GetMetricDataV2](#) APIs, this metric can be retrieved by using CONTACTS_QUEUED.

- Type: Integer
- Category: contact record-driven metric

Contacts queued (enqueue timestamp)

The count of contacts placed in the queue, updated as soon as a contact is enqueued. **Contacts queued (enqueue timestamp)** is aggregated on the ENQUEUE timestamp.

In the [GetMetricDataV2](#) API, this metric can be retrieved by using CONTACTS_QUEUED_BY_ENQUEUE.

Data for this metric is available starting from January 12, 2024 0:00:00 GMT.

Type: Integer

Category: contact event-driven metric

Tip

Contact events are from a near real-time stream of contact (voice calls, chat, and task) events (for example, call is queued) in your Amazon Connect contact center. For more

information, see [Amazon Connect contact events](#). If you want to see the count of contacts queued when a contact disconnects, see [Contacts queued](#).

Contacts removed from queue in X seconds

This metric is available only by using the `GetMetricDataV2` API.

The count of contacts removed from the queue between 0 and X after being added to it. A contact is removed from a queue when the following occurs: an agent answers the contact, the customer abandons the contact, or the customer requests a call back.

For X you can choose from pre-set times in seconds: 15, 20, 25, 30, 45, 60, 90, 120, 180, 240, 300, and 600.

In the [GetMetricDataV2](#) API, this metric can be retrieved by using `CONTACTS_REMOVED_FROM_QUEUE_IN_X`.

Type: Integer

Category: contact record-driven metric

Contacts resolved in X

The count of contacts that have a resolution duration between 0 and X seconds after being initiated based on `InitiationTimestamp`. The resolution time for a contact is defined as: beginning from [InitiationTimestamp](#), and ending at [AfterContactWorkEndTimestamp](#) or [DisconnectTimestamp](#), whichever one is later.

You can create custom duration to get this metric. Choose from additional durations, such as minutes, hours, or days. The maximum duration for a custom value is 7 days. That's because in Amazon Connect you can't have a contact that lasts longer than 7 days.

In the [GetMetricDataV2](#) API, this metric can be retrieved by using `CONTACTS_RESOLVED_IN_X`.

Type: Integer

Category: contact record-driven metric

Contacts transferred in

The count of contacts transferred in from queue to queue, and transferred in by an agent using the CCP.

In the [GetMetricData](#) API, this metric can be retrieved by using CONTACTS_TRANSFERRED_IN.

In the [GetMetricDataV2](#) API, this metric can be retrieved by using CONTACTS_CREATED with a [MetricFilters](#) parameter set as follows:

- MetricFilterKey = INITIATION_METHOD
- MetricFilterValues = TRANSFER, QUEUE_TRANSFER

Type: Integer

Category: contact record-driven metric

Contacts transferred in by agent

The count of contacts transferred in by an agent using the CCP.

In the [GetMetricData](#) API, this metric can be retrieved by using CONTACTS_TRANSFERRED_IN_BY_AGENT.

In the [GetMetricDataV2](#) API, this metric can be retrieved by using CONTACTS_CREATED with a [MetricFilters](#) parameter set as follows:

- MetricFilterKey = INITIATION_METHOD
- MetricFilterValues = TRANSFER

Type: Integer

Category: contact record-driven metric

Contacts transferred in from queue

The count of contacts transferred to the queue from another in a **Transfer to queue** flow.

In the [GetMetricData](#) API, this metric can be retrieved by using CONTACTS_TRANSFERRED_IN_FROM_Q.

In the [GetMetricDataV2](#) API, this metric can be retrieved by using CONTACTS_CREATED with a [MetricFilters](#) parameter set as follows:

- MetricFilterKey = INITIATION_METHOD
- MetricFilterValues = QUEUE_TRANSFER

Type: Integer

Category: contact record-driven metric

Contacts transferred out

The count of contacts transferred out from queue to queue, and transferred out by an agent using the CCP.

In the [GetMetricData](#) and [GetMetricDataV2](#) APIs, this metric can be retrieved by using CONTACTS_TRANSFERRED_OUT.

Tip

- **Contacts transferred out** includes all transferred contacts, including contacts who were not connected to an agent before they were transferred out.
- **Contacts transferred out by an agent** is limited to contacts who were connected to an agent before that agent transferred them out.

- Type: Integer
- Category: contact record-driven metric

Contacts transferred out by agent

The count of contacts transferred out by an agent using the CCP.

In the [GetMetricData](#) and [GetMetricDataV2](#) APIs, this metric can be retrieved by using CONTACTS_TRANSFERRED_OUT_BY_AGENT.

Tip

- **Contacts transferred out** includes all transferred contacts, including contacts who were not connected to an agent before they were transferred out.
- **Contacts transferred out by an agent** is limited to contacts who were connected to an agent before that agent transferred them out.

- Type: Integer
- Category: contact record-driven metric

Contacts transferred out external

The count of contacts that an agent transferred from the queue to an external source, such as a phone number other than the phone number for your contact center.

In the [GetMetricDataV2](#) API, this metric can be retrieved by using CONTACTS_TRANSFERRED_OUT_EXTERNAL.

- Type: Integer
- Category: contact record-driven metric

Contacts transferred out internal

The count of contacts for the queue that an agent transferred to an internal source, such as a queue or another agent. An internal source is any source that can be added as a quick connect.

In the [GetMetricDataV2](#) API, this metric can be retrieved by using CONTACTS_TRANSFERRED_OUT_INTERNAL.

- Type: Integer
- Category: contact record-driven metric

Contacts transferred out queue

The count of contacts transferred from the queue to another queue in a **Transfer to queue** flow.

In the [GetMetricData](#) and [GetMetricDataV2](#) APIs, this metric can be retrieved by using CONTACTS_TRANSFERRED_OUT_FROM_QUEUE.

- Type: Integer
- Category: contact record-driven metric

Current cases

The total count of cases existing in a given domain.

Tip

We recommend limiting the queried time window to 5 minutes. Otherwise the returned data may be inaccurate.

In the [GetMetricDataV2](#) API, this metric can be retrieved by using CURRENT_CASES.

Type: Integer

Category: Case driven metric

Customer hold time

Total time that customers spent on hold after being connected to an agent. This includes time spent on a hold when being transferred, but does not include time spent in a queue.

In the [GetMetricDataV2](#) API, this metric can be retrieved by using SUM_HOLD_TIME.

- Type: String (*hh:mm:ss*)
- Category: contact record-driven metric

Customer talk time percent

The talk time by a customer in a voice conversation as a percent of the total conversation duration. To calculate this metric, Amazon Connect totals all the intervals in which a customer was engaged in conversation, and then divides this total by the total conversation duration.

In the [GetMetricDataV2](#) API, this metric can be retrieved by using PERCENT_TALK_TIME_CUSTOMER.

Note

This metric is available only for contacts analyzed by Contact Lens conversational analytics.

- Type: Percent
- Category: Contact Lens driven metric

Error status time

For a specific agent, the total time contacts were in an error status. This metric can't be grouped or filtered by queue.

In the [GetMetricDataV2](#) API, this metric can be retrieved by using `SUM_ERROR_STATUS_TIME_AGENT`.

- Type: String (*hh:mm:ss*)
- Category: Agent activity-driven metric

Flows outcome

This metric returns the count for following flow outcomes within the specified start time and end time. The outcomes are terminal blocks in a flow.

For a given start and end time this metric shows the count those flows where the start time is between the start and end interval specified and has end time. The end time of flow can be greater than end time specified in query interval. The metric does not show the count of flow that started before the start time and is in progress during the specified interval

In the [GetMetricDataV2](#) API, this metric can be retrieved by using `FLows_OUTCOME`.

Data for this metric is available starting from April 22, 2024 0:00:00 GMT.

Following are the system-defined flow outcomes:

- **DROPPED**: When a contact drops from the flow before reaching terminal block.
- **DISCONNECTED_PARTICIPANT**: When a contact reaches a [Disconnect / hang up](#) terminal block in a flow.
- **ENDED_FLOW_EXECUTION**: When a contact reaches an [End flow / Resume](#) terminal block in a flow.
- **TRANSFERED_TO_AGENT**: When a contact is transferred to an agent after running a [Transfer to agent \(beta\)](#) block.
- **TRANSFERED_TO_PHONE_NUMBER**: When a contact is transferred to a phone number specified in a [Transfer to phone number](#) block.
- **TRANSFERED_TO_FLOW**: When a contact is transferred to another flow specified in a [Transfer to flow](#) block.

- **TRANSFERED_TO_QUEUE:** When a contact is transferred to agent queue by using a [Transfer to queue](#) block.
- **RETURNED_TO_FLOW:** When a contact returns back to its original flow from a module.

Type: Integer

Category: Flow driven metric

Flows outcome percentage

This metric returns the percentage of the specified outcome type in the metric level filter. The count value of this metric can be obtained from the FLOWS_OUTCOME metric.

In the [GetMetricDataV2](#) API, this metric can be retrieved by using PERCENT_FLOWS_OUTCOME.

Data for this metric is available starting from April 22, 2024 0:00:00 GMT.

Type: Percent

Category: Flow driven metric

Flows started

The count of flows that started running within the specified start time and end time. For a given start and end time this metric shows the count of those flows where the start time is between the start and end interval specified.

In the [GetMetricDataV2](#) API, this metric can be retrieved by using FLOWS_STARTED.

Data for this metric is available starting from April 22, 2024 0:00:00 GMT.

Type: String (*hh:mm:ss*)

Category: Flow driven metric

Maximum flow time

This metric returns the maximum time the flow took to completed for the specified start time and end time.

In the [GetMetricDataV2](#) API, this metric can be retrieved by using MAX_FLOW_TIME.

Data for this metric is available starting from April 22, 2024 0:00:00 GMT.

Type: String (hh:mm:ss)

Category: Flow driven metric

Maximum queued time

The longest time that a contact spent waiting in the queue. This includes all contacts added to the queue, even if they were not connected with an agent, such as abandoned contacts.

In the [GetMetricData](#) API, this metric can be retrieved by using QUEUED_TIME.

In the [GetMetricDataV2](#) API, this metric can be retrieved by using MAX_QUEUED_TIME.

- Type: String (*hh:mm:ss*)
- Category: contact record-driven metric

Minimum flow time

This metric returns the minimum time a flow took to complete within the specified start time and end time.

In the [GetMetricDataV2](#) API, this metric can be retrieved by using MIN_FLOW_TIME.

Data for this metric is available starting from April 22, 2024 0:00:00 GMT.

Type: String (hh:mm:ss)

Category: Flow driven metric

Non-adherent time

This metric is available only in AWS Regions where Forecasting, capacity planning, and scheduling is available.

Total time an agent was not in an Available status when their shift activity is productive or not in a non-productive status when their shift activity is non-productive.

In the [GetMetricDataV2](#) API, this metric can be retrieved by using AGENT_NON_ADHERENT_TIME.

- Type: String (*hh:mm:ss*)
- Category: Agent activity-driven metric

Non-Productive Time

Total time that agents spent in a [custom status](#). That is, their CCP status is other than **Available** or **Offline**.

This metric doesn't mean that the agent was spending their time unproductively.

Tip

Agents can handle contacts while their CCP status is set to a custom status. For example, agents can be **On contact** or doing **ACW** while their CCP is set to a custom status. This means it's possible for agents to be counted as **On contact** and **NPT** at the same time. For example, if an agent changes their status to a custom status, and then makes an outbound call, it would be counted as non-productive time.

When you create a historical metrics report, this metric can't be grouped or filtered by queue.

In the [GetMetricDataV2](#) API, this metric can be retrieved by using `SUM_NON_PRODUCTIVE_TIME_AGENT`.

- Type: String (*hh:mm:ss*)
- Category: Agent activity-driven metric

Non-talk time percent

The non-talk time in a voice conversation as a percent of the total conversation duration. To calculate non-talk time percent, Amazon Connect totals all the intervals in which participants remained silent (non-talk time), and then divides this total by the total conversation duration.

In the [GetMetricDataV2](#) API, this metric can be retrieved by using `PERCENT_NON_TALK_TIME`.

Note

This metric is available only for contacts analyzed by Contact Lens conversational analytics.

- Type: Percent
- Category: Contact Lens driven metric

Occupancy

Percentage of time that agents were active on contacts. This percentage is calculated as follows:

$$\text{(Agent on contact (wall clock time)) / (Agent on contact (wall clock time) + Agent idle time)}$$

Where:

- (Agent on contact + Agent idle time) = total amount of agent time
- So (Agent on contact)/(total amount of agent time) = percentage of time agents were active on contacts.

Important

Occupancy doesn't account for concurrency. That is, an agent is considered 100% occupied for a given interval if they are handling at least one contact for that entire duration.

In the [GetMetricData](#) API, this metric can be retrieved by using OCCUPANCY.

In the [GetMetricDataV2](#) API, this metric can be retrieved by using AGENT_OCCUPANCY.

- Type: String
- Min value: 0.00%
- Max value: 100.00%
- Category: Agent activity-driven metric

Online time

Total time that an agent spent with their CCP set to a status other than **Offline**. This includes any time spent in a custom status. When you create a historical metrics reports, this metric can't be grouped or filtered by queue, phone number, or channels.

In the [GetMetricDataV2](#) API, this metric can be retrieved by using SUM_ONLINE_TIME_AGENT.

- Type: String

- Category: Agent activity-driven metric

Scheduled time

This metric is available only in AWS Regions where [Forecasting, capacity planning, and scheduling](#) is available.

Total time an agent was scheduled (either for productive or non-productive time) and *Adherence* for those shifts was set to Yes.

In the [GetMetricDataV2](#) API, this metric can be retrieved by using AGENT_SCHEDULED_TIME.

- Type: String ((hh:mm:ss))
- Category: Agent activity-driven metric

Service level X

Percentage of contacts removed from the queue between 0 and X after being added to it. A contact is removed from a queue when the following occurs: an agent answers the contact, the customer abandons the contact, or the customer requests a call back.

For X you can choose from pre-set times in seconds: 15, 20, 25, 30, 45, 60, 90, 120, 180, 240, 300, and 600. This percentage is calculated as follows:

$(\text{Contacts removed from queue in } X \text{ seconds} / \text{Contacts queued}) * 100$

In the [GetMetricData](#) and [GetMetricDataV2](#) APIs, this metric can be retrieved by using SERVICE_LEVEL.

- Type: String
- Min value: 0.00%
- Max value: 100.00%
- Category: contact record-driven metric

Custom service levels

You can also create custom service level metrics. Choose from additional durations, such as minutes, hours, or days.

Custom service levels are localized to the report where they are created. For example, you create a report that has a custom service level of 75. You leave the page and then create another report. The custom service level 75 won't exist in the second report. You'll need to create it again.

The maximum duration for a custom service level is 7 days. That's because in Amazon Connect you can't have a contact that goes longer than 7 days.

You can add up to 10 custom service levels per report.

Talk time percent

The talk time in a voice conversation as a percent of the total conversation duration. To calculate talk time percent, Amazon Connect totals all the intervals in which either an agent, a customer, or both were engaged in conversation (talk time), and then divides this total by the total conversation duration.

In the [GetMetricDataV2](#) API, this metric can be retrieved by using PERCENT_TALK_TIME.

Note

This metric is available only for contacts analyzed by Contact Lens conversational analytics.

- Type: Percent
- Category: Contact Lens driven metric

Permissions required to view historical metrics reports

To view historical metrics reports, you need to be assigned to a security profile that has either the **Access metrics - Access** permission or the **Real-time metrics - Access** permission. Note the following behavior when you assign these permissions:

- When **Access metrics - Access** is selected, the **Real-time metrics**, **Historical metrics**, and **Agent activity audit** permissions are also automatically assigned.
- When **Access metrics - Access** is assigned, you have access to all real-time and historical metrics reports.

The following image shows the **Analytics and Optimization** section of the **Security profile permissions** page. The **Access** option is selected for **Access metrics**, **Real-time metrics**, **Historical metrics**, and **Agent activity audit**.

Analytics and Optimization										
Type	All	Access	View	Edit	Create	Enable/Disable	Enable download button	Delete	Publish	Schedule
Access metrics	<input type="checkbox"/>	<input checked="" type="checkbox"/>	<input type="checkbox"/>	<input type="checkbox"/>	<input type="checkbox"/>	<input type="checkbox"/>	<input type="checkbox"/>	<input type="checkbox"/>	<input type="checkbox"/>	<input type="checkbox"/>
Real-time metrics	<input type="checkbox"/>	<input checked="" type="checkbox"/>	<input type="checkbox"/>	<input type="checkbox"/>	<input type="checkbox"/>	<input type="checkbox"/>	<input type="checkbox"/>	<input type="checkbox"/>	<input type="checkbox"/>	<input type="checkbox"/>
Historical metrics	<input type="checkbox"/>	<input checked="" type="checkbox"/>	<input type="checkbox"/>	<input type="checkbox"/>	<input type="checkbox"/>	<input type="checkbox"/>	<input type="checkbox"/>	<input type="checkbox"/>	<input type="checkbox"/>	<input type="checkbox"/>
Agent activity audit	<input type="checkbox"/>	<input checked="" type="checkbox"/>	<input type="checkbox"/>	<input type="checkbox"/>	<input type="checkbox"/>	<input type="checkbox"/>	<input type="checkbox"/>	<input type="checkbox"/>	<input type="checkbox"/>	<input type="checkbox"/>
Contact search	<input type="checkbox"/>	<input type="checkbox"/>	<input type="checkbox"/>	<input type="checkbox"/>	<input type="checkbox"/>	<input type="checkbox"/>	<input type="checkbox"/>	<input type="checkbox"/>	<input type="checkbox"/>	<input type="checkbox"/>
Search contacts by conversation characteristics	<input type="checkbox"/>	<input type="checkbox"/>	<input type="checkbox"/>	<input type="checkbox"/>	<input type="checkbox"/>	<input type="checkbox"/>	<input type="checkbox"/>	<input type="checkbox"/>	<input type="checkbox"/>	<input type="checkbox"/>
Search contacts by keywords	<input type="checkbox"/>	<input type="checkbox"/>	<input type="checkbox"/>	<input type="checkbox"/>	<input type="checkbox"/>	<input type="checkbox"/>	<input type="checkbox"/>	<input type="checkbox"/>	<input type="checkbox"/>	<input type="checkbox"/>
Configure searchable contact attributes	<input type="checkbox"/>	<input type="checkbox"/>	<input type="checkbox"/>	<input type="checkbox"/>	<input type="checkbox"/>	<input type="checkbox"/>	<input type="checkbox"/>	<input type="checkbox"/>	<input type="checkbox"/>	<input type="checkbox"/>

If only **Historical metrics - Access** is selected, you have access to only historical metrics and no other analytics pages or reports. The following image shows the **Analytics and Optimization** section, with only **Historical metrics - Access** selected.

Analytics and Optimization										
Type	All	Access	View	Edit	Create	Enable/Disable	Enable download button	Delete	Publish	Schedule
Access metrics	<input type="checkbox"/>	<input type="checkbox"/>	<input type="checkbox"/>	<input type="checkbox"/>	<input type="checkbox"/>	<input type="checkbox"/>	<input type="checkbox"/>	<input type="checkbox"/>	<input type="checkbox"/>	<input type="checkbox"/>
Real-time metrics	<input type="checkbox"/>	<input type="checkbox"/>	<input type="checkbox"/>	<input type="checkbox"/>	<input type="checkbox"/>	<input type="checkbox"/>	<input type="checkbox"/>	<input type="checkbox"/>	<input type="checkbox"/>	<input type="checkbox"/>
Historical metrics	<input type="checkbox"/>	<input checked="" type="checkbox"/>	<input type="checkbox"/>	<input type="checkbox"/>	<input type="checkbox"/>	<input type="checkbox"/>	<input type="checkbox"/>	<input type="checkbox"/>	<input type="checkbox"/>	<input type="checkbox"/>
Agent activity audit	<input type="checkbox"/>	<input type="checkbox"/>	<input type="checkbox"/>	<input type="checkbox"/>	<input type="checkbox"/>	<input type="checkbox"/>	<input type="checkbox"/>	<input type="checkbox"/>	<input type="checkbox"/>	<input type="checkbox"/>
Contact search	<input type="checkbox"/>	<input type="checkbox"/>	<input type="checkbox"/>	<input type="checkbox"/>	<input type="checkbox"/>	<input type="checkbox"/>	<input type="checkbox"/>	<input type="checkbox"/>	<input type="checkbox"/>	<input type="checkbox"/>
Search contacts by conversation characteristics	<input type="checkbox"/>	<input type="checkbox"/>	<input type="checkbox"/>	<input type="checkbox"/>	<input type="checkbox"/>	<input type="checkbox"/>	<input type="checkbox"/>	<input type="checkbox"/>	<input type="checkbox"/>	<input type="checkbox"/>
Search contacts by keywords	<input type="checkbox"/>	<input type="checkbox"/>	<input type="checkbox"/>	<input type="checkbox"/>	<input type="checkbox"/>	<input type="checkbox"/>	<input type="checkbox"/>	<input type="checkbox"/>	<input type="checkbox"/>	<input type="checkbox"/>
Configure searchable contact attributes	<input type="checkbox"/>	<input type="checkbox"/>	<input type="checkbox"/>	<input type="checkbox"/>	<input type="checkbox"/>	<input type="checkbox"/>	<input type="checkbox"/>	<input type="checkbox"/>	<input type="checkbox"/>	<input type="checkbox"/>

Apply tag-based access control to historical metrics reports

You can use resource tags and access control tags to apply granular access to users, queues, and routing profiles for historical metrics. For example, you can control who has access to view specific users, queues, and routing profile historical metrics.

Amazon Connect also supports tag-based access controls for real-time metrics and the agent activity audit, but it does not support dashboards and the login/logout report. For more information, see [Real-time metrics tag-based access control](#) and [Agent activity audit tag-based access control](#).

Tag-based access controls enable you to configure granular access to specific resources based on assigned resource tags. You can configure tag-based access controls by using the API or the

Amazon Connect admin website for supported resources. You must configure resource tags and access control tags before tag-based access control is applied to users, queues, and routing profiles for real-time metrics. For more information, see [Tag resources in Amazon Connect](#) and [Tag-based access control](#).

How to enable tag-based access control for historical metrics reports

To apply tags to control access to users, queues, and routing profiles metrics in historical metrics reports:

1. Apply tags to the resources that you're going use in the historical metrics report, such as users, queues, and routing profiles. For more information, see [Tag resources in Amazon Connect](#).
2. You need to be assigned to a security profile that specifically grants you access to the resources that have been tagged. On the Security profiles page, choose **Show advanced** options to assign these permissions.
3. In addition, you need the one of following permissions to view the historical metrics reports:
 - **Analytics and Optimization - Access metrics - Access:** If you choose this option, access is also granted to Real-time metrics, Historical metrics, Agent activity audit, and Dashboards. This means you are granting users permission see all data for Dashboards where tag-based access controls are not currently applied.

OR

- **Analytics and Optimization - Historical metrics - Access**

Limitations

The following limitations apply when you use tag-based access controls with historical metrics:

- You can only filter and group by the same resource (user, queue, or routing profile). For example, you cannot filter by queue for an agent grouping and you cannot group by queue and routing profile. The only additional grouping you can do is channel (for example, Group by queue and channel).
- You can filter for 100 resources per report.
- You can't group by agent hierarchy and phone numbers. You can't filter by agent hierarchy, phone numbers, or agent queues.
- Access to the homepage service level dashboard is disabled.

How to transition to tag-based access control

If you open a saved report containing tables with users, queues, or routing profiles that you don't have access to anymore due to tag-based access control, or if groupings or non-primary filters are applied to tables, you won't see data in those tables.

To view the data, perform one of the following steps:

- Edit your table filters to include the agents, queues, or routing profiles that you have access to.
- Create a new report that includes the resources you have access to.
- Remove the groupings and non-primary filters from the table.

Create a historical metrics report

Although Amazon Connect includes built-in historical reports, you can create your own custom reports so you look at only the data that's of interest to your organization.

Requirement

- You must have permission to access metric data. The following security profiles include this permission: **CallCenterManager** and **QualityAnalyst**. For more information, see [Security profiles](#).

Grouping options

You can group the metrics included in your reports in different ways to provide greater insight into how your contact center is performing.

You can group reports by queue, agent, agent hierarchy, routing profile, or phone number. The metric calculations, and therefore metrics values displayed in the report, are different when reports are grouped differently. For example, if you group a report by queue, the value of a metric includes all contacts associated with the queue. If you group a report by agent, the values for the metrics associated with queues might not provide much insight.

When you create a report, the values for calculated metrics are displayed as rows in the report. The rows in the report are grouped by the grouping options you select. Grouping the data enables you to generate global data for your contact center, or more specific data for queues, agents, routing profiles, or agent hierarchy defined in your contact center.

For example, consider the **Contacts handled** metric. This metric is a count of the contacts handled during the time range defined for the report. Here are the results based on the grouping:

- **Queue** - The metric is the total number of contacts handled during the time range from that queue by all agents in your contact center.
- **Agent** - The metric is the total number of contacts handled by that agent during the time range across all queues and routing profiles.
- **Routing Profile** - The metric is the total number of contacts handled during the time range by agents assigned that routing profile.
- **Queue, then Agent, then Routing Profile** - The metric is the total number of contacts that agent assigned that routing profile handled from that queue.

Agent activity can be included in one routing profile at a time, but agents can switch between routing profiles over the reporting time interval. If agents are assigned multiple routing profiles and handle contacts from multiple queues, there are multiple rows in the report for each routing profile assigned to the agent and the queue that the agent handled contacts from.

Filters

When you customize a report, you can add filters to control which data is included in the report. You can filter on the following:

- **Queue**—Includes data only for the specified queues. If you don't specify any queues, all queues are included.
- **Routing profile**—Includes data only for the agents assigned to the specified routing profiles. If you don't specify any routing profiles, data for all agents for all routing profiles is included.
- **Agent hierarchy**—Includes data only for the contacts handled by agents in the specified hierarchies. If you don't specify a hierarchy, data for all contacts handled by agents in all hierarchies is included. When only one hierarchy is specified, you can specify a more granular filter within the hierarchy.
- **Phone number**—Includes data only for the contacts associated with the specified phone numbers. If you don't specify a phone number, data for all contacts associated with all phone numbers is included.

How to create a historical metrics report

1. Log in to the Amazon Connect admin website at https://instance_name.my.connect.aws/.
2. Choose **Analytics and optimization, Historical metrics**.
3. Choose one of the following report types, which group and order the data in different ways, and include different metrics:
 - **Queues**
 - **Contact metrics**
 - **Agent metrics**
 - **Agents**
 - **Agent performance**
 - [Agent activity audit report](#)
 - **Phone numbers**
 - **Contact metrics**
4. To customize your report, choose the gear icon.
5. On the **Interval & Time range** tab, do the following:
 - a. For **Interval**, choose **30 minutes** to get a row for each 30-minute period in the time range, **Daily** to get a row for each day in the time range, or **Total** to get all data for the time range in a single row.
 - b. For **Time Zone**, select a time zone, which determines the hour at which a day starts. For example, to align the report with your calendar days, select the time zone for your location.

You should use the same time zone for reports over time to get accurate and consistent metrics data for your contact center. Using different time zones for different reports may result in different data for the same time range selection.

- c. The possible values for **Time range** depend on the value that you select for **Interval**. Alternatively, you can specify a custom time range.

For **Last x days** and **Month to date**, the current day is not included in the report.

Yesterday specifies the previous calendar day while **Last 24 hours** specifies the 24 hours prior to the current time.

6. (Optional) On the **Groupings** tab, choose up to five groupings. If you choose one grouping option, the data is grouped by that option. If you choose multiple grouping options, the data is group by the first grouping option and then by the subsequent grouping options. For more information, see [Grouping options](#).
7. (Optional) On the **Filters** tab, specify filters to scope the data to be included in the report. The available filters depend on the groupings that you select. For more information, see [Filters](#).
8. On the **Metrics** tab, choose the metrics and fields to include in the report. An exclamation point (!) is displayed next to any metrics that are not available based on the groupings that you selected. For more information, see [Historical metrics definitions](#).
9. When you are finished customizing your report, choose **Apply**.
10. (Optional) To save your report for future use, choose **Save**, provide a name for the report, and then choose **Save**.

Historical report limits

Historical metrics reports have the following limits:

Service quotas

- Historical metrics reports have service quotas, such as **Reports per instance** and **Scheduled reports per instance**. When service quotas are breached, the following error message is displayed: *Report cannot be saved*. For more information about these quotas, see [Amazon Connect service quotas](#)

Data only for active queues

- You can get data only for active queues. A queue is inactive if there are no contacts in the queue and no agents available.

Query data for three days at a time, for the past 2 days

- When you create a report that uses 15 minute intervals, you can return data for three days at a time, for the past 35 days. For 30 minute intervals you can return data for only three days at a time, but the data is available based on the retention period of contact records.

The availability of historical metric data is based on the retention period of contact records

- Historical metrics are based contact records. For the current retention period for contact records, see [Amazon Connect feature specifications](#).

For daily and total intervals

- You can select up to 31 days in a single request.

80k cell limit

There is currently an 80k cell limitation on historical metrics reports and scheduled reports. This applies to the total number of cells (columns * rows), accounting for grouping and filtering.

For example, let's say you create a historical metrics report with this criteria:

- Grouped by agents
- With an interval of 30 minutes
- For the last 24 hours
- Configured to include only 5 metrics
- Filtered to show only contacts handled in BasicQueue

If only 10 agents handled contacts in BasicQueue during this time, then you would expect to see $(24*2)*5*10 = 2400$ cells that count towards the 80k limit.

A message informs you if you reach the limit.

Schedule a historical metrics report

Before you schedule a historical metrics report, here are a few things you need to know:

Others can access the report

- Scheduling a report makes the report accessible by any other users in your contact center who have permissions to view saved reports.

Anyone with Schedule permissions can create, edit, or delete the schedule of your report

- After you publish a report, any user with **Saved reports - Schedule** permissions in their security profile can create, edit, or delete the schedule of your report. They cannot delete the actual report.

Scheduled reports are located in an Amazon S3 bucket

- Scheduled reports are saved as CSV files in the Amazon S3 bucket specified for reports for your contact center. When you set up the scheduled report, you can add a prefix to the location in Amazon S3 for the report files.
- When the report is exported to your Amazon S3 bucket, the file name includes the date and UTC time when the report was created. The **Last modified date** for the file is displayed using the time zone for the Amazon S3 bucket, and may not match the creation time for the report, which is in UTC.

There's a 15 minute delay

- For scheduled reports, there is a delay of 15 minutes after the scheduled report time before the report is generated. This is to ensure that the report includes the data for all of the activity that occurred during the time range specified for the report. Data from your contact center is not immediately processed and available to include in reports, so some data from the time range might not be captured in a report if the report is generated at the second the time range ends.
- For example, if you create a scheduled report for time frame of 8:00 AM to 5:00 PM, and there is activity in your contact center between 4:46:00 PM and 4:59:59 PM, the data about that activity may not be aggregated prior 5:00 PM when the report is scheduled to generate. Instead, the report is generated after 5:15 PM, by which time the data for the last 15 minutes of the time range is included in the report.

A scheduled Yesterday report works like a Last 24 hours report

- Usually **Yesterday** specifies the previous calendar day while **Last 24 hours** specifies the 24 hours prior to the current time. However, if you schedule to run a **Yesterday** report, it will work like a **Last 24 hours** report.

No message if a scheduled report doesn't run

- If a scheduled report fails to run, you won't get any message in the Amazon Connect UI. You just won't see the report in the Amazon S3 location.

Use your messaging system to email scheduled reports

- To email a scheduled report to a list of co-workers, you need to generate the email manually using your messaging system. Amazon Connect doesn't provide an option to email the scheduled report automatically.

How to schedule a historical metrics report

1. Log in to the Amazon Connect admin website at [https://*instance name*.my.connect.aws/](https://instance_name.my.connect.aws/).
2. Create a new report and save it, or open a saved report.
3. Choose the down arrow next to **Save** in the top-right corner of the page and choose **Schedule**.
4. On the **Recurrence** tab, specify how often this report should be run (for example, weekly on Saturdays) and the range (for example, from midnight for the previous 5 days).
5. (Optional) On the **Delivery Options** tab, specify a prefix for the location in Amazon S3 for the report files.
6. Choose **Create**.

How to delete a scheduled report

To get to the page where you can delete a scheduled report, you need to create another temporary scheduled report.

1. Log in to the Amazon Connect admin website at [https://*instance name*.my.connect.aws/](https://instance_name.my.connect.aws/).
2. On the navigation menu, choose **Analytics and optimization, Dashboards and reports**.
3. On the **View reports** page, choose the **Historical metrics** tab.
4. Click or tap on the saved report that has been scheduled.
5. Choose the down arrow next to **Save** in the top-right corner of the page and choose **Schedule**.
6. Choose **Create**.
7. On the **Schedule Report** page, choose **Delete** next to the scheduled reports you want to delete.

For instructions on deleting saved reports, see [How to delete saved reports](#).

Update a historical metrics report

After you save a report, you can update it at any time.

To update a historical metrics report

1. Log in to the Amazon Connect admin website at [https://*instance name*.my.connect.aws/](https://instance_name.my.connect.aws/).
2. Choose **Analytics and optimization, Saved reports**.
3. From the **Historical metrics** tab, choose the name of the report. Choose the gear icon, update the report settings as needed, and choose **Apply**.
4. To update the current report, choose **Save**. To save your changes to a new report, choose **Save as**.

Download a historical metrics report

You can download the data included in a report as a comma-separated value (CSV) file so you can use it with other applications. If there's no data for one of the selected metrics, the field in the downloaded CSV file contains a dash.

To download a historical metrics report as a CSV file

1. Log in to the Amazon Connect admin website at [https://*instance name*.my.connect.aws/](https://instance_name.my.connect.aws/).
2. Create a new report or open a saved report.
3. Choose the down arrow next to **Save** in the top-right corner of the page and choose **Download CSV**.
4. When prompted, confirm whether to open or save the file.

The following image shows metrics in a Queue table. All times in the online report are in hours:minutes:seconds (hh:mm:ss). Below the image of the Queue table, there is an image of the same data in a downloaded CSV file opened with Excel. All times in the downloaded report are in seconds.

Queue	Agent on contact time	Agent idle time	Average after contact work time
BasicQueue	186:15:05	49:24:56	46:32:42
DeviceIssue	00:02:02	00:17:24	00:02:01
NetworkIssue	172:40:41	00:17:24	86:20:25
PasswordReset	00:02:40	00:17:24	00:00:21

All times in the online report are in hh:mm:ss.

Queue	Agent on contact time	Agent idle time	Average after contact work time
BasicQueue	670505	177896	167562
DeviceIssue	122	1044	121
NetworkIssue	621641	1044	310825
PasswordReset	160	1044	21

All times in the downloaded report are in seconds.

You can convert the seconds to minutes using an Excel formula. Alternatively, if you have a short report, you can copy and paste the data from Amazon Connect to Excel and it will preserve the format.

Interval downloaded in ISO date format

The interval is downloaded in ISO date format, as shown in the following image. When you download a historical metrics report, the interval will be in ISO data format and won't match the UI. If needed, use Excel to convert it to the desired format.

Tip: when you download a historical metrics report, the interval will be in ISO date format, and won't match the UI. If needed, use Excel to convert it to the desired format.

Interval	Agent
1/28/20 12:00 AM - 1/29/20 12:00 AM	Jane
1/28/20 12:00 AM - 1/29/20 12:00 AM	John
1/29/20 12:00 AM - 1/30/20 12:00 AM	John

Download all historical metric results

If you need to download more than a page or two of historical metrics, we recommend using the following steps:

1. Schedule the report to run as often as needed.

For example, you might schedule the Login/Logout report to run daily at midnight.

2. The full report is saved to your Amazon S3 bucket.
3. Go to your Amazon S3 bucket and download the report.

To learn how scheduled reports work, see [Schedule a historical metrics report](#).

Show agent queues in a Queues table

By default agent queues don't appear in a Queues table in a historical metrics report. You can choose to show them.

To show agent queues in a Queues table

1. In a historical metrics report, choose the **Settings** icon, as shown in the following image.

Historical metrics: Queues

Save

Interval: Total, Time range: Sep 10, 2020, 12:00 AM - Sep 17, 2020, 12:00 AM, Time Zone: UTC

Queue	Average queue abandon time	Average after contact work time	Average queue size
< [Progress Bar] >			

- Choose **Filters, Show agent queues, Agent queues**, and then use the drop-down to choose the agent's queues you want to include in the table. These options are shown in the following image.

Table Settings

Interval & Time range | Groupings | **Filters** | Metrics

Queues that match these filters will be displayed on the table

Show agent queues

Queue

- Agent queues**
- Routing profile
- Agent hierarchy
- Phone number

Agent queues

Show metrics only for contacts handled in these queues:

Search

- John (John Doe)
- Jane (Jane Doe)

- Choose **Apply**. The agent queues you selected appear in the Queues table in the historical metrics report.

How many contacts in queue on a specific date

The historical metrics reports don't provide a way for you to determine how many contacts were in queue on a specific date, at a specific time.

To get this information in a historical report, you need the help of a developer. The developer uses the [GetCurrentMetricData](#) API to store the data so you can look it up later.

Agent activity audit report

The agent activity audit is like a report version of the [agent event stream](#). All of the data in this report is also in the agent event stream.

For example, if there's something in the audit report you want to recreate, or if you want to recreate a different time period, you can do so using the agent event stream.

Contents

- [Run the agent activity audit report](#)
- [Status definitions](#)
- [When is the status Agent Disconnected, Contact Missed, or Rejected?](#)
- [Permissions required to view agent activity audit reports](#)
- [Agent activity audit tag-based access control](#)

Run the agent activity audit report

For a list of required permissions to perform this procedure, see [Permissions required to view historical metrics reports](#).

1. Log in to the Amazon Connect admin website at [https://*instance name*.my.connect.aws/](https://instance_name.my.connect.aws/).
2. Choose **Analytics and optimization, Historical metrics, Agents, Agent activity audit**.
3. Choose the agent login, date, and timezone, and then choose **Generate Report**.
4. To download the results, choose **Download CSV**.

Status definitions

The following values may appear in the **Status** column on agent activity audit report.

- **Available:** The agent has set their status in the Contact Control Panel (CCP) to **Available**. Contacts can be routed to them.
- **Offline:** The agent has set their status in the Contact Control Panel (CCP) to **Offline**. Contacts can not be routed to them.
- **Custom status:** The agent has set their status in the Contact Control Panel (CCP) to a custom status. Contacts can not be routed to them.
- **Joining Customer:** The state between an inbound contact arriving in the flow and routing to the agent.
- **Connecting Agent:** The state between an inbound contact being routed to an agent and the agent receiving the contact.
- **Connected:** When an inbound contact has been established by the agent choosing **Accept** in their CCP.
- **Busy:** The agent is interacting with a customer.
- **Agent Disconnected:** When the agent doesn't choose **Accept** on the inbound voice contact in 20 seconds, or they choose **Reject**.
- **Calling Customer:** The state before an outbound call is established.
- **Contact Missed:** When the agent misses a chat or task contact.
- **Missed Call Agent:** When an agent accepts a callback, but they end the call before ringing the customer has finished.
- **Paused:** When a contact has been paused after being connected to an agent using the CCP or public API.
- **Telecom issue:** When an outbound call is ended before the call is established. For example, there was an error with the agent's soft phone connection.

Note

If a status appears in your report but is not listed on this page, it is a custom status created by your organization. Contact your Amazon Connect admin to learn the definition.

When is the status **Agent Disconnected**, **Contact Missed**, or **Rejected**?

Following is a summary of when the **Status** column can be **Agent Disconnected**, **Contact Missed**, or **Rejected**:

- Voice contact
 - When anyone misses a voice contact, the status in the agent audit is **Agent Disconnected**.
 - When anyone rejects a voice contact, the status in the agent audit is **Agent Disconnected**.
- Chat contact
 - When anyone misses a chat contact, the status in the agent audit is **Contact Missed**.
 - When anyone rejects a chat contact, the status in the agent audit is **Contact Missed**.
- Task contact
 - When anyone misses a task contact, the status in the agent audit is **Contact Missed**.
 - When anyone rejects a task contact, the status in the agent audit is **Rejected**.

Permissions required to view agent activity audit reports

To view real-time metrics reports, you need to be assigned to a security profile that has either the **Access metrics - Access** permission or the **Real-time metrics - Access** permission. Note the following behavior when you assign these permissions:

- When **Access metrics - Access** is selected, the **Real-time metrics**, **Historical metrics**, and **Agent activity audit** permissions are also automatically assigned.
- When **Access metrics - Access** is assigned, you have access to all real-time and historical metrics reports.

Analytics and Optimization ⓘ										
Type	All	Access	View	Edit	Create	Enable/Disable	Enable download button	Delete	Publish	Schedule
Access metrics	<input type="checkbox"/>	<input checked="" type="checkbox"/>	<input type="checkbox"/>	<input type="checkbox"/>	<input type="checkbox"/>	<input type="checkbox"/>	<input type="checkbox"/>	<input type="checkbox"/>	<input type="checkbox"/>	<input type="checkbox"/>
Real-time metrics ⓘ	<input type="checkbox"/>	<input checked="" type="checkbox"/>	<input type="checkbox"/>	<input type="checkbox"/>	<input type="checkbox"/>	<input type="checkbox"/>	<input type="checkbox"/>	<input type="checkbox"/>	<input type="checkbox"/>	<input type="checkbox"/>
Historical metrics ⓘ	<input type="checkbox"/>	<input checked="" type="checkbox"/>	<input type="checkbox"/>	<input type="checkbox"/>	<input type="checkbox"/>	<input type="checkbox"/>	<input type="checkbox"/>	<input type="checkbox"/>	<input type="checkbox"/>	<input type="checkbox"/>
Agent activity audit ⓘ	<input type="checkbox"/>	<input checked="" type="checkbox"/>	<input type="checkbox"/>	<input type="checkbox"/>	<input type="checkbox"/>	<input type="checkbox"/>	<input type="checkbox"/>	<input type="checkbox"/>	<input type="checkbox"/>	<input type="checkbox"/>
Contact search	<input type="checkbox"/>	<input type="checkbox"/>	<input type="checkbox"/>	<input type="checkbox"/>	<input type="checkbox"/>	<input type="checkbox"/>	<input type="checkbox"/>	<input type="checkbox"/>	<input type="checkbox"/>	<input type="checkbox"/>
Search contacts by conversation characteristics	<input type="checkbox"/>	<input type="checkbox"/>	<input type="checkbox"/>	<input type="checkbox"/>	<input type="checkbox"/>	<input type="checkbox"/>	<input type="checkbox"/>	<input type="checkbox"/>	<input type="checkbox"/>	<input type="checkbox"/>
Search contacts by keywords	<input type="checkbox"/>	<input type="checkbox"/>	<input type="checkbox"/>	<input type="checkbox"/>	<input type="checkbox"/>	<input type="checkbox"/>	<input type="checkbox"/>	<input type="checkbox"/>	<input type="checkbox"/>	<input type="checkbox"/>
Configure searchable contact attributes	<input type="checkbox"/>	<input type="checkbox"/>	<input type="checkbox"/>	<input type="checkbox"/>	<input type="checkbox"/>	<input type="checkbox"/>	<input type="checkbox"/>	<input type="checkbox"/>	<input type="checkbox"/>	<input type="checkbox"/>

If only **Agent activity audit - Access** is selected, you have access to only agent activity audit report and no other analytics pages or reports. The following image shows the **Analytics and Optimization** section, with only **Agent activity audit - Access** selected.

Analytics and Optimization										
Type	All	Access	View	Edit	Create	Enable/Disable	Enable download button	Delete	Publish	Schedule
Access metrics	<input type="checkbox"/>	<input type="checkbox"/>	<input type="checkbox"/>	<input type="checkbox"/>	<input type="checkbox"/>	<input type="checkbox"/>	<input type="checkbox"/>	<input type="checkbox"/>	<input type="checkbox"/>	<input type="checkbox"/>
Real-time metrics	<input type="checkbox"/>	<input type="checkbox"/>	<input type="checkbox"/>	<input type="checkbox"/>	<input type="checkbox"/>	<input type="checkbox"/>	<input type="checkbox"/>	<input type="checkbox"/>	<input type="checkbox"/>	<input type="checkbox"/>
Historical metrics	<input type="checkbox"/>	<input type="checkbox"/>	<input type="checkbox"/>	<input type="checkbox"/>	<input type="checkbox"/>	<input type="checkbox"/>	<input type="checkbox"/>	<input type="checkbox"/>	<input type="checkbox"/>	<input type="checkbox"/>
Agent activity audit	<input type="checkbox"/>	<input checked="" type="checkbox"/>	<input type="checkbox"/>	<input type="checkbox"/>	<input type="checkbox"/>	<input type="checkbox"/>	<input type="checkbox"/>	<input type="checkbox"/>	<input type="checkbox"/>	<input type="checkbox"/>
Contact search	<input type="checkbox"/>	<input type="checkbox"/>	<input type="checkbox"/>	<input type="checkbox"/>	<input type="checkbox"/>	<input type="checkbox"/>	<input type="checkbox"/>	<input type="checkbox"/>	<input type="checkbox"/>	<input type="checkbox"/>
Search contacts by conversation characteristics	<input type="checkbox"/>	<input type="checkbox"/>	<input type="checkbox"/>	<input type="checkbox"/>	<input type="checkbox"/>	<input type="checkbox"/>	<input type="checkbox"/>	<input type="checkbox"/>	<input type="checkbox"/>	<input type="checkbox"/>
Search contacts by keywords	<input type="checkbox"/>	<input type="checkbox"/>	<input type="checkbox"/>	<input type="checkbox"/>	<input type="checkbox"/>	<input type="checkbox"/>	<input type="checkbox"/>	<input type="checkbox"/>	<input type="checkbox"/>	<input type="checkbox"/>
Configure searchable contact attributes	<input type="checkbox"/>	<input type="checkbox"/>	<input type="checkbox"/>	<input type="checkbox"/>	<input type="checkbox"/>	<input type="checkbox"/>	<input type="checkbox"/>	<input type="checkbox"/>	<input type="checkbox"/>	<input type="checkbox"/>

Agent activity audit tag-based access control

You can use resource tags and access control tags to apply granular access to users for the agent activity audit report. For example, you can control who has access to view agent status history for specific users in the report. The following images provide example views of the agent activity audit report with and without tag-based access controls:

Without tag-based access controls, you see all agents:

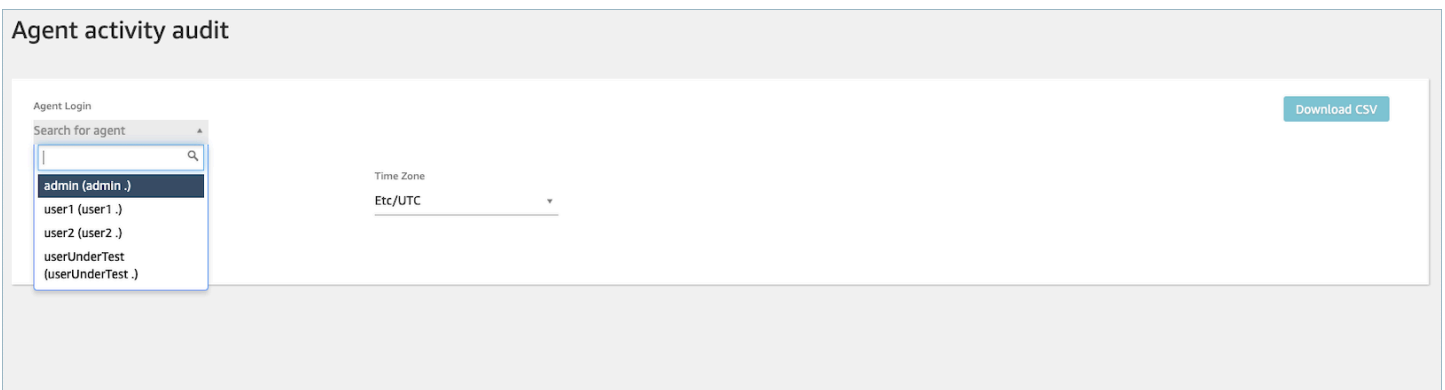

By using tag-based access controls, you can see a limited set of agents:

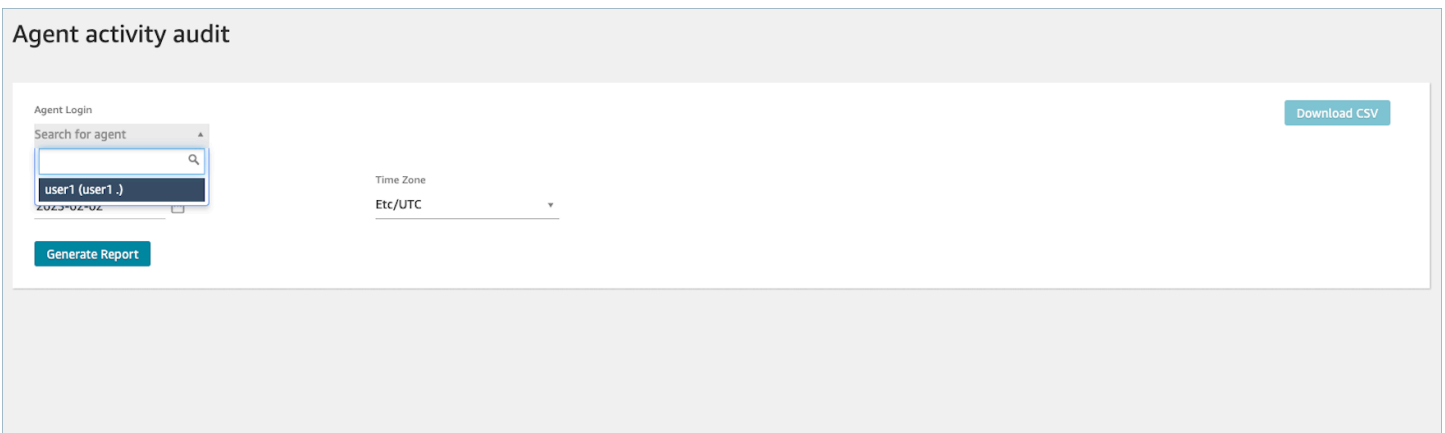

Tag-based access controls are available for real-time metrics; however, they are not applicable to other historical metric reports or the login/logout report. For more information, please see [Real-time metrics tag-based access control](#).

Tag-based access controls enable you to configure granular access to specific resources based on assigned resource tags. You can configure tag based access controls by using the API/SDK or the Amazon Connect admin website (for supported resources). You must configure user resource tags and access control tags before tag-based access control is applied to users for the agent activity audit report. For more information, see [Tag resources in Amazon Connect](#) and [Tag-based access control](#).

How To Enable Tag-based Access Control for Agent Activity Audit Report





To use tags to control access to users for the agent activity audit report, you must first configure user resource tags and access control tags. After your resource tags and access control tags are configured, you need to apply the appropriate permissions.

After your resource tags, access control tags, and permissions have been appropriately configured, you will have access controls applied to users for the agent activity audit report.

For more information on tagging resources and tag-based access control in Amazon Connect, see [Tag resources in Amazon Connect](#) and [Tag-based access control](#).

Permissions

To view agent activity audit reports with tag-based access controls applied, you need to be assigned to a security profile that has Access selected for **Agent Activity Audit** or has Access selected for **Access metrics** permission, along with access to the user resource. Note that if you enable **Access metrics**, then **Real-time metrics**, **Historical Metrics**, and **Agent Activity Audit** will be filled in automatically, and you therefore will be enabling users to see all data for historical metrics for which tag-based access controls are not currently applied.

Analytics and Optimization 										
Type	All	Access	View	Edit	Create	Enable/Disable	Enable download button	Delete	Publish	Schedule
Access metrics	<input type="checkbox"/>	<input type="checkbox"/>	<input type="checkbox"/>	<input type="checkbox"/>	<input type="checkbox"/>	<input type="checkbox"/>	<input type="checkbox"/>	<input type="checkbox"/>	<input type="checkbox"/>	<input type="checkbox"/>
Real-time metrics 	<input type="checkbox"/>	<input type="checkbox"/>	<input type="checkbox"/>	<input type="checkbox"/>	<input type="checkbox"/>	<input type="checkbox"/>	<input type="checkbox"/>	<input type="checkbox"/>	<input type="checkbox"/>	<input type="checkbox"/>
Historical metrics 	<input type="checkbox"/>	<input type="checkbox"/>	<input type="checkbox"/>	<input type="checkbox"/>	<input type="checkbox"/>	<input type="checkbox"/>	<input type="checkbox"/>	<input type="checkbox"/>	<input type="checkbox"/>	<input type="checkbox"/>
Agent activity audit 	<input type="checkbox"/>	<input checked="" type="checkbox"/>	<input type="checkbox"/>	<input type="checkbox"/>	<input type="checkbox"/>	<input type="checkbox"/>	<input type="checkbox"/>	<input type="checkbox"/>	<input type="checkbox"/>	<input type="checkbox"/>
Contact search	<input type="checkbox"/>	<input type="checkbox"/>	<input type="checkbox"/>	<input type="checkbox"/>	<input type="checkbox"/>	<input type="checkbox"/>	<input type="checkbox"/>	<input type="checkbox"/>	<input type="checkbox"/>	<input type="checkbox"/>
Search contacts by conversation characteristics	<input type="checkbox"/>	<input type="checkbox"/>	<input type="checkbox"/>	<input type="checkbox"/>	<input type="checkbox"/>	<input type="checkbox"/>	<input type="checkbox"/>	<input type="checkbox"/>	<input type="checkbox"/>	<input type="checkbox"/>
Search contacts by keywords	<input type="checkbox"/>	<input type="checkbox"/>	<input type="checkbox"/>	<input type="checkbox"/>	<input type="checkbox"/>	<input type="checkbox"/>	<input type="checkbox"/>	<input type="checkbox"/>	<input type="checkbox"/>	<input type="checkbox"/>
Configure searchable contact attributes	<input type="checkbox"/>	<input type="checkbox"/>	<input type="checkbox"/>	<input type="checkbox"/>	<input type="checkbox"/>	<input type="checkbox"/>	<input type="checkbox"/>	<input type="checkbox"/>	<input type="checkbox"/>	<input type="checkbox"/>

Analytics and Optimization										
Type	All	Access	View	Edit	Create	Enable/Disable	Enable download button	Delete	Publish	Schedule
Access metrics	<input type="checkbox"/>	<input checked="" type="checkbox"/>	<input type="checkbox"/>	<input type="checkbox"/>	<input type="checkbox"/>	<input type="checkbox"/>	<input type="checkbox"/>	<input type="checkbox"/>	<input type="checkbox"/>	<input type="checkbox"/>
Real-time metrics	<input type="checkbox"/>	<input checked="" type="checkbox"/>	<input type="checkbox"/>	<input type="checkbox"/>	<input type="checkbox"/>	<input type="checkbox"/>	<input type="checkbox"/>	<input type="checkbox"/>	<input type="checkbox"/>	<input type="checkbox"/>
Historical metrics	<input type="checkbox"/>	<input checked="" type="checkbox"/>	<input type="checkbox"/>	<input type="checkbox"/>	<input type="checkbox"/>	<input type="checkbox"/>	<input type="checkbox"/>	<input type="checkbox"/>	<input type="checkbox"/>	<input type="checkbox"/>
Agent activity audit	<input type="checkbox"/>	<input checked="" type="checkbox"/>	<input type="checkbox"/>	<input type="checkbox"/>	<input type="checkbox"/>	<input type="checkbox"/>	<input type="checkbox"/>	<input type="checkbox"/>	<input type="checkbox"/>	<input type="checkbox"/>
Contact search	<input type="checkbox"/>	<input type="checkbox"/>	<input type="checkbox"/>	<input type="checkbox"/>	<input type="checkbox"/>	<input type="checkbox"/>	<input type="checkbox"/>	<input type="checkbox"/>	<input type="checkbox"/>	<input type="checkbox"/>
Search contacts by conversation characteristics	<input type="checkbox"/>	<input type="checkbox"/>	<input type="checkbox"/>	<input type="checkbox"/>	<input type="checkbox"/>	<input type="checkbox"/>	<input type="checkbox"/>	<input type="checkbox"/>	<input type="checkbox"/>	<input type="checkbox"/>
Search contacts by keywords	<input type="checkbox"/>	<input type="checkbox"/>	<input type="checkbox"/>	<input type="checkbox"/>	<input type="checkbox"/>	<input type="checkbox"/>	<input type="checkbox"/>	<input type="checkbox"/>	<input type="checkbox"/>	<input type="checkbox"/>
Configure searchable contact attributes	<input type="checkbox"/>	<input type="checkbox"/>	<input type="checkbox"/>	<input type="checkbox"/>	<input type="checkbox"/>	<input type="checkbox"/>	<input type="checkbox"/>	<input type="checkbox"/>	<input type="checkbox"/>	<input type="checkbox"/>

Users and permissions							
Type	All	View	Edit	Create	Remove	Enable / Disable	Edit permission
Users	<input type="checkbox"/>	<input checked="" type="checkbox"/>	<input type="checkbox"/>	<input type="checkbox"/>	<input type="checkbox"/>	<input type="checkbox"/>	<input type="checkbox"/>
Agent hierarchy	<input type="checkbox"/>	<input type="checkbox"/>	<input type="checkbox"/>	<input type="checkbox"/>	<input type="checkbox"/>	<input type="checkbox"/>	<input type="checkbox"/>
Security profiles	<input type="checkbox"/>	<input type="checkbox"/>	<input type="checkbox"/>	<input type="checkbox"/>	<input type="checkbox"/>	<input type="checkbox"/>	<input type="checkbox"/>
Agent status	<input type="checkbox"/>	<input type="checkbox"/>	<input type="checkbox"/>	<input type="checkbox"/>	<input type="checkbox"/>	<input type="checkbox"/>	<input type="checkbox"/>

Login/Logout reports

The Login/Logout report displays the login and logout information for the users in your contact center (for example, agents, managers, and administrators). For each user session, the login and logout times are displayed as a row in the report. You can use the report to determine the time users were logged in to Amazon Connect. The report also displays the amount of time for each session that user was logged in to Amazon Connect.

Important

By default, when an agent closes their CCP window, they are not logged out. Unless you have [customized your CCP for automatic logout](#), agents must choose the **Logout** button. Until they choose the **Logout** button, the Login/Logout report shows them as logged in.

Login/Logout report limit: 10,000 rows

- If you try to generate a Login/Logout report that has more than 10,000 rows, it won't complete.
- The Login/Logout report page displays only 10,000.
- If you schedule a Login/Logout report that contains more than 10,000 rows, the report will fail. In addition, no report output will be saved to your S3 bucket, and you cannot view the report.
- If you have a contact center with a lot of users, and your reports fail to complete, you can specify a shorter time range to reduce the size of the report generated, or apply filters to the report,

such as routing profile and agent hierarchy. You can then use other filters to capture all of the login/logout data for your instance.

Required permissions to access the Login/Logout report

Before you can generate a Login/Logout report, you need the following permissions assigned to your security profile: **Login/Logout report - View**.

Metrics and Quality ⓘ					
Type	All	Access	View	Edit	Create
Access metrics	<input type="checkbox"/>	<input type="checkbox"/>	<input type="checkbox"/>	<input type="checkbox"/>	<input type="checkbox"/>
Rules	<input type="checkbox"/>	<input type="checkbox"/>	<input type="checkbox"/>	<input type="checkbox"/>	<input type="checkbox"/>
Recorded conversations (redacted) ⓘ	<input type="checkbox"/>	<input type="checkbox"/>	<input type="checkbox"/>	<input type="checkbox"/>	<input type="checkbox"/>
Login/Logout report	<input type="checkbox"/>	<input type="checkbox"/>	<input checked="" type="checkbox"/>	<input type="checkbox"/>	<input type="checkbox"/>
Manager monitor	<input type="checkbox"/>	<input type="checkbox"/>	<input type="checkbox"/>	<input type="checkbox"/>	<input type="checkbox"/>

By default, the Amazon Connect **Admin** security profile has these permissions.

For information about how to add more permissions to an existing security profile, see [Update security profiles](#).

Generate a Login/Logout report

A Login/Logout report includes only login or logout actions by your users that occurred during the specified time range.

- If user logged in during the time range and did not log out, the report shows a login time but not a logout time.
- If the user logged in before the start of the time range, and then logged out during the time range, the report shows both the login and logout times even though the login occurred before

the start of the time range. This is so you can view the duration of the user session associated with the most recent logout.

To generate a Login/Logout report

1. Log in to the Amazon Connect admin website at https://instance_name.my.connect.aws/.
2. Choose **Analytics and optimization, Login/Logout report**.
3. On the **Login/Logout report** page, choose the **Time range** for the records to include in the report. Choose **Custom time range** to specify a range up to 7 days. This configuration is shown in the following image.

Login/Logout report

Time range and filters

Time range
Custom time range

Start date
2020-09-01

End date
2020-09-07

Time zone
UTC

Filter by
None (show all agents)

Generate report

Use **Custom time range** to specify a range up to 7 days.

4. Choose the **Time zone** to use for your report.
5. To filter data included in the report, for **Filter by**, choose a value.
6. Choose **Generate report, Save**.
7. Provide a name for the report, and choose **Save**.

Edit a Saved Login/Logout Report

After you save your report, you can edit it at any time. When you open a saved report, the time frame and date range displayed show the date and time defined when you saved the report.

To edit a saved Login/Logout report

1. Log in to the Amazon Connect admin website at [https://*instance name*.my.connect.aws/](https://instance_name.my.connect.aws/).
2. Choose **Analytics and optimization, Saved reports**.
3. Choose **Login/Logout report** and select the report to edit.
4. Update the **Time range, Time zone, and Filter by** settings.
5. To overwrite your existing report, choose **Save**.
6. To save the changes as a new report, choose **Save, Save as**. Provide a name for the report and choose **Save as**.

Download a Login/Logout report as a CSV File

When you have generated a report, you can download it as a comma-separated value (CSV) file so that you can use it other applications to work with the data, such as a spreadsheet or database.

To download a report as a CSV file

1. Open the report to download.
2. On the **Login/Logout report** page, at the top right corner, choose the **Share report** menu (arrow) next to **Save**.
3. Choose **Download CSV**. The file `Login_Logout_report.csv` is downloaded to your computer.

Share a Login/Logout report

To make the report available to other people in your organization, you can share a report. People can access the report only if they have appropriate permissions in Amazon Connect.

To share a Login/Logout report

1. On the **Login/Logout report** page, at the top right corner, choose the **Share report** menu (arrow) next to **Save**.

2. Choose **Share report**.
3. To copy the URL to the report, choose **Copy link address**. You can send the URL to others in your organization by pasting the link into an email or other document.
4. To publish the report to your organization, for **Publish report to organization**, move the toggle to **On**.
5. Choose **Save**.

Schedule a Login/Logout report

To generate a report with the same settings on a regular basis, you can schedule the report to run daily or on specific days of the week. Note that *scheduled* Login/Logout reports work differently than Login/Logout reports you [generate](#) from the user interface for a specified time range.

Important things to know

- When you schedule a report, it is automatically published to your organization. Anyone with appropriate permissions can view the report. Users with all permissions for Login/Logout reports can also edit, schedule, or delete the report.
- For scheduled Login/Logout reports, the trailing window value is always the last 24 hours.
- A scheduled report always runs at 12AM on the day you select, in the time zone that you choose.

For example, if you select Wednesday, the report runs at midnight Wednesday and does not include any data for Wednesday.

- Scheduled reports are saved as CSV files in your Amazon S3 bucket. The default time zone is UTC. To have your report run at 12AM in your local time, choose your time zone instead.
- To email a scheduled report to a list of co-workers, you need to generate the email manually using your messaging system. Amazon Connect doesn't provide an option to email the scheduled report automatically.

How to schedule a Login/Logout report

1. If you already have a saved report to schedule open, skip to step 4. Otherwise, in the dashboard, choose **Analytics and optimization, Dashboards and reports**.
2. Choose **Login/Logout report**.

3. Hover the mouse pointer over the row containing the name of the report to schedule, and choose the **Schedule report** icon.
4. On the **Schedule report** page, under **Recurrence**, for **Generate this report**, choose whether to generate the report **Daily** or **Weekly**.
5. If you choose **Weekly**, select the day or days of the week on which to run the report.
6. Choose the **Time zone**.
7. To add a prefix to the S3 path to the saved report, choose **Delivery Options** and enter a value in the **Prefix** field.

The prefix is added to the path between /Reports and the report name. For example: .../Reports/*my-prefix*/report-name-YYYY-MM-DD...

8. Choose **Create**.

After you schedule a report, you can change or delete the schedule for it at any time.

To edit or delete the schedule for a report

1. Follow the steps in the preceding section to open the **Schedule report** page.
2. To edit the schedule, choose **Edit**, update the **Recurrence** and **Delivery Options** as desired, and then choose **Save**.
3. To delete the schedule for the report, choose **Delete**, and then choose **Delete** again on the confirmation dialog.

Delete a Saved Login/Logout report

Too many reports in your report library? If you no longer want to use a saved report, you can delete it. When you delete a report, you are only deleting the settings for the report, not any reports that have already been generated using those settings. No CSV files created from a scheduled report are removed from your S3 bucket.

To delete a saved Login/Logout report

1. Open your Amazon Connect dashboard.
2. Choose **Analytics and optimization, Saved reports**.
3. Hover over the row for the report to delete, and choose the **Delete** icon.
4. Choose **Delete** again.

Tag-based access control

Amazon Connect does not currently support tag-based access controls for login/logout reports.

Amazon Connect agent event streams

Amazon Connect agent event streams are Amazon Kinesis data streams that provide you with near real-time reporting of agent activity within your Amazon Connect instance. The events published to the stream include these CCP events:

- Agent login
- Agent logout
- Agent connects with a contact
- Agent status change, such as to Available to handle contacts, or on Break or at Training.

You can use the agent event streams to create dashboards that display agent information and events, integrate streams into workforce management (WFM) solutions, and configure alerting tools to trigger custom notifications of specific agent activity. Agent event streams help you manage agent staffing and efficiency.

Contents

- [Enable agent event streams](#)
- [Sample agent event stream](#)
- [Determine how long an agent spends doing ACW](#)
- [Agent event streams data model](#)

Enable agent event streams

Agent event streams are not enabled by default. Before you can enable agent event streams in Amazon Connect, create a data stream in Amazon Kinesis Data Streams. Then, choose the Kinesis stream as the stream to use for agent event streams. Though you can use the same stream for both agent event streams and contact records, managing and getting data from the stream is much easier when you use a separate stream for each. For more information, see the [Amazon Kinesis Data Streams Developer Guide](#).

When data is sent to Kinesis, the partition key used is the agent ARN. All events for a single agent are sent to the same shard, and any resharding events in the stream are ignored.

Note

If you enable server-side encryption for the Kinesis stream you select for agent event streams, Amazon Connect cannot publish to the stream. This is because it does not have permission to Kinesis `kms:GenerateDataKey`. To work around this, first enable encryption for scheduled reports or recordings of conversations. Next, create a AWS KMS key using KMS for encryption. Finally, choose the same KMS key for your Kinesis data stream that you use for encryption of scheduled reports or recordings of conversations so that Amazon Connect has appropriate permissions to encrypt data sent to Kinesis. For more information about creating a KMS key, see [Creating Keys](#).

To enable agent event streams

1. Open the Amazon Connect console at <https://console.aws.amazon.com/connect/>.
2. On the console, choose the name in the **Instance Alias** column of the instance for which to enable agent event streams.
3. Choose **Data streaming**, then select **Enable data streaming**.
4. Under **Agent Events**, select the Kinesis stream to use, and then choose **Save**.

Sample agent event stream

In the following sample agent event stream, the agent is assigned to a routing profile that requires them to take both chats and calls. They can take one call, and up to three chats at a time.

Note

For how many chats and tasks an agent can take concurrently, see [Amazon Connect service quotas](#).

```
{  
  "AWSAccountId": "012345678901",
```



```

    "AgentARN": "arn:aws:connect:us-west-2:012345678901:instance/aaaaaaaa-bbbb-cccc-
    dddd-111111111111/agent/agent-ARN",
    "CurrentAgentSnapshot":
    {
    "AgentStatus": {
        "ARN": "example-ARN", //The ARN for the agent's current agent status (not
for the agent).
        "Name": "Available", //This shows the agent status in the CCP is set to
Available.
        "StartTimestamp": "2019-08-13T20:52:30.704Z"
    },
    "NextAgentStatus": {
        "Name": "Lunch", //They set their next status, which pauses new contacts
being routed to them while they finish their current contacts.
        "ARN": "example-ARN2", //The ARN of the agent status that the agent has
set as their next status.
        "EnqueuedTimestamp": "2019-08-13T20:58:00.004Z", //When the agent set
their next status and paused routing of incoming contacts.
    }
    },
    "Configuration": {
        "AgentHierarchyGroups": null,
        "FirstName": "AgentEventStreamTest",
        "LastName": "Agent",
        "Proficiencies": [{
            "Level": 3.0,
            "Name": "Technology",
            "Value": "Kinesis"
        }, {
            "Level": 1.0,
            "Name": "Location",
            "Value": "WA"
        }
    ],
        "RoutingProfile": {
            "ARN": "arn:aws:connect:us-west-2:012345678901:instance/aaaaaaaa-bbbb-
            cccc-dddd-111111111111/routing-profile/routing-profile-ARN",
            "Concurrency": [
                {
                    "AvailableSlots": 3, //This shows the agent has 3 slots
available.
                    //They aren't on any chats right now.
                    "Channel": "CHAT",
                    "MaximumSlots": 3 //The agent's routing profile allows them to
take up to 3 chats.
                }
            ]
        }
    }
}

```

```

    },
    {
      "AvailableSlots": 1, //The agent has 1 slot available to take a
call.
      "Channel": "VOICE",
      "MaximumSlots": 1 //The agent's routing profile allows them to
take 1 call at a time.
    }
  ],
  "DefaultOutboundQueue": {
    "ARN": "arn:aws:connect:us-west-2:012345678901:instance/aaaaaaa-
bbb-bbbb-cccc-dddd-111111111111/queue/queue-ARN",
    "Channels": [
      "VOICE" //This outbound queue only works for calls.
    ],
    "Name": "OutboundQueue"
  },
  "InboundQueues": [
    {
      "ARN": "arn:aws:connect:us-west-2:012345678901:instance/
aaaaaaa-bbbb-cccc-dddd-111111111111/queue/agent/agent-ARN",
      "Channels": [
        "VOICE",
        "CHAT"
      ],
      "Name": null //This queue has a name of "null" because it's an
agent queue,
      //and agent queues don't have names.
    },
    {
      "ARN": "arn:aws:connect:us-west-2:012345678901:instance/
aaaaaaa-bbbb-cccc-dddd-111111111111/queue/queue-ARN",
      "Channels": [
        "CHAT",
        "VOICE"
      ],
      "Name": "Omni-channel-queue" //This inbound queue takes both
chats and calls.
    }
  ],
  "Name": "AgentEventStreamProfile"
},
"Username": "aestest"
},

```

```

    "Contacts": [ ]
  },
  "EventId": "EventId-1",
  "EventTimestamp": "2019-08-13T20:58:44.031Z",
  "EventType": "HEART_BEAT",
  "InstanceARN": "arn:aws:connect:us-west-2:012345678901:instance/aaaaaaaa-bbbb-cccc-
  dddd-111111111111",
  "PreviousAgentSnapshot": {
    "AgentStatus": {
      "ARN": "arn:aws:connect:us-west-2:012345678901:instance/aaaaaaaa-bbbb-cccc-
  dddd-111111111111/agent-state/agent-state-ARN",
      "Name": "Offline",
      "StartTimestamp": "2019-08-13T20:52:30.704Z"
    },
    "Configuration": {
      "AgentHierarchyGroups": null,
      "FirstName": "AgentEventStreamTest",
      "LastName": "Agent",
      "Proficiencies": [{
        "Level": 3.0,
        "Name": "Technology",
        "Value": "Kinesis"
      }, {
        "Level": 1.0,
        "Name": "Location",
        "Value": "WA"
      }],
      "RoutingProfile": {
        "ARN": "arn:aws:connect:us-west-2:012345678901:instance/aaaaaaaa-bbbb-
  cccc-ddd-111111111111/routing-profile/routing-profile-ARN",
        "Concurrency": [
          {
            "AvailableSlots": 3,
            "Channel": "CHAT",
            "MaximumSlots": 3
          },
          {
            "AvailableSlots": 1,
            "Channel": "VOICE",
            "MaximumSlots": 1
          }
        ],
        "DefaultOutboundQueue": {

```

```

        "ARN": "arn:aws:connect:us-west-2:012345678901:instance/aaaaaaa-
bbbb-cccc-dddd-111111111111/queue/queue-ARN",
        "Channels": [
            "VOICE"
        ],
        "Name": "OutboundQueue"
    },
    "InboundQueues": [
        {
            "ARN": "arn:aws:connect:us-west-2:012345678901:instance/
aaaaaaa-bbbb-cccc-dddd-111111111111/queue/agent/agent-ARN",
            "Channels": [
                "VOICE",
                "CHAT"
            ],
            "Name": null
        },
        {
            "ARN": "arn:aws:connect:us-west-2:012345678901:instance/
aaaaaaa-bbbb-cccc-dddd-111111111111/queue/queue-ARN",
            "Channels": [
                "CHAT",
                "VOICE"
            ],
            "Name": "Omni-channel-queue"
        }
    ],
    "Name": "AgentEventStreamProfile"
},
"Username": "aestest"
},
"Contacts": [ ]
},
"Version": "2017-10-01"
}

```

Determine how long an agent spends doing ACW

There's no event in the agent event stream that tells you how long a contact is in the ACW state, and by extension how long an agent spends doing ACW. However, there's other data in the agent event stream that you can use to figure this out.

First, identify when the contact entered ACW. Here's how to do that:

1. Identify when the conversation between the contact and agent ENDED.
2. View the StateStartTimeStamp for the event.

For example, in the following agent event stream output, the contact enters ACW state at "**StateStartTimeStamp**": "2019-05-25T18:55:27.017Z".

Tip

In the agent event stream, events are listed in reverse chronological order. We recommend reading through following examples by starting at the bottom of each example.

```
{
  "AWSAccountId": "012345678901",
  "AgentARN": "arn:aws:connect:us-east-1:012345678901:instance/aaaaaaaa-bbbb-cccc-
  dddd-111111111111/agent/agent-ARN",
  "CurrentAgentSnapshot": {
    "AgentStatus": {
      "ARN": "arn:aws:connect:us-east-1:012345678901:instance/aaaaaaaa-bbbb-cccc-
  dddd-111111111111/agent-state/agent-state-ARN",
      "Name": "Available", //This just refers to the status that the agent sets
  manually in the CCP.
      It means they are ready to handle contacts, not say, on Break.
      "StartTimeStamp": "2019-05-25T18:43:59.049Z"
    },
    "Configuration": {
      "AgentHierarchyGroups": null,
      "FirstName": "(Removed)",
      "LastName": "(Removed)",
      "RoutingProfile": {
        "ARN": "arn:aws:connect:us-east-1:012345678901:instance/aaaaaaaa-bbbb-
  cccc-dddd-111111111111/routing-profile/routing-profile-ARN",
        "DefaultOutboundQueue": {
          "ARN": "arn:aws:connect:us-east-1:012345678901:instance/aaaaaaaa-
  bbbb-cccc-dddd-111111111111/queue/queue-ARN-for-BasicQueue",
          "Name": "BasicQueue"
        },
        "InboundQueues": [
          {
            "ARN": "arn:aws:connect:us-east-1:012345678901:instance/
  aaaaaaaaa-bbbb-cccc-dddd-111111111111/queue/queue-ARN-for-BasicQueue",
```

```

        "Name": "BasicQueue"
      },
      {
        "ARN": "arn:aws:connect:us-east-1:012345678901:instance/
aaaaaaa-bbbb-cccc-dddd-111111111111/queue/queue-ARN-for-PrimaryQueue",
        "Name": "PrimaryQueue"
      }
    ],
    "Name": "Basic Routing Profile"
  },
  "Username": "(Removed)"
},
"Contacts": [
  {
    "Channel": "VOICE",
    "ConnectedToAgentTimestamp": "2019-05-25T18:55:21.011Z",
    "ContactId": "ContactId-1", //This is the same contact the agent was
working on when their state was CONNECTED (below).
    "InitialContactId": null,
    "InitiationMethod": "OUTBOUND", //This indicates how the contact was
initiated. OUTBOUND means the agent initiated contact with the customer.
INBOUND means the customer initiated contact with your center.
    "Queue": {
      "ARN": "arn:aws:connect:us-east-1:012345678901:instance/aaaaaaa-
bbbb-cccc-dddd-111111111111/queue/queue-ARN-for-BasicQueue",
      "Name": "BasicQueue"
    },
    "QueueTimestamp": null,
    "State": "ENDED", //This shows the conversation has ended.
    "StateStartTimestamp": "2019-05-25T18:55:27.017Z" //This is the
timestamp for the ENDED event (above),
which is when the contact entered ACW state.
  }
]
},
"EventId": "EventId-1",
"EventTimestamp": "2019-05-25T18:55:27.017Z",
"EventType": "STATE_CHANGE", //This shows that the state of the contact has
changed; above we can see the conversation ENDED.
"InstanceARN": "arn:aws:connect:us-east-1:012345678901:instance/aaaaaaa-bbbb-cccc-
dddd-111111111111",
"PreviousAgentSnapshot": {

```

```

    "AgentStatus": {
      "ARN": "arn:aws:connect:us-east-1:012345678901:instance/aaaaaaaa-bbbb-cccc-
      dddd-111111111111/agent-state/agent-state-ARN",
      "Name": "Available", //This just refers to the status that the agent sets
      manually in the CCP.
      It means they were ready to handle contacts, not say, on Break.
      "StartTimestamp": "2019-05-25T18:43:59.049Z"
    },
    "Configuration": {
      "AgentHierarchyGroups": null,
      "FirstName": "(Removed)",
      "LastName": "(Removed)",
      "RoutingProfile": {
        "ARN": "arn:aws:connect:us-east-1:012345678901:instance/aaaaaaaa-bbbb-
        cccc-dddd-111111111111/routing-profile/routing-profile-ARN",
        "DefaultOutboundQueue": {
          "ARN": "arn:aws:connect:us-east-1:012345678901:instance/aaaaaaaa-
          bbbb-cccc-dddd-111111111111/queue/queue-ARN-for-BasicQueue",
          "Name": "BasicQueue"
        },
        "InboundQueues": [
          {
            "ARN": "arn:aws:connect:us-east-1:012345678901:instance/
            aaaaaaaaa-bbbb-cccc-dddd-111111111111/queue/queue-ARN-for-BasicQueue",
            "Name": "BasicQueue"
          },
          {
            "ARN": "arn:aws:connect:us-east-1:012345678901:instance/
            aaaaaaaaa-bbbb-cccc-dddd-111111111111/queue/queue-ARN-for-PrimaryQueue",
            "Name": "PrimaryQueue"
          }
        ],
        "Name": "Basic Routing Profile"
      },
      "Username": "(Removed)"
    },
    "Contacts": [
      {
        "Channel": "VOICE", //This shows the agent and contact were talking on
        the phone.
        "ConnectedToAgentTimestamp": "2019-05-25T18:55:21.011Z",
        "ContactId": "ContactId-1", //This shows the agent was working with a
        contact identified as "ContactId-1".
        "InitialContactId": null,

```

```

        "InitiationMethod": "OUTBOUND",
        "Queue": {
            "ARN": "arn:aws:connect:us-east-1:012345678901:instance/aaaaaaaa-
bbbb-cccc-dddd-111111111111/queue/queue-ARN-for-BasicQueue",
            "Name": "BasicQueue"
        },
        "QueueTimestamp": null,
        "State": "CONNECTED", //This shows the contact was CONNECTED to the
agent, instead of say, MISSED.
        "StateStartTimestamp": "2019-05-25T18:55:21.011Z" //This shows when
the contact was connected to the agent.
    }
}
    ],
    "Version": "2019-05-25"
}

```

Next, determine when a contact left ACW. Here's how to do that:

1. Find where the `CurrentAgentSnapshot` has no contacts, and the state for the contact listed in the `PreviousAgentSnapshot` equals `ENDED`.

Because a `STATE_CHANGE` event also occurs when the agent's configuration is changed, such as when they are assigned a different routing profile, this step confirms you have the right event.

2. Find where the `EventType` = `"STATE_CHANGE"`.
3. View the `EventTimeStamp` for it.

For example, in the following agent event stream file, the contact left ACW at `"EventTimeStamp": "2019-05-25T18:55:32.022Z"`.

```

{
  "AWSAccountId": "012345678901",
  "AgentARN": "arn:aws:connect:us-east-1:012345678901:instance/aaaaaaaa-bbbb-cccc-
dddd-111111111111/agent/agent-ARN",
  "CurrentAgentSnapshot": {
    "AgentStatus": {
      "ARN": "arn:aws:connect:us-east-1:012345678901:instance/aaaaaaaa-bbbb-cccc-
dddd-111111111111/agent-state/agent-state-ARN",
      "Name": "Available", //This just refers to the status that the agent sets
manually in the CCP. It means they

```

are ready to handle contacts, not say, on Break.

```

    "StartTimestamp": "2019-05-25T18:43:59.049Z"
  },
  "Configuration": {
    "AgentHierarchyGroups": null,
    "FirstName": "(Removed)",
    "LastName": "(Removed)",
    "RoutingProfile": {
      "ARN": "arn:aws:connect:us-east-1:012345678901:instance/aaaaaaaa-bbbb-
cccc-dddd-111111111111/routing-profile/routing-profile-ARN",
      "DefaultOutboundQueue": {
        "ARN": "arn:aws:connect:us-east-1:012345678901:instance/aaaaaaaa-
bbbb-cccc-dddd-111111111111/queue/queue-ARN-for-BasicQueue",
        "Name": "BasicQueue"
      },
      "InboundQueues": [
        {
          "ARN": "arn:aws:connect:us-east-1:012345678901:instance/
aaaaaaaa-bbbb-cccc-dddd-111111111111/queue/queue-ARN-for-BasicQueue",
          "Name": "BasicQueue"
        },
        {
          "ARN": "arn:aws:connect:us-east-1:012345678901:instance/
aaaaaaaa-bbbb-cccc-dddd-111111111111/queue/queue-ARN-for-PrimaryQueue",
          "Name": "PrimaryQueue"
        }
      ],
      "Name": "Basic Routing Profile"
    },
    "Username": "(Removed)"
  },
  "Contacts": [] //Since a contact isn't listed here, it means ACW for
ContactId-1 (below)
is finished, and the agent is ready for a new contact to be routed to
them.
  },
  "EventId": "477f2c4f-cd1a-4785-b1a8-97023dc1229d",
  "EventTimestamp": "2019-05-25T18:55:32.022Z", //Here's the EventTimestamp for the
STATE_CHANGE event. This is when
the contact left ACW.
  "EventType": "STATE_CHANGE", //Here's the STATE_CHANGE
  "InstanceARN": "arn:aws:connect:us-east-1:012345678901:instance/aaaaaaaa-bbbb-cccc-
dddd-111111111111",
  "PreviousAgentSnapshot": {

```

```

    "AgentStatus": {
      "ARN": "arn:aws:connect:us-east-1:012345678901:instance/aaaaaaaa-bbbb-cccc-
      dddd-111111111111/agent-state/agent-state-ARN",
      "Name": "Available", //This just refers to the status that the agent sets
      manually in the CCP.
      "StartTimestamp": "2019-05-25T18:43:59.049Z"
    },
    "Configuration": {
      "AgentHierarchyGroups": null,
      "FirstName": "(Removed)",
      "LastName": "(Removed)",
      "RoutingProfile": {
        "ARN": "arn:aws:connect:us-east-1:012345678901:instance/aaaaaaaa-bbbb-
        cccc-dddd-111111111111/routing-profile/routing-profile-ARN",
        "DefaultOutboundQueue": {
          "ARN": "arn:aws:connect:us-east-1:012345678901:instance/aaaaaaaa-
          bbbb-cccc-dddd-111111111111/queue/queue-ARN-for-BasicQueue",
          "Name": "BasicQueue"
        },
        "InboundQueues": [
          {
            "ARN": "arn:aws:connect:us-east-1:012345678901:instance/
            aaaaaaaaa-bbbb-cccc-dddd-111111111111/queue/queue-ARN-for-BasicQueue",
            "Name": "BasicQueue"
          },
          {
            "ARN": "arn:aws:connect:us-east-1:012345678901:instance/
            aaaaaaaaa-bbbb-cccc-dddd-111111111111/queue/queue-ARN-for-PrimaryQueue",
            "Name": "PrimaryQueue"
          }
        ],
        "Name": "Basic Routing Profile"
      },
      "Username": "(Removed)"
    },
    "Contacts": [
      {
        "Channel": "VOICE",
        "ConnectedToAgentTimestamp": "2019-05-25T18:55:21.011Z",
        "ContactId": "ContactId-1", //This is the ContactId of the customer
        the agent was working on previously.
        "InitialContactId": null,
        "InitiationMethod": "OUTBOUND",

```

```
    "Queue": {
      "ARN": "arn:aws:connect:us-east-1:012345678901:instance/aaaaaaaa-
bbbb-cccc-dddd-111111111111/queue/queue-ARN-for-BasicQueue",
      "Name": "BasicQueue"
    },
    "QueueTimestamp": null,
    "State": "ENDED", //The ACW for ContactId-1 has ended.
    "StateStartTimestamp": "2019-05-25T18:55:27.017Z"
  }
]
},
"Version": "2019-05-25"
}
```

Finally, to calculate the amount of time the contact was in the ACW state, and thus how long the agent spent working on it:

- Subtract the **"StateStartTimestamp"**: "2019-05-25T18:55:27.017Z" from the **"EventTimestamp"**: "2019-05-25T18:55:32.022Z".

In this example, the agent spent 5.005 seconds doing ACW for ContactId-1.

Agent event streams data model

Agent event streams are created in JavaScript Object Notation (JSON) format. For each event type, a JSON blob is sent to the Kinesis data stream. The following event types are included in agent event streams:

- LOGIN—An agent login to the contact center.
- LOGOUT—An agent logout from the contact center.
- STATE_CHANGE—One of the following changed:
 - The agent changed their status in the Contact Control Panel (CCP). For example, they changed it from Available to on Break.
 - The state of the conversation between the agent and contact changed. For example, they were connected and then on hold.
 - One of the following settings changed in the agent's configuration:
 - Their routing profile
 - The queues in their routing profile

- Auto-accept call
 - Sip address
 - Agent hierarchy group
 - Language preference setting in the CCP
- HEART_BEAT—This event is published every 120 seconds if there are no other events published during that interval.

 **Note**

These events continue to be published up to an hour after an agent has logged off.

Event Objects

- [AgentEvent](#)
- [AgentSnapshot](#)
- [Configuration](#)
- [Contact object](#)
- [HierarchyGroup object](#)
- [AgentHierarchyGroups object](#)
- [Proficiency](#)
- [Queue object](#)
- [RoutingProfile object](#)

AgentEvent

The AgentEvent object includes the following properties:

AgentARN

The Amazon Resource Name (ARN) for the agent account.

Type: ARN

AWSAccountId

The 12-digit AWS account ID for the AWS account associated with the Amazon Connect instance.

Type: String

CurrentAgentSnapshot

Contains agent configuration, such as username, first name, last name, routing profile, hierarchy groups, contacts, and agent status.

Type: AgentSnapshot object

EventId

Universally unique identifier (UUID) for the event.

Type: String

EventTimestamp

A time stamp for the event, in ISO 8601 standard format.

Type: String (*yyyy-mm-ddThh:mm:ss.sssZ*)

EventType

The type of event.

Valid values: STATE_CHANGE | HEART_BEAT | LOGIN | LOGOUT

InstanceARN

Amazon Resource Name for the Amazon Connect instance in which the agent's user account is created.

Type: ARN

PreviousAgentSnapshot

Contains agent configuration, such as username, first name, last name, routing profile, hierarchy groups), contacts, and agent status.

Type: AgentSnapshot object

Version

The version of the agent event stream in date format, such as 2019-05-25.

Type: String

AgentSnapshot

The AgentSnapshot object includes the following properties:

AgentStatus

Agent status data, including:

- ARN—The ARN for the agent's current agent status (not for the agent).
- Name—This is the [status of the agent that they manually set in the CCP](#), or that the supervisor manually [changes in the real-time metrics report](#).

For example, their status might be **Available**, which means that they are ready for inbound contacts to be routed to them. Or it might be a custom status, such as Break or Training, which means that inbound contacts can't be routed to them BUT they can still make outbound calls.

A status of **Default** indicates an internal Amazon Connect error.

- StartTimestamp—The timestamp in ISO 8601 standard format for the time at which the agent entered the status.

Type: String (yyyy-mm-ddThh:mm:ss.sssZ)

- Type—ROUTABLE, CUSTOM, or OFFLINE

Type: AgentStatus object.

NextAgentStatus

If the agent set a next agent status, the data appears here.

- ARN—The ARN of the agent status that the agent has set as their next status.
- Name—This is the name of the agent status that the agent has set as their next status.
- EnqueuedTimestamp—The timestamp in ISO 8601 standard format for the time at which the agent set their next status and paused routing of incoming contacts.

Type: String (yyyy-mm-ddThh:mm:ss.sssZ)

Type: NextAgentStatus object.

Configuration

Information about the agent, including:

- **FirstName**—The agent's first name.
- **HierarchyGroups**—The hierarchy group the agent is assigned to, if any.
- **LastName**—The agent's last name.
- **RoutingProfile**—The routing profile the agent is assigned to.
- **Username**—the agent's Amazon Connect user name.

Type: Configuration object

Contacts

The contacts

Type: List of Contact Objects object

Configuration

The Configuration object includes the following properties:

FirstName

The first name entered in the agent's Amazon Connect account.

Type: String

Length: 1-100

AgentHierarchyGroups

The hierarchy group, up to five levels of grouping, for the agent associated with the event.

Type: AgentHierarchyGroups object

LastName

The last name entered in the agent's Amazon Connect account.

Type: String

Length: 1-100

Proficiencies

List of all the proficiencies assigned to the agent.

Type: List of Proficiency objects

RoutingProfile

The routing profile assigned to the agent associated with the event.

Type: RoutingProfile object.

Username

The user name for the agent's Amazon Connect user account.

Type: String

Length: 1-100

Contact object

The Contact object includes the following properties:

ContactId

The identifier for the contact.

Type: String

Length: 1-256

InitialContactId

The original identifier of the contact that was transferred.

Type: String

Length: 1-256

Channel

The method of communication.

Valid values: VOICE, CHAT, TASKS

InitiationMethod

Indicates how the contact was initiated.

Valid values:

- **INBOUND:** The customer initiated voice (phone) contact with your contact center.
- **OUTBOUND:** An agent initiated voice (phone) contact with the customer, by using the CCP to call their number. This initiation method calls the [StartOutboundVoiceContact](#) API.
- **TRANSFER:** The customer was transferred by an agent to another agent or to a queue, using quick connects in the CCP. This results in a new contact record being created.
- **CALLBACK:** The customer was contacted as part of a callback flow.

For more information about the InitiationMethod in this scenario, see [About queued callbacks in metrics](#).

- **API:** The contact was initiated with Amazon Connect by API. This could be an outbound contact you created and queued to an agent, using the [StartOutboundVoiceContact](#) API, or it could be a live chat that was initiated by the customer with your contact center, where you called the [StartChatConnect](#) API.
- **QUEUE_TRANSFER:** While the customer was in one queue (listening to Customer queue flow), they were transferred into another queue using a flow block.
- **MONITOR:** A supervisor initiated monitor on an agent. The supervisor can silently monitor the agent and customer, or barge the conversation.

Note

This status shows only if you have opted into [Multi-Party Calls and Enhanced Monitoring](#).

- **DISCONNECT:** When a [Set disconnect flow](#) block is triggered, it specifies which flow to run after a disconnect event during a contact.

A disconnect event is when:

- A chat, or task is disconnected.
- A task is disconnected as a result of a flow action.
- A task expires. The task is automatically disconnected if it is not completed in 7 days.

If a new contact is created while running a disconnect flow, then the initiation method for that new contact is DISCONNECT.

State

The state of the contact.

Valid values: INCOMING | PENDING | CONNECTING | CONNECTED | CONNECTED_ONHOLD | MISSED | PAUSED | REJECTED | ERROR | ENDED

Note

The PAUSED state is only available for tasks.

StateStartTimestamp

The time at which the contact entered the current state.

Type: String (*yyyy-mm-ddThh:mm:ss.sssZ*)

ConnectedToAgentTimestamp

The time at which the contact was connected to an agent.

Type: String (*yyyy-mm-ddThh:mm:ss.sssZ*)

QueueTimestamp

The time at which the contact was put into a queue.

Type: String (*yyyy-mm-ddThh:mm:ss.sssZ*)

Queue

The queue the contact was placed in.

Type: Queue object

HierarchyGroup object

The HierarchyGroup object includes the following properties:

ARN

The Amazon Resource Name (ARN) for the agent hierarchy.

Type: String

Name

The name of the hierarchy group.

Type: String

AgentHierarchyGroups object

The AgentHierarchyGroups object includes the following properties:

Level1

Includes details for Level1 of the hierarchy assigned to the agent.

Type: HierarchyGroup object

Level2

Includes details for Level2 of the hierarchy assigned to the agent.

Type: HierarchyGroup object

Level3

Includes details for Level3 of the hierarchy assigned to the agent.

Type: HierarchyGroup object

Level4

Includes details for Level4 of the hierarchy assigned to the agent.

Type: HierarchyGroup object

Level5

Includes details for Level5 of the hierarchy assigned to the agent.

Type: HierarchyGroup object

Proficiency

The Proficiency object includes the following properties:

Name

The name of predefined attribute.

Type: String

Length: 1-64

Value

The value of predefined attribute.

Type: String

ProficiencyLevel

The proficiency level of the agent.

Type: Float

Valid values: 1.0, 2.0, 3.0, 4.0 and 5.0

Queue object

The Queue object includes the following properties:

ARN

The Amazon Resource Name (ARN) for the queue.

Type: String

Name

The name of the queue.

Type: String

Channels

The type of communication channel.

Type: List of Channel objects

RoutingProfile object

The RoutingProfile object includes the following properties:

ARN

The Amazon Resource Name (ARN) for the agent's routing profile.

Type: String

Name

The name of the routing profile.

Type: String

InboundQueues

The Queue objects associated with the agent's routing profile.

Type: List of Queue object

DefaultOutboundQueue

The default outbound queue for the agent's routing profile.

Type: Queue object

Concurrency

A list of concurrency information. Concurrency information objects have AvailableSlots (number), Channel (a channel object), and MaximumSlots (number) values.

Amazon Connect contact events

Amazon Connect allows you to subscribe to a near real-time stream of contact (voice calls, chat, and task) events (for example, call is queued) in your Amazon Connect contact center.

You can use contact events to create analytics dashboards to monitor and track contact activity, integrate into workforce management (WFM) solutions to better understand contact center performance, or to integrate applications that react to events (for example, call disconnected) in real-time.

Contents

- [Subscribe to Amazon Connect contact events](#)
- [Contact events data model](#)
- [Contact timestamps](#)
- [Sample to stop streaming an event type](#)
- [Sample contact event for when a voice call is connected to an agent](#)
- [Sample contact event for when a voice call is disconnected](#)
- [Sample event for when contact properties are updated](#)
- [Sample contact event for when a voice call is connected to an agent using routing criteria](#)
- [Sample event for when routing step expires on a contact](#)
- [Sample contact event for when a voice call is connected to an agent provided by the customer using routing criteria](#)

Subscribe to Amazon Connect contact events

Amazon Connect contact events are published using [Amazon EventBridge](#), and can be enabled in a couple of steps for your Amazon Connect instance in the Amazon EventBridge console by creating a new rule. Although events are not ordered, they have a timestamp which enables you to consume the data.

Events are emitted on a [best effort](#) basis.

To subscribe to Amazon Connect contact events:

1. In the Amazon EventBridge console, choose **Create rule**.

2. On the **Default rule detail** page, assign a name to the rule, choose **Rule with an event pattern**, and then choose **Next**, as shown in the following image.

Define rule detail [Info](#)

Rule detail

Name
 Maximum of 64 characters consisting of numbers, lower/upper case letters, -_~.

Description - optional

Event bus [Info](#)
 Select the event bus this rule applies to, either the default event bus or a custom or partner event bus.
 default

Enable the rule on the selected event bus

Rule type [Info](#)

Rule with an event pattern
 A rule that runs when an event matches the defined event pattern. EventBridge sends the event to the specified target.

Schedule
 A rule that runs on a schedule

Cancel **Next**

3. On the **Build event pattern** page, under **Event source**, verify that **AWS events or EventBridge partner events** is selected.
4. Under **Sample event type**, choose **AWS events**, and then choose **Amazon Connect Contact Event** from the dropdown box, as shown in the following image.

Sample event - optional

You don't have to select or enter a sample event, but it's recommended so you can reference it when writing and testing the event pattern, or filter criteria.

You can reference the sample event when you write the event pattern, or use the sample event to test if it matches the event pattern. Find a sample event, enter your own, or edit a sample event below. [Learn more about the required fields in a sample event.](#)

Sample event type

AWS events EventBridge partner events

Enter my own

Sample events
 Filter by event source and type or by keyword.

Amazon Connect Contact Event

5. For Creation method choose Use pattern form. In the **Event pattern** section, choose **AWS services, Amazon Connect, Amazon Connect Contact Event**, and then choose **Next**, as shown in the following image.

Creation method

Method

Use schema
Use an Amazon EventBridge schema to generate the event pattern.

Use pattern form
Use a template provided by EventBridge to create an event pattern.

Custom pattern (JSON editor)
Write an event pattern in JSON.

Event pattern [Info](#)

Event source
AWS service or EventBridge partner as source

AWS services ▼

AWS service
The name of the AWS service as the event source



Amazon Connect ▼

Event type
The type of events as the source of the matching pattern

Amazon Connect Contact Event ▼

Event pattern
Event pattern, or filter to match the events

```
1 {  
2   "source": ["aws.connect"],  
3   "detail-type": ["Amazon Connect Contact Event"]  
4 }
```

 Copy  Test pattern  Edit pattern

6. On the **Select target(s)** page, you can then select a target of your choice, which includes a Lambda function, SQS queue, or SNS topic. For information about configuring targets, [Amazon EventBridge targets](#).
7. Optionally configure tags. On the **Review and create** page, choose **Create rule**.

For more information about configuring rules, see [Amazon EventBridge rules](#) in the *Amazon EventBridge User Guide*.

Contact events data model

Contact events are generated in JSON. For each event type, a JSON blob is sent to the target of your choice, as configured in the rule. The following contact events are available:

- **AMD_DISABLED** - Answering machine detection is disabled.
- **INITIATED** - A voice call, chat, or task is initiated or transferred.
- **CONNECTED_TO_SYSTEM** - The contact has established media (for example, it was answered by a person or by voicemail). This event is generated for any of the [AnsweringMachineDetectionStatus](#) codes.

Note

This event is generated for outbound calls (including [Amazon Connect outbound campaigns](#)) tasks, and chats.

- **CONTACT_DATA_UPDATED** - One or more of the following contact properties were updated on a voice call, chat, or task: scheduled timestamp (task only), user-defined attributes and tags, routing criteria is updated or step is expired, and if Contact Lens is enabled for a given contact.
- **QUEUED** - A voice call, chat, or task is queued to be assigned to an agent.
- **CONNECTED_TO_AGENT** - A voice call, chat, or task is connected to an agent.
- **DISCONNECTED** - A voice call, chat, or task is disconnected. For outbound calls, the dial attempt is not successful, the attempt is connected but the call is not picked up, or the attempt results in a [SIT tone](#).

A disconnect event is when:

- A chat, or task is disconnected.
- A task is disconnected as a result of a flow action.
- A task expires. The task is automatically disconnected if it is not completed in 7 days.
- **PAUSED** - An active task contact was paused.
- **RESUMED** - A paused task contact was resumed.

Event Objects

- [AgentInfo](#)
- [AttributeCondition](#)

- [Campaign](#)
- [Contact event](#)
- [CustomerVoiceActivity](#)
- [Expiry](#)
- [Expression](#)
- [QueueInfo](#)
- [RoutingCriteria](#)
- [Steps](#)

AgentInfo

The AgentInfo object includes the following properties:

AgentArn

The Amazon Resource Name (ARN) for the agent account.

Type: ARN

HierarchyGroups

The agent hierarchy group for the agent.

Type: ARN

AttributeCondition

An object to specify the predefined attribute condition.

Name

The name of predefined attribute.

Type: String

Length: 1-64

Value

The value of predefined attribute.

Type: String

Length: 1-64

ComparisonOperator

The operator of the condition.

Type: String

Valid values: NumberGreaterOrEqualTo

ProficiencyLevel

The proficiency level of the condition.

Type: Float

Valid values: 1.0, 2.0, 3.0, 4.0 and 5.0

MatchCriteria

An object to define AgentsCriteria.

Type: MatchCriteria object

AgentsCriteria

An Object to define agentIds.

Type: AgentsCriteria object

AgentIds

An object to specify a list of agents, by Agent ID.

Type: Array of strings

Length Constraints: Maximum length of 256

Campaign

Information associated with a campaign.

Type: [Campaign](#) object

Contact event

The Contact object includes the following properties:

ContactId

The identifier for the contact.

Type: String

Length: 1-256

InitialContactId

The identifier of the initial contact.

Type: String

Length: 1-256

RelatedContactId

The contactId that is [related](#) to this contact.

Type: String

Length: Minimum of 1. Maximum of 256.

PreviousContactId

The original identifier of the contact that was transferred.

Type: String

Length: 1-256

Channel

The type of channel.

Type: VOICE, CHAT, or TASK

InstanceArn

Amazon Resource Name (ARN) for the Amazon Connect instance in which the agent's user account is created.

Type: ARN

InitiationMethod

Indicates how the contact was initiated.

Valid values:

- **INBOUND:** The customer initiated voice (phone) contact with your contact center.
- **OUTBOUND:** Represents an agent-initiated outbound voice call from the Contact Control Panel (CCP).
- **TRANSFER:** The contact was transferred by an agent to another agent or to a queue, using quick connects in the CCP. This results in a new contact record being created.
- **CALLBACK:** The customer was contacted as part of a callback flow. For more information about the InitiationMethod in this scenario, see [About queued callbacks in metrics](#).
- **API:** The contact was initiated with Amazon Connect by API. This could be an outbound contact you created and queued to an agent, using the [StartOutboundVoiceContact](#) API, or it could be a live chat that was initiated by the customer with your contact center, where you called the [StartChatContact](#) API, or it could be a tasks initiated by the customer by calling the [StartTaskContact](#) API.
- **QUEUE_TRANSFER:** While the contact is one queue, and was then transferred into another queue using a flow block.
- **EXTERNAL_OUTBOUND:** An agent initiated voice (phone) contact with an external participant to your contact center using either quick connect in the CCP or a flow block.
- **MONITOR:** A supervisor initiated monitor on an agent. The supervisor can silently monitor the agent and customer, or barge the conversation.
- **DISCONNECT:** When a [Set disconnect flow](#) block is triggered, it specifies which flow to run after a disconnect event.

A disconnect event is when:

- A chat, or task is disconnected.
- A task is disconnected as a result of a flow action.
- A task expires. The task is automatically disconnected if it is not completed in 7 days.

When the disconnect event occurs, the corresponding content flow runs. If a new contact is created while running a disconnect flow, then the initiation method for that new contact is DISCONNECT.

DisconnectReason code

Indicates how the contact was terminated. This is available for the contacts of outbound campaigns in which the media connection failed.

Valid values:

- **OUTBOUND_DESTINATION_ENDPOINT_ERROR**: Current configurations do not allow this destination to be dialed (for example, calling an endpoint destination from an ineligible instance).
- **OUTBOUND_RESOURCE_ERROR**: Instance has insufficient permissions to make outbound calls or necessary resources were not found.
- **OUTBOUND_ATTEMPT_FAILED**: There was an unknown error, invalid parameter, or insufficient permissions to call the API.
- **EXPIRED**: Not enough agents available, or not enough telecom capacity for such calls.

AnsweringMachineDetectionStatus

Indicates how an [outbound campaign](#) call is actually disposed if the contact is connected to Amazon Connect.

Type: String

Valid values:

- **HUMAN_ANSWERED**: The number dialed was answered by a person.
- **VOICEMAIL_BEEP**: The number dialed was answered by voicemail with a beep.
- **VOICEMAIL_NO_BEEP**: The number dialed was answered by a voicemail with no beep.
- **AMD_UNANSWERED**: The number dialed kept ringing, but the call was not picked up.
- **AMD_UNRESOLVED**: The number dialed was connected but the answering machine detection could not determine whether the call was picked up by a person or voicemail.
- **AMD_NOT_APPLICABLE**: The call disconnected before ringing, and there was no media to detect.
- **SIT_TONE_BUSY**: The number dialed was busy

- `SIT_TONE_INVALID_NUMBER`: The number dialed was not a valid number.
- `SIT_TONE_DETECTED`: A special information tone (SIT) was detected.
- `FAX_MACHINE_DETECTED`: A fax machine was detected.
- `AMD_ERROR`: The number dialed was connected, but there was an error in answering machine detection.

EventType

The type of event published.

Type: String

Valid values: `INITIATED`, `CONNECTED_TO_SYSTEM`, `CONTACT_DATA_UPDATED`, `QUEUED`, `CONNECTED_TO_AGENT`, `DISCONNECTED`

UpdatedProperties

The type of property updated.

Type: String

Valid values: `ScheduledTimestamp`, `UserDefinedAttributes`, `ContactLens.ConversationalAnalytics.Configuration`, `Tags`

AgentInfo

The agent the contact was assigned to.

Type: AgentInfo object

QueueInfo

The queue the contact was placed in.

Type: QueueInfo object

ContactLens

Contact Lens information if Contact Lens is enabled on the flow.

Type: For more information about the ContactLens object, see the [UpdateContactRecordingBehavior](#) action in the *Flow language* section of the *Amazon Connect API Reference*.

SegmentAttributes

A set of system defined key-value pairs stored on individual contact segments using an attribute map. The attributes are standard Amazon Connect attributes and can be accessed in flows. Attribute keys can include only alphanumeric, -, and _ characters.

This field can be used to show channel subtype. For example, `connect:Guide` or `connect:SMS`.

Type: SegmentAttributes

Members: SegmentAttributeName, SegmentAttributeValue

Tags

[Tags](#) associated with the contact. This contains both AWS generated and user-defined tags.

Type: String to string map

CustomerVoiceActivity

The CustomerVoiceActivity object includes the following properties:

GreetingStartTimestamp

The date and time that measures the beginning of the customer greeting from an outbound voice call, in UTC time.

Type: String (yyyy-MM-dd'T'HH:mm:ss.SSS'Z')

GreetingEndTimestamp

The date and time that measures the end of the customer greeting from an outbound voice call, in UTC time.

Type: String (yyyy-MM-dd'T'HH:mm:ss.SSS'Z')

Expiry

An object to specify the expiration of a routing step.

DurationInSeconds

The number of seconds to wait before expiring the routing step.

Type: Integer

Min value: 0

ExpiryTimestamp

The timestamp indicating when the routing step expires.

Type: String (yyyy-mm-ddThh:mm:ssZ)

Expression

A tagged union to specify expression for a routing step.

AndExpression

List of routing expressions which will be AND-ed together.

Type: Expression

Min value: 0

OrExpression

List of routing expressions which will be OR-ed together.

Type: Expression

AttributeCondition

An object to specify the predefined attribute condition.

Type: AttributeCondition

QueueInfo

The QueueInfo object includes the following properties:

QueueArn

The Amazon Resource Name (ARN) for the queue.

Type: String

QueueType

The type of queue.

Type: String

RoutingCriteria

List of routing criteria. Each time the routing criteria is updated on a contact, it will be added to this list.

ActivationTimestamp

The timestamp indicating when the routing criteria is set to active. A routing criteria is activated when contact is transferred to a queue.

ActivationTimestamp will be set on routing criteria for contacts in agent queue even though Routing criteria is never activated for contacts in agent queue.

Type: String (yyyy-mm-ddThh:mm:ssZ)

Index

Information about the index of the routing criteria.

Type: Integer

Min value: 0

Steps

List of routing steps.

Type: List of Step objects

Length: 1-5

Steps

When Amazon Connect does not find an available agent meeting the requirements in a step for a given step duration, the routing criteria will move on to the next step sequentially until a join is

completed with an agent. When all steps are exhausted, the contact will be offered to any agent in the queue.

Status

Represents status of the Routing step.

Type: String

Valid Values: EXPIRED, ACTIVE, JOINED, INACTIVE, DEACTIVATED, INTERRUPTED

Expression

An object to specify the expression of a routing step..

Type: Expression

Expiry

An object to specify the expiration of a routing step.

Type: Expiry

Contact timestamps

InitiationTimestamp

The date and time this contact was initiated, in UTC time. In the case that a voice contact was initiated as part of an outbound campaign, the `InitiationTimestamp` will show when the contact is initiated for the `Initiated` event, and will be updated to when the call is started in subsequent events.

Type: String (yyyy-MM-dd'T'HH:mm:ss.SSS'Z')

ConnectedToSystemTimestamp

The date and time the customer endpoint connected to Amazon Connect, in UTC time.

EnqueueTimestamp

The date and time the contact was added to the queue, in UTC time.

Type: String (yyyy-MM-dd'T'HH:mm:ss.SSS'Z')

ConnectedToAgentTimestamp

The date and time the contact was connected to the agent, in UTC time.

Type: String (yyyy-MM-dd'T'HH:mm:ss.SSS'Z')

DisconnectTimestamp

The date and time that the customer endpoint disconnected from Amazon Connect, in UTC time

Type: String (yyyy-MM-dd'T'HH:mm:ss.SSS'Z')

ScheduledTimestamp

The date and time when this contact was scheduled to trigger the flow to run, in UTC time. This is supported only for the task channel.

Type: String (yyyy-MM-dd'T'HH:mm:ss.SSS'Z')

GreetingStartTimestamp

The date and time that measures the beginning of the customer greeting from an outbound voice call, in UTC time.

Type: String (yyyy-MM-dd'T'HH:mm:ss.SSS'Z')

GreetingEndTimestamp

The date and time that measures the end of the customer greeting from an outbound voice call, in UTC time.

Type: String (yyyy-MM-dd'T'HH:mm:ss.SSS'Z')

Sample to stop streaming an event type

The following sample shows how to stop streaming a CONTACT_DATA_UPDATED event from Amazon Connect to EventBridge.

```
{
  "source": ["aws.connect"],
  "detail-type": ["Amazon Connect Contact Event"],
  "detail": {
    "eventType": [{
      "anything-but": ["CONTACT_DATA_UPDATED"]
    }]
  }
}
```

```

    ]]
  }
}

```

Sample contact event for when a voice call is connected to an agent

```

{
  "version": "0",
  "id": "abcbcab-abca-abca-abca-abcbcabcbcb",
  "detail-type": "Amazon Connect Contact Event",
  "source": "aws.connect",
  "account": "111122223333",
  "time": "2021-08-04T17:43:48Z",
  "region": "your-region",
  "resources": [
    "arn:aws:...",
    "contactArn",
    "instanceArn"
  ],
  "detail": {
    "initiationTimestamp": "2021-08-04T17:17:53.000Z",
    "contactId": "11111111-1111-1111-1111-111111111111",
    "channel": "VOICE",
    "instanceArn": "arn:aws::connect:your-region:123456789012:instance/12345678-1234-1234-1234-123456789012",
    "initiationMethod": "INBOUND",
    "eventType": "CONNECTED_TO_AGENT",
    "agentInfo": {
      "agentArn": "arn:aws::connect:your-region:123456789012:instance/12345678-1234-1234-1234-123456789012/agent/12345678-1234-1234-1234-123456789012",
      "connectedToAgentTimestamp": "2021-08-04T17:29:09.000Z",
      "hierarchyGroups": {
        "level1": {
          "arn": "arn:aws:connect:your-region:012345678901:instance/12345678-1234-1234-1234-123456789012/agent-group/abcdefgh-1234-1234-1234-12345678901a",
        },
        "level2": {
          "arn": "arn:aws:connect:your-region:012345678901:instance/12345678-1234-1234-1234-123456789012/agent-group/abcdefgh-1234-1234-1234-12345678901b",
        },
        "level3": {

```

```

        "arn": "arn:aws:connect:your-
region:012345678901:instance/12345678-1234-1234-1234-123456789012/agent-group/
        abcdefgh-1234-1234-1234-12345678901c",
      },
      "level4": {
        "arn": "arn:aws:connect:your-
region:012345678901:instance/12345678-1234-1234-1234-123456789012/agent-group/
        abcdefgh-1234-1234-1234-12345678901d",
      },
      "level5": {
        "arn": "arn:aws:connect:your-
region:012345678901:instance/12345678-1234-1234-1234-123456789012/agent-group/
        abcdefgh-1234-1234-1234-12345678901e",
      }
    }
  },
  "queueInfo": {
    "queueType": "type",
    "queueArn": "arn:aws::connect:your-
region:123456789012:instance/12345678-1234-1234-1234-123456789012/
    queue/12345678-1234-1234-1234-123456789012",
    "enqueueTimestamp": "2021-08-04T17:29:04.000Z"
  },
  "tags": {
    "aws:connect:instanceId": "12345678-1234-1234-1234-123456789012",
    "aws:connect:systemEndpoint": "+11234567890"
  }
}

```

Sample contact event for when a voice call is disconnected

The following sample event shows a contact that has a user-defined tag with **Dept** as the key. Note that queueInfo is not included in events received by EventBridge when initiationMethod is OUTBOUND.

```

{
  "version": "0",
  "id": "the event ID",
  "detail-type": "Amazon Connect Contact Event",
  "source": "aws.connect",
  "account": "111122223333",

```

```

"time": "2021-08-04T17:43:48Z",
"region": "your-region",
"resources": [
  "arn:aws:...",
  "contactArn",
  "instanceArn"
],
"detail": {
  "eventType": "DISCONNECTED",
  "contactId": "11111111-1111-1111-1111-111111111111",
  "initialContactId": "11111111-2222-3333-4444-555555555555",
  "previousContactId": "11111111-2222-3333-4444-555555555555",
  "channel": "Voice",
  "instanceArn": "arn:aws::connect:your-
region:123456789012:instance/12345678-1234-1234-1234-123456789012",
  "initiationMethod": "OUTBOUND",
  "initiationTimestamp": "2021-08-04T17:17:53.000Z",
  "connectedToSystemTimestamp": "2021-08-04T17:17:55.000Z",
  "disconnectTimestamp": "2021-08-04T17:18:37.000Z",
  "agentInfo": {
    "agentArn": "arn",
    "connectedToAgentTimestamp": "2021-08-04T17:29:09.000Z",
    "hierarchyGroups": {
      "level1": {
        "arn": "arn:aws:connect:your-
region:012345678901:instance/12345678-1234-1234-1234-123456789012/agent-group/
abcdefgh-1234-1234-1234-12345678901a",
      },
      "level2": {
        "arn": "arn:aws:connect:your-
region:012345678901:instance/12345678-1234-1234-1234-123456789012/agent-group/
abcdefgh-1234-1234-1234-12345678901b",
      },
      "level3": {
        "arn": "arn:aws:connect:your-
region:012345678901:instance/12345678-1234-1234-1234-123456789012/agent-group/
abcdefgh-1234-1234-1234-12345678901c",
      },
      "level4": {
        "arn": "arn:aws:connect:your-
region:012345678901:instance/12345678-1234-1234-1234-123456789012/agent-group/
abcdefgh-1234-1234-1234-12345678901d",
      },
      "level5": {

```

```

        "arn": "arn:aws:connect:your-
region:012345678901:instance/12345678-1234-1234-1234-123456789012/agent-group/
abcdefgh-1234-1234-1234-12345678901e",
    },
    },
    },
    "CustomerVoiceActivity": {
        "greetingStartTimestamp": "2021-08-04T17:29:20.000Z",
        "greetingEndTimestamp": "2021-08-04T17:29:22.000Z",
    },
    "tags": {
        "aws:connect:instanceId": "12345678-1234-1234-1234-123456789012",
        "aws:connect:systemEndpoint": "+11234567890",
        "Dept": "Finance"
    }
}
}
}

```

Sample event for when contact properties are updated

```

{
  "version": "0",
  "id": "the event ID",
  "detail-type": "Amazon Connect Contact Event",
  "source": "aws.connect",
  "account": "the account ID",
  "time": "2021-08-04T17:43:48Z",
  "region": "your-region",
  "resources": [
    "arn:aws:...",
    "contactArn",
    "instanceArn"
  ],
  "detail": {
    "eventType": "CONTACT_DATA_UPDATED",
    "contactId": "the contact ID",
    "channel": "CHAT",
    "instanceArn": "arn:aws:connect:us-west-2:the account ID:instance/the instance ID",
    "initiationMethod": "API",
    "queueInfo": {
      "queueArn": "arn:aws:connect:us-west-2:the account ID:instance/the instance ID/
queue/the queue ID",

```



```

    "enqueueTimestamp": "2023-10-24T02:39:15.240Z",
    "queueType": "STANDARD"
  },
  "agentInfo": {
    "agentArn": "arn:aws:connect:us-west-2:the account ID:instance/the instance ID/agent/the agent ID",
    "connectedToAgentTimestamp": "1970-01-01T00:00:00.001Z",
    "hierarchyGroups": {
      "level1": {
        "arn": "arn:aws:connect:us-west-2:the account ID:instance/the instance ID/agent-group/the agent group ID"
      },
      "level2": {
        "arn": "arn:aws:connect:us-west-2:the account ID:instance/the instance ID/agent-group/the agent group ID"
      },
      "level3": {
        "arn": "arn:aws:connect:us-west-2:the account ID:instance/the instance ID/agent-group/the agent group ID"
      },
      "level4": {
        "arn": "arn:aws:connect:us-west-2:the account ID:instance/the instance ID/agent-group/the agent group ID"
      }
    }
  },
  "updatedProperties": ["ContactLens.ConversationalAnalytics.Configuration"],
  "initiationTimestamp": "2023-10-24T02:39:15.154Z",
  "connectedToSystemTimestamp": "1970-01-01T00:00:00.001Z",
  "tags": {
    "aws:connect:instanceId": "the instance ID"
  },
  "contactLens": {
    "conversationalAnalytics": {
      "configuration": {
        "enabled": true,
        "channelConfiguration": {
          "analyticsModes": ["PostContact"]
        },
        "languageLocale": "en-US",
        "redactionConfiguration": {
          "behavior": "Enable",
          "policy": "RedactedAndOriginal",
          "entities": ["EMAIL"],

```

```

        "maskMode": "EntityType"
      }
    }
  }
}
}

```

Sample contact event for when a voice call is connected to an agent using routing criteria

```

{
  "version": "0",
  "id": "abcabcab-abca-abca-abca-abcabcabcabc",
  "detail-type": "Amazon Connect Contact Event",
  "source": "aws.connect",
  "account": "111122223333",
  "time": "2021-08-04T17:43:48Z",
  "region": "your-region",
  "resources": [
    "arn:aws:...",
    "contactArn",
    "instanceArn"
  ],
  "detail": {
    "ContactId": "12345678-1234-1234-1234-123456789012",
    "Channel": "VOICE",
    "InstanceArn": "arn:aws::connect:us-west-2:123456789012:instance/12345678-1234-1234-1234-123456789012",
    "InitiationMethod": "INBOUND",
    "EventType": "CONNECTED_TO_AGENT",
    "AgentInfo": {
      "AgentArn": "arn:aws::connect:us-west-2:123456789012:instance/12345678-1234-1234-1234-123456789012/agent/12345678-1234-1234-1234-123456789012",
      "ConnectedToAgentTimestamp": "2021-08-04T17:29:09.000Z"
    },
    "QueueInfo": {
      "QueueType": "type",
      "QueueArn": "arn:aws::connect:us-west-2:123456789012:instance/12345678-1234-1234-1234-123456789012/queue/12345678-1234-1234-1234-123456789012",

```

```
    "EnqueueTimestamp": "2021-08-04T17:29:04.000Z"
  },
  "tags": {
    "aws:connect:instanceId": "12345678-1234-1234-1234-123456789012",
    "aws:connect:systemEndpoint": "+11234567890"
  },
  "RoutingCriteria": [{
    "ActivationTimestamp": "2021-08-04T17:29:04.000Z",
    "Index": 0,
    "Steps": [{
      "Status": "JOINED",
      "Expiry": {
        "DurationInSeconds": 60,
      },
      "Expression": {
        "OrExpression": [{
          "AttributeCondition": {
            "Name": "Technology",
            "ComparisonOperator": "NumberGreaterOrEqualTo",
            "ProficiencyLevel": 2.0,
            "Value": "AWS Kinesis"
          }
        },
        {
          "AttributeCondition": {
            "Name": "Language",
            "ComparisonOperator": "NumberGreaterOrEqualTo",
            "ProficiencyLevel": 4.0,
            "Value": "English"
          }
        }
      ]
    },
    {
      "AndExpression": [{
        "AttributeCondition": {
          "Name": "Language",
          "ComparisonOperator": "NumberGreaterOrEqualTo",
          "ProficiencyLevel": 2.0,
          "Value": "Spanish"
        }
      ]
    }
  ]
}
}
```

Sample event for when routing step expires on a contact

```
{
  "version": "0",
  "id": "the event ID",
  "detail-type": "Amazon Connect Contact Event",
  "source": "aws.connect",
  "account": "the account ID",
  "time": "2021-08-04T17:43:48Z",
  "region": "your-region",
  "resources": [
    "arn:aws:...",
    "contactArn",
    "instanceArn"
  ],
  "detail": {
    "eventType": "CONTACT_DATA_UPDATED",
    "contactId": "12345678-1234-1234-1234-123456789012",
    "channel": "CHAT",
    "instanceArn": "arn:aws::connect:us-west-2:123456789012:instance/12345678-1234-1234-1234-123456789012",
    "initiationMethod": "API",
    "queueInfo": {
      "queueArn": "arn:aws:connect:us-west-2:123456789012:instance/12345678-1234-1234-1234-123456789012/queue/12345678-1234-1234-1234-123456789012",
      "enqueueTimestamp": "2023-11-01T18:33:03.062Z",
      "queueType": "STANDARD"
    },
    "updatedProperties": ["RoutingCriteria.Step.Status"],
    "initiationTimestamp": "2023-11-01T18:33:00.716Z",
    "connectedToSystemTimestamp": "2023-11-01T18:33:01.736Z",
    "tags": {
      "aws:connect:instanceId": "12345678-1234-1234-1234-123456789012"
    },
    "routingCriteria": {
      "steps": [
        {
          "expiry": {
            "durationInSeconds": 50,
            "expiryTimestamp": "2023-11-01T18:34:54.275Z"
          }
        }
      ],
    }
  }
}
```

```
    "expression":{
      "attributeCondition":{
        "name":"Location",
        "value":"AZ",
        "proficiencyLevel":3.0,
        "comparisonOperator":"NumberGreaterOrEqualTo"
      }
    },
    "status":"EXPIRED"
  },
  {
    "expiry":{
      "durationInSeconds":10
    },
    "expression":{
      "attributeCondition":{
        "name":"Language",
        "value":"Spanish",
        "proficiencyLevel":4.0,
        "comparisonOperator":"NumberGreaterOrEqualTo"
      }
    },
    "status":"ACTIVE"
  },
  {
    "expression":{
      "attributeCondition":{
        "name":"Language",
        "value":"Spanish",
        "proficiencyLevel":1.0,
        "comparisonOperator":"NumberGreaterOrEqualTo"
      }
    },
    "status":"INACTIVE"
  }
],
"activationTimestamp":"2023-11-01T18:34:04.275Z",
"index":1
}
}
```

Sample contact event for when a voice call is connected to an agent provided by the customer using routing criteria

```
{
  "version": "0",
  "id": "abcabcab-abca-abca-abca-abcabcabcabc",
  "detail-type": "Amazon Connect Contact Event",
  "source": "aws.connect",
  "account": "111122223333",
  "time": "2021-08-04T17:43:48Z",
  "region": "your-region",
  "resources": [
    "arn:aws:...",
    "contactArn",
    "instanceArn"
  ],
  "detail": {
    "ContactId": "12345678-1234-1234-1234-123456789012",
    "Channel": "VOICE",
    "InstanceArn": "arn:aws::connect:us-west-2:123456789012:instance/12345678-1234-1234-1234-123456789012",
    "InitiationMethod": "INBOUND",
    "EventType": "CONNECTED_TO_AGENT",
    "AgentInfo": {
      "AgentArn": "arn:aws::connect:us-west-2:123456789012:instance/12345678-1234-1234-1234-123456789012/agent/12345678-1234-1234-1234-123456789012",
      "ConnectedToAgentTimestamp": "2021-08-04T17:29:09.000Z"
    },
    "QueueInfo": {
      "QueueType": "type",
      "QueueArn": "arn:aws::connect:us-west-2:123456789012:instance/12345678-1234-1234-1234-123456789012/queue/12345678-1234-1234-1234-123456789012",
      "EnqueueTimestamp": "2021-08-04T17:29:04.000Z"
    },
    "tags": {
      "aws:connect:instanceId": "12345678-1234-1234-1234-123456789012",
      "aws:connect:systemEndpoint": "+11234567890"
    },
    "RoutingCriteria": [{
      "ActivationTimestamp": "2021-08-04T17:29:04.000Z",
      "Index": 0,

```

```
    "Steps": [{
      "Status": "JOINED",
      "Expiry": {
        "DurationInSeconds": 60,
      },
      "Expression": {
        "AttributeCondition": {
          "ComparisonOperator": "Match",
          "MatchCriteria": {
            "AgentsCriteria": {
              "AgentIds": ["AGENT_1"]
            }
          }
        }
      }
    }
  ]
}
```

Contact records data model

This article describes the data model for Amazon Connect contact records. Contact records capture the events associated with a contact in your contact center. Real-time and historical metrics are based on the data captured in the contact records.

Important things to know

- We continually release new features that result in the addition of new fields to the contact records data model. Any changes we make to the data model are backward compatible. When you develop applications, we recommend that you build them to ignore the addition of new fields in the contact records data model. This will help ensure your applications are resilient.
- Amazon Connect delivers contact records at least once. Contact records may be delivered again for multiple reasons, such as new information arriving after initial delivery. For example, when you use [update-contact-attributes](#) to update a contact record, Amazon Connect delivers a new contact record. This contact record is available for 24 months from the time the associated contact was initiated.

If you're building a system that consumes contact record export streams, be sure to include logic that checks for duplicate contact records for a contact. Use the **LastUpdateTimestamp** property to determine if a copy contains new data than previous copies. Then use the **ContactId** property for deduplication.

- Every action taken on a unique contact generates an event. These events appear as a field or an attribute on the contact record. If the number of actions for a contact exceeds a threshold, such as an internal storage limit, then any actions that follow will not appear on that contact record.
- For the contact record retention period and maximum size of the attributes section of a contact record, see [Amazon Connect feature specifications](#).
- For information about when a contact record is created (and thus can be exported or used for data reporting), see [Events in the contact record](#).
- For a list of all contact attributes, including telephony call and case attributes, see [List of available contact attributes and their JSONPath reference](#).
- In the past we referred to *contact records* as *Contact Trace Records (CTR)*. Now we use the term *contact record* only. There is no difference between the two terms.

Agent

Information about the agent who accepted the incoming contact.

AgentInteractionDuration

The time, in whole seconds, that an agent interacted with a customer. For outbound calls, this is the time, in whole seconds, that an agent was connected to a contact, even if the customer is not present.

This does not include agent pause duration (which applies only to tasks).

Type: Integer

Min value: 0

AgentPauseDuration

The time, in whole seconds, that a task assigned to an agent was paused.

Type: Integer

Min value: 0

AfterContactWorkDuration

The difference in time, in whole seconds, between `AfterContactWorkStartTimestamp` and `AfterContactWorkEndTimestamp`.

Type: Integer

Min value: 0

AfterContactWorkEndTimestamp

The date and time when the agent stopped doing After Contact Work for the contact, in UTC time.

Type: String (*yyyy-mm-ddThh:mm:ssZ*)

AfterContactWorkStartTimestamp

The date and time when the agent started doing After Contact Work for the contact, in UTC time.

Type: String (*yyyy-mm-ddThh:mm:ssZ*)

ARN

The Amazon Resource Name of the agent.

Type: ARN

ConnectedToAgentTimestamp

The date and time the contact was connected to the agent, in UTC time.

Type: String (*yyyy-mm-ddThh:mm:ssZ*)

CustomerHoldDuration

The time, in whole seconds, that the customer spent on hold while connected to the agent.

Type: Integer

Min value: 0

DeviceInfo

Information about agent's device.

Type: [DeviceInfo](#)

HierarchyGroups

The agent hierarchy groups for the agent.

Type: [AgentHierarchyGroups](#)

LongestHoldDuration

The longest time, in whole seconds, that the customer was put on hold by the agent.

Type: Integer

Min value: 0

NumberOfHolds

The number of times the customer was put on hold while connected to the agent.

Type: Integer

Min value: 0

RoutingProfile

The routing profile of the agent.

Type: [RoutingProfile](#)

Username

The username of the agent.

Type: String

Length: 1-100

StateTransitions

The state transitions of a supervisor.

Type: Array of [StateTransitions](#).

AgentHierarchyGroup

Information about an agent hierarchy group.

ARN

The Amazon Resource Name (ARN) of the group.

Type: ARN

GroupName

The name of the hierarchy group.

Type: String

Length: 1-256

AgentHierarchyGroups

Information about the agent hierarchy. Hierarchies can be configured with up to five levels.

Level1

The group at level one of the agent hierarchy.

Type: [AgentHierarchyGroup](#)

Level2

The group at level two of the agent hierarchy.

Type: [AgentHierarchyGroup](#)

Level3

The group at level three of the agent hierarchy.

Type: [AgentHierarchyGroup](#)

Level4

The group at level four of the agent hierarchy.

Type: [AgentHierarchyGroup](#)

Level5

The group at level five of the agent hierarchy.

Type: [AgentHierarchyGroup](#)

AttributeCondition

An object to specify the predefined attribute condition.

Name

The name of predefined attribute.

Type: String

Length: 1-64

Value

The value of predefined attribute.

Type: String

Length: 1-64

ComparisonOperator

The operator of the condition.

Type: String

Valid values: NumberGreaterOrEqualTo

ProficiencyLevel

The proficiency level of the condition.

Type: Float

Valid values: 1.0, 2.0, 3.0, 4.0 and 5.0

MatchCriteria

An object to define AgentsCriteria.

Type: MatchCriteria object

AgentsCriteria

An Object to define agentIds.

Type: AgentsCriteria object

AgentIds

An object to specify a list of agents, by Agent ID.

Type: Array of strings

Length Constraints: Maximum length of 256

ContactDetails

Contains user-defined attributes which are lightly typed within the contact.

This object is used only for task contacts. For voice or chat contacts, or for tasks that have contact attributes set with the flow block, check the [ContactTraceRecord](#) Attributes object.

ContactDetailsName

Type: String

Length: 1-128

ContactDetailsValue

Type: String

Length: 0-1024

ReferenceAttributeName

Type: String

Length: 1-128

ReferenceAttributesValue

Type: String

Length: 0-1024

ContactTraceRecord

Information about a contact.

Agent

If this contact successfully connected to an agent, this is information about the agent.

Type: [Agent](#)

AgentConnectionAttempts

The number of times Amazon Connect attempted to connect this contact with an agent.

Type: Integer

Min value: 0

Attributes

The contact attributes, formatted as a map of keys and values.

Type: Attributes

Members: AttributeName, AttributeValue

AWSAccountId

The ID of the AWS account that owns the contact.

Type: String

AWSContactTraceRecordFormatVersion

The record format version.

Type: String

Channel

How the contact reached your contact center.

Valid values: VOICE, CHAT, TASK

ConnectedToSystemTimestamp

The date and time the customer endpoint connected to Amazon Connect, in UTC time. For INBOUND, this matches InitiationTimestamp. For OUTBOUND, CALLBACK, and API, this is when the customer endpoint answers.

Type: String (*yyyy-mm-ddThh:mm:ssZ*)

ContactId

The ID of the contact.

Type: String

Length: 1-256

CustomerEndpoint

The customer or external third party participant endpoint.

Type: [Endpoint](#)

CustomerVoiceActivity

The CustomerVoiceActivity object includes the following properties:

GreetingStartTimestamp

The date and time that measures the beginning of the customer greeting from an outbound voice call, in UTC time.

Type: String (yyyy-MM-dd'T'HH:mm:ss.SSS'Z')

GreetingEndTimestamp

The date and time that measures the end of the customer greeting from an outbound voice call, in UTC time.

Type: String (yyyy-MM-dd'T'HH:mm:ss.SSS'Z')

DisconnectTimestamp

The date and time that the customer endpoint disconnected from Amazon Connect, in UTC time.

Type: String (yyyy-mm-ddThh:mm:ssZ)

DisconnectReason

Indicates how the contact was terminated. This data is currently available in the Amazon Connect contact record stream and **Contact details** page.

The disconnect reason may not be accurate when there are agent or customer connectivity issues. For example, if the agent is having connectivity issues, the customer might

not be able to hear them ("Are you there?") and hang up. This would be recorded as `CUSTOMER_DISCONNECT` and not reflect the connectivity issue.

Type: String

Voice contacts can have the following disconnect reasons:

- `CUSTOMER_DISCONNECT`: Customer disconnected first.
- `AGENT_DISCONNECT`: Agent disconnected when the contact was still on the call.
- `THIRD_PARTY_DISCONNECT`: In a third-party call, after the agent has left, the third-party disconnected the call while the contact was still on the call.
- `TELECOM_PROBLEM`: Disconnected due to an issue with connecting the call from the carrier, network congestion, network error, etc.
- `BARGED`: manager disconnected the agent from the call.
- `CONTACT_FLOW_DISCONNECT`: Call was disconnected in a flow.
- `OTHER`: This includes any reason not explicitly covered by the previous codes. For example, the contact was disconnected by an API.

Outbound campaign voice contacts can have the following disconnect reasons:

- `OUTBOUND_DESTINATION_ENDPOINT_ERROR`: Current configurations do not allow this destination to be dialed (for example, calling an endpoint destination from an ineligible instance).
- `OUTBOUND_RESOURCE_ERROR`: Instance has insufficient permissions to make outbound calls or necessary resources were not found.
- `OUTBOUND_ATTEMPT_FAILED`: There was an unknown error, invalid parameter, or insufficient permissions to call the API.
- `EXPIRED`: Not enough agents available, or not enough telecom capacity for such calls.

Chats can have the following disconnect reasons:

- `AGENT_DISCONNECT`: Agent explicitly disconnects or rejects a chat.
- `CUSTOMER_DISCONNECT`: Customer explicitly disconnects.
- `OTHER`: Used only for error states such as message transport issues.

For many contacts, such as contacts ended by flows or APIs, there will not be any disconnect reason. In the contact record it will appear as `null`.

Tasks can have the following disconnect reasons:

- **AGENT_DISCONNECT**: Agent marked the task as complete.
- **EXPIRED**: Task expired automatically because it was not assigned or completed within 7 days.
- **CONTACT_FLOW_DISCONNECT**: Task was disconnected or completed by a flow.
- **API**: The [StopContact](#) API was called to end the task.
- **OTHER**: This includes any reason not explicitly covered by the previous codes.

AnsweringMachineDetectionStatus

Indicates how an [outbound campaign](#) call is actually disposed if the contact is connected to Amazon Connect.

Valid values:

- **HUMAN_ANSWERED**: The number dialed was answered by a person.
- **VOICEMAIL_BEEP**: The number dialed was answered by voicemail with a beep.
- **VOICEMAIL_NO_BEEP**: The number dialed was answered by a voicemail with no beep.
- **AMD_UNANSWERED**: The number dialed kept ringing, but the call was not picked up.
- **AMD_UNRESOLVED**: The number dialed was connected but the answering machine detection could not determine whether the call was picked up by a person or voicemail.
- **AMD_NOT_APPLICABLE**: The call disconnected before ringing, and there was no media to detect.
- **SIT_TONE_BUSY**: The number dialed was busy
- **SIT_TONE_INVALID_NUMBER**: The number dialed was not a valid number.
- **SIT_TONE_DETECTED**: A special information tone (SIT) was detected.
- **FAX_MACHINE_DETECTED**: A fax machine was detected.
- **AMD_ERROR**: The number dialed was connected, but there was an error in answering machine detection.

InitialContactId

The identifier of the initial contact.

Type: String

Length: 1-256

InitiationMethod

Indicates how the contact was initiated.

Valid values:

- **INBOUND:** The customer initiated voice (phone) contact with your contact center.
- **OUTBOUND:** An agent initiated voice (phone) contact with the customer, by using the CCP to call their number.
- **TRANSFER:** The customer was transferred by an agent to another agent or to a queue, using quick connects in the CCP. This results in a new CTR being created.
- **CALLBACK:** The customer was contacted as part of a callback flow.

For more information about the InitiationMethod in this scenario, see [About queued callbacks in metrics](#).

- **API:** The contact was initiated with Amazon Connect by API. This could be an outbound contact you created and queued to an agent, using the [StartOutboundVoiceContact](#) API, or it could be a live chat that was initiated by the customer with your contact center, where you called the [StartChatConnect](#) API.
- **WEBRTC_API:** The contact used the communication widget with video call.
- **QUEUE_TRANSFER:** While the customer was in one queue (listening to Customer queue flow), they were transferred into another queue using a flow block.
- **EXTERNAL_OUTBOUND:** An agent initiated voice (phone) contact with an external participant to your contact center using either quick connect in the CCP or a flow block.
- **MONITOR:** A supervisor initiated monitor on an agent. The supervisor can silently monitor the agent and customer, or barge the conversation.
- **DISCONNECT:** When a [Set disconnect flow](#) block is triggered, it specifies which flow to run after a disconnect event during a contact.

A disconnect event is when:

- A chat, or task is disconnected.
- A task is disconnected as a result of a flow action.
- A task expires. The task is automatically disconnected if it is not completed in 7 days.

If a new contact is created while running a disconnect flow, then the initiation method for that new contact is DISCONNECT.

InitiationTimestamp

The date and time this contact was initiated, in UTC time. For INBOUND, this is when the contact arrived. For OUTBOUND, this is when the agent began dialing. For CALLBACK, this is when the callback contact was created. For EXTERNAL_OUTBOUND, this is when the agent started dialing the external participant. For MONITOR, this is when the manager started listening to a contact. For TRANSFER and QUEUE_TRANSFER, this is when the transfer was initiated. For API, this is when the request arrived.

Type: String (*yyyy-mm-ddThh:mm:ssZ*)

InstanceARN

The Amazon Resource Name of the Amazon Connect instance.

Type: ARN

LastUpdateTimestamp

The date and time this contact was last updated, in UTC time.

Type: String (*yyyy-mm-ddThh:mm:ssZ*)

LastPausedTimestamp

The date and time this contact was last paused, in UTC time.

Type: String (*yyyy-mm-ddThh:mm:ssZ*)

LastResumedTimestamp

The date and time this contact was last resumed, in UTC time.

Type: String (*yyyy-mm-ddThh:mm:ssZ*)

MediaStreams

The media streams.

Type: Array of [MediaStream](#)

NextContactId

If this contact is not the last contact, this is the ID of the next contact.

Type: String

Length: 1-256

PreviousContactId

If this contact is not the first contact, this is the ID of the previous contact.

Type: String

Length: 1-256

Queue

If this contact was queued, this is information about the queue.

Type: [QueueInfo](#)

Campaign

Information associated with a campaign.

Type: [Campaign](#) object

Recording

If recording was enabled, this is information about the recording.

Type: [RecordingInfo](#)

Recordings

If recording was enabled, this is information about the recording.

Type: Array of [RecordingsInfo](#)

Note

The first recording for a contact will appear in both the Recording and Recordings sections of the contact record.

Amazon Q in Connect

If Amazon Q was enabled on the contact, this is information about the Amazon Q session.

Type: [WisdomInfo](#)

RelatedContactId

If this contact is associated with another contact, this is the identifier of the related contact.

Type: String

Length: 1-256.

ScheduledTimestamp

The date and time when this contact was scheduled to trigger the flow to run, in UTC time. This is supported only for the task channel.

Type: String (*yyyy-mm-ddThh:mm:ssZ*)

SegmentAttributes

A set of system defined key-value pairs stored on individual contact segments using an attribute map. The attributes are standard Amazon Connect attributes and can be accessed in flows. Attribute keys can include only alphanumeric, -, and _ characters.

This field can be used to show channel subtype. For example, `connect:Guide` or `connect:SMS`.

Type: SegmentAttributes

Members: SegmentAttributeName, SegmentAttributeValue

SystemEndpoint

The system endpoint. For INBOUND, this is the phone number that the customer dialed. For OUTBOUND and EXTERNAL_OUTBOUND, this is the outbound caller ID number assigned to the outbound queue that is used to dial the customer. For callback, this shows up as Softphone for calls handled by agents with softphone.

When [Transfer to phone number](#) block is used without specifying a custom caller ID, the caller ID of the caller is passed as the caller ID. For example, if you transfer to an external number and no custom caller ID is used to specify that the call is coming from your organization, then the contact's caller ID is displayed to the external party.

Type: [Endpoint](#)

TotalPauseCount

Total number of Pauses including when the contact was not connected.

Type: Integer

TotalPauseDurationInSeconds

Total Pause duration, including before and after the agent was connected.

Type: Integer

TransferCompletedTimestamp

If this contact was transferred out of Amazon Connect, the date and time the transfer endpoint was connected, in UTC time.

Type: String (*yyyy-mm-ddThh:mm:ssZ*)

TransferredToEndpoint

If this contact was transferred out of Amazon Connect, the transfer endpoint.

Type: [Endpoint](#)

Tags

[Tags](#) associated with the contact. This contains both AWS generated and user-defined tags.

Type: String to string map

DeviceInfo

Information about participant's device.

PlatformName

Name of the platform that the participant used for the call.

Type: String

Length: 1-128

PlatformVersion

Version of the platform that the participant used for the call.

Type: String

Length: 1-128

OperatingSystem

Operating system that the participant used for the call.

Type: String

Length: 1-128

DisconnectDetails

Information about the call disconnect experience.

PotentialDisconnectIssue

Indicates the potential disconnection issues for a call. This field is not populated if the service does not detect potential issues.

Type: String

Length: 0-128

Valid values:

- AGENT_CONNECTIVITY_ISSUE: Indicates potential issues with agent network connectivity.
- AGENT_DEVICE_ISSUE: Indicates problems with the customer hearing the agent due to potential issues with the agent's device such as their workstation, headset, or microphone.

Endpoint

Information about an endpoint. In Amazon Connect, an endpoint is the destination for a contact, such as a customer phone number, or a phone number for your contact center.

Address

The value for the type of endpoint. For TELEPHONE_NUMBER, the value is a phone number in E.164 format.

Type: String

Length: 1-256

Type

The endpoint type. Currently, an endpoint can only be a telephone number.

Valid values: TELEPHONE_NUMBER

Expiry

An object to specify the expiration of a routing step.

DurationInSeconds

The number of seconds to wait before expiring the routing step.

Type: Integer

Min value: 0

ExpiryTimestamp

The timestamp indicating when the routing step expires.

Type: String (yyyy-mm-ddThh:mm:ssZ)

Expression

A tagged union to specify expression for a routing step.

AndExpression

List of routing expressions which will be AND-ed together.

Type: Expression

Min value: 0

OrExpression

List of routing expressions which will be OR-ed together.

Type: Expression

AttributeCondition

An object to specify the predefined attribute condition.

Type: AttributeCondition

ExternalThirdParty

Information about the External Third Party participant.

ExternalThirdPartyInteractionDuration

The time, in whole seconds, that the external participant interacted with the customer.

Type: Integer

Min value: 0

MediaStream

Information about the media stream used during the contact.

Type

Type: MediaStreamType

Valid values: AUDIO, VIDEO, CHAT

QualityMetrics

Information about the quality of the participant's media connection.

QualityScore

Number measuring the estimated quality of the media connection.

Type: Number

Min value: 1.00

Max val: 5.00

PotentialQualityIssues

List of potential issues causing degradation of quality on a media connection. If the service did not detect any potential quality issues the list is empty.

Type: `StringArray`

Valid values: Empty array or array with any of the following values: `HighPacketLoss`, `HighRoundTripTime`, `HighJitterBuffer`.

QueueInfo

Information about a queue.

ARN

The Amazon Resource Name of the queue.

Type: `ARN`

DequeueTimestamp

The date and time the contact was removed from the queue, in UTC time. Either the customer disconnected or the agent started interacting with the customer.

Type: `String (yyyy-mm-ddThh:mm:ssZ)`

Duration

The difference in time, in whole seconds, between `EnqueueTimestamp` and `DequeueTimestamp`.

Type: `Integer`

Min value: 0

EnqueueTimestamp

The date and time the contact was added to the queue, in UTC time.

Type: `String (yyyy-mm-ddThh:mm:ssZ)`

Name

The name of the queue.

Type: `String`

Length: 1-256

RecordingInfo

Information about a voice recording.

DeletionReason

If the recording was deleted, this is the reason entered for the deletion.

Type: String

Location

The location, in Amazon S3, for the recording.

Type: String

Length: 0-256

Status

The recording status.

Valid values: AVAILABLE | DELETED | NULL

Type

The recording type.

Valid values: AUDIO

RecordingsInfo

Information about a voice recording, chat transcript, or screen recording.

DeletionReason

If the recording/transcript was deleted, this is the reason entered for the deletion.

Type: String

FragmentStartNumber

The number that identifies the Kinesis Video Streams fragment where the customer audio stream started.

Type: String

FragmentStopNumber

The number that identifies the Kinesis Video Streams fragment where the customer audio stream stopped.

Type: String

Location

The location, in Amazon S3, for the recording/transcript.

Type: String

Length: 0-256

MediaStreamType

Information about the media stream used during the conversation.

Type: String

Valid values: AUDIO, VIDEO, CHAT

ParticipantType

Information about the conversation participant: whether they are an agent or contact. Following are the participant types:

- All
- Manager
- Agent
- Customer
- Thirdparty
- Supervisor

Type: String

StartTimestamp

When the conversation of the last leg of the recording started.

Type: String (*yyyy-mm-ddThh:mm:ssZ*)

Status

The status of the recording/transcript.

Valid values: AVAILABLE | DELETED | NULL

StopTimestamp

When the conversation of the last leg of recording stopped.

Type: String (*yyyy-mm-ddThh:mm:ssZ*)

StorageType

Where the recording/transcript is stored.

Type: String

Valid values: Amazon S3 | KINESIS_VIDEO_STREAM

References

Contains links to other documents that are related to a contact.

Reference Info

Name

Type: URL | ATTACHMENT | NUMBER | STRING | DATE | EMAIL

- When Type = ATTACHMENT, the record also has a Status field.

Status valid values: APPROVED | REJECTED

Value

RoutingCriteria

List of routing criteria. Each time the routing criteria is updated on a contact, it will be added to this list.

ActivationTimestamp

The timestamp indicating when the routing criteria is set to active. A routing criteria is activated when contact is transferred to a queue.

ActivationTimestamp will be set on routing criteria for contacts in agent queue even though Routing criteria is never activated for contacts in agent queue.

Type: String (yyyy-mm-ddThh:mm:ssZ)

Index

Information about the index of the routing criteria.

Type: Integer

Min value: 0

Steps

List of routing steps.

Type: List of Step objects

Length: 1-5

RoutingProfile

Information about a routing profile.

ARN

The Amazon Resource Name of the routing profile.

Type: ARN

Name

The name of the routing profile.

Type: String

Length: 1-100

StateTransitions

Information about the state transitions of a supervisor.

stateStartTimestamp

The date and time when the state started in UTC time.

Type: String (yyyy-mm-ddThh:mm:ssZ)

stateEndTimeStamp

The date and time when the state ended in UTC time.

Type: String (yyyy-mm-ddThh:mm:ssZ)

state

Valid values: SILENT_MONITOR | BARGE.

Steps

When Amazon Connect does not find an available agent meeting the requirements in a step for a given step duration, the routing criteria will move on to the next step sequentially until a join is completed with an agent. When all steps are exhausted, the contact will be offered to any agent in the queue.

Status

Represents status of the Routing step.

Type: String

Valid Values: EXPIRED, ACTIVE, JOINED, INACTIVE, DEACTIVATED, INTERRUPTED

Expression

An object to specify the expression of a routing step..

Type: Expression

Expiry

An object to specify the expiration of a routing step.

Type: Expiry

VoiceIdResult

The latest Voice ID status.

Authentication

The voice authentication information for the call.

Type: Authentication

FraudDetection

The fraud detection information for the call.

Type: FraudDetection

GeneratedSpeakerId

The speaker identifier generated by Voice ID.

Type: String

Length: 25 characters

SpeakerEnrolled

Was the customer enrolled during this contact?

Type: Boolean

SpeakerOptedOut

Did the customer opt out during this contact?

Type: Boolean

WisdomInfo

Information about an Amazon Q in Connect session.

SessionArn

The Amazon Resource Name (ARN) of the Amazon Q in Connect session for the contact.

Type: ARN

Authentication

Information about Voice ID authentication for a call.

ScoreThreshold

The minimum authentication score required for a user to be authenticated.

Type: Integer

Min value: 0

Max value: 100

MinimumSpeechInSeconds

The number of seconds of speech used to authenticate the user.

Type: Integer

Min value: 5

Max value: 10

Score

The output of Voice ID authentication evaluation.

Type: Integer

Min value: 0

Max value: 100

Result

The string output of Voice ID authentication evaluation.

Type: String

Length: 1-32

Valid values: Authenticated | Not Authenticated | Not Enrolled | Opted Out | Inconclusive | Error

FraudDetection

Information about Voice ID fraud detection for a call.

ScoreThreshold

The threshold for detection of fraudsters in a watchlist that was set in the flow for the contact.

Type: Integer

Min value: 0

Max value: 100

Result

The string output of detection of fraudsters in a watchlist.

Type: String

Valid values: High Risk | Low Risk | Inconclusive | Error

Reasons

Contains fraud types: Known Fraudster and Voice Spoofing.

Type: List of String

Length: 1-128

RiskScoreKnownFraudster

The detection of fraudsters in a watchlist score for Known Fraudster category.

Type: Integer

Min value: 0

Max value: 100

RiskScoreVoiceSpoofing

The fraud risk score based on Voice Spoofing, such as playback of audio from Text-to-Speech systems recorded audio.

Type: Integer

Length: 3

RiskScoreSyntheticSpeech (unused)

This field is unused. This score is presented as a combined risk score for Voice Spoofing.

Type: Integer

Length: 3

GeneratedFraudsterID

The fraudster ID if the fraud type is Known Fraudster.

Type: String

Length: 25 characters

WatchlistID

The fraudster watchlist that was set in the flow for the contact. Use for Known Fraudster Detection.

Type: String

Length: 22 characters

How to identify abandoned contacts

An abandoned contact refers to a contact that was disconnected by the customer while in queue. This means that they weren't connected to an agent.

The contact record for an abandoned contact has a **Queue**, and an **Enqueue Timestamp** because it was enqueued. It won't have a **ConnectedToAgentTimestamp**, or any of the other fields that populate only after the contact has been connected to an agent.

View a contact record in the UI

1. Do a [contact search](#). A list of contact IDs will be returned.
2. Choose an ID to view the contact record for the contact.

The following image shows part of a contact record in the UI, for a chat conversation. Note the following:

- For chats, the initiation method is always **API**.
- The chat transcript is visible in the UI.

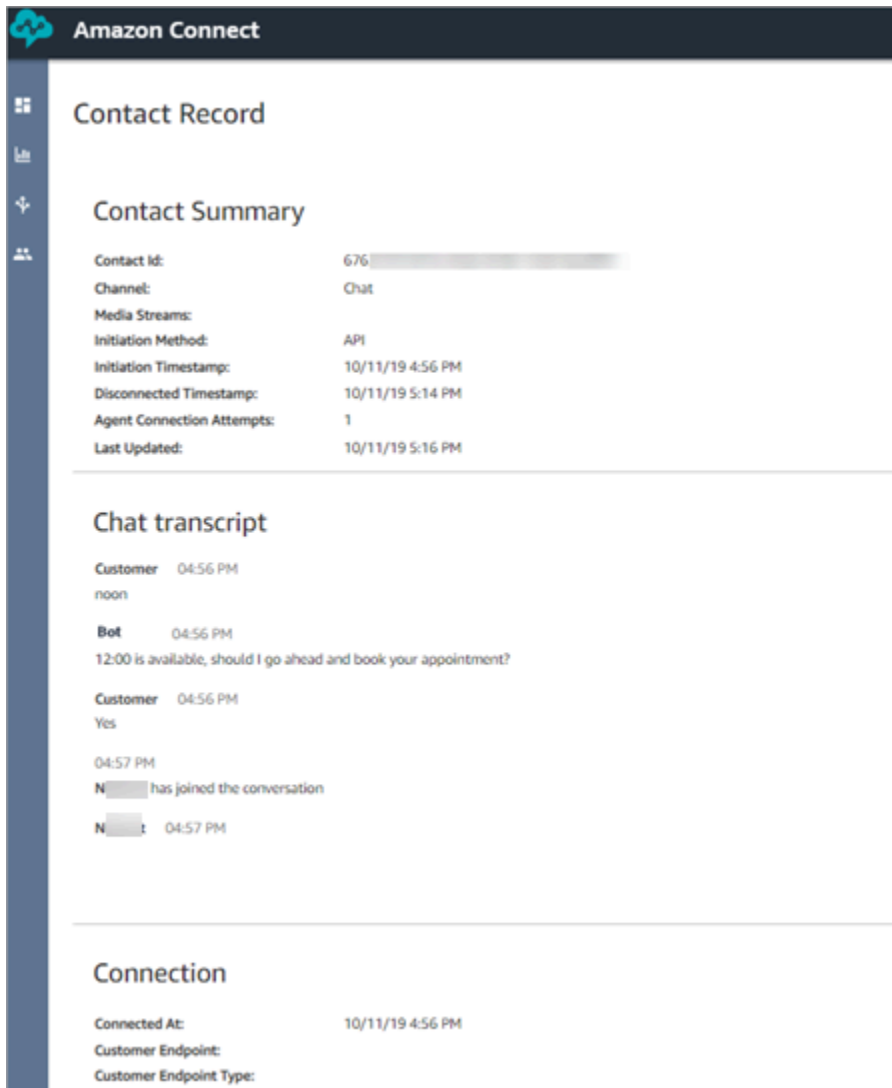

The screenshot displays the Amazon Connect interface for a contact record. The page is titled "Contact Record" and is divided into three main sections: "Contact Summary", "Chat transcript", and "Connection".

Contact Summary

Contact Id:	676 [redacted]
Channel:	Chat
Media Streams:	
Initiation Method:	API
Initiation Timestamp:	10/11/19 4:56 PM
Disconnected Timestamp:	10/11/19 5:14 PM
Agent Connection Attempts:	1
Last Updated:	10/11/19 5:16 PM

Chat transcript

Customer 04:56 PM
noon

Bot 04:56 PM
12:00 is available, should I go ahead and book your appointment?

Customer 04:56 PM
Yes

04:57 PM
N [redacted] has joined the conversation

N [redacted] 04:57 PM

Connection

Connected At:	10/11/19 4:56 PM
Customer Endpoint:	
Customer Endpoint Type:	

About agent status

Agents have a status. It's manually set in the Contact Control Panel (CCP).

- When they're ready to handle contacts, they set their status in the CCP to **Available**. This means inbound contacts can be routed to them.
- When agents want to stop taking inbound contacts, they set their status to a custom status that you create, such as **Break** or **Training**. They can also change their status to **Offline**.

Tip

Managers can manually [change the agent's status in the real-time metrics report](#).

The following diagram illustrates how the agent's status in the CCP stays constant while they are handling contacts, but in the real-time metrics report, the **Agent activity state** and the **Contact state** change.

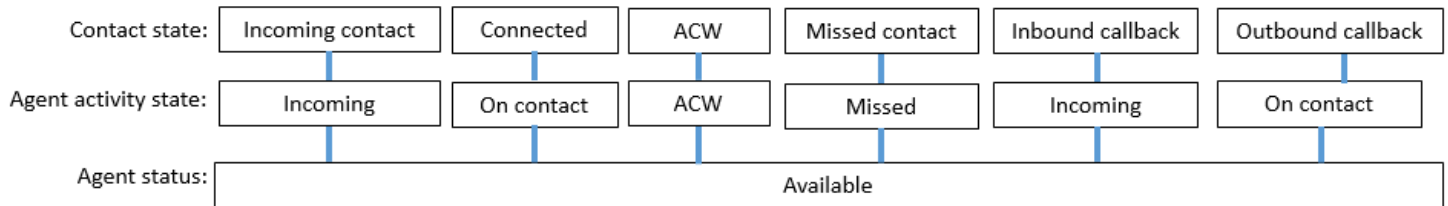

For example, when the **Agent activity state** = **Incoming**, the **Contact state** = **Incoming contact**.

About custom agent statuses

It's possible for agents to make outbound calls when their status in the CCP is set to a custom status. Technically, agents can make an outbound call when their CCP is set to **Offline**.

For example, an agent wants to make an outbound call to a contact. Because they don't want contacts to be routed to them during this time, they set their status to a custom status. So when you look at your real-time metrics report, you'll see the agent is simultaneously on **NPT** (the metric that indicates a custom status) and **On contact**, for example.

About ACW (After contact work)

After a conversation between an agent and customer ends, the contact is moved into the ACW state.

When the agent finishes doing ACW for the contact, they click **Clear** to clear that slot so another contact can be routed to them.

To identify how long an agent spent on ACW for a contact:

- In the historical metrics report, **After contact work time** captures the amount of time each contact spent in ACW.
- In the agent event stream, you have to do some calculations. For more information, see [Determine how long an agent spends doing ACW](#).

How do you know when an agent can handle another contact?

The **Availability** metric tells you when agents are finished with a contact and ready to have another one routed to them.

What appears in the real-time metrics report?

To find out what the agent status is in the real-time metrics report, look at the **Agent Activity** metric.

What appears in the agent event stream?

In the agent event stream you'll see the **AgentStatus**, for example:

```
{
  "AWSAccountId": "012345678901",
  "AgentARN": "arn:aws:connect:us-east-1:012345678901:instance/aaaaaaaa-bbbb-cccc-
  dddd-111111111111/agent/agent-ARN",
  "CurrentAgentSnapshot": {
    "AgentStatus": { //Here's the agent's status that they set in the CCP.
      "ARN": "arn:aws:connect:us-east-1:012345678901:instance/aaaaaaaa-bbbb-cccc-
  dddd-111111111111/agent-state/agent-state-ARN",
      "Name": "Available", //When an agent sets their status to "Available" it
  means they are ready for
                                                                    // inbound contacts to be routed
  to them, and not say, at Lunch.
      "StartTimestamp": "2019-05-25T18:43:59.049Z"
    },
  },
}
```

"We couldn't find this agent. Use the agent's user name to identify them."

On occasion, in the **Contact summary** the **Agent** field may say **"We couldn't find this agent. Use the agent's user name to identify them."** This message is shown in the following image of the **Contact summary**.

Contact summary	
Contact ID	[REDACTED]
Channel	Voice
Initiation method	Inbound
Media streams	[AUDIO]
Start and end time	Apr 2, 22, 01:51:53 pm - 01:54:18 pm
Duration	00:02:25
Disconnect reason	Customer disconnect
Customer phone number	+12075609361
Agent	We couldn't find this agent. Use the agent's user name to identify them
Last updated	Apr 2, 22, 01:55:25 pm

This is a generic message for contacts that did not get connected to an agent at the time. It usually means that the inbound call was not answered by the agent and the customer disconnected the call.

To confirm that the caller was never connected to an agent:

- **Disconnect reason = Customer disconnect.**
- No recording of the call is found for that contact ID.

To verify this behavior, call your contact center and disconnect after a period of time without an agent accepting the call.

About contact states

Contact states appear in two places: the real-time metrics reports and the agent event stream.

Contact states in the agent event stream

There are different events that can appear in the lifecycle of a contact. Each of these events appear in the agent event stream as a **State**. A contact can have the following states that appear in the agent event stream:

- **INCOMING** - This is specific to queued callbacks. The agent is presented with a callback.
- **PENDING** - This is specific to queued callbacks.
- **CONNECTING** - An inbound contact is being offered to the agent (it's ringing). The agent has not yet taken any action to accept or reject the contact, and they haven't missed it.

- **CONNECTED** - The agent has accepted the contact. Now the customer is in a conversation with the agent.
- **CONNECTED_ONHOLD** - They are in a conversation with the agent, and the agent has put the customer on hold.
- **PAUSED** - The contact was paused. This is only applicable to task contacts.
- **MISSED** - The contact was missed by the agent.
- **ERROR** - This appears when, for example, the customer abandons the call during outbound whisper.
- **ENDED** - The conversation has ended, and the agent has started doing ACW for that contact.
- **REJECTED** - The contact was rejected by the agent, or the customer abandoned the contact when it was connecting to the agent.

Here's what the contact state looks like in the agent event stream:

```
"Contacts": [  
  {  
    "Channel": "VOICE", //This shows the agent and contact were talking on the phone.  
    "ConnectedToAgentTimestamp": "2019-05-25T18:55:21.011Z",  
    "ContactId": "ContactId-1", //This shows the agent was working with a contact identified as "ContactId-1".  
    "InitialContactId": null,  
    "InitiationMethod": "OUTBOUND", //This shows the agent reached the customer by making an outbound call.  
    "Queue": {  
      "ARN": "arn:aws:connect:us-east-1:012345678901:instance/aaaaaaaa-bbbb-cccc-dddd-111111111111/queue/queue-ARN-for-BasicQueue",  
    },  
    "QueueTimestamp": null,  
    "State": "CONNECTED", //Here's the contact state. In this case, it shows the contact was CONNECTED to the agent, instead of say, MISSED.  
    "StateStartTimestamp": "2019-05-25T18:55:21.011Z" //This shows when the contact was connected to the agent.  
  }  
]
```



Events in the contact record

A contact record captures events associated with the contact in your contact center. For example, how long the contact lasted, when it started and stopped. For a list of all data that's captured in the contact record, see [Contact records data model](#).

A contact record is opened for a customer when they are connected to your contact center. The contact record is completed when the interaction with the flow or agent ends (that is, the agent has completed the ACW and cleared the contact). This means it's possible for a customer to have multiple contact records.

The following diagram shows when a contact record is created for a contact. It shows three contact records for a contact:

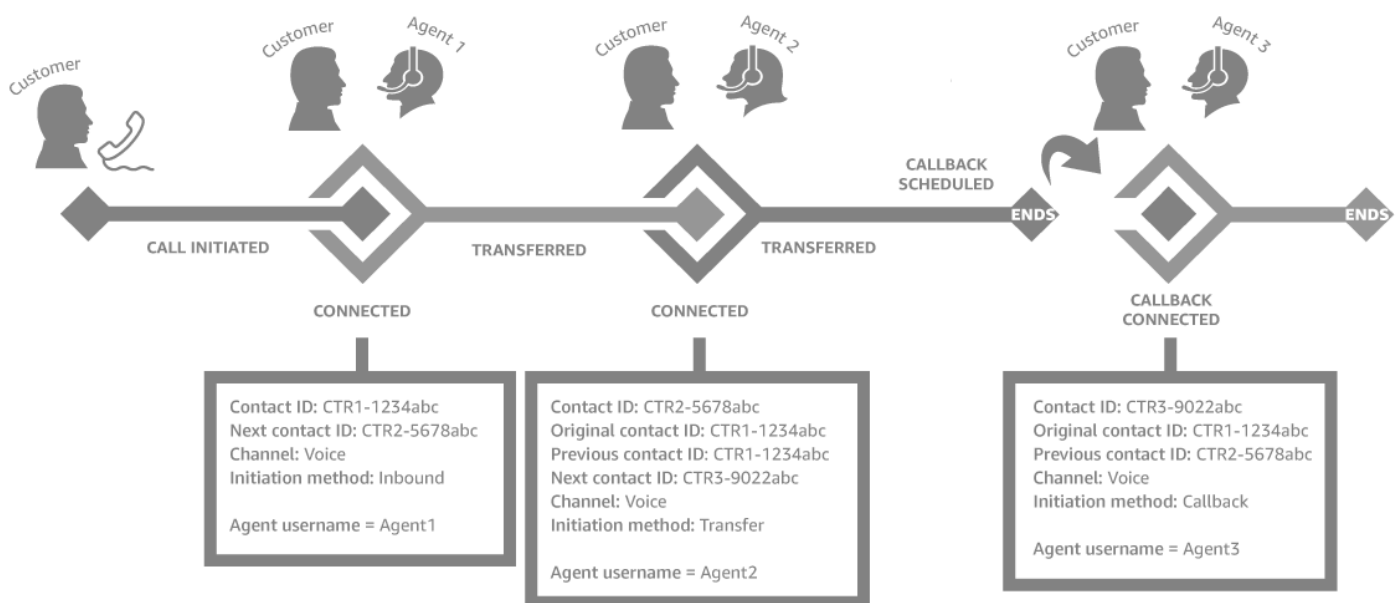
- The first record is created when the contact is connected to Agent 1.
- The second record is created when the contact is transferred to Agent 2.
- The third record is created when the contact is connected to Agent 3 during a callback.



Each time a contact is connected to an agent, a new contact record is created. The contact records for a contact are linked together through the contactId fields: initial, next, previous, and [RelatedContactId](#).

Tip

A contact is considered connected when a contact record is created. It's possible a contact record can be created before a call is finished ringing for the caller, due to network conditions and PSTN event propagation.

About queued callbacks in metrics

This topic explains how queued callbacks appear in your real-time metrics reports and the contact record.

Tip

To see only the number of customers who are waiting for a call back, you need to create a queue that only takes callback contacts. To learn how to do this, see [Set up routing](#). Currently there isn't a way to see the phone numbers of the contacts waiting for callbacks.

1. Callbacks are initiated when the [Transfer to queue](#) block is triggered to create the callback in a callback queue. The following image of a flow shows the **Transfer to queue** block at the end of the flow.

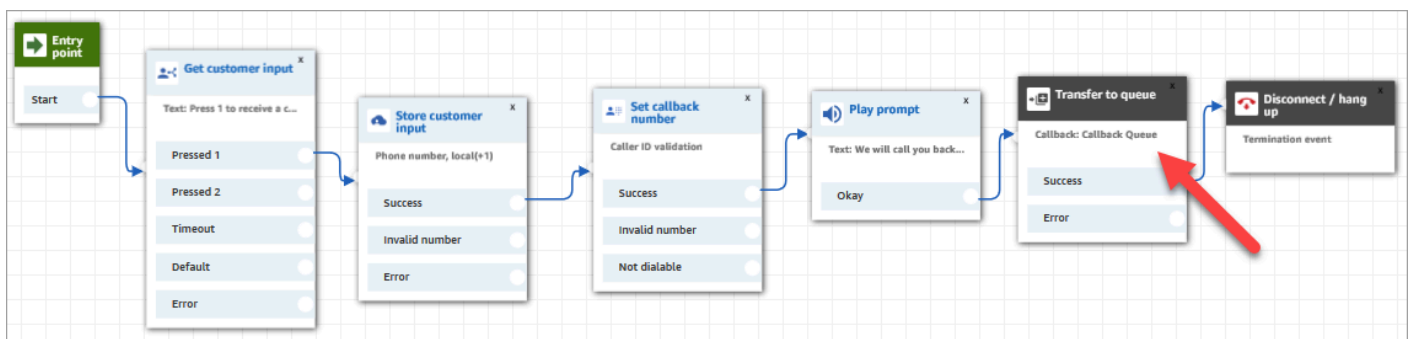

2. After any initial delay is applied, the callback is put into the queue. It remains there until an agent is available and can be offered the contact. The following image shows the contact in the **In queue** column on the **Real-time metrics** page.

Real-time metrics Last Upd

Queues ✎

Queues	Performance				
	PT	In queue	Oldest	Scheduled	Queued
BasicQueue		1	00:05:12	0	1

3. When the callback is connected to the agent, a new contact record is created for the contact. The following diagram shows three contact records. The third record is for the callback, connected to Agent 3.

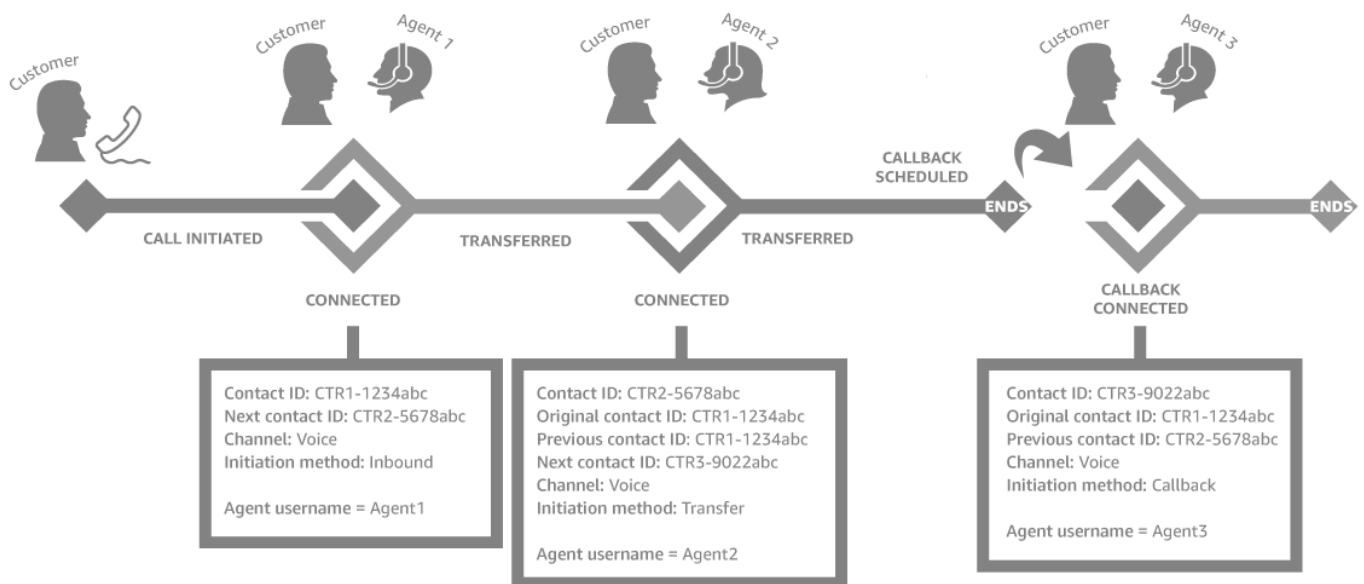

4. The **Initiation Timestamp** in the callback contact record corresponds to when the callback is initiated in the flow, shown in step 1. The following image shows the **Initiation Timestamp** field on the **Contact Record** page.

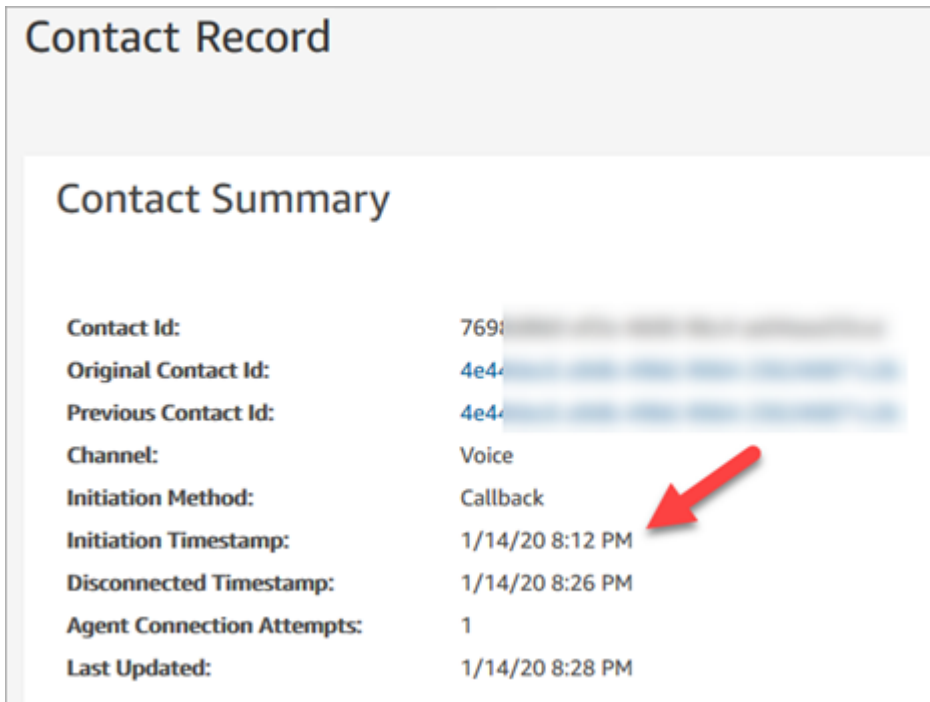

Contact Record	
Contact Summary	
Contact Id:	769[REDACTED]
Original Contact Id:	4e4[REDACTED]
Previous Contact Id:	4e4[REDACTED]
Channel:	Voice
Initiation Method:	Callback
Initiation Timestamp:	1/14/20 8:12 PM
Disconnected Timestamp:	1/14/20 8:26 PM
Agent Connection Attempts:	1
Last Updated:	1/14/20 8:28 PM

How properties in the Transfer to Queue block affect this flow

The [Transfer to queue](#) block has the following properties, which affect how Amazon Connect handles the callback:

- **Initial delay:** This property affects when a callback is put in queue. Specify how much time has to pass between a callback contact being initiated in the flow, and the customer being put in queue for the next available agent. For more information, see [How Initial delay affects Scheduled and In queue metrics](#).
- **Maximum number of retries:** If this is set to 2, then Amazon Connect tries to call the customer at most three times: the initial callback, and two retries.
- **Minimum time between attempts:** If the customer doesn't answer the phone, this is how long to wait before trying again.

How Initial delay affects Scheduled and In queue metrics

In the [Transfer to queue](#) block, the **Initial delay** property affects when a callback is put in queue. For example, assume **Initial delay** is set to 30 seconds. Here's what appears in your real-time metrics report:

1. After 20 seconds, the callback has already been created, but it is not yet in queue because of the **Initial delay** setting. In the following image of the **Real-time metrics** page, **In queue** = 0 and **Scheduled** = 1.

Real-time metrics Last Up

Queues ✎

Queues	IPT	Performance			
		In queue	Oldest	Scheduled	Queued
BasicQueue		0	00:00:00	1	1

The callback is Scheduled while waiting for the Initial delay time to elapse. However, it is not In queue.

2. After 35 seconds, the callback contact has been placed in queue. In the following image, the callback is now **In queue**. It is no longer scheduled.

Real-time metrics Last Up

Queues ✎

Queues	IPT	Performance			
		In queue	Oldest	Scheduled	Queued
BasicQueue		1	00:10:00	0	-

The callback is now in queue. It's no longer scheduled.

3. Assume that after 40 seconds, an agent accepts the callback. The **In queue** column = 0, the **Scheduled** column = 0.

Real-time metrics Last Up

Queues ✎

Queues	IPT	Performance			
		In queue	Oldest	Scheduled	Queued
BasicQueue		0	00:00:00	0	-

The callback has been accepted by an agent.

What counts as a "Failed Callback Attempt"

If an agent doesn't accept an offered callback, it doesn't count as a failed callback attempt. Rather, the routing engine offers the callback to the next available agent, until an agent accepts.

A failed callback attempt would be along the lines of: an agent accepts a callback but then something goes wrong between then and the agent being joined to the customer.

The contact is considered to be in the callback queue until an agent accepts the offered callback contact.

Amazon Connect removes the callback from the queue when it's connected to the agent. At that time, Amazon Connect starts dialing the customer.

The following image shows what this looks like in a contact record:

- **Dequeued At:** The timestamp of when the callback was connected to the agent. It's also when Amazon Connect starts dialing the customer.

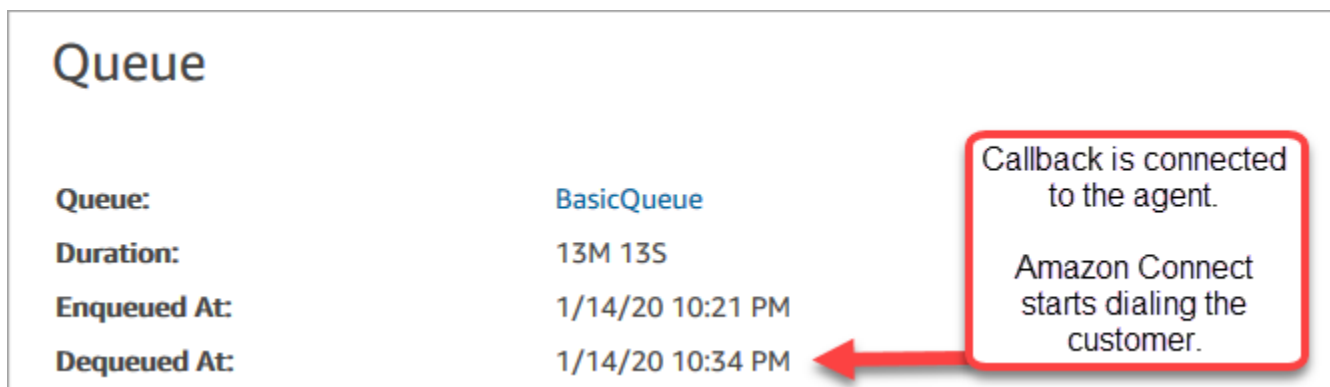

Queue	
Queue:	BasicQueue
Duration:	13M 13S
Enqueued At:	1/14/20 10:21 PM
Dequeued At:	1/14/20 10:34 PM

The enqueued time on the contact record for a particular callback leg corresponds to the amount of time that the contact was in queue before that particular callback attempt was made. This is not the total enqueued time across all contact records.

For example, an inbound call could be in queue for 5 minutes before a callback is scheduled. Then, after an initial delay of 10 seconds, the callback contact could be in a callback queue for 10 seconds before an agent accepts it. In this case, you would see two contact records:

1. The first contact record, with `InitiationMethod=INBOUND`, would have an enqueued time of 5 minutes.

2. The second contact record, with `InitiationMethod=CALLBACK`, would have an enqueued time of 10 seconds.

Example: Metrics for a queued callback

This topic shows an example queued callback flow and reviews how the contact records and times are set for it.

Assume we have set up the following flows:

- **Inbound flow** -- Runs when the customer calls the customer service number.
- **Customer queue flow** – Runs when the customer is waiting in queue. In this example, we build a flow that offers a callback to the customer. If the customer selects yes, this flow executes the **Transfer to queue** block to transfer the contact to the callback queue named `CallbackQueue`, with an initial delay of 99 seconds, and then hangs up.
- **Outbound whisper flow** -- When a queued callback is placed, the customer hears this after they pick up and before they connect to the agent. For example, "Hello, this is your scheduled callback..."
- **Agent whisper flow** -- The agent hears this right after they accept the contact, before they are joined to the customer. For example, "You are about to be connected to Customer John, who requested a refund for..."

In this example, John calls customer service. Here's what happens:

1. Inbound flow creates contact record-1:
 - a. John calls customer service at 11:35. The Inbound flow runs and puts him in queue at 11:35.
 - b. The Customer queue flow runs. At 11:37, John chooses to schedule a callback, so Amazon Connect initiates a callback contact at 11:37, before the inbound contact is disconnected.
2. Callback flow creates contact record-2:
 - a. The callback contact was initiated at 11:37.
 - b. Because the initial delay is 99 seconds, the callback contact is placed into `CallbackQueue` at 11:38:39, after the 99 seconds pass. Now the callback contact is offered to an available agent.
 - c. After 21 seconds, an agent available at 11:39:00 and accepts the contact. The 10-second agent whisper flow is played to the agent.

- d. After the agent whisper flow is complete, Amazon Connect calls John at 11:39:10. John picks up, and listens to the 15-second outbound whisper flow.
- e. When the outbound whisper flow is complete, John is connected to the agent at 11:39:25. They talk until 11:45, and then John hangs up.

This scenario results in two contact records, which include the following metadata.

Contact record-1	Data	Notes
Initiation Method	Inbound	
Initiation Timestamp	11:35	The inbound contact is initiated in Amazon Connect.
ConnectedToSystem Timestamp	11:35	Because this is an inbound contact, InitiationTimestamp = ConnectedToSystemTimestamp.
Next Contact Id	points to contact record-2	
Queue	InboundQueue	
Enqueued Timestamp	11:35	The inbound contact is put in queue.
Dequeued Timestamp	11:37	Because no agent picked up, this is the same as DisconnectedTimestamp.
ConnectedToAgent Timestamp	N/A	John scheduled a callback before any agent could pick up.
Disconnected Timestamp	11:37:00	John was disconnected by flow.

contact record-2	Data	Notes
PreviousContactId	points to contact record-1	
Initiation Timestamp	11:37	The callback contact is created in Amazon Connect.
Queue	CallbackQueue	
Enqueued Timestamp	11:38:39	The contact was put into the CallbackQueue, after the 99-second initial delay completes .
Dequeued Timestamp	11:39:00	After 21 seconds, an agent accepts the contact.
Queue Duration	120 seconds	This is the initial delay (99 seconds), plus any additional time sitting in queue waiting for an agent to become available (21 seconds).
ConnectedToSystem Timestamp	11:39:10	John is called after the 10 second agent whisper flow completes.
ConnectedToAgent Timestamp	11:39:25	John and the agent are connected, after the 15 second outbound whisper flow completes.
Disconnected Timestamp	11:45	John hangs up.

Save custom reports

You can create custom real-time, historical, and login/logout reports that include only the metrics you're interested in. For instructions, see [Create a real-time metrics report](#) and [Create a historical metrics report](#).

After you create a report, you can:

- [Save](#) the custom report and return to it later.
- [Share](#) a link to the custom report so only people in your organization who have the link AND who have the [appropriate permissions](#) in their security profile can access the report.
- [Publish](#) the report so everyone in your organization who has the [appropriate permissions](#) in their security profile can view the report.

Personal saved reports count towards quota

Personal saved reports count towards your service quota of reports per instance. For example, if you save a report every day, it will count towards your organization's number of saved reports for the instance.

For more information about quotas, see [Amazon Connect service quotas](#).

Create a naming convention

All saved reports in your Amazon Connect instance must have a unique name. We recommend creating a naming convention that indicates who the owner of the report is. For example, use the team name or owner alias as the report suffix: Agent Performance - *team name*. That way, if the report is published, others will know who owns it.

If your organization needs to delete reports because you've reached the service quota for reports for your instance, a naming convention that includes the team or owner alias will help you track down the report owners to find out if the report is still needed.

How to save reports

1. Customize a real-time, historical, or login/logout report to include the metrics you want.
2. Choose **Save**. If you don't have permissions in your security profile to create reports, this button will be inactive.

3. Assign a unique name to the report.

Tip

We recommend establishing a naming convention for reports in your organization, especially published reports. This will help everyone identify who the owner is. For example, use the team name or owner alias as the report suffix: *Agent Performance - team name*.

4. To view the report at a later time, on the navigation menu, choose **Analytics and optimization, Saved reports**.

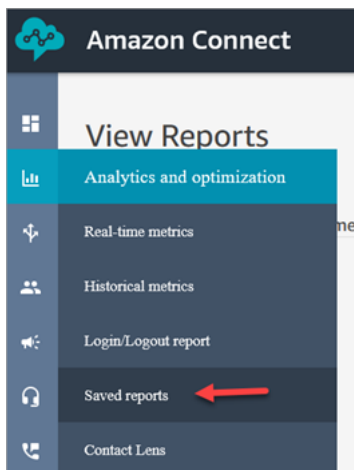

How to delete saved reports

1. Log in to the Amazon Connect admin website at https://instance_name.my.connect.aws/. Use an Admin account or an account that has **Saved reports - Delete** permissions in its security profile.
2. On the navigation menu, choose **Analytics and optimization, Dashboards and reports**.
3. Choose the **Historical metrics** tab.
4. Go to the row that has the report you want to delete, and choose the **Delete** icon, as shown in the following image. If you don't have permissions in your security profile to delete reports, this option won't be available.

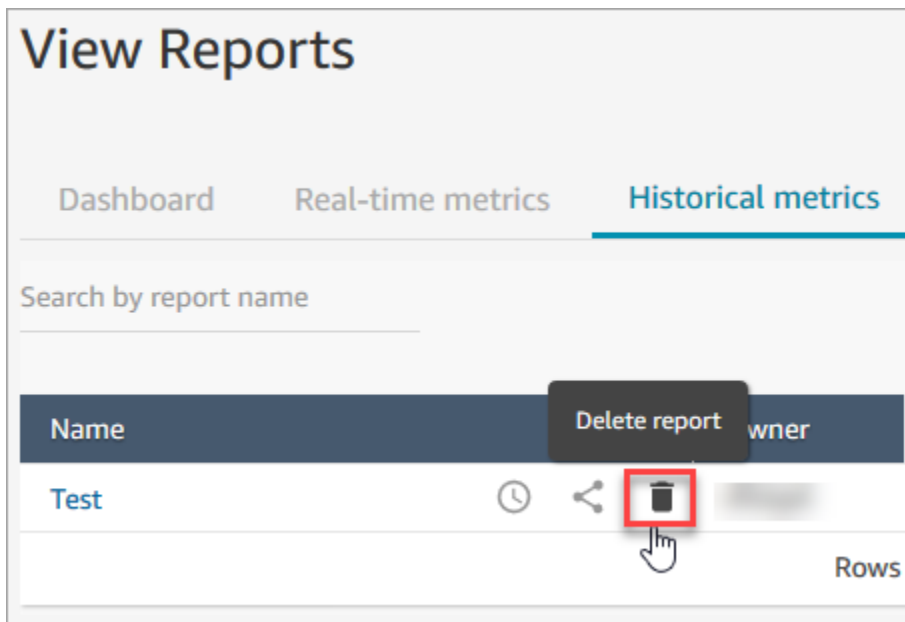

Share custom reports

You can only share reports that you create and save. This means you need the following permissions in your security profile to share reports: **Access metrics - Access** and **Saved reports - Create**. The following image shows the **Access metrics - Access** permissions on the security profiles page.

Analytics and Optimization ⓘ										
Type	All	Access	View	Edit	Create	Enable/Disable	Enable download button	Delete	Publish	Schedule
Access metrics	<input type="checkbox"/>	<input checked="" type="checkbox"/>	<input type="checkbox"/>	<input type="checkbox"/>	<input type="checkbox"/>	<input type="checkbox"/>	<input type="checkbox"/>	<input type="checkbox"/>	<input type="checkbox"/>	<input type="checkbox"/>
Real-time metrics ⓘ	<input type="checkbox"/>	<input checked="" type="checkbox"/>	<input type="checkbox"/>	<input type="checkbox"/>	<input type="checkbox"/>	<input type="checkbox"/>	<input type="checkbox"/>	<input type="checkbox"/>	<input type="checkbox"/>	<input type="checkbox"/>
Historical metrics ⓘ	<input type="checkbox"/>	<input checked="" type="checkbox"/>	<input type="checkbox"/>	<input type="checkbox"/>	<input type="checkbox"/>	<input type="checkbox"/>	<input type="checkbox"/>	<input type="checkbox"/>	<input type="checkbox"/>	<input type="checkbox"/>
Agent activity audit ⓘ	<input type="checkbox"/>	<input checked="" type="checkbox"/>	<input type="checkbox"/>	<input type="checkbox"/>	<input type="checkbox"/>	<input type="checkbox"/>	<input type="checkbox"/>	<input type="checkbox"/>	<input type="checkbox"/>	<input type="checkbox"/>
Contact search	<input type="checkbox"/>	<input type="checkbox"/>	<input type="checkbox"/>	<input type="checkbox"/>	<input type="checkbox"/>	<input type="checkbox"/>	<input type="checkbox"/>	<input type="checkbox"/>	<input type="checkbox"/>	<input type="checkbox"/>
Search contacts by conversation characteristics	<input type="checkbox"/>	<input type="checkbox"/>	<input type="checkbox"/>	<input type="checkbox"/>	<input type="checkbox"/>	<input type="checkbox"/>	<input type="checkbox"/>	<input type="checkbox"/>	<input type="checkbox"/>	<input type="checkbox"/>
Search contacts by keywords	<input type="checkbox"/>	<input type="checkbox"/>	<input type="checkbox"/>	<input type="checkbox"/>	<input type="checkbox"/>	<input type="checkbox"/>	<input type="checkbox"/>	<input type="checkbox"/>	<input type="checkbox"/>	<input type="checkbox"/>
Configure searchable contact attributes	<input type="checkbox"/>	<input type="checkbox"/>	<input type="checkbox"/>	<input type="checkbox"/>	<input type="checkbox"/>	<input type="checkbox"/>	<input type="checkbox"/>	<input type="checkbox"/>	<input type="checkbox"/>	<input type="checkbox"/>

To share reports

- On the page of the report you want to share, choose the **Actions** dropdown menu and then choose **Share report**. The following image shows an example report named **Historical metrics: Test**, and the location of the **Share report** option in the **Actions** dropdown menu.

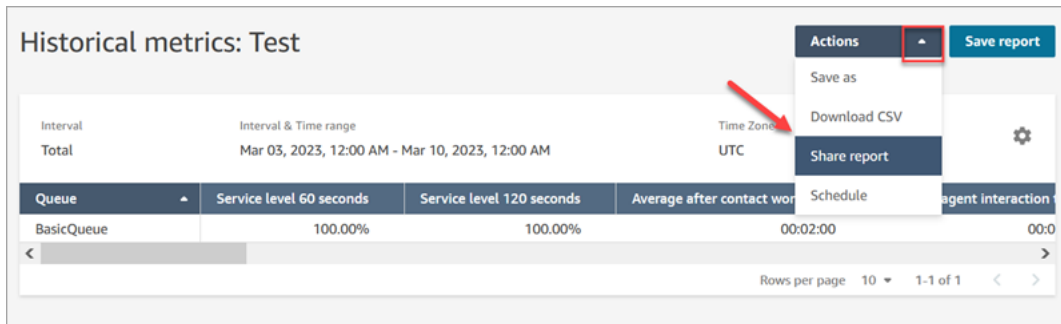

Or, from your list of saved reports, choose the **Share report** icon, as shown in the following image.

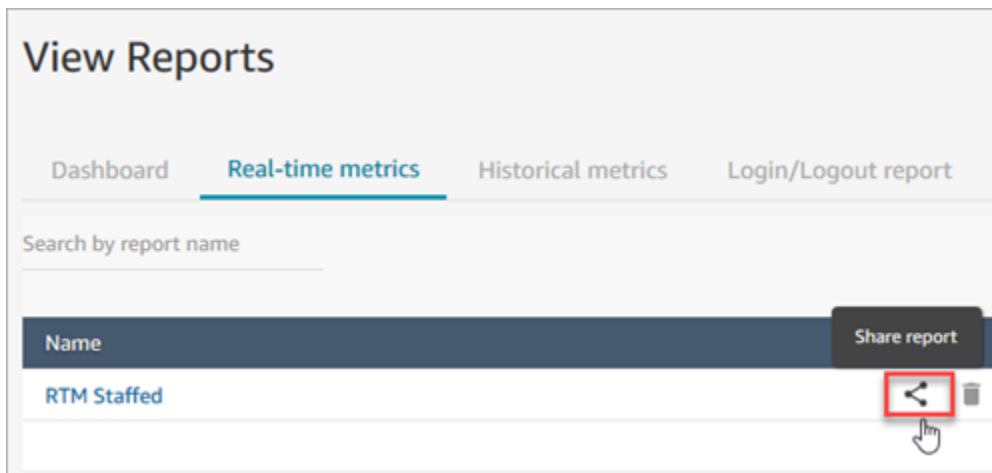

2. Choose **Copy link address** and choose **Save**, as shown in the following image. This saves the link to your clipboard. Paste this link into an email or other location to share the report.

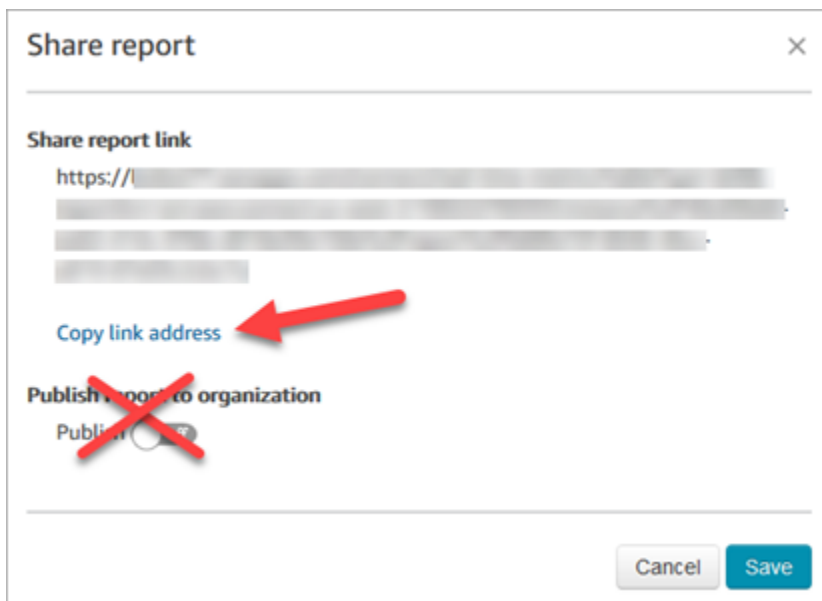

You don't need to publish the report to your organization in order to share the link with specific people.

⚠ Important

Anyone who has the link and the appropriate permissions can access the report.

View a shared report

To view a report that someone has shared with you, you need the following:

- A link to the report.
- Permissions in your security profile:
 - **Access metrics**, if the report is a real-time or historical metrics report
 - **View Login/Logout report**, if the report is a login/logout report
 - **View Saved reports**

These permissions are shown in the following image of the **Analytics and Optimization** section of the security profiles page.

Type	All	Access	View
Access metrics	<input type="checkbox"/>	<input checked="" type="checkbox"/>	<input type="checkbox"/>
Contact search	<input type="checkbox"/>	<input type="checkbox"/>	<input type="checkbox"/>
Contact attributes	<input type="checkbox"/>	<input type="checkbox"/>	<input type="checkbox"/>
Login/Logout report	<input type="checkbox"/>	<input type="checkbox"/>	<input checked="" type="checkbox"/>
Manager monitor	<input type="checkbox"/>	<input type="checkbox"/>	<input type="checkbox"/>
Recorded conversations	<input type="checkbox"/>	<input type="checkbox"/>	<input type="checkbox"/>
Saved reports	<input type="checkbox"/>	<input type="checkbox"/>	<input checked="" type="checkbox"/>

Tips for viewing a shared report

- Every time you want to view the shared report, you need to access it through the link that was shared with you.
- If you get a 505 error when you choose the link that was shared with you, it means you don't have permissions to view the report.
- There's no way to save the exact same report to your list of Saved reports. You can give the report a new name and save it to your list, but then it's a different report from the one that was shared with you. If the owner of original report makes changes, you won't see them in your renamed report.

Publish reports

After you create and save a custom report with the metrics you're interested in, you can publish it so everyone in your organization with the [appropriate permissions](#) can access the report.

After a report is published, people will be able to see the report in their list of Saved reports.

Tip

We recommend establishing a naming convention for reports in your organization. When reports are published, this will help everyone identify who the owner is. For example, use the team name or owner alias as the report suffix: Agent Performance - *team name*.

Only people who have permissions in their security profile to **Create** and/or **Edit** saved reports will be able to change the published report and save their changes to the published version.

To publish a report

1. On the real-time metrics, historical metrics, login/logout report, or Saved reports page, choose **Share report**.
2. In the **Share report** dialog box, toggle **Publish report** to **On**, and then choose **Save**. This toggle is shown in the following image of the dialog box.

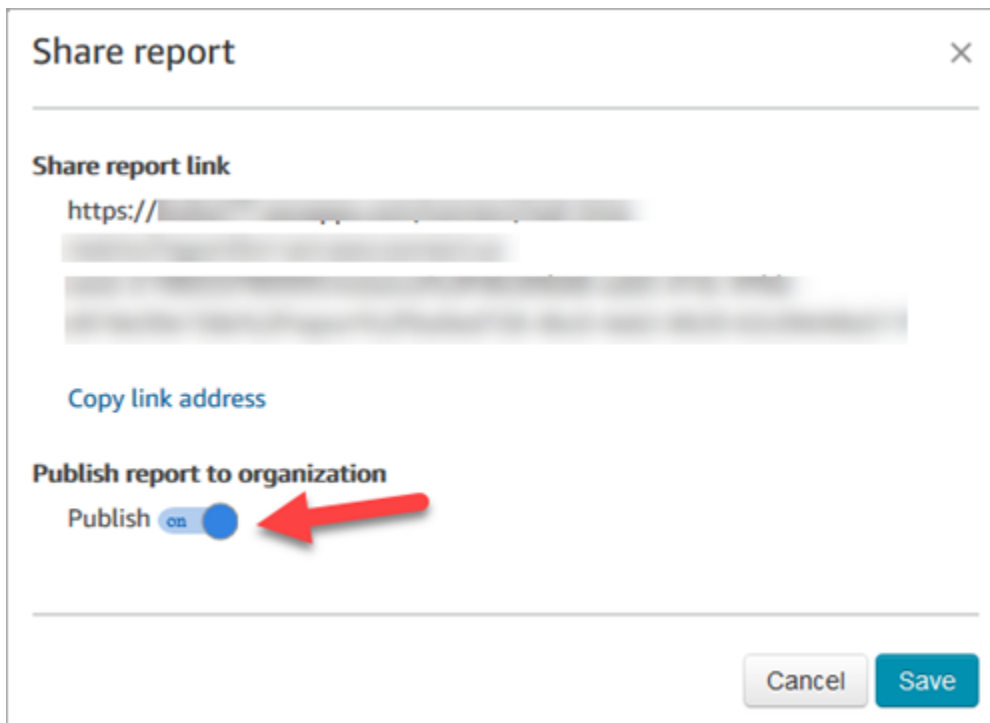

The report appears in the list of Saved reports for everyone who has appropriate permissions in their security profile.

3. To unpublish the report, move the toggle to **Off**.

The report is removed from everyone's list of Saved reports.

View published reports

To view published reports, at minimum you need the following permissions in your security profile:

- **Access metrics**, if the report is a real-time or historical metrics report
- **View Login/Logout report**, if the report is a login/logout report
- **View Saved reports**

These permissions are shown in the following image of the **Analytics and Optimization** section of the security profiles page.

Type	All	Access	View
Access metrics	<input type="checkbox"/>	<input checked="" type="checkbox"/>	<input type="checkbox"/>
Contact search	<input type="checkbox"/>	<input type="checkbox"/>	<input type="checkbox"/>
Contact attributes	<input type="checkbox"/>	<input type="checkbox"/>	<input type="checkbox"/>
Login/Logout report	<input type="checkbox"/>	<input type="checkbox"/>	<input checked="" type="checkbox"/>
Manager monitor	<input type="checkbox"/>	<input type="checkbox"/>	<input type="checkbox"/>
Recorded conversations	<input type="checkbox"/>	<input type="checkbox"/>	<input type="checkbox"/>
Saved reports	<input type="checkbox"/>	<input type="checkbox"/>	<input checked="" type="checkbox"/>

To view published reports

1. Log in to the Amazon Connect admin website at https://instance_name.my.connect.aws/. Use an account that has the appropriate permissions.
2. On the navigation menu, choose **Analytics and optimization, Dashboards and reports**.

Published reports appear in your list automatically.

Manage saved reports (admin)

You can view and delete all saved reports in your instance, including reports that were not created by you or that are not currently published.

To do this, you need the **Analytics and Optimization - Saved reports (admin)** permission in your security profile.

View and delete reports

1. Log in to the Amazon Connect admin website at https://instance_name.my.connect.aws/. Use an account that has **Save reports (admin) - All** in its security profile.
2. On the navigation menu, choose **Analytics and Optimization, Dashboards and reports**.
3. On the **View Reports** page, choose **All reports**.

4. Use the filters to search by report name, report type, published status, and user.
5. To delete reports, select the reports by using the boxes on the left and then choose **Remove**, as shown in the following image.

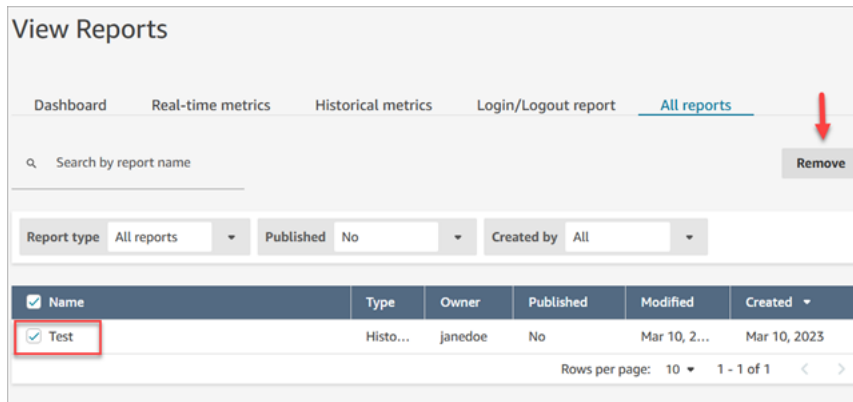

Monitoring your instance using CloudWatch

Amazon Connect sends data about your instance to CloudWatch metrics so that you can collect, view, and analyze CloudWatch metrics for your Amazon Connect virtual contact center. You can use this data to monitor key operational metrics and set up alarms. Data about your contact center is sent to CloudWatch every 1 minute.

When you view the CloudWatch metrics dashboard, you can specify the refresh interval for the data displayed. The values displayed in the dashboard reflect the values for the refresh interval you define. For example, if you set the refresh interval to 1 minute, the values displayed are for a minute period. You can select a refresh interval of 10 seconds, but Amazon Connect does not send data more often than every 1 minute. Metrics that are sent to CloudWatch are available for two weeks, and then discarded. To learn more about metrics in CloudWatch, see the [Amazon CloudWatch User Guide](#).

Note

If your Amazon Connect instance was created on or before October 2018, you need to provide Amazon Connect with permission to begin publishing chat metrics to your CloudWatch account. To do so, create an IAM policy with the following permission and attach it to the Amazon Connect service role. You can find the Amazon Connect service role on the **Account overview** page for your Amazon Connect instance.

```
{
  "Effect": "Allow",
  "Action": "cloudwatch:PutMetricData",
  "Resource": "*",
  "Condition": {
    "StringEquals": {
      "cloudwatch:namespace": "AWS/Connect"
    }
  }
}
```

Amazon Connect metrics sent to CloudWatch

The AWS/Connect namespace includes the following metrics.

Metric	Description
CallsBreachingConcurrencyQuota	<p>The total number of voice calls that exceeded the concurrent calls quota for the instance. For the total number of calls that breach the quota, take a look at the Sum statistic.</p> <p>For example, assume your contact center experiences the following volumes, and your service quota is 100 concurrent calls:</p> <ul style="list-style-type: none"> 0:00 : 125 concurrent calls. This is 25 over the quota. 0:04 : 135 concurrent calls. This is 35 over the quota. 0:10 : 150 concurrent calls. This is 50 over the quota. <p>CallsBreachingConcurrencyQuota = 110: the total number of voice calls that exceeded the quota between 0:00 and 0:10.</p> <p>Unit: Count</p> <p>Dimension:</p> <ul style="list-style-type: none"> InstanceId: The ID of your instance

Metric	Description
CallbackNotDialableNumber	<ul style="list-style-type: none"> • MetricGroup: VoiceCalls <p>The number of times a queued callback to a customer could not be dialed because the customer's number is in a country for which outbound calls are not allowed for the instance. The countries allowed for an instance are defined by the service quotas.</p> <p>Unit: Count</p> <p>Dimensions:</p> <ul style="list-style-type: none"> • InstanceId The ID of your instance • MetricGroup: ContactFlow • ContactFlowName: The name of your flow
CallRecordingUploadError	<p>The number of call recordings that failed to upload to the Amazon S3 bucket configured for your instance. This is the bucket specified in Data Storage > Call Recordings settings for the instance.</p> <p>Unit: Count</p> <p>Dimensions:</p> <ul style="list-style-type: none"> • InstanceId: The ID of your instance • MetricGroup: CallRecordings
CallsPerInterval	<p>The number of voice calls, both inbound and outbound, received or placed per second in the instance.</p> <p>Unit: Count</p> <p>Dimensions:</p> <ul style="list-style-type: none"> • InstanceId: The ID of your instance • MetricGroup: VoiceCalls

Metric	Description
ChatsBreachingActiveChatQuota	<p>The total number of valid requests made to start a chat that exceeded the concurrent active chats quota for the instance. For the total number of chats requests that breach the quota, take a look at the Sum statistic.</p> <p>For example, assume your contact center experiences the following volumes, and your service quota is 2500 concurrent active chats:</p> <ul style="list-style-type: none">• 0:00 : 2525 concurrent active chats. This is 25 over the quota.• 0:04 : 2535 concurrent active chats. This is 35 over the quota.• 0:10 : 2550 concurrent active chats. This is 50 over the quota. <p>ChatsBreachingActiveChatsQuota = 110: the total number of chats that exceeded the quota between 0:00 and 0:10.</p> <p>Unit: Count</p> <p>Dimensions:</p> <ul style="list-style-type: none">• InstanceId: The ID of your instance• MetricGroup: Chats

Metric	Description
ConcurrentActiveChats	<p>The number of concurrent active chats in the instance at the time the data is displayed in the dashboard. The value displayed for this metric is the number of concurrent active chats at the time the dashboard is displayed, and not a sum for the entire interval of the refresh interval set. All active chats are included, not only active chats that are connected to agents.</p> <p>While all statistics are available in CloudWatch for concurrent active chats, you might be most interested in looking at the Maximum/Average statistic. The Sum statistic isn't as useful here.</p> <p>Unit: Count</p> <p>Dimensions:</p> <ul style="list-style-type: none">• InstanceId: The ID of your instance• MetricGroup: Chats

Metric	Description
ConcurrentActiveChatsPercentage	<p>The percentage of the concurrent active chats service quota used in the instance. This is calculated by:</p> <ul style="list-style-type: none">• $\text{ConcurrentActiveChats} / \text{ConfiguredConcurrentActiveChatsLimit}$ <p>Where <code>ConfiguredConcurrentActiveChatsLimit</code> is the Concurrent active chats per instance configured for your instance.</p> <p>Unit: Percent (Output displays as an integer. For example, 1% of chats is shown as 1, not as 0.01.)</p> <p>Dimensions:</p> <ul style="list-style-type: none">• InstanceId: The ID of your instance• MetricGroup: Chats

Metric	Description
ConcurrentCalls	<p>The number of concurrent active voice calls in the instance at the time the data is displayed in the dashboard. The value displayed for this metric is the number of concurrent active calls at the time the dashboard is displayed, and not a sum for the entire interval of the refresh interval set. All active voice calls are included, not only active calls that are connected to agents.</p> <p>While all statistics are available in CloudWatch for concurrent voice calls you might be most interested in looking at the Maximum/Average statistic. The Sum statistic isn't as useful here.</p> <p>Unit: Count</p> <p>Dimensions:</p> <ul style="list-style-type: none">• InstanceId: The ID of your instance• MetricGroup: VoiceCalls
ConcurrentCallsPercentage	<p>The percentage of the concurrent active voice calls service quota used in the instance. This is calculated by:</p> <ul style="list-style-type: none">• $\text{ConcurrentCalls} / \text{ConfiguredConcurrentCallsLimit}$ <p>Unit: Percent (output displays as a decimal)</p> <p>Dimensions:</p> <ul style="list-style-type: none">• InstanceId: The ID of your instance• MetricGroup: VoiceCalls

Metric	Description
ConcurrentTasks	<p>The number of concurrent active tasks in the instance at the time the data is displayed in the dashboard. The value displayed for this metric is the number of concurrent active tasks at the time the dashboard is displayed, and not a sum for the entire interval of the refresh interval set. All active tasks are included, not only active tasks that are connected to agents.</p> <p>While all statistics are available in CloudWatch for concurrent tasks you might be most interested in looking at the Maximum/Average statistic. The Sum statistic isn't as useful here.</p> <p>Unit: Count</p> <p>Dimensions:</p> <ul style="list-style-type: none">• InstanceId: The ID of your instance• MetricGroup: Tasks
ConcurrentTasksPercentage	<p>The percentage of the concurrent active tasks service quota used in the instance. This is calculated by:</p> <ul style="list-style-type: none">• $\text{ConcurrentTasks} / \text{ConfiguredConcurrentTasksLimit}$ <p>Where <code>ConfiguredConcurrentTasksLimit</code> is the Concurrent tasks per instance configured for your instance.</p> <p>Unit: Percent (output displays as a decimal)</p> <p>Dimensions:</p> <ul style="list-style-type: none">• InstanceId: The ID of your instance• MetricGroup: Tasks

Metric	Description
ContactFlowErrors	<p>The number of times the error branch for a flow was run.</p> <p>Unit: Count</p> <p>Dimensions:</p> <ul style="list-style-type: none">• InstanceId: The ID of your instance• MetricGroup: ContactFlow• ContactFlowName: The name of your flow
ContactFlowFatalErrors	<p>The number of times a flow failed to execute due to a system error.</p> <p>Unit: Count</p> <p>Dimensions:</p> <ul style="list-style-type: none">• InstanceId: The ID of your instance• MetricGroup: ContactFlow• ContactFlowName: The name of your flow
LongestQueueWaitTime	<p>The longest amount of time, in seconds, that a contact waited in a queue. This is the length of time a contact waited in a queue during the refresh interval selected in the CloudWatch dashboard, such as 1 minute or 5 minutes.</p> <p>Unit: Seconds</p> <p>Dimensions:</p> <ul style="list-style-type: none">• InstanceId: The ID of your instance• MetricGroup: Queue• QueueName: The name of your queue

Metric	Description
MissedCalls	<p>The number of voice calls that were missed by agents during the refresh interval selected, such as 1 minute or 5 minutes. A missed call is one that is not answered by an agent within 20 seconds.</p> <p>To monitor the total missed calls in a given time period, take a look at the Sum statistic in CloudWatch.</p> <p>Unit: Count</p> <p>Dimensions:</p> <ul style="list-style-type: none">• InstanceId: The ID of your instance• MetricGroup: VoiceCalls
MisconfiguredPhoneNumbers	<p>The number of calls that failed because the phone number is not associated with a flow.</p> <p>Unit: Count</p> <p>Dimensions:</p> <ul style="list-style-type: none">• InstanceId: The ID of your instance• MetricGroup: VoiceCalls
PublicSigningKeyUsage	<p>The number of times a flow security key (public signing key) was used to encrypt customer input in a flow.</p> <p>Unit: Count</p> <p>Dimensions:</p> <ul style="list-style-type: none">• InstanceId: The ID of your instance• SigningKeyId: The ID of your signing key

Metric	Description
QueueCapacityExceededError	<p>The number of calls that were rejected because the queue was full.</p> <p>Unit: Count</p> <p>Dimensions:</p> <ul style="list-style-type: none">• InstanceId: The ID of your instance• MetricGroup: Queue• QueueName: The name of your queue
QueueSize	<p>The number of contacts in the queue. The value reflects the number of contacts in the queue at the time the dashboard is accessed, not for the duration of the reporting interval.</p> <p>Unit: Count</p> <p>Dimensions:</p> <ul style="list-style-type: none">• InstanceId: The ID of your instance• MetricGroup: Queue• QueueName: The name of your queue
SuccessfulChatsPerInterval	<p>The number of chats successfully started in the instance for the defined interval.</p> <p>Unit: Count</p> <p>Dimensions:</p> <ul style="list-style-type: none">• InstanceId: The ID of your instance• MetricGroup: Chats

Metric	Description
TasksBreachingConcurrencyQuota	<p>The total number of tasks that exceeded the concurrent tasks quota for the instance. For the total number of tasks that breach the quota, take a look at the Sum statistic.</p> <p>For example, assume your contact center experiences the following volumes, and your service quota is 2500 concurrent tasks:</p> <ul style="list-style-type: none"> • 0:00 : 2525 concurrent tasks. This is 25 over the quota. • 0:04 : 2535 concurrent tasks. This is 35 over the quota. • 0:10 : 2550 concurrent tasks. This is 50 over the quota. <p>TasksBreachingConcurrencyQuota = 110: the total number of tasks that exceeded the quota between 0:00 and 0:10.</p> <p>Unit: Count</p> <p>Dimensions:</p> <ul style="list-style-type: none"> • InstanceId: The ID of your instance • MetricGroup: Tasks
TasksExpired	<p>Tasks which have expired after being active for 7 days.</p> <p>To monitor the total number of tasks that have expired in a given time period, take a look at the Sum statistic in CloudWatch.</p> <p>Unit: Count</p> <p>Dimensions:</p> <ul style="list-style-type: none"> • InstanceId: The ID of your instance • MetricGroup: Tasks • ContactId: The ID of the task contact

Metric	Description
TasksExpiryWarningReached	<p>Tasks that have been active for 6 days 22 hours and reached expiry warning limit.</p> <p>To monitor the total number of tasks that have reached expiry warning limit in a given time period, take a look at the Sum statistic in CloudWatch.</p> <p>Unit: Count</p> <p>Dimensions:</p> <ul style="list-style-type: none">• InstanceId: The ID of your instance• MetricGroup: Tasks• ContactId: The ID of the task contact
ThrottledCalls	<p>The number of voice calls that were rejected because the rate of calls per second exceeded the maximum supported quota. To increase the supported rate of calls, request an increase in the service quota for concurrent active calls per instance.</p> <p>To monitor the total throttled calls in a given time period, take a look at the Sum statistic in CloudWatch.</p> <p>Unit: Seconds</p> <p>Unit: Count</p> <p>Dimensions:</p> <ul style="list-style-type: none">• InstanceId: The ID of your instance• MetricGroup: VoiceCalls

Metric	Description
ToInstancePacketLossRate	<p>The ratio of packet loss for calls in the instance, reported every 10 seconds. Each data point is between 0 and 100. The ratio of packet loss for calls in the instance appears as a percent between 0 and 1.</p> <p>Unit: Percent</p> <p>Dimensions:</p> <ul style="list-style-type: none">• Participant: Agent• Type of Connection: WebRTC• Instance ID: The ID of your instance• Stream Type: Voice

Amazon Connect CloudWatch metrics dimensions

In CloudWatch, a dimension is a name/value pair that uniquely identifies a metric. In the dashboard, metrics are grouped by dimension. When you view metrics in the dashboard, only metrics with data are displayed. If there is no activity during the refresh interval for which there is a metric, then no data from your instance is displayed in the dashboard.

The following dimensions are used in the CloudWatch dashboard for Amazon Connect metrics.

Flow metrics dimension

Note

If a flow has a dimension name in non-ASCII characters, you won't be able to see it in CloudWatch.

Filters metric data by flow. Includes the following metrics:

- ContactFlowErrors
- ContactFlowFatalErrors

- PublicSigningKeyUsage

Contact metrics dimension

Filters metric data by contacts. Includes the following metrics:

- TasksExpiryWarningReached
- TasksExpired

Instance metrics dimension

Filters meta data by instance. Includes the following metrics:

- CallsBreachingConcurrencyQuota
- CallsPerInterval
- CallRecordingUploadError
- ChatsBreachingActiveChatQuota
- ConcurrentActiveChats
- ConcurrentActiveChatsPercentage
- ConcurrentCalls
- ConcurrentCallsPercentage
- ConcurrentTasks
- ConcurrentTasksPercentage
- MisconfiguredPhoneNumbers
- MissedCalls
- SuccessfulChatsPerInterval
- TasksBreachingConcurrencyQuota
- ThrottledCalls

Instance ID, Participant, Stream Type, Type of Connection

Filters metric data by connection. Includes the following metrics:

- ToInstancePacketLossRate

Queue metrics dimension

Note

If a queue has a dimension name in non-ASCII characters, you won't be able to see it in CloudWatch.

Filters metric data by queue. Includes the following metrics:

- `CallBackNotDialableNumber`
- `LongestQueueWaitTime`
- `QueueCapacityExceededError`
- `QueueSize`

Amazon Connect Voice ID metrics sent to CloudWatch

The `VoiceID` namespace includes the following metrics.

RequestLatency

The elapsed time for the request.

Frequency: 1 minute

Unit: Milliseconds

Dimension: API

UserErrors

The number of Error counts due to bad requests from user.

Frequency: 1 minute

Unit: Count

Dimension: API

SystemErrors

The number of Error counts due to internal service error.

Frequency: 1 minute

Unit: Count

Dimension: API

Throttles

The number of requests that are rejected due to exceeding the max rate allowed for sending requests.

Frequency: 1 minute

Unit: Count

Dimension: API

ActiveSessions

The number of active sessions in the domain. Active sessions are sessions that are in pending or ongoing status.

Frequency: 1 minute

Unit: Count

Dimension: Domain

ActiveSpeakerEnrollmentJobs

The number of active Batch Enrollment Jobs in the domain. Active Jobs are those which are in Pending or InProgress status.

Frequency: 15 minutes

Unit: Count

Dimension: Domain

ActiveFraudsterRegistrationJobs

The number of active Batch Registration Jobs in the domain. Active Jobs are those which are in Pending or InProgress status.

Frequency: 15 minutes

Unit: Count

Dimension: Domain

Speakers

The number of Speakers in the domain.

Frequency: 15 minutes

Unit: Count

Dimension: Domain

Fraudsters

The number of Fraudsters in the domain.

Frequency: 15 minutes

Unit: Count

Dimension: Domain

Amazon Connect Voice ID metrics dimensions

The following dimensions are used in the CloudWatch dashboard for Amazon Connect Voice ID metrics. When you view metrics in the dashboard, only metrics with data are displayed. If there is no activity during the refresh interval for which there is a metric, then no data from your instance is displayed in the dashboard.

API metrics dimension

This dimension limits the data to one of the following Voice ID operations:

- DeleteFraudster
- EvaluateSession
- ListSpeakers
- DeleteSpeaker
- OptOutSpeaker

Domain metrics dimension

The Voice ID domain where the enrollment, authentication or registration is conducted.

Amazon AppIntegrations metrics sent to CloudWatch

The AWS/AppIntegrations namespace includes the following metrics.

RecordsDownloaded

The number of records that were successfully downloaded as part of an AppFlow flow execution for a data integration.

Frequency: 1 minute

Unit: Count

Valid Statistics: Maximum, Sum, Minimum, Average

RecordsFailed

The number of records that failed to download as part of an AppFlow flow execution for a data integration.

Frequency: 1 minute

Unit: Count

Valid Statistics: Maximum, Sum, Minimum, Average

DataDownloaded

The number of bytes that were successfully downloaded as part of an AppFlow flow execution for a data integration.

Frequency: 1 minute

Unit: Bytes

Valid Statistics: Maximum, Sum, Minimum, Average

DataProcessingDuration

The time it took to process and download data as part of a single AppFlow flow execution for a data integration.

Frequency: 1 minute

Unit: Milliseconds

Valid Statistics: Maximum, Sum, Minimum, Average

EventsReceived

The number of events that were successfully emitted from your third-party source application (Salesforce, Zendesk) and received on your event bus.

Frequency: 1 minute

Unit: Count

Valid Statistics: Maximum, Sum, Minimum, Average

EventsProcessed

The number of events that were successfully processed and forwarded to be evaluated against the rules you configured on an event integration.

Frequency: 1 minute

Unit: Count

Valid Statistics: Maximum, Sum, Minimum, Average

EventsThrottled

The number of events that were throttled because the rate of emitting events exceeded the maximum supported quota.

Frequency: 1 minute

Unit: Bytes

Valid Statistics: Maximum, Sum, Minimum, Average

EventsFailed

The number of events that failed to process due to malformed or unsupported third-party events, and other processing errors .

Frequency: 1 minute

Unit: Bytes

Valid Statistics: Maximum, Sum, Minimum, Average

EventProcessingDuration

The time it took to successfully process and forward an event to be evaluated against the rules you configured on an event integration.

Frequency: 1 minute

Unit: Milliseconds

Valid Statistics: Maximum, Sum, Minimum, Average

Amazon AppIntegrations metric dimensions

You can use the following dimensions to refine AppIntegrations [metrics](#).

Dimension	Description
AccountId	AWS account ID
ClientId	Service principal of the client
IntegrationARN	ARN of the event or data integration
IntegrationType	DataIntegration or EventIntegration
Region	Region of the data or event integration

Amazon Connect Customer Profiles metrics

The `AWS/CustomerProfiles` namespace includes the following metrics.

Real-time export metrics sent to CloudWatch

The two following metrics will be published to CloudWatch for every export task. These metrics will provide information on your export stream tasks and will allow you to configure your Kinesis streams based on your use case. In the case of being throttled, these metrics will enable you to provision your Kinesis stream to ensure delivery to your destination.

EventsProcessed

Number of records successfully streamed into a Kinesis Stream.

Unit: Count

EventsThrottled

Number of PutRecord attempts that encountered throttling exception.

Unit: Count

Amazon Connect Customer Profiles metric dimensions

You can use the following dimensions to refine Customer Profiles [metrics](#).

Dimension	Description
DomainName	Customer Profiles domain name
DestinationType	Type of destination. Available value is: Kinesis
DestinationName	Name of destination. Kinesis Data Streaming name for DestinationType: Kinesis.

Use CloudWatch metrics to calculate concurrent call quota

Important

The **ConcurrentCallsPercentage** calculation information is not the same as **ConcurrentTasksPercentage** and **ConcurrentChatPercentage**.

- The metrics emitted for **ConcurrentCallsPercentage** are in decimal and not multiplied by 100. The metric represents a percentage of your total quota.
- For **ConcurrentTasksPercentage** and **ConcurrentChatPercentage** the value is multiplied by 100. That gives you your total quota.
- The metrics emitted are correct and there is no discrepancy in data.

Here's how to calculate your quota usage for concurrent calls.

With calls active in the system, look at **ConcurrentCalls** and **ConcurrentCallsPercentage**. Calculate how much of your quota has been used:

- $(\text{ConcurrentCalls} / \text{ConcurrentCallsPercentage})$

For example, if **ConcurrentCalls** is 20 and **ConcurrentCallsPercentage** is 50, your quota usage is calculated as $(20/0.5) = 40$. Your total quota is 40 calls.

Use CloudWatch metrics to calculate concurrent active chats quota

Here's how to calculate your quota for concurrent active chats.

With chats active in the system, look at **ConcurrentActiveChats** and **ConcurrentChatsPercentage**. Calculate the quota:

- $(\text{ConcurrentActiveChats} / \text{ConcurrentActiveChatsPercentage}) * 100$

For example, if **ConcurrentActiveChats** is 1000 and **ConcurrentActiveChatsPercentage** is 50, your quota is calculated as $(1000/50)*100 = 2000$. Your total quota is 2000 chats.

Use CloudWatch metrics to calculate concurrent task quota

Here's how to calculate your quota for concurrent tasks.

With tasks active in the system, look at **ConcurrentTasks** and **ConcurrentTasksPercentage**. Calculate the quota:

- $(\text{ConcurrentTasks} / \text{ConcurrentTasksPercentage}) * 100$

For example, if **ConcurrentTasks** is 20 and **ConcurrentTasksPercentage** is 50, your total quota is calculated as $(20/50)*100 = 40$. Your total quota is 40 tasks.

Logging Amazon Connect API calls with AWS CloudTrail

Amazon Connect is integrated with AWS CloudTrail, a service that provides a record of the Amazon Connect API calls that a user, role, or AWS service makes. CloudTrail captures Amazon Connect API calls as events. All public Amazon Connect APIs support CloudTrail.

Note

- When you use the Amazon Connect admin website to create or update quick connects, queues, or user management resources, CloudTrail logging records those events.

- When you create or update hours of operation, flow, phone number, user hierarchy, agent status, and prompt resources, CloudTrail only logs those events if you use the CLI or public APIs to make the changes.
- For access to the updated Amazon Connect admin website and CloudTrail support, you must use service-linked roles. For more information, see [Use service-linked roles for Amazon Connect](#).

Using the information that CloudTrail collects, you can identify a specific request to an Amazon Connect API, the IP address of the requester, the requester's identity, the date and time of the request, and so on. If you configure a trail, you can enable continuous delivery of CloudTrail events to an Amazon S3 bucket. If you don't configure a trail, you can view the most recent events in **Event History** in the CloudTrail console.

For more information about CloudTrail, including how to configure and enable it, see [Creating a Trail For Your AWS Account](#) and [AWS CloudTrail User Guide](#).

Amazon Connect information in CloudTrail

CloudTrail is enabled on your AWS account when you create the account. When supported event activity occurs in Amazon Connect, that activity is recorded in a CloudTrail event along with other AWS service events in **Event history**. You can view, search, and download recent events in your AWS account. For more information, see [Viewing Events with CloudTrail Event History](#).

For an ongoing record of events in your AWS account, including events for Amazon Connect, create a trail. A *trail* enables CloudTrail to deliver log files to an Amazon S3 bucket. By default, when you create a trail in the console, the trail applies to all AWS Regions. The trail logs events from all AWS Regions and delivers the log files to the Amazon S3 bucket that you specify. Additionally, you can configure other AWS services to further analyze and act upon the event data collected in CloudTrail logs. For more information, see the following:

- [Creating a trail for your AWS account](#)
- [CloudTrail supported services and integrations](#)
- [Configuring Amazon SNS notifications for CloudTrail](#)
- [Receiving CloudTrail log files from multiple Regions](#)
- [Receiving CloudTrail log files from multiple accounts](#)

Every event or log entry contains information about who generated the request. The identity information helps you determine the following:

- Whether the request was made with root or AWS Identity and Access Management (IAM) credentials.
- Whether the request was made with temporary security credentials for a role or federated user.
- Whether the request was made by another AWS service.

For more information, see the [CloudTrail userIdentity Element](#).

Example: Amazon Connect log file entries

A trail is a configuration that enables delivery of events as log files to an Amazon S3 bucket that you specify. CloudTrail log files contain one or more log entries. An event represents a single request from any source and includes information about the requested action, the date and time of the action, request parameters, and so on. CloudTrail log files aren't an ordered stack trace of the public API calls, so they don't appear in any specific order.

The following example shows a CloudTrail log entry that demonstrates the `GetContactAttributes` action.

```
{
  "eventVersion": "1.05",
  "userIdentity": {
    "type": "AssumedRole",
    "principalId": "AAAAAAA1111111EXAMPLE",
    "arn": "arn:aws:sts::123456789012:assumed-role/John",
    "accountId": "123456789012",
    "accessKeyId": "AAAAAAA1111111EXAMPLE",
    "sessionContext": {
      "attributes": {
        "mfaAuthenticated": "false",
        "creationDate": "2019-08-15T06:40:14Z"
      },
      "sessionIssuer": {
        "type": "Role",
        "principalId": "AAAAAAA1111111EXAMPLE",
        "arn": "arn:aws:iam::123456789012:role/John",
        "accountId": "123456789012",
        "userName": "John"
      }
    }
  }
}
```

```

    }
  },
  "eventTime": "2019-08-15T06:40:55Z",
  "eventSource": "connect.amazonaws.com",
  "eventName": "GetContactAttributes",
  "awsRegion": "us-west-2",
  "sourceIPAddress": "205.251.233.179",
  "userAgent": "aws-sdk-java/1.11.590 Mac_OS_X/10.14.6 Java_HotSpot(TM)_64-
Bit_Server_VM/25.202-b08 java/1.8.0_202 vendor/Oracle_Corporation",
  "requestParameters": {
    "InitialContactId": "00fbee1-123e-111e-93e3-11111bfbfcc1",
    "InstanceId": "00fbee1-123e-111e-93e3-11111bfbfcc1"
  },
  "responseElements": null,
  "requestID": "be1bee1d-1111-11e1-1eD1-0dc1111f1ac1c",
  "eventID": "00fbee1-123e-111e-93e3-11111bfbfcc1",
  "readOnly": true,
  "eventType": "AwsApiCall",
  "recipientAccountId": "123456789012"
}

```

Example: Amazon Connect Voice ID log file entries

Just like Amazon Connect, Voice ID is integrated with CloudTrail. When enabled, the service emits events for the Voice ID API calls made by a user, role, or an AWS service. You can reuse the same CloudTrail resources created for Amazon Connect, including the trail and the S3 bucket, to receive CloudTrail logs for Voice ID as well.

For security reasons, the sensitive fields which might contain PII information in the API requests and responses are redacted in the events.

The following example shows a CloudTrail log entry that demonstrates the `CreateDomain` action.

```

{
  "eventVersion": "1.08",
  "userIdentity": {
    "type": "AssumedRole",
    "principalId": "AR0A5STZEFPSWCM4YHJB2:SampleUser",
    "arn": "arn:aws:sts::111122223333:assumed-role/SampleRole/SampleUser",

```

```

"accountId": "111122223333",
"accessKeyId": "AAAAAAA1111111EXAMPLE",
"sessionContext": {
  "sessionIssuer": {
    "type": "Role",
    "principalId": "EXAMPLEZEFPWC4YHJB2",
    "arn": "arn:aws:iam::111122223333:role/SampleRole",
    "accountId": "111122223333",
    "userName": "SampleRole"
  },
  "webIdFederationData": {},
  "attributes": {
    "mfaAuthenticated": "false",
    "creationDate": "2021-08-17T01:55:39Z"
  }
},
"eventTime": "2021-08-17T01:55:41Z",
"eventSource": "voiceid.amazonaws.com",
"eventName": "CreateDomain",
"awsRegion": "us-west-2",
"sourceIPAddress": "205.251.233.179",
"userAgent": "aws-sdk-java/1.11.590 Mac_OS_X/10.14.6 Java_HotSpot(TM)_64-
Bit_Server_VM/25.202-b08 java/1.8.0_202 vendor/Oracle_Corporation",
"requestParameters": {
  "description": "HIDDEN_DUE_TO_SECURITY_REASONS",
  "name": "HIDDEN_DUE_TO_SECURITY_REASONS",
  "serverSideEncryptionConfiguration": {
    "kmsKeyId": "alias/sample-customer-managed-key"
  }
},
"responseElements": {
  "domain": {
    "arn": "arn:aws:voiceid:us-west-2:111122223333:domain/Example0sAjzg9xoByUatN",
    "createdAt": "Aug 17, 2021, 1:55:40 AM",
    "description": "HIDDEN_DUE_TO_SECURITY_REASONS",
    "domainId": "UcUuCPF0sAjzg9xoByUatN",
    "domainStatus": "ACTIVE",
    "name": "HIDDEN_DUE_TO_SECURITY_REASONS",
    "serverSideEncryptionConfiguration": {
      "kmsKeyId": "arn:aws:kms:us-west-2:111122223333:key/1111111-7741-44b1-
a5fe-7c6208589bf3"
    },
    "updatedAt": "Aug 17, 2021, 1:55:40 AM"
  }
}

```

```
    }
  },
  "requestID": "11111111-b358-4637-906e-67437274fe4e",
  "eventID": "11111111-a4d1-445e-ab62-8626af3c458d",
  "readOnly": false,
  "eventType": "AwsApiCall",
  "managementEvent": true,
  "eventCategory": "Management",
  "recipientAccountId": "111122223333"
}
```

EventBridge events emitted by Amazon Connect

Amazon Connect emits a variety of events related to the contact center, including but not limited to the following types of events:

- [Contact events](#) - contact (voice calls, chat, and task) events.
- [Contact Lens events](#) - create rules that generate EventBridge events.
- [Voice ID events](#) - events for every transaction: enrollment, authentication, or detection of fraudsters in a watchlist. Events are sent to the EventBridge default event bus.

Analytics data lake

You can use Analytics data lake as a central location to query various types of data from Amazon Connect. This data includes contact records, Contact Lens conversational analytics, Contact Lens performance evaluations, and more. Data is refreshed after a record is created with a small delay for processing and should be available in less than an hour. You can use the Analytics data lake to create custom reports or run SQL queries.

For information about related API actions, see [Analytics data lake actions](#) in the *Amazon Connect API Reference*.

Contents

- [Access Analytics data lake](#)
- [Associate tables for Analytics data lake](#)
- [Manage access to Resource link tables](#)
- [Data Type Definitions](#)

- [Data retention](#)

Access Analytics data lake

To access Analytics data lake, you can use the AWS console, the AWS CLI or AWS CloudShell, which is a browser-based, pre-authenticated shell that you can launch directly from the AWS Management Console. For information about how to use the AWS CLI, see [AWS Command Line Interface](#). For more information about AWS CloudShell, see [AWS CloudShell](#).

Configure data to be shared

Option 1 - Using the AWS Console

1. Open the Amazon Connect console at <https://console.aws.amazon.com/connect/>.
2. On the instances page, choose the instance alias. The instance alias is also your instance name, which appears in your Amazon Connect URL. The following image shows the Amazon Connect virtual contact center instances page, with a box around the instance alias.

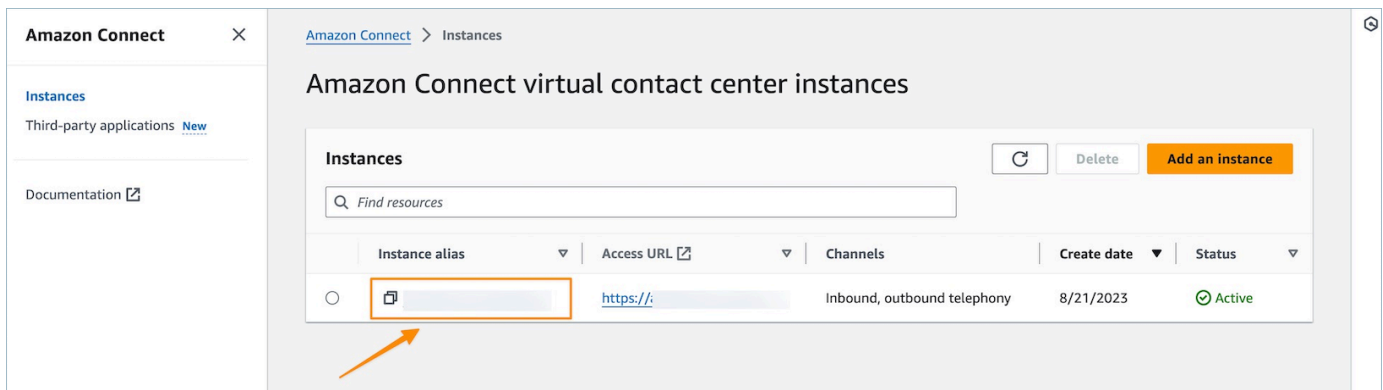

3. On the left navigation menu, choose **Analytics Tools** and then choose **Add data share**.

The screenshot shows the Amazon Connect console interface. On the left is a navigation sidebar with 'Analytics tools' highlighted. The main content area is titled 'Analytics tools' and includes a sub-header 'Monitor the performance of your contact center and track key performance indicators using the analytics tools.' Below this are two main sections: 'Contact Lens' (with an 'Edit' button) and 'Data lake'. The 'Data lake' section contains an information box about Zero-ETL analytics data lake and a table with columns for 'Target AWS account ID' and 'Data type'. An orange arrow points to the 'Add data share' button in the 'Data lake' section.

4. For the **Target AWS account ID** specify the AWS account ID of the account from which you wish to access data (consumer). This can be the same AWS account as hosts your Amazon Connect instance or a different AWS account. Select one or multiple data types you wish to access from the consumer account and select **Confirm**.

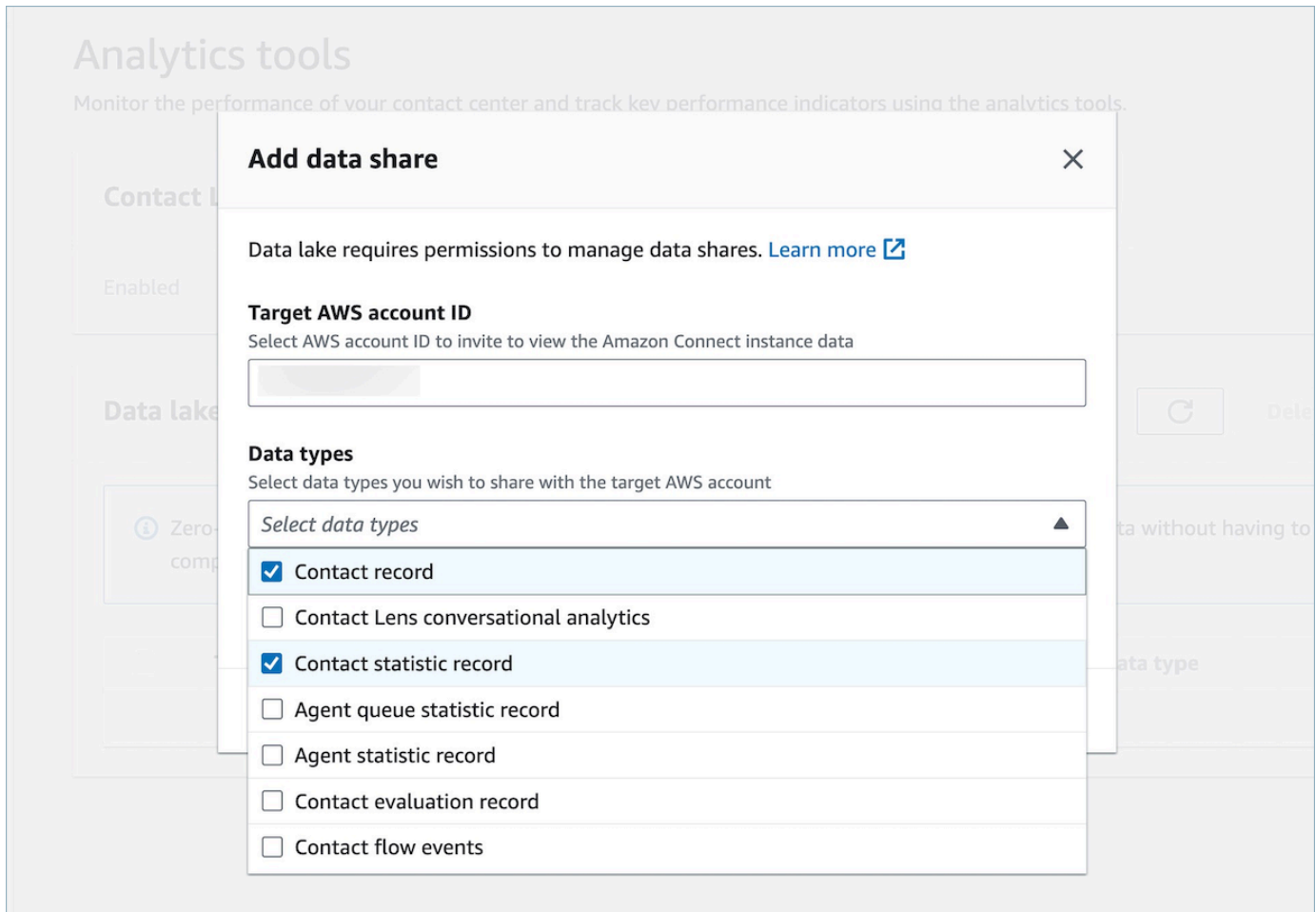

Option 2 - Using CLI or CloudShell

1. Generate the generate Association api request file by running the `aws connect batch-associate-analytics-data-set --generate-cli-skeleton input > input_batch_association.json` command.
2. Open the JSON file in a text editor and enter the following:
 - **Instance ID** – Your Amazon Connect instance ID.
 - **DataSetID** – Enter the required tables. For more information about required tables, see [Associate tables for Analytics data lake](#).
 - **TargetAccountId** – Account ID to share data.

Following is an example of the JSON file with all of the [tables](#).

```
{
```



```

"InstanceId": your_instance_id,
"DataSetIds": [
  "contact_record",
  "contact_flow_events",
  "contact_statistic_record",
  "contact_lens_conversational_analytics",
  "agent_queue_statistic_record",
  "agent_statistic_record",
  "contact_evaluation_record"
],
"TargetAccountId": your_account_ID
}

```

3. Associate analytics data lake to a single account by running the `aws connect batch-associate-analytics-data-set --cli-input-json file:///path/to/request/file` command (where this path is based on the location of the JSON file).

Associate tables for Analytics data lake

Configuration of data sharing creates a RAM invitation to the consumer account. [RAM](#) is a service to help you securely share resources across AWS accounts. Ensure that you have the required AWS Identity and Access Management (IAM) permissions to view and accept resource share invitations.

For information about the suggested IAM policies for data lake administrators, see [Data lake administrator permissions](#).

1. Open the RAM console at <https://console.aws.amazon.com/ram/>.
2. Under **Shared with me** select **Resource shares**

The screenshot shows the AWS Resource Access Manager console. On the left is a sidebar with 'Resource Access Manager' and navigation options: 'Shared by me' (Resource shares, Shared resources, Principals) and 'Shared with me' (Resource shares with 3 invitations, Shared resources, Principals). The main content area is titled 'Shared with me: Resource shares' and shows a list of resource shares. A search bar is present with the text 'Filter by text and property value'. The list contains three entries, all with a status of 'Pending'.

Name	ID	Owner	Status
LakeFormation-	2dc55854-	06	Pending
LakeFormation-	02bf19bf-	06	Pending
LakeFormation-	23917315-	06	Pending

3. Select the name of the resource share and **Accept resource share**

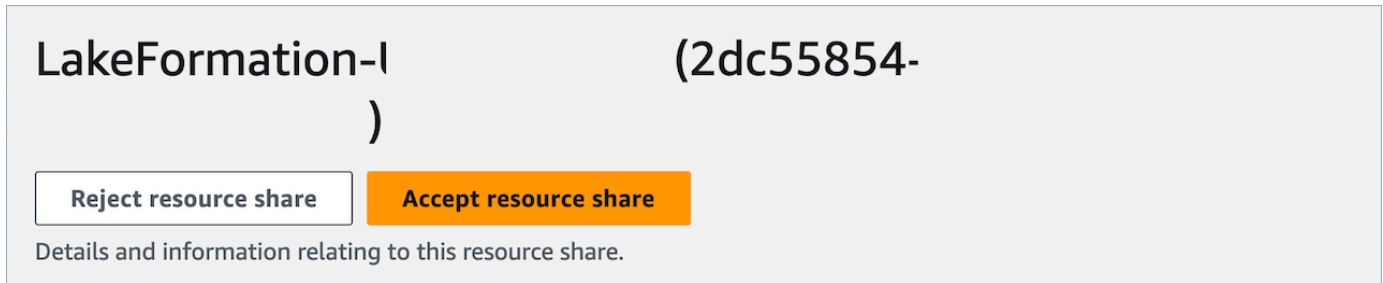

- Once the resource shares have been accepted, in the consumer account navigate to the AWS Lake Formation console at <https://console.aws.amazon.com/lakeformation>. To configure access to Amazon Connect analytics data lake tables, be certain the user configuring the following resources has Data lake administrator permissions in Lake Formation. For more information, see the - [Lake Formation personas and IAM permissions reference](#).
- Either use an existing lake formation database or create a new database for the Amazon Connect analytics data lake tables. For more information, see [Creating a database](#).
- In the AWS Lake Formation console, choose **Tables** on the left navigation menu.

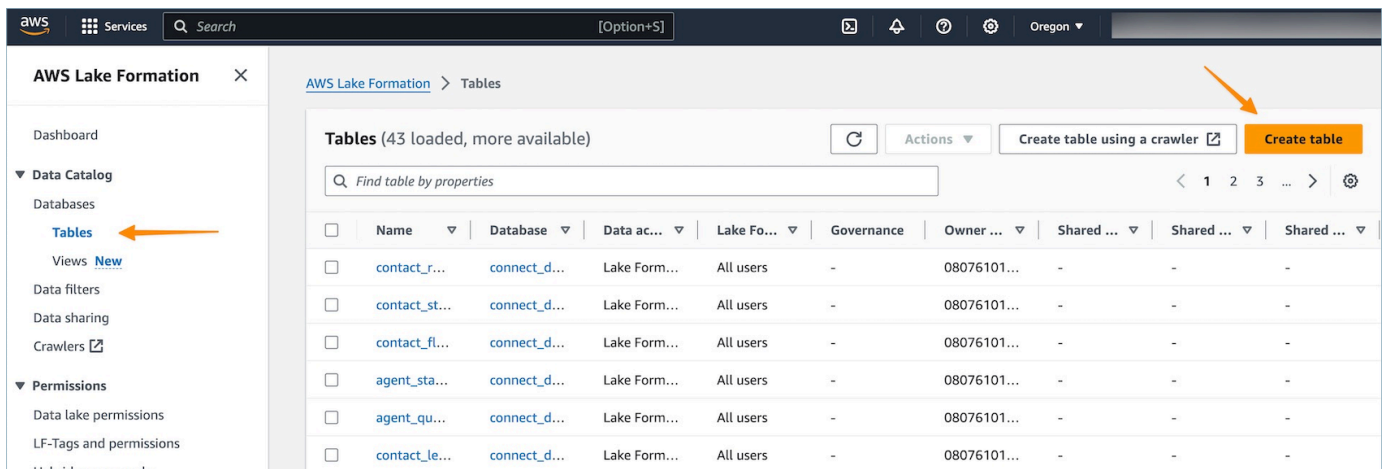

7. Select **Create table** from the upper right to [create a new Resource link](#).

[AWS Lake Formation](#) > [Tables](#) > Create table

Create table [Info](#)

Table details
Create a table in the Data Catalog.

Table
Create a table in my account.

Resource link
Create a resource link to a shared table.

Resource link name

connect_data

If you plan to access the table from Amazon Athena, then the name should be under 256 characters and contain only lowercase letters (a-z), numbers (0-9), and underscore (_). For more information, see [Athena names](#).

Database
Resource link will be contained in this database.

connect_datalake

Shared table's region
Select the region of the shared table.

US West (Oregon)

Shared table
Enter or choose a shared table.

Enter or choose a shared table.

- In the create table dialog, select the **Resource link** radio button. **Resource link name** can be any value you wish to name the linked table. For example, for the **contact record** data type you may want to define the link name as `contact_record`.
- Specify the **Database** previously created from step 5.
- In the **Shared table** choose the shared table whose RAM invite was previously accepted and you wish to map to this Resource link name. For example, select the `contact_record` shared table to map to the contact record resource link.
- Information for the Shared table's database and owner ID will automatically be populated.
- Choose **Create**.
- Repeat for all data types shared to the consumer account.

14. Open the Amazon Athena [console](#), and run a query to check if the data with the shared instance_id is provided in the request file. For example:

```
select * from database_name.linked_table limit 10.
```

Where:

- *database_name* is the name of the database that you created in step 5.
- *linked_table* is one of the resource link names you created in step 8.

Manage access to Resource link tables

In a cross-account access scenario in Lake Formation, in order to grant Select permission to a user, the user has to have Describe permission on the resource link since resource links are required for integrated AWS services like Amazon Athena and Amazon Redshift, and Select permission on the shared table to have read access to the underlying resource link data. Therefore, it is a two-step grant process.

In order to grant resource link access to a QuickSight user, complete the following steps:

1. Log into the consumer account as the data lake administrator and go to the Lake Formation Console.
2. On the left navigation pane, go to Tables and select the resource link of the shared table created in the previous section.
3. Choose **Actions** and select **Grant**.

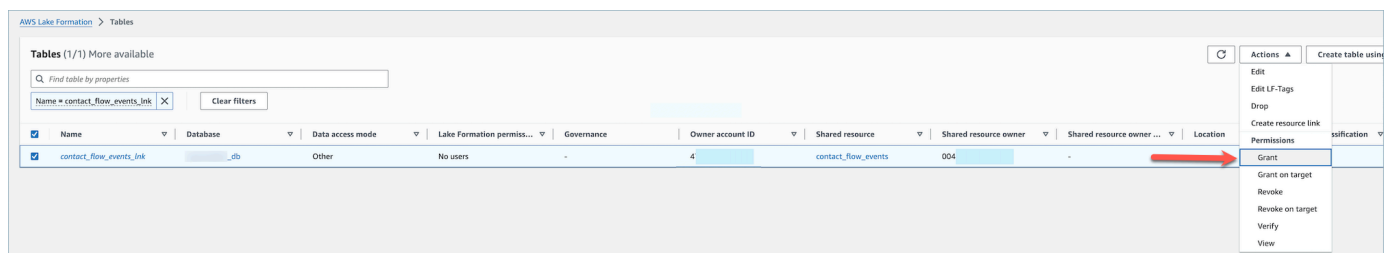

4. In the grant data permissions menu, in the Principals section, choose SAML users and groups and enter the ARN of the QuickSight user.
5. In the Table permissions section choose Describe as a table permission.
6. Choose **Grant**.

AWS Lake Formation > Grant permissions

Grant data lake permissions

Principals

Choose the principals to grant permissions.

- IAM users and roles
Users or roles from this AWS account.
- IAM Identity Center - new
Users and groups configured in IAM Identity Center.
- SAML users and groups
SAML users and group or QuickSight ARNs.
- External accounts
AWS account, AWS organization or IAM principal outside of this account

SAML and Amazon QuickSight users and groups
Enter a SAML user or group ARN or Amazon QuickSight ARN. Press Enter to add additional ARNs.

arn:aws:quicksight:us-east-1:

LF-Tags or catalog resources

Choose a method to grant permissions.

- Resources matched by LF-Tags (recommended)
Manage permissions indirectly for resources or data matched by a specific set of LF-Tags.
- Named Data Catalog resources
Manage permissions for specific databases or tables, in addition to fine-grained data access.

Databases
Select one or more databases.

Choose databases

spacanalitic_db

Tables - optional
Select one or more tables.

Choose tables

contact_flow_events_lnk
004095788891.contact_flow_events.connect_datalake

Views - optional
Select one or more views.

Choose views

Data filters - optional
Select one or more data filters.

Choose data filters

[Manage data filters](#)

Resource link permissions

Resource link permissions
Choose specific access permissions to grant.

Describe Drop

Grantable permissions
Choose the permission that may be granted to others.

Describe Drop

Now, the QuickSight user can see that the table exists within Quicksight's dataset console.

However, if the QuickSight user tries to preview or visualize the data at this stage, an exception will be raised since the user does not have access to the underlying data.

Now, we will grant the user read access to the data in the resource link's target, which is the table shared by Amazon Connect. To do that, complete the following steps:

1. Log into the consumer account as the data lake administrator and go to the Lake Formation Console.
2. On the left navigation pane, go to **Tables** and select the resource link of the shared table created in the previous section.
3. Choose **Actions** and select **Grant on Target**.

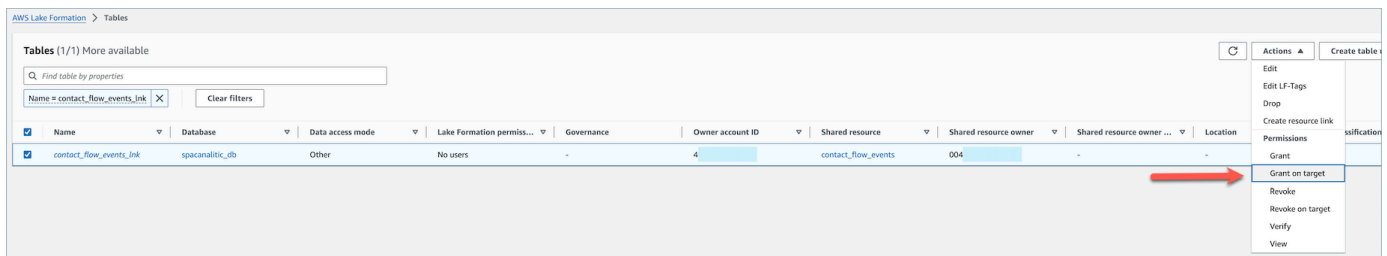

4. In the grant data permissions menu, in the **Principals** section, choose SAML users and groups and enter the ARN of the QuickSight user.
5. In the Table permissions section choose Select as a table permission.
6. Choose **Grant**.

AWS Lake Formation > Grant permissions

Grant data lake permissions

Principals
Choose the principals to grant permissions.

- IAM users and roles
Users or roles from this AWS account.
- IAM Identity Center - new
Users and groups configured in IAM Identity Center.
- SAML users and groups
SAML users and group or QuickSight ARNs.
- External accounts
AWS account, AWS organization or IAM principal outside of this account.

SAML and Amazon QuickSight users and groups
Enter a SAML user or group ARN or Amazon QuickSight ARN. Press Enter to add additional ARNs.
arn:aws:quicksight:us-east-1:

LF-Tags or catalog resources
Choose a method to grant permissions.

- Resources matched by LF-Tags (recommended)
Manage permissions indirectly for resources or data matched by a specific set of LF-Tags.
- Named Data Catalog resources
Manage permissions for specific databases or tables, in addition to fine-grained data access.

Databases
Select one or more databases.
Choose databases [v] Load more
connect_datalake X

Tables - optional
Select one or more tables.
Choose tables [v]
contact_flow_events X

Views - optional
Select one or more views.
Choose views [v]

Data filters - optional
Select one or more data filters.
Choose data filters [v] Load more Create new
Manage data filters [link]

Table permissions

Table permissions
Choose specific access permissions to grant.

- Select
- Insert
- Delete
- Describe
- Alter
- Drop
- Super
This permission is the union of all the individual permissions to the left, and supersedes them.

Grantable permissions
Choose the permission that may be granted to others.

- Select
- Insert
- Delete
- Describe
- Alter
- Drop
- Super
This permission allows the principal to grant any of the permissions to the left, and supersedes those grantable permissions.

Data permissions

- All data access
Grant access to all data without any restrictions.
- Column-based access
Grant data access to specific columns only.

Cancel Grant

Data Type Definitions

Contacts Record

Column	Type	Description
instance_id	string	The ID of the AWS Connect instance.
aws_account_id	string	The ID of the AWS account that owns the contact.
contact_id	string	The ID of the contact in the contact record
initial_contact_id	string	The unique identifier for the contact associated with the first interaction between the customer

Column	Type	Description
		and your contact center. Use the initial contact ID to track contacts between flows
previous_contact_id	string	The unique identifier for the contact before it was transferred. Use the previous contact ID to trace contacts between flows.

Column	Type	Description
related_contact_id	string	Each time a contact is connected to an agent, a new contact record is created. The contact records for a contact are linked together through the contactId fields: related

Column	Type	Description
next_contact_id	string	Each time a contact is connected to an agent, a new contact record is created. The contact records for a contact are linked together through the contactId fields: initial, next, previous

Column	Type	Description
channel	string	The method used to contact your contact center: VOICE, CHAT, TASK.
initiation_method	string	How the contact was initiated . Valid values include: INBOUND, OUTBOUND, TRANSFER, CALLBACK, QUEUE_TRANSFER, EXTERNAL_OUTBOUND, MONITOR, DISCONNECT, and API
initiation_timestamp	timestamp	contact initiation timestamp

Column	Type	Description
connected_to_system_timestamp	timestamp	The timestamp marking the time the contact connected to the system
last_update_timestamp	timestamp	Timestamp which shows the last time the data last touched a record in the data lake.

Column	Type	Description
scheduled_timestamp	timestamp	The date and time when this contact was scheduled to trigger the flow to run, in UTC time. This is supported only for the task channel.
transfer_completed_timestamp	timestamp	The timestamp for the completion of the transfer
disconnect_timestamp	timestamp	contact disconnect timestamp
disconnect_reason	string	The reason for disconnect of the call

Column	Type	Description
queue_duration_ms	bigint	The duration that a contact spent waiting in the queue in milliseconds.
queue_dequeue_timestamp	timestamp	The timestamp of contacts transferred out of the queue from another queue during a Customer queue flow .

Column	Type	Description
queue_enqueue_timestamp	timestamp	The timestamp of contacts transferred into the queue from another queue during a Customer queue flow .
queue_name	string	The name of the queue
queue_arn	string	ARN of the queue
queue_id	string	ID of the queue
agent_connection_attempts	bigint	The number of contacts where a callback was attempted

Column	Type	Description
agent_connected_to_agent_timestamp	timestamp	The timestamp for the connection between agents
agent_interaction_duration_ms	bigint	Total time that agents spent interacting with customers in milliseconds
agent_customer_hold_duration_ms	bigint	Total time that agents and contact were on hold in milliseconds
agent_number_of_holds	bigint	The count of contacts that were placed on hold by the agent

Column	Type	Description
agent_longest_hold_duration_ms	bigint	The longest time, in whole seconds, that the customer was put on hold by the agent.
agent_after_contact_work_start_timestamp	timestamp	The timestamp marking the start of the AfterContactWork state
agent_after_contact_work_end_timestamp	timestamp	The timestamp marking the end of the AfterContactWork state

Column	Type	Description
agent_after_contact_work_duration_ms	bigint	The total time that an agent spent doing ACW for a contact in milliseconds. In some businesses, also known as Call Wrap Up time.
attributes	map(string,string)	A contact attribute represents this data as a key-value pair. You might think of it as a field name together with the data entered into that field.

Column	Type	Description
agent_username	string	The user name of the agent, as entered in their Amazon Connect user account.
agent_arn	string	The ARN of the agent, as created in their Amazon Connect user account.
agent_id	string	The ID of the agent, as created in their Amazon Connect user account.
instance_arn	string	The ARN of the AWS Connect instance.

Column	Type	Description
agent_hierarchy_groups_level_1_name	string	The hierarchy name the agent is assigned to, for first level
agent_hierarchy_groups_level_1_arn	string	The hierarchy ARN the agent is assigned to, for first level
agent_hierarchy_groups_level_1_id	string	The hierarchy ID the agent is assigned to, for first level
agent_hierarchy_groups_level_2_name	string	The hierarchy name the agent is assigned to, for second level

Column	Type	Description
agent_hierarchy_groups_level_2_arn	string	The hierarchy ARN the agent is assigned to, for second level
agent_hierarchy_groups_level_2_id	string	The hierarchy ID the agent is assigned to, for second level
agent_hierarchy_groups_level_3_name	string	The hierarchy name the agent is assigned to, for third level
agent_hierarchy_groups_level_3_arn	string	The hierarchy ARN the agent is assigned to, for third level

Column	Type	Description
agent_hierarchy_groups_level_3_id	string	The hierarchy ID the agent is assigned to, for third level
agent_hierarchy_groups_level_4_name	string	The hierarchy name the agent is assigned to, for fourth level
agent_hierarchy_groups_level_4_arn	string	The hierarchy ARN the agent is assigned to, for fourth level
agent_hierarchy_groups_level_4_id	string	The hierarchy ID the agent is assigned to, for fourth level

Column	Type	Description
agent_hierarchy_groups_level_5_name	string	The hierarchy name the agent is assigned to, for fifth level
agent_hierarchy_groups_level_5_arn	string	The hierarchy ARN the agent is assigned to, for fifth level
agent_hierarchy_groups_level_5_id	string	The hierarchy ID the agent is assigned to, for fifth level
agent_routing_profile_name	string	The name of routing profile for the agent.
agent_routing_profile_arn	string	The ARN of routing profile for the agent.

Column	Type	Description
agent_routing_profile_id	string	The ID of the routing profile for the agent.
aws_contact_trace_record_format_version	string	The record format version.
campaign_id	string	The ID associated with an outbound campaign to assist with tracking campaigns
customer_endpoint_type	string	The type of the customer endpoint. Valid value is TELEPHONE_NUMBER.

Column	Type	Description
customer_endpoint_address	string	The customer or external third party participant endpoint address.
transferred_endpoint_type	string	The customer or external third party participant transferred endpoint type
transferred_endpoint_address	string	The customer or external third party participant transferred endpoint address.

Column	Type	Description
system_endpoint_type	string	The type of the system endpoint. Valid value is TELEPHONE_NUMBER.
system_endpoint_address	string	The system endpoint type address
recording_deletion_reason	string	If the recording was deleted, this is the reason entered for the deletion.
recording_location	string	The location, in Amazon S3, for the recording.

Column	Type	Description
recording_status	string	The recording status. Valid values: AVAILABLE DELETED NULL
recording_type	string	The recording type. Valid values: AUDIO
answering_machine_detection_Status	string	The status of whether an answering machine was detected
voice_id_result_authentication_result	string	The voice authentication information for the call.

Column	Type	Description
voice_id_result_fraud_detection_watch_list_id	string	The fraud detection information for the call for watch list
voice_id_result_speaker_id	string	The fraud detection result produced by Voice ID, processed against the current session state and streamed audio of the speaker.
voice_id_result_fraud_detection_result	string	The fraud detection result information for the call.

Column	Type	Description
voice_id_result_fraud_detection_fraudster_Id	string	The fraud detection information for the call detecting a fraudster.
external_third_party_interaction_duration_ms	bigint	The interaction duration for external third party in milliseconds.
voice_id_result_authentication_minimum_speech_ms	bigint	The minimum authentication score required for a user to be authenticated. Values MIN 0 and MAX 100.

Column	Type	Description
voice_id_result_authentication_score	bigint	The minimum authentication score required for a user to be authenticated. Values MIN 0 and MAX 100
voice_id_result_authentication_score_threshold	bigint	The minimum authentication score required for a user to be authenticated. Values MIN 0 and MAX 100

Column	Type	Description
voice_id_result_fraud_detection_risk_score_known_fraudster	bigint	The detection of fraudsters in a watchlist score for Known Fraudster category.
voice_id_result_fraud_detection_risk_score_synthetic_speech	bigint	This score is presented as a combined risk score for Voice Spoofing.
voice_id_result_fraud_detection_risk_score_voice_spoofing	bigint	The fraud risk score based on Voice Spoofing, such as playback of audio from Text-to-Speech systems recorded audio.

Column	Type	Description
voice_id_result_fraud_detection_score_threshold	bigint	The threshold for detection of fraudsters in a watchlist that was set in the flow for the contact.
agent_pause_duration_ms	bigint	Agent pause duration for a contact in seconds.
voice_id_result_speaker_enrolled	boolean	Enrolled: The caller is enrolled in voice authentication.

Column	Type	Description
voice_id_result_speaker_opted_out	boolean	Opted out: The caller has opted out of voice authentication.
media_streams_items	array(struct(type:string))	Information about the media stream used during the contact. Valid values: AUDIO, VIDEO, CHAT
voice_id_result_fraud_detection_reasons_items	array(string)	Contains fraud types: Known Fraudster and Voice Spoofing.
tags_references_items	map(string,string)	Adds the specified tags to the specified resource.

Column	Type	Description
contact_details	map(string,string)	The details for the contact between agent and caller
contact_evaluations	map(string,struct(form_id:string,evaluation_array:string,status:string, start_timestamp:timestamp,end_timestamp:timestamp,delete_timestamp:timestamp, export_location:string))	The list with the fields and data in the evaluation form.
references	array(struct(name:string,type:string,value:string))	Contains links to other documents that are related to a contact. Type: URL ATTACHMENT NUMBER STRING DATE EMAIL

Column	Type	Description
agent_state_transitions	array(struct(state_start_timestamp:timestamp, state_end_timestamp:timestamp, state:string))	Information about the state transitions of the agent
recordings	array(struct(storage_type:string,location:string,media_stream_type:string, participant_type:string,fragment_start_number:string,fragment_start_number:string, start_timestamp:timestamp,stop_timestamp:timestamp,status:string, deletion_reason:string))	Information about a voice recording, chat transcript, or screen recording

Column	Type	Description
data_lake_last_processed_timestamp	timestamp	Timestamp which shows the last time the data late touched a record in the data lake. This can be include transformation and backfill. This field cannot be used to reliably determine data freshness

Contact Lens Conversational Analytics

Column	Type	Description
aws_account_id	string	The ID of the AWS account that owns the contact.
version	string	Indicates real-time or post call/chat analysis
instance_id	string	The ID of the AWS Connect instance.

Column	Type	Description
instance_arn	string	The ARN of the AWS Connect instance.
contact_id	string	The ID of the contact being evaluated
channel	string	The method used to contact your contact center: VOICE, CHAT, TASK.
language_locale	string	Language used to analyze contact - https://docs.aws.amazon.com/connect/latest/adminguide/supported-languages.html#supported-languages-contact-lens
feature	string	Will always have the same value "contact_lens_conversational_analytics"
categories	array(string)	Array of categories assigned to the contact
disconnect_timestamp	timestamp	contact disconnect timestamp
greeting_time_agent_ms	bigint	First response time of agents on chat, indicating how quickly they engage with customers after joining the chat
non_talk_time_total_ms	bigint	Total non-talk time in a voice conversation. Non-talk time refers to the combined duration of hold time and periods of silence exceeding 3 seconds, during which neither the agent nor the customer is engaged in conversation
talk_time_total_ms	bigint	Time that was spent talking during a voice contact across either the customer or the agent.
talk_time_agent_ms	bigint	Time that was spent talking during a voice contact by the agent.

Column	Type	Description
talk_time_customer_ms	bigint	Time that was spent talking during a voice contact by the customer.
total_conversation_duration_ms	bigint	The total time from the start of the conversation until the last word spoken by either the agent or the customer.
talk_speed_agent_wpm	float	Words per minute spoken by the agent
talk_speed_customer_wpm	float	Words per minute spoken by the customer
interruptions_time_total_ms	bigint	Amount of time agent or customer were speaking at the same time
interruptions_time_agent_ms	bigint	Amount of time the agent spoke while the customer was already speaking
interruptions_time_customer_ms	bigint	Amount of time the customer spoke while the agent was already speaking
interruptions_total_count	bigint	Count of times interruptions were detected during a conversation
interruptions_agent_count	bigint	Count of time an agent interruption was detected during a conversation
interruptions_customer_count	bigint	Count of times a customer interruption was detected during a conversation
sentiment_overall_score_agent	float	A sentiment score is an analysis of text, and a rating of whether it includes mostly positive, negative, or neutral language. This is overall sentiment score for the agent during the call. The overall sentiment score is the average of the scores assigned during each portion of the call.

Column	Type	Description
sentiment_overall_score_customer	float	A sentiment score is an analysis of text, and a rating of whether it includes mostly positive, negative, or neutral language. This is overall sentiment score for customer during the call. The overall sentiment score is the average of the scores assigned during each portion of the call.
sentiment_interaction_score_customer_with_agent	float	A sentiment score is an analysis of text, and a rating of whether it includes mostly positive, negative, or neutral language. This is sentiment score of agent without customer.
sentiment_interaction_score_customer_without_agent	float	A sentiment score is an analysis of text, and a rating of whether it includes mostly positive, negative, or neutral language. This is sentiment score of customer without the agent.
sentiment_end_score_agent	float	A sentiment score is an analysis of text, and a rating of whether it includes mostly positive, negative, or neutral language. This is sentiment score for agent at the end of the call.
sentiment_end_score_customer	float	A sentiment score is an analysis of text, and a rating of whether it includes mostly positive, negative, or neutral language. This is sentiment score for customer at the end of the call.
response_time_average_agent_ms	bigint	For Chat, average time to send a response after the customers last message
response_time_average_customer_ms	bigint	For Chat, average time to send a response after the agents last message

Column	Type	Description
response_time_maximum_agent_ms	bigint	For Chat, maximum time to send a response after the customers last message
response_time_maximum_customer_ms	bigint	For Chat, maximum time to send a response after the customers last message
data_lake_last_processed_timestamp	timestamp	Timestamp which shows the last time the data lake touched a record in the data lake. This can be include transformation and backfill. This field cannot be used to reliably determine data freshness

Contact Statistic Record

Column	Type	Description
instance_id	string	The ID of the AWS Connect instance.
aws_account_id	string	The ID of the AWS account that owns the contact.
contact_id	string	The ID of the contact
channel	string	The method used to contact your contact center: VOICE, CHAT, TASK.
queue_id	string	ID of the queue
agent_id	string	ID of the agent
initiation_method	string	Values for INITIATION_METHOD: INBOUND OUTBOUND TRANSFER

Column	Type	Description
		QUEUE_TRANSFER CALLBACK API
disconnect_timestamp	timestamp	contact disconnect timestamp
enqueue_timestamp	timestamp	The timestamp of contacts transferred into the queue from another queue during a Customer queue flow .
contact_flow_time_ms	bigint	The time a contact spent in a contact flow.
abandon_time_ms	bigint	The time that contacts waited in the queue before being abandoned.
queue_time_ms	bigint	The time that a contact spent waiting in the queue.
queue_answer_time_ms	bigint	The time that contacts waited in the queue before being answered by an agent.
handle_time_ms	bigint	The time that an agent spent on contacts. Agent interaction + Customer Hold + ACW
customer_hold_time_ms	bigint	The time that customers spent on hold after being connected to an agent.
agent_interaction_time_ms	bigint	The time that customer spent to interact with agent.

Column	Type	Description
agent_interaction_outbound_time_ms	bigint	The time that agents spent interacting with a customer during an outbound contact.
agent_interaction_and_hold_time_ms	bigint	The time that customer spent to interact with agent and put on hold.
after_contact_work_time_ms	bigint	The time that an agent spent doing ACW for a contact.
after_contact_work_outbound_time_ms	bigint	The time that agents spent doing After Contact Work (ACW) for an outbound contact.
is_connected	bigint	A flag indicating whether a contact is connected to customer.
is_abandoned	bigint	A flag indicating whether a contact is abandoned. (Determined by not having been handled by an agent, not being transferred by a flow and not having a next contact.)
is_agent_hung_up_first	bigint	A flag indicating whether a contact is disconnected where the agent disconnected before the customer.
is_handled	bigint	A flag indicating whether call was handled

Column	Type	Description
is_handled_incoming	bigint	A flag indicating whether a contact is an incoming contact that was handled by an agent, including inbound contacts and transferred contacts.
is_handled_outbound	bigint	A flag indicating whether a contact is an outbound contact that was handled by an agent.
is_callback_handled	bigint	A flag indicating whether a contact is a callback and handled by an agent.
is_api_handled	bigint	A flag indicating whether a contact is initiated using an Amazon Connect API operation and handled by an agent.
is_put_on_hold	bigint	A flag indicating whether a contact is put on hold.
is_hold_disconnect	bigint	A flag indicating whether a contact is disconnected while the customer was on hold.
is_hold_agent_disconnect	bigint	A flag indicating whether a contact is disconnected by the agent while the customer was on hold.

Column	Type	Description
is_hold_customer_disconnect	bigint	A flag indicating whether a contact is disconnected by the customer while the customer was on hold.
is_incoming	bigint	A flag indicating whether a contact is an incoming contacts, including inbound contacts and transferred contacts.
is_callback_contact	bigint	A flag indicate whether a contact is callback.
is_api_contact	bigint	A flag indicate whether a contact is initiated using an Amazon Connect API operation.
is_queued	bigint	A flag indicate whether a contact is put in queue.
is_queued_and_handled	bigint	A flag indicate whether a contact is put in queue and handled by agent.
is_transferred_in	bigint	A flag indicate whether a contact is transferred in.
is_transferred_in_from_handled	bigint	A flag indicate whether a contact is transferred in from a contact handled by agent.

Column	Type	Description
is_transferred_in_from_queued	bigint	A flag indicate whether a contact is transferred to the queue from another in a Transfer to queue contact flow.
is_transferred_out	bigint	A flag indicate whether a contact is transferred out.
is_transferred_out_from_handled	bigint	A flag indicate whether a contact is transferred in from a contact handled by agent.
is_transferred_out_from_queued	bigint	A flag indicate whether a contact is transferred from the queue to another queue in a Transfer to queue contact flow.
is_transferred_out_internal	bigint	A flag indicate whether a contact is transferred to an internal source.
is_transferred_out_external	bigint	A flag indicate whether a contact is transferred from the queue to an external source.
is_transferred_out_external_from_contact_flow	bigint	A flag indicate whether a contact is transferred to an external destination by contact flow.

Column	Type	Description
data_lake_last_processed_timestamp	timestamp	Timestamp which shows the last time the data late touched a record in the data lake. This can be include transformation and backfill. This field cannot be used to reliably determine data freshness

Agent Queue Statistic Record

Column	Type	Description
aqsr_statistic_id	string	Unique name for the AQSR record
instance_id	string	The identifier of the Amazon Connect instance. You can find the instance ID in the Amazon Resource Name (ARN) of the instance.
user_id	string	<u>The identifier of the user account.</u>
routing_profile_id	string	ID of routing profile
agent_hierarchy_level_1_id	string	ID of level 1 Hierarchy Group
agent_hierarchy_level_2_id	string	ID of level 2 Hierarchy Group
agent_hierarchy_level_3_id	string	ID of level 3 Hierarchy Group
agent_hierarchy_level_4_id	string	ID of level 4 Hierarchy Group
agent_hierarchy_level_5_id	string	ID of level 5 Hierarchy Group
interval_start_time	timestamp	Timestamp of the conversation when interval started.
interval_end_time	timestamp	Timestamp of the conversation when interval ended.

Column	Type	Description
published_date	timestamp	
aws_account_id	string	The ID of the AWS account that owns the contact.
queue_id	string	<u>The identifier of the queue.</u>
channel	string	The method used to contact your contact center: VOICE, CHAT, TASK.
queue_type	string	<u>QueueType specifies the classification of the queue, indicating its intended use and behavior. Valid values for QueueType are STANDARD, which is a general-purpose queue where contacts wait before they are routed to and accepted by agents, and AGENT, which are created automatically for every agent user you add Amazon Connect.</u>
agent_non_response	bigint	<u>The count of contacts routed to an agent but not answered by that agent, including contacts abandoned by the customer.</u>
contacts_offered	bigint	
contacts_handled	bigint	The count of contacts that were connected to an agent. It doesn't matter how the contact got to the agent. It could be a customer calling your contact center, or an agent calling the customer. It could be a contact transferred from one agent to another. It could be a contact where the agent answered it, but then they weren't sure what to do and they transferred the contact away again. As long as the agent was connected to the contact, it increments Contacts handled .

Column	Type	Description
handle_time	bigint	The average time, from start to finish, that a contact was connected with an agent (average handled time). It includes talk time, hold time, After Contact Work (ACW) time, custom status time, and agent pause duration (which applies only to tasks). AHT is calculated by averaging the amount of time between the contact being answered by an agent and the conversation ending. It applies to both inbound and outbound calls.
agent_incoming_connecting_time	bigint	The total time between when a contact is initiated by Amazon Connect reserving the agent for the contact, and the agent is connected.
agent_outbound_connecting_time	bigint	Total time between when an outbound contact is initiated by Amazon Connect reserving the agent for the contact, and the agent is connected.
agent_callback_connecting_time	bigint	The total time between when a callback contact is initiated by Amazon Connect reserving the agent for the contact, and the agent is connected.
agent_api_connecting_time	bigint	The total time between when a contact is initiated using an Amazon Connect API, and the agent is connected.
incoming_connecting_attempts	bigint	The number of attempts initiated by Amazon Connect reserving the agent for the contact for INBOUND initiation type contacts
outbound_connecting_attempts	bigint	The number of attempts initiated by Amazon Connect reserving the agent for the contact for outbound initiation type contacts
callback_connecting_attempts	bigint	The number of contacts where a callback was attempted, but the customer did not pick up.

Column	Type	Description
api_connecting_attempts	bigint	Used for calculating - Average agent incoming connecting time
data_lake_last_processed_timestamp	timestamp	Timestamp which shows the last time the data lake touched a record in the data lake. This can be include transformation and backfill. This field cannot be used to reliably determine data freshness

Agent Statistic Record

Column	Type	Description
asr_statistic_id	string	
instance_id	string	The identifier of the Amazon Connect instance. You can find the instance ID in the Amazon Resource Name (ARN) of the instance.
user_id	string	<u>The identifier of the user account.</u>
routing_profile_id	string	ID of routing profile
agent_hierarchy_level_1_id	string	ID of level 1 Hierarchy Group
agent_hierarchy_level_2_id	string	ID of level 2 Hierarchy Group
agent_hierarchy_level_3_id	string	ID of level 3 Hierarchy Group
agent_hierarchy_level_4_id	string	ID of level 4 Hierarchy Group
agent_hierarchy_level_5_id	string	ID of level 5 Hierarchy Group
interval_start_time	timestamp	Timestamp of the conversation when interval started.

Column	Type	Description
interval_end_time	timestamp	Timestamp of the conversation when interval ended.
published_date	timestamp	
aws_account_id	string	The ID of the AWS account that owns the contact.
online_time	bigint	Total time that an agent spent with their CCP set to a status other than Offline . This includes any time spent in a custom status. When you create a historical metrics reports, this metric can't be grouped or filtered by queue, phone number, or channels.
error_time	bigint	For a specific agent, the total time contacts were in an error status. This metric can't be grouped or filtered by queue.
non_productive_time	bigint	Total time that agents spent in a custom status . That is, their CCP status is other than Available or Offline . This metric doesn't mean that the agent was spending their time unproductively.
agent_idle_time	bigint	After the agent sets their status in the CCP to Available , this is the amount of time they weren't handling contacts + any time their contacts were in an Error state. Agent idle time doesn't include the amount of time from when Amazon Connect starts routing the contact to the agent, to when agent picks up or declines the contact.

Column	Type	Description
agent_on_contact_time	bigint	Total time that an agent spent on one or multiple contacts, including Customer hold time and After contact work time . This does not include time spent on a contact while in a custom status or Offline status. (Custom status = the agent's CCP status is other than Available or Offline . For example, Training would be a custom status).
custom_state_time_01	bigint	Represents custom agent states defined by a customer. Ex: Coffee_break.
custom_state_time_02	bigint	Represents custom agent states defined by a customer. Ex: Coffee_break.
custom_state_time_03	bigint	Represents custom agent states defined by a customer. Ex: Coffee_break.
custom_state_time_04	bigint	Represents custom agent states defined by a customer. Ex: Coffee_break.
custom_state_time_05	bigint	Represents custom agent states defined by a customer. Ex: Coffee_break.
custom_state_time_06	bigint	Represents custom agent states defined by a customer. Ex: Coffee_break.
custom_state_time_07	bigint	Represents custom agent states defined by a customer. Ex: Coffee_break.
custom_state_time_08	bigint	Represents custom agent states defined by a customer. Ex: Coffee_break.
custom_state_time_09	bigint	Represents custom agent states defined by a customer. Ex: Coffee_break.

Column	Type	Description
custom_state_time_10	bigint	Represents custom agent states defined by a customer. Ex: Coffee_break.
custom_state_time_11	bigint	Represents custom agent states defined by a customer. Ex: Coffee_break.
custom_state_time_12	bigint	Represents custom agent states defined by a customer. Ex: Coffee_break.
custom_state_time_13	bigint	Represents custom agent states defined by a customer. Ex: Coffee_break.
custom_state_time_14	bigint	Represents custom agent states defined by a customer. Ex: Coffee_break.
custom_state_time_15	bigint	Represents custom agent states defined by a customer. Ex: Coffee_break.
custom_state_time_16	bigint	Represents custom agent states defined by a customer. Ex: Coffee_break.
custom_state_time_17	bigint	Represents custom agent states defined by a customer. Ex: Coffee_break.
custom_state_time_18	bigint	Represents custom agent states defined by a customer. Ex: Coffee_break.
custom_state_time_19	bigint	Represents custom agent states defined by a customer. Ex: Coffee_break.
custom_state_time_20	bigint	Represents custom agent states defined by a customer. Ex: Coffee_break.
custom_state_time_21	bigint	Represents custom agent states defined by a customer. Ex: Coffee_break.
custom_state_time_22	bigint	Represents custom agent states defined by a customer. Ex: Coffee_break.

Column	Type	Description
custom_state_time_23	bigint	Represents custom agent states defined by a customer. Ex: Coffee_break.
custom_state_time_24	bigint	Represents custom agent states defined by a customer. Ex: Coffee_break.
custom_state_time_25	bigint	Represents custom agent states defined by a customer. Ex: Coffee_break.
custom_state_time_26	bigint	Represents custom agent states defined by a customer. Ex: Coffee_break.
custom_state_time_27	bigint	Represents custom agent states defined by a customer. Ex: Coffee_break.
custom_state_time_28	bigint	Represents custom agent states defined by a customer. Ex: Coffee_break.
custom_state_time_29	bigint	Represents custom agent states defined by a customer. Ex: Coffee_break.
custom_state_time_30	bigint	Represents custom agent states defined by a customer. Ex: Coffee_break.
custom_state_time_31	bigint	Represents custom agent states defined by a customer. Ex: Coffee_break.
custom_state_time_32	bigint	Represents custom agent states defined by a customer. Ex: Coffee_break.
custom_state_time_33	bigint	Represents custom agent states defined by a customer. Ex: Coffee_break.
custom_state_time_34	bigint	Represents custom agent states defined by a customer. Ex: Coffee_break.
custom_state_time_35	bigint	Represents custom agent states defined by a customer. Ex: Coffee_break.

Column	Type	Description
custom_state_time_36	bigint	Represents custom agent states defined by a customer. Ex: Coffee_break.
custom_state_time_37	bigint	Represents custom agent states defined by a customer. Ex: Coffee_break.
custom_state_time_38	bigint	Represents custom agent states defined by a customer. Ex: Coffee_break.
custom_state_time_39	bigint	Represents custom agent states defined by a customer. Ex: Coffee_break.
custom_state_time_40	bigint	Represents custom agent states defined by a customer. Ex: Coffee_break.
custom_state_time_41	bigint	Represents custom agent states defined by a customer. Ex: Coffee_break.
custom_state_time_42	bigint	Represents custom agent states defined by a customer. Ex: Coffee_break.
custom_state_time_43	bigint	Represents custom agent states defined by a customer. Ex: Coffee_break.
custom_state_time_44	bigint	Represents custom agent states defined by a customer. Ex: Coffee_break.
custom_state_time_45	bigint	Represents custom agent states defined by a customer. Ex: Coffee_break.
custom_state_time_46	bigint	Represents custom agent states defined by a customer. Ex: Coffee_break.
custom_state_time_47	bigint	Represents custom agent states defined by a customer. Ex: Coffee_break.
custom_state_time_48	bigint	Represents custom agent states defined by a customer. Ex: Coffee_break.

Column	Type	Description
custom_state_time_49	bigint	Represents custom agent states defined by a customer. Ex: Coffee_break.
custom_state_time_50	bigint	Represents custom agent states defined by a customer. Ex: Coffee_break.
data_lake_last_processed_timestamp	timestamp	Timestamp which shows the last time the data late touched a record in the data lake. This can be include transformation and backfill. This field cannot be used to reliably determine data freshness

Contact Evaluation Record

Column	Type	Description
aws_account_id	string	The ID of the AWS account that owns the contact.
instance_id	string	The identifier of the Amazon Connect instance. You can find the instance ID in the Amazon Resource Name (ARN) of the instance.
evaluation_id	string	primary key, ID of the evaluation to disambiguate multiple evaluations done of the call with the same form (by different evaluators)
item_reference_id	string	primary key - may represent form/ section/ sub-section/ question depending on type
item_type	string	Defines "Form/Section/sub-section/q uestion or indicates a deleted record

Column	Type	Description
contact_id	string	The ID of the contact being evaluated
evaluation_submitted_timestamp	timestamp	Timestamp when contact was evaluated
score	double	Score out of 1 - 10 for questions; score out of 100% for sections/ forms
weighted_score	double	Score adding up to 100% of form, e.g. 2 sections - one of 80, other out of 20
automatic_fail	boolean	Boolean to indicate if automatic fail was applied
evaluator_id	string	user_ID of evaluator
numeric_answer	double	Value for question where answer type is numeric
answer_reference_id	string	for single select answer type
to_delete	boolean	Set to true if Form/Section/sub-section/ question was deleted
disconnect_timestamp	timestamp	contact disconnect timestamp
initiation_timestamp	timestamp	contact initiation timestamp
user_id	string	user_id of person being evaluated
queue_id	string	queue_id of queue which contact was handled from
channel	string	The method used to contact your contact center: VOICE, CHAT, TASK.
contact_aggregation_timestamp	timestamp	Timestamp used for building aggregated agent, queue and weekly aggregation tables

Column	Type	Description
evaluated_contact_with_status	string	The status of the evaluated contact evaluation. Valid Values: DRAFT SUBMITTED
data_lake_last_processed_timestamp	timestamp	Timestamp which shows the last time the data lake touched a record in the data lake. This can include transformation and backfill. This field cannot be used to reliably determine data freshness

Contact Flow Events

Column	Type	Description
instance_id	string	The identifier of the Amazon Connect instance. You can find the instance ID in the Amazon Resource Name (ARN) of the instance.
event_id	string	The ID of the contact as it interacts with the flow
aws_account_id	string	The ID of the AWS account that owns the contact.
instance_arn	string	The ARN of the AWS Connect instance.
contact_id	string	The ID of the contact in the contact record
flow_resource_id	string	Contact flow Id
module_resource_id	string	Module Id
resource_version	string	Version of the contact flow used
resource_type	string	Can be flow or module
channel	string	The method used to contact your contact center: VOICE, CHAT, TASK.

Column	Type	Description
start_timestamp	timestamp	Date and time of the start event in unix epoch, UTC
end_timestamp	timestamp	Date and time of the end event in unix epoch, UTC
next_flow_resource_id	string	Next contact flow resource id
next_queue_resource_id	string	Next queue resource id
next_resource_type	string	It can be flow or queue
flow_language_version	string	Flow language version
flow_outcome	string	This will contain the system defined and custom outcomes
sub_type	string	This field can be used to show channel subtype. For example, connect:Guide or connect:SMS.
flow_type	string	Amazon Connect includes a set of nine flow types. For more information, see Choose a flow type .
initiation_method	string	Every contact in your Amazon Connect contact center is initiated by one of the following methods: Inbound, Outbound, Transfer, Callback, API, Queue Transfer, Disconnect
resource_published_timestamp	timestamp	"Creation" or "revision" date of the flow itself
data_lake_last_processed_timestamp	timestamp	Timestamp which shows the last time the data lake touched a record in the data lake. This can include transformation and backfill. This field cannot be used to reliably determine data freshness

Data retention

The analytics data lake retains data for 25 months. At launch, the following data sets have data from October 2022 assuming your instance has data from that far back: Contacts Record, Contact Statistic Record, Agent Queue Statistic Record, and Agent Statistic Record. Contact Lens Conversational Analytics data is available from July 2023, Contact Lens evaluation records from February 2023, and Contact Flow Events from May of 2024.

Customize the Amazon Connect Agent Workspace

This section explains how to customize the agent workspace and enable guided experiences.

Out-of-the-box the agent workspace integrates all of your agent facing capabilities on one page. For example, when an agent accepts a call, chat, or task, they are given necessary information about the case and customer, plus real-time recommendations.

You can customize the agent workspace by enabling guided experiences, for example, and customizing the look and feel of the View resources in the agent workspace.

The following image shows the parts of the agent workspace.

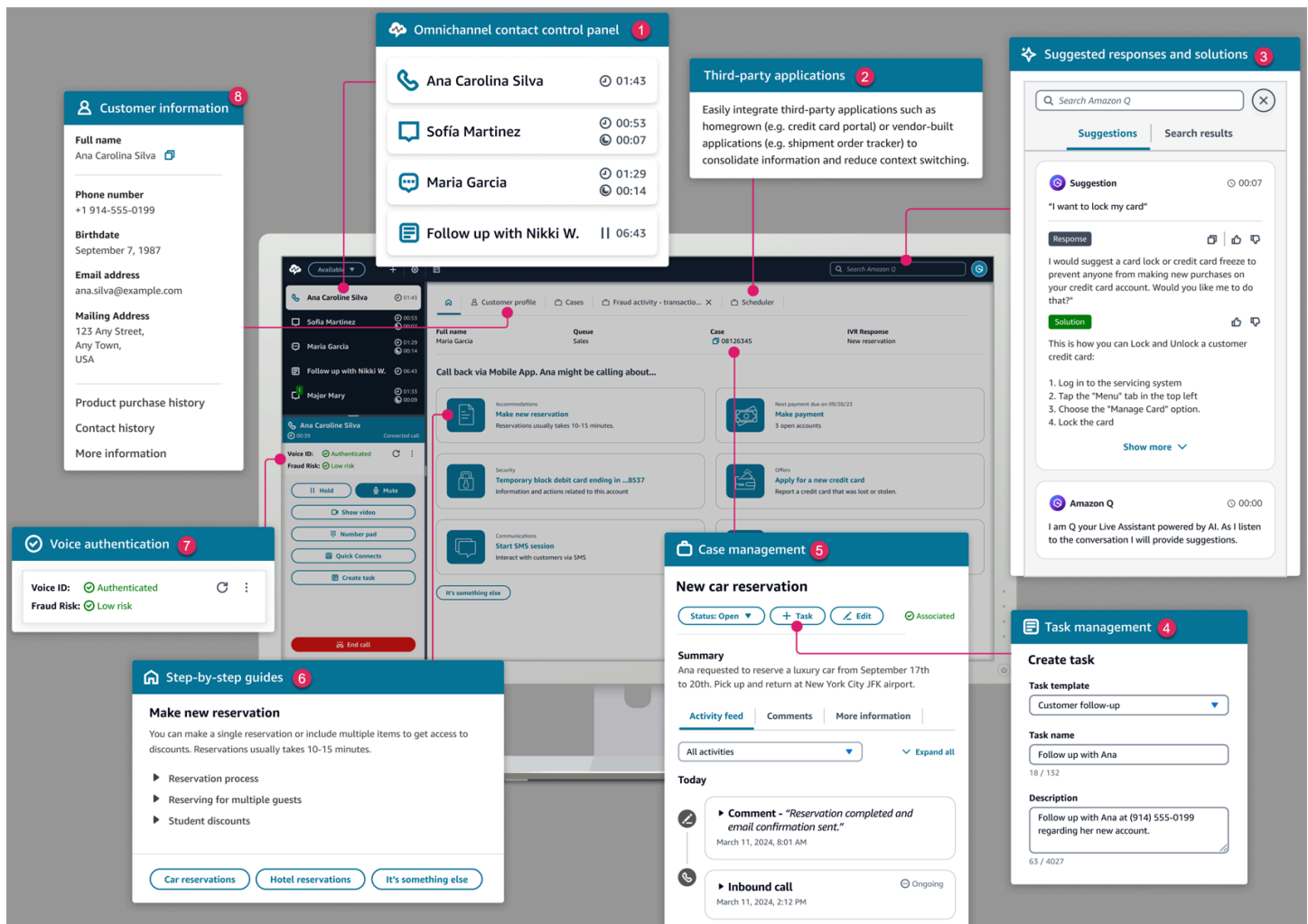

1. The **Contact Control Panel**, which agents use to accept calls, chats, and tasks.
2. **Third-party applications**, which reduce the number of windows an agent interacts with.

3. Real-time recommendations, powered by Amazon Q in Connect.
4. **Tasks** to assign work or follow-up activities.
5. The case ID, and other info on the **Cases** tab, powered by Amazon Connect Cases.
6. **Step-by-step guides**, which provide consistent workflows to reduce cognitive load.
7. Machine-learning powered voice authentication, powered by **Voice ID**.
8. Customer information on the **Customer profile** tab, powered by Amazon Connect Customer Profiles.

You can also integrate [third-party applications](#)—built by vendors or you—into the agent workspace. The following image shows an example third-party app named **SchedulerApp** in the agent workspace. Agents can launch apps by using the **Apps** launcher, which is located in the right corner of the agent workspace.

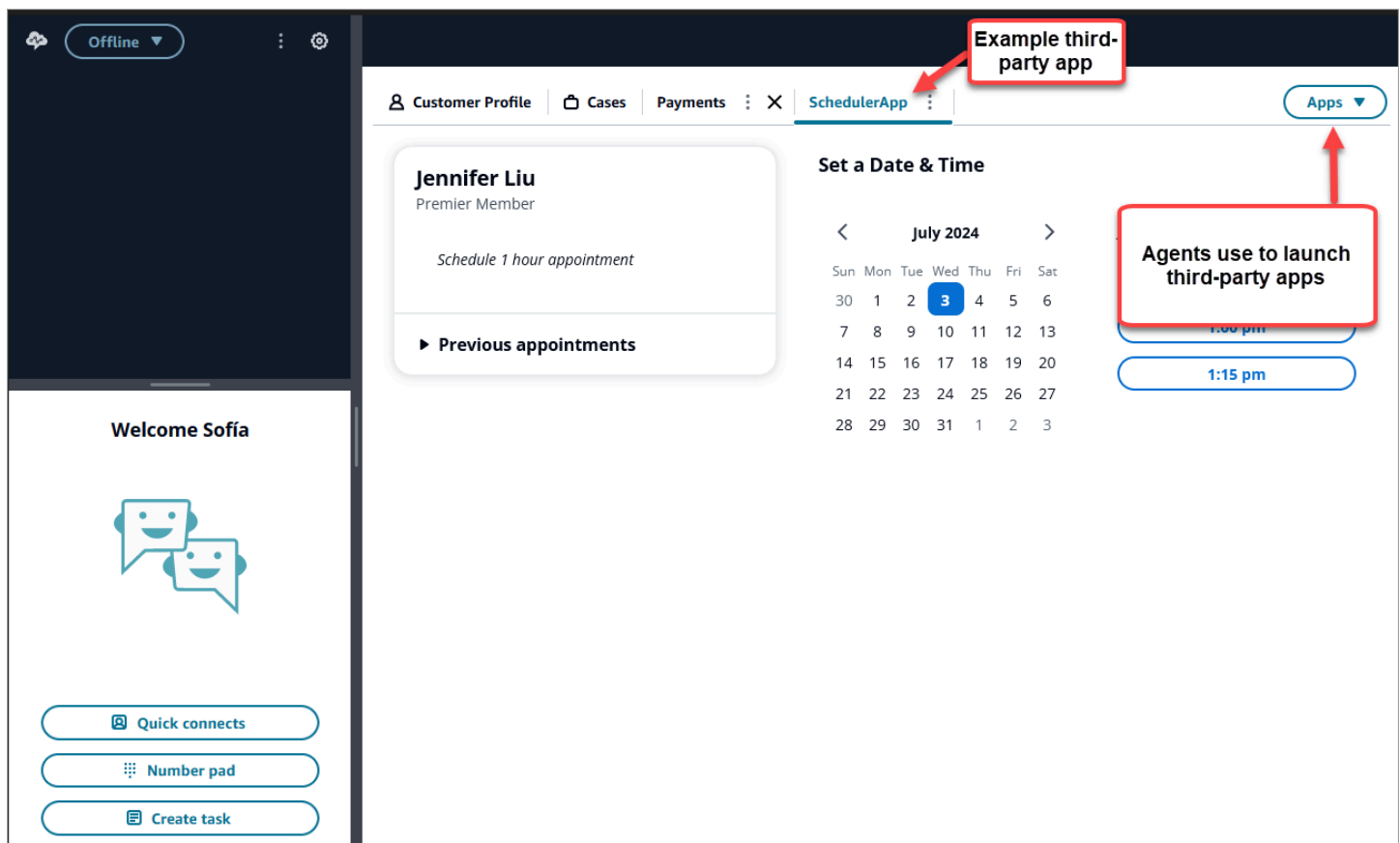

Contents

- [Step-by-step Guides](#)
- [Enable step-by-step guides](#)

- [View resource](#)
- [No-code UI builder](#)
- [How to invoke a guide at the start of a contact](#)
- [How to deploy step-by-step guides in chats](#)
- [Display contact attributes in the agent workspace](#)
- [Disposition codes](#)
- [PII Redaction](#)
- [Integrate third-party applications \(3p apps\) in the agent workspace](#)

Step-by-step Guides

In the Amazon Connect agent workspace, you can create workflows that walk agents through custom UI pages that suggest what to do at a given moment during a customer interaction. You can create workflows that give your agents screen pops and single page forms, or you can create detailed step-by-step guides that give your agents clear instructions on how to handle a particular use case. You can also customize the UI and the data that agents see.

To learn more about the possible UI configurations, see our interactive [documentation](#).

To learn more about the pricing of step-by-step guides, choose the **Guides** tab on the Amazon Connect [pricing page](#).

Overview

Agent facing workflows are configured by creating a flow that uses the [Show view](#). The **Show view** block determines what View to render in the agent's UI while all pre-existing flow blocks can be used to create branching decision trees and send and receive data from external systems.

When mapping a view to a **Show view** block, you will be able to select from a list of pre-built Views. For more details on the views see [Flow block: Show view](#).

Complex JSON Object support

The Show view block allows you to pass complex JSON objects between Amazon Connect agent workspaces and flows. Along with the **Show view** block, the **Invoke AWS Lambda** block is able to take JSON objects as input and output parameters. This allows you to pass larger quantities of data with fewer mapping steps required.

Enable step-by-step guides

The following steps allow you to provide your users with the ability to create guided experiences, and allow agents to interact with the experiences.

1. Enable admins to create visual flow

Assign managers and business analysts to the **Channels and flows - Views** security profile permission, as shown in the following image. This permission grants them the ability to configure step-by-step guides in flows.

Since guides are created using flows, also assign the **Flows - Edit, Create** permissions so that they can create any type of flow.

Security profile permissions									
Routing									
This group gives permissions to the following areas: routing policies, quick connects, hours of operation, queues and task templates.									
Channels and flows									
This allows for access to creating prompts, flows (IVR), as well as phone numbers.									
Type	All	View	Edit	Create	Remove	Publish	Claim	Release	Enable / Disable
Prompts	<input type="checkbox"/>	<input checked="" type="checkbox"/>	<input checked="" type="checkbox"/>	<input checked="" type="checkbox"/>	<input checked="" type="checkbox"/>	<input type="checkbox"/>	<input type="checkbox"/>	<input type="checkbox"/>	<input type="checkbox"/>
Flows	<input type="checkbox"/>	<input checked="" type="checkbox"/>	<input checked="" type="checkbox"/>	<input checked="" type="checkbox"/>	<input type="checkbox"/>	<input checked="" type="checkbox"/>	<input type="checkbox"/>	<input type="checkbox"/>	<input type="checkbox"/>
Flow modules	<input type="checkbox"/>	<input checked="" type="checkbox"/>	<input checked="" type="checkbox"/>	<input checked="" type="checkbox"/>	<input type="checkbox"/>	<input checked="" type="checkbox"/>	<input type="checkbox"/>	<input type="checkbox"/>	<input type="checkbox"/>
Phone numbers	<input type="checkbox"/>	<input checked="" type="checkbox"/>	<input checked="" type="checkbox"/>	<input type="checkbox"/>	<input type="checkbox"/>	<input type="checkbox"/>	<input checked="" type="checkbox"/>	<input checked="" type="checkbox"/>	<input type="checkbox"/>
Communication widget	<input type="checkbox"/>	<input type="checkbox"/>	<input type="checkbox"/>	<input type="checkbox"/>	<input type="checkbox"/>	<input type="checkbox"/>	<input type="checkbox"/>	<input type="checkbox"/>	<input checked="" type="checkbox"/>
Views ⓘ	<input type="checkbox"/>	<input checked="" type="checkbox"/>	<input checked="" type="checkbox"/>	<input checked="" type="checkbox"/>	<input checked="" type="checkbox"/>	<input type="checkbox"/>	<input type="checkbox"/>	<input type="checkbox"/>	<input type="checkbox"/>

2. Enable agents to view guides

Assign the **Agent Applications - Custom views** permission to agents. This enables them to see step-by-step guides in their agent workspace.

Historical changes ⓘ				
Customer Profiles ⓘ				
Agent Applications ⓘ				
Type	All	Access	View	Edit
Wisdom	<input type="checkbox"/>	<input type="checkbox"/>	<input type="checkbox"/>	<input type="checkbox"/>
Custom views ⓘ	<input checked="" type="checkbox"/>	<input checked="" type="checkbox"/>	<input type="checkbox"/>	<input type="checkbox"/>
Cases ⓘ				

3. Increase your service quota for concurrent active chats per instance

The workflows that agents interact with run as chat contacts in Amazon Connect. We recommend that you increase your **concurrent active chats per instance** quota by the number of concurrent contacts you expect to have this feature enabled for.

For more information about quotas, see [Amazon Connect quotas](#).

Note

Disconnect flow workflows count as their own contacts, so if you are setting both a `DefaultFlowID` and `DisconnectFlowID`, they will be counted as two active contacts.

View resource

Views are UI templates that you can use to customize your agent's workspace. For example, you can use views to display contact attributes to an agent, provide forms for entering disposition codes, provide call notes, and present UI pages for walking agents through step-by-step guides.

Amazon Connect includes a set of views that you can add your agent's workspace, and you can also create your own views using our public APIs.

When configuring views in flows using the [Show view](#) block, you can define both static and dynamic content for each view. The content for a specific view is composed of three key elements: a template, an input schema, and actions.

Tip

For the best data mapping experience, we recommend using the **Set JSON** option in the [Show view](#) block. All namespaces in flows can be referenced in the **Show View** block, including `$.External`, so you will be able to share data from external systems to your agent in whichever view you create. You can mix and match data from Amazon Connect and other sources in order to create a consolidated UI for your agent.

Custom views

Using APIs you can now create your own view resources. The View resource includes CloudFormation, CloudTrail, and Tagging support.

Views API example

View description

This view nests two cards within a container, and places a skip button to their right.

CLI command

```
aws connect create-view --name CustomerManagedCardsNoContainer \  
--status PUBLISHED --content file://view-content.json \  
--instance-id $INSTANCE_ID --region $REGION
```

view-content.json

```
{  
  "Template": <stringified-template-json>  
  "Actions": ["CardSelected", "Skip"]  
}
```

Template JSON (not stringified)

```
{  
  "Head": {  
    "Title": "CustomerManagedFormView",  
    "Configuration": {  
      "Layout": {  
        "Columns": ["10", "2"] // Default column width for each component is  
12, which is also the width of the entire view.  
      }  
    }  
  },  
  "Body": [  
    {  
      "_id": "FormContainer",  
      "Type": "Container",  
      "Props": {},  
      "Content": [  
        {
```

```
        "_id": "cafe_card",
        "Type": "Card",
        "Props": {

            "Id": "CafeCard",
            "Heading": "Cafe Card",
            "Icon": "Cafe",
            "Status": "Status Field",
            "Description": "This is the cafe card.",
            "Action": "CardSelected" // Note that these actions also appear
in the view-content.json file.

        },
        "Content": []
    },
    {
        "_id": "no_icon_card",
        "Type": "Card",
        "Props": {
            "Id": "NoIconCard",
            "Heading": "No Icon Card",
            "Status": "Status Field",
            "Description": "This is the icon card.",
            "Action": "CardSelected" // Note that these actions also appear
in the view-content.json file.

        },
        "Content": []
    }
]
},
{
    "_id": "button",
    "Type": "Button",
    "Props": { "Action": "Skip" }, // Note that these actions also appear in
the view-content.json file.
    "Content": ["Skip"]
}
]
```

The View

Inputs

\$.NoIconCardHeading indicates that an input for the field NoIconCardHeading is necessary to render the view.

Let's say NoIconCardHeading is set to No Icon Card.

Appearance

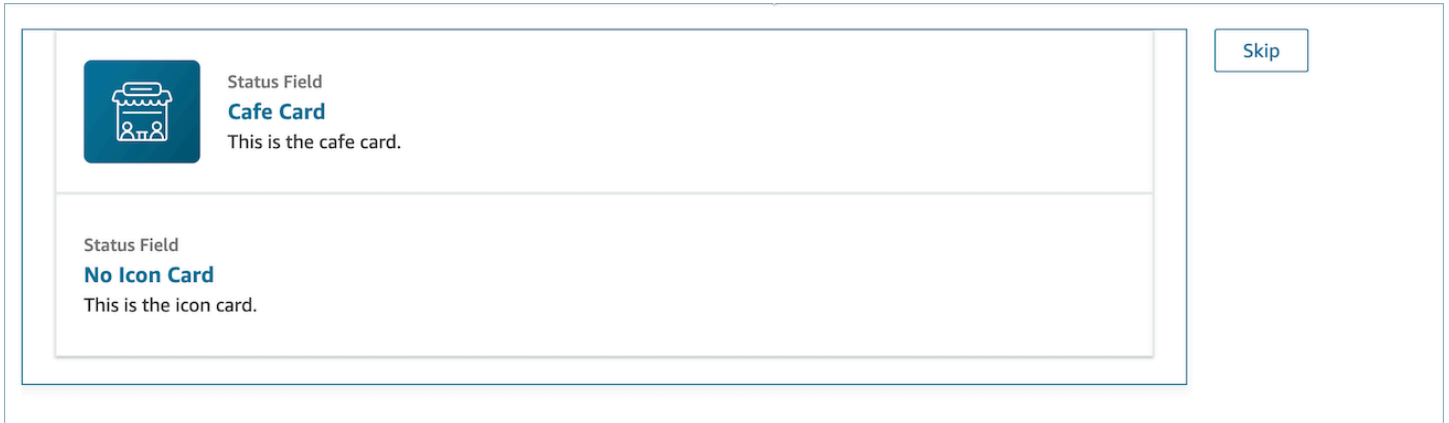

View output example

Views output two main pieces of data: the Action taken, and the Output data.

When using a view with the [Show view block](#), Action represents a branch, and Output data is set to the \$.Views.ViewResultData flow attribute, as mentioned in the Show View block documentation.

Scenario 1: Choose the Cafe Card Card

```
"Action": "CardSelected"
"Output": {
  "Heading": "CafeCard",
  "Id": "CafeCard"
}
```

Scenario 2: Choose the Skip Button

```
"Action": "Skip"
"Output": {
  "action": "Button"
}
```

Form View output example

When using the **AWS-managed view (Form view)**, the result of form data will be under *FormData*.

```
{
  FormData: {
    email: "a@amazon.com"
  }
}
```

You can access the data in the show view block such as `$.Views.ViewResultData.FormData.email`.

When using the **Custom view (with form component)**, the result of form data be come directly under output.

```
{
  email: "a@amazon.com"
}
```

You can access the data in the show view block such as `$.Views.ViewResultData.email`.

AWS managed views

Amazon Connect includes a set of views that you can add your agent's workspace. See the following for details on how to configure the different AWS managed views.

Detail view

The **Detail view** is for displaying information to the agent and providing them with a list of actions that they can take. A common use case of the **Detail view** is to surface a screen-pop to the agent at the start of a call.

- Actions in this view can be used to let an agent continue to the next step in a step-by-step guide or the actions can be used to invoke entirely new workflows.
- **Sections** is the only required component. It is where you can configure the body of the page you want to show to your agent.
- Optional components such as the **AttributeBar** are supported by this view.

Interactive [documentation](#) for **Detail view**

The following image shows an example of a **Detail view**. It has a page heading, description, and four examples.

Page Heading

Description of package or include multiple items to get access to discounts. Reservations usually takes 10-15 minutes.

<p>Example Attribute</p> <p>Example Attribute</p>	<p>Example 2 Attribute 2</p> <p>Example 2 Attribute 2</p>	<p>Example 3 Case:123456 🔗</p> <p>Example 3 Case:123456 🔗</p>	<p>Example 4 Attribute 2 🔗</p> <p>Example 4 Attribute 2 🔗</p>
<p>Example Attribute</p> <p>Example Attribute</p>	<p>Example 2 Attribute 2</p> <p>Example 2 Attribute 2</p>	<p>Example 3 Case:123456 🔗</p> <p>Example 3 Case:123456 🔗</p>	<p>Example 4 Attribute 2 🔗</p> <p>Example 4 Attribute 2 🔗</p>

Action 1
Action 2

Sections

- Content can be a static string, a `TemplateString` or a key-value pair. It can be a single data point or a list. For more information, see [TemplateString](#) or [AttributeSection](#).

AttributeBar (Optional)

- Optional, if provided will display the Attribute bar at the top of the view.
- Is a list of objects with required properties, **Label**, **Value**, and optional properties **LinkType**, **ResourceId**, **Copyable** and **Url**. For more information see, [Attribute](#).
 - **LinkType** can be external or connect application such as case.
 - When it is *external*, a user can navigate to a new browser page, which is configured with **Url**.
 - When it is *case*, a user can navigate to a new case detail on the Agent workspace, which configured with **ResourceId**.

- **Copyable** allows users to copy the ResourceId by choosing it with your input device.

Back (Optional)

- Optional, but required if no actions are included. If provided will display the back navigation link.
- Is an object with a *Label* which will control what is displayed in the link text.

Heading (Optional)

- Optional, if provided will display Text as the title.

Description (Optional)

- Optional, if provided will display description text under the title.

Actions (Optional)

- Optional. If provided, will display a list of action at the bottom of the page.

Input example

```
{
  "AttributeBar": [
    {"Label": "Example", "Value": "Attribute"},
    { "Label": "Example 2", "Value": "Attribute 3", "LinkType": "case",
  "ResourceId": "123456", "Copyable": true }
  ],
  "Back": {
    "Label": "Back"
  },
  "Heading": "Hello world",
  "Description": "This view is showing off the wonders of a detail page",
  "Sections": [{
    "TemplateString": "This is an intro paragraph"
  }, "abc"],
  "Actions": ["Do thing!", "Update thing 2!"],
}
```

Output example

```
{
  Action: "ActionSelected",
  ViewResultData: {
    actionName: "Action 2"
  }
}
```

List view

The **List view** is for displaying information as a list of items with titles and descriptions. Items may also act as links with actions attached. It also optionally supports the standard back navigation and persistent context header.

Interactive [documentation](#) for **List view**

The following image shows an example of a List view. It has one column with three items in it.

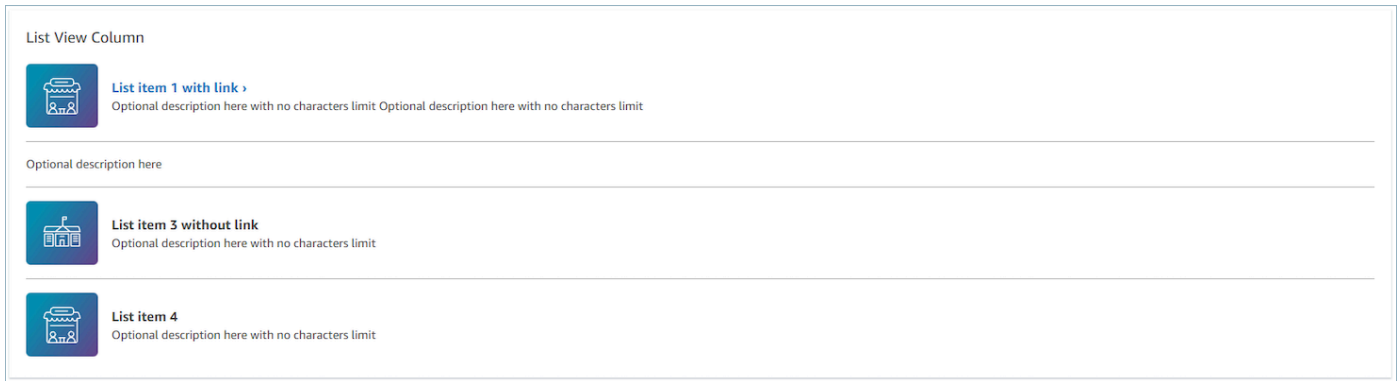

Items

- Required, will display these items as a list.
- Each item may have a Heading, Description, Icon, and Id.
 - All properties are optional.
 - When Id is defined, the output will include the value as part of output.

AttributeBar (Optional)

- Optional, if provided will display the Attribute bar at the top of the view.
- Is a list of objects with required properties, **Label**, **Value**, and optional properties **LinkType**, **ResourceId**, **Copyable** and **Url**. For more information see, [Attribute](#).
- **LinkType** can be external or connect application such as case.
 - When it is *external*, a user can navigate to a new browser page, which is configured with **Url**.
 - When it is *case*, a user can navigate to a new case detail on the Agent workspace, which configured with **ResourceId**.
- **Copyable** allows users to copy the **ResourceId** by choosing it with your input device.

Back (Optional)

- Optional, but required if no actions are included. if provided will display the back navigation link.
- Is an object with a *Label* which will control what is displayed in the link text.

Heading (Optional)

- Optional, if provided will display Text as the title.

SubHeading (Optional)

- Optional, if provided will display Text as the title of list.

Input data example

```
    {
      "AttributeBar": [
        { "Label": "Example", "Value": "Attribute" },
        { "Label": "Example 2", "Value": "Attribute 2" },
        { "Label": "Example 2", "Value": "Attribute 3", "LinkType": "external", "Url":
"https://www.amzon.com" }
      ],
      "Back": {
        "Label": "Back"
      },
    },
```

```

"Heading": "José may be contacting about...",
"SubHeading": "Optional List Title",
"Items": [
  {
    "Heading": "List item with link",
    "Description": "Optional description here with no characters limit. We
can just wrap the text.",
    "Icon": "School",
    "Id": "Select_Car"
  },
  {
    "Heading": "List item not a link",
    "Icon": "School",
    "Description": "Optional description here with no characters limit."
  },
  {
    "Heading": "List item not a link and no image",
    "Description": "Optional description here with no characters limit."
  },
  {
    "Heading": "List item no image and with link",
    "Description": "Optional description here with no characters limit."
  }
]
}

```

Output data example

```

{
  Action: "ActionSelected",
  ViewResultData: {
    actionName: "Select_Car"
  }
}

```

Form view

The **Form view** allows you to provide your agents with input fields to gather required data and submit data to backend systems. This view consists of multiple *Sections* with a predefined *Section* style with a header. The body consists of various input fields arranged in a column or a grid layout format.

Interactive [documentation](#) for **Form view**

The following image shows an example of a Form view for a car rental reservation. It has location and date fields on it.

The screenshot displays a form view for a car rental reservation. At the top, there is a header with four columns: Queue (Sales), Case ID (1234567), Case (New reservation), and Attribute 3 (Attribute). Below the header is a navigation link: < Back to home. The main content is titled "Modify reservation" for a "Cadillac XT5". There are two main sections: "Pick up details" and "Drop off details". The "Pick up details" section includes a "Location" dropdown menu set to "New York City JFK Airport", a "Day" field set to "07/23/2022" with a calendar icon, and a "Time" dropdown menu set to "10AM - 12PM". The "Drop off details" section includes a search bar for location, a "Day" field set to "07/28/2022" with a calendar icon, and a "Time" dropdown menu set to "10AM - 12PM". At the bottom right, there are two buttons: "Cancel" and "Confirm reservation", with a mouse cursor pointing at the "Confirm reservation" button.

Sections

- Location in the **Form view** where input fields and display fields are located.
- **SectionProps**
 - **Heading**
 - Heading of the section
 - **Type**
 - Type of section

- `FormSection` (forms handling user's input) or `DataSection` (displaying a list of label and value)
- **Items**
 - List of data based on the type. When `Type` is `DataSection`, the data should be attributes. If the `Type` is `FormSection`, the data should be form components.
- **isEditable**
 - Show edit button at the header when it is provided when the section type is `DataSection`.
 - Boolean

Wizard (Optional)

- Display **ProgressTracker** at the left side of the view.
- Each item may have a `Heading`, `Description`, and `Optional`.
 - `Heading` is required

Back (Optional)

- Is an object or string with a `Label` which will control what is displayed in the link text.

Next (Optional)

- This action is used when the step is not the last step in steps.
- Is an object (`FormActionProps`) or string. For more information, see [FormActionProps](#).

Cancel (Optional)

- This action is used when the step is not the first step.
- Is an object (`FormActionProps`) or string. For more information, see [FormActionProps](#).

Previous (Optional)

- This action is used when the step is not the first step.
- Is an object (`FormActionProps`) or string. For more information, see [FormActionProps](#).

Edit (Optional)

- This action is shown when the section type is `DataSection`.
- Is an object (`FormActionProps`) or string. For more information, see [FormActionProps](#).

AttributeBar (Optional)

- Optional, if provided will display the Attribute bar at the top of the view.
- Is a list of objects with required properties, **Label**, **Value**, and optional properties **LinkType**, **ResourceId**, **Copyable** and **Url**. For more information see, [Attribute](#).
 - **LinkType** can be external or connect application such as case.
 - When it is *external*, a user can navigate to a new browser page, which is configured with **Url**.
 - When it is *case*, a user can navigate to a new case detail on the Agent workspace, which configured with **ResourceId**.
 - **Copyable** allows users to copy the **ResourceId** by choosing it with your input device.

Heading (Optional)

- String that displays as the page title.

SubHeading (Optional)

- Secondary message for the page.

ErrorText (Optional)

- Optional, shows server-side error messages.
- `ErrorProps`; String

Input data example

```
      {  
    "AttributeBar": [{  
      "Label": "Queue",
```

```

        "Value": "Sales"
    },
    {
        "Label": "Case ID",
        "Value": "1234567"
    },
    {
        "Label": "Case",
        "Value": "New reservation"
    },
    {
        "Label": "Attribute 3",
        "Value": "Attribute"
    }
],
"Back": {
    "Label": "Back Home"
},
"Next": {
    "Label": "Confirm Reservation",
    "Details": {
        "endpoint": "awesomecustomer.com/submit",
    }
},
"Cancel": {
    "Label": "Cancel"
},
"Heading": "Modify Reservation",
"SubHeading": "Cadillac XT5",
"ErrorText": {
    "Header": "Modify reservation failed",
    "Content": "Internal Server Error, please try again"
},
"Sections": [{
    "_id": "pickup",
    "Type": "FormSection",
    "Heading": "Pickup Details",
    "Items": [{
        "LayoutConfiguration": {
            "Grid": [{
                "colspan": {
                    "default": "12",
                    "xs": "6"
                }
            }
        ]
    }
}

```

```

    ]],
  },
  "Items": [{
    "Type": "FormInput",
    "Fluid": true,
    "InputType": "text",
    "Label": "Location",
    "Name": "pickup-location",
    "DefaultValue": "Seattle"
  ]],
}, {
  "LayoutConfiguration": {
    "Grid": [{
      "colspan": {
        "default": "6",
        "xs": "4"
      }
    }, {
      "colspan": {
        "default": "6",
        "xs": "4"
      }
    }
  ]],
  "Items": [{
    "Label": "Day",
    "Type": "DatePicker",
    "Fluid": true,
    "DefaultValue": "2022-10-10",
    "Name": "pickup-day"
  }, {
    "Label": "Time",
    "Type": "TimeInput",
    "Fluid": true,
    "DefaultValue": "13:00",
    "Name": "pickup-time"
  }
  ]],
}, {
  "_id": "dropoff",
  "Heading": "Drop off details",
  "Type": "FormSection",
  "Items": [{
    "LayoutConfiguration": {

```

```
        "Grid": [{
            "colspan": {
                "default": "12",
                "xs": "6"
            }
        }
    ]
},
"Items": [{
    "Label": "Location",
    "Type": "FormInput",
    "Fluid": true,
    "DefaultValue": "Lynnwood",
    "Name": "dropoff-location"
}]
}, {
    "LayoutConfiguration": {
        "Grid": [{
            "colspan": {
                "default": "6",
                "xs": "4"
            }
        }, {
            "colspan": {
                "default": "6",
                "xs": "4"
            }
        }
    ]
},
"Items": [{
    "Label": "Day",
    "Type": "DatePicker",
    "Fluid": true,
    "DefaultValue": "2022-10-15",
    "Name": "dropoff-day"
}, {
    "Label": "Time",
    "Type": "TimeInput",
    "Fluid": true,
    "DefaultValue": "01:00",
    "Name": "dropoff-time"
}]
}]
}]
```



```
}
```

Output data example

```
{
  Action: "Submit",
  ViewResultData: {
    FormData: {
      "dropoff-day": "2022-10-15",
      "dropoff-location": "Lynnwood",
      "dropoff-time": "01:00",
      "pickup-day": "2022-10-10",
      "pickup-location": "Seattle",
      "pickup-time": "13:00"
    },
    StepName:"Pickup and drop off"
  }
}
```

Confirmation view

The **Confirmation view** is a page to show users after a form has been submitted or an action has been completed. In this pre-built template you can provide a summary of what has happened, any next steps, and prompts. The **Confirmation view** supports a persistent attribute bar, an icon/image, headline, and sub-headline, along with a back to home navigation button.

Interactive [documentation](#) for **Confirmation view**

The following image shows an example of a confirmation.



I have updated your car rental reservation for pickup on July 22.

You will be receiving a confirmation shortly. Is there anything else I can help with today?

Back to Home

Next

- Required.
- Action button for next
 - Label - string label for the navigation button.

AttributeBar (Optional)

- Optional, if provided will display the Attribute bar at the top of the view.
- Is a list of objects with required properties, **Label**, **Value**, and optional properties **LinkType**, **ResourceId**, **Copyable** and **Url**. For more information see, [Attribute](#).
 - **LinkType** can be external or connect application such as case.

- When it is *external*, a user can navigate to a new browser page, which is configured with **Url**.
- When it is *case*, a user can navigate to a new case detail on the Agent workspace, which configured with **ResourceId**.
- **Copyable** allows users to copy the **ResourceId** by choosing it with your input device.

Heading (Optional)

- String that displays as the page title.

SubHeading (Optional)

- Secondary message for the page.

Graphic (Optional)

- Displays an image
- Object with the following key:
 - **Include** - boolean, if this is true then the graphic will be included in the page.

Input Data Example

```
{
  "AttributeBar": [
    { "Label": "Attribute1", "Value": "Value1" },
    { "Label": "Attribute2", "Value": "Value2" },
    { "Label": "Attribute3", "Value": "Amazon", "LinkType": "external", "Url":
"https://www.amzon.com" }
  ],
  "Next": {
    "Label": "Go Home"
  },
  "Graphic": {
    "Include": true
  },
  "Heading": "I have updated your car rental reservation for pickup on July 22.",
```

```
"SubHeading": "You will be receiving a confirmation shortly. Is there anything
else I can help with today?",
}
```

Output Data Example

```
{
  "Action": "Next",
  "ViewResultData": {
    "Label": "Go Home"
  }
}
```

Cards view

The **Cards view** allows you to guide your agent by presenting them with a list of topics to choose from as soon as they accept the contact.

Interactive [documentation](#) for **Cards view**

Present cards to your agents. The following image shows an example of six cards that are presented to the agent: one to make a new reservation, and the others to review reservations for upcoming trips.

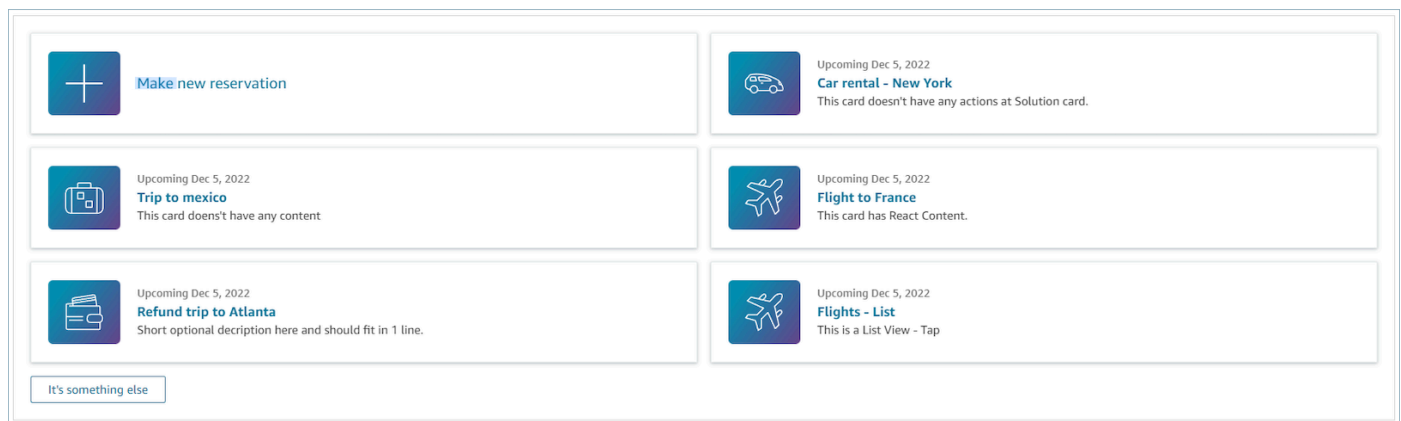

When agents choose a card, more info is revealed. The following image shows an open card that displays details for a reservation.

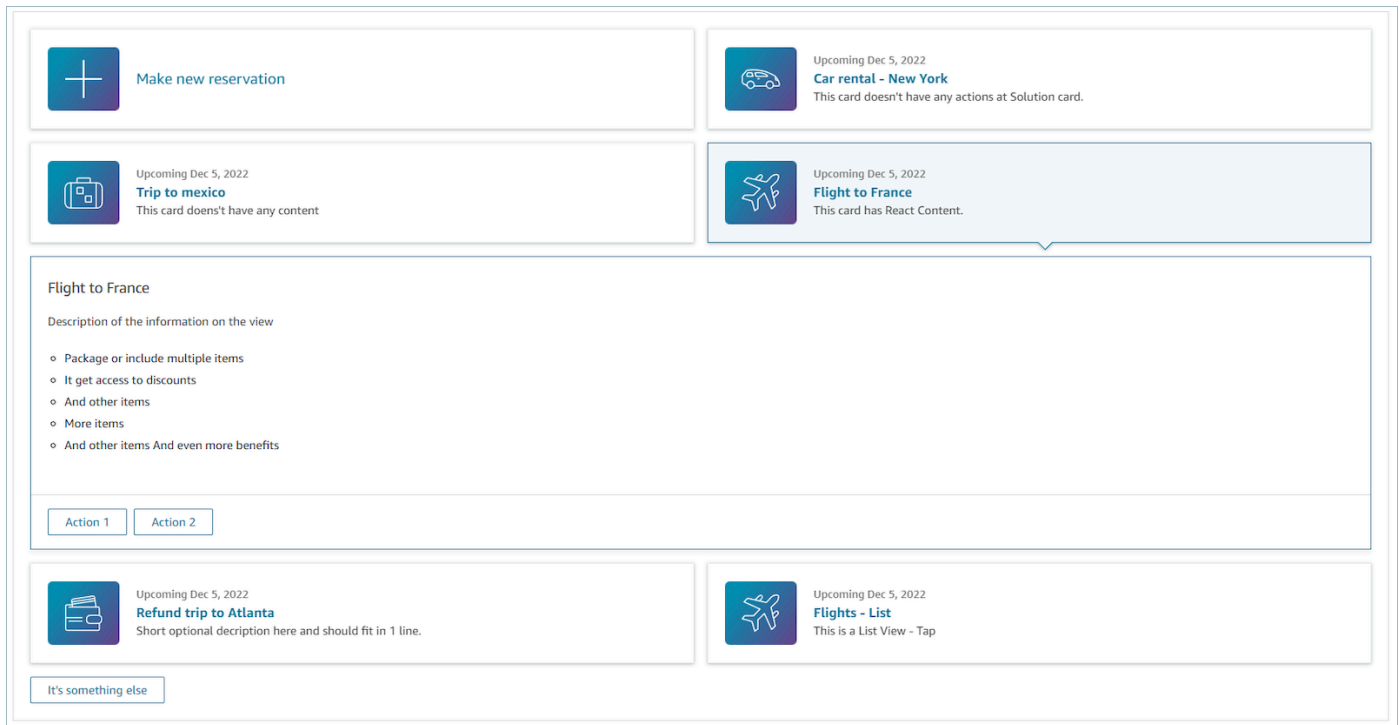

Sections

- It is list of objects with Summary and Detail. It must be provided to create Card and Detail.
- Consists of Summary and Detail. For more information see [Summary and Detail](#).

AttributeBar (Optional)

- Optional, if provided will display the Attribute bar at the top of the view.
- Is a list of objects with required properties, **Label**, **Value**, and optional properties **LinkType**, **ResourceId**, **Copyable** and **Url**. For more information, see [Attribute](#).
 - **LinkType** can be external or connect application such as case.
 - When it is *external*, a user can navigate to a new browser page, which is configured with **Url**.
 - When it is *case*, a user can navigate to a new case detail on the Agent workspace, which configured with **ResourceId**.
 - **Copyable** allows users to copy the **ResourceId** by choosing it with your input device.

Heading (Optional)

- String that displays as the page title

Back (Optional)

- It is an object or string with a Label which will control what is displayed in the link text. For more information, see [ActionProps](#).

NoMatchFound (Optional)

- It is a string that displays for a button that is below Cards. For more information see [ActionProps](#).

Input Data Example

```
{
  "AttributeBar": [{
    "Label": "Queue",
    "Value": "Sales"
  },
  {
    "Label": "Case ID",
    "Value": "1234567"
  },
  {
    "Label": "Case",
    "Value": "New reservation"
  },
  {
    "Label": "Attribute 3",
    "Value": "Attribute"
  }
  ],
  "Back": {
    "Label": "Back"
  },
  "Heading": "Customer may be contacting about...",
  "Cards": [{
    "Summary": {
      "Id": "lost_luggage",
      "Icon": "plus",
```

```

        "Heading": "Lost luggage claim"
    },
    "Detail": {
        "Heading": "Lost luggage claim",
        "Description": "Use this flow for customers that have lost their
luggage and need to fill a claim in order to get reimbursement. This workflow
usually takes 5-8 minutes",
        "Sections": {
            "TemplateString": "<TextContent>Steps:<ol><li>Customer provides
incident information</li><li>Customer provides receipts and agrees with amount</
li><li>Customer receives reimbursement</li></ol></TextContent>"
        },
        "Actions": [
            "Start a new claim",
            "Something else"
        ]
    }
},
{
    "Summary": {
        "Id": "car_rental",
        "Icon": "Car Side View",
        "Heading": "Car rental - New York",
        "Status": "Upcoming Sept 17, 2022"
    },
    "Detail": {
        "Heading": "Car rental - New York",
        "Sections": {
            "TemplateString": "<p>There is no additional information</p>"
        }
    }
},
{
    "Summary": {
        "Id": "trip_reservation",
        "Icon": "Suitcase",
        "Heading": "Trip to Mexico",
        "Status": "Upcoming Aug 15, 2022",
        "Description": "Flying from New York to Cancun, Mexico"
    },
    "Detail": {
        "Heading": "Trip to Mexico",
        "Sections": {
            "TemplateString": "<p>There is no additional information</p>"
        }
    }
}

```

```
    }
  }
},
{
  "Summary": {
    "Id": "fligh_reservation",
    "Icon": "Airplane",
    "Heading": "Flight to France",
    "Status": "Upcoming Dec 5, 2022",
    "Description": "Flying from Miami to Paris, France"
  },
  "Detail": {
    "Heading": "Flight to France",
    "Sections": {
      "TemplateString": "<p>There is no additional information</p>"
    }
  }
},
{
  "Summary": {
    "Id": "flight_refund",
    "Icon": "Wallet Closed",
    "Heading": "Refund flight to Atlanta",
    "Status": "Refunded July 10, 2022"
  },
  "Detail": {
    "Heading": "Refund trip to Atlanta",
    "Sections": {
      "TemplateString": "<p>There is no additional information</p>"
    }
  }
},
{
  "Summary": {
    "Id": "book_experience",
    "Icon": "Hot Air Balloon",
    "Heading": "Book an experience",
    "Description": "Top experience for european travellers"
  },
  "Detail": {
    "Heading": "Book an experience",
    "Sections": {
      "TemplateString": "<p>There is no additional information</p>"
    }
  }
}
```



```

    }
  }],
  "NoMatchFound": {
    "Label": "Can't find match?"
  }
}

```

Output Data Example

```

{
  Action: "ActionSelected",
  ViewResultData: {
    actionName: "Update the trip"
  }
}

```

HTML and JSX support

You can customize the look and feel of the layouts of View resources by leveraging HTML or JSX when you pass in input parameters to the show view block.

As a simple example, create a flow with one show view block and select the **Details view**. In the **Sections** field use the below JSON to see how either HTML or JSX expressions get processed.

HTML example

```

{
  "TemplateString":
    "<TextContent>Steps:<ol><li>Customer provides incident information</li><li>Customer provides receipts and agrees with amount</li> <li>Customer receives reimbursement</li></ol></TextContent>"
}

```

JSX example

```

{

```

```
"TemplateString":  
"Please provide an introduction to the customers. Ask them how their day is going  
Things to say:  
Hello, how are you today? My name is Bob, who am I speaking to?"  
}
```

No-code UI builder

You can create the view resources used in step-by-step guides by using Amazon Connect's no-code UI builder. With this feature, you are able to drag and drop UI components onto a canvas, arrange your layout, and edit the properties of each component. UI components are available on the left hand side of the screen and are grouped inside collapsible containers. The center of the screen is the canvas that shows you what your view resource looks like. The right hand side of the screen is where the properties are located.

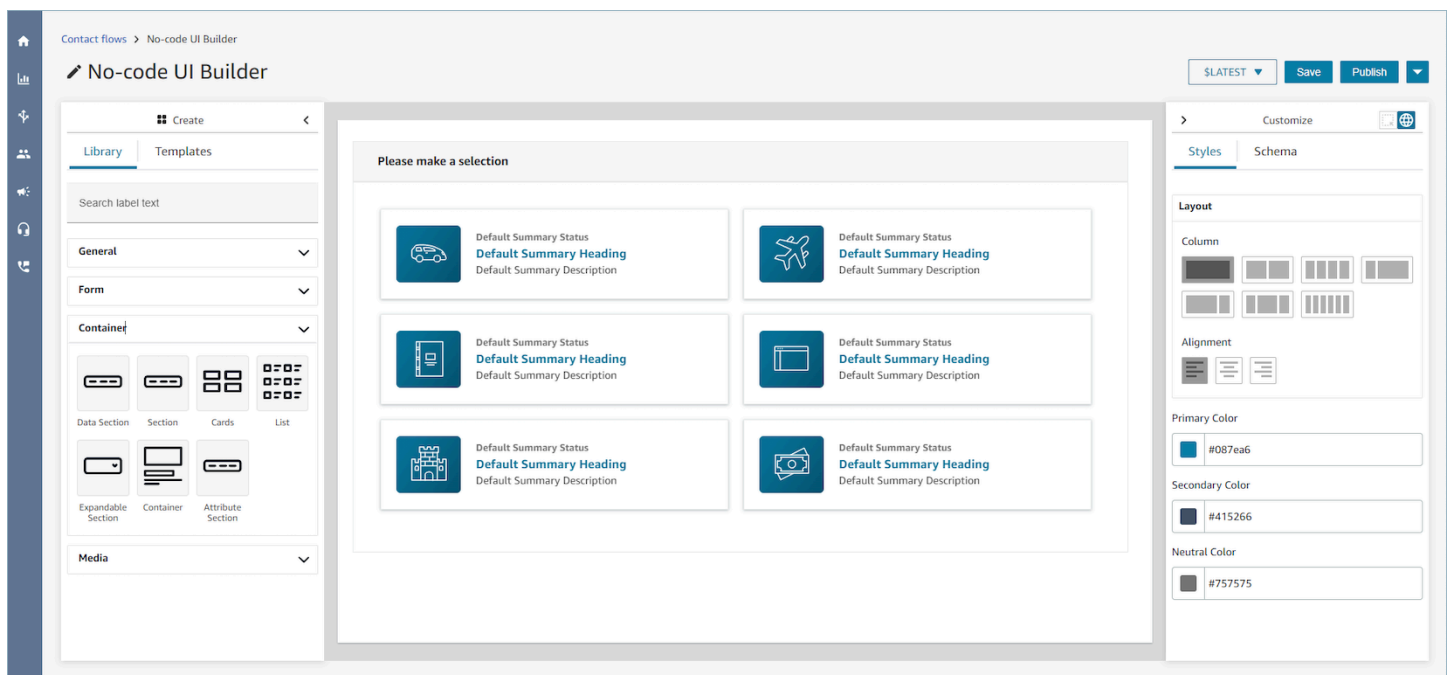

Accessing the no-code UI builder

To access the no-code UI builder, you can ensure that your Amazon Connect user has access to **Views** permissions under the **Channels and flows** security profile permissions. After the permissions are granted, the user will be able to see the no-code UI builder in the Amazon Connect admin website under **Routing, Flows, Views**. For more information on enabling **View** permissions, see [Enable step-by-step guides](#).

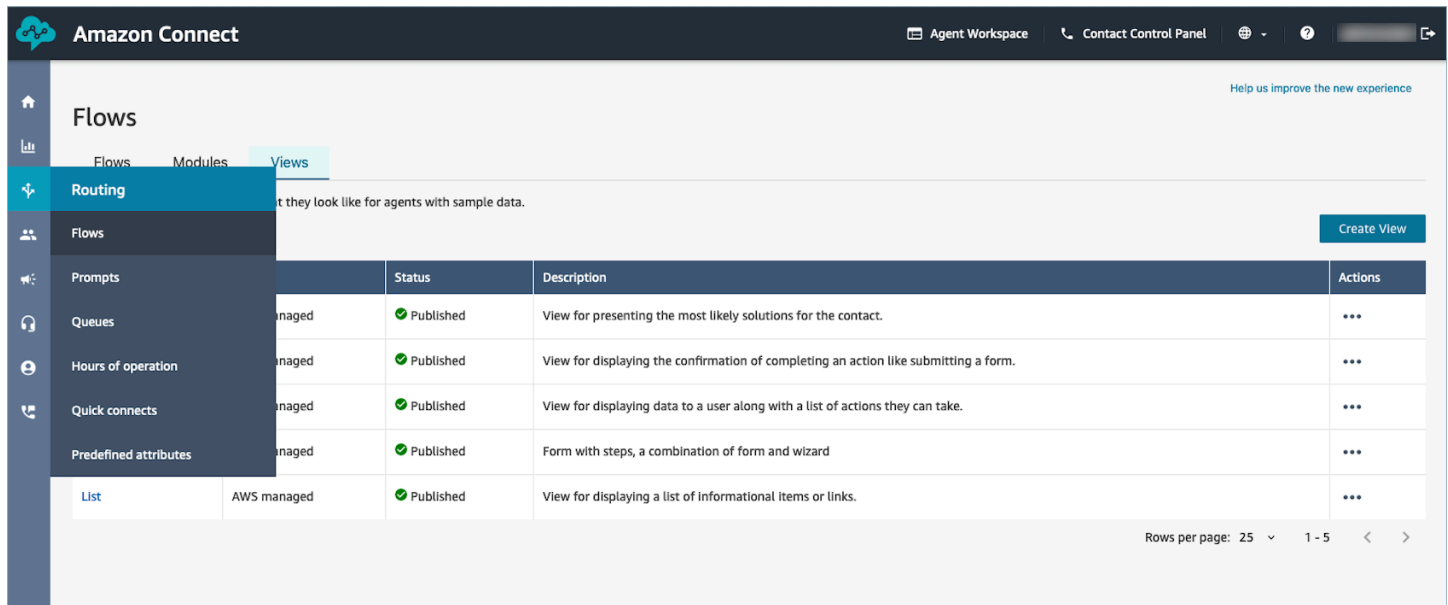

Amazon Connect

Agent Workspace Contact Control Panel

Flows

Routing

Flows

Prompts

Queues

Hours of operation

Quick connects

Predefined attributes

List

Name	Status	Description	Actions
Managed	Published	View for presenting the most likely solutions for the contact.	...
Managed	Published	View for displaying the confirmation of completing an action like submitting a form.	...
Managed	Published	View for displaying data to a user along with a list of actions they can take.	...
Managed	Published	Form with steps, a combination of form and wizard	...
List	Published	View for displaying a list of Informational Items or links.	...

Rows per page: 25 1 - 5

UI component library

To learn more about all of the individual UI components and how to configure these components, see our interactive [documentation](#).

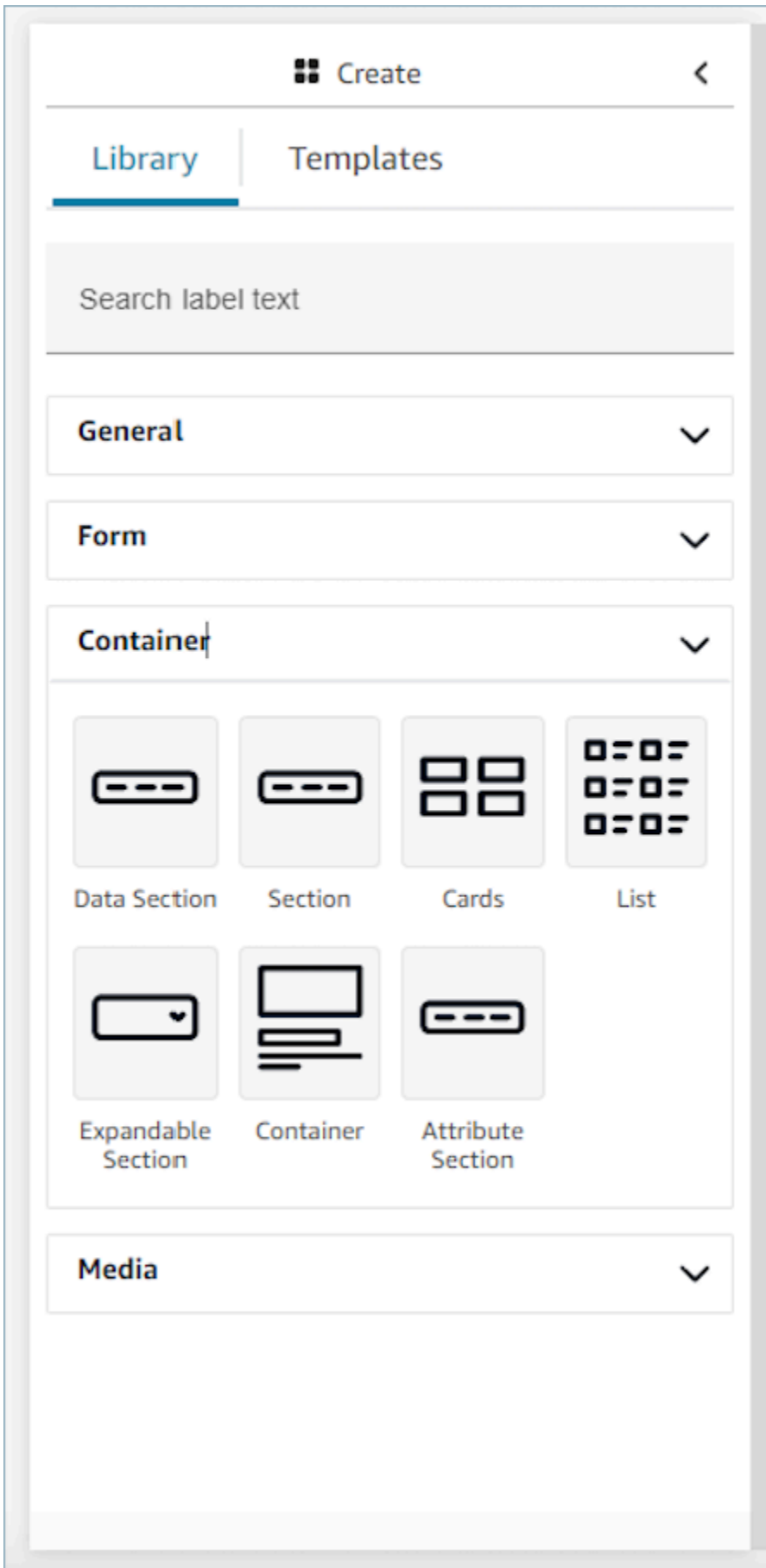

Containers

Containers are a core building block to make views. You are able to move UI components (including other containers) into a container in order to group them together logically and visually on the page. In order to keep the contents of the page relatively consistent as you customize the top level view settings, we highly encourage using containers in all of your views. Containers also come with column layout support, allowing you to organize the contents with a container.

Form

In order to create a form, you must use the form component. You can drag and drop the form component onto the canvas from the UI library or start off with the **Form Example** template that uses a form component. Effectively, the form component is a special type of container into which you are able to insert input fields and a submit button. When the submit button is pressed by the user interacting with a guide, the system will pass along all of the values entered into the form fields back to the contact flow. At that point, in the contact flow, you will be able to customize your own business logic and send/retrieve data to third-party systems using lambda flow blocks.

The screenshot shows a no-code UI builder interface for a form. The form is titled "Please enter details" and is contained within a window labeled "Form" with a close button (X) in the top right corner. The form contains several input fields:

- A text input field with a "Label placeholder" and a "DefaultValue Placeholder".
- A text input field with a "Label placeholder" and a "HelperText Placeholder".
- A dropdown menu with a "Label placeholder" and a downward arrow.
- A date input field with a "Label placeholder" and a calendar icon, with the text "Date in YYYY-MM-DD format" below it.
- A telephone number input field with a "Label placeholder" and the value "212-123-4567".
- A time input field with a "Label placeholder" and a clock icon, with the text "--:-- --" below it.

A "Submit Button" is located at the bottom right of the form.

Customize panel

On the right hand side of the no-code UI builder is the **Customize** panel. In this panel you will be able to set a range of settings for your view including column layouts, colors, dynamic data mapping, sample data, and static data definitions. Both global settings for the entire view resource as well as local settings at the component level are configured in this panel.

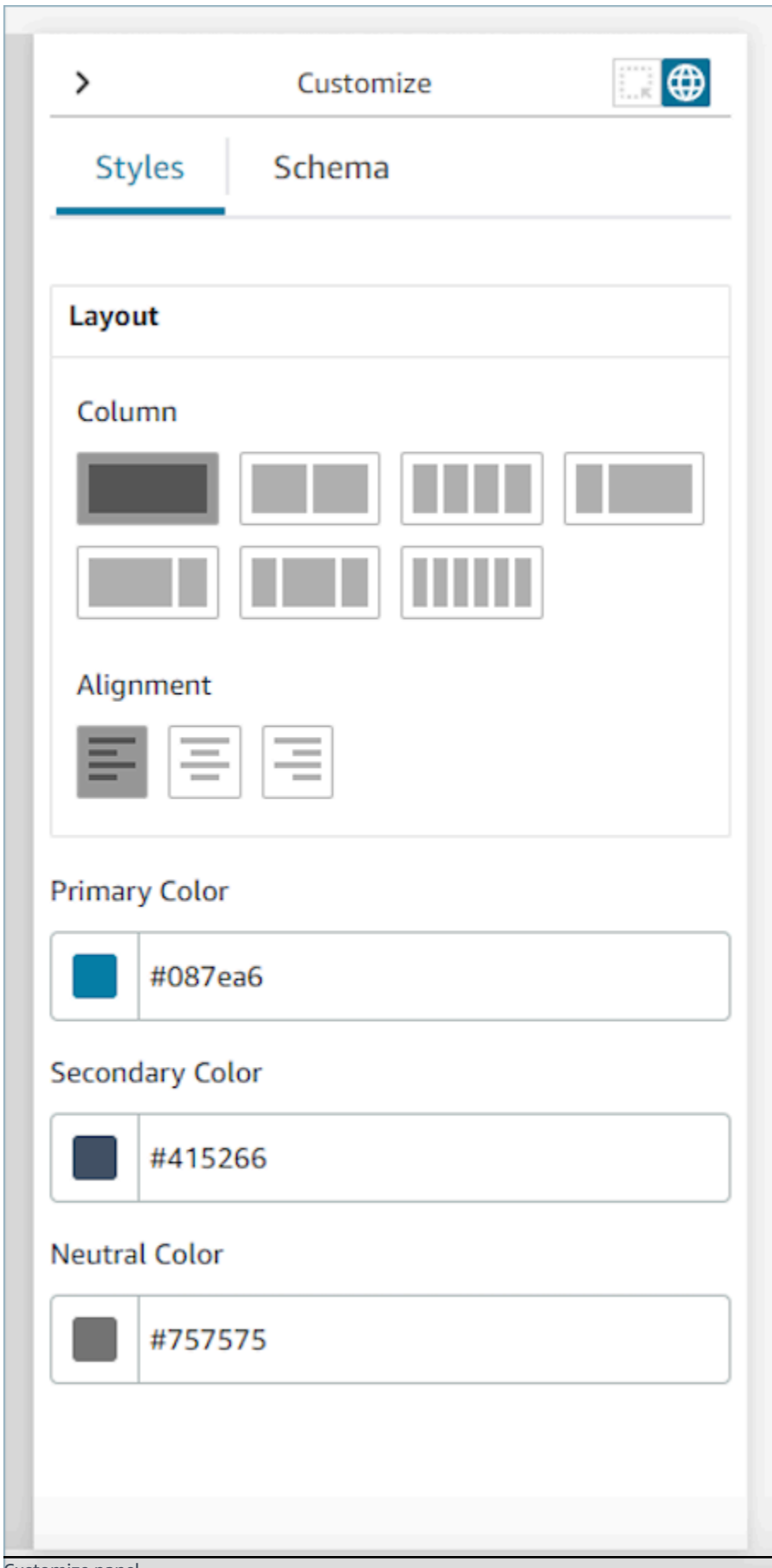

Global settings

Global settings control the overall configuration of your view. To find global settings, navigate to the Customize panel on the right hand side of the screen and choose the globe icon, which is highlighted in the following image. Global Settings that exist today are layouts and colors. For more details on columns, see [Layout columns](#). **Alignment** controls the relative location of components either to the left, center, or right of the view. There are three color fields available at the global level for the view resource: primary color, secondary color, and neutral color. Each component in the view will apply these settings by default. However, when customizing a component, you are able to override these global color settings.

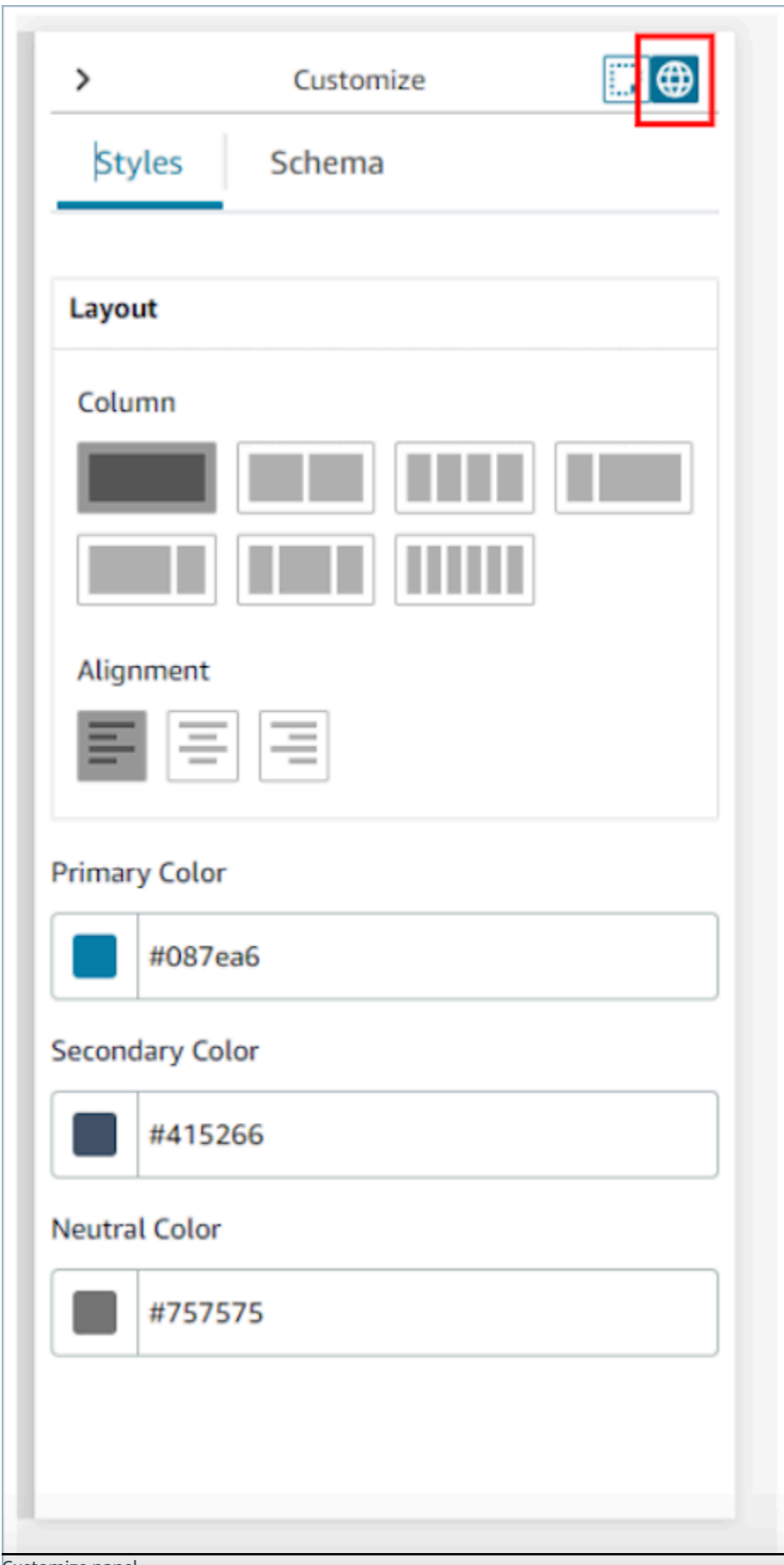

Layout columns

The view resource uses a flexbox pattern with 12 columns. Instead of components being placed onto the canvas in a pixel perfect manner, components occupy a relative position to one another, allowing the view to responsively scale up and down in size without losing the composition of the view. In the Global settings you are able to determine how you want to group your columns.

For example, in the **Column** section, you can choose to divide the view into two sections of 6 columns and get the following layout.

The image shows a user interface layout divided into two columns. The left column contains a form titled "Enter Details" with three input fields: "City" (New York City), "Telephone Number" (212-123-4567), and "Email Address" (name@company.com). The right column contains three promotional cards: "New Offers Flight Deals", "Default status Automobiles", and "New Offers Bicycles", each with an icon and a "Click here to learn more a..." link.

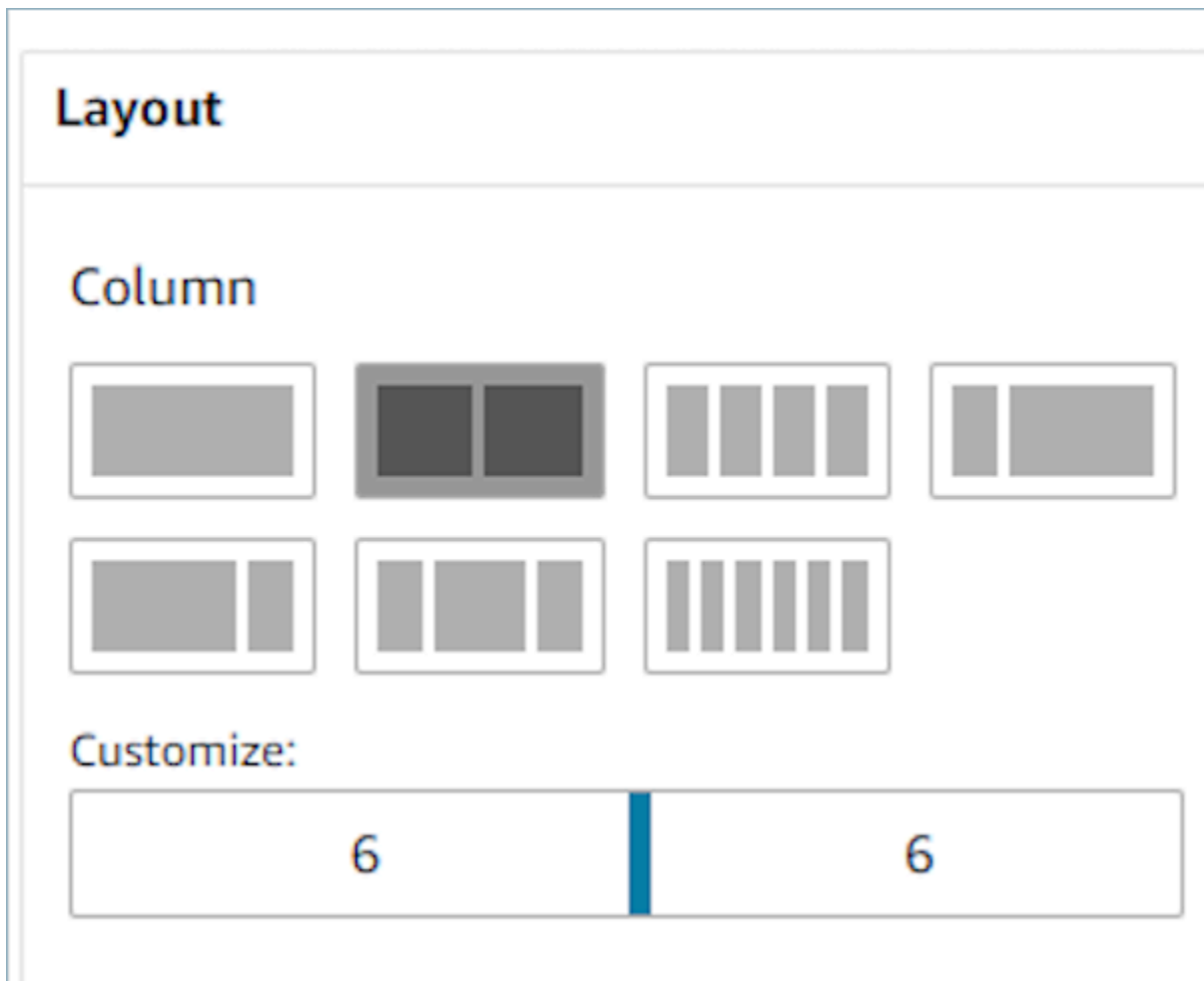

You could also use the **Customize** slider to alter the ratios of these groupings. For example, you can set it so the left hand side of the view is 4 columns and the right hand side is 8.

Enter Details

City
New York City

Telephone Number
212-123-4567

Email Address
name@company



New Offers
Flight Deals
Click here to learn more about the deals available



Default status
Automobiles
Click here to learn more about the deals available



New Offers
Bicycles
Click here to learn more about the deals available

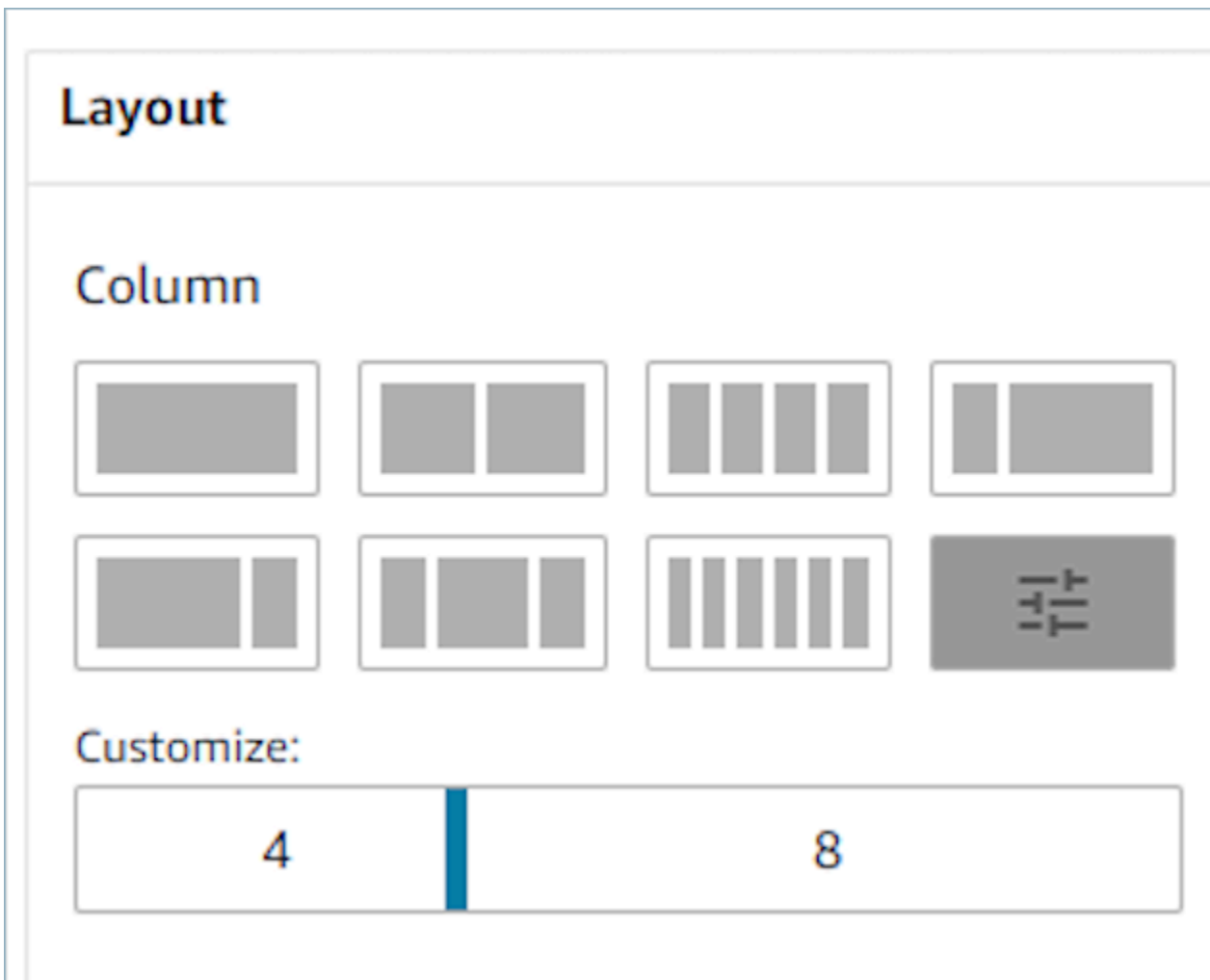

Dynamic fields

For some components, you won't know what values get populated until a guide is used at runtime. For example, if you are making a screen pop, you might know that you want to surface the customer's name and profile ID, but the values of these fields will change from contact to contact.

To set a specific field to have a component value, you can open up the properties tab for that component and select the check box **This is dynamic** that appears next to the field in question. The most common fields that requires dynamic values are the **Value** field for display fields and the **DefaultValue** field found in form inputs. Technically, any field both visible and hidden to an agent can be dynamically determined at runtime, which is why every field in the properties tab has a **This is dynamic** option that you may select.

As an example, we can take a look at the **AttributesBar** component. **This is dynamic**, the label of the display field found in the attributes bar, is statically defined as **Customer Name**, whereas the

actual value that populates this field is dynamic, and therefore will be determined by the data that gets passed in at runtime into the [Show view block](#).

▼ **Attributes-1**

This is dynamic

Label

This is dynamic

Customer Name

Value

This is dynamic

You also have the option to set all of the attributes of a component as dynamic. In this case, everything about this field, including the label, will be determined at runtime based on the values passed into the [Show view block](#). In this case, **Customer Name** is now sample data that you can use to get a sense of what the agent will see when they use a guide, but this value is not viewable to the agent.

▼ **Attributes-1**

This is dynamic

Label

This is dynamic

Customer Name

Value

This is dynamic

LinkType

This is dynamic

undefined ▼

Url

This is dynamic

ex. <https://example.com>

You can also set all of the sub-components of special containers as dynamic. For example, with the attributes bar, you can select the **This is dynamic** checkbox to make all of the attributes dynamic and therefore determined by whatever gets passed into the [Show view block](#) at runtime.

Attributes ▼

This is dynamic

- ▶ **Attributes-1**
- ▶ **Attributes-2**
- ▼ **Attributes-3**

This is dynamic

Label

This is dynamic

Active Case

Value

This is dynamic

Attribute 2

LinkType

This is dynamic

Case ▼

Url

This is dynamic

Setting actions that appear in flows

In order for a user to proceed to a new page when using guides, they will need to choose a button. When configuring buttons in the no-code UI builder, such as a submit form button, you will be able to determine an **Action** for this button. When a user chooses the button at runtime when using a guide and the response message is sent to flows, the **Action** value will determine which branching path will be followed. For example, if a view has three buttons on it, each with different actions, then those actions will appear on the show view block as different paths, allowing you to quickly configure the appropriate branching logic in flows.

The image shows the 'Customize' interface for a button in Amazon Connect. On the left, a preview shows a blue button labeled 'Next' with a close icon. The right panel is titled 'Customize' and has two tabs: 'Properties' (selected) and 'Styles'. The button is identified as 'Button' with ID 'Button_1...'. Below are several settings, each with a 'This is dynamic' checkbox: 'Variant' is set to 'Primary'; 'IconAlign' is set to 'Left'; 'IconName' is empty; and 'Disabled' is turned off. The 'Action' field at the bottom is highlighted with a red border and contains 'NextPage' with a search icon and a close icon.

Saving and publishing view versions

View resources have versioning support that lets you audit and even re-use the previous iterations of a view you have created and/or used in step-by-step guides. After you make changes to your view, it is important to choose the **Save** button in order for the view resource to get updated. Once you are ready for a view to be used in a step-by-step guide contact flow, you can choose the **Publish** button. Only view versions that have been published will appear in the [Show view block](#) for use in a flow.

Note

In order to save a view, you must have entered a name for the view. You can set the name of the view in the top left hand corner of the no-code UI builder.

Templates to get started quickly

Included in the no-code UI builder are ready made templates you can use to pre-populate your canvas with components. By navigating to the **Templates** tab in the **Create** panel on the left hand side, you will be able to select one of the template options. Once the template appears on the canvas, you can add more components, delete components, and do any other type of configuration you can do with a view resource built from scratch.

If you have already placed UI components onto the canvas, these components will be overwritten and the template will take their place. These changes will only be finalized once you **Save** the view resource, so if you use a template in error, you can leave the page and come back to return to your last saved view resource version.

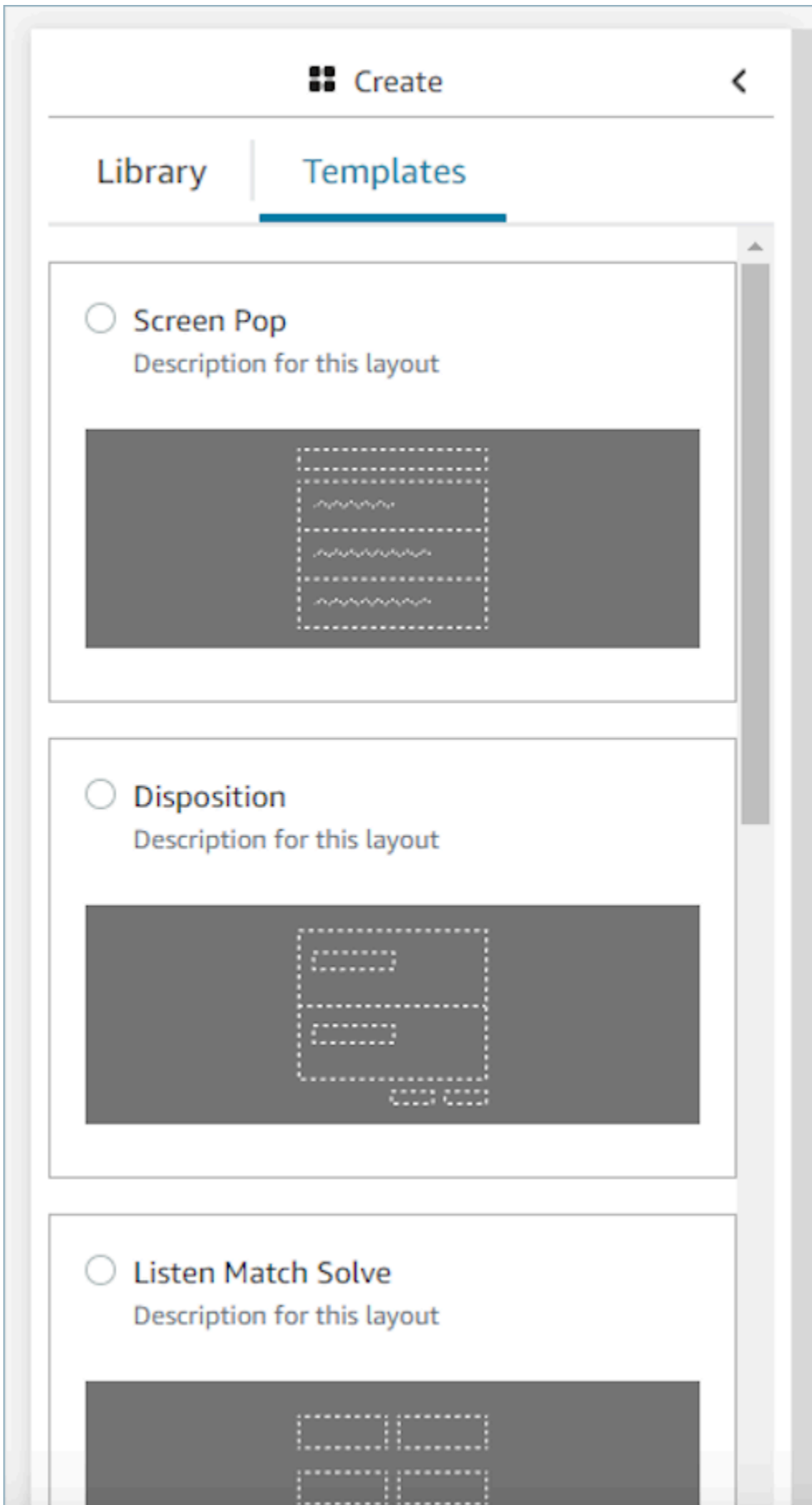

Screen pop applications

For screen pop functionality of third-party applications, you can use step-by-step guides or you can use app pinning. For more information, see [Access third-party applications in the agent workspace](#). When the contact comes in, the **Guides** tab opens as the first one in the agent workspace. You can [configure the step-by-step guides](#) using flows.

Note

When you configure a view, ensure that the app name registered in the AWS Console exactly matches the app name that you are providing to the Application and/or App Launch component. If you are getting errors, and you think the names are matching, edit the AWS Console application name and ensure there are no leading or trailing spaces.

- With the Application component, you are embedding the third-party application into Guides. The application displays in the first tab when the contact comes in.
- With the App Launch component, you are configuring the application to open as a tab in the agent workspace. You can turn on auto-open, the Guide will take the focus as the first tab, and the application will open as another tab.
- You can always use the Link component with auto-open to configure any browser link to open in a new browser window.

You have the option to provide a path to give a more specific destination or parameter for the contact. When you provide the path, it will be shortened to the domain. You should provide a forward slash at the end of the app domain.

Example 1 (Recommended):

```
App Domain registered in AWS console: https://example.com/  
Path: cats/siamese  
Guides will attempt to render: Domain https://example.com/ + Path cats/siamese  
https://example.com/cats/siamese  
Success if website exists!
```

Example 2:

App Domain registered in AWS console: `https://example.com/dogs/`
Path: `cats/siamese`
Guides will attempt to render: Domain `https://example.com/` + Path `cats/siamese`
`https://example.com/cats/siamese`
 Fails because only subdomains of `https://example.com/dogs/` are allowed

Example 3:

App Domain registered in AWS console: `https://example.com/cats`
Path: `cats/siamese`
Guides will attempt to render: Domain `https://example.com/` + Path `cats/siamese`
`https://example.com/cats/siamese`
 Success if website exists!

The screenshot displays the Amazon Connect console interface for configuring a contact flow. The main area shows a canvas with an 'AppLaunch' widget. On the left, a 'Create' panel is open, showing a 'Library' of widgets including Alert, App Launch, Application, Attribute Bar, Button, Card, Carousel, Detail, Header, Link, HTML Box, and Text Box. On the right, a 'Customize' panel is open, showing the 'Properties' tab for the 'AppLaunch' widget. The 'App Name' field is set to 'Sample App 1' and the 'Path' field is set to 'default/track?gtms=LP-12345-628-110'. The 'AutoOpen' checkbox is checked.

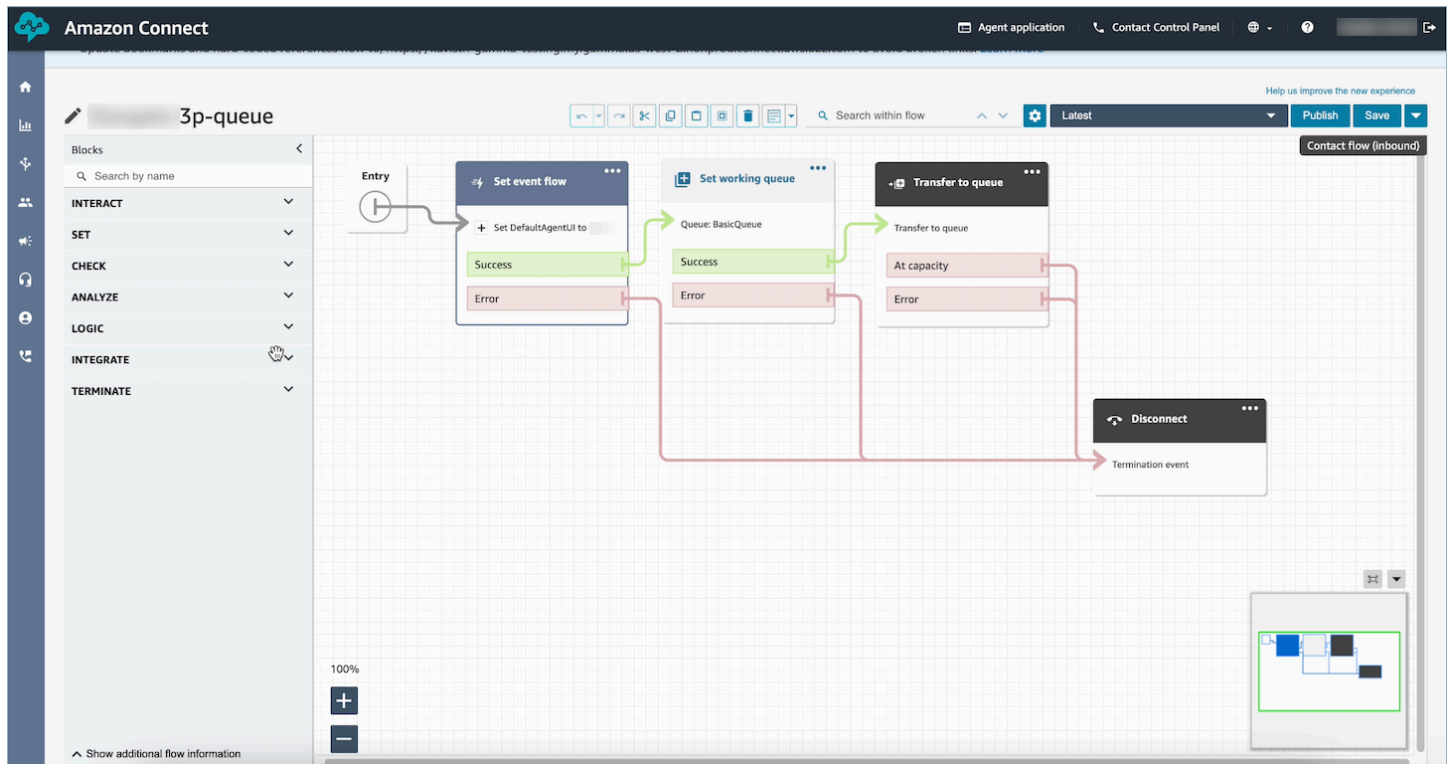

Sample data

Sample data can be used to see what your final view will look like to the user even when the actual data fields that will be displayed are dynamically determined at runtime. When **This is dynamic** is selected for a field, the value entered into the input box for that field is sample data that will appear in the canvas. This sample data is for view purposes only and will only appear in the Amazon Connect admin website.

For example, in the following image, **Address Line 1** in the **Mailing address** is a dynamic default value that will be populated at run-time by the address found in the customer profile. However, since the person building the view resource would like to see what the final UI will look like for their agent, they have entered a text default value. This value **7 W 34th St** is for display purposes only in the Amazon Connect admin website and will not appear to the agent.

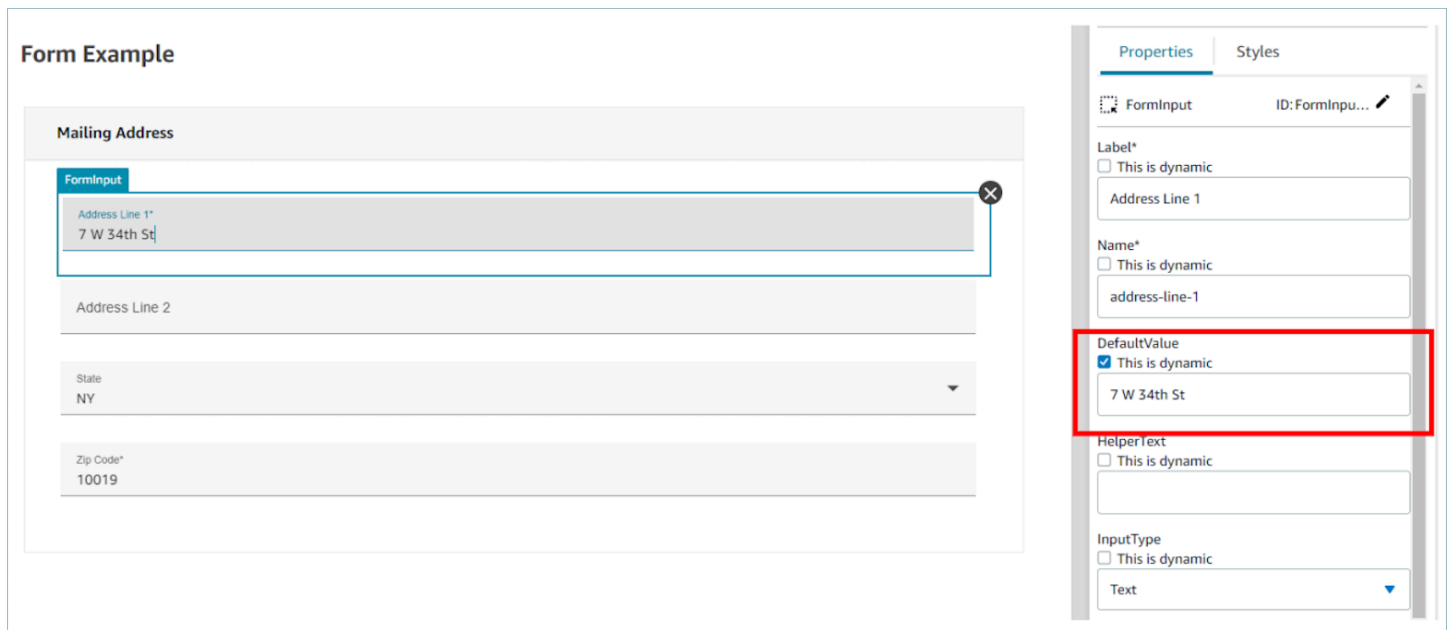

How to invoke a guide at the start of a contact

After you've created your flows, you will be able to dynamically determine which ones to surface by setting the **DefaultFlowForAgentUI** event hook in your flows using the **Set event flow** block.

Guides start as soon as the contact is offered to the agent. They don't wait for the contact to be accepted. We recommend that you do not set guides in the **Agent whisper flow**; choose another flow instead.

For example, by checking the IVR responses, queue name, and customer info, you can create branching logic in flows that determines which flow ID to set. Use the **Check attribute** block to set your conditional logic and the **Set event flow** block to set the flow you want to send to your agent.

The following image shows the **Properties** page for the **Set event flow** block. **Event hook** is set to **Default flow for Agent UI**.

Set event flow



Specify a flow to run when a contact event or interaction occurs, such as an agent accepting or disconnecting from a call or placing a customer on hold [Info](#)

Select event

Select an event hook

Default flow for Agent UI

Select a flow

Set manually

 Select a flow

This field cannot be empty.

Set dynamically

How to deploy step-by-step guides in chats

You can enable step-by-step Guides within Amazon Connect chats to create interactive, self-service experiences. This feature helps you resolve customer issues faster by gathering and transferring context to your agents. You can present the same guide that you built for your agents to customers for better configuration management.

Enable step-by-step Guides in Amazon Connect chats

1. Ensure that you have enabled and configured [step-by-step Guides](#) for agents. After you configure the guides, confirm that they pop up when a contact is reserved for an agent to answer.
2. Set up your flow to invoke Views in the chat flow by using the Show View Block, in the same way that you would configure this for your agent. The following example will trigger the guide when the chat bubble is chosen by the customer. The flow will go through two views before transferring the chat to an agent.

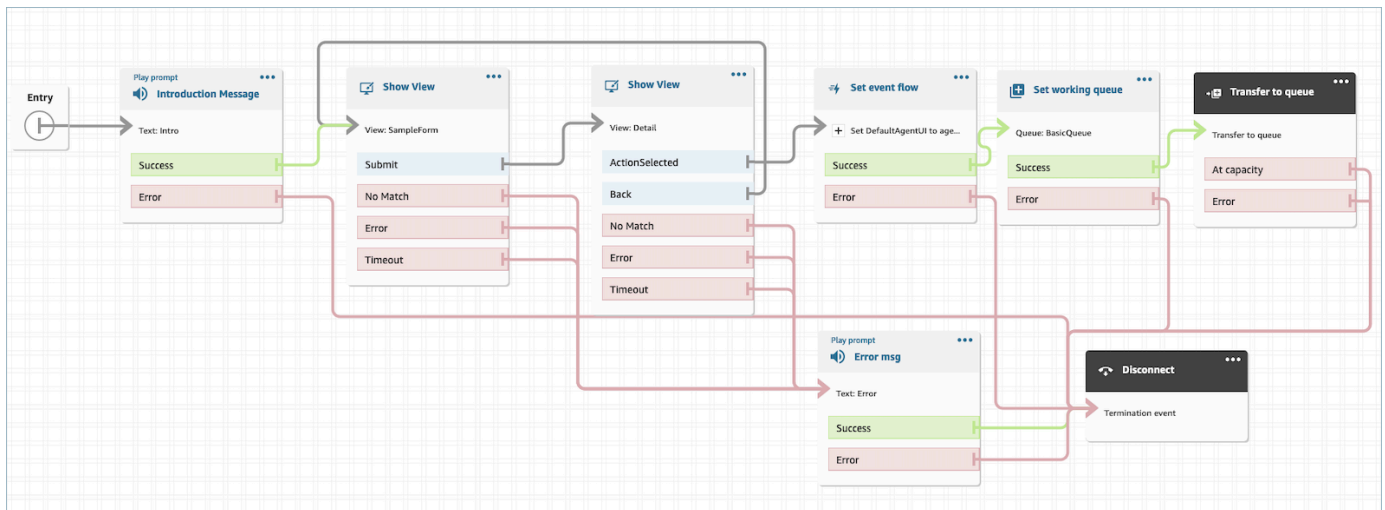

3. Create a hosted chat widget from the admin page. Set the chat flow to the one you created.

Communication options

Choose how your customers can engage with your widget



Chat

Enable a chat experience for your customers. [Learn more](#)

Add chat

This will allow your customers to start a chat.

Allow message receipts

Enable customers to see when messages have been delivered and read.

Chat contact flow

Select the contact flow to initiate for the inbound chat. This will define the experience for your customers when they begin a new chat.

LostLuggageCustomer



Required

This hosted chat will generate a script similar to the following:

```
<script type="text/javascript">
  (function(w, d, x, id){
    s=d.createElement('script');
    s.src='https://d38ij7tdo5kvz7.cloudfront.net/amazon-connect-chat-interface-client.js';
    s.async=1;
    s.id=id;
    d.getElementsByTagName('head')[0].appendChild(s);
    w[x] = w[x] || function() { (w[x].ac = w[x].ac || []).push(arguments) };
  })(window, document, 'amazon_connect', '0b68a091-3538-4dcd-888e-f3b3ae64c5aa');
  amazon_connect('styles', { iconType: 'CHAT', openChat: { color: '#ffffff',
  backgroundColor: '#123456' }, closeChat: { color: '#ffffff', backgroundColor:
  '#123456' } });
  amazon_connect('snippetId',
  'QVFJREFIZ3R0VzRTQkxzUnR6S1BPcXRseVB0UV1vWV1Fc1ZwZmJ5bWZUc1hHVU1SM0FHM3BsdU4yaTZVTW9jeTRqQ
  amazon_connect('supportedMessagingContentTypes', [ 'text/plain', 'text/
  markdown' ]));
</script>
```

The last line contains an array of allowed messages. You can add interactive messages to it to enable Guides within chat. For example:

```
amazon_connect('supportedMessagingContentTypes', ['text/plain',  
  'application/vnd.amazonaws.connect.message.interactive', 'application/  
  vnd.amazonaws.connect.message.interactive.response']);
```

4. Add the following to your allow list of URLs to allow step-by-step Guides to work within chat:

- *your-website-url*/views/renderer/

If you use a CSP for the chat widget to work on your website, you should already have a cloudfront url. For example:

- <https://unique-id.cloudfront.net/amazon-connect-chat-interface.js>

Note

You can also use Guides in chat with a custom build communications widget. For more information about adding step-by-step guides into your custom communications widget, see the [Amazon Connect chat interface](#) on Github.

Display contact attributes in the agent workspace

A simple use case of step-by-step guides is to surface contact attributes to your agents at the start of a contact in order to give them the context they need at the start of the contact so they can dive right into problem solving. This feature is sometimes referred to as a Screen Pop. To implement this use case, follow the example of how to deploy a **Details view**. For more information see [View resource](#).

Disposition codes

A simple use case of step-by-step guides is to have an agent enter a disposition code at the end of the contact. To give your agents the ability to set disposition codes at the end of a contact or

complete other post-call work, create a flow that has one [Show view](#) block and one [Set contact attributes](#) block.

- Use the [Show view](#) block to create a **Form** view that gives the agents the required input field.
- Use the [Set contact attributes](#) block to save the response as contact attributes.

In addition, you can also use an [Invoke AWS Lambda function](#) block to send the entered data to an external system.

After you've created your flow, you will be able to dynamically determine which one to surface at the end of a contact by setting the **DisconnectFlowForAgentUI** as a custom attribute in your contact flows. As long as this attribute is set before a contact ends, the agent UI will surface this form after a contact ends.

The following image shows the properties page for a [Set contact attributes](#). It is configured to save the response in a user-defined attribute.

Set contact attributes

Define and store key-value pairs as contact attributes. [Info](#)

i Contact attributes are accessible by other areas of Amazon Connect, such as the Contact Control Panel (CCP) and Contact Trace Records (CTRs).

Namespace
User defined

Value
DisconnectFlowForAgentUI

Set manually

Value
78598a99-2c07-4627-af8e-6d8ab28fd6

Set dynamically

PII Redaction

By default, any information passed through a guide is included in the contact record transcript. To prevent PII from appearing in your contact record transcript, you will want to use the [Set recording and analytics behavior block](#) in your step-by-step guide contact flow, [enable Contact Lens](#), and enable the redaction of sensitive data.

For full details on how to enable PII redaction, see [Enable redaction of sensitive data](#).

Integrate third-party applications (3p apps) in the agent workspace

Amazon Connect agent workspace is a single, intuitive application that provides your agents with the tools and step-by-step guidance they need to resolve issues efficiently, improve customer experiences, and onboard faster. In addition to using first-party applications in your agent workspace, such as Customer Profiles, Cases, and Amazon Q in Connect, you can integrate third-party applications.

For example, you can integrate your proprietary reservation system or a vendor-provided metrics dashboard, into the Amazon Connect agent workspace.

If you are a developer interested in building a third-party application, see the [Agent Workspace Developer Guide](#).

Contents

- [Onboard third-party applications](#)
- [Security profile permissions for third-party applications](#)
- [Events and Requests](#)
- [Access third-party applications in the agent workspace](#)
- [Set up third-party application SSO Federation](#)

- [Screen pop applications](#)
- [Workshop for building a third-party app](#)

Onboard third-party applications

Requirements

If you're using custom IAM policies to manage access to third-party applications, your users need the following IAM permissions to integrate a third-party application using the AWS Console. In addition to `AmazonConnect_FullAccess`, users need:

```
{
```

```
"Version": "2012-10-17",
"Statement": [
  {
    "Action": [
      "app-integrations:CreateApplication",
      "app-integrations:GetApplication",
      "iam:GetRolePolicy",
      "iam:PutRolePolicy",
      "iam>DeleteRolePolicy"
    ],
    "Resource": "arn:aws:app-integrations:<aws-region>:<aws-account-
Id>:application/*",
    "Effect": "Allow"
  }
]
```

How to integrate a third-party application

Note

To integrate third-party applications into your instances, ensure that your instance is using a Service-Linked Role (SLR). If your instance currently does not use an SLR but you wish to integrate third-party applications, you will need to migrate to an SLR. Third-party applications can only be integrated and used in instances that are using an SLR. For more information, see [For instances created before October 2018](#).

1. Open the Amazon Connect [console](https://console.aws.amazon.com/connect/) (<https://console.aws.amazon.com/connect/>).
2. On the left navigation pane, choose **Third-party applications**. If you do not see this menu, it's because it is not available in your region. To check the regions where this feature is available, see [Availability of Amazon Connect features by Region](#).
3. On the **Third-party applications** page, choose **Add application**.

The screenshot shows the Amazon Connect console interface. At the top, there's a navigation bar with the AWS logo, 'Services', a search bar, and the text '[Option+S]'. Below this, the breadcrumb path is 'Amazon Connect > Third-party applications'. A blue banner at the top of the main content area says 'Enhance the agent workspace experience with third-party apps.' with a cloud icon. Below the banner, the title 'Third-party applications' is followed by a sub-header 'Applications (3)'. A search bar labeled 'Search applications' is positioned above a table. The table has four columns: 'Display name', 'Namespace', 'Associated instances', and 'Last updated'. It lists three applications: 'Maps' (namespace: sample.maps, 1 instance, updated 9/14/2023), 'Notes' (namespace: sample.connect.notes, 1 instance, updated 8/23/2023), and 'Scheduling' (namespace: sample.notes, 1 instance, updated 9/15/2023). On the right side of the table, there are 'View details' and 'Edit' buttons. In the bottom left corner, there are two toggle switches: 'Enable Dark Mode' and 'Use System Preferences'.

4. On the **Add application** page, enter:

a. **Basic information**

- i. **Display name:** A friendly name for the application. This name will display on security profiles and to your agents on the tab within the agent workspace. You may come back and change this name.
- ii. **Namespace:** The official name that is unique for your application. If you have only one application per access URL, we recommend that you use the origin of the access URL. You may not change this name.
- iii. **Description (optional):** You may optionally provide any description for this application. This description will not display to agents.

b. **Access**

- i. **Access URL:** This is the URL where your application is hosted. The URL must be secure, starting with https, unless it's a local host.

Note

Not all URLs can be iframed. Here are two ways to check if the URL can be iframed:

- i. There is a third-party tool available to help check if a URL can be iframed that is called [Iframe Tester](#).
 - A. If a URL can be iframed, it will render in a preview on this page.
 - B. If a URL cannot be iframed, it will display an error in the preview on this page.
 - It is possible that this website displays an error, and the app can still be iframed in the agent workspace. This is because the app developer can lock down their app to only be embeddable into the workspace and nowhere else. If you received this app from an app developer, we recommend that you still try integrating this app into the agent workspace.
- ii. For technical users: Check the security policy content of the application you are trying to integrate.
 - A. Firefox: Hamburger menu > More tools > Web developer tools > Network
 - B. Chrome: 3 dots menu > More tools > Developer tools > Network
 - C. Other browsers: Locate the network settings in the developer tools.
 - D. The Content-Security-Policy frame-ancestors directive should be `https://your-instance.my.connect.aws`.
 - If the directive is same origin or deny, then this URL cannot be iframed by AWS/Amazon Connect

Here's what you can do if the app cannot be iframed:

- If you control the app/URL, you can update the app's content security policy. Follow the best practices for app developers/ Ensuring that apps can only be embedded in the Connect agent workspace section [here](#).
- If you do not control the app/URL, you can try reaching out to the app developer and asking them to update the app's content security policy.

- ii. **Approved origins (optional):** Allowlist URLs that should be permitted, if different than the access URL. The URL must be secure, starting with https, unless it's a local host.
- c. Add permissions to [events and requests](#).

The following is an example of how you can onboard a new application and assign permissions to it by using the AWS Console. In this example, six different permissions are assigned to the application.

Providing basic information and access details

- d. **Instance association**
 - i. You may give any instance(s) within this account-region access to this application.
 - ii. While associating the application to an instance is optional, you will not be able to use this application until you associate it with instance(s).

Granting permissions to the application for workspace data integration

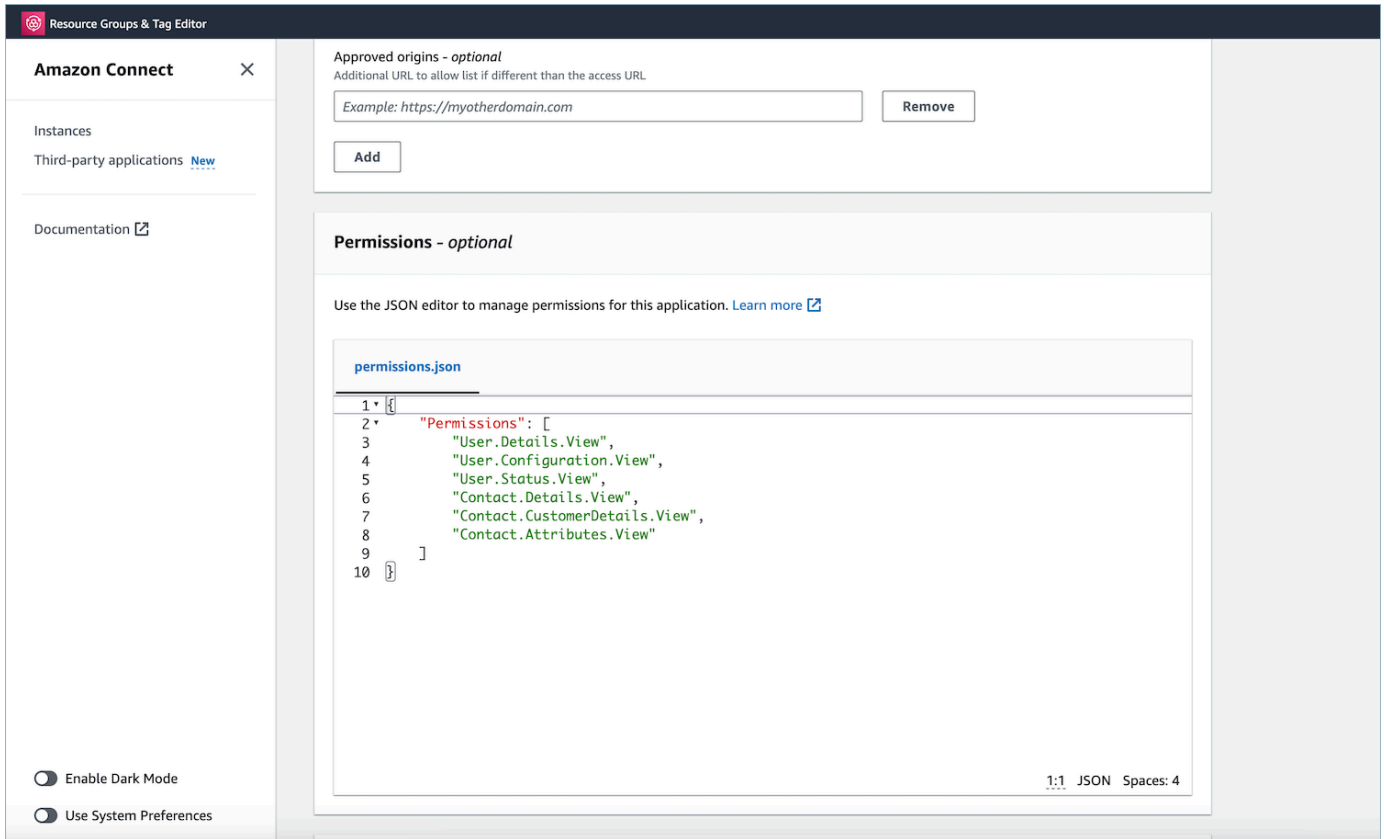

5. Choose **Save**.
6. If the application was successfully created, you will be returned to the **Third-party applications** page, you will see a success banner, and you should see the application on the list.

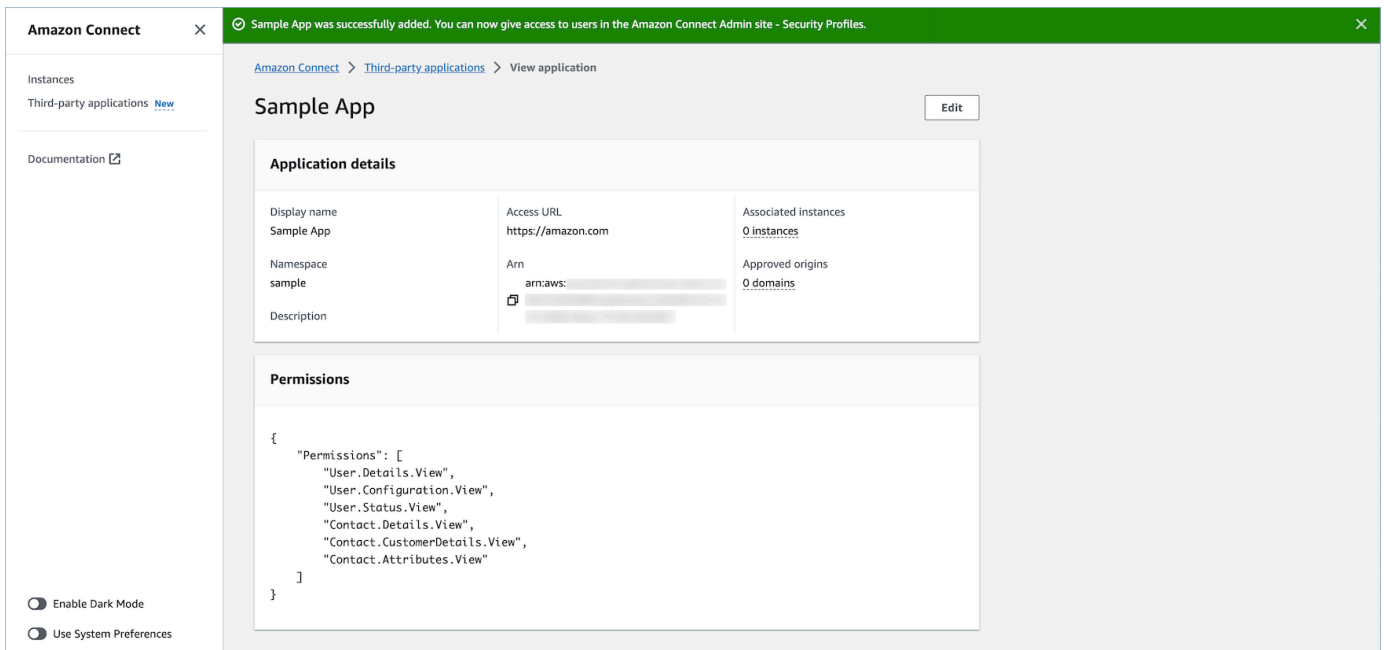

You can edit certain attributes of an existing app, such as its Display Name, Access URL, and Permissions.

- If there was an error in either creating the application or associating the application to an instance, then you will see an error message, and you can take the corresponding action to correct the issue.

Delete third-party applications

If you no longer want to use a third-party application in the foreseeable future, you can delete it. If you temporarily want to stop using it, but you may want to use it again in the foreseeable future, we recommend that you disassociate it from an instance to avoid having to add it again. To delete third-party applications, navigate to the AWS console, select an application, and choose **Delete**.

Troubleshooting

- The operation will fail if the application is associated with any instance. You will first have to disassociate the application from any instance. Then you can come back and delete.

Tip

If you created an application before Dec 15, 2023, then you may encounter issues when updating the association of the application to instance(s). This is because you need to make updates to your IAM policy.

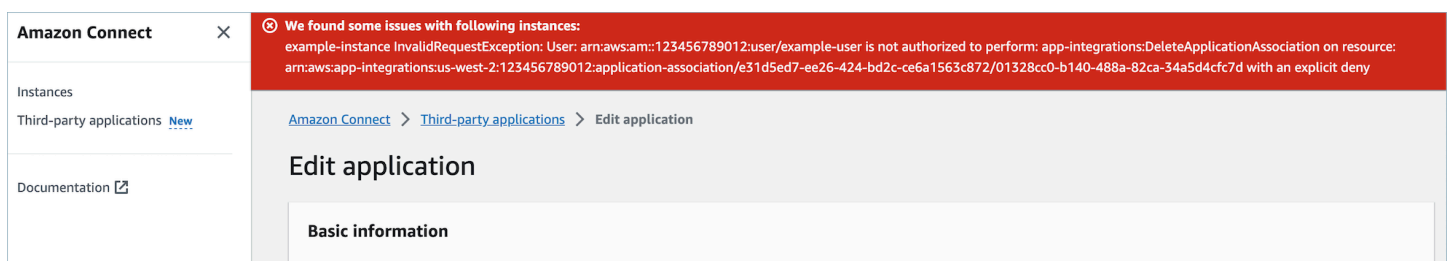

The screenshot shows the Amazon Connect console interface. On the left is a navigation sidebar with 'Amazon Connect' at the top, followed by 'Instances', 'Third-party applications' (with a 'New' button), and 'Documentation'. The main content area has a red error banner at the top that reads: 'We found some issues with following instances: example-instance InvalidRequestException: User: arn:aws:iam::123456789012:user/example-user is not authorized to perform: app-integrations:DeleteApplicationAssociation on resource: arn:aws:app-integrations:us-west-2:123456789012:application-association/e31d5ed7-ee26-424-bd2c-ce6a1563c872/01328cc0-b140-488a-82ca-34a5d4cfc7d with an explicit deny'. Below the error banner is a breadcrumb trail: 'Amazon Connect > Third-party applications > Edit application'. The main heading is 'Edit application', and the first section is 'Basic information'.

Your IAM policy will need to be updated to include the following permissions:

- `app-integrations:CreateApplicationAssociation`
- `app-integrations>DeleteApplicationAssociation`

```

{
  "Version": "2012-10-17",
  "Statement": [
    {
      "Action": [
        "app-integrations:CreateApplication",
        "app-integrations:GetApplication"
      ],
      "Resource": "arn:aws:app-integrations:<aws-region>:<aws-account-Id>:application/*",
      "Effect": "Allow"
    },
    {
      "Action": [
        "app-integrations:CreateApplicationAssociation",
        "app-integrations>DeleteApplicationAssociation"
      ],
      "Resource": "arn:aws:app-integrations:<aws-region>:<aws-account-Id>:application-association/*",
      "Effect": "Allow"
    },
    {
      "Action": [
        "iam:GetRolePolicy",
        "iam:PutRolePolicy",
        "iam>DeleteRolePolicy"
      ],
      "Resource": "arn:aws:iam::<aws-account-Id>:role/aws-service-role/connect.amazonaws.com/AWSServiceRoleForAmazonConnect_*",
      "Effect": "Allow"
    }
  ]
}

```

Security profile permissions for third-party applications

This topic describes the security profiles permissions that are required to access third-party applications that you have onboarded and associated. For a list of third-party application permissions and their API name, see [List of security profile permissions](#).

Third-party application permissions

Note

After associating an application to an instance, you may have to wait up to 10 minutes to see the application appear the security profiles **Agent Applications** menu.

Any applications that you have onboarded to AWS and associated with your Amazon Connect instance will appear on the security profiles **Agent Applications** menu, as in the following image:

Agent Applications						
These permissions are for agent experiences.						
Type	All	Access	View	Edit	Create	Delete
Wisdom	<input type="checkbox"/>	<input type="checkbox"/>	<input checked="" type="checkbox"/>	<input type="checkbox"/>	<input type="checkbox"/>	<input type="checkbox"/>
Custom views ⓘ	<input type="checkbox"/>	<input checked="" type="checkbox"/>	<input type="checkbox"/>	<input type="checkbox"/>	<input type="checkbox"/>	<input type="checkbox"/>
Maps	<input type="checkbox"/>	<input checked="" type="checkbox"/>	<input type="checkbox"/>	<input type="checkbox"/>	<input type="checkbox"/>	<input type="checkbox"/>
Notes	<input type="checkbox"/>	<input checked="" type="checkbox"/>	<input type="checkbox"/>	<input type="checkbox"/>	<input type="checkbox"/>	<input type="checkbox"/>

Note

You will also need to give access to the CCP in order for the app launcher menu to appear.

Contact Control Panel (CCP)

This allows various levels of access to the Call Control Panel (CCP).

Type	Access
Access Contact Control Panel	<input checked="" type="checkbox"/>

After you have given permissions, you can review how to [Access third-party applications in the agent workspace](#).

Events and Requests

App permissions

Note

If you are a developer, review how to create applications that react to events [here](#).

When you onboard the applications by using the API or the onboardingUI in the AWS Console, you must explicitly give third-party applications permissions to Amazon Connect data. You can also edit the permissions on an existing app.

To understand the effects of assigning a particular permission, please review the below permissions, description, and corresponding requests and events. As an example: If you assign the permission `User.Details.View` to the application, then it will have the ability to make the following requests: `agent.getName` and `agent.getARN`. If your app attempts to subscribe to an event or make a request for data that it does not have permission for, your app may not function as intended. To learn more about each request and event, see the [API Reference](#).

Permission	Description	Requests	Events
<code>User.Details.View</code>	Details about the agent, such as their full name and User ARN	<code>agent.getName</code> <code>agent.getARN</code>	
<code>User.Configuration.View</code>	Configuration information about the agent, such as their associated routing profile	<code>agent.getRoutingProfile</code> <code>agent.getChannelConcurrency</code> <code>agent.getDialableCountries</code> <code>agent.getExtension</code> <code>getLanguage</code>	<code>onLanguageChanged</code>

Permission	Description	Requests	Events
User.Status.View	Details about the agent's status	agent/getState	agent/onStateChanged
Contact.Details.View	Details about the contact available in the workspace	contact/getInitialContactId contact/getType contact/getStateDuration contact/getQueue contact/getQueueTimestamp	contact/onDestroyed contact/onMissed contact/onStartingAcw contact/onConnected
Contact.CustomerDetails.View	Details about your customers, such as the phone number they're calling from (Voice only)	contact/getPhoneNumber	
Contact.Attributes.View	Metadata about the contact	contact/getAttribute contact/getAttributes	

Access third-party applications in the agent workspace

Important things to know

- We are aware of the **Google Chrome** Third-Party Cookies Deprecation (3PCD) that may impact the third-party applications experience. If you are using third-party apps in the Amazon Connect Agent workspace on the Chrome browser, we recommend that you:
 - Temporary solution:** Update [Enterprise Chrome policies](#)). You can set `BlockThirdPartyCookies` Policy to false and safeguard your agent experience from immediate impact due to 3P Cookie Deprecation.

- **Permanent solution:** We recommend that app developers follow [best practices](#) that will continue to pass third-party cookies.
- You must have [integrated the application](#) and the agent must have [access to the application](#) by using security profiles. The agent must also have access to the CCP in order for the application launcher to appear.

Use the app launcher to access third-party applications

Agents can access third-party applications in the agent workspace by using the apps launcher, shown in the following image. The apps launcher appears on the agent workspace after you have successfully [onboarded](#) your third-party app.

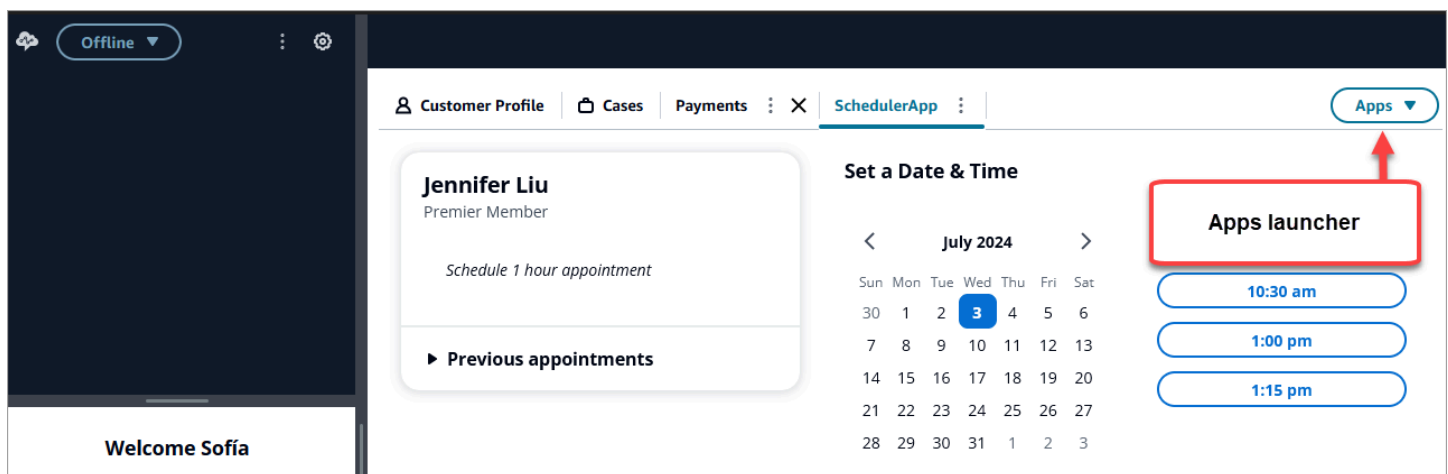

The app launcher shows a list of applications that the agent has access to.

The agent can launch applications when they don't have any contacts (they are in the idle state) or when they are on a contact (call, chat, or task). After an app is opened for a given contact, it stays open until that contact is closed.

Required security profile permissions to access third-party applications

Agents need the following security profiles permissions to access third-party apps:

- **Contact Control Panel (CCP) - Access the CCP**
- Access to at least one third-party application - it appears in the security profile page after you have successfully [onboarded](#) your third-party app.

Pin apps on the agent workspace

Agents can pin an app as open. On the apps tab, choose the More icon and then select **Pin tab**, as shown in the following image.



After an app is pinned, it stays open in the idle state and pops open for any contacts that come in. The app stays pinned for that user and browser until the user clears the cookies on the browser.

An agent can unpin the tab if they no longer want this app to always be open; they will still be able to open and close the app as needed.

Examples of apps pinned on the agent workspace

The following image shows an example of a third-party app named NoteTest that is pinned to the agent workspace.

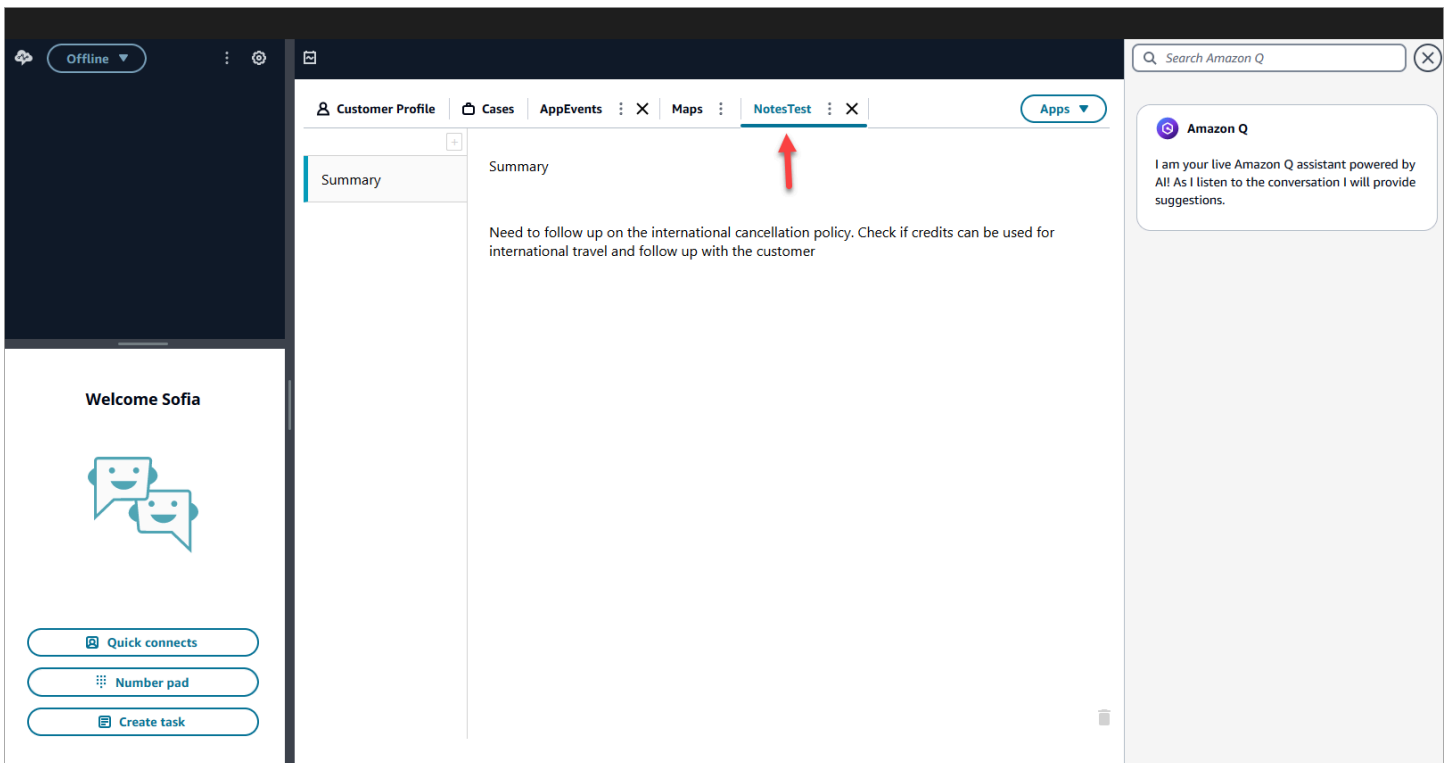

The following image shows an example of a third-party app named Maps that is pinned to the agent workspace.

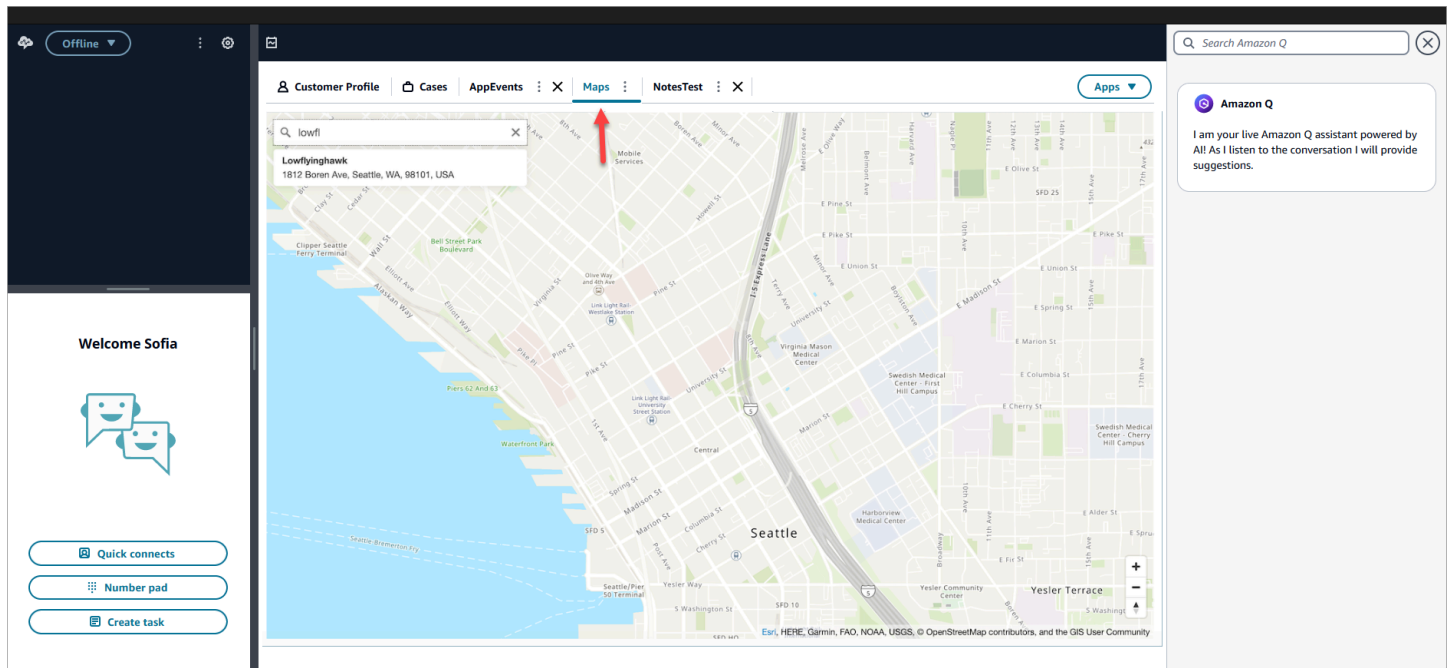

Set up third-party application SSO Federation

A user can use Single-Sign-On to federate into multiple third-party applications that have been setup within their Amazon Connect instance without the need to authenticate separately for each application.

Note

Your third-party (3P) application can seamlessly complete the Sign-On flow within an iframe, provided that the Identity Provider supports iframing their sign-in page. Refer to the Identity Provider guides for detailed information on iframing capabilities.

Setup SSO for third-party apps that exist within your Amazon Connect instances

1. Set up an Identity Provider or use an existing Identity Provider.
2. Set up users within the Identity Provider.
3. Set up an Amazon Connect instance and [Configure SAML with IAM for Amazon Connect](#).
4. Set up other applications within your Identity Provider which you will be integrating with your Amazon Connect instance.
5. Attach each individual user identity to any applications within the Identity Provider that will be integrated with your Amazon Connect instance. You can control which agent has access to an

application on the Amazon Connect agent workspace by providing more granular application specific permissions in security profiles. For more information, see [Security profile permissions for third-party applications](#).

6. After a user has signed into their Identity Provider, they can federate into their Amazon Connect instance which has third-party applications configured and they can federate into each application (if the application has been setup for SSO) without the need of their username and password.

Use Amazon Q in Connect for generative AI-powered agent assistance in real-time

Note

Powered by Amazon Bedrock: AWS implements [automated abuse detection](#). Because Amazon Q in Connect is built on Amazon Bedrock, users can take full advantage of the controls implemented in Amazon Bedrock to enforce safety, security, and the responsible use of artificial intelligence (AI).

Amazon Q in Connect is a generative AI customer service assistant. It is an LLM-enhanced evolution of Amazon Connect Wisdom that delivers real-time recommendations to help contact center agents resolve customer issues quickly and accurately.

Amazon Q in Connect automatically detects customer intent during calls and chats using conversational analytics and natural language understanding (NLU). It then provides agents with immediate, real-time generative responses and suggested actions. It also provides links to relevant documents and articles.

In addition to receiving automatic recommendations, agents can also query Amazon Q directly using natural language or keywords to answer customer requests. Amazon Q works right within the Amazon Connect agent workspace.

Amazon Q in Connect is available by API to be used in an existing agent workspace. For more information, see the [Amazon Q in Connect API Reference Guide](#).

Note

To use Amazon Q in Connect with calls, you must enable Amazon Connect Contact Lens. Contact Lens is not required to use Amazon Q in Connect with chats.

Amazon Q in Connect can be used in compliance with GDPR and is HIPAA eligible.

The following image shows how an article may appear in the agent application when the agent is on a call.

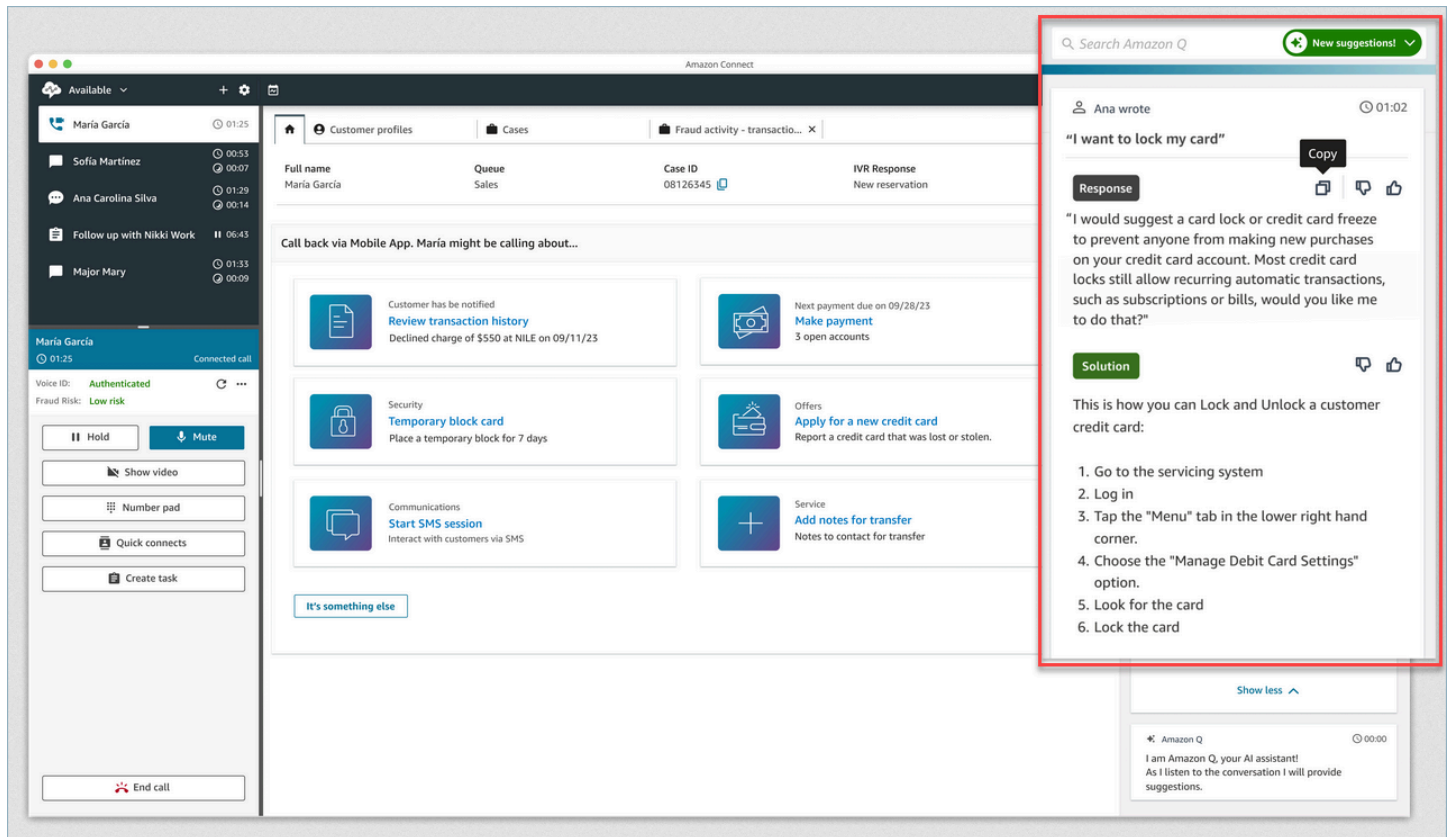

1. The agent is on a call.
2. The agent can ask natural-language questions.
3. Amazon Q in Connect provides a response that the agent can share directly with the customer. For example, they can copy and paste the response into a chat, or read it over the call.
4. Amazon Q in Connect provides more information for the agent, for example, a summary of the solution or of the next steps they should take.
5. Amazon Q in Connect provides links to specific articles.

Enable Amazon Q in Connect for your instance

There are two ways you can enable Amazon Q in Connect:

- Use the Amazon Connect console. There are instructions on this page.
- Use the [Amazon Q in Connect API](#) to ingest content.

The following sections explain how to use the Amazon Connect console to enable Amazon Q in Connect. Follow them in the order listed. If you want to use the Amazon Q in Connect API, we assume you have the necessary programming skills.

Contents

- [Supported content types](#)
- [Integration overview](#)
- [Before you begin](#)
- [Step 1: Create an Amazon Q in Connect domain](#)
- [Step 2: Encrypt the domain](#)
- [Step 3: Create an integration \(knowledge base\)](#)
- [Step 4: Configure your flow for Amazon Q in Connect](#)
- [When was your knowledge base last updated?](#)

Supported content types

Amazon Q in Connect supports the ingestion of HTML, Word, PDF, and text files up to 1 MB. Note the following:

- Plain text files must be in UTF-8.
- Word documents must be in DOCX format.
- Word documents are automatically converted to simplified HTML and will not retain the source document's font family, size, color, highlighting, alignment, or other formatting such as background colors, headers or footers.
- PDF files cannot be encrypted or password protected.
- Actions and scripts embedded into PDF files are not supported.

For a list of adjustable quotas, such as the number of quick responses per knowledge base, see [Amazon Q in Connect service quotas](#).

Integration overview

You follow these broad steps to enable Amazon Q in Connect:

1. Create an Amazon Q in Connect domain (assistant). A domain consists of a single knowledge base, such as Salesforce or Zendesk.
2. Create an encryption key to encrypt the excerpts that are provided in the recommendations to the agent.
3. Create a knowledge base using external data:
 - Add data integrations from Amazon S3, Microsoft SharePoint Online, [Salesforce](#), [ServiceNow](#), and ZenDesk using prebuilt connectors in the Amazon Connect console.
 - Encrypt the content importing from these applications using a KMS key.
 - For certain integrations, specify the sync frequency.
 - Review the integration.
4. Configure your flow.
5. Assign permissions.

Before you begin

Following is an overview of key concepts and the information that you'll be prompted for during the setup process.

About the Amazon Q in Connect domain

When you enable Amazon Q in Connect, you create an Amazon Q in Connect *domain*: an assistant that consists of one knowledge base. Follow these guidelines when creating domains:

- You can create multiple domains, but they don't share external application integrations or customer data between each other.
- You can associate each domain with one or more Amazon Connect instances, but you can only associate an Amazon Connect instance with one domain.

Note

If you want to use multiple data sources, we recommend collecting the data in Amazon Simple Storage Service and using that as your domain.

- All the external application integrations you create are at a domain level. All of the Amazon Connect instances associated with a domain inherit the domain's integrations.

- You can associate your Amazon Connect instance with a different domain at any time by choosing a different domain.

How to name your Amazon Q in Connect domain

When you enable Amazon Q in Connect, you are prompted to provide a friendly domain name that's meaningful to you, such as your organization name.

(Optional) Create AWS KMS keys to encrypt the domain and the content

When you enable Amazon Q in Connect, by default the domain and connection are encrypted with an AWS owned key. However, if you want to manage the keys, you can create or provide two [AWS KMS keys](#):

- Use one key for the Amazon Q in Connect domain, used to encrypt the excerpt provided in the recommendations.
- Use the second key to encrypt the content imported from Amazon S3, Microsoft SharePoint Online, Salesforce, ServiceNow, or ZenDesk. Note that Amazon Q in Connect search indices are always encrypted at rest using an AWS owned key.

To create KMS keys, follow the steps in [Step 1: Create an Amazon Q in Connect domain](#), later in this section.

Your customer managed key is created, owned, and managed by you. You have full control over the KMS key, and AWS KMS charges apply.

If you choose to set up a KMS key where someone else is the administrator, the key must have a policy that allows `kms:CreateGrant`, `kms:DescribeKey`, and `kms:Decrypt` and `kms:GenerateDataKey*` permissions to the IAM identity using the key to invoke Amazon Q in Connect. To use Amazon Q in Connect with chat, the key policy for your Amazon Q in Connect domain must allow `kms:Decrypt`, `kms:GenerateDataKey*`, and `kms:DescribeKey` permissions to the `connect.amazonaws.com` service principal.

Note

To use Amazon Q in Connect with chat, the key policy for your Amazon Q in Connect domain must grant the `connect.amazonaws.com` service principal the following permissions;

- kms:GenerateDataKey*
- kms:DescribeKey
- kms:Decrypt

For information about how to change a key policy, see [Changing a key policy](#) in the *AWS Key Management Service Developer Guide*.

Step 1: Create an Amazon Q in Connect domain

The following steps explain how to add a domain to an Amazon Connect instance, and how to add an integration to the domain. To complete these steps, you must have an instance without a domain.

1. Open the Amazon Connect console at <https://console.aws.amazon.com/connect/>.
2. On the **Amazon Connect virtual contact center instances** page, under **Instance alias**, choose the name of the instance. The following image shows a typical instance name.

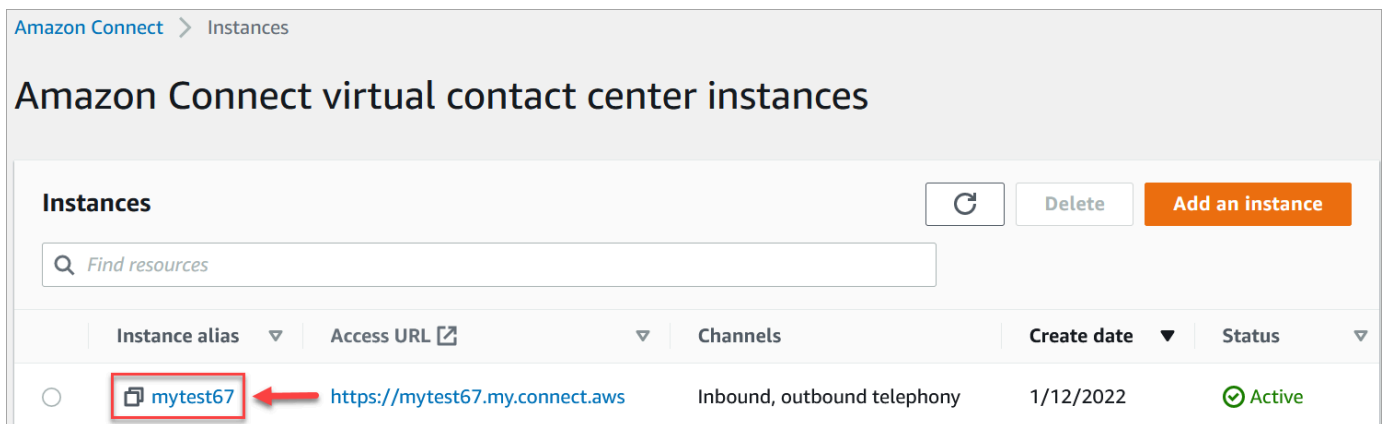

3. In the navigation pane, choose **Amazon Q**, and then choose **Add domain**.
4. On the **Add domain** page, choose **Create a domain**.
5. In the **Domain name** box, enter a friendly name, such as your organization name.

Add domain
Use a new or existing Amazon Q domain to enable Amazon Q for your instance.

Domain setup

Choose domain method

Create a new domain
Use a new domain to enable Amazon Q for your instance.

Domain name

Amazon_Q_in_Connect_Domain

Must be between 1 and 1024 characters. Valid characters are a-z, A-Z, 0-9, -

6. Keep the page open and go to the next step.

Step 2: Encrypt the domain

You can use the Amazon Connect default key to encrypt your domain. You can also use an existing key, or you can create keys that you own. The following sets of steps explain how to use each type of key. Expand each section as needed.

Use the default key

1. Under **Encryption**, clear the **Customize encryption settings** checkbox.
2. Choose **Add domain**.

Use an existing key

1. Under **Encryption**, open the **AWS KMS key** list and select the desired key.
2. Choose **Add domain**.

Note

To use an existing key with Amazon Connect chat, you must grant the `connect.amazonaws.com` service principal the `kms:Decrypt`, `kms:GenerateDataKey*`, and `kms:DescribeKey` permissions.

The following example shows a typical policy.

```
{
  "Id": "key-consolepolicy-3",
  "Version": "2012-10-17",
  "Statement": [
    {
      "Effect": "Allow",
      "Principal": {
        "AWS": "arn:aws:iam::your_accountId:root"
      },
      "Action": "kms:*",
      "Resource": "*"
    },
    {
      "Effect": "Allow",
      "Principal": {
        "Service": "connect.amazonaws.com"
      },
      "Action": [
        "kms:Decrypt",
        "kms:GenerateDataKey*",
        "kms:DescribeKey"
      ],
      "Resource": "*"
    }
  ]
}
```

Create an AWS KMS key

1. On the **Add domain** page, under **Encryption**, choose **Create an AWS KMS key**.

Encryption

Your data is encrypted by default with a key that AWS owns and manages for you. To choose a different key, customize your encryption settings. [Info](#)

Customize encryption settings (advanced)
To use the default key, disable this option.

AWS KMS key
Choose a key that you have permission to use, or create one.

[Create an AWS KMS key](#)

That takes you to the Key Management Service (KMS) console. Follow these steps:

- In the KMS console, on the **Configure key** page, choose **Symmetric**, and then choose **Next**.

KMS > Customer managed keys > Create key

Step 1
Configure key

Step 2
Add labels

Step 3
Define key administrative permissions

Step 4
Define key usage permissions

Step 5
Review and edit key policy

Configure key

Key type [Help me choose](#)

Symmetric
A single encryption key that is used for both encrypt and decrypt operations

Asymmetric
A public and private key pair that can be used for encrypt/decrypt or sign/verify operations

► **Advanced options**

Cancel **Next**

- On the **Add labels** page, enter an alias and description for the KMS key, and then choose **Next**.

KMS > [Customer managed keys](#) > Create key

Step 1
[Configure key](#)

Step 2
Add labels

Step 3
Define key administrative permissions

Step 4
Define key usage permissions

Step 5
Review

Add labels

Alias
You can change the alias at any time. [Learn more](#)

Alias

Description - optional
You can change the description at any time.

Description

- c. On the **Define key administrative permissions** page, choose **Next**, and on the **Define key usage permissions** page, choose **Next** again.
- d. On the **Review and edit key policy** page, scroll down to **Key policy**.

Note

To use Amazon Q in Connect with chat, modify the key policy to allow the `kms:Decrypt`, `kms:GenerateDataKey*`, and `kms:DescribeKey` permissions to the `connect.amazonaws.com` service principal. The following code shows a sample policy.

```
{
  "Id": "key-consolepolicy-3",
  "Version": "2012-10-17",
  "Statement": [
    {
      "Effect": "Allow",
      "Principal": {
        "AWS": "arn:aws:iam::your_accountId:root"
      },
      "Action": "kms:*",
      "Resource": "*"
    },
    {
      "Effect": "Allow",
```

```

    "Principal": {
      "Service": "connect.amazonaws.com"
    },
    "Action": [
      "kms:Decrypt",
      "kms:GenerateDataKey*",
      "kms:DescribeKey"
    ],
    "Resource": "*"
  }
]
}

```

- e. Choose **Finish**.

In the following example, the name of the KMS key starts with **9059f488**.

KMS > Customer managed keys

Customer managed keys (1)

Filter keys by properties or tags

<input type="checkbox"/>	Aliases	Key ID	Status	Key type	Key spec	Key usage
<input type="checkbox"/>	AmazonQinConnect	9059f488-...	Enabled	Symmetric	SYMMETRIC_DEFAULT	Encrypt and decrypt

2. Return to the **Amazon Q in Connect** browser tab, open the **AWS KMS key** list, and select the key that you created in the previous steps.

Encryption

Your data is encrypted by default with a key that AWS owns and manages for you. To choose a different key, customize your encryption settings. [Info](#)

Customize encryption settings (advanced)
To use the default key, disable this option.

AWS KMS key
Choose a key that you have permission to use, or create one.

Choose an AWS KMS key or enter an ARN

9059f488-
AmazonQinConnect

Create an AWS KMS key

3. Choose **Add domain**.

Step 3: Create an integration (knowledge base)

1. On the **Amazon Q** page, choose **Add integration**.
2. On the **Add integration** page, choose **Create a new integration**, and then select a source.

Add integration [Info](#)

Choose a data source for this integration and establish a connection to import your content to Wisdom.

Integration setup

Choose integration method

Create a new integration
Create a new integration and select object fields

Use an existing integration
Reuse an existing integration with object fields

Source

Q |

Salesforce

ServiceNow

Zendesk

Microsoft SharePoint Online

Cancel **Next**

The steps for creating an integration vary, depending on the source that you choose. Expand the following sections as needed to finish creating an integration.

Create a Salesforce integration

You follow a multi-step process to create a Salesforce integration. The following sections explain how to complete each step.

Step 1: Add the integration

1. Select all the checkboxes that appear. This acknowledges that you set up your Salesforce account properly:

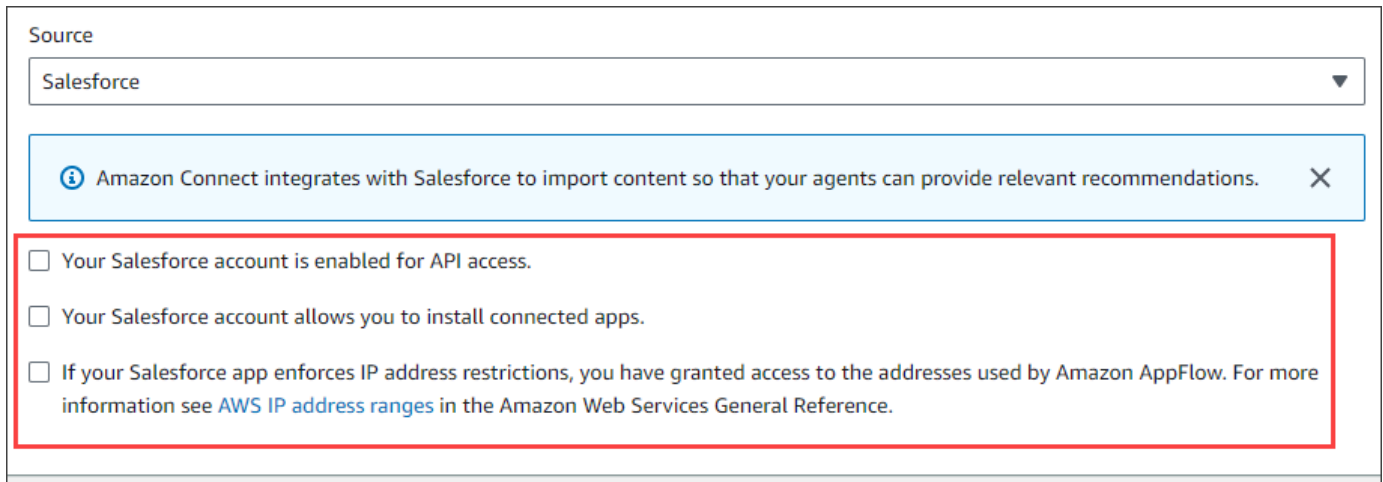

Source

Salesforce

Amazon Connect integrates with Salesforce to import content so that your agents can provide relevant recommendations.

- Your Salesforce account is enabled for API access.
- Your Salesforce account allows you to install connected apps.
- If your Salesforce app enforces IP address restrictions, you have granted access to the addresses used by Amazon AppFlow. For more information see [AWS IP address ranges](#) in the Amazon Web Services General Reference.

2. In the **Integration name** box, enter a name for the integration.

Tip

If you create multiple integrations from the same source, we recommend you develop a naming convention to make the names easy to distinguish.

3. Select **Use an existing connection**, open the **Select an existing connection** list and choose a connection, then choose **Next**.

—OR—

Select **Create a new connection** and follow these steps:

- a. Choose **Production** or **Sandbox**.
 - b. In the **Connection name** box, enter the name of your connection. The name is your Salesforce URL without the **https://**.
 - c. Choose **Connect**, sign in to Salesforce, and when prompted, choose **Allow**.
4. Under **Encryption**, open the **AWS KMS Key** list and choose a key.

—OR—

Choose **Create an AWS KMS Key** and follow the steps listed in [Create an AWS KMS key](#), earlier in this section.

5. (Optional) Under **Sync frequency**, open the **Sync frequency** list and select and select a synchronization interval. The system defaults to an hour.

6. (Optional) Under **Ingestion start date**, choose **Ingest records created after**, then select a start date. The system defaults to ingesting all records.
7. Choose **Next** and follow the steps in the next section of this topic.

Step 2: Select objects and fields

Tip

If you create multiple integrations from the same source, we recommend you develop a naming convention to make the names easy to distinguish.

1. On the **Select objects and fields** page, open the **Available objects** list and select an object. Only knowledge objects appear in the list.
2. Under **Select fields for *object name***, select the fields that you want to use.

Note

By default, the system automatically selects all required fields.

3. Choose **Next**.

Step 3: Review and add the integration

- Review the settings for the integration. When finished, choose **Add integration**.

Create a ServiceNow integration

1. Under **Integration setup**, select the checkbox next to **Read and acknowledge that your ServiceNow account meets the integration requirements..**
2. In the **Integration name** box, enter a name for the integration.

Tip

If you create multiple integrations from the same source, we recommend you develop a naming convention to make the names easy to distinguish.

3. Select **Use an existing connection**, open the **Select an existing connection** list and choose a connection, then choose **Next**.

—OR—

Select **Create a new connection** and follow these steps:

- a. In the **User name** box, enter your ServiceNow user name. You must have administrator permissions.
- b. In the **Password** box, enter your password.
- c. In the **Instance URL** box, enter your ServiceNow URL.
- d. In the **Connection name** box, enter a name for the connection.
- e. Choose **Connect**.
- f. Under **Encryption**, open the **AWS KMS Key** list and choose a key.

—OR—

Choose **Create an AWS KMS Key** and follow the steps listed in [Create an AWS KMS key](#), earlier in this section.

- g. (Optional) Under **Sync frequency**, open the **Sync frequency** list and select and select a synchronization interval. The system defaults to an hour.
 - h. (Optional) Under **Ingestion start date**, choose **Ingest records created after**, then select a start date. The system defaults to ingesting all records.
 - i. Choose **Next**.
4. Select the fields for the knowledge base. The following fields are required:
 - short_description
 - number
 - workflow_state
 - sys_mod_count
 - active
 - text
 - sys_updated_on
 - wiki

5. Choose **Next**.
6. Review your settings, change them as needed, then choose **Add integration**.

Create a Zendesk integration

Prerequisites

You must have the following items to connect to Zendesk:

- A client ID and a client secret. You obtain the ID and secret by registering your application with Zendesk and enabling an OAuth authorization flow. For more information, see [Using OAuth authentication with your application](#) on the Zendesk support site.
- In Zendesk, a Redirect URL configured with `https://[AWS REGION].console.aws.amazon.com/connect/v2/oauth`. For example, `https://ap-southeast-2.console.aws.amazon.com/connect/v2/oauth`.

Once you have those items, follow these steps:

1. Under **Integration setup**, select the checkboxes and enter a name for the integration.

Tip

If you create multiple integrations from the same source, we recommend you develop a naming convention to make the names easy to distinguish.

2. Select **Use an existing connection**, open the **Select an existing connection** list and choose a connection, then choose **Next**.

—OR—

Select **Create a new connection** and follow these steps:

- a. Enter a valid client ID, client secret, account name, and connection name in their respective boxes, then choose **Connect**.
- b. Enter your email address and password, then choose **Sign in**.
- c. On the pop-up that appears, select **Allow**.
- d. Under **Encryption**, open the **AWS KMS Key** list and choose a key.

—OR—

Choose **Create an AWS KMS Key** and follow the steps listed in [Create an AWS KMS key](#), earlier in this section.

3. (Optional) Under **Sync frequency**, open the **Sync frequency** list and select and select a synchronization interval. The system defaults to an hour.
4. (Optional) Under **Ingestion start date**, choose **Ingest records created after**, then select a start date. The system defaults to ingesting all records.
5. Choose **Next**.
6. Select the fields for the knowledge base, then choose **Next**.
7. Review your settings, change them as needed, then choose **Add integration**.

After you create the integration, you can only edit its URL.

Create a SharePoint Online integration

1. Under **Integration setup**, select the checkbox and enter a name for the integration.

Tip

If you create multiple integrations from the same source, we recommend you develop a naming convention to make the names easy to distinguish.

2. Under **Connections with Microsoft SharePoint Online**, open the **Select an existing connection** list and choose a connection, then choose **Next**.

—OR—

Select **Create a new connection** and follow these steps:

- a. Enter your tenant ID in both boxes, enter a connection name, then choose **Connect**.
- b. Enter your email address and password to sign in to SharePoint.
- c. Under **Encryption**, open the **AWS KMS Key** list and choose a key.

—OR—

- Choose **Create an AWS KMS Key** and follow the steps listed in [Create an AWS KMS key](#), earlier in this section.
- d. Under **Sync frequency**, accept the default or open the **Sync frequency** list and select and select a synchronization interval.
 - e. Choose **Next**.
3. Under **Select Microsoft SharePoint Online site**, open the list and select a site.
 4. Under **Select folders from *site name***, select the folders that you want to include in your domain, then choose **Next**.
 5. Review your settings, change them as needed, then choose **Add integration**.

Create an Amazon Simple Storage Service integration

1. In the **Integration name** box, enter a name for your integration.

Tip

If you create multiple integrations from the same source, we recommend you develop a naming convention to make the names easy to distinguish.

2. Under **Connections with Microsoft SharePoint Online**, open the **Select an existing connection** list and choose a connection, then choose **Next**.

—OR—

Under **Connection with S3**, enter the URI of your Amazon S3 bucket, then choose **Next**.

—OR—

Choose **Browse S3**, use the search box to find your bucket, select the button next to it, then select **Choose**.

3. Under **Encryption**, open the **AWS KMS Key** list and choose a key.

—OR—

Choose **Create an AWS KMS Key** and follow the steps listed in [Create an AWS KMS key](#), earlier in this section.

4. Choose **Next**.

5. Review your settings, change them as needed, then choose **Add integration**.

Note

- If you delete objects from SaaS applications, such as Salesforce and ServiceNow, Amazon Q in Connect does not process those deletions. You must archive objects in Salesforce and retire articles in ServiceNow to remove them from those knowledge bases.
- For Zendesk, Amazon Q in Connect does not process hard deletes or archives of articles. You must unpublish articles in Zendesk to remove them from your knowledge base.
- For Microsoft SharePoint Online, you can select a maximum of 10 folders.
- Amazon Q automatically adds an `AmazonConnectEnabled:True` tag to the Amazon Q resources associated with your Amazon Connect instance, such as a knowledge base and an Assistant. It does this to authorize the access from Amazon Connect to Amazon Q resources. This action is a result of the tag-based access control in the managed policy of the Amazon Connect service linked role. For more information, see [Service-linked role permissions for Amazon Connect](#).

Step 4: Configure your flow for Amazon Q in Connect

1. Add a [Amazon Q in Connect](#) block to your flow. The block associates an Amazon Q in Connect domain to the current contact. This enables you to display information from a specific domain, based on criteria about the contact.
2. To use Amazon Q in Connect with calls, you must enable Amazon Connect Contact Lens in the flow by adding a [Set recording and analytics behavior](#) block that is configured for Contact Lens real-time. It doesn't matter where in the flow you add the [Set recording and analytics behavior](#) block.

Note

Contact Lens is not required to use Amazon Q in Connect with chats. You use Amazon Q in Connect and Contact Lens real-time analytics to recommend content that is related to customer issues detected during the current call.

When was your knowledge base last updated?

To confirm the last date and time that your knowledge base was updated (meaning a change in the content available), use the [GetKnowledgeBase](#) API to reference `lastContentModificationTime`.

Integrate Amazon Q in Connect with step-by-step guides

To help agents get to solutions faster, you can associate [step-by-step guides](#) with knowledge base content, such as knowledge articles. Then, when Amazon Q in Connect provides a recommended solution to an agent, it also provides them with the option to start the step-by-step guide that you associated with the content.

This topic explains how to associate step-by-step guides with knowledge base content.

Step 1: Identify the resources you want to integrate

The first step is to gather the information needed to run the integration command in [Step 2: Associate the step-by-step guide with the knowledge base content](#):

- The ID of the knowledge base that contains the content resource you want to associate with step-by-step guides.
- The ID of the content resource in the knowledge base.
- The ARN of the step-by-step guide that you want to associate with the content.

The following sections explain how to get this information.

Get the knowledge base ID

To obtain the ID of knowledge base that you want to associate with step-by-step guides, you can call the [ListKnowledgeBases](#) API or run the `list-knowledge-bases` CLI command.

Following is an example `list-knowledge-bases` command that lists all of the knowledge bases:

```
aws qconnect list-knowledge-bases
```

Identify the knowledge base that contains the content resources you want to associate. Copy and save the `knowledgeBaseId`. You'll use it in [Step 2](#).

Get the content ID

To list the content resources in the knowledge base, you can call the [ListContents](#) API or run the `list-contents` CLI command.

Following is an example `list-contents` command that lists the content resources and their content ID.

```
aws qconnect list-contents \  
  --knowledge-base-id knowledgeBaseId
```

Identify which content resources you want to associate with a step-by-step guide. Copy and save the `contentId`. You'll use it in [Step 2](#).

Get the flowARN of the step-by-step guide

You need to get the `flowARN` of the step-by-step guide that you want to associate with the content. There are two ways you can get the `flowARN`: use the Amazon Connect admin website or the CLI.

Amazon Connect admin website

1. In the Amazon Connect admin website, on the navigation menu choose **Routing, Flows**.
2. On the **Flows** page, choose the step-by-step guide to open it in the flow designer.
3. In the flow designer, choose **About this flow**, then choose **View ARN**.
4. Copy and save the `flowARN`. It is the entire string, as shown in the following image.

About this flow

Flow description

Description

Enables the customer to enter digits in private. In a real world implementation, enabling encryption is likely preferred.

Type	ARN
Contact flow (inbound)	Hide ARN 

```
arn:aws:connect:us-west-2:100222783355:instance/0ab6947e-516a-468f-9164-6e79b9191802/contact-flow/00711358-cd68-441d-8301-2e847ca80c82
```

You'll use the flowARN in [Step 2](#).

AWS CLI

1. You can call the Amazon Connect [ListInstances](#) API or run the `list-instances` CLI command to get the `instanceId` of the instance you want to use.

Following is an example `list-instances` command:

```
aws connect list-instances
```

Copy and save the `instanceId`.

2. You can call the Amazon Connect [ListContactFlows](#) API or run the `list-contact-flows` CLI command to determine the step-by-step guide to use.

Following is an example `list-contact-flows` command that lists all the flows and step-by-step guides, and their flowARNs:

```
aws connect list-contact-flows \
```

```
--instance-id instanceId
```

Identify the step-by-step guide you want to associate with the knowledge base, and copy and save its flowARN. You'll use the flowARN in [Step 2](#).

Step 2: Associate the step-by-step guide with the knowledge base content

Create the content association

To complete this step you need the `knowledgeBaseId`, `contentId` and `flowARN` that you obtained in Step 1.

You can call the [CreateContentAssociation](#) API or the run the `create-content-association` CLI command to link the content resource and step-by-step guide.

- You can create only one content association for each content resource.
- You can associate a step-by-step guide with multiple content resources.

Following is an example `create-content-association` command to create a content association between the content resource and a step-by-step guide:

```
aws qconnect create-content-association \
  --knowledge-base-id knowledgeBaseId \
  --content-id contentId \
  --association-type AMAZON_CONNECT_GUIDE \
  --association '{"amazonConnectGuideAssociation":{"flowId":"flowArn"}}'
```

For example, the command might look like the following sample when values are added:

```
aws qconnect create-content-association \
  --knowledge-base-id 00000000-0000-0000-0000-000000000000 \
  --content-id 11111111-1111-1111-1111-111111111111 \
  --association-type AMAZON_CONNECT_GUIDE \
  --association '{"amazonConnectGuideAssociation":{"flowId":"arn:aws:connect:us-west-2:111111111111:instance/22222222-2222-2222-2222-222222222222/contact-flow/00711358-cd68-441d-8301-2e847ca80c82"}}'
```

Confirm that the content association exists

You can call the [ListContentAssociations](#) API or run the `list-content-associations` CLI command to list all of the content associations for the specified content.

Following is an example `list-content-associations` command that returns a list of content associations so you can verify that the association you created exists:

```
aws qconnect list-content-associations \  
  --knowledge-base-id knowledgebaseId \  
  --content-id contentId
```

For example, the command might look like the following sample when values are added:

```
aws qconnect list-content-associations \  
  --knowledge-base-id 00000000-0000-0000-0000-000000000000 \  
  --content-id 11111111-1111-1111-1111-111111111111
```

Assign permissions so agents can view recommendations and step-by-step guides

Assign the following **Agent Applications** security profile permissions to the agents so they can view the knowledge base content and the step-by-step guides.

- **Amazon Q in Connect - View:** Enables agents to search for and view content. They can also receive automatic recommendations during calls if Contact Lens is enabled. Contact Lens is not required to use Amazon Q with chats.
- **Custom views - Access:** Enables agents to see step-by-step guides in their agent workspace.

For information about how to add more permissions to an existing security profile, see [Update security profiles](#).

Security profile permissions for Amazon Q in Connect

Assign the following **Agent Applications** permission to the agent's security profile:

- **Amazon Q - Access:** Enables agents to search for and view content. They can also receive automatic recommendations during calls if Contact Lens is enabled. Contact Lens is not required to use Amazon Q with chats.

For information about how to add more permissions to an existing security profile, see [Update security profiles](#).

By default, the **Admin** security profile already has permissions to perform all Amazon Q activities.

Access Amazon Q in Connect in the agent application

If you're using the CCP that is provided with Amazon Connect, after you enable Amazon Q in Connect, share the following URL with your agents so they can access it:

- [https://*instance name*.my.connect.aws/agent-app-v2/](https://instance_name.my.connect.aws/agent-app-v2/)

If you access your instance using the **awsapps.com** domain, use the following URL:

- [https://*instance name*.awsapps.com/connect/agent-app-v2/](https://instance_name.awsapps.com/connect/agent-app-v2/)

For help finding your instance name, see [Find your Amazon Connect instance name](#).

By using the new URL, your agents can view the CCP and Amazon Q in Connect in the same browser window.

If CCP is embedded in your agent's application, see [Initialization for CCP, Customer Profiles, and Amazon Q in Connect](#) in the *Amazon Connect Streams Documentation* for information about how to include Amazon Q in Connect.

For more information about the agent's experience using Amazon Q in Connect, see [Search for content using Amazon Q in Connect](#).

Amazon Connect Cases

Amazon Connect Cases enables your customer service organization to track, collaborate, and resolve customer cases.

A *case* represents a customer's issue. It is created to record the customer's issue, the steps and interactions taken to resolve the customer's issue, and the outcome.

Without doing any integration work, you can enable Cases for your contact center. You can set up cases to be created when contacts come in, and collect information from the customer to display on the case. Alternatively, agents can manually create cases. When an agent accepts a contact, they have context about an issue and can immediately start solving it. You can create tasks to track and route follow up steps to resolve the case.

The following image shows an example case as it appears in the agent application.

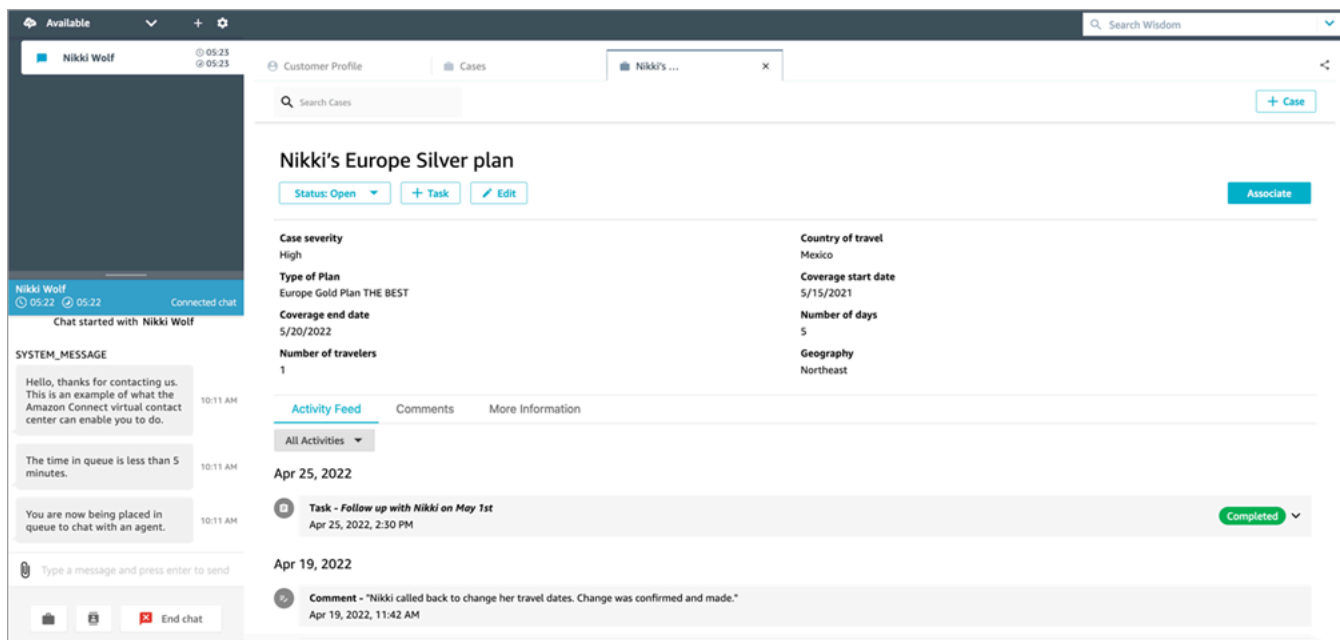

Getting started with Cases

We recommend reviewing these topics to help you get started:

- [Enable Cases](#)
- [Assign permissions](#)
- [Create case fields](#) and [case templates](#)

- [Set up case assignment](#)
- [Use Cases](#) in the agent application
- [Cases block](#)
- [Case event streams](#)
- [Cases quotas](#)

Enable Cases

This topic explains how to enable Amazon Connect Cases using the Amazon Connect console. To use the API, see [Amazon Connect Cases API Reference](#).

Tip

A case is always associated with a customer profile. You must have Customer Profiles enabled. Check your instance settings in the Amazon Connect console, and if a Customer Profiles domain does not yet exist, see [Enable Customer Profiles for your instance](#).

Requirements

If you're using custom IAM policies to manage access to the Amazon Connect Cases, your users need the following IAM permissions to onboard to Cases using the Amazon Connect console:

- `connect:ListInstances`
- `ds:DescribeDirectories`
- `connect:ListIntegrationAssociations`
- `cases:GetDomain`
- `cases:CreateDomain`
- `connect:CreateIntegrationAssociation`
- `connect:DescribeInstance`
- `iam:PutRolePolicy`

For more information, see [Required permissions for using custom IAM policies to manage Cases](#).

How to enable Amazon Connect Cases

1. Open the Amazon Connect console at <https://console.aws.amazon.com/connect/>.
2. On the instances page, choose the instance alias. The instance alias is also your **instance name**, which appears in your Amazon Connect URL. The following image shows the **Amazon Connect virtual contact center instances** page, with a box around the instance alias.

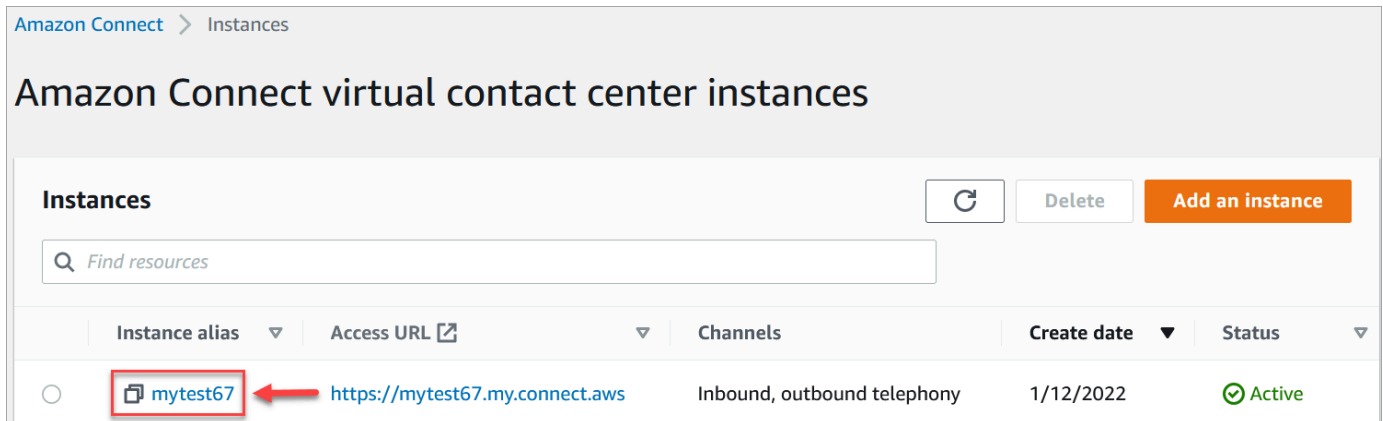

3. On the left navigation menu, choose **Cases** under the **Applications** section. If you don't see this option, it may not be available in your Region. For information about where Cases is available, see [Cases availability by Region](#).
4. Choose **Enable cases** to get started.
5. On the **Cases** page, choose **Add domain**.
6. On the **Add domain** page, enter a unique, friendly name that's meaningful to you, such as your organization name.
7. Choose **Add domain**. The domain is created.

If the domain is not created, choose **Try again**. If that doesn't work, contact AWS Support.

Next steps

After your cases domain is created, do the following:

1. [Assign security profile permissions](#) to agents and call center managers.
2. [Create case fields](#). Fields are the building blocks of your case templates.
3. [Create case templates](#). Case templates are forms that agents complete and reference in the agent application. Templates ensure the right information is collected and referenced for different types of customer issues.

- Optionally, [enable attachments](#) across your Amazon Connect instance. This step allows your agents to upload files to cases. For more information on the Files API, see the [StartAttachedFileUpload](#) API documentation.

Note

Ensure that you have the `cases:CreateRelatedItem` permission for your IAM entity. For more information on Cases permissions, see [Actions, resources, and condition keys for Amazon Connect Cases](#).

- Optionally, add the [Cases](#) block to your flows. This block enables you to get, update, or create cases automatically.
- Optionally, set up [case event streams](#) to get near real-time updates when cases are created or modified.

Security profile permissions for Cases

This topic describes the security profiles permissions that are required to access and use Amazon Connect Cases. For a list of Cases permissions and their API name, see [List of security profile permissions](#).

Required Cases permissions

The following image shows the security permissions used to manage access to [Amazon Connect Cases](#) functionality:

Cases				
These permissions are for cases				
Type	All	View	Edit	Create
Cases	<input checked="" type="checkbox"/>	<input checked="" type="checkbox"/>	<input checked="" type="checkbox"/>	<input checked="" type="checkbox"/>
Audit History ⓘ	<input checked="" type="checkbox"/>	<input checked="" type="checkbox"/>	<input type="checkbox"/>	<input type="checkbox"/>
Case Fields	<input checked="" type="checkbox"/>	<input checked="" type="checkbox"/>	<input checked="" type="checkbox"/>	<input checked="" type="checkbox"/>
Case Templates	<input checked="" type="checkbox"/>	<input checked="" type="checkbox"/>	<input checked="" type="checkbox"/>	<input checked="" type="checkbox"/>

Required Customer Profiles permissions

To use Amazon Connect Cases, your users also need permissions to Customer Profiles permissions, as shown in the following image.

Customer Profiles ⓘ					
Type	All	View	Create	Edit	
Customer profiles	<input checked="" type="checkbox"/>	<input checked="" type="checkbox"/>	<input checked="" type="checkbox"/>	<input checked="" type="checkbox"/>	

Required queue, quick connect, and user view permissions

To be able to assign case ownership to users or queues, agents need permissions to view queues, quick connects, and users. To be able to view the author name on comments, agents need permission to view users. These permissions are shown in the following two images.

Routing		
This group gives permissions to the following areas:		
Type	All	View
Routing profiles	<input type="checkbox"/>	<input type="checkbox"/>
Quick connects	<input type="checkbox"/>	<input checked="" type="checkbox"/>
Hours of operation	<input type="checkbox"/>	<input type="checkbox"/>
Queues	<input type="checkbox"/>	<input checked="" type="checkbox"/>
Task templates	<input type="checkbox"/>	<input type="checkbox"/>

Users and permissions		
This allows for setting user permissions via security p		
Type	All	View
Users	<input type="checkbox"/>	<input checked="" type="checkbox"/>
Agent hierarchy	<input type="checkbox"/>	<input type="checkbox"/>
Security profiles	<input type="checkbox"/>	<input type="checkbox"/>
Agent status	<input type="checkbox"/>	<input type="checkbox"/>

Description of Cases permissions

- **Audit History:** Manage who can access the audit history of cases in the agent application.
 - **View Audit History:** Allows the user to view the audit history of cases in the agent application.
- **Cases:** Manage who can access cases by using the agent application.
 - **View case:** Allows the user to view and search cases in the agent application. This includes viewing case data (for example, status, title, summary), contact history (for example, calls, chats, tasks with information such as start time, end time, duration, etc.), and comments.
 - **Edit case:** Allows the user to edit cases, which includes editing case data (for example, update case status), add comments, and associate contacts to cases.
 - **Create case:** Allows the user to create new cases, and associate contacts to cases.
- **Case Fields:** Manage who can configure case fields by using the Amazon Connect console.
 - **View Case Fields:** Allows users to view the case fields page and all of the existing case fields (could be system or custom).
 - **Edit Case Fields:** Allows users to edit any of the case fields (for example, change title, description, single-select options).
 - **Create Case Fields:** Allows users to create new case fields.
- **Case Templates:** Manage who can configure case templates by using the Amazon Connect console.
 - **View Case Fields:** Allows users to view the case fields page and all of the existing case fields (could be system or custom).
 - **Edit Case Fields:** Allows users to edit any of the case fields (for example, change title, description, single-select options).
 - **Create Case Fields:** Allows users to create new case fields.

When users have permissions to **View Case Fields** and **View Case Templates**, they will see the **Case fields** and **Case templates** options in their left navigation menu, as shown in the following image:

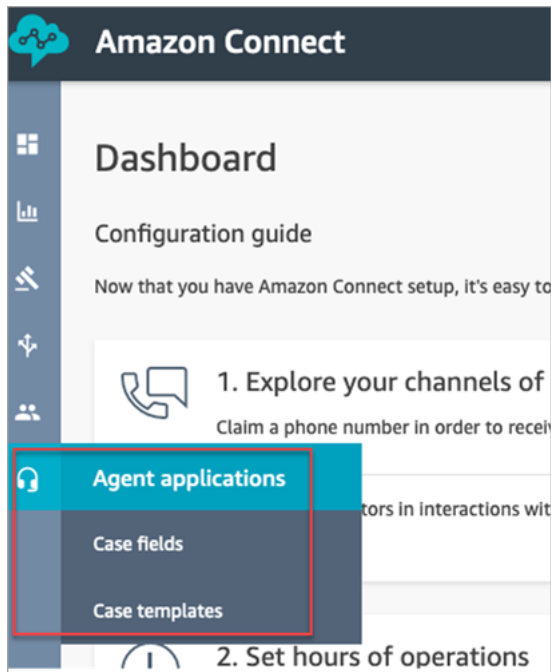

Required permissions for using custom IAM policies to manage Cases

If you're using custom IAM policies to manage access to the Amazon Connect Cases, your users need some or all of the permissions listed in this article, depending on the tasks they need to do.

View Cases domain details

There are two options for granting users IAM permissions to view Cases domain details on the Amazon Connect console.

Option 1: Minimum required IAM permissions

To view Cases domain details in the Amazon Connect console, users must have the following IAM permissions:

- `connect:ListInstances`
- `ds:DescribeDirectories`
- `connect:ListIntegrationAssociations`
- `cases:GetDomain`

Following is a sample IAM policy with these permissions:

```
{
  "Version": "2012-10-17",
  "Statement": [
    {
      "Sid": "AllowsViewingConnectConsole",
      "Effect": "Allow",
      "Action": [
        "connect:ListInstances",
        "ds:DescribeDirectories"
      ],
      "Resource": "*"
    },
    {
      "Sid": "ListIntegrationAssociations",
      "Effect": "Allow",
      "Action": [
        "connect:ListIntegrationAssociations"
      ],
      "Resource": "*"
    },
    {
      "Sid": "CasesGetDomain",
      "Effect": "Allow",
      "Action": [
        "cases:GetDomain"
      ],
      "Resource": "*"
    }
  ]
}
```

Note the following:

- `cases:GetDomain` Action is required on Resource *
- `connect:ListIntegrationAssociations` action supports the instance resource type. See the table in [Actions defined by Amazon Connect](#).

Option 2: Update the existing Amazon Connect policy with cases: GetDomain and profile: SearchProfiles

Include the [AmazonConnectReadOnlyAccess](#) policy, and add cases: GetDomain, as shown in the following example.

```
{
  "Version": "2012-10-17",
  "Statement": [
    {
      "Sid": "CasesGetDomain",
      "Effect": "Allow",
      "Action": [
        "cases:GetDomain"
      ],
      "Resource": "*"
    }
  ]
}
```

Onboard to Cases

There are two options for granting users IAM permissions to onboard to Cases using the Amazon Connect console.

Option 1: Minimum required permissions

To onboard to Cases by using the Amazon Connect console, users must have the following IAM permissions:

- connect:ListInstances
- ds:DescribeDirectories
- connect:ListIntegrationAssociations
- cases:GetDomain
- cases:CreateDomain
- connect:CreateIntegrationAssociation
- connect:DescribeInstance
- iam:PutRolePolicy

- `profile:SearchProfiles`

Following is a sample IAM policy with these permissions:

```
{
  "Version": "2012-10-17",
  "Statement": [
    {
      "Sid": "AllowsViewingConnectConsole",
      "Effect": "Allow",
      "Action": [
        "connect:ListInstances",
        "ds:DescribeDirectories"
      ],
      "Resource": "*"
    },
    {
      "Sid": "ListIntegrationAssociations",
      "Effect": "Allow",
      "Action": [
        "connect:ListIntegrationAssociations"
      ],
      "Resource": "*"
    },
    {
      "Sid": "CasesGetDomain",
      "Effect": "Allow",
      "Action": [
        "cases:GetDomain"
      ],
      "Resource": "*"
    },
    {
      "Sid": "CasesCreateDomain",
      "Effect": "Allow",
      "Action": [
        "cases:CreateDomain"
      ],
      "Resource": "*"
    },
    {
      "Sid": "CreateIntegrationAssociationsAndDependencies",
      "Effect": "Allow",
```



```

        "Action": [
            "connect:CreateIntegrationAssociation",
            "connect:DescribeInstance"
        ],
        "Resource": "*"
    },
    {
        "Sid": "AttachAnyPolicyToAmazonConnectRole",
        "Effect": "Allow",
        "Action": "iam:PutRolePolicy",
        "Resource": "arn:aws:iam::*:role/aws-service-role/connect.amazonaws.com/
AWSServiceRoleForAmazonConnect*"
    },
    {
        "Sid": "ProfileSearchProfiles",
        "Effect": "Allow",
        "Action": [
            "profile:SearchProfiles"
        ],
        "Resource": "*"
    }
]
}

```

Note the following:

- `cases:GetDomain` Action is required on Resource *
- You can scope the permissions to specific Amazon Connect tasks by using the information in [Actions, resources, and condition keys for Amazon Connect](#).
- `profile:SearchProfiles` Action is required because the `CreateCase` API calls the `SearchProfiles` API to search for customer profiles to validate against, and then associate the profile with the case.

Option 2: Use a combination of existing policies

The following combination of policies will also work:

- **AmazonConnect_FullAccess** policy
- `iam:PutRolePolicy` to modify the service-linked role. For an example, see [AmazonConnect_FullAccess policy](#).

- The following IAM policy:

```
{
  "Version": "2012-10-17",
  "Statement": [
    {
      "Sid": "CasesGetDomain",
      "Effect": "Allow",
      "Action": [
        "cases:GetDomain",
        "cases>CreateDomain"
      ],
      "Resource": "*"
    },
    {
      "Sid": "ProfileSearchProfiles",
      "Effect": "Allow",
      "Action": [
        "profile:SearchProfiles"
      ],
      "Resource": "*"
    }
  ]
}
```

Create case fields

Case fields are the building blocks for *case templates*. You create all of the possible fields of information (for example, VIN number, policy number, make/model of car) that you want agents to collect for a given customer issue.

After you create case fields, you can create case templates.

There are two types of case fields:

- [System case fields](#): Amazon Connect provides system fields. You cannot change the name or description.
- [Custom case fields](#): You can create custom case fields that are specific for your business. You must name the case field, and optionally provide a description. Note that the description appears only in the Amazon Connect console. It doesn't appear to agents.

How to create case fields

1. Log in to the Amazon Connect console with an **Admin** account, or an account assigned to a security profile that has permissions to create fields. For a list of required permissions, see [Security profile permissions for Cases](#).
2. Verify the quota for case fields and request an increase if needed. For more information, see [Amazon Connect Cases service quotas](#).
3. On the left navigation menu, choose **Agent applications, Case fields**.
4. The first time you create new fields, you'll notice several [system fields](#) are already present. You cannot change the name of these fields, but in some cases you can edit them.

For example, **Case Id** is a system field. When a case is created, Amazon Connect adds a case ID automatically, and you cannot change it. **Case reason** is also a system field but you can edit it and enter reasons that are specific to your contact center.

5. Choose **+ New field**.
6. Select the type of field you want to create. For example, you might choose **Text** if you want agents to be able to enter free form notes.
7. Assign a name to the field. It will appear to agents in the agent application.
8. Optionally, provide a description. It will only appear to admins on the Amazon Connect console. It does not appear to agents in the agent application.
9. Choose **Save**.
10. When you're done adding fields, you're ready to [create a template](#).

System case fields

Amazon Connect provides system fields. You cannot change the name or description of a system field.

The following table lists the system case fields:

Field name	Field ID (how you call the field in the API)	Field type	Description	Where the data comes from
Assigned queue	assigned_queue	text	The Amazon Connect queue that is assigned to a case	Agent
Assigned user	assigned_user	text	The Amazon Connect user who is assigned to a case	Agent
Case ID	case_id	text	Unique Identifier of the case in UUID format (for example, 689b0bea-aa29-4340-896d-4ca3ce9b6226)	Amazon Connect
Case ID	case_id	text	Unique Identifier of the case in UUID format (for example, 689b0bea-aa29-4340-896d-4ca3ce9b6226)	Amazon Connect
Case Reason	case_reason	single-select	The reason for opening the case	Agent
Customer	customer_id	text	The full ARN of the customer profile identifier	Amazon Connect

Field name	Field ID (how you call the field in the API)	Field type	Description	Where the data comes from
			d for the case is required when using the API. On the Cases: Fields page, the customer's name is displayed.	
Date/Time Closed	last_closed_datetime	date-time	The date and time the case was last closed. It does not guarantee that a case is closed. If a case is reopened, this field contains the date/time stamp of the last time the status was changed to closed.	Amazon Connect
Date/Time Opened	created_datetime	date-time	The date and time the case was opened.	Amazon Connect
Date/Time Updated	last_updated_datetime	date-time	The date and time the case was last updated.	Amazon Connect

Field name	Field ID (how you call the field in the API)	Field type	Description	Where the data comes from
Last Updated User	last_updated_user	text	The identity of the user who performed the last update on the case.	Amazon Connect
Reference number	reference_number	text	<p>A friendly number for the case in 8-digit numeric format.</p> <p>Reference numbers (unlike the Case ID) are not guaranteed to be unique. We recommend that you identify the customer and then collect the reference number to correctly find the right case.</p>	Agent
Status	status	single-select	Current status of the case	Agent
Summary	summary	text	Summary of the case	Agent
Title	title	text	Title of the case	Agent

Custom case fields

You can create custom case fields that are specific for your business. You must name the case field, and optionally provide a description. Note that the description appears only in the Amazon Connect console. It doesn't appear to agents.

You can create fields that are type: number, text, single-select, or true/false.

Single-select fields

For single-select case fields, whether system or custom, you can add value options that the field can take. For example, you can add options to the single-select system field **Case reason** such as **General inquiry**, **Billing issue**, or **Product defect**, that reflect the types of issues in your contact center.

About the **Status** field

You can add options to the single-select **Status** field, such as **Investigating** or **Escalated to manager**. The field comes with two options, **Open** and **Closed**, which cannot be changed.

Active/inactive field options

Single-select case fields can be active or inactive.

Enter field detail: Single-select

Label your field with a unique name.

Field name
Status

Required. Field name cannot end with a space. 6 / 100

Description
Current status of the case

26 / 255

Single-select options

The option name is displayed to agents on the case, for example, "New York." The option name also has an internal value mapped to it called "option value," for example, "NY." By default, the option value is the same as option name, and agents cannot see it.

To change an option's value, choose "Show option value." You can change an option's name at any time; however, once the field is created, you cannot change an option's value.

Active
Inactive

Show option value

Option name (shown to agents)

Closed

Open

Pending

Make inactive

- **Active:** If a field option is active, it means that the field can be given that option. For example, based on the following image, the Status field can be set to **Closed**, **Open**, or **Pending**, as these are the only active options.
- **Inactive:** If you make the **Pending** option inactive, then the field can no longer be given that option. Any existing cases remain unchanged and can still have the status as **Pending**.

Single-select options have two parts:

1. Option name (shown to agents): The label that is displayed to agents in the agent application.
2. Option value (internal reference): The data that's collected. For example, for AWS Region, you may want to display **US West (Oregon)** but collect the data as **PDX**.

Field options appear to the agent in alphabetical order.

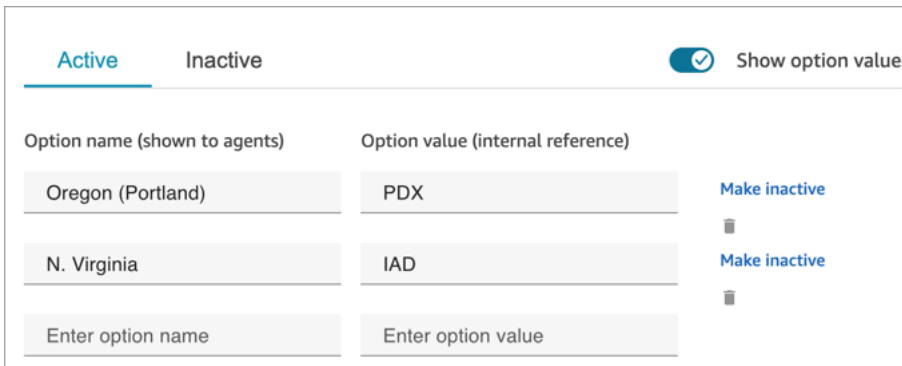

Option name (shown to agents)	Option value (internal reference)	
Oregon (Portland)	PDX	Make inactive
N. Virginia	IAD	Make inactive
Enter option name	Enter option value	

Create case templates

Case templates are forms that ensure agents collect and reference the right information for different types of customer issues. For example, you can create a case template for vehicle damage issues, and require agents complete certain fields when they talk to a customer filing an insurance claim.

When you create a case template, you choose the name that appears to agents, the fields on the form, and the order of the fields.

Important

Cases are always created based on a template.

How case templates look in the agent application

In the agent application, the agent sees the case fields in a Z-formation: case fields are displayed in two columns from left to right, top to bottom.

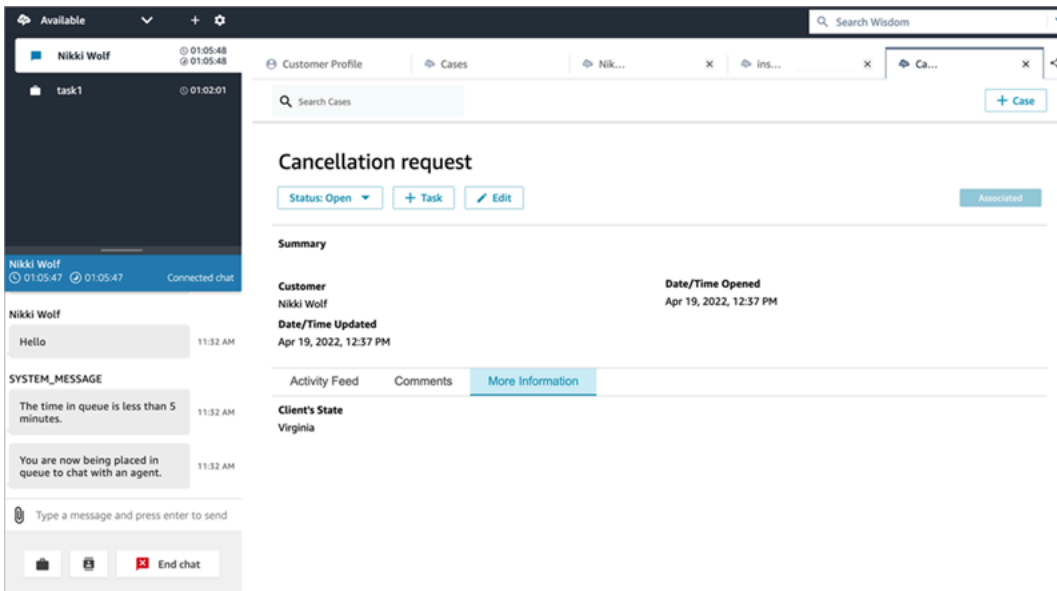

When you're building a case template, think of the information in the agent application as being divided into two sections where case fields are displayed to the agent:

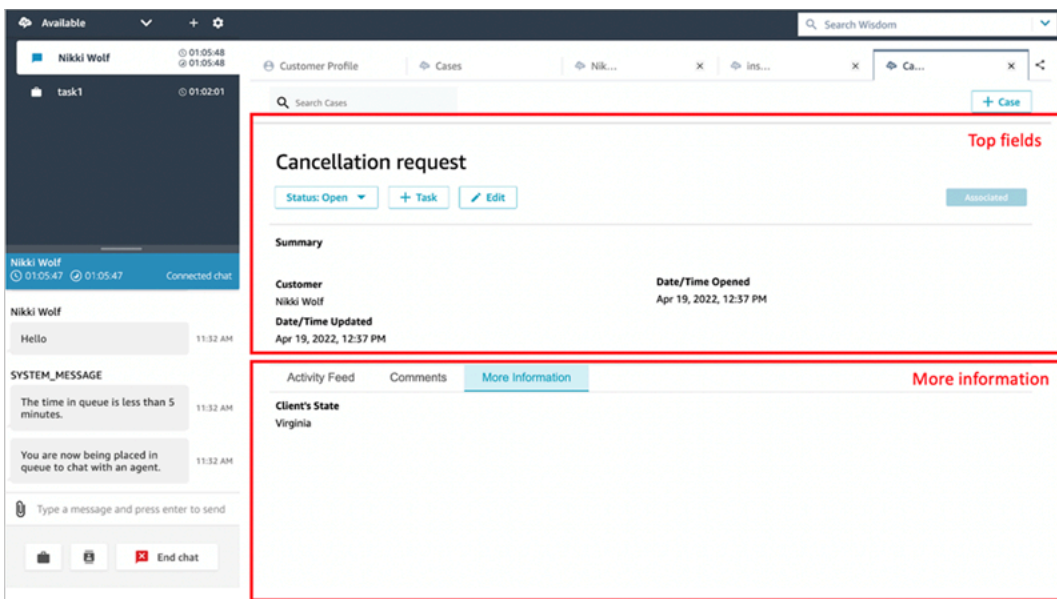

- **Top fields:** This section is always visible on the case, even when agent is viewing sub-sections of the case (for example, **Activity Feed** or **Comments**).
- **More information:** This is a tabbed subsection of the case. It is visible when agent is viewing another subsection, such as **Activity Feed** or **Comments**.

When you create and edit a template, you can do the following in each section:

- Change the order of the fields.
- Indicate if fields are required.

Some system fields, such as **Title** and **Status**, appear on all cases and are required. Other system fields, such as **Customer**, **Summary**, and **Reference number**, appear by default on the case details page. You can remove or rearrange these fields.

Each case that is created is connected to a customer profile from your Amazon Connect instance. On new case templates, the customer name appears by default on the case details page. You can remove or rearrange this field from your templates from the Amazon Connect console.

How to create a template

1. Log in to the Amazon Connect console with an **Admin** account, or an account assigned to a security profile that has permissions to create templates. For a list of required permissions, see [Security profile permissions for Cases](#).
2. Verify the quota for case templates and request an increase if needed. For more information, see [Amazon Connect Cases service quotas](#).
3. Verify the [case fields](#) you want to add to your case template have already been created.
4. On the left navigation menu, choose **Agent applications, Case templates**.
5. Choose **+ New Template**.
6. Assign a name to the template. It will appear to agents in the agent application. The following image shows an example of how templates appear, by default in alphabetical order:

The screenshot shows the 'Create new case' interface in Amazon Connect. On the left, a chat window for 'Nikki Wolf' is visible, showing a 'hello' message and system messages about queue time and agent connection. The main form area is titled 'Create new case' and includes the following fields:

- Template***: A dropdown menu currently set to 'Amazon retail'. A red arrow points to this dropdown.
- Title***: A text input field.
- Status***: A dropdown menu currently set to 'Open'.
- Summary**: A text input field.
- Case Reason**: A dropdown menu.
- Case severity**: A dropdown menu.

- In the **Top fields** section, you'll see some system fields already there. Choose **Add fields**, and use the dropdown to choose the field. Fields that are gray-out are already a part of the template. If you want agents to complete the field in order to save the form, choose **Required**.
- In the **More information** section, choose the fields you want to appear.
- When you're done, choose **Save**. The template is immediately made available to agents in the agent application.

Case layouts

This topic is intended for developers who are using the Amazon Connect Cases APIs.

There is an underlying resource called a *case layout* that is linked to the case template. Technically, it is the case layout that holds the display elements for a case, such as:

- Which fields to display.
- The section, either Top panel or More information.
- The order within a section to display these fields

Whereas it's the case template that mandates a particular schema, such as required case fields.

The case layout is linked to a case template.

Note

You can create a case template and not link it to a case layout. Any case created with a case template that is not linked to a case layout will display system fields in a default order.

Set up case assignment

To help your organization clearly track ownership of cases and resolve them faster, you can ensure every case has an assigned owner who is responsible for case resolution. The owner can be a queue or an individual user.

Note

Assigning a case owner does not route the case to the queue or the individual.

The following image shows the **Case list** view in the agent workspace. You can filter by unassigned cases, for example, and assign ownership as needed. The default view is set to cases assigned to the agent who is viewing the list.

Customer Profile | Cases

Search Cases

Use the case list view to identify cases that need resolution.

+ Case

Cases

Refresh

Assigned queue: Unassigned +1 | Assigned user: | Status: |

Status	Reference Number	Title	Date/Time Updated
Open	34317000	Refund request	Sep 1, 2023, 12:11 PM
Open	79827263	Customer care feedback	Sep 1, 2023, 12:00 PM
Closed	09934245	Flight delay resulted in overnight stay	Sep 1, 2023, 11:59 AM
Pending	13237632	Flight delay	Sep 1, 2023, 11:59 AM
Open	76276897	Flight change request	Sep 1, 2023, 11:59 AM
Open	79887007	Reimbursement request	Sep 1, 2023, 11:58 AM
Open	63436804	Inquiries on seating types	Sep 1, 2023, 11:58 AM
Open	83524150	Request for receipts	Sep 1, 2023, 11:55 AM
Open	55489514	Customer needed to change flight	Sep 1, 2023, 11:55 AM

Contents

- [Set up agents and flows case assignment](#)

- [How agents assign case ownership](#)
- [How to configure the Cases block to assign case ownership in a flow](#)

Set up agents and flows case assignment

To enable case assignment in your Amazon Connect instance, configure the following resources:

1. **Case template.** Add the following [system case fields](#) to a new or existing case template:
 - Assigned queue
 - Assigned user
2. To enable agents to assign case ownership in the agent workspace:
 - **Security profile.** Grant agents permission to view the queues, users, and quick connects that are going to appear in the dropdown lists in the agent workspace. For more information, see [Required queue, quick connect, and user view permissions](#).
 - **Quick connects.** Create user and queue quick connects for each user and queue that you want to appear in the dropdown lists. For instructions, see [Create quick connects](#).
 - **Queues.** Add the quick connects to the agent's queue. For instructions, see [Create a queue](#).
 - **Routing profile.** Add the queue to the agent's routing profile. For instructions, see [Create a routing profile](#).

Agents see only those quick connects that are added to the queues assigned to their routing profile.

3. To configure the Cases block to assign case ownership automatically during a flow, set the **Request Fields** section to **Assigned Queue** or **Assigned User**. For an image and more instructions, see [How to configure the Cases block to assign case ownership in a flow](#).

How agents assign case ownership

The following image shows the agent workspace. Agents choose the **Assign to** dropdown box to assign ownership of a case to themselves (the default option), a queue, or another user.

Refund request

Status: Open + Task Edit Assign to Associate

Summary
Customer is requesting a refund for product outside of warranty period. Product's warranty period is 1 year.

Reference Number
34317000

Date/Time Created
Sep 1, 2023, 12:10 PM

Assigned Queue
Billing Issues

Customer
Nikki Wolf ...

Date/Time Updated
Sep 1, 2023, 12:11 PM

Assigned User
Self

Activity Feed Comments More Information

All Activities

Today

- Task - Reach out to manufacturer
Sep 1, 2023, 12:11 PM **Completed**
- Inbound call
Sep 1, 2023, 12:10 PM **Completed**

If agents assign ownership of a case to a queue or another user, they are presented with a prompt to choose from a filtered list of queues or users. The filtered list of available queues or users is based on the quick connects in the agent's routing profile.

Assign to queue

The following image shows an example dropdown list of queues in the agent workspace. For this list of queues to be displayed to an agent: create a quick connect for each queue, and then add the queue to the agent's routing profile.

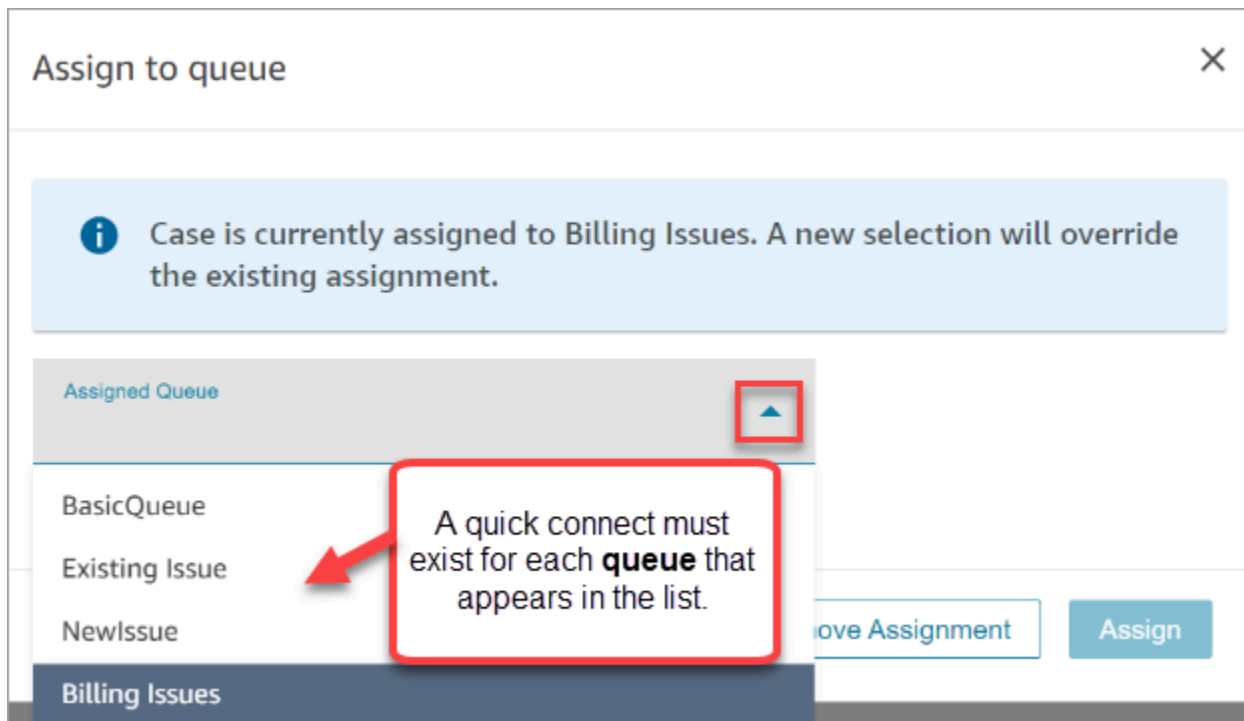

Assign to user

The following image shows an example dropdown list of users in the agent workspace. For this list of users to be displayed to an agent: create a quick connect for each user, assign the quick connects to the queue, add the queue to the agent's routing profile.

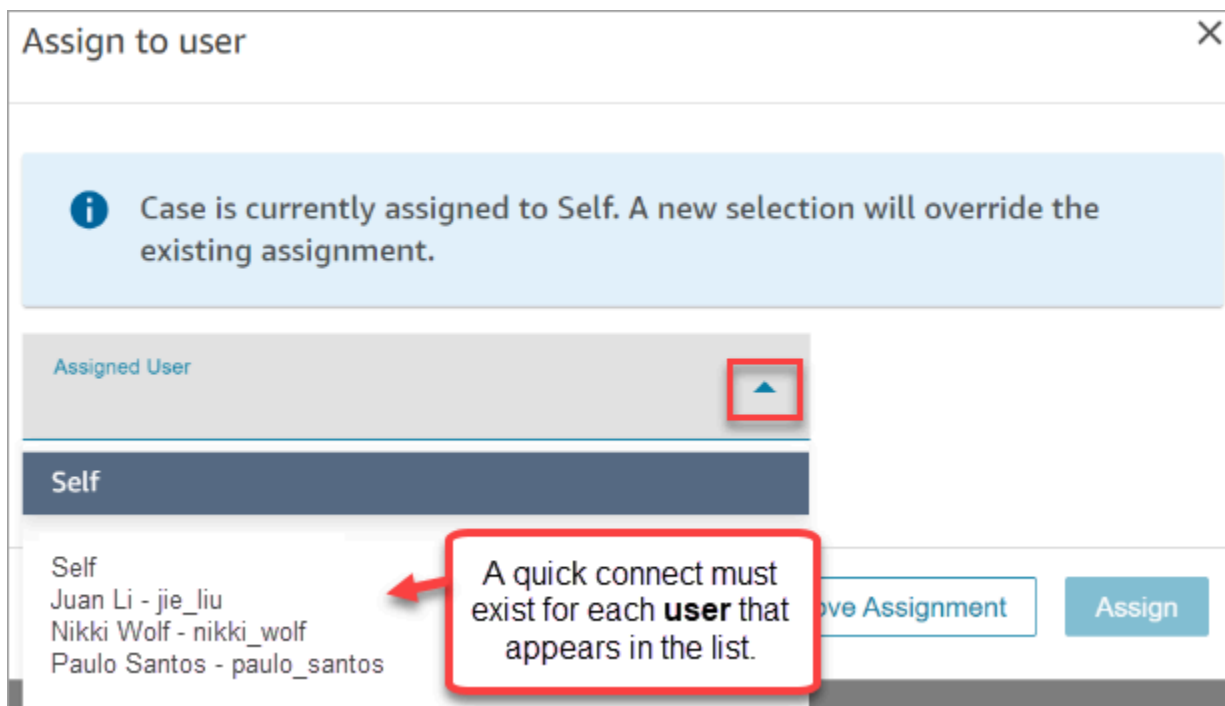

How to configure the Cases block to assign case ownership in a flow

You can configure the [Cases](#) block to automatically populate the **Assigned queue** or **Assigned user** ownership fields. When agents view the case in the agent workspace, the case ownership is already set. Agents can override the assignment as needed, but are restricted to the queues and users that are available in their routing profile.

The following image shows an example of the Properties page for the **Cases** block. The **Request Fields** section is configured to **Set manually, Assigned queue**. You must enter the full ARN of the queue.

Get, update or create a case. [Info](#)

Action

Action
Update case ▼

Link contact to case

Yes
 No

Case to update (CaseID)

Namespace
Case ▼

Key
Case Id ▼

Request Fields

Select fields and give values to populate case data

Assigned Queue × ▼

Assigned Queue ×

Assigned Queue ×

Set manually
 Set dynamically

Assigned Queue
arn:aws:connect:us-west-2:9292880097

Enter the full ARN of the queue.

Cancel Save

There are situations where you may want to set the assigned queue or assigned user dynamically. For example, when the customer enters a DTMF number for a fraud issue, you can create cases where the Fraud department is automatically set as the case owner.

Access Cases in the agent application

After you enable Amazon Connect Cases, you need to take steps to make the functionality available through the agent application. This topic explains your options.

Tip

Make sure your agents have **Cases** permissions in their security profile so they can access Cases. For more information, see [Security profile permissions for Cases](#).

Option 1: Use Cases with the CCP out-of-the-box

Cases is already embedded alongside the Contact Control Panel (CCP). Your agents will access the CCP and Cases in the same browser window using a link that looks like this:

- [https://*instance name*.my.connect.aws/agent-app-v2/](https://instance_name.my.connect.aws/agent-app-v2/)

If you access your instance using the **awsapps.com** domain, use the following URL:

- [https://*instance name*.awsapps.com/connect/agent-app-v2/](https://instance_name.awsapps.com/connect/agent-app-v2/)

For help finding your instance name, see [Find your Amazon Connect instance name](#).

Option 2: Embed Cases into a custom agent application

When you embed your Contact Control Panel (CCP), you have the option of showing or hiding the pre-built CCP user interface. For example, you may want to develop a custom agent application that has a user interface you design, with customized buttons to accept and reject calls. Or, you may want to embed the pre-built CCP that's included with Amazon Connect into another custom app.

You can display the pre-built CCP user interface, or hide it and build your own. In both scenarios, you can incorporate Cases into your agent application by using public APIs provided by Amazon

Connect. These APIs are built to provide you the flexibility to create the functionality and user experience that you want. For more information, see the [Cases API documentation](#).

Tip

When you customize the agent's application, you determine what URL agents will use to access their agent application. This might be very different from the one provided by Amazon Connect. For example, your URL could be `https://example-corp.com/agent-support-app`.

Case event streams

Amazon Connect Cases event streams provide you with near real-time updates when cases are created or modified within your Amazon Connect Cases domain. The events published to the stream include these resource events:

- Case created
- Cases modified
- Related items (Comments, Calls, Chats, Tasks) are added to a case

You can use the case event streams to integrate streams into your data lake solutions, create dashboards that display case performance metrics, implement business rules or automated actions based on case events, and configure alerting tools to trigger custom notifications of specific case activity.

Contents

- [Set up case event streams](#)
- [Case event payload and schema](#)

Set up case event streams

This topic explains how to set up and use case event streams. Some of the onboarding steps require you to call [Amazon Connect Cases APIs](#).

Step 1: Create an Amazon Connect instance and enable Customer Profiles

1. Ensure you have a working Amazon Connect instance in one of the AWS Regions where Cases is available. See [Cases availability by Region](#).
2. Enable Amazon Connect Customer Profiles. For instructions, see [Enable Customer Profiles for your instance](#).

Amazon Connect Cases requires Customer Profiles because each case must be associated with a customer profile from the Customer Profiles service.

Step 2: Add a Cases domain to your Amazon Connect instance

For instructions, see [Enable Cases](#).

If you want to add a case domain using the API, see the [CreateDomain](#) API in the *Amazon Connect Cases API Reference*.

Step 3: Create a case template

[Create a case template](#). In *Step 6: Test case event streams*, you'll use the template.

If you want to create a case template using the API, see the [CreateTemplate](#) API in the *Amazon Connect Cases API Reference*.

Step 4: Enable case event streams and setup to receive events into an SQS queue

Run the following command to enable case event streams for your Cases domain. After this command runs, when cases are created or updated, an event is published to the default-bus of the EventBridge service in your account (it must be in the same AWS Region as your Cases domain).

```
aws connectcases put-case-event-configuration --domain-  
id dad5efb6-8485-4a55-8241-98a88EXAMPLE --event-bridge enabled=true
```

By default, the events published by Amazon Connect Cases only contain metadata about the case, such as `templateId`, `caseId`, `caseArn`, `approximateChangeTime`, and more. You can run the following command to get more information about the case (at the time the event was generated) to be included in the event.

Note

If you want to include a custom field in the event, use the custom field ID. For instructions about how to locate the custom field ID, see [Find the custom field ID](#).

```
# You can include any other field defined in your cases domain in the fields section.
# To list the fields that are defined in your cases domain, call the Cases ListFields
  API.
# To include case fields that you create (custom fields) in the event, enter the custom
  field ID.
aws connectcases put-case-event-configuration --domain-id YOUR_CASES_DOMAIN_ID --event-
bridge "{
  \"enabled\": true,
  \"includedData\": {
    \"caseData\": {
      \"fields\": [
        {
          \"id\": \"status\"
        },
        {
          \"id\": \"title\"
        },
        {
          \"id\": \"customer_id\"
        },
        {
          \"id\": \"your custom field ID\"
        }
      ]
    },
    \"relatedItemData\": {
      \"includeContent\": true
    }
  }
}"
```

Next, create an Amazon SQS queue and set that as a target for the Amazon Connect Cases events on your EventBridge bus so that all the case events are delivered to the SQS queue for later processing.

```
# Create an SQS queue
aws sqs create-queue --queue-name case-events-queue --attributes "{\"Policy\": \"{ \\
\\\"Version\\\": \\\"2012-10-17\\\", \\\"Statement\\\": [{ \\\"Sid\\\": \\\"case-event-
subscription\\\", \\\"Effect\\\": \\\"Allow\\\", \\\"Principal\\\": { \\\"Service\\\":
\\\"events.amazonaws.com\\\"}, \\\"Action\\\": \\\"SQS:SendMessage\\\", \\\"Resource\\
\\\": \\\"*\\\"}]}\""}"

# Create an rule on the EventBridge default bus that represents the case events
aws events put-rule --name case-events-to-sqs-queue --event-pattern "{\"source\":
[\"aws.cases\"]}" --state ENABLED

# Ask event bridge to publish case events to the SQS queue.
aws events put-targets --rule case-events-to-sqs-queue --target "[{
  \"Id\": \"target-1\",
  \"Arn\": \"arn:aws:sqs:The AWS Region of your Amazon Connect instance:your AWS account
  ID:case-events-queue\"
}]"
```

Step 5: Test case event streams

Use the Amazon Connect agent application to:

1. Accept a chat contact.
2. Create a customer profile and associate that to the chat contact.
3. Create a case.

Note

The **Create case** button on the **Cases** tab is inactive until you accept a contact and associate that contact with a customer profile.

Navigate to the Amazon SQS console and check that a case event (type: `CASE.CREATED`) for the newly created case is available in your SQS Queue. Similarly, you can modify the case created above and get a corresponding case event (type: `CASE.UPDATED`) in your SQS queue. You can associate the contact to the case, and leave a comment on the case to get case events for those actions, too.

Step 6: Use cases for the case event streams

Case event streams publish events every time a case is created, case is updated, contact is associated to the case, and comment is added on a case. You can use these events for:

- Metrics, analytics and dashboards
- Build Apps that notify users (for example, send emails)
- Automated actions that are triggered based on certain type of case updates

For example, you can use the SQS target on EventBridge (as shown on step 4) to temporarily store the case events in the SQS queue, and use Lambda functions to process events in the SQS to build custom applications such as sending emails to the customer when their case is updated, automatically resolving any tasks linked to the case, and more. Similarly, you can use the Firehose target on the EventBridge to store the case events into an S3 bucket and then use the AWS Glue for ETL, Athena for ad-hoc analytics, and Amazon QuickSight for dashboards.

Case event payload and schema

When you request to include case data in the event payload, the data reflects the version of the case after that particular edit.

Amazon Connect Cases default limits guarantee that the payload will be less than 256KB (the maximum size of an EventBus event). Since you can customize the case object model (for example, you can define custom fields on case objects to capture business specific information), case event schema reflect the customizations made to the case object as shown in the following examples (for example, see how customer-specific UUIDs are being use as JSON properties).

Example case event payload for the case resource

```
// Given the limits on the "includedData" configuration
// this payload is guaranteed to less than 256KB at launch.
{
  "version": "0",
  "id": "event ID",
  "detail-type": "Amazon Connect Cases Change",
  "source": "aws.cases",
  "account": "your AWS account ID",
  "time": "2022-03-16T23:43:26Z",
  "region": "The AWS Region of your Amazon Connect instance",
  "resources": [
```

```

    "arn:aws:cases:your Amazon Connect AWS Region:your AWS account ID:domain/case
domain ID",
    "arn:aws:cases:your Amazon Connect AWS Region:your AWS account ID:domain/case
domain ID/case/case ID"
  ],
  "detail": {
    "version": "0",
    "eventType": "CASE.UPDATED", //(or "CASE.CREATED" or "CASE.DELETED")
    "approximateChangeTime": "2022-03-16T23:16:57.893Z", // Can be used for
ordering
    "changedFieldIds": ["status", "last_updated_datetime"],
    "performedBy": {
      "user": {
        "userArn": "arn:aws:connect:your Amazon Connect AWS Region:your AWS
account ID:instance/connect instance ID/user/connect user ID"
      },
      "iamPrincipalArn": "arn:aws:iam::your Amazon Connect AWS Region:role/role
name"
    },
    "case": {
      "caseId": "case ID",
      "templateId": "template ID",
      "createdDateTime": "2022-03-16T23:16:57.893Z",

      // This section contains only non-null field values for the
      // fields that customers have configured in the "includedData".

      // Field values included in this section reflects the case
      // after this particular change is applied.
      "fields": {
        "status": {
          "value": {
            "stringValue": "open"
          }
        },
        "case_reason": {
          "value": {
            "stringValue": "Shipment lost"
          }
        },
        "custom-field-uuid-1": {
          "value": {
            "stringValue": "Customer didn't receive the product"
          }
        }
      }
    }
  }
}

```



```

    }
  }
}
}
}

```

Example case event payload for the related-item resource

```

// Given the limits on the "includedData" configuration
// this payload is guaranteed to less than 256KB
{
  "version": "0",
  "id": "event ID",
  "detail-type": "Amazon Connect Cases Change",
  "source": "aws.cases",
  "account": "your AWS account ID",
  "time": "2022-03-16T23:43:26Z",
  "region": "The AWS Region of your Amazon Connect instance",
  "resources": [
    "arn:aws:cases:your Amazon Connect AWS Region:your AWS account ID:domain/case domain ID",
    "arn:aws:cases:your Amazon Connect AWS Region:your AWS account ID:domain/case domain ID/case/case ID/related-item/related-item ID"
  ],
  "detail": {
    "version": "0",
    "eventType": "RELATED_ITEM.CREATED", //(or "RELATED_ITEM.UPDATED" or "CASE.RELATED_ITEM.DELETED")
    "approximateChangeTime": "2022-03-16T23:16:57.893Z", // Can be used for ordering
    "changedAttributes": ["comment.commentText"],
    "performedBy": {
      "user": {
        "userArn": "arn:aws:connect:your Amazon Connect AWS Region:your AWS account ID:instance/connect instance ID/user/connect user ID"
      },
      "iamPrincipalArn": "arn:aws:iam::your Amazon Connect AWS Region:role/role name"
    },
    "relatedItem": {
      "relatedItemType": "Comment", // (OR Contact)
      "relatedItemId": "related-item ID",

```

```
"caseId": "case id that this related item is a sub-resource of",
"createdDateTime": "2022-03-16T23:16:57.893Z",

// This section includes any attributes that customers have configured
// in the "includedData" configuration.
"comment": {
  "body": "Gave a $5 refund to customer to make them happy",
},

// if the related item was of type contact.
// "contact": {
//   "contactArn": ".....",
// }
}
}
```

Amazon Connect Contact Lens

Note

Powered by Amazon Bedrock: AWS implements [automated abuse detection](#). Because Amazon Connect Contact Lens is built on Amazon Bedrock, users can take full advantage of the controls implemented in Amazon Bedrock to enforce safety, security, and the responsible use of artificial intelligence (AI).

Amazon Connect Contact Lens provides contact center analytics and quality management capabilities that enable you to monitor, measure, and continuously improve contact quality and agent performance for a better overall customer experience.

- [Analyze conversations using conversational analytics](#). You can uncover trends and improve customer service by understanding sentiment, conversation characteristics, emerging contact themes, and agent compliance risks.
- [Evaluate agent performance](#). You can review conversations alongside contact details, recordings, transcripts, and summaries, without the need to switch applications. You can define and assess agent performance criteria (for example, script adherence, sensitive data collection, and customer greetings) and automatically pre-populate evaluation forms.
- [Set up and review agent screen recordings](#). You can review agent actions handling customer contacts by reviewing screen recordings. This helps you ensure adherence to quality standards, compliance requirements, and best practices. It also helps you identify coaching opportunities and bottlenecks so you can streamline workflows.
- [Search for contacts](#). You can search for contacts as far back as two years ago.
- [Monitor live and recorded conversations](#). You can monitor live conversations (both voice and chat) and barge live voice conversations. This is especially helpful for agents in training.
- [Transfer](#), [reschedule](#), or [end](#) in-progress contacts. While on the **Contact details** page, you can manage in-progress contacts.

Contact Lens helps you protect your customer's privacy by enabling you to [automatically redact sensitive data](#) from conversation transcripts and audio files.

Analyze conversations using conversational analytics

With Amazon Connect Contact Lens, you can analyze conversations between customers and agents by using speech and chat transcriptions, natural language processing, and intelligent search capabilities. Amazon Connect Contact Lens performs sentiment analysis, detects issues, and enables you to automatically categorize contacts.

Speech analytics support

- **Real-time call analytics:** Use to detect and resolve customer issues more proactively while the call is progress. For example, it can [analyze and alert](#) you when a customer is getting frustrated because the agent is unable to resolve a complicated problem. This allows you to provide more immediate assistance.
- **Post-call analytics:** Use to understand trends of customer conversations and agent compliance. This helps you identify opportunities to coach an agent after the call.

Chat analytics support

- **Real-time chat analytics:** As with real-time call analytics, you can detect and resolve customer issues more proactively while the chat is progress and [receive an alert](#). For example, managers can get a real-time email alert when customer sentiment for a chat contact turns negative, allowing them to join the in-progress contact and help resolve the customer issue.
- **Post-chat analytics:** Use to understand trends of customer conversations with both bots and agents. It provides information specific to a chat interaction, such as the agent greeting time, and agent and customer response times. The response times and sentiments help you investigate the customer's experience with the bot versus the agent, and identify areas for improvement.

Each processed chat message is charged the same way. While not all messages may have all features applied (for example, summarization is applied to text/plain messages only), if at least one Contact Lens feature is applied, the message is counted for billing. For more information about pricing, see [Amazon Connect Pricing](#).

You can protect your customer's privacy by redacting sensitive data, such as name, address, and credit card information from transcripts and audio recordings.

Sample Contact details page for a call

The following image shows the conversational analytics for a voice call. Notice that it includes **Talk time** metrics.

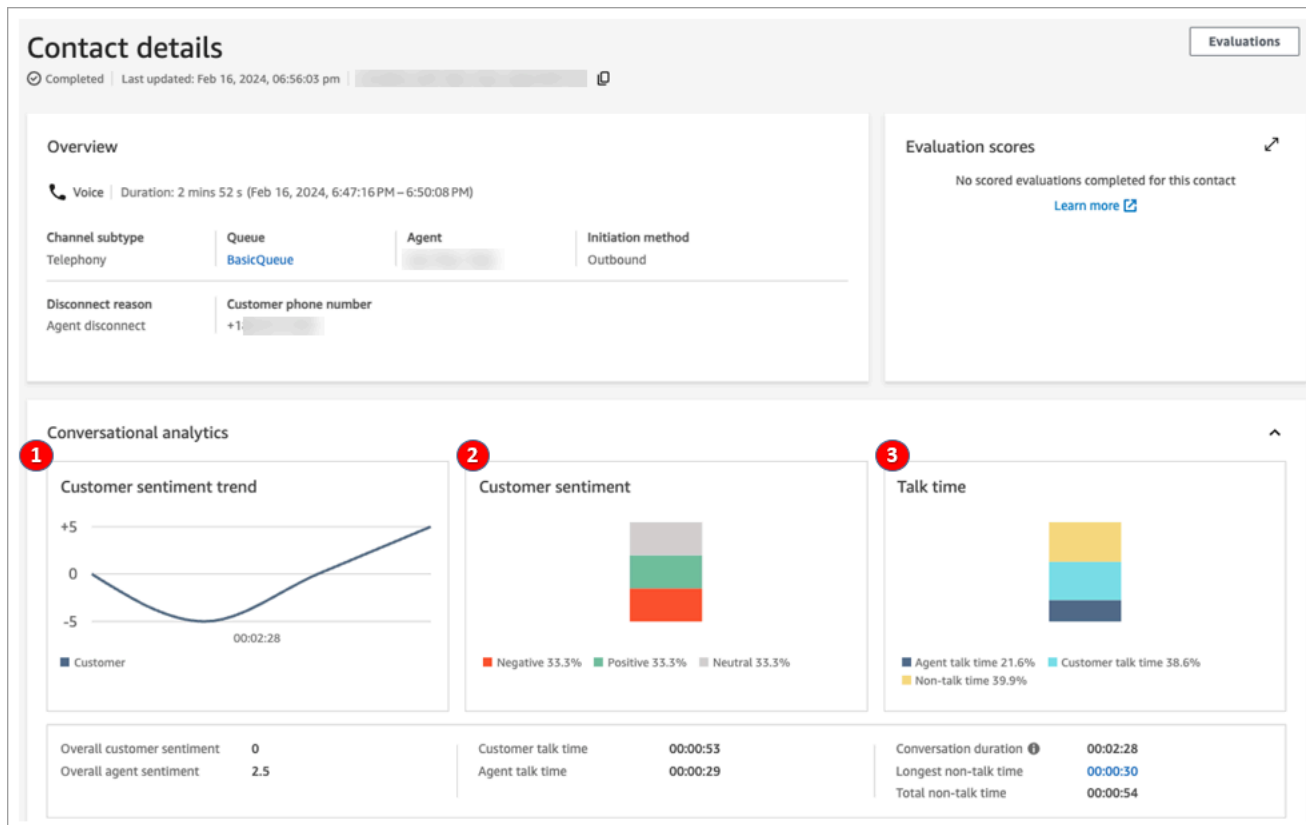

- Customer sentiment trend:** This graph shows how customer sentiment changes as the contact progresses. For more information, see [Investigate sentiment scores during contacts](#).
- Customer sentiment:** This graph shows the distribution of customer sentiment for the entire call. This is calculated by counting the total number of conversation turns or chat messages where a customer had Positive, Neutral, and Negative sentiment.
- Talk time:** This graph shows the distribution of talk time and non talk-time during the entire call. The talk time is further split into agent and customer talk time.

The following image shows the next section on the **Contact details** page for a voice call: the audio analysis and transcript. Notice that personally identifiable information (PII) has been [redacted from the transcript](#).

The screenshot displays the Amazon Connect Recording interface. At the top, there is a 'Recording' section with a timeline from 00:30 to 07:30. Below the timeline are playback controls (rewind, play, fast forward) and a 'Legend' icon. The main area is titled 'Transcript' and includes a 'Show transcript summary' toggle (off) and an 'Auto scroll' toggle (on). Under 'Categories', 'cancellation' is selected. The transcript shows a conversation between a Customer and an Agent. A red box highlights a customer message: 'Uh I don't know why should be giving money to a company tha...'. A callout box points to this message with the text: 'Sensitive information has been redacted from this conversation.' Other messages in the transcript include: 'what's going on So um yeah I'll finish one thing so um I would like to see if I can get a refund or exchange because I ordered one of your grow it yourself under herb garden kids and uh nothing's proud did after a couple of weeks. So I think something is wrong with the seats and uh the the product may be defective.', 'Yeah I'm it's actually rather upsetting what happened. My wife is blind and sensitive to the sun so I was going to surprise her with uh with the birthday present uh with your uh with the this thing of yours because uh um she loves growing stuff and you guys actually really let me know I I I'm very frustrated I this this is a huge let down I should be taking my business somewhere else and it's it's just very weird.', and 'Yeah sure it's uh [PII] my name is [PII] uh and the last name is [PII].'. The transcript also shows agent responses: 'Okay. Um could you please tell me what is your first and the last name' and 'And uh could you please share the order ID number?'. Sentiment indicators (sad face) are present next to the customer messages.

Sample Contact details page for real-time chat analytics

The following image shows the conversational analytics for a real-time chat. Notice that it includes Key highlights and customer sentiment.

Contact details

In progress | Last updated: Oct 28, 2019, 10:36:32 pm

Overview

Chat | Start time: 07:42 pm, Nov 14, 2023

Queue	Agent	Initiation method	Disconnect reason	Customer sentiment
BasicQueue		API	-	

Interactions and transcript



Key highlights

Issue

Show key highlights

Categories

Proper-Greeting

Upset_Customer-customer_any_time

Angry-Customer 2

Show 1 more

Good morning. Thank you for contacting us today. I see you're platinum member. Thank you for your loyalty. My name is [redacted] How can I help you today?

Customer 01:00

Angry-Customer 2/2



Hi, [redacted] I know it's not your fault, and I'm sorry about all this, but I'm telling you right now that I'm upset. I can't believe this is happening to me.

Customer 01:10

Issue



I am considering to cancel my account.

Sample Contact details page for post-chat analytics

The following image shows post-chat analytics. Notice that it includes chat response metrics, such as **Agent greeting time** (the time from the agent joining the chat to when they send the first response), **Customer response time**, and **Agent response time**.

Contact details

Contact summary

Contact ID	[REDACTED]	Initiation method	API
Duration	00:11:06	Disconnect reason	Customer disconnect
Channel	Chat	Media streams	[CHAT]
Queue	BasicQueue	Last updated	Nov 8, 22, 01:06:52 am
Agent	John		
Start and end time	Nov 8, 22, 12:53:05 am - 01:04:11 am		

[Show less](#)

Conversational analytics

Customer sentiment trend

Customer sentiment

Note the metrics for chat conversations. For example:
Agent greeting time = after the agent joined the chat, how long until they sent the first response.

Overall customer sentiment	-1.2	Avg. customer response time	00:00:05	Agent greeting time	00:00:06
Overall agent sentiment	0.9	Max. customer response time	00:00:07	Avg. agent response time	00:00:11
				Max. agent response time	00:00:54

The following image shows the next section on the **Contact details** page for a chat: the interaction analysis and transcript. Notice that you can investigate the customer's interaction with a bot versus the agent.

The screenshot displays the Amazon Connect Interactions console. At the top, there is a timeline view showing the interaction between a Customer, an Agent, and a System/Bot. A red box highlights a specific segment of the interaction, with a callout text that reads: "The customer's interaction with system prompts or a bot is separated from their interaction with the agent, allowing you to investigate and improve it." Below the timeline, the transcript is visible, starting with a system prompt: "Thank you for chatting with Hotel Grand Vancouver. How can I help you?". The customer then sends a message: "I did not receive my reward points after my stay at your hotel!!!". The agent (John) responds: "I was counting on those points to pay for my flight home. So now I'm stuck here." The transcript also shows a "Categories" section with buttons for "LostBusiness", "AgentNoHello", and "NoSentimentImprovement". A "Show transcript summary" toggle is visible on the right.

Enable Amazon Connect Contact Lens

You can enable Amazon Connect Contact Lens in a few steps. Add a [Set recording and analytics behavior](#) block to a flow, and configure it to enable Contact Lens for voice, chat, or both.

The following image shows a block that's configured for call recording, and Contact Lens speech analytics and chat analytics. The **Call recording** option is set to **Agent and customer**. In the **Analytics** section, the options are selected for speech and chat.

Set recording and analytics behavior ×

Specify recording behavior and configure Contact Lens conversational analytics [Info](#)

Call recording

Enables or disables call recording for the agent, customer, or both.

On

- Agent and customer
- Agent only
- Customer only

Off

Analytics

Enable Contact Lens conversational analytics.
Contact Lens conversational analytics provides ML-based speech and chat analytics such as transcripts, sentiment, contact categorization, sensitive data redaction, and contact summarization. These analytics help identify customer issues and improve agent performance. [Info](#)

Enable speech analytics
ML-based speech analytics for post-call and real-time. You need agent and customer call recordings to enable speech analytics

- Post-call analytics
Recommended for best transcription accuracy.
- Real-time and post-call analytics
Enables real-time alerts and speech analytics on live calls.

Enable chat analytics
ML-based chat analytics for post-chat. You need chat transcripts enabled on the Amazon Connect AWS management console to leverage chat analytics

The procedures in this topic describe the steps to enable Contact Lens for call or chat analytics.

Contents

- [Important things to know](#)
- [Enable call recording and speech analytics](#)
- [Enable chat analytics](#)
- [Enable redaction of sensitive data](#)
- [Review sensitive data redaction for accuracy](#)
- [Dynamically enable Contact Lens using contact attributes](#)
- [Design a flow for key highlights](#)
- [What if the flow block fails to enable Contact Lens?](#)
- [Multi-party calls and Contact Lens](#)

Important things to know

- **Collect data after transferring a contact:** If you want to continue using Contact Lens to collect data after transferring a contact to another agent or queue, you need to add another [Set](#)

[recording and analytics behavior](#) block with **Enable analytics** enabled for the flow. This is because a transfer generates a second contact ID and contact record. Contact Lens needs to run on that contact record as well.

- When you select **Enable Contact Lens conversational analytics**, you must choose to enable speech or chat analytics. Otherwise, your flow will display an error when you publish it.
- Where you place the [Set recording and analytics behavior](#) block in a flow affects the agent's experience with key highlights. For more information, see [Design a flow for key highlights](#).

Enable call recording and speech analytics

1. In the [Set recording and analytics behavior](#) block, under **Call recording**, choose **On, Agent and Customer**.

Both agent and customer call recordings are required to use Contact Lens for voice contacts.

2. Under **Analytics**, choose **Enable Contact Lens conversational analytics**, **Enable speech analytics**.

If you don't see this option, Amazon Connect Contact Lens hasn't been enabled for your instance. To enable it, see [Update instance settings](#).

3. Choose one of the following:

- a. **Post-call analytics:** Contact Lens analyzes the call recording after the conversation and After Contact Work (ACW) is complete. This option provides the best transcription accuracy.
- b. **Real-time analytics:** Contact Lens provides both real-time insights during the call, and post-call analytics after the conversation has ended and After Contact Work (ACW) is complete.

If you choose this option, we recommend setting up alerts based on keywords and phrases that the customer may utter during the call. Contact Lens analyzes the conversation real-time to detect the specified keywords or phrases, and alerts supervisors. From there, supervisors can listen in on the live call and provide guidance to the agent to help them resolve the issue faster.

For information about setting up alerts, see [Alert supervisors in real-time based on keywords and phrases mentioned during a call](#).

If your instance was created before October 2018, additional configuration is needed to access real-time call analytics. For more information, see [Service-linked role permissions for Amazon Connect](#).

4. Choose the language. For a list of available languages for various Contact Lens features, see [Supported languages](#).

For instructions on using an attribute, see [Use contact attributes](#).

5. Optionally, enable redaction of sensitive data. For more information, see the next section, [Enable redaction](#).
6. Choose **Save**.
7. If the contact is going to be transferred to another agent or queue, repeat these steps to add another [Set recording and analytics behavior](#) block with **Enable Contact Lens for conversational analytics** enabled.

Enable chat analytics

1. In the [Set recording and analytics behavior](#) block, under **Analytics**, choose **Enable Contact Lens conversational analytics**, and **Enable chat analytics**.

Note

By choosing this option you will receive both real-time and post-chat analytics.

If you don't see this option, Amazon Connect Contact Lens hasn't been enabled for your instance. To enable it, see [Update instance settings](#).

2. Choose the language. For a list of available languages for various Contact Lens features, see [Supported languages](#).

For instructions on using an attribute, see [Use contact attributes](#).

3. Optionally, enable redaction of sensitive data. For more information, see the next section, [Enable redaction of sensitive data](#).
4. Choose **Save**.

- If the contact is going to be transferred to another agent or queue, repeat these steps to add another [Set recording and analytics behavior](#) block with **Enable Contact Lens for conversational analytics** enabled.

Enable redaction of sensitive data

To enable redaction of sensitive data in a flow, choose **Redact sensitive data**. When redaction is enabled you can choose from the following options:

- Redact all personally identifiable information (PII) data (all PII entities supported).
- Choose which PII entities to redact from the list of supported entities.

If you accept the default settings, Contact Lens redacts all personally identifiable information (PII) it identifies, and replaces it with **[PII]** in the transcript. The default settings are shown in the following image because the following options are selected: **Redact sensitive data**, **Redact All PII data**, and **Replace with placeholder PII**.

Redact sensitive data
Redact sensitive data, such as personal information, in the Contact Lens output file and get a redacted audio recording. Sensitive data redaction is applied after the call disconnects, and is currently available for certain languages only. [Info](#)

Set manually

- Generate both redacted and original transcripts and audio
- Generate redacted transcript only, and both redacted and original audio

Set dynamically

Data redaction

Redact All PII data

Select PII entities to redact

Data redaction replacement

Replace with placeholder PII
All PII data is replaced with [PII]. For example, Jane Doe is replaced with [PII]

Replace with PII entity type
Each PII entity is replaced with its type. For example, Jane Doe is replaced with [NAME]

Select PII entities to redact

Under the **Data redaction** section, you can select specific PII entities to redact. The following image shows that **Credit/Debit Card Number** is going to be redacted.

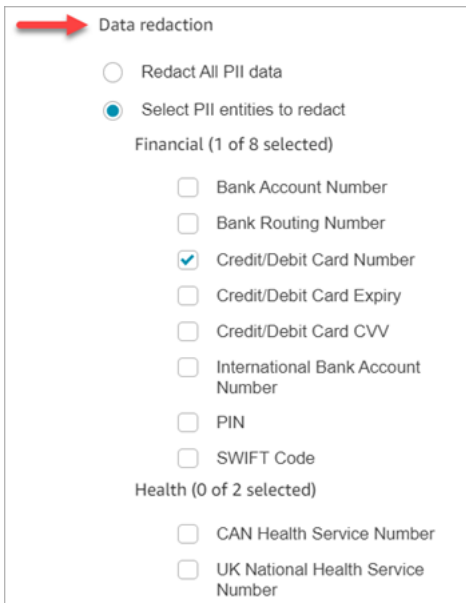

Data reduction

Redact All PII data

Select PII entities to redact

Financial (1 of 8 selected)

Bank Account Number

Bank Routing Number

Credit/Debit Card Number

Credit/Debit Card Expiry

Credit/Debit Card CVV

International Bank Account Number

PIN

SWIFT Code

Health (0 of 2 selected)

CAN Health Service Number

UK National Health Service Number

Choose data redaction replacement

Under the **Data redaction replacement** section, you can choose the mask to be used as data redaction replacement. For example, in the following image, the **Replace with placeholder PII** option indicates that **PII** will replace the data.

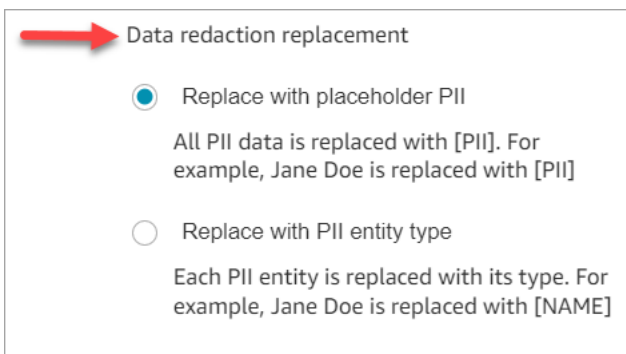

Data redaction replacement

Replace with placeholder PII

All PII data is replaced with [PII]. For example, Jane Doe is replaced with [PII]

Replace with PII entity type

Each PII entity is replaced with its type. For example, Jane Doe is replaced with [NAME]

For more information about using redaction, see [Use sensitive data redaction](#).

Review sensitive data redaction for accuracy

The redaction feature is designed to identify and remove sensitive data. However, due to the predictive nature of machine learning, it may not identify and remove all instances of sensitive data in a transcript generated by Contact Lens. We recommend you review any redacted output to ensure it meets your needs.

⚠ Important

The redaction feature does not meet the requirements for de-identification under medical privacy laws like the U.S. Health Insurance Portability and Accountability Act of 1996 (HIPAA), so we recommend you continue to treat it as protected health information after redaction.

For the location of redacted files and examples, see [Output file locations](#).

Dynamically enable Contact Lens using contact attributes

You can dynamically enable Contact Lens and the redaction of the output files based on the language of the customer. For example, for customers using en-US, you may want only a redacted file whereas for those using en-GB, you may want both the original and redacted output files.

- Redaction: choose one of the following (they are case sensitive)
 - None
 - RedactedOnly
 - RedactedAndOriginal
- Language: Choose from the [list of available languages](#).

You can set these attributes in the following ways:

- User defined: use a **Set contact attributes** block. For general instructions about using this block, see [How to reference contact attributes](#). Define the **Destination key** and **Value** for redaction and language as needed.

The following image shows an example of how you can configure the **Set contact attributes** block to use contact attributes for redaction. Choose the **Use text** option, set **Destination key** to **redaction_option**, and set **Value** to **RedactedAndOriginal**.

ℹ Note

Value is case sensitive.

Set contact attributes

Define and store key-value pairs as contact attributes. [Learn more](#)

Contact attributes are accessible by other areas of Amazon Connect, such as the Contact Control Panel (CCP) and Contact Trace Records (CTRs).

Attribute to save

Use text ×

Destination key

Value

Use attribute



The following image show how to use contact attributes for language. Choose the Use text option, set Destination key to language, set **Value** to **en-US**.



Use text

Destination key

language

Value

en-US

Use attribute

This is case sensitive!

- [Use a Lambda function](#). This is similar to how you set up user-defined contact attributes. An AWS Lambda function can return the result as a key-value pair, depending on the language of the Lambda response. The following example shows a Lambda response in JSON:

```
{
  'redaction_option': 'RedactedOnly',
  'language': 'en-US'
}
```

Design a flow for key highlights

Transcripts are visible to agents using the Contact Control Panel (CCP) depending on whether Contact Lens analytics is enabled in the [Set recording and analytics behavior](#) in the inbound flow, and/or a transfer flow.

This section provides three use cases for enabling Contact Lens analytics in the [Set recording and analytics behavior](#) block, and describes how they affect the agent's experience with key highlights.

Use case 1: Contact Lens analytics is enabled in an inbound flow only

- A contact enters the inbound flow, and there are no call transfers. Following is the agent experience:

The agent receives the full transcript during After Contact Work (ACW). The transcript includes everything said by the agent and the customer, from the moment the agent accepts the initial call, until the call has ended, as shown in the following image.

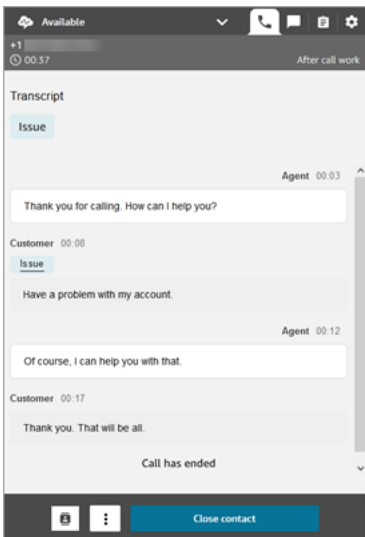

- A contact enters the inbound flow, and there is a call transfer. Following is the agent experience:
- Agent 1 receives a call transcript after they leave the conference/warm transfer, during ACW.

The transcript includes everything said by agent 1 and the customer, from the moment the agent accepts the initial call, until the agent 1 leaves the conference/warm transfer portion of the call. The transcript includes the flow (transfer/queue flow) prompt messages, as shown in the following image.

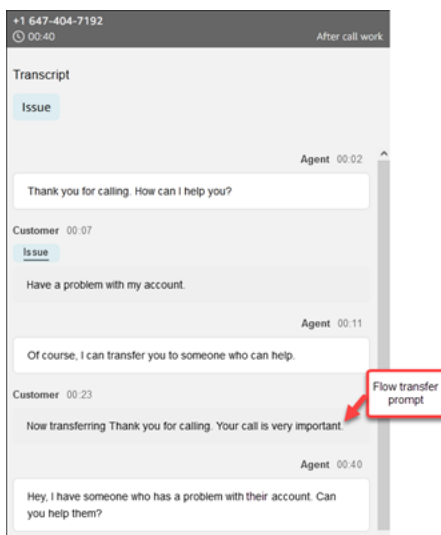

- Agent 2 receives a call transcript at the time of accepting the conference/warm transfer call from agent 1.

The transcript includes everything said by agent 1 and the customer, from the moment agent 1 accepts the initial call until the agent 1 leaves the conference/warm transfer portion of the

call. The transcript includes the flow (transfer/queue flow) prompt messages, and the warm transfer conversation, as shown in the following image.

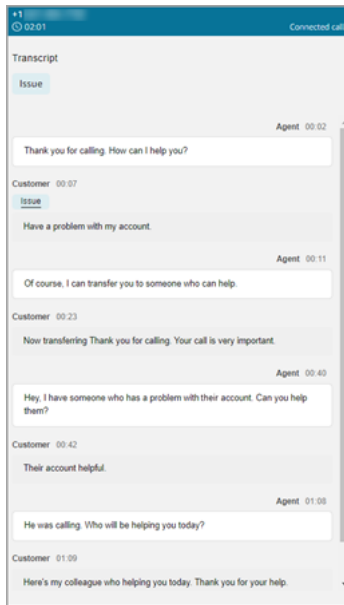

Because Contact Lens is not enabled in the transfer flow, agent 2 doesn't see the remainder of the transcript when the call has ended and they enter ACW. The following image of ACW for agent 2 shows the transcript is empty.

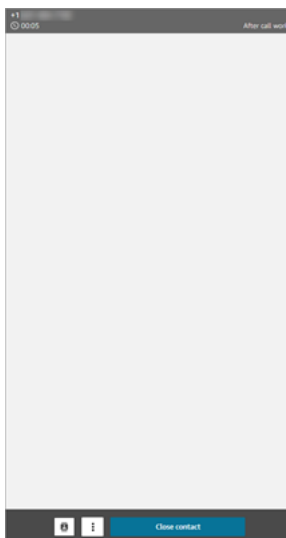

Use case 2: Contact Lens analytics is enabled in an inbound flow and a transfer flow (quick connect)

- A contact enters the inbound flow, and there are no call transfers. Following is the agent experience:

- Agent 1 receives a full call transcript (unredacted) during ACW.

The transcript includes everything said by agent 1 and the customer from the moment the agent accepts the call, until the call has ended. This is shown in the following image of the CCP for agent 1.

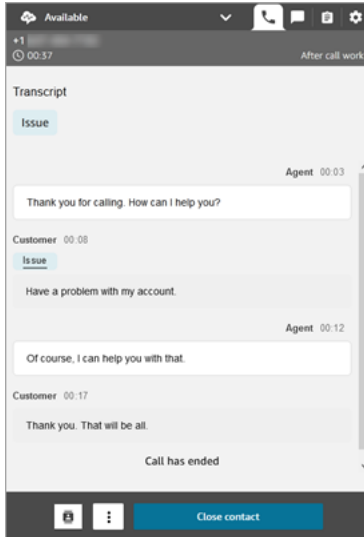

- A contact enters the inbound flow, and there is a call transfer. Following is the agent experience:
 - Agent 1 receives a call transcript after they leave the conference/warm transfer, during ACW.

The transcript includes everything said by agent 1 and the customer from the moment agent 1 accepts the call, until agent 1 leaves the conference/warm transfer portion of the call. The transcript includes flow (transfer/queue flow) prompt messages.

The full call transcript until warm transfer is shown in the following image.

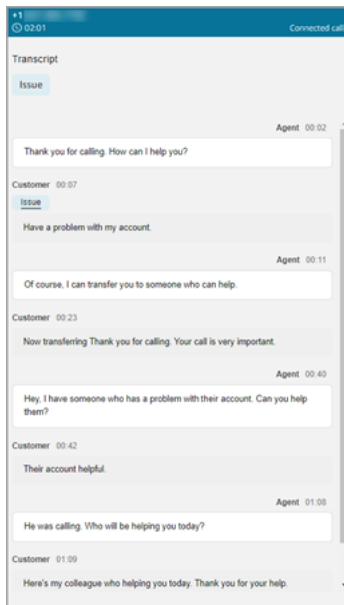

- Agent 2 receives a call transcript at the time of accepting the conference/warm transfer call from agent 1.

The transcript includes everything said by agent 1 and the customer, from the moment agent 1 accepts the call, until agent 1 leaves the conference/warm transfer portion of the call. The transcript includes the flow (transfer/queue flow) prompt messages.

- Because Contact Lens is enabled in the transfer flow, agent 2 receives a call transcript after the call is completed, during ACW.

The transcript includes only the remaining portion of the call between agent 2 and customer, after agent 1 has left the call. The transcript includes everything said by agent 2 and the customer, from the moment they are conferenced/warm transferred in, until the call has ended. An example transcript is shown in the following image.

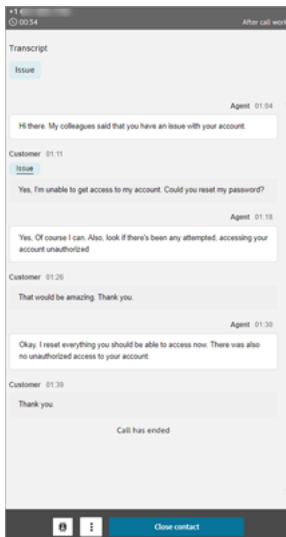

What if the flow block fails to enable Contact Lens?

It's possible that the [Set recording and analytics behavior](#) block can fail to enable Contact Lens on a contact. If Contact Lens isn't enabled for a contact, [check the flow logs](#) for the error.

Multi-party calls and Contact Lens

Contact Lens supports calls with up to 2 participants. For example, if there are more than two parties (agent and customer) on a call, or a call is getting transferred to a third party, the quality of the transcription and analytics, such as sentiment, redaction, categories among others, can get degraded. We recommend you disable Contact Lens for multi-party or third-party calls if there are more than two parties (agent and customer). For information on disabling Contact Lens for a contact, see [Flow block: Set recording and analytics behavior](#).

Security profile permissions for Contact Lens

To keep customer data secure, you can set up permissions to have granular control on who can access information generated by Contact Lens.

The following image shows the **Analytics and Optimization** security profile permissions that apply to Contact Lens.

Analytics and Optimization	
This group gives access to real-time metrics, historical metrics, contact trac	
Type	All
Access metrics	<input type="checkbox"/>
Real-time metrics ⓘ	<input type="checkbox"/>
Historical metrics ⓘ	<input type="checkbox"/>
Agent activity audit ⓘ	<input type="checkbox"/>
Contact search ⓘ	<input type="checkbox"/>
View my contacts ⓘ	<input type="checkbox"/>
Search contacts by conversation characteristics	<input type="checkbox"/>
Search contacts by keywords	<input type="checkbox"/>
Configure searchable contact attributes	<input type="checkbox"/>
Restrict contact access ⓘ	<input type="checkbox"/>
Contact attributes ⓘ	<input type="checkbox"/>
Contact Lens - conversational analytics	<input type="checkbox"/>
Contact Lens - custom vocabularies ⓘ	<input type="checkbox"/>
Contact Lens - theme detection	<input type="checkbox"/>
Rules	<input type="checkbox"/>
Recorded conversations (redacted)	<input type="checkbox"/>
Login/Logout report	<input type="checkbox"/>
Real-time contact monitoring	<input type="checkbox"/>
Real-time contact barge-in	<input type="checkbox"/>
Recorded conversations (unredacted)	<input type="checkbox"/>
Saved reports	<input type="checkbox"/>

Following is a description of the permissions.

Contact search

This permission isn't specific to Contact Lens, but it is required so you can access the **Contact search** page, which is where you can search contacts so you can review the analyzed recording and transcript. In addition, you can do fast, full-text search on call transcripts, and search by sentiment score and non-talk time.

View my contacts

This permission isn't specific to Contact Lens, but it is required if you need to access the **Contact search** page, review only those contacts that you handled, and review the analyzed recording and transcripts.

Important

If both **Contact search** and **View my contacts** permissions are granted, then the user will have access to all contacts.

Search contacts by conversation characteristics

On the **Contact Search** page:

- For voice contacts, you can access additional filters that allow you to return results by sentiment score and non-talk time.
- For chat contacts, you can access an additional filter to search for contacts by response time.
- For both voice and chat, you can search conversations that fall into specific contact categories.

For more information, see [Search for sentiment score/shift](#), [Search for non-talk time](#), and [Search a contact category](#).

The following image shows of the **Filters** section of the **Contact Search** page, and the **Filters** dropdown menu. Filters with **CL** next to them are only available to users who have this security profile permission.

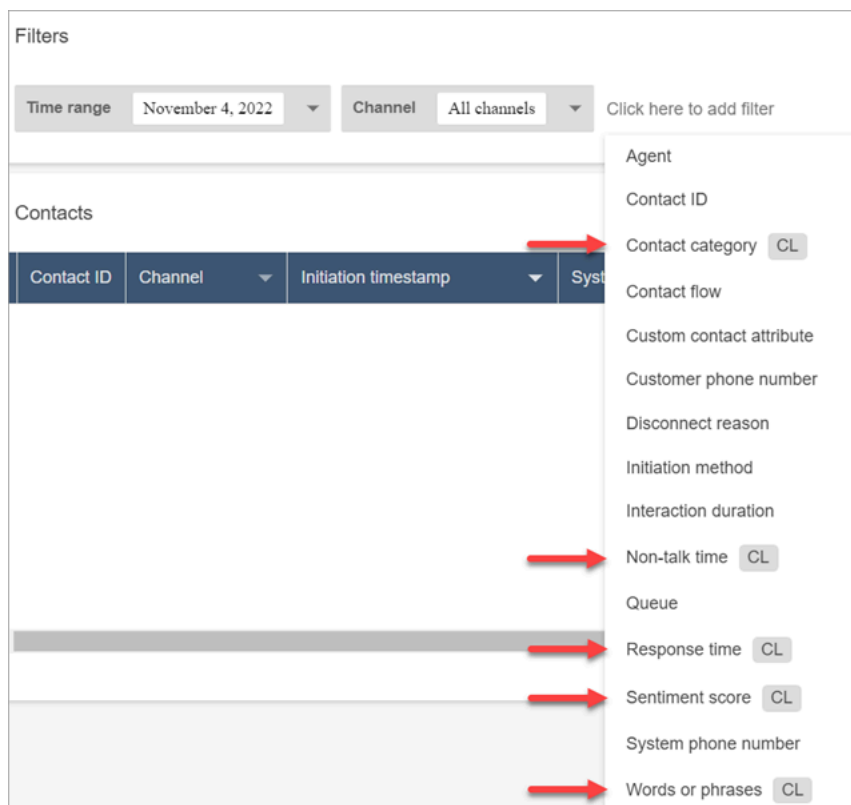

Search contacts by keywords

On the **Contact Search** page, you can access additional filters that allow you to search contacts by **Words or phrases**, such as *"thank you for your business."* For more information, see [Search for words or phrases](#).



Contact Lens - conversational analytics

On the **Contact details** you can view graphs that summarize conversational analytics (customer sentiment, talk time for voice contacts), as well as sentiment colors and indicators for each conversation turn on transcripts and recordings. For example, the following image shows how this information is displayed on the **Contact details** page for a voice contact.

Contact Lens - conversational analytics - View permission is also required to view sentiment indicators on conversation recordings and transcripts.

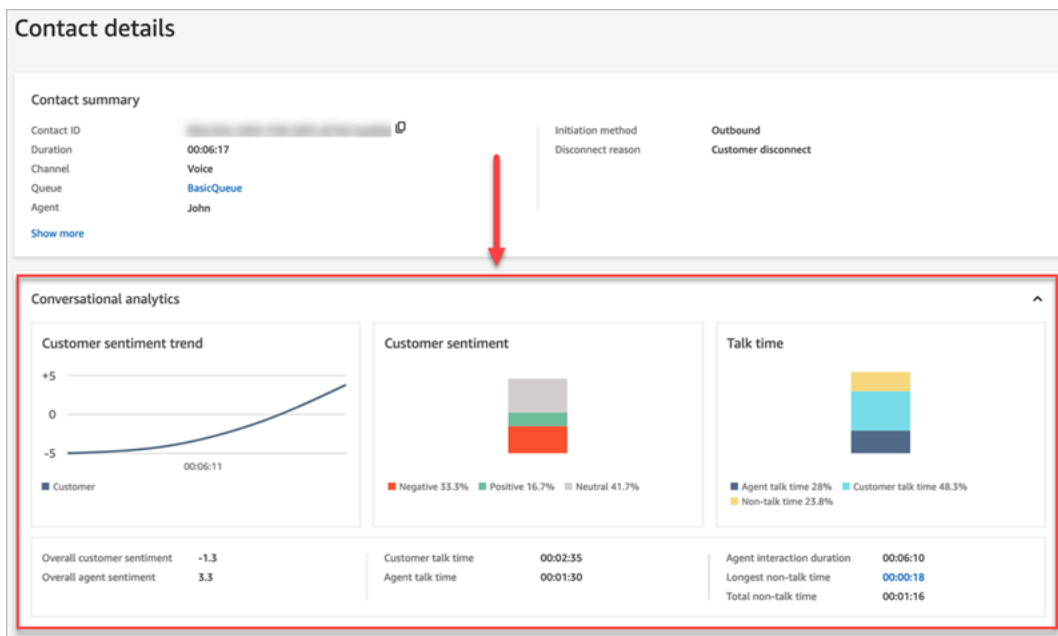

Rules

This permission allows you to view, edit, or create rules for categorizing contacts. For more information, see [Automatically categorize contacts based on keywords and phrases used during a conversation.](#)

Recorded conversations (redacted)

On the **Contact details** and **Contact search** pages for a contact, this permission allows you to listen to call recording files or view the chat transcript in which the sensitive data has been removed. For more information, see [Example redacted file for a call.](#)

Recorded conversations (unredacted)

On the **Contact details** and **Contact search** pages, this permission manages access to unredacted content that contains sensitive data such as name and credit card information. It manages access to the following unredacted content:

- Original, unredacted chat and speech transcripts analyzed by Contact Lens
- Original, unredacted transcripts analyzed by Contact Lens
- Original, unredacted audio recordings

You can access this content on the **Contact details** page for a contact. For more information, see [Example original, analyzed file for a call](#).

Important

If you have permissions to both **Recorded conversations (redacted)** and **Recorded conversations (unredacted)**, note the following behavior:

- By default only redacted recordings and transcripts are made available on the **Contact details** and **Contact search** pages.
- When no redacted content exists for the contact, or when redacted content cannot be shown to the user, then unredacted content is displayed on the **Contact details** and **Contact search** pages.

To access unredacted conversations, remove permissions to **Recorded conversations (redacted)**. This leaves the user with only **Recorded conversations (unredacted)** permissions.

You cannot access both the redacted and unredacted version of a conversation at the same time.

Contact Lens notification types

Contact Lens provides the following notification types:

- **Contact Lens Post Call/Chat Rules Matched:** An EventBridge event is delivered whenever a Contact Lens rule is matched and has triggered the EventBridge rule action.

This event contains useful information about the Contact Lens rule that is triggered including the category assigned, and details of the agent, contact and queue.

- **Contact Lens Real Time Call/Chat Rules Matched:** An EventBridge event is delivered whenever a Contact Lens rule is matched and has triggered in real time.

This event contains useful information about the Contact Lens rule that is triggered including the category assigned, and details of the agent, contact and queue.

- **Contact Lens Analysis State Change:** An EventBridge event is delivered when Contact Lens is unable to analyze a contact recording. The event contains the Event Reason Code which provides the details on why it was unable to process the recording.

You can use these notification types in a variety of scenarios. For example, use Contact Lens analysis State Change events to signal unexpected errors in the processing of a contact file where EventBridge event details can be subsequently stored in a CloudWatch log for additional review, trigger additional workflows, or alert relevant support teams for further investigation.

The Contact Lens events for speech and chat analytics enable numerous new use cases such as surfacing and visualization of additional insights, for example:

- Generate alerts on real-time customer sentiment drops across all call and chat conversations
- Aggregating and reporting on reoccurring issues and topics
- Measuring the impact of the latest marketing campaign by detecting how many customers referenced it during a call
- Customizing agent compliance standards for each Region and lines of business, and enrolling agents into additional training where required.

Add custom vocabularies

You can improve the accuracy of speech recognition for product names, brand names, and domain-specific terminology, by expanding and tailoring the vocabulary of the speech-to-text engine in Contact Lens.

This topic explains how to add custom vocabularies using the Amazon Connect admin website. You can also add them using the [CreateVocabulary](#) and [AssociateDefaultVocabulary](#) APIs.

Things to know about custom vocabularies

- You must set a vocabulary as the **default** for it to be applied to the analyses to generate transcripts. The following image shows the **Custom vocabularies** page. Choose the ellipsis, and then choose **Set as default**.

Name	Language	State
Test- [REDACTED]	British English	Ready (default)
TestUpload	Scottish English	Ready

	<ul style="list-style-type: none"> Set as default Download Remove 	25 ▾	1 -
--	--	------	-----

- You can have one vocabulary per language applied to the analyses. This means only one file per language can be in the **Ready (default)** state.
- You can upload and activate up to 20 vocabulary files. You can activate all 20 files at the same time.
- Transcription is a one-time event. A newly uploaded vocabulary isn't applied retroactively to existing transcriptions.
- Your text file must be in LF format. If you use any other format, such CRLF format, your custom vocabulary is not accepted by Amazon Transcribe.
- The sample vocabulary file can be downloaded only when you choose an English language setting.
- For limits to the size of a vocabulary file and other requirements, see [Custom vocabularies](#) in the *Amazon Transcribe Developer Guide*.
- Custom vocabularies apply to speech analytics only. They do not apply to chat conversations because the transcripts already exist.

Required permissions

Before you can add custom vocabularies to Amazon Connect, you need the **Analytics and Optimization, Contact Lens - custom vocabularies** permission assigned to your security profile.

By default, in new instances of Amazon Connect the **Admin** and **CallCenterManager** security profiles have this permission.

For information about how to add more permissions to an existing security profile, see [Update security profiles](#).

Add a custom vocabulary

1. Log in to Amazon Connect with a user account that has the required permissions to add custom vocabularies.
2. Navigate to **Analytics and optimization, Custom vocabularies**.
3. Choose **Add custom vocabulary**.
4. On the **Add custom vocabulary** page, enter a name for the vocabulary, choose an English language, and then choose **Download a sample file**.

Note

The sample vocabulary file can be downloaded only when you choose an English language setting. Otherwise, an error message is displayed, as shown in the following image.

Language	State
Australian English	Ready
Australian English	Processing the vocabulary failed, please check the documentation and try again
French	Failed
French	Ready

The following image shows what the sample vocabulary file looks like. The header contains Phrase, IPA, SoundsLike, DisplayAs. The header is required.

This is the header. It is required.

```

sample-table-type-file (2) - Notepad
File Edit Format View Help
Phrase IPA SoundsLike DisplayAs
Los-Angeles Los Angeles
F.B.I. ε f b i aɪ FBI
Etienne eh-tee-en
  
```

5. The information in the file is separated by one [TAB] per entry. For details about how to add words and acronyms to your vocabulary file, see [Creating a custom vocabulary using a table](#) in the *Amazon Transcribe Developer Guide*.

The following image shows words in a sample vocabulary file. Words in the Phrase column are required. Words in the IPA, SoundsLike, and DisplayAs columns are optional.

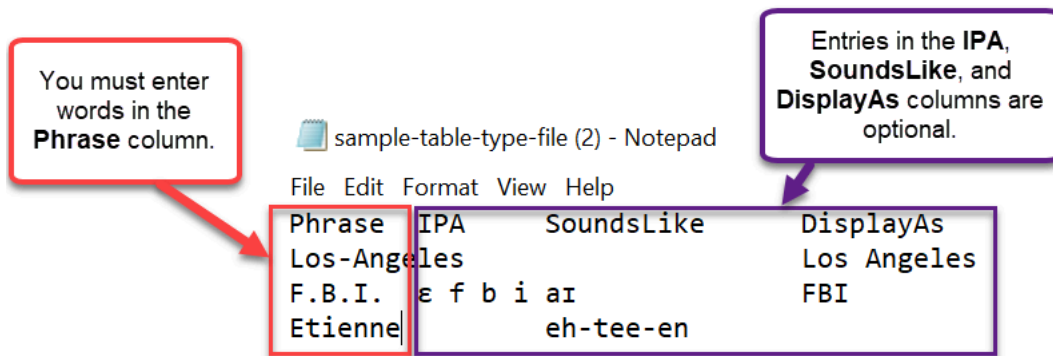

To enter multiple words in the **Phrase** column, separate each word with a hyphen (-); do not use spaces.

Vocabulary states

- **Ready (default):** The vocabulary is being applied to the analyses to generate transcripts. It is applied to both real-time and post-call analyses.
- **Ready:** The vocabulary is not being applied to analyses, but it is a valid file and available. To apply it to analyses, set it to default.
- **Processing:** Amazon Connect is validating your uploaded vocabulary and trying to apply it to the analyses to generate transcripts.
- **Deleting:** You chose to **Remove** the vocabulary, and Amazon Connect is deleting it now.

It takes about 90 minutes for Amazon Connect to delete a vocabulary.

If you attempt to upload a vocabulary that does not validate, it results in a **Failed** state. For example, if you add multiple-word phrases to the **Phrase** column, and separate them with spaces instead of hyphens, it will fail.

Download and view a custom vocabulary

To view a custom vocabulary that has been uploaded, you download and open the file. Only files in the **Ready** state can be downloaded and viewed.

1. Navigate to **Analytics and optimization, Custom vocabularies**.
2. Choose **More, Download**. The location of **Download** is shown in the following image.

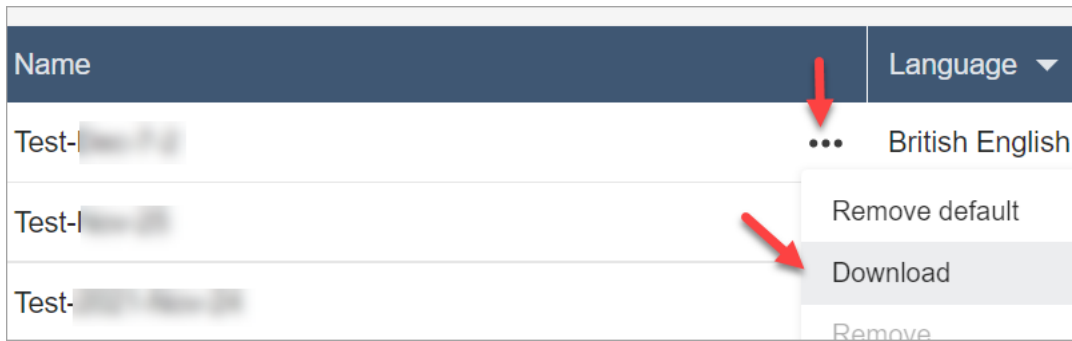

3. Open the download to view the contents.
4. You can change the contents, and then choose **Save and upload**.

Create rules with Contact Lens

Contact Lens rules allow you to automatically categorize contacts, receive alerts, or generate tasks based on keywords that are used during a call or chat, sentiment scores, customer attributes, and other criteria.

This topic explains how to create rules using the Amazon Connect admin website. To create and manage rules programmatically, see [Rules actions](#) and the [Amazon Connect Rules Function language](#) in the *Amazon Connect API Reference Guide*.

Tip

For a list of rules feature specifications (for example, how many rules you can create), see [Amazon Connect Rules feature specifications](#).

Step 1: Define rule conditions

1. On the navigation menu, choose **Analytics and optimization, Rules**.
2. Select **Create a rule, Conversational analytics**.
3. Under **When**, use the dropdown list to choose **post-call analysis, real-time analysis, or post-chat analysis**.

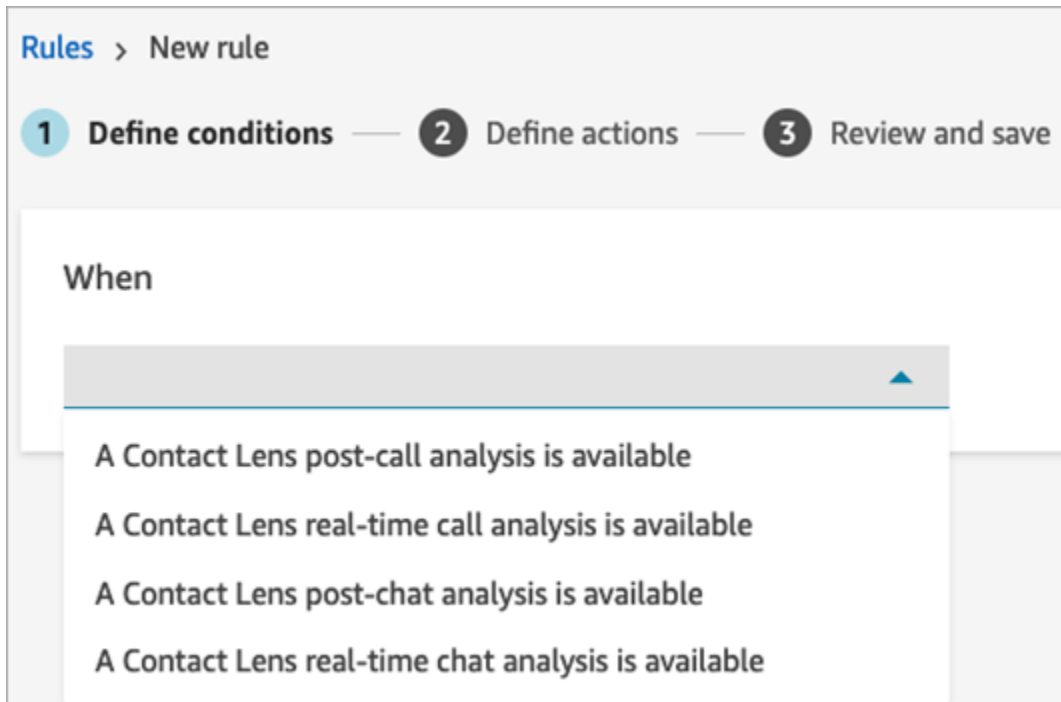

4. Choose **Add condition**.

You can combine criteria from a large set of conditions to build very specific Contact Lens rules. Following are the available conditions:

- **Words or phrases:** Choose from [Exact match](#), [Pattern match](#), or [Semantic match](#) to trigger an alert or task when keywords are uttered.
- **Agent:** Build rules that run on a subset of agents. For example, create a rule to ensure newly hired agents comply with company standards.

To see agent names so you can add them to rules, you need **Users - View** permissions in your security profile.

- **Queues:** Build rules that run on a subset of queues. Often organizations use queues to indicate a line of business, topic, or domain. For example, you could build rules specifically for your sales queues, tracking the impact of a recent marketing campaign or alternatively rules for your customer support queues, tracking overall sentiment.

To see the queue names so you can add them to rules, you need **Queues - View** permissions in your security profile.

- **Contact attributes:** Build rules that run on the values of custom [contact attributes](#). For example, you can build rules specifically for a particular line of business or for specific

customers, such as based on their membership level, their current country of residence, or if they have an outstanding order.

You can add up to five contact attributes to a rule.

- **Sentiment - Time period:** Build rules that run on the sentiment analysis results (positive, negative, or neutral) over a trailing window of time.

For example, you can build a rule for when customer sentiment has remained negative for a set period of time. If the participant joined the contact later, the time period set here applies to when participant was present.

- **Sentiment - Entire contact:** Build rules that run on the value of sentiment scores over an entire contact. For example, you can build a rule when customer sentiment has remained low for the entire contact, you can create a task for a customer experience analyst to review the call transcript and follow-up.
- **Interruptions:** Build rules that detect when the agent has interrupted the customer for more than X times. This feature applies to calls only.
- **Non-talk time:** Build rules that run when periods of no talk time are detected. For example, when a customer and agent have not spoken for over 30 seconds which may indicate unnecessary customer wait time or highlight a customer services process that would benefit from optimisation. This feature applies to calls only.
- **Response time:** Build rules to identify contacts where the participant had a response time longer or shorter than what was expected: Average or Maximum.

For example, you can set a rule on the **Agent greeting time**, also known as **First response time**: after the agent joined the chat, how long until they sent the first greeting message. This will help you to identify when an agent took too long to engage with the customer.

The following image shows a sample rule with multiple conditions for a voice contact.

If **all** of these conditions are met

Words or phrases - Semantic match
Limit: 100 words or phrases total for the rule

Logic: Any of the following words or phrases were mentioned during the entire length of the contact, where speaker is agent

Enter keywords or phrases. Comma separate multiples entries.

Keywords or phrases

Thank you for calling

Agents

carlos (Salazar, Carlos) X janedoe (Doe, Jane) X

Queues

Queue1 X

Contact attributes

OfficeLocation = Seattle

Contact attributes

CustomerType = VIP

Sentiment - Time period
Set a condition with average sentiment score within a time period

Customer sentiment was positive during the last 30 seconds of the contact

The following image shows a sample rule with multiple conditions for a chat contact. The rule is triggered when the **First** response time is greater than or equal to 1 minute, and the agent did not mention any of the listed greeting words or phrases in their first response.

First response time = after the agent has joined the chat, how long until they sent the first message to the customer.

When

A Contact Lens post-chat analysis is available

any of these conditions are met

Chat - Response time
Set a condition with the time it takes for an agent to respond to chat queries

First agent response time was >= 1 minutes

Words or phrases - Exact match
Limit: 100 words or phrases total for the rule

Logic: Any of the following words or phrases were not mentioned during the first 1 minutes after the participant has joined the contact, where participant is agent

Enter keywords or phrases. Comma separate multiples entries. Add

Keywords or phrases

- Good day
- Hello
- Hi
- Welcome

This rule is triggered when the agent took longer than 1 minute to send the first chat message to the customer, after they joined the conversation.

Or the agent didn't use any of these words in the first 1 minute of joining the contact.

5. Choose **Next**.

Step 2: Define rule actions

1. Choose **Add action**. You can choose the following actions:
 - [Create Task](#): this option is not available for real-time chat
 - [Send email notification](#)
 - [Generate an EventBridge event](#)

Rules > New rule

Define conditions —
 2 Define actions —
 3 Review and save

Take these actions

Add action

- Create Task
- Send email notification
- Generate an EventBridge event

Cancel

2. Choose **Next**.
3. Review and make any edits, then choose **Save**.
4. After you add rules, they are applied to new contacts that occur after the rule was added. Rules are applied when Contact Lens analyzes conversations.

You cannot apply rules to past, stored conversations.

Automatically categorize contacts based on keywords and phrases used during a conversation

You can set up Contact Lens to track issues that you know exist in your contact center ("known knows"), and monitor any changes over time.

You can label your contacts based on predefined criteria you set up, that is, keywords and phrases you want to detect. Through categorization, each contact is analyzed for these criteria, and labeled.

This is useful to do when, for example, you want to ensure that agents are using certain words or phrases in calls or chats, for compliance reasons. Or, for example, you want to investigate when customers use certain words and have a negative sentiment.

To set up this feature, add rules that contain the words or phrases that you want to highlight.

In a **Contact details** page for a chat, categories appear above the transcript, as shown in the following image.

The screenshot displays the Amazon Connect interface for a chat conversation. At the top, there is an 'Interactions' timeline showing the sequence of messages between the Customer, Agent, and System/Bot. Below this, the 'Transcript' section is visible, featuring a 'Categories' bar with three items: 'LostBusiness', 'AgentNoHello', and 'NoSentimentImprovement'. A red arrow points from a text box to the 'NoSentimentImprovement' category. The transcript itself shows a customer message: 'As I wrote - I did not receive my reward points after my stay at your hotel!!!'. A 'Show transcript summary' toggle is located on the right side of the transcript area.

Interactions

Customer

Agent

System / Bot

0:00 / 9:49

0 5:00 10:00 25:00 30:00 Legend ⓘ

Transcript

Categories

LostBusiness AgentNoHello NoSentimentImprovement

Customer ([PII]) 00:38 Issue

As I wrote - I did not receive my reward points after my stay at your hotel!!!

Show transcript summary

These rules contain the words or phrases you want to highlight in the transcript.

Click or tap the rule to automatically navigate to the section of the transcript with the highlighted content.

The following image shows what a **Contact details** page looks like with a category for a call. The category is named **cancellation**. It contains the words or phrases you want to highlight in the analysis.

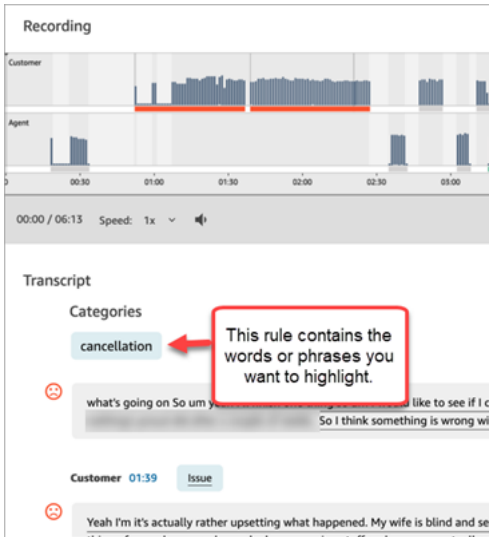

Add rules to categorize contacts

Step 1: Define conditions

1. Log in to Amazon Connect with a user account that is assigned the **CallCenterManager** security profile, or that is enabled for **Rules** permissions.
2. On the navigation menu, choose **Analytics and optimization, Rules**.
3. Select **Create a rule, Conversational analytics**.
4. Assign a name to the rule.
5. Under **When**, use the dropdown list to choose **post-call analysis, real-time analysis, post-chat analysis** or **real-time chat analysis**.

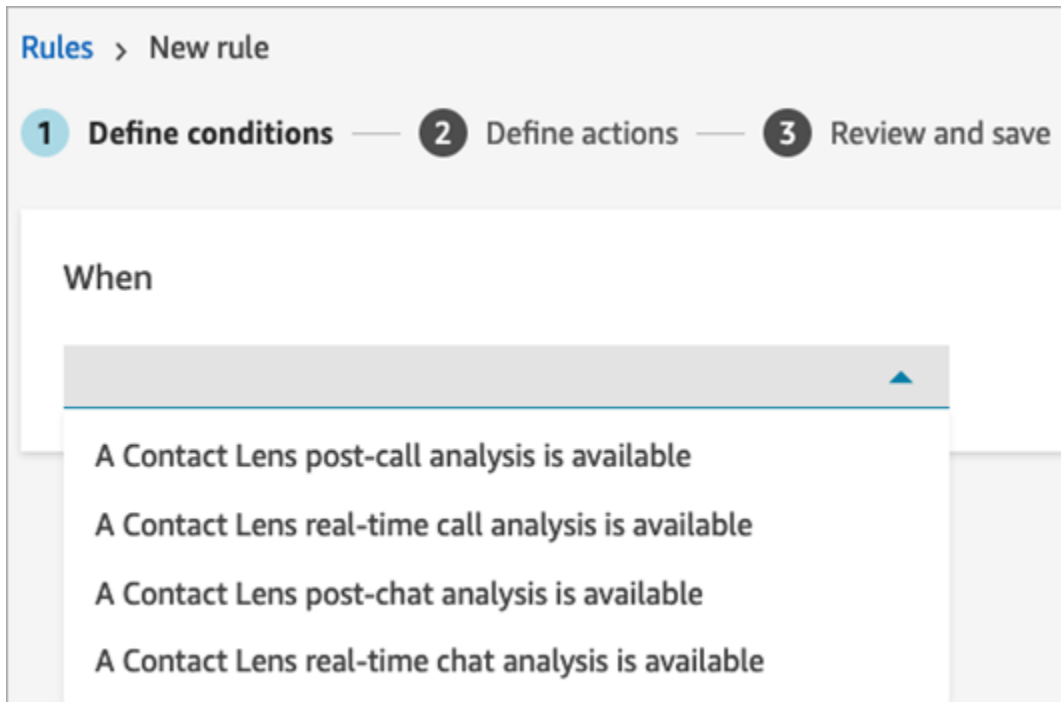

6. Choose **Add condition**, and then choose the type of match:

- **Exact Match:** Finds only the exact words or phrases. Enter the words or phrases, separated by a comma.
- **Semantic Match:** Finds words that may be synonyms. For example, if you enter "upset" it can match "not happy," or "hardly acceptable" can match with "unacceptable," and "unsubscribe" can match with "cancel subscription."

Similarly, it can semantically match phrases. For example, "thank you so much for helping me out," "thanks a lot and this is so helpful," and "I am so happy that you are able to help me."

This removes the need to define an exhaustive list of keywords while creating categories, and provides you the ability to cast a wider net for searching similar phrases that are important to you.

For best semantic matching results, provide keywords or phrases with similar meaning within a semantic matching card. Currently, you can provide a maximum of four keywords and phrases per semantic matching card.

- **Pattern Match:** Finds matches that may be less than 100 percent exact. You can also specify the distance between words. For example, if you are looking for contacts where the word "credit" was mentioned but you do not want to see any mention of the words "credit card,"

you can define a pattern matching category to look for the word "credit" that is not within a one-word distance of "card."

- Using **Exact Match** as an example, enter the words or phrases, separated by a comma, that you want to highlight.

The screenshot shows the configuration for a rule named "Words or phrases - Exact match" with a limit of 100 words or phrases. The logic is set to "Any of the following words or phrases were mentioned during the entire length of the contact, where participant is agent". A text input field contains the phrase "Hello thank you for calling Example Corp. we value your business, how may I assist you" with an "Add" button. Below this is a table for "Keywords or phrases" which is currently empty. A red box highlights the input field with the text "Enter multiple words or phrases, separated by a comma." Another red box points to the "entire" dropdown in the logic, with the text "Choose when in the conversation the words or phrases need to be uttered." A third red box points to the "agent" dropdown, with the text "Choose who needs to utter the words."

- Choose **Add**. Each word or phrase separated by a comma gets its own line in the card.

This screenshot shows the same configuration as the previous one, but now the "Keywords or phrases" table contains three entries: "Hello thank you for calling Example Corp", "we value your business", and "how may I assist you". Each entry has a copy icon and a delete icon. A red box points to the "Add" button with the text "When you choose Add, each entry gets its own line." Another red box points to the first entry in the table.

The logic that Contact Lens uses to read these phrases is: (Hello AND thank AND you AND for AND calling AND Example AND Corp) OR (we AND value AND your AND business) OR (how AND may AND I AND assist AND you).

- To add more words or phrases, choose **Add group of words or phrases**. In the following image, the first group of words or phrases are what the agent might utter, and the second group is what the customer might utter.

Words or phrases - Exact match
Limit: 100 words or phrases total for the rule

Logic: Any of the following words or phrases were mentioned during the entire length of the contact, where participant is agent

Enter keywords or phrases. Comma separate multiples entries. Add

Keywords or phrases

Hello thank you for calling Example Corp

we value your business

how may I assist you

AND

Words or phrases - Exact match
Limit: 100 words or phrases total for the rule

Logic: Any of the following words or phrases were mentioned during the entire length of the contact, where participant is customer

Enter keywords or phrases. Comma separate multiples entries. Add

Keywords or phrases

new account

reset password

1. The logic that Contact Lens uses to read these phrases is: (Hello AND thank AND you AND for AND calling AND Example AND Corp) OR (we AND value AND your AND business) OR (how AND may AND I AND assist AND you).
2. The two cards are connected with an AND. This means, one of the rows in the first card needs to be uttered AND then one of the phrases in the second card needs to be uttered.

The logic that Contact Lens uses to read the two cards of words or phrases is (card 1) AND (card 2).

10. Choose **Add condition** to apply the rules to:

- Specific queues
- When contact attributes have certain values
- When sentiment scores have certain values

For example, the following image shows a rule that applies when an agent is working the BasicQueue or Billing and Payments queues, the customer is for auto insurance, and the agent is located in Seattle.

Words or phrases - Exact match
Limit: 100 words or phrases total for the rule

Logic: Any of the following words or phrases were mentioned during the entire length of the contact, where participant is customer

Enter keywords or phrases. Comma separate multiples entries. Add

Keywords or phrases

new account
reset password

Queues
Match any of the following queues

Include Select a queue
BasicQueue X Billing and Payments X

Contact attributes customerType = AutoInsurance

Contact attributes agentLocation = Seattle

+ Add condition + Add group

Step 2: Define actions

In addition to categorizing a contact, you can define what actions Amazon Connect should take:

1. [Generate an EventBridge event](#)
2. [Create Task](#)
3. [Create Case](#)
4. [Send email notifications](#)
5. [Create a rule that submits an automated evaluation](#)

Step 3: Review and save

1. When done, choose **Save**.
2. After you add rules, they are applied to new contacts that occur after the rule was added. Rules are applied when Contact Lens analyzes conversations.

You cannot apply rules to past, stored conversations.

Alert supervisors in real-time based on keywords and phrases mentioned during a call

After you [enable real-time analytics](#) in your flow, you can add rules that automatically alert supervisors when a customer experience issue occurs.

For example, Contact Lens can automatically send an alert when certain keywords or phrases are mentioned during the conversation, or when it detects other criteria. The supervisor sees the alert on the real-time metrics dashboard. From there, supervisors can listen in to the live call, and provide guidance to the agent over chat to help them resolve the issue faster.

The following image shows an example of what a supervisor would see on the real-time metrics report when they get an alert. In this case, Contact Lens has detected an angry customer situation.

Real-time metrics		
Agents		
Agent login	Channels	Agents
		Activity
loginname_a	All channels	On contact
	Voice	
	Escalation, Angry customer	
loginname_b	Voice	2 On contact
loginname_c	All channels	On contact
	Voice	
	Chat	

When the supervisor listens in to a live call, Contact Lens provides them with a real-time transcript and customer sentiment trend that helps them understand the situation and assess the appropriate action. The transcript also eliminates the need for customers to repeat themselves if they are transferred to another agent.

The following image shows a sample real-time transcript.

Real-Time Contact Summary

Summary

Contact Id: 75a1fd9e-511
 Channel: Voice
 Customer sentiment:

Customer sentiment

- Positive 20%
- Negative 33%
- Neutral 46%

Categories

Angry-Customer | Account-Cancellation **2**

Transcript

Last updated: Nov 27, 20, 02:47:48 pm

Agent 00:01
 Good morning, . thank you for contacting us today. I see you're a platinum member. Thank you for your loyalty. My name is . How can I help you today?

Customer 00:27
 Hi . I know it's not your fault, and I'm sorry about all this, but I'm telling you right now that I'm upset. I can't believe this is happening to me. I am considering to cancel my account.

Agent 00:43
 Thank you for saying that. I'm sorry there seems to be a problem. Could you tell me what's going on?

Customer 01:41
 OK. So it's Friday and I need to get to my pitch meeting by noon. It's not like I can just phone it in. I have to be there on time in person. I do this every week and it's not like it's usually a big deal. But this was important and I even called this morning to make sure that there was a note on the record but my ride was late. I mean, come on!

This counter alerts you that Contact Lens has detected 2 occurrences where the customer has mentioned cancellation.

Add rules for real-time alerts for calls

1. Log in to Amazon Connect with a user account that is assigned the **CallCenterManager** security profile, or that is enabled for **Rules** permissions.
2. On the navigation menu, choose **Analytics and optimization, Rules**.
3. Select **Create a rule, Conversational analytics**.
4. Assign a name to the rule.
5. Under **When**, use the dropdown list to choose **real-time analysis**.
6. Choose **Add condition**, and then choose the type of match:
 - **Exact Match:** Finds only the exact words or phrases.
 - **Pattern Match:** Finds matches that may be less than 100 percent exact. You can also specify the distance between words. For example, you might look for contacts where the word "credit" was mentioned, but you do not want to see any mention of the words "credit card."

You can define a pattern matching category to look for the word "credit" that is not within a one-word distance of the word "card."

Tip

Semantic Match isn't available for real-time analysis.

7. Enter the words or phrases, separated by a comma, that you want to highlight. Real-time rules only support any keywords or phrases that **were mentioned**.

Words and phrases
Limit: 100 strings total for the rule

Logic: **Any** of the following words or phrases were mentioned during the entire length of the contact, where speaker is customer

Talk to your manager, this is not helpful, speak to your supervisor, cancel my account, cancel my membership

Enter multiple words or phrases separated by a comma

8. Choose **Add**. Each word or phrase separated by a comma gets its own line.

Words and phrases
Limit: 100 strings total for the rule

Logic: **Any** of the following words or phrases were mentioned during the entire length of the contact, where speaker is customer

Enter keywords or phrases. Comma separate multiples entries.

Keyword and phrases	
Talk to your manager	Remove
this is not helpful	Remove
speak to your supervisor	Remove
cancel my account	Remove
cancel my membership	Remove

When you choose **Add**, each entry gets its own line

The logic that Contact Lens uses to read these words or phrases is: (Talk OR to OR your OR manager) OR (this OR is OR not OR helpful) OR (speak OR to OR your OR supervisor), etc.

9. To add more words or phrases, choose **Add group of words or phrases**. In the following image, the first group of words or phrases are what the agent might utter. The second group is what the customer might utter.

The screenshot displays two configuration cards for 'Words or phrases - Exact match' rules. Each card has a limit of 100 words or phrases. The first card is configured for 'agent' and contains three phrases: 'Hello thank you for calling Example Corp', 'we value your business', and 'how may I assist you'. The second card is configured for 'customer' and contains two phrases: 'new account' and 'reset password'. The two cards are connected by an 'AND' operator, indicating that both conditions must be met for the rule to trigger.

1. In this first card, Content Lens reads each line as an OR. For example: (Hello) OR (thank OR you OR for OR calling OR Example OR Corp) OR (we OR value OR your OR business).
2. The two cards are connected with an AND. This means, one of the rows in the first card needs to be uttered AND then one of the phrases in the second card needs to be uttered.

The logic that Contact Lens uses to read the two cards of words or phrases is (card 1) AND (card 2).

10. Choose **Add condition** to apply the rules to:
- Specific queues
 - When contact attributes have certain values
 - When sentiment scores have certain values

For example, the following image shows a rule that applies when an agent is working the BasicQueue or Billing and Payments queues, the customer is for auto insurance, and the agent is located in Seattle.

Words or phrases - Exact match
Limit: 100 words or phrases total for the rule

Logic: Any of the following words or phrases were mentioned during the entire length of the contact, where participant is customer

Enter keywords or phrases. Comma separate multiples entries. Add

Keywords or phrases

new account

reset password

Queues
Match any of the following queues

Include Select a queue

BasicQueue X Billing and Payments X

Contact attributes customerType = AutoInsurance

Contact attributes agentLocation = Seattle

+ Add condition + Add group

11. When done, choose **Next**.
12. In the **Assign contact category** box, add a name for the category. For example, **Compliant** or **Not_Compliant**.
13. Choose **Next**, then choose **Save and publish**.

Alert supervisors in real-time based on keywords and phrases mentioned during a chat

After you [enable real-time analytics](#) in your flow, you can add rules that automatically alert supervisors when a customer experience issue occurs.

For example, Contact Lens can automatically send an alert when certain keywords or phrases are mentioned during the chat, or when it detects other criteria. The supervisor can then view the **Contact details** page for a real-time chat to view the issue. From there, supervisors can join the chat, and provide guidance to the agent over chat to help them resolve the issue faster.

The following image shows an example of what a supervisor would see on the **Contact details** page when they get an alert for a real-time chat. In this case, Contact Lens has detected an angry customer situation.

The screenshot displays the 'Contact details' page for a chat session. At the top, it shows the contact status as 'In progress' and the last updated time as 'Oct 28, 2019, 10:36:32 pm'. Below this, the 'Overview' section provides details about the chat, including the start time '07:42 pm, Nov 14, 2023'. A table lists key attributes: Queue (BasicQueue), Agent (blurred), Initiation method (API), Disconnect reason (-), and Customer sentiment (represented by a red and green bar). The 'Interactions and transcript' section features a timeline chart showing customer and agent activity. A red box highlights a counter indicating '2' occurrences of 'Angry-Customer'. Below the chart, 'Key highlights' and 'Categories' are shown, with 'Angry-Customer' having a count of 2. The transcript includes a customer message: 'Hi, [blurred] I know it's not your fault, and I'm sorry about all this, but I'm telling you right now that I'm upset. I can't believe this is happening to me.' and another message: 'I am considering to cancel my account.'

When the supervisor monitors a chat, Contact Lens provides them with a real-time transcript and customer sentiment trend that helps them understand the situation and assess the appropriate action. The transcript also eliminates the need for customers to repeat themselves if they are transferred to another agent.

Add rules for real-time alerts for chats

1. Log in to Amazon Connect with a user account that is assigned the **CallCenterManager** security profile, or that is enabled for **Rules** permissions.
2. On the navigation menu, choose **Analytics and optimization, Rules**.

3. Select **Create a rule, Conversational analytics**.
4. Assign a name to the rule.
5. Under **When**, use the dropdown list to choose **real-time analysis**.
6. Choose **Add condition**, and then choose the type of match. The following image shows a rule configured for a **Sentiment - Time period** condition.

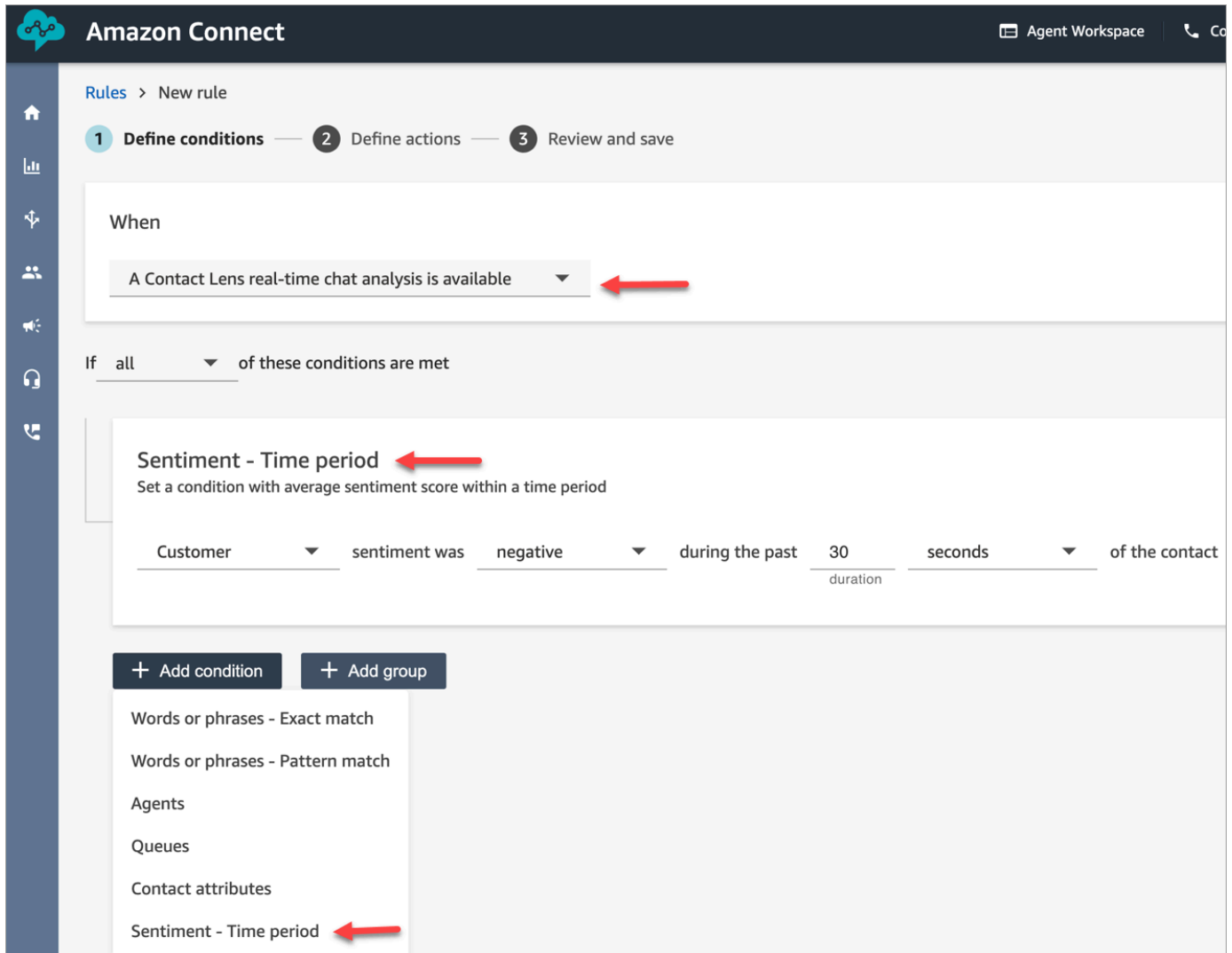

Choose from the following options:

- **Exact Match:** Finds only the exact words or phrases.
- **Pattern Match:** Finds matches that may be less than 100 percent exact. You can also specify the distance between words. For example, you might look for contacts where the word "credit" was mentioned, but you do not want to see any mention of the words "credit card."

You can define a pattern matching category to look for the word "credit" that is not within a one-word distance of the word "card."

Tip

Semantic Match isn't available for real-time analysis.

- 7. Enter the words or phrases, separated by a comma, that you want to highlight. Real-time rules only support any keywords or phrases that **were mentioned**.

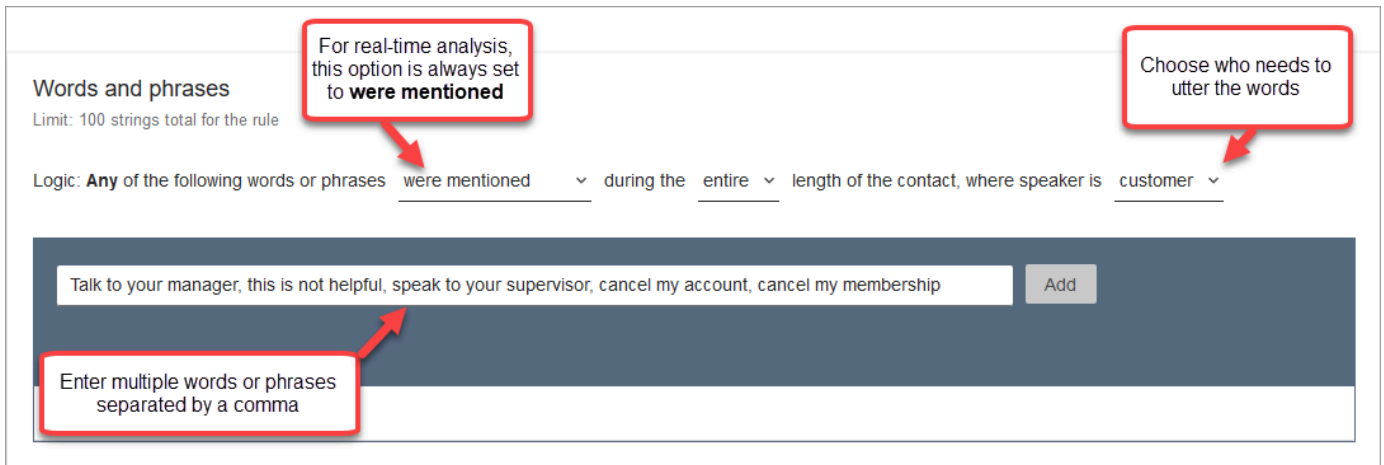

- 8. Choose **Add**. Each word or phrase separated by a comma gets its own line.

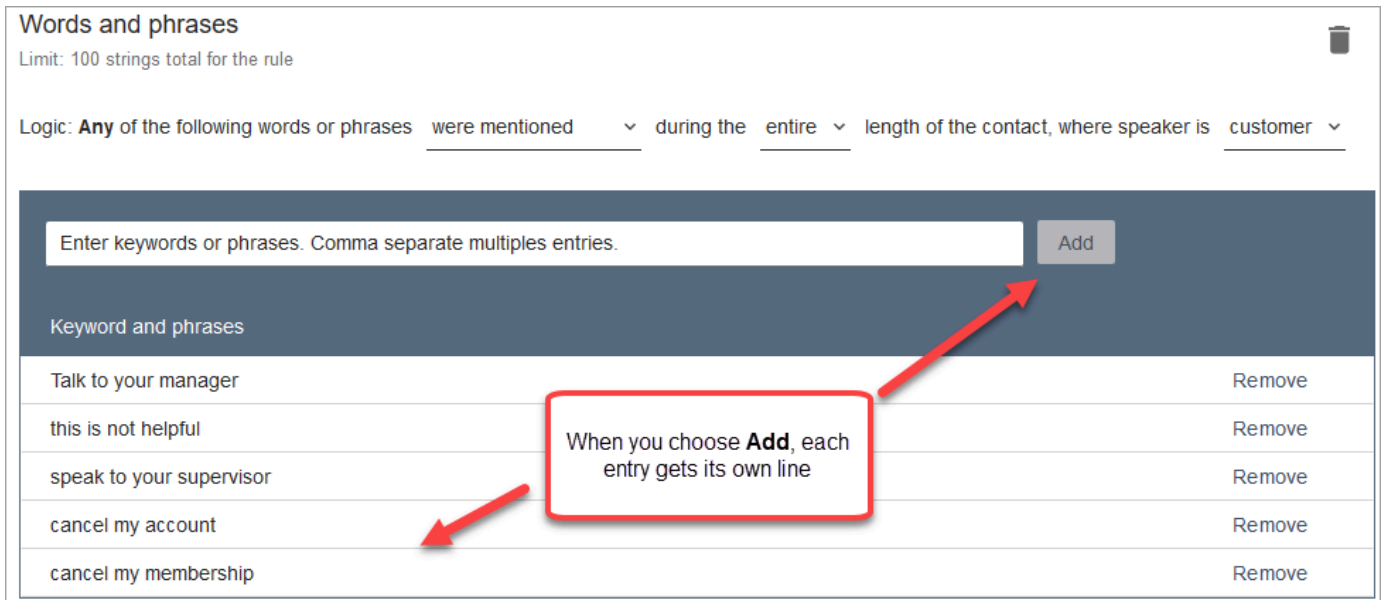

The logic that Contact Lens uses to read these words or phrases is: (Talk OR to OR your OR manager) OR (this OR is OR not OR helpful) OR (speak OR to OR your OR supervisor), etc.

9. To add more words or phrases, choose **Add group of words or phrases**. In the following image, the first group of words or phrases are what the agent might mention. The second group is what the customer might mention.

The screenshot displays two configuration cards for 'Words or phrases - Exact match' rules. Each card has a limit of 100 words or phrases. The first card is configured for 'agent' and contains three phrases: 'Hello thank you for calling Example Corp', 'we value your business', and 'how may I assist you'. The second card is configured for 'customer' and contains two phrases: 'new account' and 'reset password'. The two cards are connected by an 'AND' operator, indicating that both conditions must be met.

1. In this first card, Content Lens reads each line as an OR. For example: (Hello) OR (thank OR you OR for OR calling OR Example OR Corp) OR (we OR value OR your OR business).
2. The two cards are connected with an AND. This means, one of the rows in the first card needs to be mentioned AND then one of the phrases in the second card needs to be mentioned.

The logic that Contact Lens uses to read the two cards of words or phrases is (card 1) AND (card 2).

10. Choose **Add condition** to apply the rules to:
- Specific queues
 - When contact attributes have certain values
 - When sentiment scores have certain values

For example, the following image shows a rule that applies when an agent is working the BasicQueue or Billing and Payments queues, the customer is for auto insurance, and the agent is located in Seattle.

Words or phrases - Exact match
Limit: 100 words or phrases total for the rule

Logic: Any of the following words or phrases were mentioned during the entire length of the contact, where participant is customer

Enter keywords or phrases. Comma separate multiples entries. Add

Keywords or phrases

new account
reset password

Queues
Match any of the following queues

Include Select a queue
BasicQueue X Billing and Payments X

Contact attributes customerType = AutoInsurance

Contact attributes agentLocation = Seattle

+ Add condition + Add group

11. When done, choose **Next**.
12. In the **Assign contact category** box, add a name for the category. For example, **Compliant** or **Not_Compliant**.
13. Choose **Add action** to specify what action Amazon Connect should take when the conditions are met. You can configure supervisor alerts by using email notifications or by developing a custom integration with EventBridge.

✓ Define conditions — 2 Define actions — 3 Review and save

Take these actions

Assign contact category

Define the category ⓘ

Category name

PositiveSentiment

Name can contain characters A-Z, 0-9, or ".", "-", "_". It cannot contain spaces.

Add action

- Assign contact category
- Create task
- Generate an EventBridge event ←
- Send email notification ←

14. If you chose **Send email notification**, see [Create Contact Lens rules that send email notifications](#) for more details about completing the page and for information about email limits.

If you chose **Generate an EventBridge event**, see [Create a Contact Lens rule that generates an EventBridge event](#) for more details about completing the page and for information about subscribing to EventBridge event types.

Create Contact Lens rules that send email notifications

You can create Contact Lens rules that send email notifications to people in your organization. This helps you to respond more expediently to potential issues in your contact center. For example, you can create a rule to notify:

- A team supervisor when there is an account escalation or cancellation.
- A group of people in your contact center as a result of certain words being mentioned during a conversation.
- A designated person in your contact center when a disagreement occurs during the call.

All emails are sent from `no-reply@amazonconnect.com`.

To create a Contact Lens rule that sends an email notification

1. Log in to Amazon Connect with a user account that has the [required permissions](#) to create rules.
2. Navigate to **Analytics and optimization, Rules**.
3. On the **Rules** page, choose **Create a rule**, and then from the dropdown list, choose **Conversational analytics**.

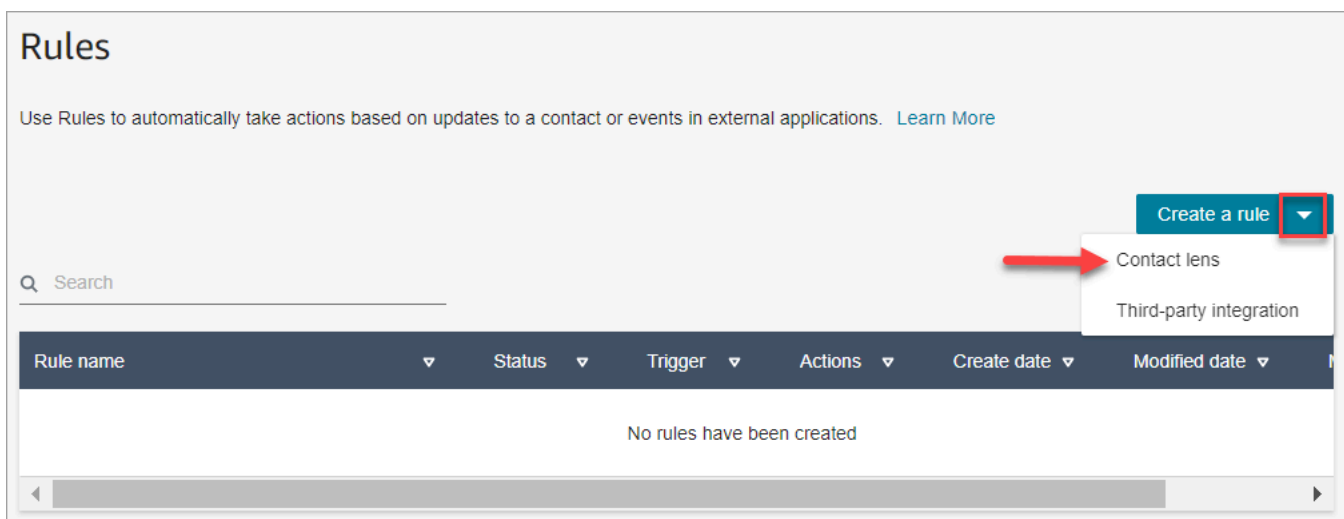

4. On the **New rule** page, define the conditions for the rule. For more information, see [Step 1: Define conditions](#).
5. When you define actions for the rule, choose **Send email notification** for the action.

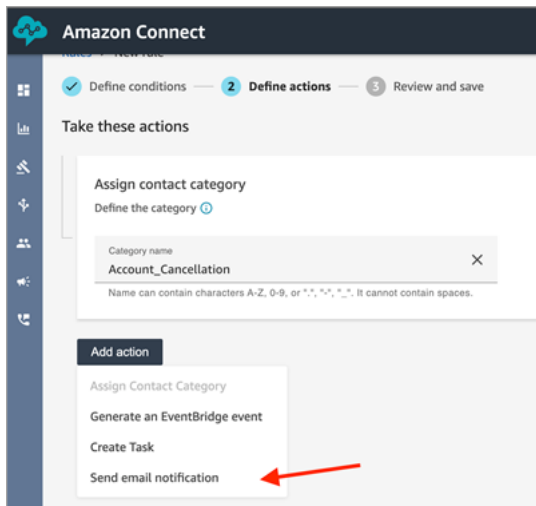

6. In the **Send email notification** section, choose who is going to receive the email by using one of these options:

- **Select recipients by login:** Routes the email to the specified user.
- **Select recipients by tags.** Routes the email dynamically based on the agent's tag values.

In the following image, the rule sends a notification email to the agent's team supervisor.

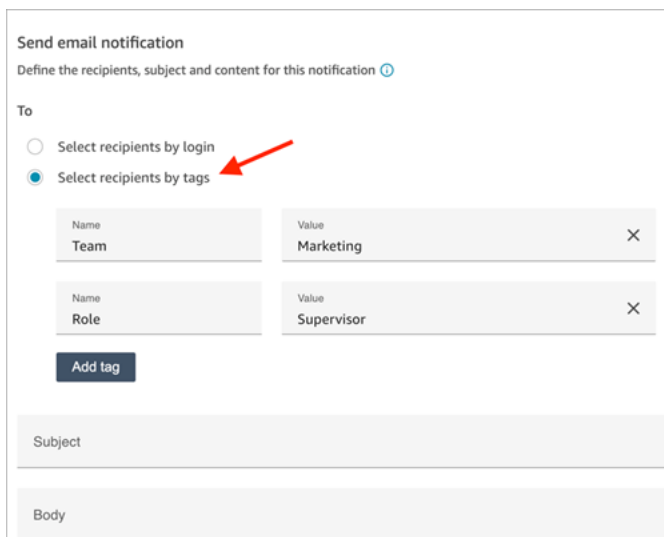

7. In **Subject**, add the email subject. In **Body**, add the contents of the email notification.

To specify contact attributes in the body of the email, type **[** and a list of available attributes appears, as shown in the following image. The available attributes are **ContactId**, **AgentId**, **QueueId**, **RuleName**, and **instance_url**.

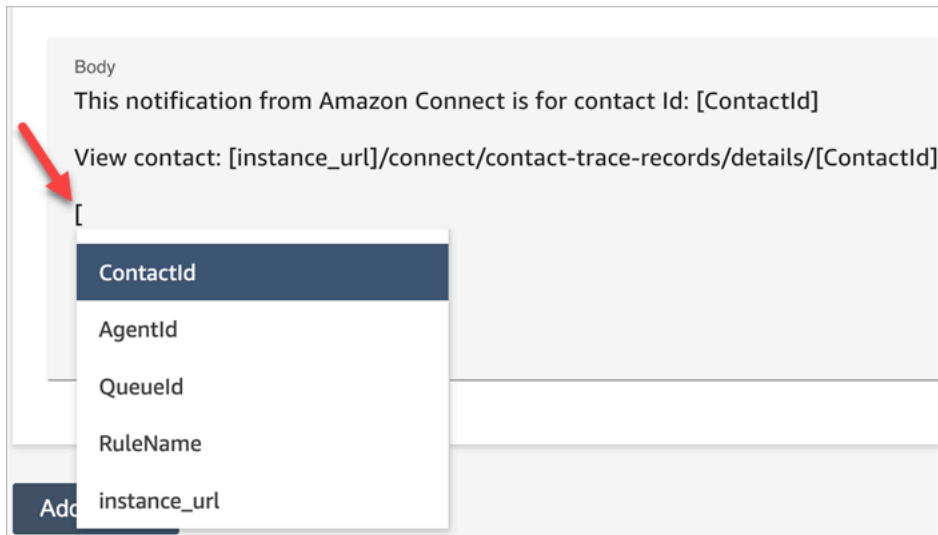

8. Choose **Next**. Review your selections, and then choose **Save**.
9. After you add rules, they are applied to new contacts that occur after the rule was added. Rules are applied when Contact Lens analyzes conversations.

You cannot apply rules to past, stored conversations.

Email limits

- Amazon Connect has a default limit of 500 emails a day. When that limit is exceeded, the Amazon Connect instance is blocked for 24 hours from sending more email. This is because the emails are subject to bounce and complaint limits. For more information, see the **Bounce** and **Complaint** sections in [Understanding email deliverability in Amazon SES](#).
- All emails are sent from `no-reply@amazonconnect.com`, which you cannot customize.

If the default option for sending emails does not meeting your requirements, please contact your Technical Account Manager or AWS Support to discuss with the Amazon Connect service team.

Create a Contact Lens rule that generates an EventBridge event

In real-time or post-call/chat, you can get events and use them to trigger subsequent notifications or alerts, or aggregate reports outside of Amazon Connect. There's a lot you can do with this data. For example:

- Get real-time alerts in a QuickSight dashboard.
- Create aggregated reported outside of Amazon Connect.

- Join data with your CRM.
- Connect your notification solution to EventBridge and make sure that by end of day, all of a certain type of events go to a certain inbox. The payload tells you the contact, agent, and queue.

To create a rule that generates an EventBridge event

1. When you create your rule, choose **Generate EventBridge event** for the action.

Take these actions

Assign contact category
Define the category

Category name
ACCOUNT_CANCELLATION

Name can contain characters A-Z, 0-9, or ".", "-", "_". It cannot contain spaces.

Add action

Assign Contact Category

Generate an EventBridge event

Create Task

2. For **Action name**, enter the name for the event payload.

Note

The value you assign for **Action name** is visible in the EventBridge payload. When you aggregate events, the action name provides an additional dimension that you can use to process them. For example, you have 200 category names, but only 50 have a specific action name, such as NOTIFY_CUSTOMER_RETENTION.

Take these actions

Assign contact category
Define the category

Category name
ACCOUNT_CANCELLATION

Name can contain characters A-Z, 0-9, or ".", "-", "_". It cannot contain spaces.

This appears in the EventBridge payload for "ruleName"

Generate an EventBridge event
Define an action name for the event payload ⓘ

Action name
NOTIFY_CUSTOMER_RETENTION

Action name can contain characters A-Z, 0-9, or ".", "-", "_". It cannot contain spaces.

This appears in the payload for "actionName"

3. Choose **Next**. Review and then **Save**.
4. After you add rules, they are applied to new contacts that occur after the rule was added. Rules are applied when Contact Lens analyzes conversations.

You cannot apply rules to past, stored conversations.

5. To leverage the EventBridge data, subscribe to the EventBridge event type. See the next procedure.

Subscribe to EventBridge event types

To subscribe to EventBridge event types, create a custom EventBridge rule that matches the following:

- "source" = "aws.connect"
- "detail-type" = "Contact Lens Analysis State Change" or one of the following:
 - **Contact Lens Post Call Rules Matched**

- **Contact Lens Realtime Rules Matched**
- **Contact Lens Realtime Chat Rules Matched**
- **Contact Lens Post Chat Rules Matched**
- **Metrics Rules Matched**

The following image shows these settings in the Event pattern section of the new rule page.

Define pattern

Build or customize an Event Pattern or set a Schedule to invoke Targets.

Event pattern [Info](#)
Build a pattern to match events

Schedule [Info](#)
Invoke your targets on a schedule

Event matching pattern
You can use pre-defined pattern provided by a service or create a custom pattern

Pre-defined pattern by service

Custom pattern

Service provider
AWS services or custom/partner services

AWS

Service name
The name of partner service selected as the event source

Amazon Connect

Event type
The type of events as the source of the matching pattern

Contact Lens Analysis State Change

Event pattern Copy Edit

```

1 {
2   "source": ["aws.connect"],
3   "detail-type": ["Contact Lens Analysis State
4 }

```

▶ Sample event(s)

Example EventBridge payloads

Following is an example of what the EventBridge payload looks like when **Contact Lens Post Call Rules Matched**.

```

{
  "version": "0", // set by EventBridge
  "id": "aaaaaaaa-bbbb-cccc-dddd-bf3703467718", // set by EventBridge
  "source": "aws.connect",
  "detail-type": "Contact Lens Post Call Rules Matched",
  "account": "your AWS account ID",
  "time": "2020-04-27T18:43:48Z",
  "region": "us-east-1", // set by EventBridge
}

```

```

"resources": ["arn:aws:connect:us-east-1:your AWS account ID:instance/instance-ARN"],
"detail": {
  "version": "1.0",
  "ruleName": "ACCOUNT_CANCELLATION", // Rule name
  "actionName": "NOTIFY_CUSTOMER_RETENTION",
  "instanceArn": "arn:aws:connect:us-east-1:your AWS account ID:instance/instance-ARN",
  "contactArn": "arn:aws:connect:us-east-1:your AWS account ID:instance/instance-ARN/contact/contact-ARN",
  "agentArn": "arn:aws:connect:us-east-1:your AWS account ID:instance/instance-ARN/agent/agent-ARN",
  "queueArn": "arn:aws:connect:us-east-1:your AWS account ID:instance/instance-ARN/queue/queue-ARN",
}
}

```

Following is an example of what the payload looks like when **Contact Lens Realtime Rules Matched**.

```

{
  "version": "0", // set by EventBridge
  "id": "aaaaaaaa-bbbb-cccc-dddd-bf3703467718", // set by EventBridge
  "source": "aws.connect",
  "detail-type": "Contact Lens Realtime Rules Matched",
  "account": "your AWS account ID",
  "time": "2020-04-27T18:43:48Z",
  "region": "us-east-1", // set by EventBridge
  "resources": ["arn:aws:connect:us-east-1:your AWS account ID:instance/instance-ARN"],
  "detail": {
    "version": "1.0",
    "ruleName": "ACCOUNT_CANCELLATION", // Rule name
    "actionName": "NOTIFY_CUSTOMER_RETENTION",
    "instanceArn": "arn:aws:connect:us-east-1:your AWS account ID:instance/instance-ARN",
    "contactArn": "arn:aws:connect:us-east-1:your AWS account ID:instance/instance-ARN/contact/contact-ARN",
    "agentArn": "arn:aws:connect:us-east-1:your AWS account ID:instance/instance-ARN/agent/agent-ARN",
    "queueArn": "arn:aws:connect:us-east-1:your AWS account ID:instance/instance-ARN/queue/queue-ARN",
  }
}

```

Create a task when a contact is categorized in real-time or post-call/chat

An especially powerful use of Content Lens rules is to build rules that generate tasks. This helps you identify issues in your contact center for you to follow up, and creates traceable actions with owners. Following are some examples:

- Create a task to review a contact when the customer is fraudulent. For example, you can create a follow-up task when a customer utters words or phrases that makes them appear potentially fraudulent.
- Follow up when the customer mentions specific topics that you want to later on upsell or provide additional support by reaching out.
- Follow up when there is a serious quality issue. In addition to contacts being categorized and getting alerts, you can route a task so you have owners. You also have contact records for these tasks, so you can search for and trace them.

To create a rule that creates a task

1. When you create your rule, choose **Create Task** for the action.

The screenshot shows the 'Rules > Edit CustomerRefund' interface. At the top, there are three steps: 'Define conditions' (checked), '2 Define actions' (active), and '3 Review and save'. Below this, the 'Take these actions' section is visible. A card titled 'Assign contact category' is shown, with a text input field for 'Category name' containing 'CustomerRefund'. Below the input field, there is a note: 'Name can contain characters A-Z, 0-9, or ".", "-", "_'. It cannot contain spaces.' Below the card, an 'Add action' button is shown, which has opened a dropdown menu. The menu items are 'Assign Contact Category', 'Generate an EventBridge event', and 'Create Task'. A red arrow points to the 'Create Task' option.

2. Complete the task fields as follows:

Take these actions

Assign contact category

Define the category

Category name
 ACCCOUNT_CANCELLATION

Name can contain characters A-Z, 0-9, or "-", "+", "_". It cannot contain spaces.

Create task

Define the schema of the task ⓘ

Name
 Please review: Action-Required - Contact Lens - [ContactId]

Description
 Please follow up with [ContactId] this customer to offer a 20% discount on products for rejoining.

Task reference name taskRef	Task reference URL [instance_url]/contact-trace-records/details/[ContactId]
--------------------------------	--

Additional References

Task reference name Latest products on discount	Task reference URL http://discounted-products.examplecorp.com
--	--

[+ Add reference](#)

Select the flow that should route the task

Select a contact flow
 Discount_returning_customers ▼

Add action

- a. **Category name:** The category name appears in the contact record. Max length: 200 characters.
- b. **Name:** The name appears in the agent's Contact Control Panel (CCP). Max length: 512 characters.
- c. **Description:** The description appears in the agent's Contact Control Panel (CCP). Max length: 4096 characters.

Tip

In **Name** and **Description**, use [] to choose from a menu of dynamic values: **ContactId**, **AgentId**, **QueueId**, and **RuleName**. For more information, see [Create a task when a contact is categorized in real-time or post-call/chat](#).

Create task

Define the schema of the task ⓘ

Name
Action-Required - Contact Lens - [ContactId]

Description
Please ask [AgentId], who was working []

Task reference name
taskRef

+ Add reference

Dropdown menu options:
ContactId
AgentId
QueueId
RuleName

- d. **Task reference name:** This is a default reference that automatically appears in the agent's CCP.
 - For real-time rules, the task reference links to the Real-time details page.
 - For post-call/chat rules, the task reference links to the **Contact details** page.
 - e. **Additional Reference name:** Max length: 4096 characters. You can add up to 25 references.
 - f. **Select a flow:** Choose the flow that is designed to route the task to the appropriate owner of the task. The flow must be saved and published for it to appear in your list of options in the dropdown.
3. The following image shows an example of how this information appears in the agent's CCP.

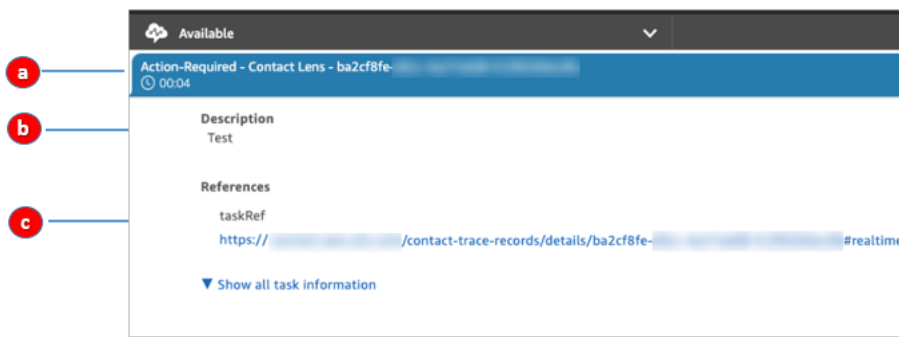

In this example, the agent sees the following values for **Name**, **Description**, and **Task reference name**:

- a. **Name** = Action-Required-Contact Lens - ba2cf8fe....
 - b. **Description** = Test
 - c. **Task reference name** = taskRef and the URL to the Real-time details page
4. Choose **Next**. Review and then choose **Save** the task.
 5. After you add rules, they are applied to new contacts that occur after the rule was added. Rules are applied when Contact Lens analyzes conversations.

You cannot apply rules to past, stored conversations.

Voice and task contact records are linked

When a rule creates a task, a contact record is automatically generated for the task. It's linked to the contact record of the voice call or chat that met the criteria for the rule to create the task.

For example, a call comes into your contact center and generates CTR1:

Contact ID: CTR1-1234abc
Channel: Voice
Initiation method: Inbound

Category: Compliance
Custom Contact Attributes:

- **CustomerType:** VIP
- **AgentLocation:** NYC

Next contact ID: CTR2-5678abc

The Rules engine generates a task. In the contact record for the task, the voice contact record appears as the **Previous contact ID**. In addition, the task contact record inherits contact attributes from the voice contact record, as illustrated in the following image:

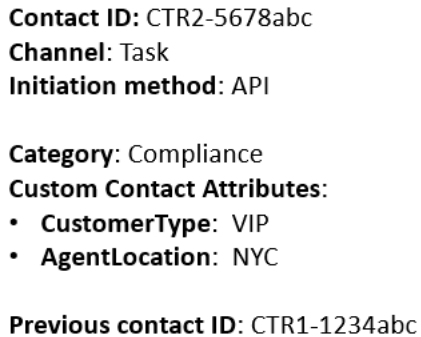

```

Contact ID: CTR2-5678abc
Channel: Task
Initiation method: API

Category: Compliance
Custom Contact Attributes:
• CustomerType: VIP
• AgentLocation: NYC

Previous contact ID: CTR1-1234abc

```

About dynamic values for ContactId, AgentId, QueueId, RuleName

The dynamic values in brackets [] are called [contact attributes](#). Contact attributes enable you to store temporary information about the contact so you can use it in a flow.

When you add contact attributes in brackets [] — such as ContactId, AgentId, QueueId, or RuleName — the value is passed from one contact record to another. You can use contact attributes in your flow to branch and route the contact accordingly.

For more information, see [Use Amazon Connect contact attributes](#).

Create a rule that ends associated tasks from a case

To create a rule that ends associated tasks

1. When you create your rule, choose **A new case is updated** as the event source.

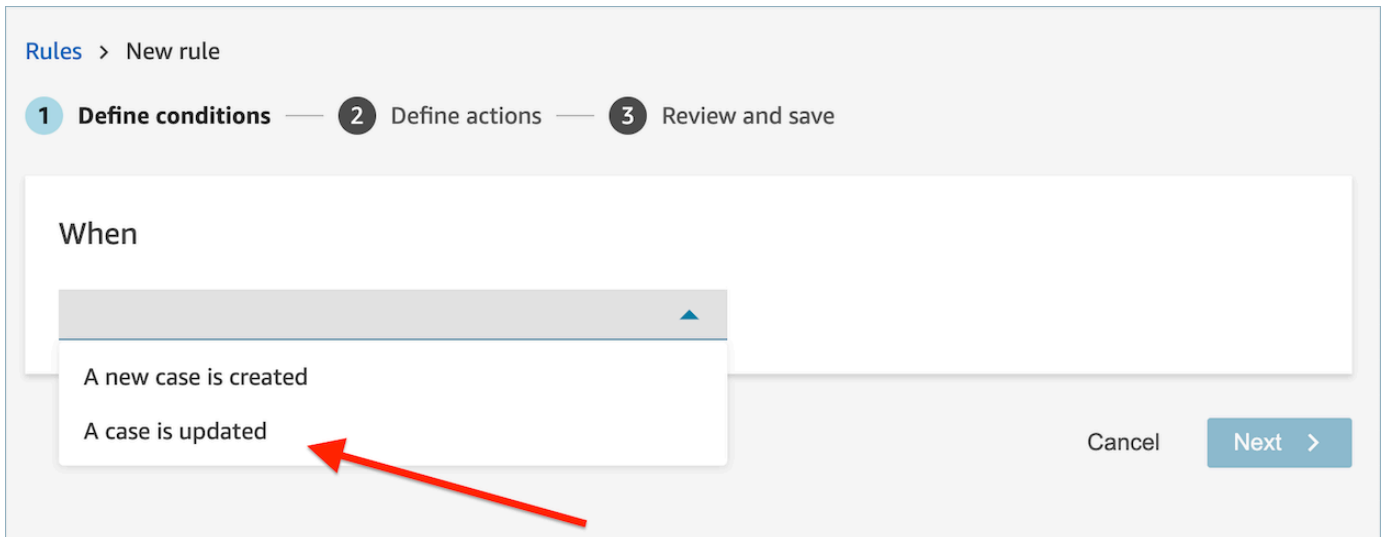

2. When you create your rule, choose **End tasks** for the action.

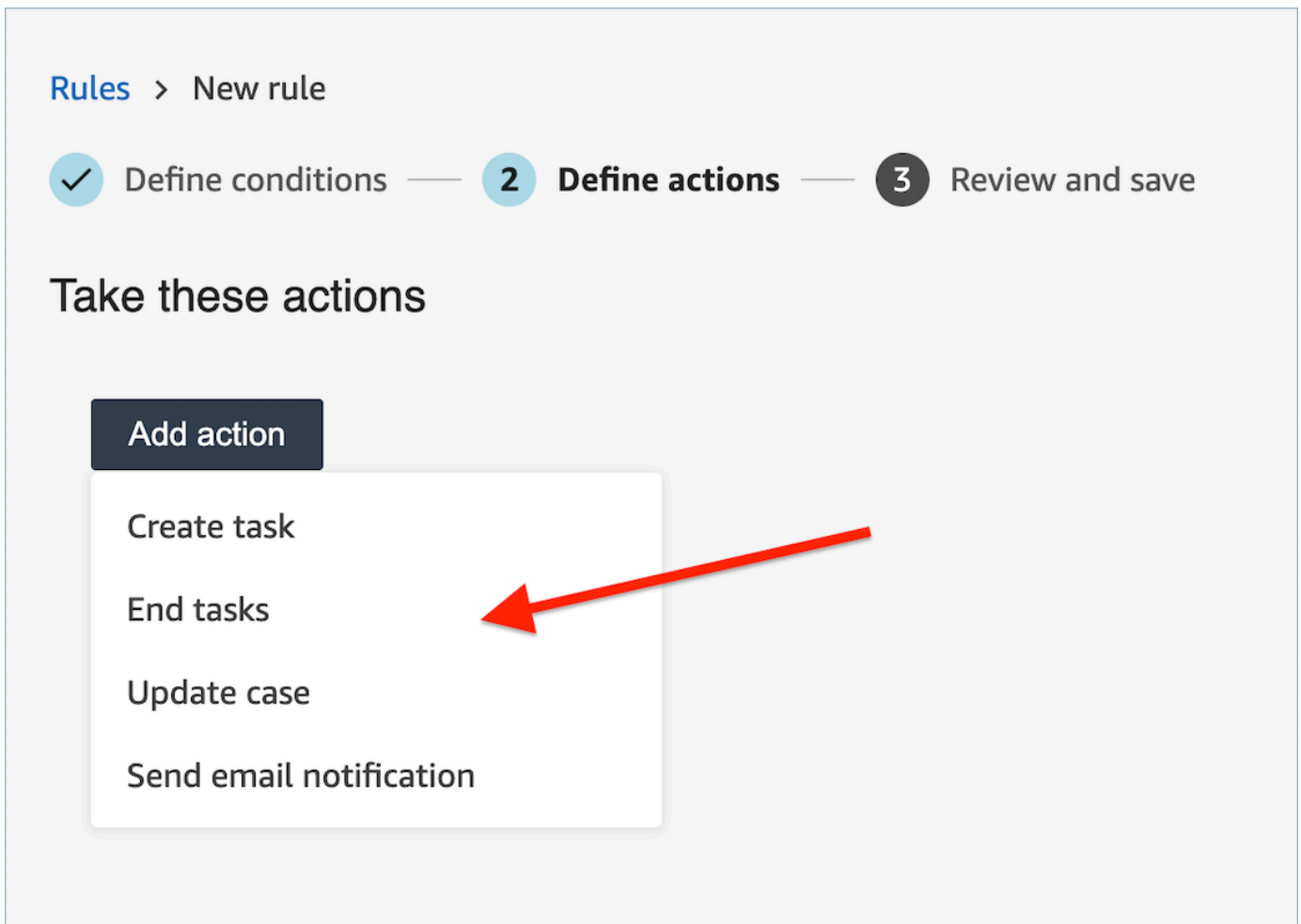

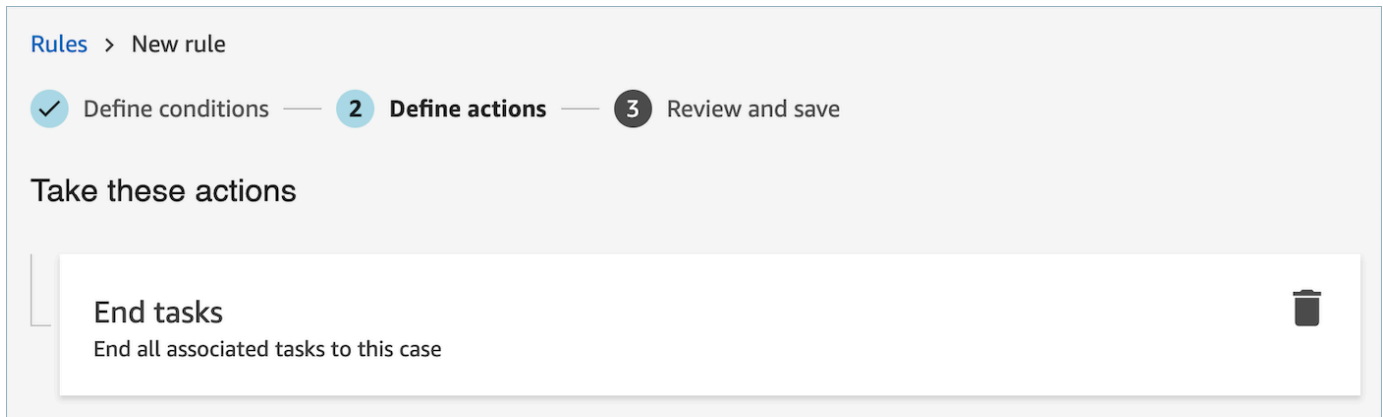

3. Choose **Next**. Review and then choose **Save**.
4. After you add rules, they are applied to new contacts that occur after the rule was added. Rules are applied when Contact Lens analyzes conversations.

You cannot apply rules to past, stored conversations.

Create a rule that creates a case

To create a rule that creates a case

1. When you create your rule, choose either **A Contact Lens post-call analysis is available** or **A Contact Lens post-chat analysis is available** as the event source.

1 **Define conditions** — 2 Define actions — 3 Review and save

When

- A Contact Lens post-call analysis is available
- A Contact Lens real-time call analysis is available
- A Contact Lens post-chat analysis is available
- A Contact Lens real-time chat analysis is available

2. Choose **Next**
3. On the actions page, choose **Create case** for the action.

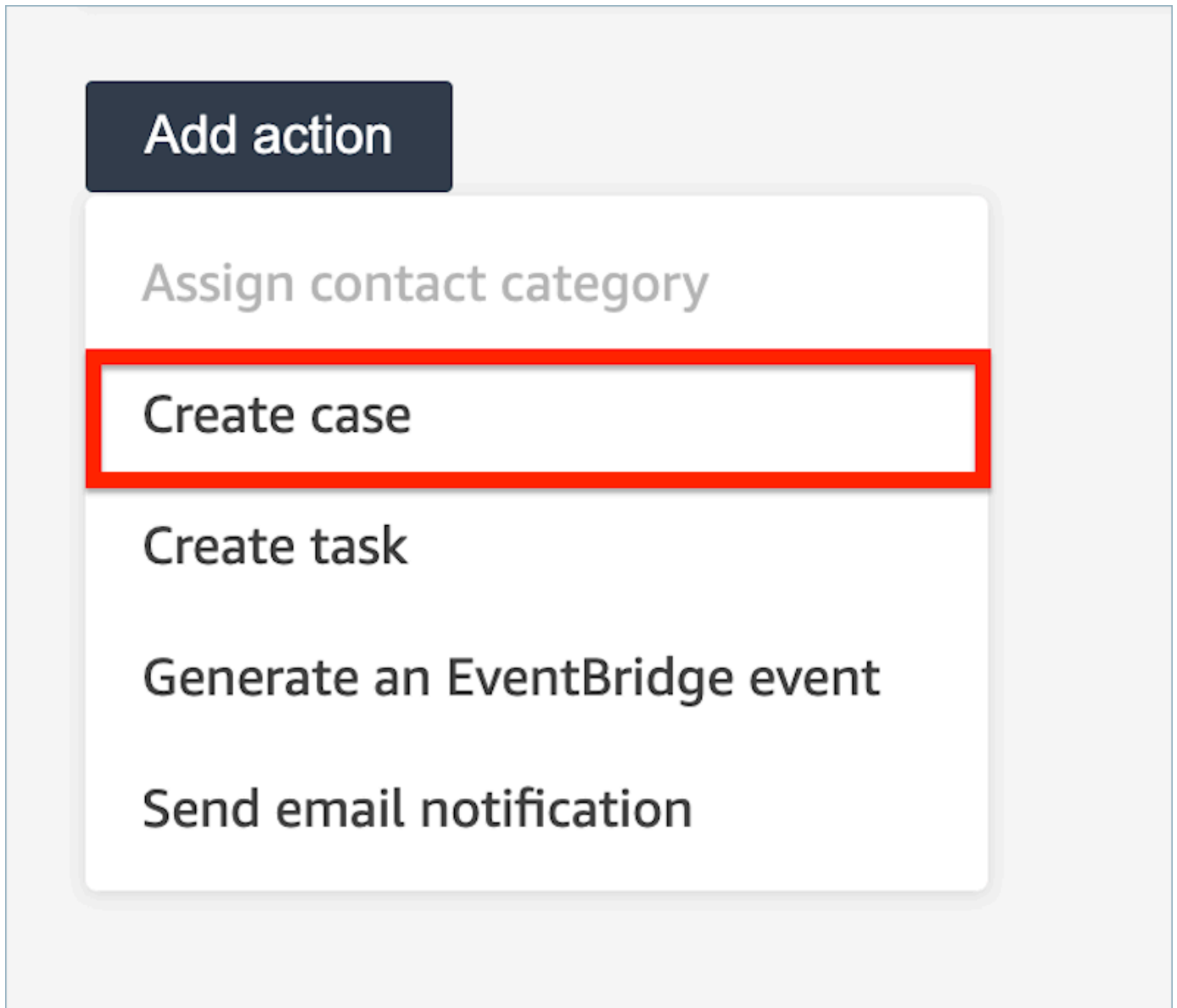

4. In the **Create case** card, select a **Case template**.

Create case
Define fields for creating a case

Amazon Connect Cases
Customer profile must be associated with a contact for this action to work. [Learn More](#)

Select a template

- Template-1
- Template-2
- Template-3

Cancel < Back Next >

5. Fill out the **required fields** and add **optional case fields** to populate case data.

Note

A customer profile must be associated with a contact for this action to work. For more information, see [Enable Cases](#).

Create case

Define fields for creating a case

Amazon Connect Cases
Customer profile must be associated with a contact for this action to work. [Learn More](#)

Select a template
Template-1

Required fields (3)

A list of fields that must contain a value for a case to be successfully created with this template

Title
Action-Required - Contact Lens - [ContactId]

Status
Open

Assigned Queue
Priority

Additional fields (1)

Select fields and give values to populate case data

Select a field

Case Reason

Case Reason
Refund

6. Choose **Next**. Review and then choose **Save**.
7. After you add rules, they are applied to new contacts that occur after the rule was added. Rules are applied when Contact Lens analyzes conversations.

You cannot apply rules to past, stored conversations.

Create a rule that updates a case

To create a rule that updates a case

1. When you create your rule, choose **A new case is updated** as the event source and choose **Next**.

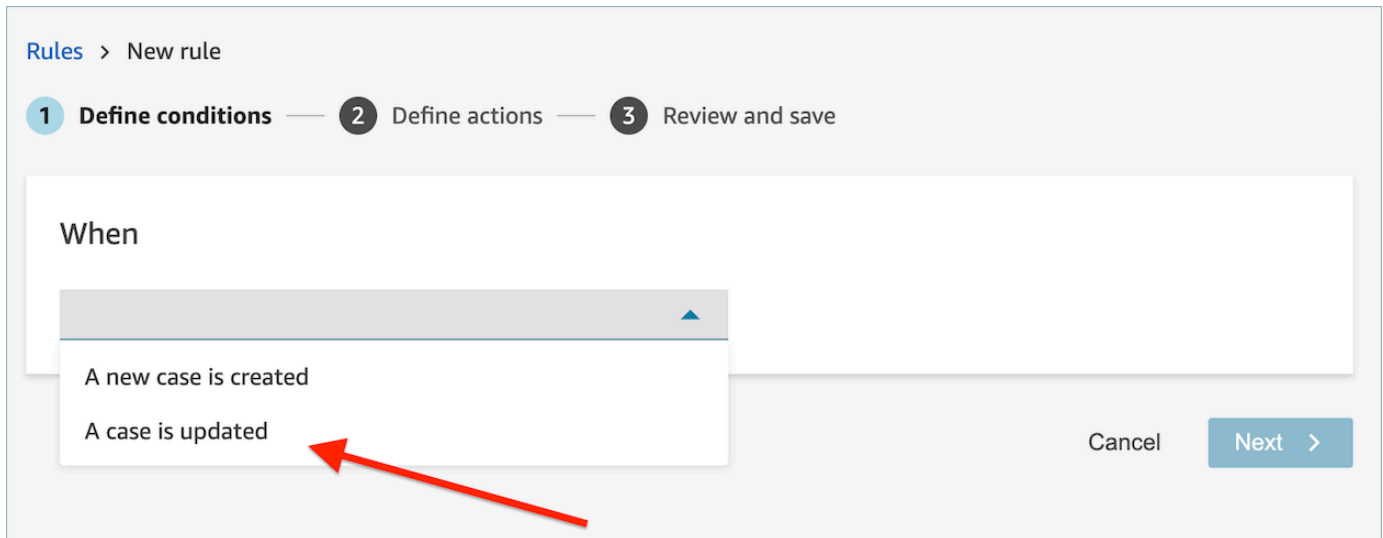

2. When you create your rule, choose **Update case** for the action.

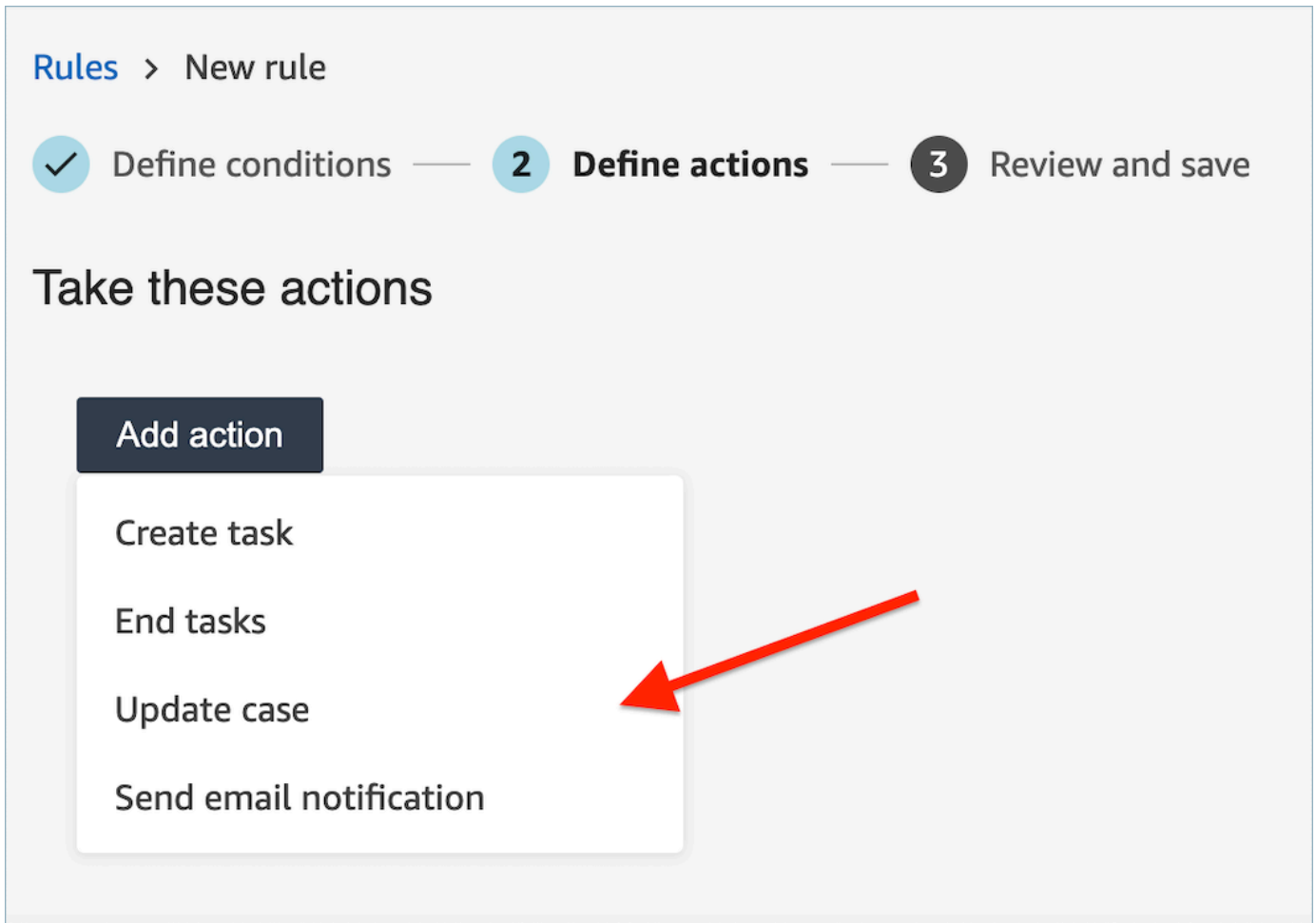

- 3. Select any case field that you want to update from the dropdown and define its new value.

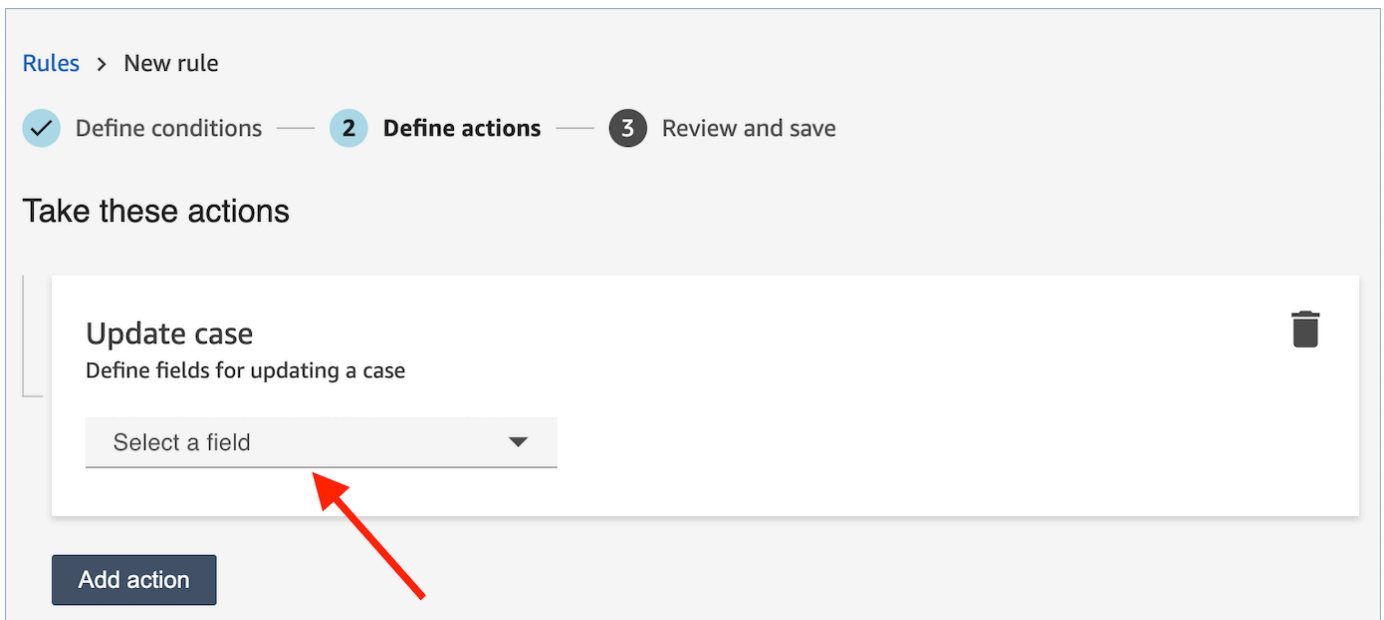

Rules > New rule

✓ Define conditions — 2 Define actions — 3 Review and save

Take these actions

Update case 

Define fields for updating a case

Select a field ▼

Status ✕

Status
Closed ▼

Add action

4. Choose **Next**. Review and then choose **Save**.
5. After you add rules, they are applied to new contacts that occur after the rule was added. Rules are applied when Contact Lens analyzes conversations.

You cannot apply rules to past, stored conversations.

Create a rule that submits an automated evaluation

Contact Lens enables you to automatically fill and submit evaluations, using insights and metrics from conversational analytics. To submit automated evaluations using an evaluation form, you first need to [configure automation on the evaluation form](#), including:

1. Setup automation on every question within an evaluation form.
2. Turn on **Enable fully automated evaluations** before activating the evaluation form.

When you activate the evaluation form with automation configured, you would receive the following prompt.

Create a rule to fully automate evaluations ✕

This version of "**ProblemSolving**" evaluation form is successfully activated. To perform fully automated evaluations, you first need to create a rule that specifies which contacts should be automatically evaluated using this evaluation form. [Learn more](#) 

Would you like to create a rule to trigger fully automated evaluations using this evaluation form now?

[Not right now](#) [Yes](#) 

Choosing **Yes**, will take you to the **Rules** page (within **Analytics and Optimization**). Here you can define a rule specifying which contacts will be automatically evaluated using the selected evaluation form.

To create a rule that submits an automated evaluation.

1. When you create your rule, choose **A Contact Lens post-call analysis is available** or **A Contact Lens post-chat analysis is available** as the event source and choose **Next**.

1 **Define conditions** — 2 Define actions — 3 Review and save

When

- A Contact Lens post-call analysis is available
- A Contact Lens real-time call analysis is available
- A Contact Lens post-chat analysis is available
- A Contact Lens real-time chat analysis is available

2. On the **Add action** page, choose **Submit automated evaluation** for the action.

Add action

Assign contact category

Create case

Create task

Generate an EventBridge event

Send email notification

Submit automated evaluation

3. On the **Submit automated evaluation** card, select an evaluation form.

Take these actions

Assign contact category

Define the category. [Learn more](#)

Category name ×

Compliance

Name can contain characters A-Z, 0-9, or ".", "-", "_". It cannot contain spaces.

Submit automated evaluation 🗑️

Automatically submit an evaluation of a contact using the selected evaluation form. [Learn More](#)

Select an evaluation form ▼

Add action

Cancel < Back Next >

4. Choose **Next**. Review and then choose **Save**.
5. After you add rules, they are applied to new contacts that occur after the rule was added. Rules are applied when Contact Lens analyzes conversations.

You cannot apply rules to past, stored conversations.

Frequently Asked Questions

1. Can an automated evaluation override an evaluation that has been manually submitted?

No, an automated evaluation will not override a manually submitted evaluation. If an evaluation already exists, then the automated evaluation will fail for that contact and account administrators can see such failure notifications within CloudWatch.

2. How do I identify automated evaluations?

If an evaluation is automatically submitted, it would be marked as “submitted by Contact Lens automation” on the Contact details page. Please note that if an automated evaluation is edited and re-submitted by an evaluator, the “submitted by” would now contain the name of the evaluator.

3. Can I automatically evaluate a contact using multiple evaluation forms?

Yes, you can automatically submit evaluations on a contact using multiple evaluation forms. This requires creation of multiple rules to submit automated evaluations using the different evaluation forms.

How to use a Word or phrase condition in a Contact Lens rule

When you add a condition to a Contact Lens rule, you have the option to specify a Words or phrases condition. You can choose Exact Match, Semantic Match, or Pattern Match for the words or phrases. This topic explains each type of match.

How to use exact match

Exact Match is an exact word match, which can be either singular or plural.

You can add the keywords or phrases by using either of the following methods:

- Selecting **Enter keywords or phrases** and entering values manually in the text box. Multiple values can be separated by a comma.

If **all** of these conditions are met

Words or phrases - Exact match

Limit: 100 words or phrases total for the rule

Logic: Any of the following words or phrases **were mentioned** during the **entire** length of the contact, where participant was **agent**

Enter keywords or phrases
 Import from word collection

hello, manually added keyword, multiple entries are separated by comma **Add**

Keywords or phrases
-

+ Add condition **+ Add group**

Cancel **Next >**

- Selecting **Import from word collection** to import pre-defined words and phrases from word collections.

If **all** of these conditions are met

Words or phrases - Exact match
Limit: 100 words or phrases total for the rule

Logic: Any of the following words or phrases **were mentioned** during the **entire** length of the contact, where participant was **agent**

Enter keywords or phrases
 Import from word collection

Access Issue
 Agent Uncertainty
 Apology
 Bill High
 Bill Inquiry
 Bill Not Received
 Cancellation
 Change Plan

Cancel **Next** >

Word collections can be categorized into two types: user word collections and system word collections. System word collections are pre-defined by Amazon Connect, which are non-editable to users. A user word collection can be created, read, updated, and deleted (CRUD) by users. For more information, see [Manage word collections](#).

How to use pattern match

If you want to match related words, append an asterisk (*) to the criteria. For example, if you want to match on all variations of "neighbor" (neighbors, neighborhood) you would type **neighbo***.

With **Pattern Match** you can specify the following:

- **List of values:** This is useful when you want to build expressions with interchangeable values. For example, the expression might be:

I'm calling about a power outage in ["Beijing" or "London" or "New York" or "Paris" or "Tokyo"]

Then in your list of values you would add the cities: Beijing, London, New York, Paris, Tokyo.

The advantage of using values is that you can create one expression, instead of multiple. This reduces the number of cards that you need to create.

- **Number:** This option is used most frequently in compliance scripts, or if you're looking for a context when you know somewhere in between there's a number. This way you can put all of your criteria into one expression instead of two. For example, an agent compliance script might say:

I have been in this industry for [num] years and would like to discuss this topic with you.

Or a customer might say:

I have been a member for [num] years.

- **Proximity definition:** Finds matches that may be less than 100 percent exact. You can also specify the distance between words. For example, if you are looking for contacts where the word "credit" was mentioned but you do not want to see any mention of the words "credit card," you can define a pattern matching category to look for the word "credit" that is not within a one-word distance of "card."

For example, a proximity definition might be:

credit [is not within 1 word from] card

Tip

For a list of languages supported by pattern match, see [Pattern match languages](#).

How to use semantic match

Semantic matching is supported only for post-call/chat analysis.

- An "intent" is an example of utterance. It can be a phrase or a sentence.
- You can enter up to four intents in one card (group).
- We recommend using semantically similar intents within one card to get the best results. For example, there's category for "politeness." It includes two intents: "greetings" and "goodbye". We recommend separating these intents into two cards:

- Card 1: "How are you today" and "How's everything going". They are semantically similar greetings.
- Card 2: "Thanks for contacting us" and "Thank you for being our customer." They are semantically similar goodbyes.

Separating the intents into two cards provides more accuracy than putting them all into one card.

Manage word collections

A *word collection* is a set of pre-built words and phrases that you can use to define the exact match condition when you create conversational analytics rules. When you add exact match conditions to a rule, you can choose a list of words and phrases from a dropdown menu.

Required permissions

Contact Lens Rules - Word Collections uses the same set of security profile permissions as Contact Lens Rules. For more information, see [Security profile permissions for Contact Lens rules](#).

How to access the word collection management page

1. When you create or update a conversational analytics rule, choose the gear icon on top right of the **Exact match** condition card, as shown in the following image.

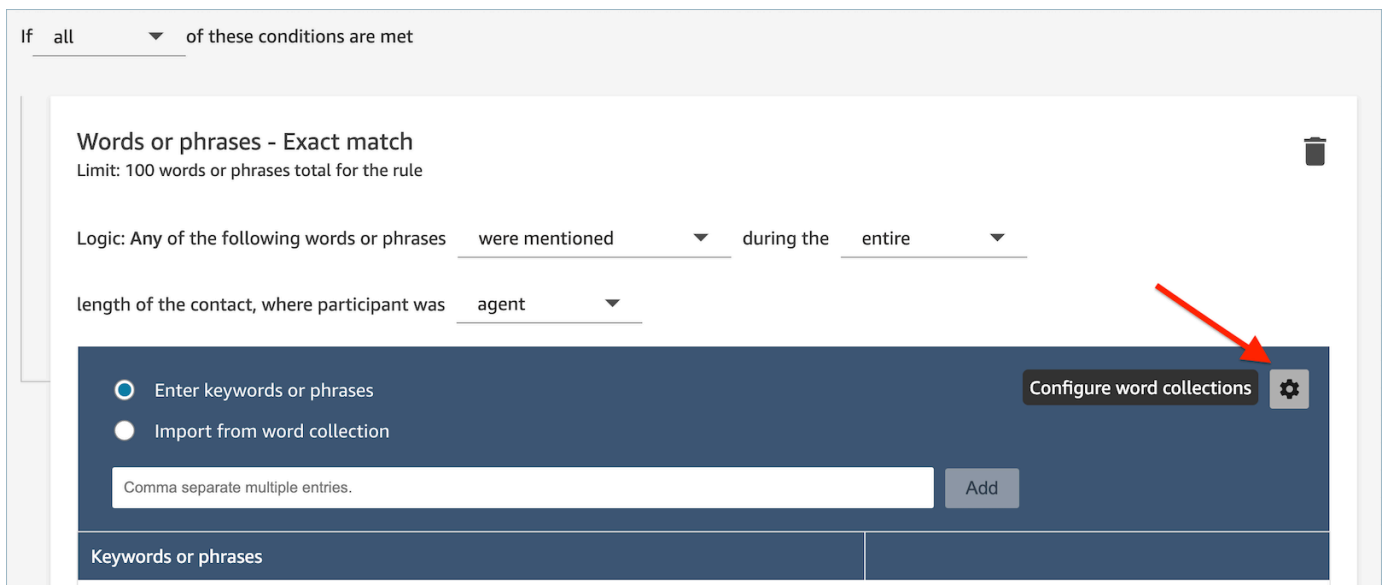

2. On the **Word collections** management page, you can view existing word collections and create new word collections.

Collection name	Type	Create date	Modified date ^	Modified by
sampleUserWordCollection	... User	Dec 3, 2023	Dec 3, 2023	
WeaselWords	... System	Jul 18, 2023	Jul 18, 2023	Amazon Connect
Emotion Detected	... System	Jul 18, 2023	Jul 18, 2023	Amazon Connect
Returns	... System	Jul 18, 2023	Jul 18, 2023	Amazon Connect
Repeat Call	... System	Jul 18, 2023	Jul 18, 2023	Amazon Connect
Refund Credit Discount	... System	Jul 18, 2023	Jul 18, 2023	Amazon Connect

How to create a user word collection

1. On the **Word collections** management page, choose **Create a word collection**.

Collection name	Type	Create date	Modified date ^	Modified by
sampleUserWordCollection	... User	Dec 3, 2023	Dec 3, 2023	
WeaselWords	... System	Jul 18, 2023	Jul 18, 2023	Amazon Connect
Emotion Detected	... System	Jul 18, 2023	Jul 18, 2023	Amazon Connect
Returns	... System	Jul 18, 2023	Jul 18, 2023	Amazon Connect
Repeat Call	... System	Jul 18, 2023	Jul 18, 2023	Amazon Connect
Refund Credit Discount	... System	Jul 18, 2023	Jul 18, 2023	Amazon Connect

2. Enter the name of the word collection, add words and phrases, then choose **Save**.

Word collections > New word collection

Name
userWordCollectionName

Word collection
Limit: 100 words or phrases total for the word collection

Enter keywords or phrases
enter more words or phrases Add

Keywords or phrases
hello

Cancel Save

Word collection limits

- Amazon Connect has a default limit of 100 user word collections per instance.
- Each word collection can have a maximum of 100 words or phrases.
- Each word or phrase is limited to no more than 512 characters.
- You can manage only user word collections. You can not manage or edit system word collections.

Enter a script in a rule

There are times when you may need you agents to follow an exact script. For example, a compliance script that all agents need to follow.

To enter a script in a rule, enter phrases. For example, if you want to highlight when agents say *Thank you for being a member. We appreciate your business*, enter two phrases:

- Thank you for being a member.
- We appreciate your business.

To apply the rule to certain lines of businesses, add a condition for which queues it applies to, or contact attributes. For example, the following image shows a rule that applies when an agent is

working the BasicQueue or Billing and Payments queues, the customer is for auto insurance, and the agent is located in Seattle.

Words or phrases - Exact match
Limit: 100 words or phrases total for the rule

Logic: Any of the following words or phrases were mentioned during the entire length of the contact, where participant is customer

Enter keywords or phrases. Comma separate multiples entries. Add

Keywords or phrases

new account

reset password

Queues
Match any of the following queues

Include Select a queue

BasicQueue X Billing and Payments X

Contact attributes customerType = AutoInsurance

Contact attributes agentLocation = Seattle

+ Add condition + Add group

Security profile permissions for Contact Lens rules

To view, edit, or add rules for automatic categorization, you must be assigned to a security profile that has **Analytics and Optimization: Rules** permissions.

To see agent names so you can add them to rules, you need **Users and permissions: Users - View** permissions in your security profile.

To see the queue names so you can add them to rules, you need **Routing: Queues - View** permissions in your security profile.

For more information, see [Security profile permissions for Contact Lens](#).

About contact attributes in a rule

You can have up to 5 contact attributes in a rule.

You can design flows to use the contact attributes you specify in a rule, and then route the task accordingly. For example, a call or chat arrives in your contact center. When Contact Lens analyzes the call or chat, it gets a hit on the **Compliance** rule. The contact record that's created for the call, for example, includes information similar to the following image. It shows the **Category** =

Compliance, and it has two custom contact attributes: **CustomerType = VIP**, **AgentLocation = NYC**.

```
Contact ID: CTR1-1234abc
Channel: Voice
Initiation method: Inbound

Category: Compliance
Custom Contact Attributes:
• CustomerType: VIP
• AgentLocation: NYC

Next contact ID: CTR2-5678abc
```

The Rules engine generates a task. The contact record for the task inherits the contact attributes from the voice contact record, as illustrated in the following image.

```
Contact ID: CTR2-5678abc
Channel: Task
Initiation method: API

Category: Compliance
Custom Contact Attributes:
• CustomerType: VIP
• AgentLocation: NYC

Previous contact ID: CTR1-1234abc
```

The voice contact record appears as the **Previous contact ID**.

The flow that you specify in the rule should be designed to use the contact attributes and route the task to the appropriate owner. For example, you may want to route tasks where **CustomerType = VIP** to a specific agent.

For more information, see [Use Amazon Connect contact attributes](#).

Rules are applied to new contacts

After you add rules, they are applied to new contacts that occur after the rule was added. Rules are applied when Contact Lens analyzes conversations.

You cannot apply rules to past, stored conversations.

Error notifications: When Contact Lens can't analyze a contact

It's possible that Contact Lens can't analyze a contact file, even though analysis is enabled on the flow. When this happens, Contact Lens sends error notifications using Amazon EventBridge events.

Events are emitted on a [best effort](#) basis.

Subscribe to EventBridge notifications

To subscribe to these notifications, create a custom EventBridge rule that matches the following:

- "source" = "aws.connect"
- "detail-type" = "Contact Lens Analysis State Change"

You can also add to the pattern to be notified when a specific event code occurs. For more information, see [Event Patterns](#) in the *Amazon EventBridge User Guide*.

The format of a notification looks like the following sample:

```
{
  "version": "0", // set by CloudWatch Events
  "id": "55555555-1111-1111-1111-111111111111", // set by CloudWatch Events
  "source": "aws.connect",
  "detail-type": "Contact Lens Analysis State Change",
  "account": "111122223333",
  "time": "2020-04-27T18:43:48Z",
  "region": "us-east-1", // set by CloudWatch Events
  "resources": [
    "arn:aws:connect:us-east-1:111122223333:instance/abcd1234-defg-5678-h9j0-7c822889931e",
    "arn:aws:connect:us-east-1:111122223333:instance/abcd1234-defg-5678-h9j0-7c822889931e/contact/efgh4567-pqrs-5678-t9c0-111111111111"
  ],
  "detail": {
    "instance": "arn:aws:connect:us-east-1:111122223333:instance/abcd1234-defg-5678-h9j0-7c822889931e",
    "contact": "arn:aws:connect:us-east-1:111122223333:instance/abcd1234-defg-5678-h9j0-7c822889931e/contact/efgh4567-pqrs-5678-t9c0-111111111111",
    "channel": "VOICE",
    "state": "FAILED",
    "reasonCode": "RECORDING_FILE_CANNOT_BE_READ"
  }
}
```

}

Event codes

The following table lists the event codes that may result when Contact Lens can't analyze a contact.

Event reason code	Description
INVALID_ANALYSIS_CONFIGURATION	Contact Lens received invalid values when the flow was initiated, such as an unsupported or invalid language code, or an unsupported value for redaction behavior.
RECORDING_FILE_CANNOT_BE_READ	Contact Lens can't get the recording file. This might be because file isn't present in the S3 bucket, or there are problems with permissions.
RECORDING_FILE_TOO_SMALL	The recording file is too small for analysis (less than 105 ms). If file doesn't have expected format, an INVALID error occurs. Empty JSON is also an unexpected object.
RECORDING_FILE_TOO_LARGE	The recording file exceeds the duration limit for analysis. <ul style="list-style-type: none">Voice: More than 14,400 seconds, or 4 hoursChat: More than 20K messages in a transcript
RECORDING_FILE_INVALID	The recording file is invalid.
RECORDING_FILE_CANNOT_BE_READ	An error occurred when Contact Lens tried to read the recording file.
RECORDING_FILE_EMPTY	The recording file is empty.

Event reason code	Description
RECORDING_SAMPLE_RATE_NOT_SUPPORTED	The sample rate of the audio file is not supported. Contact Lens currently supports audio files with an 8kHz sample rate. That is the sample rate for Amazon Connect recording s.

Error notifications: When Amazon Connect Rules action fails to run

It's important to know when a specific rule action has failed in a production environment, and what caused the failure. Then you can proactively mitigate such failures in future.

To get real-time insights on the actions that failed to run, you integrate Amazon Connect Rules with Amazon EventBridge events. This enables you to be notified when, for example, the "Create task" action failed to run because the maximum number of **Concurrent active tasks per instance** reached the service quota. When this happens, Amazon Connect sends error notifications using Amazon EventBridge events.

Events are emitted on a [best effort](#) basis.

Subscribe to EventBridge notifications

To subscribe to these notifications, create a custom EventBridge rule that matches the following:

- "source" = "aws.connect"
- "detail-type" = "Contact Lens Rules Action Execution Failed"

You can also add to the pattern to be notified when a specific event code occurs. For more information, see [Event Patterns](#) in the *Amazon EventBridge User Guide*.

The format of a notification looks like the following sample:

```
{
  "version": "0",
  "id": "8d122163-6c07-f8cb-06e7-373a1bcf8fc6",
  "source": "aws.connect",
  "detail-type": "Amazon Connect Rules Action Execution Failed",
```

```
"account": "123456789012",
"time": "2022-01-05T01:30:42Z",
"region": "us-east-1",
"resources": ["arn:aws:connect:us-east-1:123456789012:instance/cb54730f-5aac-4376-
b2f4-7c822889931e"],
"detail": {
  "ruleId": "7410c94b-21c2-4db0-a707-c6d751edbe8f",
  "actionType": "CREATE_TASK",
  "triggerEvent": "THIRD_PARTY",
  "instanceArn": "arn:aws:connect:us-east-1:123456789012:instance/cb54730f-5aac-4376-
b2f4-7c822889931e",
  "reasonCode": "ResourceNotFoundException",
  "error": "ContactFlowId provided does not belong to connect instance",
  "additionalInfo": "{\n  \"message\": \"Not Found\", \n  \"code
\": \"ResourceNotFoundException\", \n  \"statusCode\": 404, \n
  \"time\": \"2022-01-03T20:23:07.073Z\", \n  \"requestId\":
  \"048e4403-71c1-47d6-96fc-825744f518e7\", \n  \"retryable\": false, \n  \"retryDelay\":
  28.217537834500316\n}"
}
```

Supported action types

- CREATE_TASK
- GENERATE_EVENTBRIDGE_EVENT
- SEND_NOTIFICATION

For information about ASSIGN_CONTACT_CATEGORY, see [Error notifications: When Contact Lens can't analyze a contact](#).

Supported trigger events

- REAL_TIME_CALL
- REAL_TIME_CHAT
- POST_CALL
- POST_CHAT
- THIRD_PARTY

Reason codes for failed actions

When an action fails, the error notification service collects the reason codes from the supported actions. For more information about the reason codes for Task and EventBridge action failures, see the following topics:

- For reason codes for Task action failures, see [Errors](#) in the **StartTaskContact** API topic in the *Amazon Connect API Reference Guide*.
- For reason codes for EventBridge action failures, see [Errors](#) in the **PutEvents** API topic in the *Amazon EventBridge API Reference Guide*.

JSONPath Reference for Rules action public API fields that support variable injection

When you create or manage rules programmatically using Amazon Connect APIs (such as [CreateRule](#) or [UpdateRule](#)), you can specify variables for certain parameters. The variables are resolved at runtime when the action is triggered, based on the value of the [EventSourceName](#) parameter.

For example, let's say you're setting up a task action and you want to add more context. Following is an example of how you could use variable injections to include the ID of the contact and the ID of the agent in the `Description` field of the task:

- Customer is unhappy about the phone call. A swear word was detected during the conversation with agent `$.ContactLens.PostCall.Agent.AgentId` in the contact `$.ContactLens.PostCall.ContactId`

When the action is triggered, his string would resolve to "Customer is unhappy about the phone call. A swear word was detected during a conversation with agent 12345678-1234-1234-1234-EXAMPLEID012 in the contact 87654321-1234-1234-1234-EXAMPLEID345"

The following table lists each event source, and the JSONPath to use for fields that support variable injection.

EventSourceName	JSONPath Reference
OnPostCallAnalysisAvailable	<code>\$.ContactLens.PostCall.ContactId</code>

EventSourceName	JSONPath Reference
	\$.ContactLens.PostCall.Agent.AgentId \$.ContactLens.PostCall.Queue.QueueId
OnRealTimeCallAnalysisAvailable	\$.ContactLens.RealTimeCall.ContactId \$.ContactLens.RealTimeCall.Agent.AgentId \$.ContactLens.RealTimeCall.Queue.QueueId
OnPostChatAnalysisAvailable	\$.ContactLens.PostChat.ContactId \$.ContactLens.PostChat.Agent.AgentId \$.ContactLens.PostChat.Queue.QueueId
OnSalesforceCaseCreate	\$.ThirdParty.Salesforce.CaseCreate.CaseNumber \$.ThirdParty.Salesforce.CaseCreate.Name \$.ThirdParty.Salesforce.CaseCreate.Email \$.ThirdParty.Salesforce.CaseCreate.Phone \$.ThirdParty.Salesforce.CaseCreate.Company \$.ThirdParty.Salesforce.CaseCreate.Type \$.ThirdParty.Salesforce.CaseCreate.Reason \$.ThirdParty.Salesforce.CaseCreate.Origin \$.ThirdParty.Salesforce.CaseCreate.Subject \$.ThirdParty.Salesforce.CaseCreate.Priority \$.ThirdParty.Salesforce.CaseCreate.CreatedDate \$.ThirdParty.Salesforce.CaseCreate.Description

EventSourceName	JSONPath Reference
OnZendeskTicketCreate	\$.ThirdParty.Zendesk.TicketCreate.Id \$.ThirdParty.Zendesk.TicketCreate.Priority \$.ThirdParty.Zendesk.TicketCreate.CreatedAt
OnZendeskTicketStatusUpdate	\$.ThirdParty.Zendesk.TicketStatusUpdate.Id \$.ThirdParty.Zendesk.TicketStatusUpdate.Priority \$.ThirdParty.Zendesk.TicketStatusUpdate.CreatedAt

Amazon Connect Cases - rules integration onboarding

To enable Amazon Connect Cases with rules integration

1. Ensure that you have Amazon Connect Cases enabled for your instance. For more information see [Enable Cases](#).
2. Ensure that you have enabled Amazon Connect Cases event streams. For more information see [Set up case event streams](#).
 - a. You can skip the part that asks you to create a SQS queue, as it is not required.
 - b. Run the following command to include all case fields information in the event. Make sure to include all of the fields that you need for the Rules engine to work:

```
aws connectcases put-case-event-configuration --domain-id
01310a0e-24ba-4a3c-89e9-9e1daeaxxxx --event-bridge "{
  \"enabled\": true,
  \"includedData\": {
    \"caseData\": {
      \"fields\": [
        {
          \"id\": \"status\"
```

```

    },
    {
      \"id\": \"title\"
    },
    {
      \"id\": \"assigned_queue\"
    },
    {
      \"id\": \"assigned_user\"
    },
    {
      \"id\": \"case_reason\"
    },
    {
      \"id\": \"last_closed_datetime\"
    },
    {
      \"id\": \"created_datetime\"
    },
    {
      \"id\": \"last_updated_datetime\"
    },
    {
      \"id\": \"reference_number\"
    },
    {
      \"id\": \"summary\"
    }
  ]
},
\"relatedItemData\": {
  \"includeContent\": true
}
}
}

```

- c. If there are custom case fields, make sure to include a custom field ID the fields array in the previous payload as well. Field IDs can be found by running the following command :

```
aws connectcases list-fields --domain-id 01310a0e-24ba-4a3c-89e9-9e1daeaxxxx
```

d. Repeat step 2 if you need to add new custom fields.

3. Make a [CreateEventIntegration](#) API call.

- Payload:

```
aws appintegrations create-event-integration --name amazon-connect-cases --description amazon-connect-cases --event-filter '{"Source":"aws.cases"}' --event-bridge-bus default
```

- The output will be something similar to the following sample:

```
{
  "EventIntegrationArn": "arn:aws:app-integrations:us-west-2:111222333444:event-integration/amazon-connect-cases"
}
```

4. Make a [CreateIntegrationAssociation](#) API call.

- Payload:

The `IntegrationArn` is the response you get from step 3.

```
aws connect create-integration-association --instance-id bba5df5c-6a5f-421f-a81d-9c16402xxxx --integration-type EVENT --integration-arn arn:aws:app-integrations:us-west-2:111222333444:event-integration/amazon-connect-cases --source-type CASES
```

- The output will be something similar to the following sample:

```
{
  "IntegrationAssociationId": "d49048cd-497d-4257-ab5c-8de797a123445",
  "IntegrationAssociationArn": "arn:aws:connect:us-
west-2:111222333444:instance/bba5df5c-6a5f-421f-a81d-9c16402bxxxx/integration-
association/d49048cd-497d-4257-ab5c-8de797a123445"
}
```

You should now be able to use Rules with Cases.

Create alerts on real-time metrics

You can create rules that automatically send emails or tasks to managers based on the values of real-time metrics. This enables you to alert managers on contact center operations that could potentially impact the end-customer experience. For example, you can set up an alert that sends an email to a manager when one or more agents on their team have been on break for longer than 30 minutes.

Contents

- [Step 1: Define rule conditions](#)
- [Step 2: Define rule actions](#)

Step 1: Define rule conditions

1. On the navigation menu, choose **Analytics and optimization, Rules**.
2. Select **Create a rule, Real-time metrics**.
3. Under **When**, use the dropdown list to choose from the following event sources: **There is an update in queue metrics**, **There is an update in routing profile metrics**, **There is an update in agent metrics**, and **There is an update in flow metrics**. These options are shown in the following image.

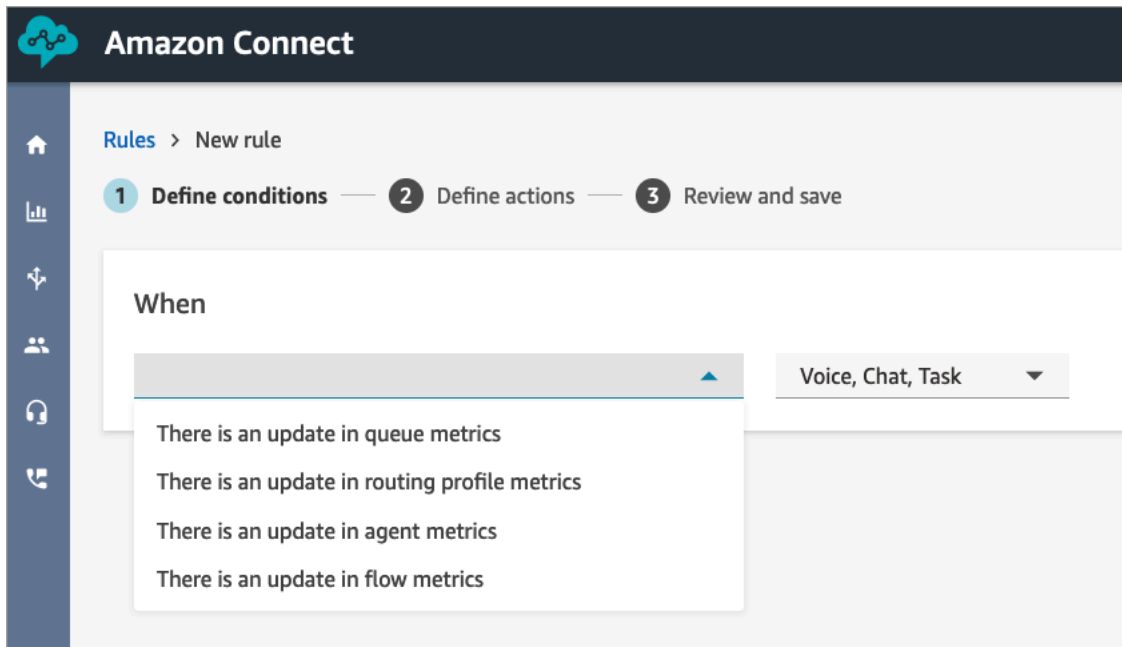

4. Choose **Add condition**. The **Metrics** card is added automatically, as shown in the following image.

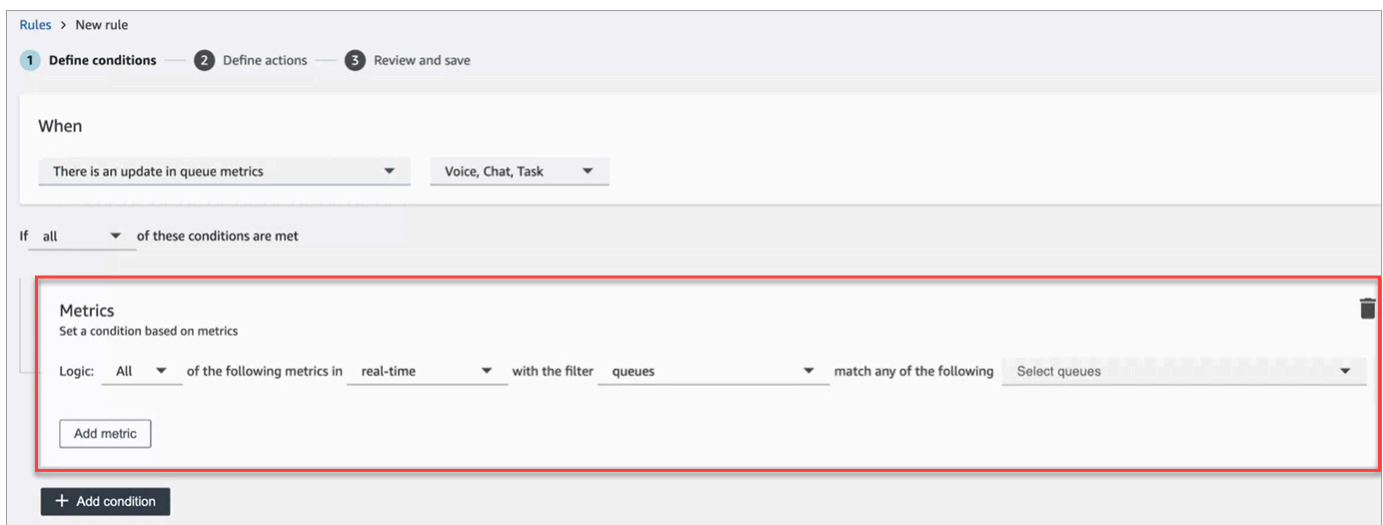

Note

- You can add up to 2 Metrics cards. This enables you to create a condition where one card evaluates real-time metrics and another evaluates trailing windows of time. For example, you may want an alert when several agents on are lunch break (Agent activity = Lunch break for 1 hour) and Average handle time is greater than 5 minutes.

- You can add up to 10 metrics to each **Metrics** card.

Following are the available real-time metrics you can add, depending on the event source.

- **There is an update in queue metrics - real-time**
 - [Contacts in queue](#): Build rules that run when the number of contacts in a queue is a specified value.
 - [Oldest contact age](#): Build rules that run when the oldest contact in queue reaches a specified age.
 - [Agents available](#): Build rules that run when the number of agents available to handle contacts reaches a specified value.

The following image shows a condition that is met when **Contacts in queue** is greater than or equal to 400 AND **Oldest contact agent** is greater than or equal to 10 minutes AND **Agents available** is greater than or equal to 0, for the **Basic Routing Profile**.

All = AND (Contacts in queue \geq 400 AND Oldest contact age \geq 10 minutes AND Agents available \geq 5)

Any = OR (Contacts in queue \geq 400 OR Oldest contact age \geq 10 minutes OR Agents available \geq 5)

Metrics
Set a condition based on metrics

Logic: **All** of the following metrics in **real-time** with the filter **routing profiles** match any of the following **Select routing profiles**

Basic Routing Profile X

Contacts in queue	\geq	400
Oldest contact age	\geq	10 minutes
Agents available	\geq	5

To evaluate the condition with OR instead of AND, change the **Logic** setting to **Any**.

- **There is an update in queue metrics - trailing windows of time**

Trailing windows of time is the past x minutes or hours.

- [Average handle time](#): Build rules that run when the average handle time reaches a specified duration.

- [Average queue answer time](#): Build rules that run when the average queue answer time reaches a specified duration.
- [Average agent interaction time](#): Build rules that run when the average interaction time reaches a specified duration.
- [Average customer hold time](#): Build rules that run when the average hold time reaches a specified duration. This metric does not apply to tasks so the value for them is always 0.
- [Service level](#): Build rules that run when the service level reaches a specified percent.
- **There is an update in routing profile metrics**

Trailing windows is not available for rules based on routing profiles.

- [Agents available](#): Build rules that run when the number of agents available to take inbound contacts reaches a specified value.
- **There is an update in agent metrics - real-time**
 - [Agent activity](#): Build rules that run when the agent activity equals a certain value such as Available, Incoming, On contact, and more.
- **There is an update in agent metrics - trailing windows**
 - [Average handle time](#): Build rules that run when the Average handle time historical metric reaches a specified duration.
 - [Agent occupancy](#): Build rules that run when the Occupancy historical metric reaches a specified percent.
- **There is an update in flow metrics - trailing windows of time**
 - [Flows started](#): Build rules that run when the flow started count reaches a specified value.
 - [Flows outcome](#): Build rules that run when the flow outcome count reaches a specified value for selected flow outcomes.
 - [Flows outcome percentage](#): Build rules that run when the flow outcome percentage value reaches a specified percent for selected flow outcomes.
 - [Average flow time](#): Build rules that run when the average flow duration reaches a specified duration for selected flow outcomes.
 - [Maximum flow time](#): Build rules that run when the maximum flow duration reaches a specified duration for selected flow outcomes.
 - [Minimum flow time](#): Build rules that run when the minimum flow duration reaches a specified duration for selected flow outcomes.

Step 2: Define rule actions

1. Choose **Add action**. You can choose the following actions:
 - [Create Task](#)
 - [Send email notification](#)
 - [Generate an EventBridge event](#): Use **Metrics Rules Matched** for the detail type.

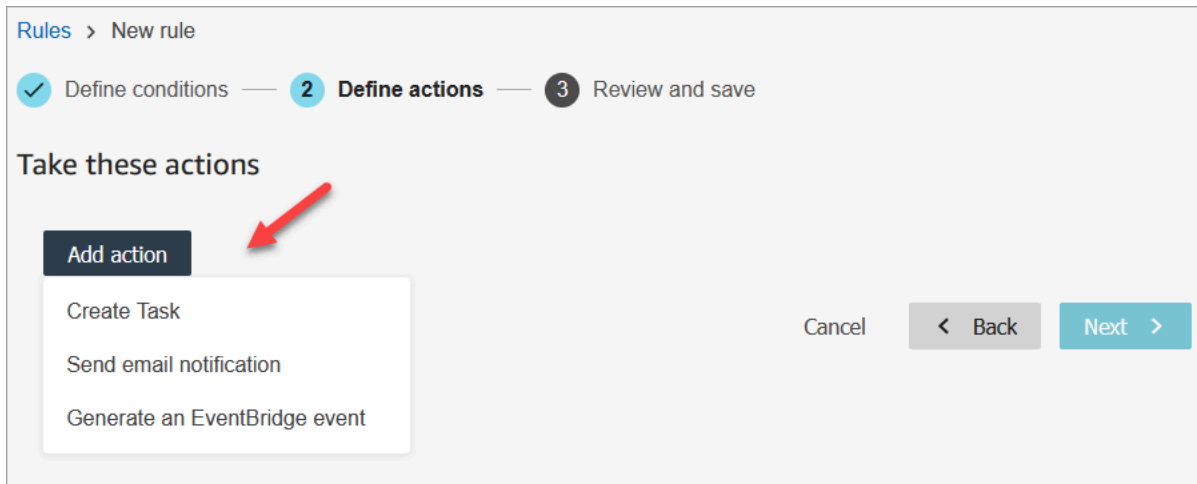

2. Choose **Next**.
3. Review and make any edits, then choose **Save**.
4. After you add rules, they are applied to new evaluation submissions that occur after the rule was added. You cannot apply rules to past, stored evaluations.

Monitor and update cases

You can create rules that automatically update tasks, update cases, end associated tasks, or send email alerts to Connect users whenever a case is created or updated. For example, you can set up an alert that sends an email to a manager when a high-priority case is created or updated.

Contents

- [Step 1: Define rule conditions](#)
- [Step 2: Define rule actions](#)

Step 1: Define rule conditions

1. On the navigation menu, choose **Analytics and optimization, Rules**.
2. Select **Create a rule, Cases**.

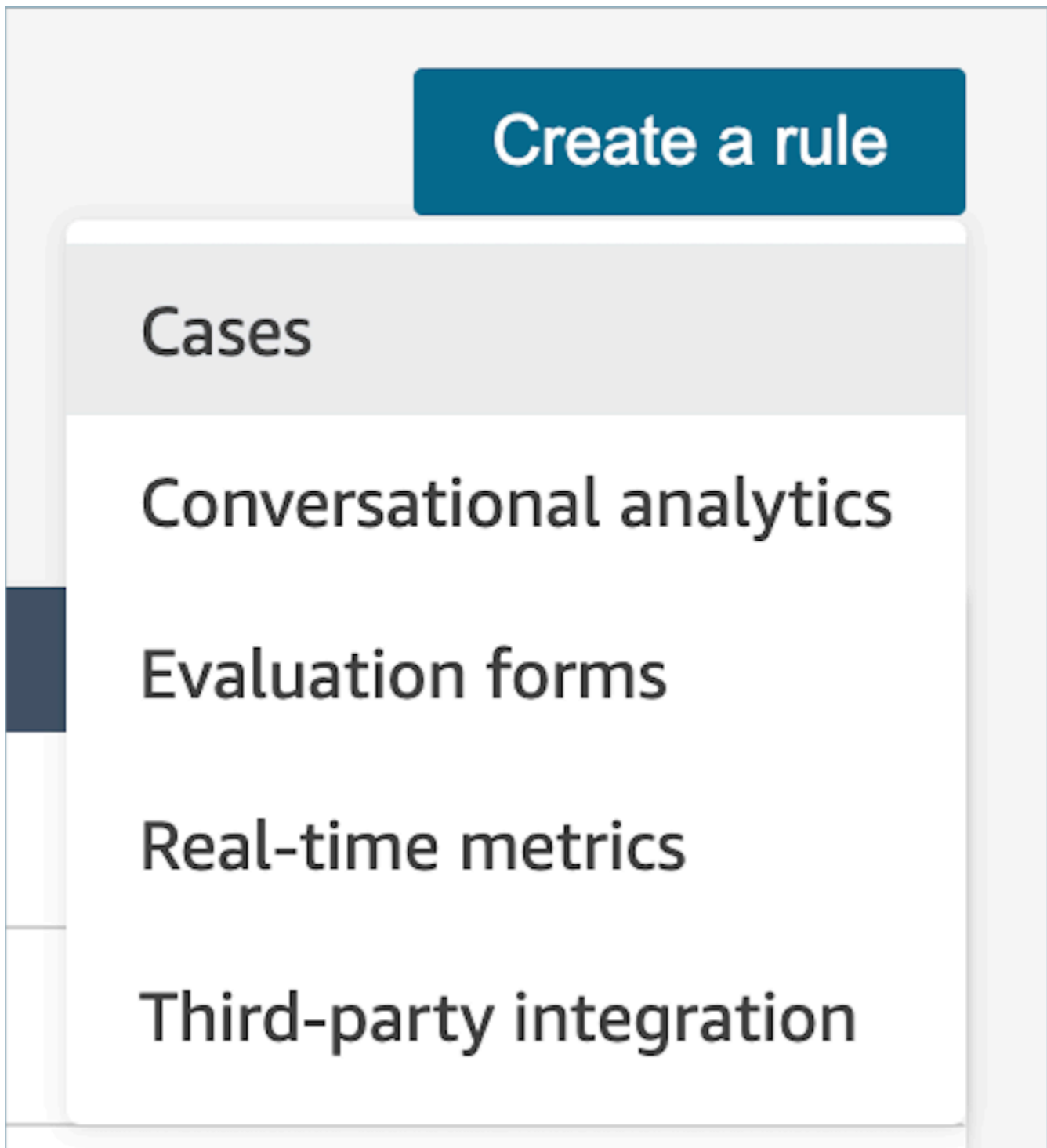

- Under **When**, use the dropdown list to choose from two event sources: **new case is created**, **A new case is updated**. These options are shown in the following image.

Note

To start creating Rules for Cases, you must enable Amazon Connect Cases and complete the onboarding steps. For more information, see [Amazon Connect Cases - rules integration onboarding](#)

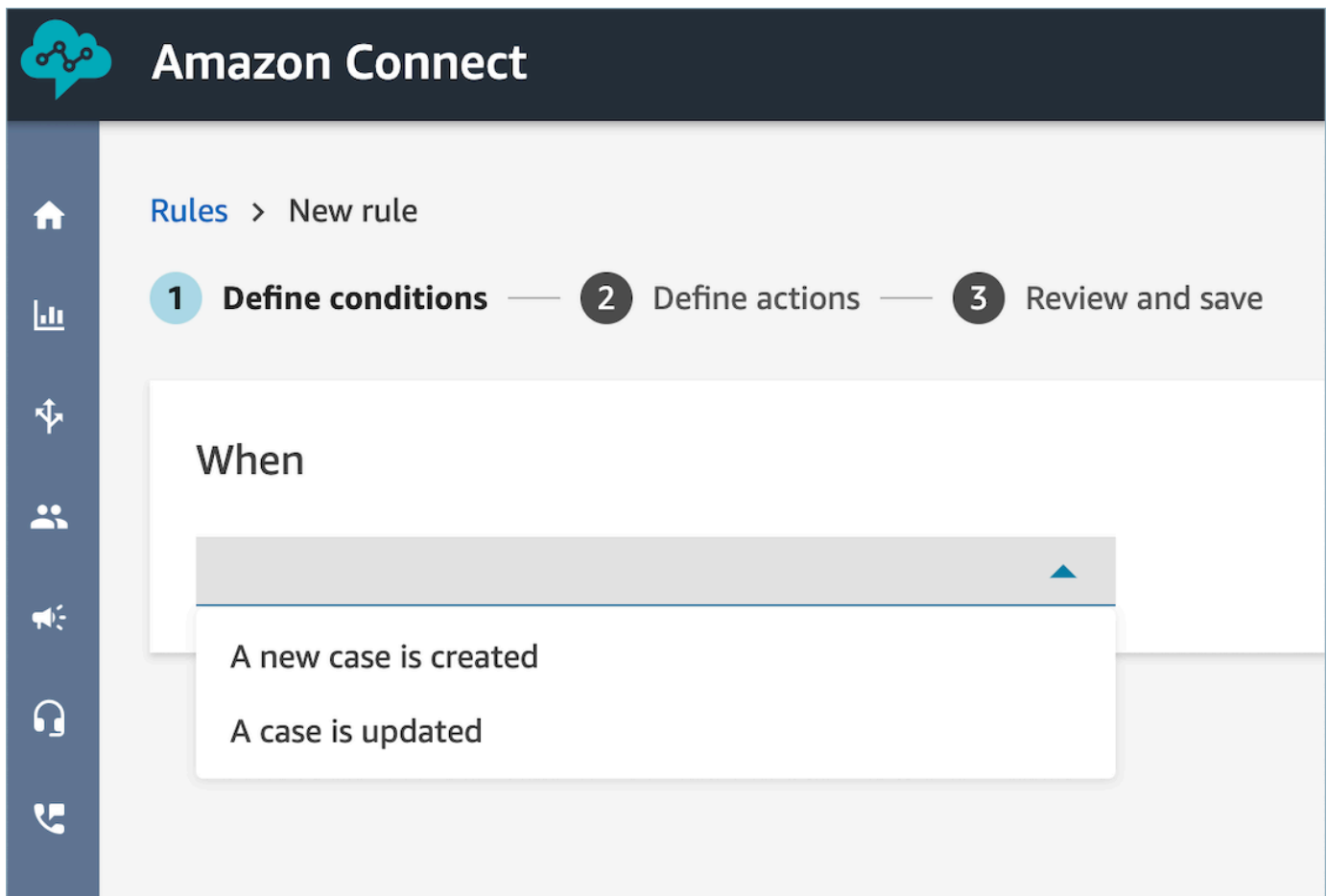

- Choose **Add condition**. The **Case field** card is added automatically, as shown in the following image.

Rules > New rule

1 Define conditions — 2 Define actions — 3 Review and save

When

A case is updated

If all of these conditions are met

Case field
Set a condition based on case field

Status = Needs approval

+ Add condition + Add group

You can combine multiple conditions to build very specific rules.

- **Case field condition** allows you to build rules by using [System](#) and [Custom](#) case fields.

The following image shows a sample rule with multiple conditions:

If all of these conditions are met

Case field
Set a condition based on case field

Status = Needs approval

Case field
Set a condition based on case field

Case Reason = Cancellation

Case field
Set a condition based on case field

Title contains urgent

+ Add condition + Add group

5. Choose **Next**.

Step 2: Define rule actions

1. Choose **Add action**. You can choose the following actions:

- [Create Task](#)
- [End tasks](#)
- [Update case](#)
- [Send email notifications](#)

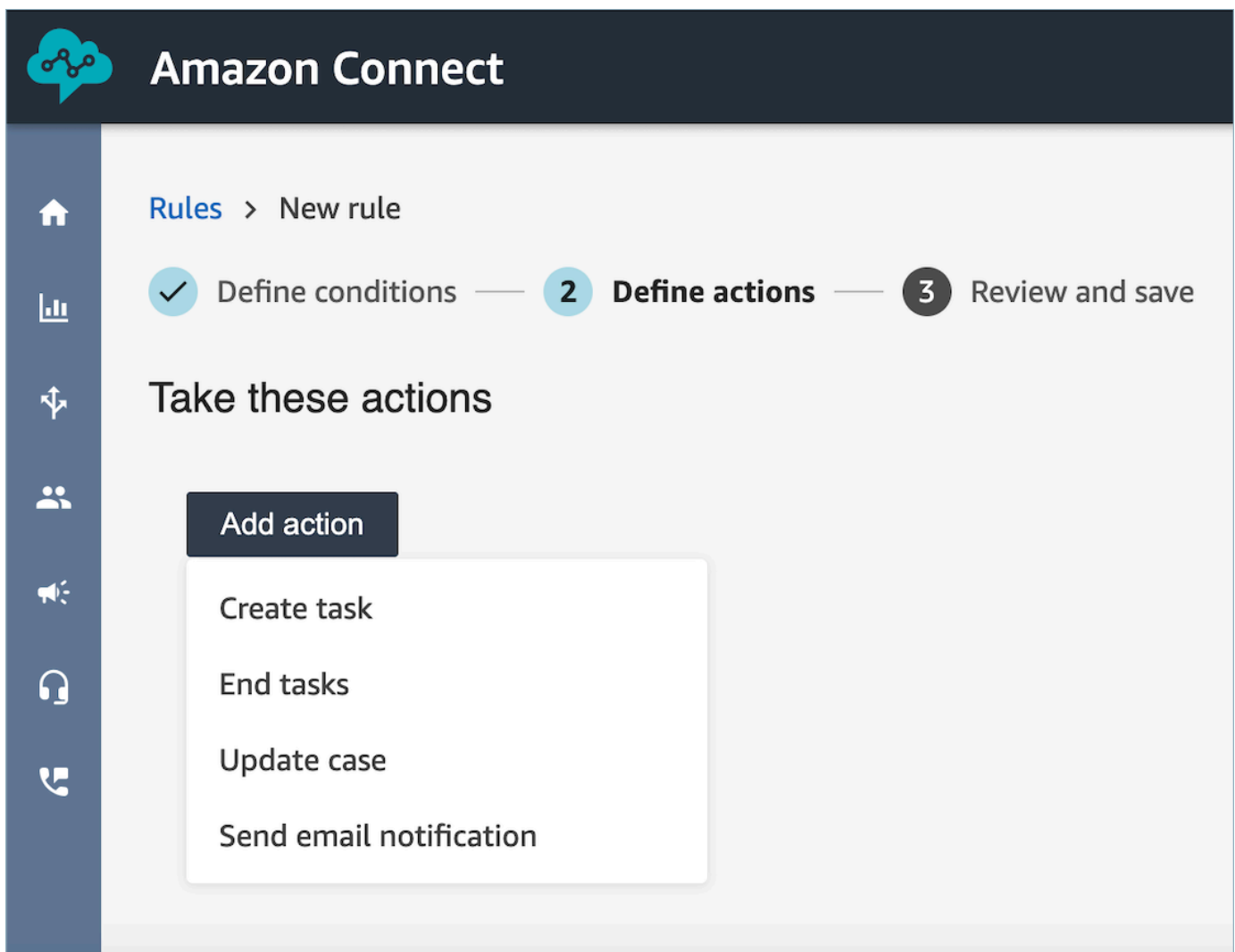

2. Choose **Next**.

3. Review and make any edits, then choose **Save**.

Search conversations analyzed by Contact Lens

You can search the analyzed and transcribed recordings based on:

- Speaker (agent or customer)
- Keywords
- Sentiment score
- Non-talk time (for calls only)
- Response time (for chats only)

In addition, you can search conversations that are in specific contact categories (that is, the conversation has been categorized based on uttered keywords and phrases).

These criteria are described in the following sections.

Important

When a Contact Lens is enabled on a contact, after a call or chat ends **and** the agent completes After Contact Work (ACW), Contact Lens analyzes (and for calls, transcribes) the recording of the customer-agent conversation. The agent must choose **Close contact** first. Chat transcripts are indexed for search when Contact Lens is enabled; they are not indexed for search if Contact Lens is not enabled.

Required permissions for searching conversations

Before you can search conversations, you need the following permissions in your security profile. They allow you to do the type of search you want.

- Enable one of the following permissions to access the **Contact Search** page:
 - **Contact search.** Allows you to search for all contacts.
 - **View my contacts:** Allows you to search for only those contacts that you handled as an agent.
- **Search contacts by conversation characteristics.** This includes non-talk time, sentiment score, and contact category.
- **Search contacts by keywords**

For more information, see [Security profile permissions for Contact Lens](#).

Search for words or phrases

For keyword search, Contact Lens uses the standard analyzer in Amazon OpenSearch Service. This analyzer is not case sensitive. For example, if you enter *thank you for your business 2 CANCELLED Flights*, the search looks for:

[thank, you, for, your, business, 2, cancelled, flights]

If you enter *"thank you for your business", two, "CANCELLED Flights"*, the search looks for:

[thank you for your business, two, cancelled flights]

To search conversations for words or phrases

1. In Amazon Connect, log in with a user account that is assigned the **CallCenterManager** security profile, or that is enabled for the **Search contacts by keywords** permission.
2. Choose **Analytics and optimization, Contact search**.
3. In the **Filter** section, specify the time period that you want to search, and specify the channel.

Tip

When searching by date, you can search up to 8 weeks at a time.

4. Choose **Click here to add filter**, and in the dropdown menu, choose **Words or phrases**.

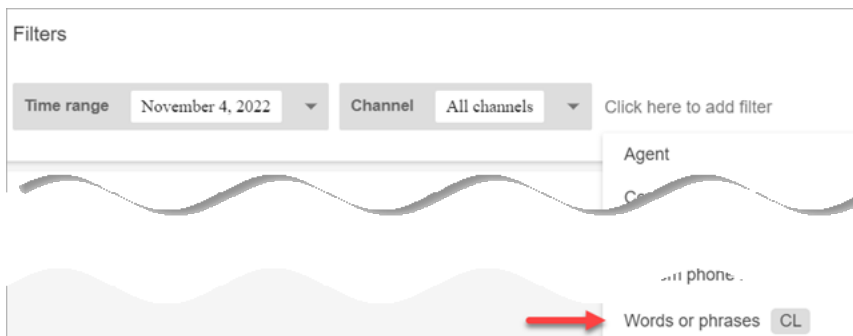

5. In the **Used by** section, choose whose part of the conversation you want to search. Note the following:
 - **System** applies to chat, where the participant may be a Lex bot or prompt.
 - To search for words or phrases that are used by all participants, select **Agent, Customer, System**.

- If no boxes are selected, it means search for words or phrases used by any of the participants.
6. In the **Logic** section, choose from the following options:
- Choose **Match any** to return contacts that have any of the words present in the transcripts.

For example, the following query means match (hello OR cancellation OR "example airline"). And, because no **Used by** boxes are selected, it means "find contacts where any of these words were used by any of the participants."

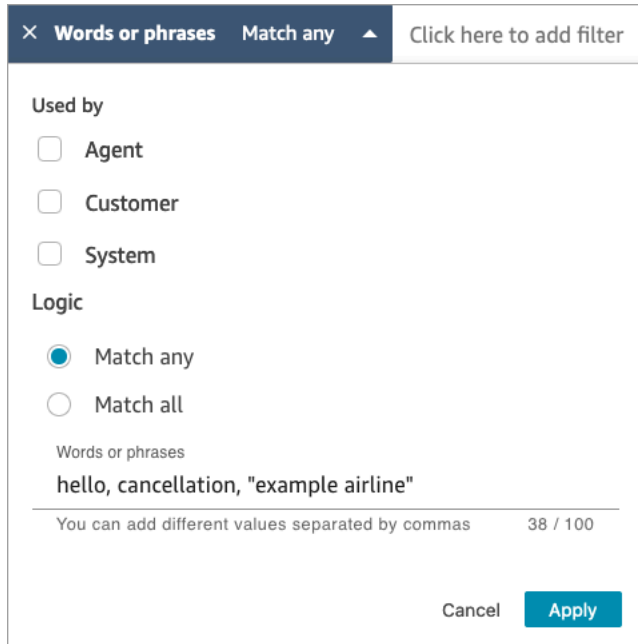

The screenshot shows a search filter dialog box with the following elements:

- Header: **Words or phrases** (with a close 'x' icon), **Match any** (with an up arrow icon), and [Click here to add filter](#).
- Used by** section:
 - Agent
 - Customer
 - System
- Logic** section:
 - Match any
 - Match all
- Text input field: **Words or phrases**
hello, cancellation, "example airline"
- Footer: You can add different values separated by commas and 38 / 100
- Buttons: **Cancel** and **Apply** (highlighted in blue).

- Choose **Match all** to return contacts that have all of the words present in the transcripts.

For example, the following query means match ("thank you for your business" AND cancellation AND "example airline"). And, because all the participant boxes are selected, it means "find contacts where all of these words and phrases were used by all of the participants."

× **Words or phrases** Match all ▲ Click here to add filter

Used by

- Agent
- Customer
- System

Logic

- Match any
- Match all

Words or phrases

"thank you for your business", cancellation, "example airline"

You can add different values separated by commas 62 / 100

- In the **Words or phrases** section, enter the words to search, separated by commas. If you enter a phrase, surround it with quotation marks.

You can enter up to 128 characters.

Search for sentiment score or evaluate sentiment shift

With Contact Lens, you can search conversations for sentiment scores or sentiment shifts on a scale of -5 (most negative) to +5 (most positive). This enables you to identify patterns and factors for why calls go well or poorly.

.2022 Channel All channels × **Sentiment score** ▲ Click here to add filter

Sentiment score

Sentiment score of the agent

Contact sentiment score

0 for the contact

Range -5 to 5

Cancel Apply

For example, suppose you want to identify and investigate all the contacts where the customer sentiment ended negatively. You might search for all contacts where the sentiment score is \leq (less than or equal to) -1.

For more information, see [Investigate sentiment scores during contacts](#).

To search for sentiment scores or evaluate sentiment shift

1. In Amazon Connect, log in with a user account that is assigned the **CallCenterManager** security profile, or that is enabled for the **Search contacts by conversation characteristics** permission.
2. On the **Contact search** page, specify whether you want the sentiment score for words or phrases spoken by the customer or agent.
3. In **Type of score analysis**, specify what type of scores to return:
 - **Sentiment score:** This returns the average score for the customer or agent's portion of the conversation.

In addition to searching for sentiment scores when the agent or customer are on the contact, you can filter the search by when the customer is:

- **With agent on the chat**
- **Without agent on the chat:** This is the time the customer is chatting with a bot, prompts, and time in queue.

The screenshot shows a filter configuration window for 'Sentiment score'. The filter is currently set to 'of the agent' with a value of '0' and a range of '-5 to 5'. A dropdown menu is open, showing the following options: 'agent' (checked), 'customer', 'customer (with agent on the chat)', and 'customer (without agent on the chat)'. A red arrow points to the 'customer (with agent on the chat)' option. The window includes 'Cancel' and 'Apply' buttons.

- **Sentiment shift:** Identify where the customer or agent's sentiment changed during the contact.

For example, the following images shows an example of searching for contacts where the customer's sentiment score begins at less than or equal to -1 and ends at greater than or equal to +1. In addition, the customer is on a chat with the agent present.

× Sentiment score ▲
Click here to add filter

Sentiment score

Sentiment shift ▼ of the customer (with agent on the chat) ▼ during the contact

Beginning sentiment score <= ▼ Beginning sentiment score
-1
Range -5 to 5

End sentiment score >= ▼ End sentiment score
1
Range -5 to 5

Cancel Apply

Search for non-talk time

To help you identify which calls to investigate, you can search for non-talk time. For example, you might want to find all calls where the non-talk time is greater than 20%, and then investigate them.

Non-talk time includes hold time and any silence where both participants aren't talking for longer than three seconds. This duration can't be customized.

Use the drop-down arrow to specify whether to search conversations for the duration or percentage of non-talk time. These options are shown in the following image.

For information about how to use this metric, see [Investigate non-talk time during calls](#).

Non-talk time

Total non-talk time	duration ▼	>= ▼	00:00:00
Longest non-talk time	percentage ▼	>= ▼	%

duration

percentage

Search by response time for chat conversations

You can search by the:

- Average response time of the agent or customer during the chat
- Maximum response time of the agent or customer during the chat

You specify whether the duration is less or greater than or equal to a specific time. For information about how to use this metric, see [Investigate response time during chats](#).

For the supported minimum and maximum response times, see [Amazon Connect Rules feature specifications](#).

The following image shows a search for contacts where the agent's average response time was greater than or equal to 1 minute.

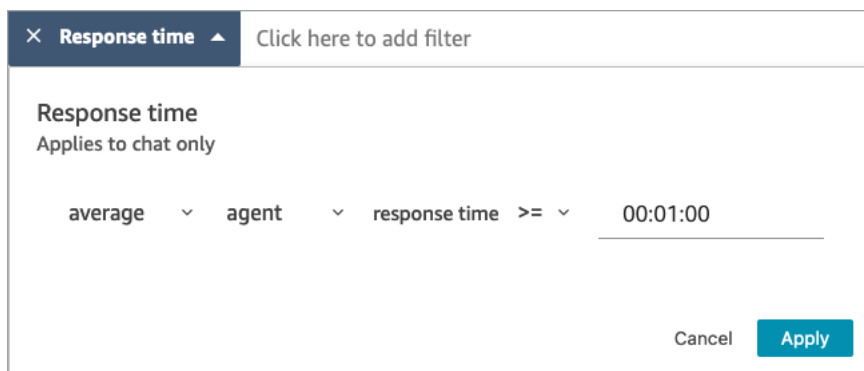

The screenshot shows a filter configuration window for 'Response time'. The window has a title bar with a close button (X) and the text 'Response time' and 'Click here to add filter'. Below the title bar, the text 'Response time' and 'Applies to chat only' is displayed. The main configuration area contains a series of dropdown menus: 'average', 'agent', 'response time', and '>='. To the right of these dropdowns is a text input field containing '00:01:00'. At the bottom right of the window are two buttons: 'Cancel' and 'Apply'.

Search a contact category

1. On the **Contact search** page, choose **Add filter, Contact category**.
2. In the **Contact categories** box, use the dropdown box to list all the current categories that are available for you to search. Or, if you start typing, the input is used to match existing categories and to filter those that don't match.
 - **Match any:** Searches for contacts that match any of the selected categories.
 - **Match all:** Searches for contacts that match all of the selected categories.
 - **Match none:** Searches for contacts that did not match any of the selected categories. Note that this would only return contacts that were analyzed by Contact Lens conversational analytics.

The following image shows a dropdown menu with all the current categories listed.

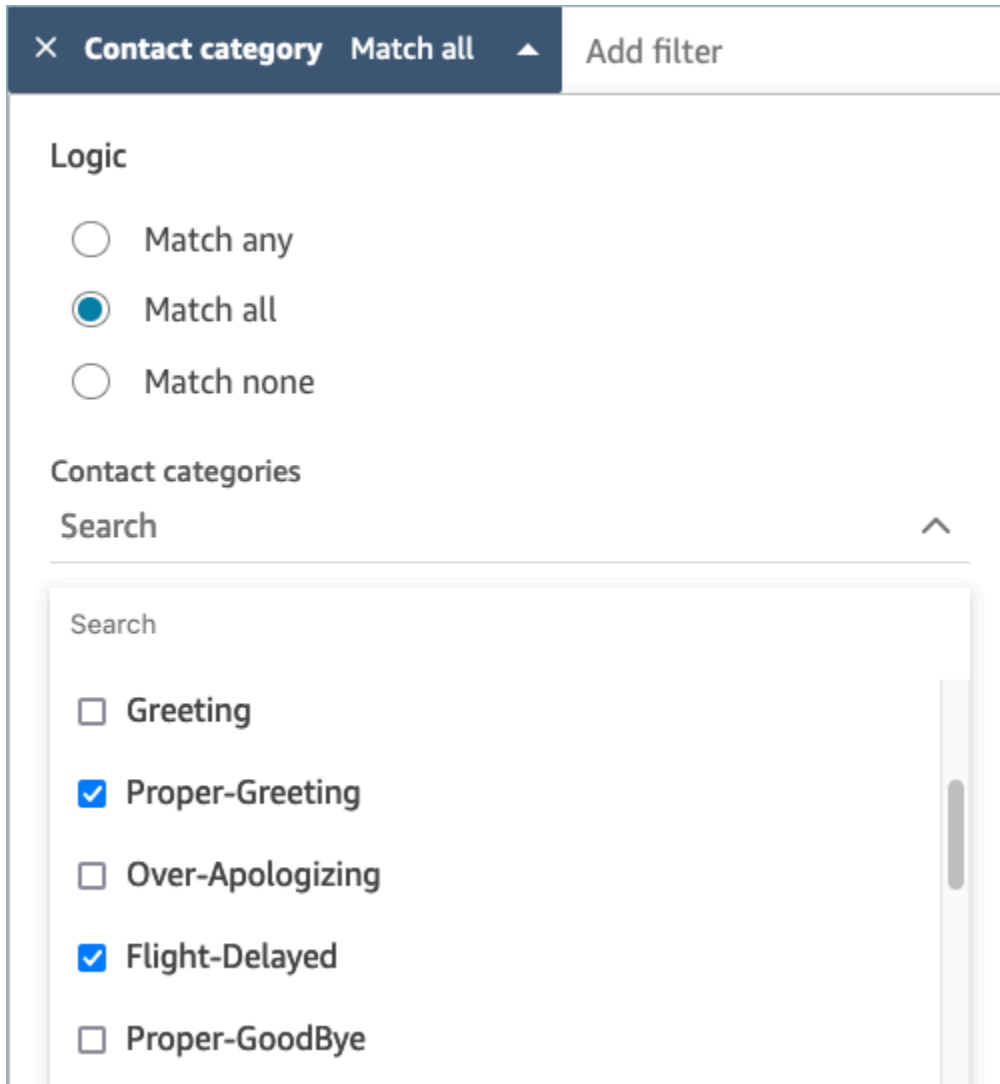

Review analyzed conversations using Contact Lens

By using Amazon Connect Contact Lens, you can review the transcript and identify what part of the contact is of interest. You won't need to listen to an entire call or read an entire chat transcript to find out what's interesting about it. You can focus on specific parts of the audio or transcript. Both are highlighted for you wherever there are points of interest.

For example, you might scan the transcript of the contact and see a red sentiment emoji for a customer turn, which indicates the customer is expressing a negative sentiment. You can choose the timestamp and jump to that portion of audio recording or chat interaction.

- For calls, if desired, choose the play prompt to listen to the recording. Or, click on the relevant part of the recording to listen to the portion you're interested in.
- For chats, if desired, use the graph to navigate to the portion of the transcript you're interested in.

Quickly navigate transcripts and audio

Supervisors are often required to review the contacts for many agents, for quality assurance purposes. The turn-by-turn transcript and sentiment data helps you quickly identify and navigate to the portion of the recording that is of interest to you.

The following image of a contact record shows features that enable you to quickly navigate transcripts and audio to find areas that need your attention. While the image shows a voice contact, the same features apply to chat contacts.

The screenshot displays the 'Recording and transcript' interface. At the top, there is a waveform showing the audio recording. Below the waveform is a playback control bar with a speed of 1x and buttons for play, pause, and stop. The transcript area is divided into sections: 'Key highlights' with buttons for 'Issue', 'Outcome', and 'Action item'; 'Categories' with 'Angry-Customer' selected; and a message history showing a customer message and two agent responses. Red callouts 1, 2, 3, and 4 point to the 'Show key highlights' toggle, the 'Auto scroll' toggle, the 'Customer' category, and the 'Angry-Customer' category, respectively.

- Use [Show key highlights](#) to review only the issue, outcome, and/or action item.

2. Use [Autoscroll](#) for voice contacts, to jump around the audio or transcript. The two always stay in sync.
3. Scan for [sentiment emojis](#) to quickly identify a part for the transcript you want to read or listen to.
4. Choose the timestamp to jump to that part of the audio recording or transcript. The timestamp is calculated from the start of the customer interaction within the contact.

Show key highlights

It can be time-consuming to review contact transcripts that are hundreds of lines long. To make this process faster and more efficient, Contact Lens provides the option for you to view key highlights. The highlights show only those lines where Contact Lens has identified an issue, outcome, or action item in the transcript.

- **Issue** represents the call driver. For example, "I'm thinking of upgrading to your online subscription plan."
- **Outcome** represents the likely conclusion or outcome of the contact. For example, "Based on your current plan I would recommend the online essentials plans that we have."
- **Action item** represents the action item the agent takes. For example, "Please keep an eye out for an email with a price quote. I will send it to you shortly."

Each contact has no more than one issue, one outcome, and one action item. Not all contacts will have all three.

Note

If Contact Lens displays the message **There are no key highlights for this transcript**, it means no issue, outcome, or action item was identified.

You don't need to configure key highlights. It works out-of-the-box without any training of the machine learning model.

Turn on autoscroll to synchronize the transcript and audio

For voice contacts, use **Autoscroll** to jump around the audio or transcript, and the two always stay in sync. For example:

- When you listen to a conversation, the transcript moves along with it, showing you sentiment emojis and any detected issue.
- You can scroll through the transcript, and choose the timestamp for the turn to listen to that specific point in the recording.

Because the audio and transcript are aligned, the transcript can help you understand what the agent and customer are saying. This is especially useful when:

- The audio is bad, maybe due to a connection issue. The transcript can help you understand what's being said.
- There's a dialect or language variant. Our models are trained on different accents so the transcript can help you understand what's being said.

Scan for sentiment emojis

Sentiment emojis help you quickly scan a transcript so you can listen to that part of the conversation.

For example, where you see red emojis for customer turns and then a green emoji, you might choose the timestamp to jump to that specific point of the conversation to check how that agent helped the customer.

Tap or click category tags to navigate through transcript

When you tap or click on the category tags, Contact Lens auto-navigates to the corresponding point-of-interests in the transcript. There are also category markers in the visualization of the interaction to indicate which part of the recording file has utterances related to the category.

The following image shows part of a **Contact details** page for a chat.

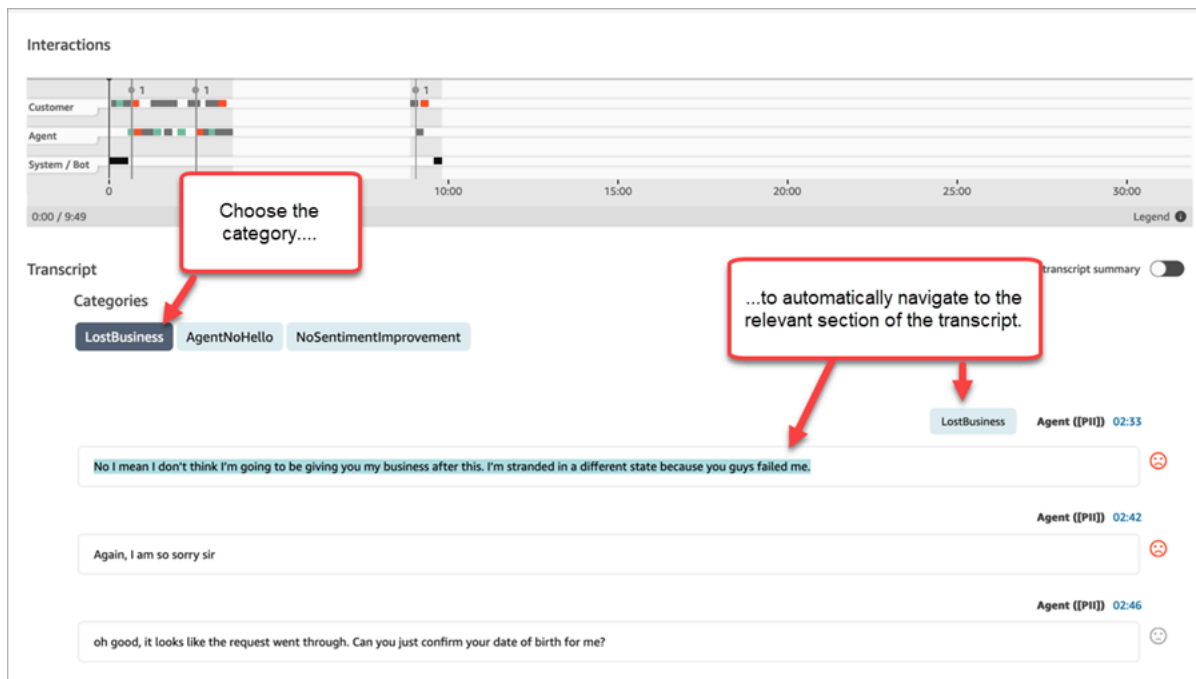

View generative AI-powered post-contact summaries

Note

Powered by Amazon Bedrock: AWS implements [automated abuse detection](#). Because generative AI-powered post-contact summaries is built on Amazon Bedrock, users can take full advantage of the controls implemented in Amazon Bedrock to enforce safety, security, and the responsible use of artificial intelligence (AI).

You can save valuable time with generative AI-powered post-contact summaries that provide essential information from customer conversations in a structured, concise, and easy to read format. You can quickly review the summaries and understand the context instead of reading through transcripts and monitoring calls.

Region and language availability: This feature is available only for Amazon Connect instances created in the US East (N. Virginia) and US West (Oregon) AWS Regions, and in [English locales](#). It's available for the voice and chat channels.

The following image shows an example of generative AI-powered post-contact summaries on the **Contact details** page.

Contact details

Completed | Last updated: Oct 28, 2019, 10:36:32 pm

Overview

Voice | Duration: 7 mins 14 s (Nov 17, 2023, 11:08–11:15 AM)

Queue	Agent	Initiation method	Disconnect reason	Customer phone number
BasicQueue	[Redacted]	Inbound	Customer disconnect	+17069988721



Summary Generated by AI 

The customer expresses frustration about a delayed gift delivery, providing the order number. The call center agent apologizes, explains the delay, and suggests sending a replacement item with expedited delivery at no extra cost to appease the customer. The customer reluctantly agrees, emphasizing the importance of timely delivery, and the agent assures they will monitor the new shipment closely to ensure prompt arrival.

The following image shows an example of generative AI-powered post-contact summaries on the **Contact search** page.

Contacts

November 15, 2023 - America/Los_Angeles

Contact ID	Channel	Contact status	Initiation timestamp	System phone number	Queue	Agent	Recording/Transcript	Customer phone number	Disconnect timestamp
a4602d...	Chat	Completed	Nov 15, 2023, 02:58:43 pm		BasicQueue	user_0	 		Nov 15, 2023, 03:03:22 pm

Summary Generated by AI 

The customer's credit card was declined due to fraudulent activity from Europe. The agent blocked those transactions so there was no impact on the customer's balance. However, the card needed to be cancelled. The agent booked an appointment for the following week to get the customer a new credit card and sent a transaction report to confirm the current balance.

Transcript Show key highlights

Key highlights Issue Outcome

Categories customer-credit 2 credit-card 2 agent-intro

Customer ((PII)) 01:43 Issue

 My credit card was declined

Each contact has no more than one summary generated. Not all contacts will have a summary generated; for more information, see [Why a summary is not generated](#).

Note

Chat contacts in supported locales and AWS Regions have summaries only for text/plain messages. By default the [Text chat](#) feature in the Amazon Connect admin website creates text/markdown messages that will not be used for summaries. To test integration, use a [customized chat widget](#) with only text/plain "supportedMessagingContentTypes".

Get started

1. Add a [Set recording and analytics behavior](#) block to your flow.
2. Configure the **Properties** page of the block:
 - Set **Analytics** to **On**.
 - Choose either **Enable speech analytics**, **Enable chat analytics**, or both.
 - If you choose redaction, the post-contact summary inherits the overall transcript redaction settings. If you choose granular settings, the post-contact summary still redacts all PII.
 - Under **Contact Lens Generative AI capabilities**, choose **Post-contact summary**.

The following image shows a **Properties** page that is configured to enable chat analytics and Contact Lens Generative AI capabilities:

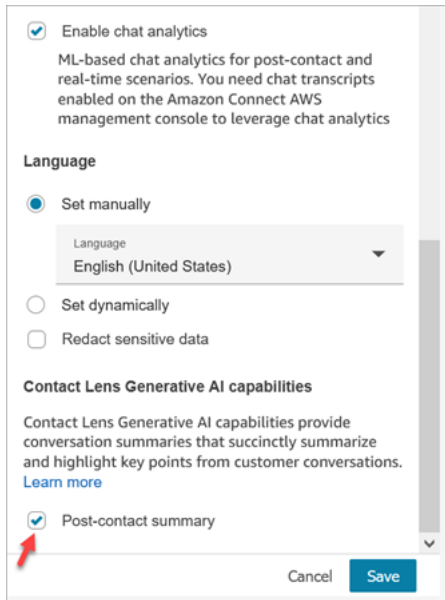

Assign security profile permissions

[Assign](#) the following security profile permissions to users who need access to this feature:

- **Contact Lens–post-contact summary, View**
- **Recorded conversations (redacted), View** or **Recorded conversations (unredacted), View**

The following image shows where these permissions are located on the **Analytics and Optimization** section of the **Edit security profile** page.

Edit security profile

Analytics and Optimization

This group gives access to real-time metrics, historical metrics, contact trace records, call recordings, manager listen in, forecasting and capacity planning.

Type	All	Access	View	Edit	Create
Access metrics	<input type="checkbox"/>	<input checked="" type="checkbox"/>	<input type="checkbox"/>	<input type="checkbox"/>	<input type="checkbox"/>
Real-time metrics ⓘ	<input type="checkbox"/>	<input checked="" type="checkbox"/>	<input type="checkbox"/>	<input type="checkbox"/>	<input type="checkbox"/>
Historical metrics ⓘ	<input type="checkbox"/>	<input checked="" type="checkbox"/>	<input type="checkbox"/>	<input type="checkbox"/>	<input type="checkbox"/>
Agent activity audit ⓘ	<input type="checkbox"/>	<input checked="" type="checkbox"/>	<input type="checkbox"/>	<input type="checkbox"/>	<input type="checkbox"/>
Dashboards ⓘ	<input type="checkbox"/>	<input type="checkbox"/>	<input type="checkbox"/>	<input type="checkbox"/>	<input type="checkbox"/>
Contact search ⓘ	<input type="checkbox"/>	<input type="checkbox"/>	<input checked="" type="checkbox"/>	<input type="checkbox"/>	<input type="checkbox"/>
View my contacts ⓘ	<input type="checkbox"/>	<input type="checkbox"/>	<input type="checkbox"/>	<input type="checkbox"/>	<input type="checkbox"/>
Search contacts by conversation characteristics	<input type="checkbox"/>	<input type="checkbox"/>	<input checked="" type="checkbox"/>	<input type="checkbox"/>	<input type="checkbox"/>
Search contacts by keywords	<input type="checkbox"/>	<input type="checkbox"/>	<input checked="" type="checkbox"/>	<input type="checkbox"/>	<input type="checkbox"/>
Configure searchable contact attributes	<input type="checkbox"/>	<input type="checkbox"/>	<input checked="" type="checkbox"/>	<input type="checkbox"/>	<input type="checkbox"/>
Restrict contact access ⓘ	<input type="checkbox"/>	<input type="checkbox"/>	<input type="checkbox"/>	<input type="checkbox"/>	<input type="checkbox"/>
Contact attributes ⓘ	<input type="checkbox"/>	<input type="checkbox"/>	<input checked="" type="checkbox"/>	<input type="checkbox"/>	<input type="checkbox"/>
Contact Lens - conversational analytics	<input type="checkbox"/>	<input type="checkbox"/>	<input checked="" type="checkbox"/>	<input type="checkbox"/>	<input type="checkbox"/>
Contact Lens - post-contact summary	<input type="checkbox"/>	<input type="checkbox"/>	<input checked="" type="checkbox"/>	<input type="checkbox"/>	<input type="checkbox"/>
Contact Lens - custom vocabularies ⓘ	<input type="checkbox"/>	<input type="checkbox"/>	<input checked="" type="checkbox"/>	<input checked="" type="checkbox"/>	<input type="checkbox"/>
Contact Lens - theme detection	<input type="checkbox"/>	<input type="checkbox"/>	<input checked="" type="checkbox"/>	<input type="checkbox"/>	<input checked="" type="checkbox"/>
Rules	<input type="checkbox"/>	<input type="checkbox"/>	<input checked="" type="checkbox"/>	<input checked="" type="checkbox"/>	<input checked="" type="checkbox"/>
Recorded conversations (redacted)	<input type="checkbox"/>	<input type="checkbox"/>	<input checked="" type="checkbox"/>	<input type="checkbox"/>	<input type="checkbox"/>

Why a summary is not generated

If a summary is not generated, an error message is displayed on the **Contact details** and **Contact search** pages. In addition, the ReasonCode for the error appears in the ContactSummary object in the Contact Lens output file, similar to the following example:

```
"JobDetails": {
  "SkippedAnalysis": [
    {
      "Feature": "POST_CONTACT_SUMMARY",
      "ReasonCode": "INSUFFICIENT_CONVERSATION_CONTENT"
```

```
    }  
  ]  
},
```

Following is a list of error messages that may be displayed on the Contact details or search pages if a summary is not generated. Also listed is the associated reason code that appears in the Contact Lens output file.

- **Summary could not be generated due to exceeding quota of concurrent summaries.**

ReasonCode: QUOTA_EXCEEDED.

If you receive this message, we recommend that you [submit a ticket](#) to increase the [Concurrent post-contact summary jobs](#) quota.

- **Summary could not be generated due to not enough eligible conversation.** ReasonCode: INSUFFICIENT_CONVERSATION_CONTENT.

For voice, there must be 1 utterance from each participant. For chat, there must be 1 message from each participant. Chat messages must be text/plain messages. If there are text/markdown messages, even if there is a lot of conversation between participants it won't be analyzed because text/markdown is not supported for this feature, and the error message will be displayed.

- **Contact Flow had invalid Contact Lens configuration for PostContact Summary, such as unsupported or invalid language code.** ReasonCode: INVALID_ANALYSIS_CONFIGURATION.

This error is returned if the enabled summary is incompatible with other contact lens settings, particularly if it's enabled for an unsupported locale.

- **Summary cannot be provided because it failed to satisfy security and quality guardrails.** ReasonCode: FAILED_SAFETY_GUIDELINES.

The generated summary cannot be provided because it failed to satisfy system safety guidelines.

View key highlights

It can be time-consuming to review contact transcripts that are hundreds of lines long. To make this process faster and more efficient, Contact Lens automatically identifies and labels key parts of customer conversations, then displays highlights of the conversations. Managers can view those highlights on the **Contact details** page. Agents can view the highlights in the Contact Control Panel (CCP).

Tip

For a list of supported languages, see the *Key highlights* column in the [Amazon Connect Contact Lens supported languages](#) topic.

After you enable Contact Lens, it identifies key parts of a customer conversation, assigns labels (such as issue, outcome, or action item) to those parts, and displays highlights of the customer conversation. You can expand the highlights to view the full transcript of the contact.

The following example shows the key highlights on the **Contact details** page.

The screenshot displays the Amazon Connect interface for a contact. At the top, there are tabs for 'Issue', 'Outcome', and 'Action item'. To the right, there are two toggle switches: 'Show key highlights' (which is turned on) and 'Auto scroll'. Below the tabs, there are 'Categories' including 'Angry-Customer' with a count of 2. The contact details show a customer message at 02:14 with an 'Issue' label and 'Angry-Customer 2/2' category. The message text is: "Hello, I've been waiting for my gift delivery, and it's still not here! This is absolutely ridiculous. It was supposed to be here two days ago!". Below this is an agent response at 04:54 with an 'Action item' label. The agent text is: "I completely understand your frustration, and I'm here to help. To make it up to you, we can expedite the delivery of a replacement item at no extra cost. Would that be acceptable to you?". A second agent response at 05:44 has an 'Outcome' label. The agent text is: "I completely agree. I'll make sure to arrange for a replacement item to be shipped with our fastest delivery method. You should receive it within the next 48 hours. Additionally, I'll escalate the issue with the original delivery to prevent this from happening again in the future." Red callout boxes with numbers 1, 2, 3, and 4 point to the 'Show key highlights' toggle, the 'Angry-Customer' category, the 'Action item' label, and the 'Outcome' label respectively.

1. Toggle **Show key highlights** on and off as needed.
2. **Issue** represents the contact driver. For example, "I'm thinking of upgrading to your online subscription plan."
3. **Action item** represents the action item the agent takes. For example, "Please keep an eye out for an email with a price quote. I will send it to you shortly."
4. **Outcome** represents the likely conclusion or outcome of the contact. For example, "Based on your current plan I would recommend our online essentials plan."

Contacts have only one issue, one outcome, and one action item. It's possible for some contacts to not have all three.

Note

You see this message **There are no key highlights for this transcript** when Contact Lens can't identify an issue, outcome, or action item.

To learn about the agent's experience—what part of the transcript is displayed in the Contact Control Panel (CCP), and when—see [Design a flow for key highlights](#).

Use theme detection to discover issues

Use theme detection to discover previously unknown or emerging contact themes from thousands of customer interactions. For example, you can spot common reasons for customer outreach such as "cancel reservation" or "delayed order." You can then take appropriate actions to improve the customer experience by expediting issue resolution, and improving IVR options, knowledge base articles, and agent training.

Important things to know

- Theme detection is available in some languages supported by Amazon Connect Contact Lens. For more information, see [Theme detection](#) in the *Languages supported by Amazon Connect* topic.
- Theme detection is supported on contacts that were created on or after January 30, 2023.
- The **Generate themes report** button is enabled only when your saved search contains at least 1,000 contacts with issues detected by Contact Lens.
- The theme detection report is generated for the 3,000 most recent contacts.
- Theme detection reports are available for 30 days after they are created. After 30 days, the reports are deleted from the database and cannot be retrieved.
- The most recent 20 theme reports for a saved search are available in the **View theme reports** dropdown menu, as shown in the following image.

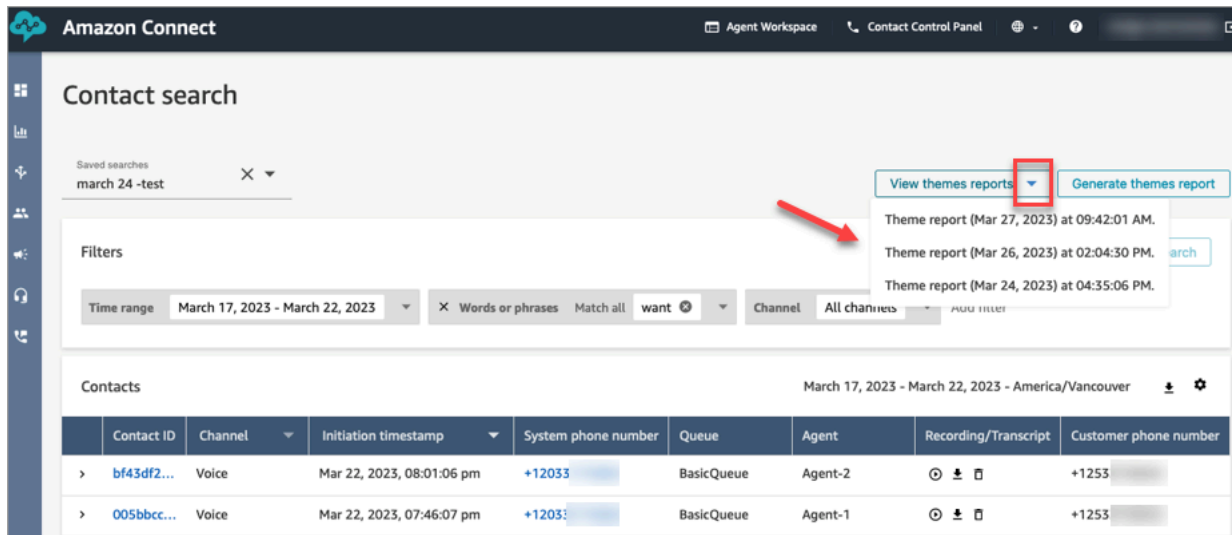

How to generate a theme report

1. Login to Amazon Connect using an account that has the following security profile permissions:
 - **Contact search - Access**
 - **Contact Lens - theme detection - Create**
 - **Contact Lens - theme detection - View**
2. In Amazon Connect, on the left navigation menu, choose **Analytics and optimization, Contact search**.
3. On the **Contact search** page, apply filters to select a group of contacts that have been analyzed by Contact Lens.

⚠ Important

Your search query must return at least 1,000 contacts with issues detected by Contact Lens. Otherwise, the **Generate themes report** button is not enabled.

4. Choose **Save search** to save your results. Assign a name to your search.
5. Choose **Generate themes report**.

Contact Lens applies machine learning to automatically group contacts with similar issues. When the report is generated, a banner displays a link to the theme report. An example banner is shown in the following image.

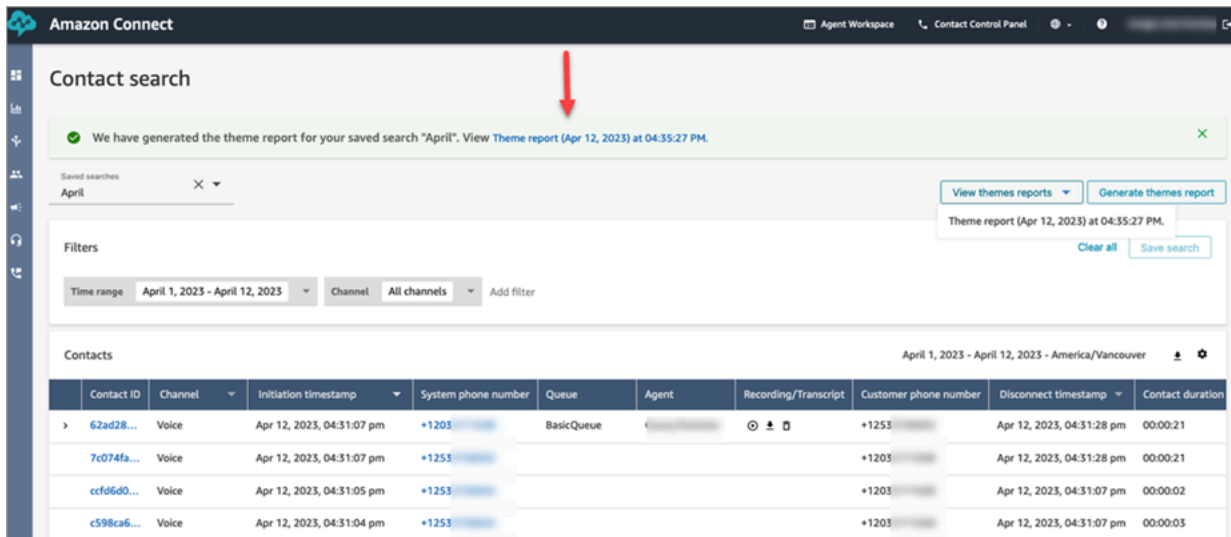

6. Click or tap the link for the theme report.

The theme report is displayed. It includes theme labels and a list of contacts, as shown in the following image.

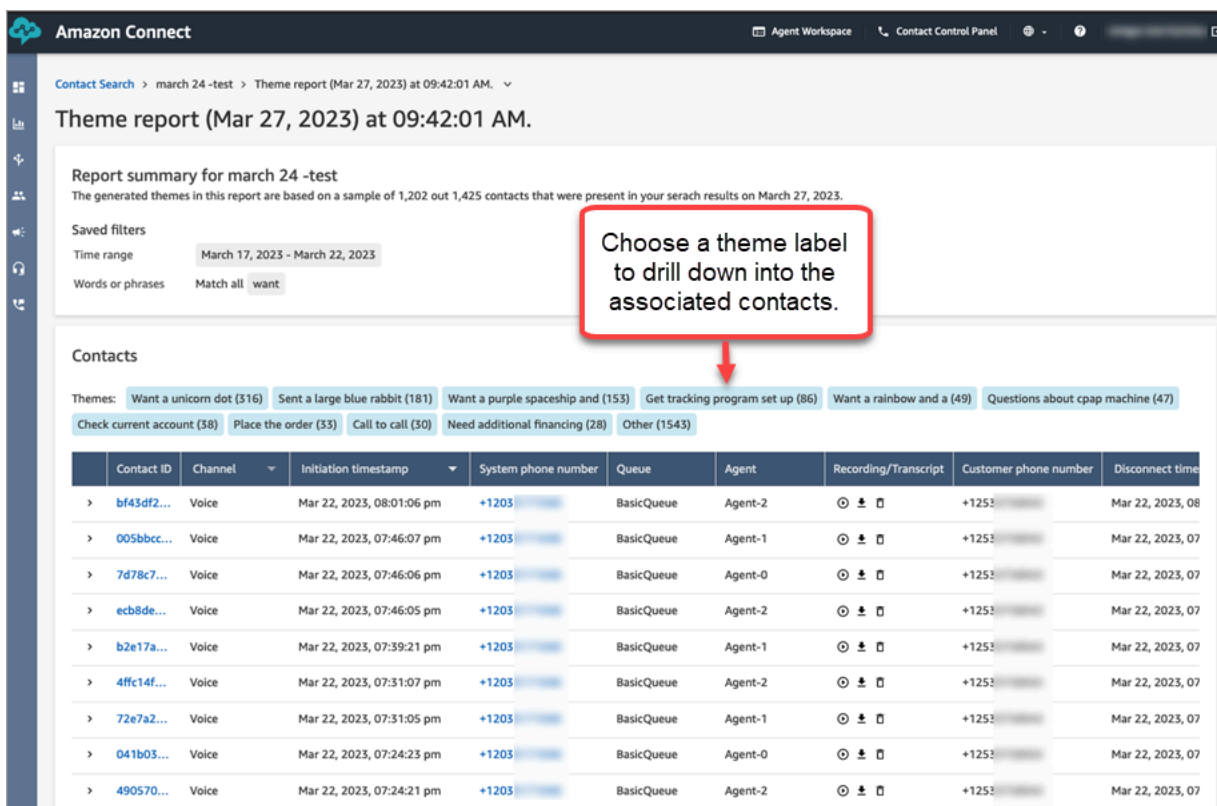

7. Click or tap the theme labels to view associated contacts, listen to specific recordings, and read transcripts for deeper analysis.

Investigate sentiment scores during contacts

What are sentiment scores?

A sentiment score is an analysis of text, and a rating of whether it includes mostly positive, negative, or neutral language. Supervisors can use sentiment scores to search conversations and identify contacts that are associated with varying degrees of customer experiences, positive or negative. It helps them identify which of their contacts to investigate.

You can view a sentiment score for the entire conversation, as well as sentiment trend across whole contact.

How to investigate sentiment scores

When working to improve your contact center, you may want to focus on the following:

- Contacts that start with a positive sentiment score but end with a negative score.

If you want to focus on a limited set of contacts to sample for quality assurance, for example, you can look at contacts where you know the customer had a positive sentiment at the start but ended with a negative sentiment. That shows you they left the conversation unhappy about something.

- Contacts that start with a negative sentiment score but end positive.

Analyzing these contacts will help you identify what experiences you can recreate in your contact center. You can share successful techniques with other agents.

An additional way of looking at sentiment progression is to check the sentiment trendline. You can see the variation in the customer's sentiment as the contact progresses. For example, the following image shows a conversation with a very low sentiment score in the beginning of the conversation, and very positive one at the end.

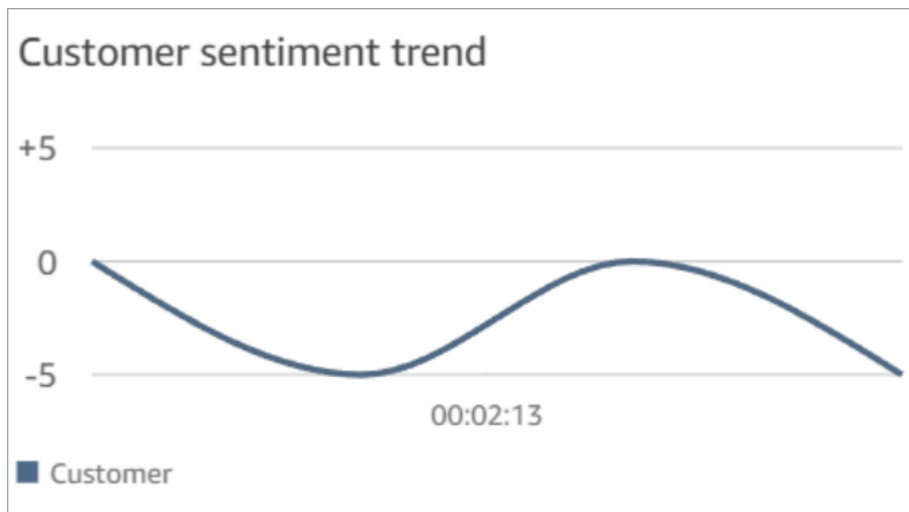

For more information, see [Search for sentiment score or evaluate sentiment shift](#).

How sentiment scores are determined

Amazon Connect Contact Lens analyzes the sentiment of each speaker turn in a conversation as positive, negative, or neutral. It then considers two factors for each participant turn to assign a score that ranges from -5 to +5 for each period of the call:

- Frequency. The number of times the sentiment is positive, negative or neutral.
- Sentiment streaks. The consecutive turns with same sentiment.

The overall sentiment score is the average of the scores assigned during each portion of the call.

Investigate non-talk time during calls

What is non-talk time?

Amazon Connect Contact Lens also identifies the amount of *non-talk time* in a call. Non-talk time equals hold time, plus any silence where both participants aren't talking for more than 3 seconds. This duration can't be customized.

The following image shows the location of non-talk time data on the **Contact details** page.

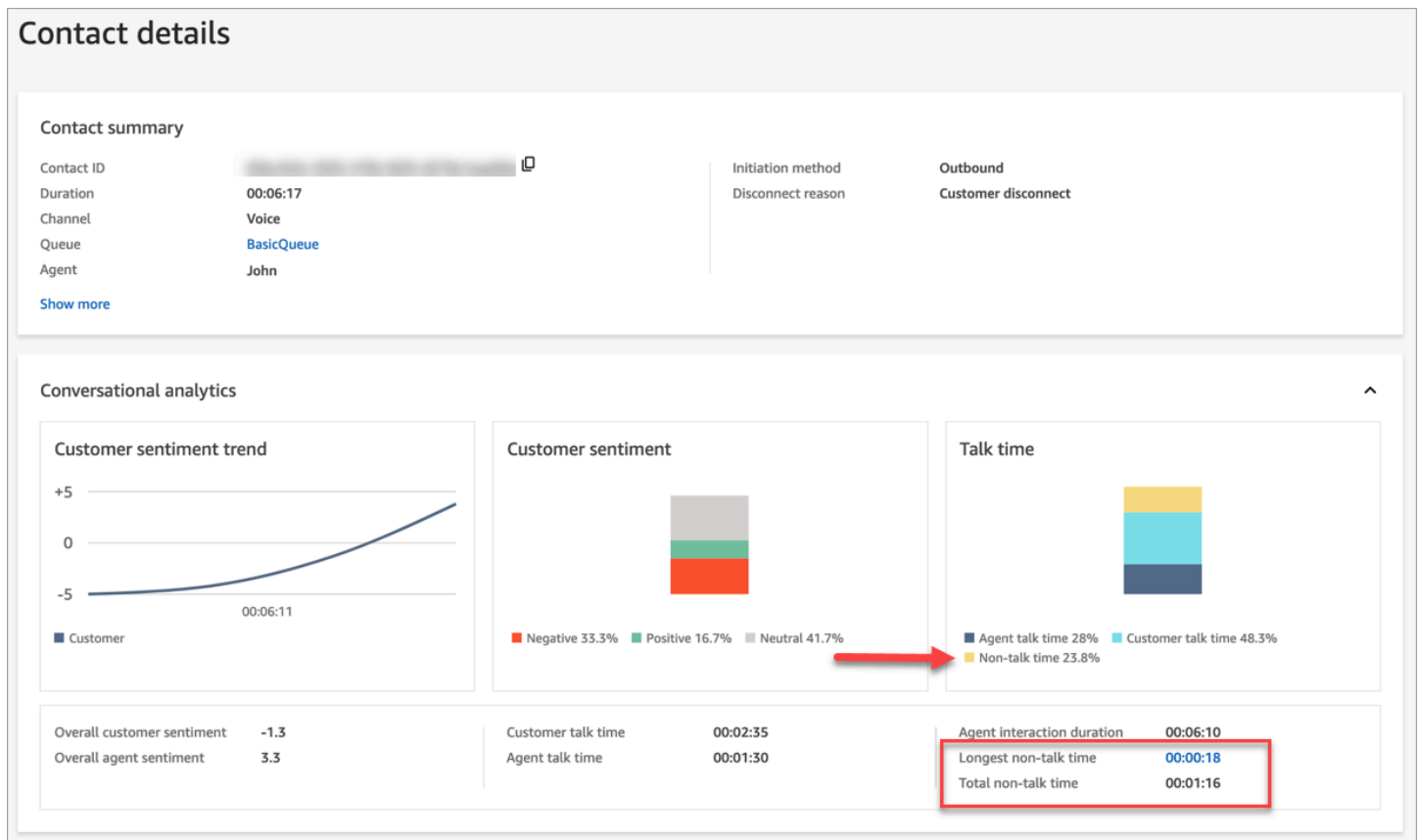

How to investigate non-talk time

Non-talk time can help you identify calls that have gone poorly. This may be because:

- The customer was asking a question that's new for your contact center.
- It's taking the agent a long time to do something but they are well-trained. This indicates there may be an issue with the tools the agent is using. For example, the tools aren't responsive enough or aren't easy to use.
- The agent didn't have a ready answer, but they are fairly new. This indicates they need more training.

You can decide whether to focus on these contacts to improve your contact center. For example, you can go to that section of the audio, and then look at the transcript to see what was going on.

In the following example, the non-talk time occurred when the agent was searching for the caller's trip ID. This could indicate there's an issue with the agent's tools. Or if the agent is new, they need more training.



For more information, see [Search for non-talk time](#).

Investigate response time during chats

Use the response time metric to understand the responsiveness of the agent or customer during a chat contact.

Contact Lens calculates the following metrics:

- **Agent greeting time.** This is the first response time for the agent, which is how fast the agent engaged with the customer after the agent joined the chat. A long first response time may explain, for example, if a customer has a negative sentiment in the beginning of conversation.
- **Avg agent response time** and **Avg customer response time.** The agent response time helps you check an agent's performance against your organization's base line.
- **Max agent response time** and **Max customer response time.**

The customer's max response time may explain an agent's response time. For example, if a customer didn't reply for five minutes and then sent a message, it's possible the agent took longer than usual to respond because they were handling other chats at the same time.

We recommend examining the response time metrics in conjunction with the interactions graph that shows gaps in conversation and participant sentiment.

You can click or tap the longest response time value on the graph to be directed to the associated message in the transcript.

The following image of the **Contact details** page shows metrics for chat conversations. Note that **Agent greeting time** = after the agent joined the chat, how long until they sent the first response.

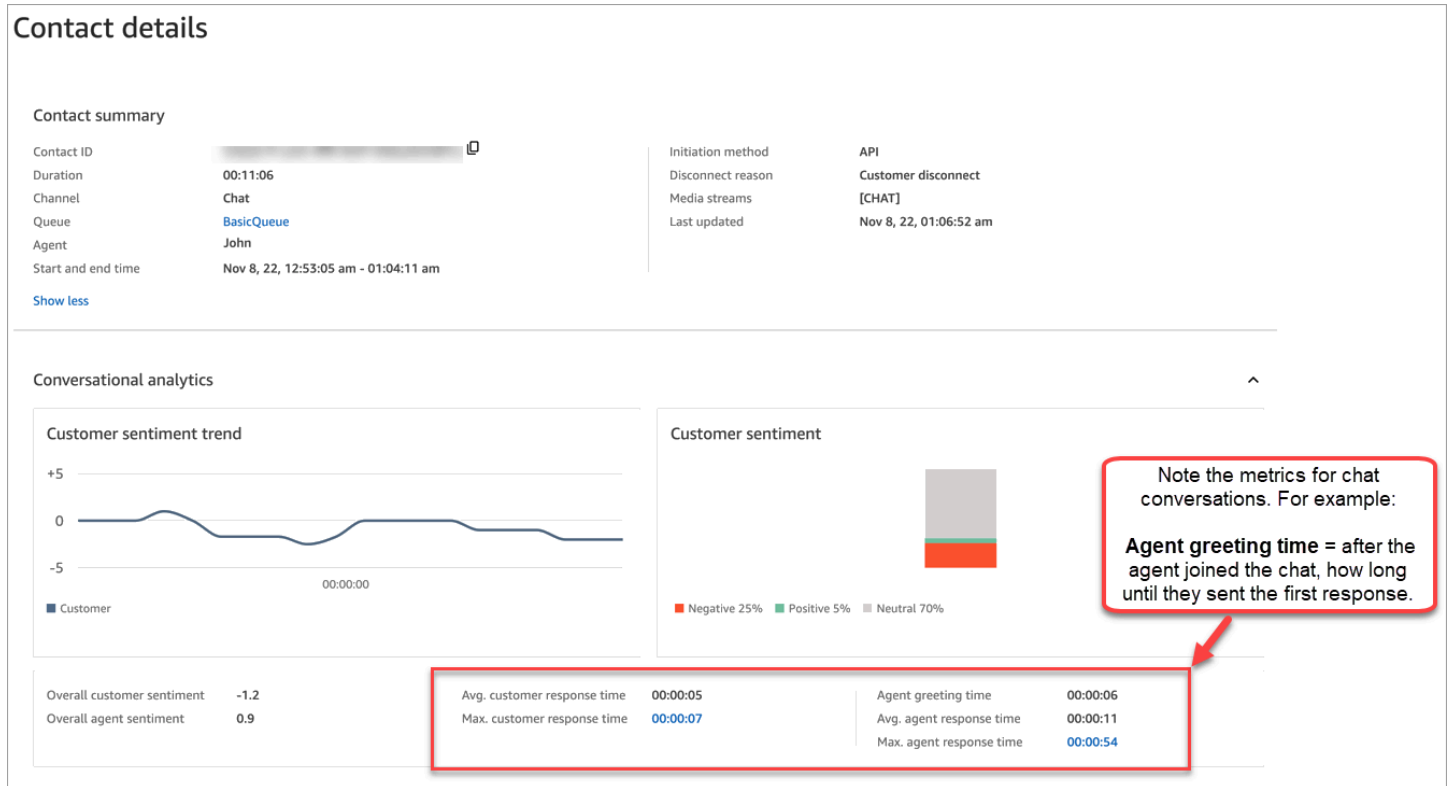

For more information, see [Search by response time for chat conversations](#).

Investigate loudness scores during calls

A loudness score measures how loudly the customer or agent are speaking during a call. Contact Lens displays an analysis of the conversation that lets you identify where the customer or agent may be talking loudly and have a negative sentiment.

How to use loudness scores

We recommend using loudness scores together with sentiments. Look for areas of the conversation where the loudness score is high and the sentiment is low. Then read that portion of the transcript or listen to that section of the call.

For example, the following is an image of a recording and transcript analysis. Spiked vertical bars indicate where the customer is talking loudly. The horizontal red bars indicate their sentiment is negative.

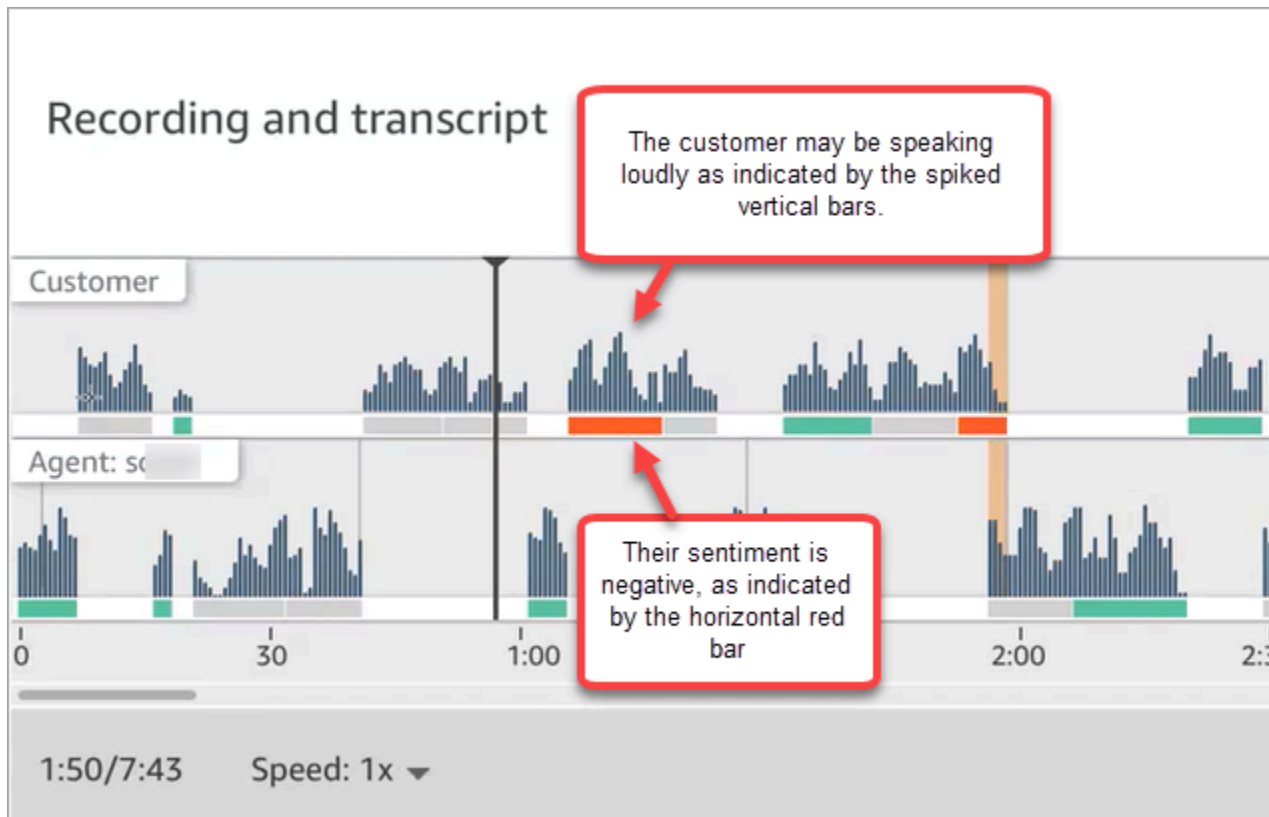

Use sensitive data redaction

To help you protect your customer's privacy, Contact Lens lets you automatically redact sensitive data from conversation transcripts and audio files. It redacts sensitive data, such as name, address, and credit card information using Natural Language Understanding.

To enable redaction, choose the option on the **Set recording and analytics behavior** block. For more information, see [Enable redaction of sensitive data](#).

Sensitive data redaction is applied after a call disconnects.

⚠ Important

The redaction feature is designed to identify and remove sensitive data. However, due to the predictive nature of machine learning, it may not identify and remove all instances of sensitive data in a transcript generated by Contact Lens. We recommend you review any redacted output to ensure it meets your needs.

The redaction feature does not meet the requirements for de-identification under medical privacy laws like the U.S. Health Insurance Portability and Accountability Act of 1996 (HIPAA), so we recommend you continue to treat it as protected health information after redaction.

For a list of the languages supported by Contact Lens redaction, see [Languages supported by Amazon Connect](#).

About redacted files

Redacted voice files are stored in your Voice Amazon S3 bucket, for example: connect-*instanceARN*/Analysis.

Redacted chat files are stored in your chat Amazon S3 bucket, for example: connect-*instanceARN*/Chat

You can access all files (redacted, unredacted, raw, etc.) through the AWS console, by using the Amazon S3 console.

Following is a list of what you can access by using the Amazon Connect admin website (such as on the **Contact details** page), assuming you have the appropriate [security profile permissions](#):

- Access redacted voice and chat files.
- Download redacted voice recordings.

Note

Currently, you cannot download redacted chat files and voice transcripts.

When redaction is enabled, Contact Lens generates the following files:

- A redacted file. This file is generated by default when Redaction is enabled. It's the output schema, with sensitive data redacted. For an example file, see [Example redacted file for a call](#).
- An original (raw), analyzed file. This file is generated only when you choose **Get redacted and original transcripts with redacted audio** in the [Set recording and analytics behavior](#) block. For an example file, see [Example original, analyzed file for a call](#).

⚠ Important

For voice contacts, the original analyzed file is the only place where the complete conversation is stored. If you delete it, there will be no record of the sensitive data that was redacted.

- A redacted audio file (wav) for voice contacts. Sensitive data in audio files is redacted as silence. These silent times are not flagged in the Amazon Connect admin website or elsewhere as non-talk time.

Use your file retention policies to determine how long to keep these files.

Use the API for real-time call and chat analytics

Contact Lens includes two APIs that support conversational analytics. Use these APIs to build solutions that make your contact center more efficient.

- [ListRealtimeContactAnalysisSegments](#): Use for voice contacts.
- [ListRealtimeContactAnalysisSegmentsV2](#): Use for chat contacts.

These real-time conversational analytics APIs are polling APIs, with a standard request/response exchange, where you don't need to integrate with any other service. However, there are [rate limitations](#). If needed, you can eliminate these limitations by using the [real-time streaming API](#). It requires integration with Amazon Kinesis Data Streams.

Following are two use cases for the real-time call and chat analytics API.

Better contact transfers

When a contact is transferred from one agent to another agent, you can transfer a transcript of the conversation to the new agent. The new agent then has context for why the customer is contacting your contact center, and the customer doesn't need to repeat information they already provided. Use the [ListRealtimeContactAnalysisSegments](#) API for voice contacts and the [ListRealtimeContactAnalysisSegmentsV2](#) API for chats to get the entire transcript of the conversation up to a certain point, and share it with the new agent.

Highlight key parts of the conversation as labels, issues, action items, and outcomes

With key highlights agents can quickly make notes after the contact ends, and supervisors can quickly identify contacts for quality and agent performance management. This makes agents and supervisors more productive at their jobs.

Use streaming for real-time contact analysis

Real-time contact analysis segment streams enable you to access Contact Lens analytics in near real-time for voice and chat contacts. Real-time streaming overcomes the scaling limitations of existing [real-time call analytics API](#). For voice contacts, it also provides access to a data segment called Utterance that allows you to access partial transcripts. This enables you to meet ultra-low latency requirements to assist agents on live calls.

This section explains how to integrate with Amazon Kinesis Data Streams for real-time streaming.

Through real-time streaming, you can receive the following event types:

- **STARTED** events published at the beginning of a real-time contact analysis session.
- **SEGMENTS** events published during the real-time contact analysis sessions. These events contain a list of segments with analyzed information.
- **COMPLETED** or **FAILED** events published at the end of a real-time contact analysis session.

Contents

- [Enable real-time contact analysis segment streams](#)
- [Data model for real-time contact analysis segment streams for voice contacts](#)
- [Data model for real time contact analysis segment streams for chat contacts](#)
- [Voice: Sample real-time contact analysis segment stream](#)
- [Chat: Sample real-time contact analysis segment stream](#)

Enable real-time contact analysis segment streams

Real-time contact analysis segment streams are not enabled by default. This topic explains how to enable them.

Step 1: Create a Kinesis stream

Create the data stream on the same account and Region where your Amazon Connect instance resides. For instructions, see [Step 1: Create a Data Stream](#) in the *Amazon Kinesis Data Streams Developer Guide*.

Tip

We recommend creating a separate stream for each type of data. While it's possible to use the same stream for real-time contact analysis segment streams, agent events, and contact records, it is much easier to manage and get data from the stream when you use a separate stream for each one. For more information, see the [Amazon Kinesis Data Streams Developer Guide](#).

Step 2: Set up server-side encryption for the Kinesis stream (optional but recommended)

There are several ways you can do this.

- Option 1: Use the Kinesis AWS managed key (`aws/kinesis`). This works with no additional setup from you.
- Option 2: Use the same customer managed key for call recordings, chat transcripts, or exported reports in your Amazon Connect instance.

Enable encryption, and use a customer managed key for call recordings, chat transcripts, or exported reports in your Amazon Connect instance. Then choose the same KMS key for your Kinesis data stream. This key already has the permission (grant) required to be used.

- Option 3: Use a different customer managed key.

Use an existing customer managed key or create a new one and add required permissions for Amazon Connect role to use the key. To add permissions using AWS KMS grants, see the following example:

```
aws kms create-grant \  
  --key-id your key ID \  
  --grantee-principal arn:aws:iam::your AWS account ID:role/aws-service-role/  
connect.amazonaws.com/AWSServiceRoleForAmazonConnect_11111111111111111111111111111111 \  
  --operations GenerateDataKey \  
  --retiring-principal arn:aws:iam::your AWS account ID:role/adminRole
```

Where `grantee-principal` is the ARN of the service-linked role associated to your Amazon Connect instance. To find the ARN of the service-linked role, in the Amazon Connect console, go to **Overview, Distribution settings, Service-linked role**.

Step 3: Associate the Kinesis stream

Use the Amazon Connect [AssociateInstanceStorageConfig](#) API to associate the following resource types:

- For voice contacts, use `REAL_TIME_CONTACT_ANALYSIS_VOICE_SEGMENTS`
- For chat contacts, use `REAL_TIME_CONTACT_ANALYSIS_CHAT_SEGMENTS`

Note

`REAL_TIME_CONTACT_ANALYSIS_SEGMENTS` is deprecated, but it is still supported and applies to voice contacts only. Use `REAL_TIME_CONTACT_ANALYSIS_VOICE_SEGMENTS` for voice contacts moving forward.

If you have previously associated a stream with `REAL_TIME_CONTACT_ANALYSIS_SEGMENTS`, no action is needed to update the stream to `REAL_TIME_CONTACT_ANALYSIS_VOICE_SEGMENTS`.

Specify the Kinesis stream where real-time contact analysis segments will be published. You'll need the instance ID and the Kinesis stream ARN. The following code shows an example:

```
// Build request
const request: Connect.Types.AssociateInstanceStorageConfigRequest = {
  InstanceId: 'your Amazon Connect instance ID',
  ResourceType: 'REAL_TIME_CONTACT_ANALYSIS_VOICE_SEGMENTS or
REAL_TIME_CONTACT_ANALYSIS_CHAT_SEGMENTS',
  StorageConfig: {
    StorageType: 'KINESIS_STREAM',
    KinesisStreamConfig: {
      StreamArn: 'the ARN of your Kinesis stream',
    },
  },
};
```

AWS CLI

The following example is for chat contacts.

```
aws connect associate-instance-storage-config --instance-id your Amazon Connect instance ID --resource-type REAL_TIME_CONTACT_ANALYSIS_CHAT_SEGMENTS --storage-config StorageType=KINESIS_STREAM,KinesisStreamConfig={StreamArn=the ARN of your Kinesis stream}
```

AWS SDK

The following example is for voice contacts.

```
import { Connect } from 'aws-sdk';

async function associate (): Promise <void> {
  const clientConfig: Connect.ClientConfiguration = {
    region: 'the Region of your Amazon Connect instance',
  };

  const connect = new Connect(clientConfig);

  // Build request
  const request: Connect.Types.AssociateInstanceStorageConfigRequest = {
    InstanceId: 'your Amazon Connect instance ID',
    ResourceType: 'REAL_TIME_CONTACT_ANALYSIS_VOICE_SEGMENTS',
    StorageConfig: {
      StorageType: 'KINESIS_STREAM',
      KinesisStreamConfig: {
        StreamArn: 'the ARN of your Kinesis stream',
      },
    },
  };

  try {
    // Execute request
    const response: Connect.Types.AssociateInstanceStorageConfigResponse = await
connect.associateInstanceStorageConfig(request).promise();

    // Process response
    console.log('raw response: ${JSON.stringify(response, null, 2)}');
```

```
    } catch (err) {
      console.error('Error calling associateInstanceStorageConfig. err.code:
${err.code}, ' +
        'err.message: ${err.message}, err.statusCode: ${err.statusCode}, err.retryable:
${err.retryable}');
    }
  }
}

associate().then(r => console.log('Done'));
```

Step 4: Enable Contact Lens for your Amazon Connect instance

For instructions, see [Enable Amazon Connect Contact Lens](#).

Step 5 (Optional): Review a sample segment stream

We recommend you review a [voice](#) or [chat](#) sample segment stream to familiarize yourself with what it looks like.

Data model for real-time contact analysis segment streams for voice contacts

Real-time contact analysis segment streams are generated in JSON. Event JSON blobs are published to the associated stream for every contact that has real-time contact analysis enabled. The following types of events can be published for a real-time contact analysis session for a voice contact:

- **STARTED** events—Each real-time contact analysis session publishes one **STARTED** event at the beginning of the session.
- **SEGMENTS** events—Each real-time contact analysis session may publish zero or more **SEGMENTS** events during the session. These events contain a list of segments with analyzed information. For voice contacts, the list of segments may include "Utterance", "Transcript", or "Categories" segments.
- **COMPLETED** or **FAILED** events—Each real-time contact analysis session publishes one **COMPLETED** or **FAILED** event at the end of the session.

Common properties included in all events for voice contacts

Every event includes the following properties:

Version

The version of the event schema.

Type: String

Channel

The type of channel for this contact.

Type: String

Valid values: VOICE, CHAT, TASK

For more information about channels, see [Concepts: Channels and concurrency](#).

AccountId

The identifier of the account where this contact takes place.

Type: String

ContactId

The identifier of the contact being analyzed.

Type: String

InstanceId

The identifier of the instance where this contact takes place.

Type: String

LanguageCode

The language code associated to this contact.

Type: String

Valid values: the language code for one of the [supported languages for Contact Lens real-time call analytics](#).

EventType

The type of event published.

Type: String

Valid values: STARTED, SEGMENTS, COMPLETED, FAILED

STARTED event

STARTED events include only the common properties:

- Version
- Channel
- AccountId
- ContactId
- LanguageCode
- EventType: STARTED

SEGMENTS event

SEGMENTS events include the following properties:

- Version
- Channel
- AccountId
- ContactId
- LanguageCode
- EventType: SEGMENTS
- Segments: In addition to the common properties, SEGMENTS events include a list of segments with analyzed information.

Type: Array of [Segment](#) objects

Segment

An analyzed segment for a real-time analysis session.

Each segment is an object with the following optional properties. Only one of these properties is present, depending on the segment type:

- Utterance
- Transcript
- Categories

Utterance

The analyzed utterance.

Required: No

- **Id**

The identifier of the utterance.

Type: String

- **TranscriptId**

The identifier of the transcript associated to this utterance.

Type: String

- **ParticipantId**

The identifier of the participant.

Type: String

- **ParticipantRole**

The role of participant. For example, is it a customer, agent, or system.

Type: String

- **PartialContent**

The content of the utterance.

Type: String

- **BeginOffsetMillis**

The beginning offset in the contact for this transcript.

Type: Integer

- **EndOffsetMillis**

The end offset in the contact for this transcript.

Type: Integer

Transcript

The analyzed transcript.

Type: [Transcript](#) object

Required: No

Categories

The matched category rules.

Type: [Categories](#) object

Required: No

COMPLETED event

COMPLETED events include only the following common properties:

- Version
- Channel
- AccountId
- ContactId
- LanguageCode
- EventType: STARTED

FAILED event

FAILED events include only the following common properties:

- Version
- Channel
- AccountId

- ContactId
- LanguageCode
- EventType: FAILED

Data model for real time contact analysis segment streams for chat contacts

Real-time contact analysis segment streams for chat contacts are generated in JSON. Event JSON blobs are published to the associated stream for every contact that has real-time contact analysis enabled. The following types of events can be published for a real-time contact analysis session for a chat contact:

- **STARTED** events—Each real-time contact analysis session publishes one **STARTED** event at the beginning of the session.
- **SEGMENTS** events—Each real-time contact analysis session may publish zero or more **SEGMENTS** events during the session. These events contain a list of segments with analyzed information. For chat contacts, the list of segments may include "Attachments," "Transcript," "Categories," "Events," or "Issues," segments.
- **COMPLETED** or **FAILED** events—Each real-time contact analysis session publishes one **COMPLETED** or **FAILED** event at the end of the session.

Common properties included in all events for chat contacts

Every event includes the following properties:

Version

The version of the event schema. For chat contacts, this is 2.0.0.

Type: String

Channel

The type of channel for this contact.

Type: String

Valid values: VOICE, CHAT, TASK

For more information about channels, see [Concepts: Channels and concurrency](#).

AccountId

The identifier of the account where this contact takes place.

Type: String

InstanceId

The identifier of the instance where this contact takes place.

Type: String

ContactId

The identifier of the contact being analyzed.

Type: String

StreamingEventType

The type of event published.

Type: String

Valid values: STARTED, SEGMENTS, COMPLETED, FAILED

StreamingSettings

The Contact Lens settings for this contact

Type: [StreamingSettings](#) object

StreamingSettings object**LanguageCode**

The language code associated to this contact.

Type: String

Valid values: the language code for one of the [supported languages for Contact Lens real-time call analytics](#).

Output

The Contact Lens output type enabled for this contact.

Type: String

Valid values: Raw, Redacted, RedactedAndRaw

RedactionTypes

The type of redaction enabled for this contact.

Type: Array of Strings

Valid values: PII

RedactionTypesMetadata

The redaction metadata for each redaction type.

Type: RedactionType string to [RedactionMetadata](#) object

Valid values: PII

RedactionMetadata object

Provides information on redaction settings.

RedactionMaskMode

The data redaction replacement setting

Type: String

Valid values: PII, EntityType

STARTED event

STARTED events include only the common properties:

- Version
- Channel
- AccountId
- ContactId
- StreamingEventType: STARTED

- StreamingSettings

SEGMENTS event

SEGMENTS events include the following properties:

- Version
- Channel
- AccountId
- OutputType
 - The Contact Lens output type of the current segment
 - Type: String
 - Valid values: Raw, Redacted
- ContactId
- StreamingEventType: SEGMENTS
- StreamingSettings
- Segments
 - A list of segments with analyzed information.
 - Type: Array of [Segment](#) objects

Segment

An analyzed segment for a real-time analysis session.

Each segment is an object with the following optional properties. Only one of these properties is present, depending on the segment type:

- [Attachments](#)
- [Categories](#)
- [Event](#)
- [Issues](#)
- [Transcript](#)

Attachments

The analyzed attachments.

Required: No

Type: [RealTimeContactAnalysisSegmentAttachments](#) object

Categories

The matched category rules.

Type: [RealTimeContactAnalysisSegmentCategories](#) object

Required: No

Event

Segment type describing a contact event.

Type: [RealTimeContactAnalysisSegmentEvent](#) object

Required: No

Issues

Segment type containing a list of detected issues.

Type: [RealTimeContactAnalysisSegmentIssues](#) object

Required: No

Transcript

The analyzed transcript segment.

Type: [RealTimeContactAnalysisSegmentTranscript](#) object

Required: No

COMPLETED event

COMPLETED events include only the following common properties:

- Version
- Channel
- AccountId
- InstanceId

- ContactId
- StreamingEventType: COMPLETED
- StreamingSettings

FAILED event

FAILED events include only the following common properties:

- Version
- Channel
- AccountId
- InstanceId
- ContactId
- StreamingEventType: FAILED
- StreamingSettings

Voice: Sample real-time contact analysis segment stream

This topic provides sample segment streams for STARTED, SEGMENTS, COMPLETED, and FAILED events that can occur during a voice contact.

Sample STARTED event

- EventType: STARTED
- Published at the beginning of the real-time contact analysis session.

```
{
  "Version": "1.0.0",
  "Channel": "VOICE",
  "AccountId": "123456789012", // your AWS account ID
  "InstanceId": "a1b2c3d4-5678-90ab-cdef-EXAMPLE11111", // your Amazon Connect
instance ID
  "ContactId": "a1b2c3d4-5678-90ab-cdef-EXAMPLE22222", // the ID of the contact
  "LanguageCode": "en-US", // the language code of the contact
  "EventType": "STARTED"
}
```

Sample SEGMENTS event

- EventType: SEGMENTS
- Published during a real-time contact analysis session. This event contains a list of segments with analyzed information. The list of segments may include "Utterance," "Transcript," or "Categories" segments.

```
{
  "Version": "1.0.0",
  "Channel": "VOICE",
  "AccountId": "123456789012", // your AWS account ID
  "InstanceId": "a1b2c3d4-5678-90ab-cdef-EXAMPLE11111", // your Amazon Connect
instance ID
  "ContactId": "a1b2c3d4-5678-90ab-cdef-EXAMPLE22222", // the ID of the contact
  "LanguageCode": "en-US", // the language code of the contact
  "EventType": "SEGMENTS",
  "Segments": [
    {
      "Utterance": {
        "Id": "7b48ca3d-73d3-443a-bf34-a9e8fcc01747",
        "TranscriptId": "121d1581-905f-4169-9804-b841bb4df04a",
        "ParticipantId": "AGENT",
        "ParticipantRole": "AGENT",
        "PartialContent": "Hello, thank you for calling Example Corp. My name
is Adam.",
        "BeginOffsetMillis": 19010,
        "EndOffsetMillis": 22980
      }
    },
    {
      "Utterance": {
        "Id": "75acb743-2154-486b-aaeb-c960ae290e88",
        "TranscriptId": "121d1581-905f-4169-9804-b841bb4df04a",
        "ParticipantId": "AGENT",
        "ParticipantRole": "AGENT",
        "PartialContent": "How can I help you?",
        "BeginOffsetMillis": 23000,
        "EndOffsetMillis": 24598
      }
    },
    {
      "Transcript": {
```

```

        "Id": "121d1581-905f-4169-9804-b841bb4df04a",
        "ParticipantId": "AGENT",
        "ParticipantRole": "AGENT",
        "Content": "Hello, thank you for calling Example Corp. My name is Adam.
How can I help you?",
        "BeginOffsetMillis": 19010,
        "EndOffsetMillis": 24598,
        "Sentiment": "NEUTRAL"
    }
},
{
    "Transcript": {
        "Id": "4295e927-43aa-4447-bbfc-8fccc2027530",
        "ParticipantId": "CUSTOMER",
        "ParticipantRole": "CUSTOMER",
        "Content": "I'm having trouble submitting the application, number
AX876293 on the portal. I tried but couldn't connect to my POC on the portal. So, I'm
calling on this toll free number",
        "BeginOffsetMillis": 19010,
        "EndOffsetMillis": 22690,
        "Sentiment": "NEGATIVE",
        "IssuesDetected": [
            {
                "CharacterOffsets": {
                    "BeginOffsetChar": 0,
                    "EndOffsetChar": 81
                }
            }
        ]
    }
},
{
    "Categories": {
        "MatchedCategories": [
            "CreditCardRelated",
            "CardBrokenIssue"
        ],
        "MatchedDetails": {
            "CreditCardRelated": {
                "PointsOfInterest": [
                    {
                        "BeginOffsetMillis": 19010,
                        "EndOffsetMillis": 22690
                    }
                ]
            }
        }
    }
}

```

```

    ],
    },
    "CardBrokenIssue": {
      "PointsOfInterest": [
        {
          "BeginOffsetMillis": 25000,
          "EndOffsetMillis": 29690
        }
      ]
    }
  }
}

```

Sample COMPLETED event

- EventType: COMPLETED
- Published at the end of the real-time contact analysis session if the analysis completed successfully.

```

{
  "Version": "1.0.0",
  "Channel": "VOICE",
  "AccountId": "123456789012", // your AWS account ID
  "InstanceId": "a1b2c3d4-5678-90ab-cdef-EXAMPLE11111", // your Amazon Connect
instance ID
  "ContactId": "a1b2c3d4-5678-90ab-cdef-EXAMPLE22222", // the ID of the contact
  "LanguageCode": "en-US", // the language code of the contact
  "EventType": "COMPLETED"
}

```

Sample FAILED event

- EventType: FAILED
- Published at the end of the real-time contact analysis session if the analysis failed.

```

{
  "Version": "1.0.0",

```



```
"Channel": "VOICE",
"AccountId": "123456789012", // your AWS account ID
"InstanceId": "a1b2c3d4-5678-90ab-cdef-EXAMPLE11111", // your Amazon Connect
instance ID
"ContactId": "a1b2c3d4-5678-90ab-cdef-EXAMPLE22222", // the ID of the contact
"LanguageCode": "en-US", // the language code of the contact
"EventType": "FAILED"
}
```

Chat: Sample real-time contact analysis segment stream

This topic provides sample segment streams for STARTED, SEGMENTS, COMPLETED, and FAILED events that occur during a chat contact.

Sample STARTED event

- EventType: STARTED
- Published at the beginning of the real-time contact analysis session.

```
{
  "Version": "2.0.0",
  "Channel": "CHAT",
  "AccountId": "123456789012", // your AWS account ID
  "InstanceId": "a1b2c3d4-5678-90ab-cdef-EXAMPLE11111", // your Amazon Connect
instance ID
  "ContactId": "a1b2c3d4-5678-90ab-cdef-EXAMPLE22222", // the ID of the contact
  "StreamingEventType": "STARTED",
  "StreamingSettings": {
    "LanguageCode": "en-US", // the language code of the contact
    "Output": "RedactedAndRaw",
    "RedactionTypes": [
      "PII"
    ],
    "RedactionTypesMetadata": {
      "PII": {
        "RedactionMaskMode": "PII"
      }
    }
  }
}
```

Sample SEGMENTS event

- EventType: [SEGMENTS](#)
- Published during a real time contact analysis session. This event contains a list of [RealtimeContactAnalysisSegment](#) objects with analyzed information. The list of segments may include "Transcript", "Categories", "Issue", "Event" or "Attachment" segments.

```
{
  "Version": "2.0.0",
  "Channel": "CHAT",
  "AccountId": "123456789012", // your AWS account ID
  "InstanceId": "a1b2c3d4-5678-90ab-cdef-EXAMPLE11111", // your Amazon Connect
instance ID
  "ContactId": "a1b2c3d4-5678-90ab-cdef-EXAMPLE22222", // the ID of the contact
  "OutputType": "Redacted",
  "StreamingEventType": "SEGMENTS",
  "StreamingSettings": {
    "LanguageCode": "en-US", // the language code of the contact
    "Output": "RedactedAndRaw",
    "RedactionTypes": [
      "PII"
    ],
    "RedactionTypesMetadata": {
      "PII": {
        "RedactionMaskMode": "PII"
      }
    }
  },
  "Segments": [{
    "Transcript": {
      "Id": "07a2d668-5c9e-4f69-b2fe-986261b0743a",
      "ParticipantId": "a309ac1e-ca87-44ca-bb5d-197eca8ed77a",
      "ParticipantRole": "AGENT",
      "DisplayName": "[PII]",
      "Content": "Hello, thank you for contacting Amazon. My name is Ray.",
      "ContentType": "text/markdown",
      "Time": {
        "AbsoluteTime": "2024-03-14T19:39:26.715Z"
      },
      "Sentiment": "NEUTRAL"
    }
  ], {
```

```

    "Categories": {
      "MatchedDetails": {
        "Hi": {
          "PointsOfInterest": [{
            "TranscriptItems": [{
              "Id": "5205b050-8aa9-4645-a381-a308801649ab",
              "CharacterOffsets": {
                "BeginOffsetChar": 0,
                "EndOffsetChar": 40
              }
            }
          ]
        }
      ]
    }
  }, {
    "Issues": {
      "IssuesDetected": [{
        "TranscriptItems": [{
          "Content": "I have an issue with my bank account",
          "Id": "0e5574a7-2aeb-4eab-8bb5-3a7f66a2284a",
          "CharacterOffsets": {
            "BeginOffsetChar": 7,
            "EndOffsetChar": 43
          }
        }
      ]
    }
  }, {
    "Attachments": {
      "Id": "06ddc1eb-2302-4a8e-a73f-37687fe41aa9",
      "ParticipantId": "7810b1de-cca8-4153-b522-2498416255af",
      "ParticipantRole": "CUSTOMER",
      "DisplayName": "Customer",
      "Attachments": [{
        "AttachmentName": "Lily.jpg",
        "ContentType": "image/jpeg",
        "AttachmentId": "343e34da-391a-4541-8b7e-3909d931fcfa",
        "Status": "APPROVED"
      }],
      "Time": {
        "AbsoluteTime": "2024-03-14T19:39:26.715Z"
      }
    }
  }
}

```

```

    }, {
      "Event": {
        "Id": "fbe61c5f-d0d8-4345-912a-4e81f5734d3b",
        "ParticipantId": "7810b1de-cca8-4153-b522-2498416255af",
        "ParticipantRole": "CUSTOMER",
        "DisplayName": "Customer",
        "EventType": "application/vnd.amazonaws.connect.event.participant.left",
        "Time": {
          "AbsoluteTime": "2024-03-14T19:40:00.614Z"
        }
      }
    }
  ]
}

```

Sample COMPLETED event

- EventType: COMPLETED
- Published at the end of the real-time contact analysis session if the analysis completed successfully.

```

{
  "Version": "2.0.0",
  "Channel": "CHAT",
  "AccountId": "123456789012", // your AWS account ID
  "InstanceId": "a1b2c3d4-5678-90ab-cdef-EXAMPLE11111", // your Amazon Connect
instance ID
  "ContactId": "a1b2c3d4-5678-90ab-cdef-EXAMPLE22222", // the ID of the contact
  "StreamingEventType": "COMPLETED",
  "StreamingEventSettings": {
    "LanguageCode": "en-US", // the language code of the contact
    "Output": "RedactedAndRaw",
    "RedactionTypes": ["PII"],
    "RedactionTypesMetadata": {
      "PII": {
        "RedactionMaskMode": "PII"
      }
    }
  }
}

```

Sample FAILED event

- EventType: FAILED
- Published at the end of the real-time contact analysis session if the analysis failed.

```
{
  "Version": "2.0.0",
  "Channel": "CHAT",
  "AccountId": "123456789012", // your AWS account ID
  "InstanceId": "a1b2c3d4-5678-90ab-cdef-EXAMPLE11111", // your Amazon Connect
instance ID
  "ContactId": "a1b2c3d4-5678-90ab-cdef-EXAMPLE22222", // the ID of the contact
  "StreamingEventType": "FAILED",
  "StreamingEventSettings": {
    "LanguageCode": "en-US",
    "Output": "RedactedAndRaw",
    "RedactionTypes": ["PII"],
    "RedactionTypesMetadata": {
      "PII": {
        "RedactionMaskMode": "PII"
      }
    }
  }
}
```

Output file locations for files analyzed by Contact Lens

Following are examples of what the path looks like for Contact Lens output files when they are stored in the Amazon S3 bucket for your instance.

- Original analyzed transcript file (JSON)
 - /connect-instance- bucket/**Analysis/Voice**/2020/02/04/*contact's_ID*_analysis_2020-02-04T21:14:16Z.json
 - /connect-instance- bucket/**Analysis/Chat**/2020/02/04/*contact's_ID*_analysis_2020-02-04T21:14:16Z.json
- Redacted analyzed transcript file in (JSON)
 - /connect-instance- bucket/**Analysis/Voice/Redacted**/2020/02/04/*contact's_ID*_analysis_redacted_2020-02-04T21:14:16Z.json

- /connect-instance- bucket/**Analysis/Chat/**
Redacted/2020/02/04/contact's_ID_analysis_redacted_2020-02-04T21:14:16Z.json
- Redacted audio file
- /connect-instance- bucket/**Analysis/Voice/**
Redacted/2020/02/04/contact's_ID_call_recording_redacted_2020-02-04T21:14:16Z.wav

Important

To delete a recording, you must delete the files for both the redacted and unredacted recordings.

Example Contact Lens output files for a call

The following sections provide examples of the output that results when Contact Lens detects issues, matches categories, indicates loudness, and redacts sensitive data.

Expand each section to learn more.

Example original, analyzed file for a call

The following example shows the schema for a call that Contact Lens has analyzed. The example shows loudness, issue detection, call drivers, and the information that will be redacted.

Note the following about the analyzed file:

- It doesn't indicate which sensitive data were redacted. All data are referred to as PII (personally identifiable information).
- Each turn includes a `Redaction` section only if it includes PII.
- If a `Redaction` section exists, it includes the offset in milliseconds. In a `.wav` file, the redacted portion will be silence. If desired, you can use the offset to replace the silence with something else, such as a beep.
- If two or more PII redactions exist in a turn, the first offset applies to the first PII, the second offset applies to the second PII, and so on.

```
{  
  "Version": "1.1.0",
```

```
"AccountId": "your AWS account ID",
"Channel": "VOICE",
"ContentMetadata": {
  "Output": "Raw"
},
"JobStatus": "COMPLETED",
"LanguageCode": "en-US",
"Participants": [
  {
    "ParticipantId": "e9b36a6d-12aa-4c21-9745-1881648ecfc8",
    "ParticipantRole": "CUSTOMER"
  },
  {
    "ParticipantId": "f36a545d-67b2-4fd4-89fb-896136b609a7",
    "ParticipantRole": "AGENT"
  }
],
"Categories": {
  "MatchedCategories": ["Cancellation"],
  "MatchedDetails": {
    "Cancellation": {
      "PointsOfInterest": [
        {
          "BeginOffsetMillis": 7370,
          "EndOffsetMillis": 11190
        }
      ]
    }
  }
},
"ConversationCharacteristics": {
  "ContactSummary": {
    "PostContactSummary": {
      "Content": "The customer and agent's conversation did not have any clear issues, outcomes or next steps. Agent verified customer information and finished the call."
    }
  },
  "TotalConversationDurationMillis": 32110,
  "Sentiment": {
    "OverallSentiment": {
      "AGENT": 0,
      "CUSTOMER": 3.1
    }
  }
}
```

```
  },
  "SentimentByPeriod": {
    "QUARTER": {
      "AGENT": [
        {
          "BeginOffsetMillis": 0,
          "EndOffsetMillis": 7427,
          "Score": 0
        },
        {
          "BeginOffsetMillis": 7427,
          "EndOffsetMillis": 14855,
          "Score": -5
        },
        {
          "BeginOffsetMillis": 14855,
          "EndOffsetMillis": 22282,
          "Score": 0
        },
        {
          "BeginOffsetMillis": 22282,
          "EndOffsetMillis": 29710,
          "Score": 5
        }
      ]
    },
    "CUSTOMER": [
      {
          "BeginOffsetMillis": 0,
          "EndOffsetMillis": 8027,
          "Score": -2.5
        },
        {
          "BeginOffsetMillis": 8027,
          "EndOffsetMillis": 16055,
          "Score": 5
        },
        {
          "BeginOffsetMillis": 16055,
          "EndOffsetMillis": 24082,
          "Score": 5
        },
        {
          "BeginOffsetMillis": 24082,
          "EndOffsetMillis": 32110,
```



```
        "Score": 5
      }
    ]
  }
},
"Interruptions": {
  "InterruptionsByInterrupter": {
    "CUSTOMER": [
      {
        "BeginOffsetMillis": 10710,
        "DurationMillis": 3790,
        "EndOffsetMillis": 14500
      }
    ],
    "AGENT": [
      {
        "BeginOffsetMillis": 10710,
        "DurationMillis": 3790,
        "EndOffsetMillis": 14500
      }
    ]
  },
  "TotalCount": 2,
  "TotalTimeMillis": 7580
},
"NonTalkTime": {
  "TotalTimeMillis": 0,
  "Instances": []
},
"TalkSpeed": {
  "DetailsByParticipant": {
    "AGENT": {
      "AverageWordsPerMinute": 239
    },
    "CUSTOMER": {
      "AverageWordsPerMinute": 163
    }
  }
},
"TalkTime": {
  "TotalTimeMillis": 28698,
  "DetailsByParticipant": {
    "AGENT": {
```

```

        "TotalTimeMillis": 15079
      },
      "CUSTOMER": {
        "TotalTimeMillis": 13619
      }
    }
  },
  "CustomModels": [
    { // set via https://docs.aws.amazon.com/connect/latest/adminguide/add-
      custom-vocabulary.html
      "Type": "TRANSCRIPTION_VOCABULARY",
      "Name": "ProductNames",
      "Id": "4e14b0db-f00a-451a-8847-f6dbf76ae415" // optional field
    }
  ],
  "Transcript": [
    {
      "BeginOffsetMillis": 0,
      "Content": "Okay.",
      "EndOffsetMillis": 90,
      "Id": "the ID of the turn",
      "ParticipantId": "AGENT",
      "Sentiment": "NEUTRAL",
      "LoudnessScore": [
        79.27
      ]
    },
    {
      "BeginOffsetMillis": 160,
      "Content": "Just hello. My name is Peter and help.",
      "EndOffsetMillis": 4640,
      "Id": "the ID of the turn",
      "ParticipantId": "CUSTOMER",
      "Sentiment": "NEUTRAL",
      "LoudnessScore": [
        66.56,
        40.06,
        85.27,
        82.22,
        77.66
      ],
      "Redaction": {
        "RedactedTimestamps": [

```

```
        {
            "BeginOffsetMillis": 3290,
            "EndOffsetMillis": 3620
        }
    ]
},
{
    "BeginOffsetMillis": 4640,
    "Content": "Hello. Peter, how can I help you?",
    "EndOffsetMillis": 6610,
    "Id": "the ID of the turn",
    "ParticipantId": "AGENT",
    "Sentiment": "NEUTRAL",
    "LoudnessScore": [
        70.23,
        73.05,
        71.8
    ],
    "Redaction": {
        "RedactedTimestamps": [
            {
                "BeginOffsetMillis": 5100,
                "EndOffsetMillis": 5450
            }
        ]
    }
},
{
    "BeginOffsetMillis": 7370,
    "Content": "I need to cancel. I want to cancel my plan subscription.",
    "EndOffsetMillis": 11190,
    "Id": "the ID of the turn",
    "ParticipantId": "CUSTOMER",
    "Sentiment": "NEGATIVE",
    "LoudnessScore": [
        77.18,
        79.59,
        85.23,
        81.08,
        73.99
    ],
    "IssuesDetected": [
        {
```

```
        "CharacterOffsets": {
            "BeginOffsetChar": 0,
            "EndOffsetChar": 55
        },
        "Text": "I need to cancel. I want to cancel my plan subscription"
    }
]
},
{
    "BeginOffsetMillis": 11220,
    "Content": "That sounds very bad. I can offer a 20% discount to make you
stay with us.",
    "EndOffsetMillis": 15210,
    "Id": "the ID of the turn",
    "ParticipantId": "AGENT",
    "Sentiment": "NEGATIVE",
    "LoudnessScore": [
        75.92,
        75.79,
        80.31,
        80.44,
        76.31
    ]
},
{
    "BeginOffsetMillis": 15840,
    "Content": "That sounds interesting. Thank you accept.",
    "EndOffsetMillis": 18120,
    "Id": "the ID of the turn",
    "ParticipantId": "CUSTOMER",
    "Sentiment": "POSITIVE",
    "LoudnessScore": [
        73.77,
        79.17,
        77.97,
        79.29
    ]
},
{
    "BeginOffsetMillis": 18310,
    "Content": "Alright, I made all the changes to the account and now these
discounts applied.",
    "EndOffsetMillis": 21820,
    "Id": "the ID of the turn",
```

```
"ParticipantId": "AGENT",
"Sentiment": "NEUTRAL",
"LoudnessScore": [
  83.88,
  86.75,
  86.97,
  86.11
],
"OutcomesDetected": [
  {
    "CharacterOffsets": {
      "BeginOffsetChar": 9,
      "EndOffsetChar": 77
    },
    "Text": "I made all the changes to the account and now these
discounts applied"
  }
],
{
  "BeginOffsetMillis": 22610,
  "Content": "Awesome. Thank you so much.",
  "EndOffsetMillis": 24140,
  "Id": "the ID of the turn",
  "ParticipantId": "CUSTOMER",
  "Sentiment": "POSITIVE",
  "LoudnessScore": [
    79.11,
    81.7,
    78.15
  ]
},
{
  "BeginOffsetMillis": 24120,
  "Content": "No worries. I will send you all the details later today and
call you back next week to check up on you.",
  "EndOffsetMillis": 29710,
  "Id": "the ID of the turn",
  "ParticipantId": "AGENT",
  "Sentiment": "POSITIVE",
  "LoudnessScore": [
    87.07,
    83.96,
    76.38,
```

```

        88.38,
        87.69,
        76.6
    ],
    "ActionItemsDetected": [
        {
            "CharacterOffsets": {
                "BeginOffsetChar": 12,
                "EndOffsetChar": 102
            },
            "Text": "I will send you all the details later today and call you
back next week to check up on you"
        }
    ],
    {
        "BeginOffsetMillis": 30580,
        "Content": "Thank you. Sir. Have a nice evening.",
        "EndOffsetMillis": 32110,
        "Id": "the ID of the turn",
        "ParticipantId": "CUSTOMER",
        "Sentiment": "POSITIVE",
        "LoudnessScore": [
            81.42,
            82.29,
            73.29
        ]
    }
]
}
}
}

```

Example redacted file for a call

This section shows an example redacted file for a call. It's a twin of the original analyzed file. The only difference is that sensitive data are redacted. In this example, three entities were selected for redaction: "CREDIT_DEBIT_NUMBER", "NAME", "USERNAME".

In this example, `RedactionMaskMode` is set to PII. When an entity is redacted, Contact Lens replaces it with [PII]. If it were set to `ENTITY_TYPE`, Contact Lens would replace the data with the name of the entity, for example, [CREDIT_DEBIT_NUMBER].

```
{
```

```
"Version": "1.1.0",
"AccountId": "your AWS account ID",
"ContentMetadata": {
  "Output": "Redacted",
  "RedactionTypes": ["PII"],
  "RedactionTypesMetadata": {
    "PII": {
      "RedactionEntitiesRequested": ["CREDIT_DEBIT_NUMBER", "NAME",
"USERNAME"],
      "RedactionMaskMode": "PII" // if you were to choose ENTITY_TYPE
instead, the redaction would say, for example, [NAME]
    }
  }
},
"Channel": "VOICE",
"JobStatus": "COMPLETED",
"LanguageCode": "en-US",
"Participants": [
  {
    "ParticipantId": "e9b36a6d-12aa-4c21-9745-1881648ecfc8",
    "ParticipantRole": "CUSTOMER"
  },
  {
    "ParticipantId": "f36a545d-67b2-4fd4-89fb-896136b609a7",
    "ParticipantRole": "AGENT"
  }
],
"Categories": {
  "MatchedCategories": ["Cancellation"],
  "MatchedDetails": {
    "Cancellation": {
      "PointsOfInterest": [
        {
          "BeginOffsetMillis": 7370,
          "EndOffsetMillis": 11190
        }
      ]
    }
  }
},
"ConversationCharacteristics": {
  "ContactSummary": {
    "PostContactSummary": {
```

```
        "Content": "The customer and agent's conversation did not have any
clear issues, outcomes or next steps. Agent verified customer information and finished
the call."
    }
},
"TotalConversationDurationMillis": 32110,
"Sentiment": {
    "OverallSentiment": {
        "AGENT": 0,
        "CUSTOMER": 3.1
    },
    "SentimentByPeriod": {
        "QUARTER": [
            "AGENT": [
                {
                    "BeginOffsetMillis": 0,
                    "EndOffsetMillis": 7427,
                    "Score": 0
                },
                {
                    "BeginOffsetMillis": 7427,
                    "EndOffsetMillis": 14855,
                    "Score": -5
                },
                {
                    "BeginOffsetMillis": 14855,
                    "EndOffsetMillis": 22282,
                    "Score": 0
                },
                {
                    "BeginOffsetMillis": 22282,
                    "EndOffsetMillis": 29710,
                    "Score": 5
                }
            ],
            "CUSTOMER": [
                {
                    "BeginOffsetMillis": 0,
                    "EndOffsetMillis": 8027,
                    "Score": -2.5
                },
                {
                    "BeginOffsetMillis": 8027,
                    "EndOffsetMillis": 16055,
```



```

        "Score": 5
      },
      {
        "BeginOffsetMillis": 16055,
        "EndOffsetMillis": 24082,
        "Score": 5
      },
      {
        "BeginOffsetMillis": 24082,
        "EndOffsetMillis": 32110,
        "Score": 5
      }
    ]
  }
},
"Interruptions": {
  "InterruptionsByInterrupter": {
    "CUSTOMER": [
      {
        "BeginOffsetMillis": 10710,
        "DurationMillis": 3790,
        "EndOffsetMillis": 14500
      }
    ],
    "AGENT": [
      {
        "BeginOffsetMillis": 10710,
        "DurationMillis": 3790,
        "EndOffsetMillis": 14500
      }
    ]
  },
  "TotalCount": 2,
  "TotalTimeMillis": 7580
},
"NonTalkTime": {
  "TotalTimeMillis": 0,
  "Instances": []
},
"TalkSpeed": {
  "DetailsByParticipant": {
    "AGENT": {
      "AverageWordsPerMinute": 239
    }
  }
}

```

```

    },
    "CUSTOMER": {
      "AverageWordsPerMinute": 163
    }
  },
  "TalkTime": {
    "TotalTimeMillis": 28698,
    "DetailsByParticipant": {
      "AGENT": {
        "TotalTimeMillis": 15079
      },
      "CUSTOMER": {
        "TotalTimeMillis": 13619
      }
    }
  }
},
"CustomModels": [
  { // set via https://docs.aws.amazon.com/connect/latest/adminguide/add-
    custom-vocabulary.html
    "Type": "TRANSCRIPTION_VOCABULARY",
    "Name": "ProductNames",
    "Id": "4e14b0db-f00a-451a-8847-f6dbf76ae415" // optional field
  }
],
"Transcript": [
  {
    "BeginOffsetMillis": 0,
    "Content": "Okay.",
    "EndOffsetMillis": 90,
    "Id": "the ID of the turn",
    "ParticipantId": "AGENT",
    "Sentiment": "NEUTRAL",
    "LoudnessScore": [
      79.27
    ]
  },
  {
    "BeginOffsetMillis": 160,
    "Content": "Just hello. My name is [PII] and help.",
    "EndOffsetMillis": 4640,
    "Id": "the ID of the turn",
    "ParticipantId": "CUSTOMER",
  }
]

```

```

    "Sentiment": "NEUTRAL",
    "LoudnessScore": [
      66.56,
      40.06,
      85.27,
      82.22,
      77.66
    ],
    "Redaction": {
      "RedactedTimestamps": [
        {
          "BeginOffsetMillis": 3290,
          "EndOffsetMillis": 3620
        }
      ]
    }
  },
  {
    "BeginOffsetMillis": 4640,
    "Content": "Hello. [PII], how can I help you?",
    "EndOffsetMillis": 6610,
    "Id": "the ID of the turn",
    "ParticipantId": "AGENT",
    "Sentiment": "NEUTRAL",
    "LoudnessScore": [
      70.23,
      73.05,
      71.8
    ],
    "Redaction": {
      "RedactedTimestamps": [
        {
          "BeginOffsetMillis": 5100,
          "EndOffsetMillis": 5450
        }
      ]
    }
  },
  {
    "BeginOffsetMillis": 7370,
    "Content": "I need to cancel. I want to cancel my plan subscription.",
    "EndOffsetMillis": 11190,
    "Id": "the ID of the turn",
    "ParticipantId": "CUSTOMER",

```

```
"Sentiment": "NEGATIVE",
"LoudnessScore": [
  77.18,
  79.59,
  85.23,
  81.08,
  73.99
],
"IssuesDetected": [
  {
    "CharacterOffsets": {
      "BeginOffsetChar": 0,
      "EndOffsetChar": 55
    },
    "Text": "I need to cancel. I want to cancel my plan subscription"
  }
]
},
{
  "BeginOffsetMillis": 11220,
  "Content": "That sounds very bad. I can offer a 20% discount to make you
stay with us.",
  "EndOffsetMillis": 15210,
  "Id": "the ID of the turn",
  "ParticipantId": "AGENT",
  "Sentiment": "NEGATIVE",
  "LoudnessScore": [
    75.92,
    75.79,
    80.31,
    80.44,
    76.31
  ]
},
{
  "BeginOffsetMillis": 15840,
  "Content": "That sounds interesting. Thank you accept.",
  "EndOffsetMillis": 18120,
  "Id": "the ID of the turn",
  "ParticipantId": "CUSTOMER",
  "Sentiment": "POSITIVE",
  "LoudnessScore": [
    73.77,
    79.17,
```

```

        77.97,
        79.29
    ]
},
{
    "BeginOffsetMillis": 18310,
    "Content": "Alright, I made all the changes to the account and now these
discounts applied.",
    "EndOffsetMillis": 21820,
    "Id": "the ID of the turn",
    "ParticipantId": "AGENT",
    "Sentiment": "NEUTRAL",
    "LoudnessScore": [
        83.88,
        86.75,
        86.97,
        86.11
    ],
    "OutcomesDetected": [
        {
            "CharacterOffsets": {
                "BeginOffsetChar": 9,
                "EndOffsetChar": 77
            },
            "Text": "I made all the changes to the account and now these
discounts applied"
        }
    ]
},
{
    "BeginOffsetMillis": 22610,
    "Content": "Awesome. Thank you so much.",
    "EndOffsetMillis": 24140,
    "Id": "the ID of the turn",
    "ParticipantId": "CUSTOMER",
    "Sentiment": "POSITIVE",
    "LoudnessScore": [
        79.11,
        81.7,
        78.15
    ]
},
{
    "BeginOffsetMillis": 24120,

```

```

    "Content": "No worries. I will send you all the details later today and
call you back next week to check up on you.",
    "EndOffsetMillis": 29710,
    "Id": "the ID of the turn",
    "ParticipantId": "AGENT",
    "Sentiment": "POSITIVE",
    "LoudnessScore": [
        87.07,
        83.96,
        76.38,
        88.38,
        87.69,
        76.6
    ],
    "ActionItemsDetected": [
        {
            "CharacterOffsets": {
                "BeginOffsetChar": 12,
                "EndOffsetChar": 102
            },
            "Text": "I will send you all the details later today and call you
back next week to check up on you"
        }
    ]
},
{
    "BeginOffsetMillis": 30580,
    "Content": "Thank you. Sir. Have a nice evening.",
    "EndOffsetMillis": 32110,
    "Id": "the ID of the turn",
    "ParticipantId": "CUSTOMER",
    "Sentiment": "POSITIVE",
    "LoudnessScore": [
        81.42,
        82.29,
        73.29
    ]
}
]
}

```

Example Contact Lens output files for a chat

This section shows an example schema for a chat conversation that Contact Lens has analyzed. The example shows inferred sentiment, matched categories, contact summary, and response time.

The original, analyzed file contains the full chat transcript. The same content that is present in the chat **Transcript** field on the **Contact details** page is present in `Transcript` field in the original Contact Lens analysis file. In addition, the analyzed file may contain more fields, such as a `Redaction` section to indicate that there is redacted data in the redacted analysis file.

Note

Some `ConversationCharacteristics` include `DetailsByParticipantRole` maps, with participant roles as keys. However, not all roles from the `Participants` list (such as `CUSTOMER` or `AGENT`) are guaranteed to have corresponding keys in the `DetailsByParticipantRole` objects. The presence of a key for a participant depends on whether there was eligible data for ContactLens analysis.

Categories

`PointsOfInterest` differs between post-chat and post-call categories:

- Post-call `PointsOfInterest` has milliseconds offset.
- Post-chat `PointsOfInterest` has an array of `TranscriptItems`; each item has an `id` and `CharacterOffset`.

There is an array of `PointsOfInterest`. Each array has an array of `TranscriptItems`: each `PointOfInterest` is for a `Category` match, but each match can span across multiple transcript items.

For both calls and chats, the `PointsOfInterest` array can be empty. This means that the category is matched for the whole contact. For example, if you create a rule to match the category when `Hello` is not mentioned in the contact, there would be no portion of the transcript to pinpoint for this condition.

Note

Currently, category is inferred for `text/plain`, `text/markdown` chat messages only.

Key highlights

Key highlights are located in the `ConversationCharacteristics.ContactSummary.SummaryItemsDetected` array. No more than one item can be in that array, emphasizing that only one set of `Issue`, `Outcome`, and `Action` item can be found.

Each object in the array has following fields: `IssuesDetected`, `OutcomesDetected`, `ActionItemsDetected`.

Each of the fields has an array of `TranscriptItems` that has `Id` and `CharacterOffsets`. They describe `TranscriptItems` and specific parts that were identified to contain that contact summary: `issue`, `outcome`, or `action` item.

Note

Currently, key highlights are inferred for `text/plain` chat messages only.

Sentiment

Overall sentiment

The `DetailsByParticipantRole` field sentiment score for contact participants is similar to the Contact Lens for speech analytics file.

`DetailsByInteraction` field has `CUSTOMER` sentiment score for parts of chat interaction `WithAgent` and `WithoutAgent`. If there were no customer messages in those parts of interaction, the respective field will be absent.

Note

Currently, sentiment is inferred is for `text/plain`, `text/markdown` chat messages only.

Sentiment shift

The `DetailsByParticipantRole` field contains an object that describes the sentiment shift for contact participants (that is, AGENT, CUSTOMER): `BeginScore` and `EndScore`.

The `DetailsByInteraction` field has CUSTOMER sentiment shift for parts of the chat interaction `WithAgent` and `WithoutAgent`. If there were no customer messages in those parts of the interaction, the respective field will be absent.

Sentiment shift provides information about how the participant's sentiment changed throughout the chat interaction.

Response time

`AgentGreetingTimeMillis` measures the time between when the AGENT joined the chat and the moment when they ended their first message to customer.

`DetailsByParticipantRole` has following characteristics for each of participant:

- **Average:** What is average response time for a participant.
- **Maximum:** What is the longest response time for a participant. If there are multiple transcript items with the same maximum response time, which ones are they.

To calculate the `Average` and `Maximum` response times for a given participant, they need to respond to a message from another participant (AGENT needs to responds to the CUSTOMER, or vice versa).

For example, if there was only one message from CUSTOMER and then only one message from AGENT before the chat ended, Contact Lens will calculate a response time for the AGENT, but not for the CUSTOMER.

Note

Currently, response time is inferred is for `text/plain`, `text/markdown` chat messages only.

Redaction

Note the following about the original analysis file for chats:

- Transcript item includes a Redaction section only if there is data to be redacted. The section contains character offsets for the data that is redacted in the redacted analysis file.
- If two or more pieces of a message are redacted, the first offset applies to the first redacted piece, the second offset applies to the second redacted piece, and so on.

DisplayNames for AGENT and CUSTOMER are redacted because they contain PII. This applies to AttachmentName, too.

CharacterOffsets take into consideration redaction changes of the Content length in the redacted analysis file. CharacterOffsets describe redacted content, not original content.

Example original chat file

```
{
  "AccountId": "123456789012",
  "Categories": {
    "MatchedCategories": [
      "agent-intro"
    ],
    "MatchedDetails": {
      "agent-intro": {
        "PointsOfInterest": [
          {
            "TranscriptItems": [
              {
                "CharacterOffsets": {
                  "BeginOffsetChar": 0,
                  "EndOffsetChar": 73
                },
                "Id": "e4949dd1-aaa1-4fbd-84e7-65c95b2d3d9a"
              }
            ]
          }
        ]
      }
    }
  },
  "Channel": "CHAT",
  "ChatTranscriptVersion": "2019-08-26",
  "ContentMetadata": {
    "Output": "Raw"
  },
}
```

```
"ConversationCharacteristics": {
  "ContactSummary": {
    "PostContactSummary": {
      "Content": "The customer and agent's conversation did not have any clear
issues, outcomes or next steps. Agent verified customer information and finished the
call."
    }
  },
  "SummaryItemsDetected": [
    {
      "ActionItemsDetected": [],
      "IssuesDetected": [
        {
          "TranscriptItems": [
            {
              "CharacterOffsets": {
                "BeginOffsetChar": 72,
                "EndOffsetChar": 244
              },
              "Id": "2b8ba020-53ee-4053-b5b7-35364ac1c7df"
            }
          ]
        }
      ]
    }
  ],
  "OutcomesDetected": [
    {
      "TranscriptItems": [
        {
          "CharacterOffsets": {
            "BeginOffsetChar": 0,
            "EndOffsetChar": 150
          },
          "Id": "72cc8c8d-2199-422a-b363-01d6d3fdc851"
        }
      ]
    }
  ]
},

"ResponseTime": {
  "AgentGreetingTimeMillis": 2511,
  "DetailsByParticipantRole": {
    "AGENT": {
```

```
    "Average": {
      "ValueMillis": 5575
    },
    "Maximum": {
      "TranscriptItems": [
        {
          "Id": "21acf0fc-7259-4a08-b4cd-688eb56587d3"
        }
      ],
      "ValueMillis": 7309
    }
  },
  "CUSTOMER": {
    "Average": {
      "ValueMillis": 5875
    },
    "Maximum": {
      "TranscriptItems": [
        {
          "Id": "c71ad383-f876-4bb3-b254-7837b6a3d395"
        }
      ],
      "ValueMillis": 11366
    }
  }
},
"Sentiment": {
  "DetailsByTranscriptItemGroup": [
    {
      "ParticipantRole": "AGENT",
      "ProgressiveScore": 0,
      "Sentiment": "NEUTRAL",
      "TranscriptItems": [
        {
          "Id": "e4949dd1-aaa1-4fbd-84e7-65c95b2d3d9a"
        }
      ]
    },
    {
      "ParticipantRole": "AGENT",
      "ProgressiveScore": 0,
      "Sentiment": "NEUTRAL",
      "TranscriptItems": [
```

```
        {
            "Id": "3673d926-6e75-4620-a6f0-7ea571790a15"
        }
    ],
},
{
    "ParticipantRole": "AGENT",
    "ProgressiveScore": 0,
    "Sentiment": "NEUTRAL",
    "TranscriptItems": [
        {
            "Id": "46d37141-32d8-4f2e-a664-bcd3f34a68b3"
        }
    ]
},
{
    "ParticipantRole": "AGENT",
    "ProgressiveScore": 0,
    "Sentiment": "NEUTRAL",
    "TranscriptItems": [
        {
            "Id": "3c4a2a1e-6790-46a6-8ad4-4a0980b04795"
        }
    ]
},
{
    "ParticipantRole": "AGENT",
    "ProgressiveScore": 0,
    "Sentiment": "NEUTRAL",
    "TranscriptItems": [
        {
            "Id": "f9cd41b6-3f68-4e83-a47d-664395f324c0"
        }
    ]
},
{
    "ParticipantRole": "AGENT",
    "ProgressiveScore": 1.6666666666666667,
    "Sentiment": "POSITIVE",
    "TranscriptItems": [
        {
            "Id": "21acf0fc-7259-4a08-b4cd-688eb56587d3"
        }
    ]
}
```

```
  },
  {
    "ParticipantRole": "AGENT",
    "ProgressiveScore": 1.6666666666666667,
    "Sentiment": "NEUTRAL",
    "TranscriptItems": [
      {
        "Id": "2b8ba020-53ee-4053-b5b7-35364ac1c7df"
      }
    ]
  },
  {
    "ParticipantRole": "AGENT",
    "ProgressiveScore": 1.6666666666666667,
    "Sentiment": "NEUTRAL",
    "TranscriptItems": [
      {
        "Id": "28d0a1ce-64d1-4625-bbef-4cfeb97b6742"
      }
    ]
  },
  {
    "ParticipantRole": "AGENT",
    "ProgressiveScore": 0,
    "Sentiment": "NEUTRAL",
    "TranscriptItems": [
      {
        "Id": "ef9b8622-32d5-4cfd-9ccc-a242502267bc"
      },
      {
        "Id": "03a9de67-f9e1-4884-a1a3-ecea78a4ce9e"
      },
      {
        "Id": "cfee5ece-a671-4a11-9ec2-89aba4b7d688"
      }
    ]
  },
  {
    "ParticipantRole": "AGENT",
    "ProgressiveScore": 0,
    "Sentiment": "NEUTRAL",
    "TranscriptItems": [
      {
        "Id": "72cc8c8d-2199-422a-b363-01d6d3fdc851"
      }
    ]
  }
}
```

```
    }
  ]
},
{
  "ParticipantRole": "AGENT",
  "ProgressiveScore": 1.6666666666666667,
  "Sentiment": "POSITIVE",
  "TranscriptItems": [
    {
      "Id": "61bb2591-fe87-44e4-bba0-a3619c4cef1f"
    }
  ]
},
{
  "ParticipantRole": "AGENT",
  "ProgressiveScore": 1.6666666666666667,
  "Sentiment": "NEUTRAL",
  "TranscriptItems": [
    {
      "Id": "1761f27e-0989-4b6d-a046-fc03d2c6bc9c"
    }
  ]
},
{
  "ParticipantRole": "AGENT",
  "ProgressiveScore": 3.3333333333333335,
  "Sentiment": "POSITIVE",
  "TranscriptItems": [
    {
      "Id": "8cdf161-dc25-44e6-986f-fc0e08ee0a7d"
    }
  ]
},
{
  "ParticipantRole": "CUSTOMER",
  "ProgressiveScore": -1.6666666666666667,
  "Sentiment": "NEGATIVE",
  "TranscriptItems": [
    {
      "Id": "bcc51949-3a79-4398-be1b-a27345a8a8ad"
    }
  ]
},
{
```

```
    "ParticipantRole": "CUSTOMER",
    "ProgressiveScore": -3.75,
    "Sentiment": "NEGATIVE",
    "TranscriptItems": [
      {
        "Id": "7d5c07d7-3d26-4b34-ae91-39aeaeef685c"
      },
      {
        "Id": "e0efbd17-9139-439b-8c80-ebf2b9b703b9"
      }
    ]
  },
  {
    "ParticipantRole": "CUSTOMER",
    "ProgressiveScore": -3.75,
    "Sentiment": "NEUTRAL",
    "TranscriptItems": [
      {
        "Id": "8fbb8dd4-9fd4-4991-83dc-5f06eeead9aa"
      }
    ]
  },
  {
    "ParticipantRole": "CUSTOMER",
    "ProgressiveScore": -2.5,
    "Sentiment": "NEUTRAL",
    "TranscriptItems": [
      {
        "Id": "3b856fd9-0eeb-4fb2-93ed-95ec4aeae3a6"
      }
    ]
  },
  {
    "ParticipantRole": "CUSTOMER",
    "ProgressiveScore": 0,
    "Sentiment": "NEUTRAL",
    "TranscriptItems": [
      {
        "Id": "ecb8c498-96d7-448b-8360-366eeddb4090"
      }
    ]
  },
  {
    "ParticipantRole": "CUSTOMER",
```



```
    "ProgressiveScore": 0,
    "Sentiment": "NEUTRAL",
    "TranscriptItems": [
      {
        "Id": "d334058f-e3de-4cf1-a361-32e4e61f1839"
      }
    ]
  },
  {
    "ParticipantRole": "CUSTOMER",
    "ProgressiveScore": 0,
    "Sentiment": "NEUTRAL",
    "TranscriptItems": [
      {
        "Id": "3ec6adb5-3f11-409c-af39-40cf7ba6f078"
      }
    ]
  },
  {
    "ParticipantRole": "CUSTOMER",
    "ProgressiveScore": 0,
    "Sentiment": "NEUTRAL",
    "TranscriptItems": [
      {
        "Id": "c71ad383-f876-4bb3-b254-7837b6a3d395"
      }
    ]
  },
  {
    "ParticipantRole": "CUSTOMER",
    "ProgressiveScore": 0,
    "Sentiment": "NEUTRAL",
    "TranscriptItems": [
      {
        "Id": "4b292b64-4a33-45ff-89df-d5a175d16d70"
      }
    ]
  },
  {
    "ParticipantRole": "CUSTOMER",
    "ProgressiveScore": 0,
    "Sentiment": "NEUTRAL",
    "TranscriptItems": [
      {
```

```
        "Id": "2da5a3c2-9d1b-458c-ae53-759a4e63198d"
      }
    ]
  },
  {
    "ParticipantRole": "CUSTOMER",
    "ProgressiveScore": 1.6666666666666667,
    "Sentiment": "POSITIVE",
    "TranscriptItems": [
      {
        "Id": "e23a2331-f3fc-4d3c-8a51-1541451186c9"
      }
    ]
  },
  {
    "ParticipantRole": "CUSTOMER",
    "ProgressiveScore": 3.75,
    "Sentiment": "POSITIVE",
    "TranscriptItems": [
      {
        "Id": "5a27cc39-9b73-4ebe-9275-5e6723788a1b"
      }
    ]
  },
  {
    "ParticipantRole": "CUSTOMER",
    "ProgressiveScore": 3.75,
    "Sentiment": "NEUTRAL",
    "TranscriptItems": [
      {
        "Id": "540368c7-ec19-4fc0-8c86-0a5ee62d31a0"
      }
    ]
  }
],
"OverallSentiment": {
  "DetailsByInteraction": {
    "DetailsByParticipantRole": {
      "CUSTOMER": {
        "WithAgent": 0
      }
    }
  }
},
"DetailsByParticipantRole": {
```

```

        "AGENT": 1.1538461538461537,
        "CUSTOMER": 0
    }
},
"SentimentShift": {
    "DetailsByInteraction": {
        "DetailsByParticipantRole": {
            "CUSTOMER": {
                "WithAgent": {
                    "BeginScore": -3,
                    "EndScore": 3.75
                }
            }
        }
    },
    "DetailsByParticipantRole": {
        "AGENT": {
            "BeginScore": 0,
            "EndScore": 2.5
        },
        "CUSTOMER": {
            "BeginScore": -3.75,
            "EndScore": 3.75
        },
        "SYSTEM": {
            "BeginScore": 2.5,
            "EndScore": 0
        }
    }
}
},
"CustomerMetadata": {
    "ContactId": "b49644f6-672f-445c-b209-f76b36482830",
    "InputS3Uri": "path to the json file in s3",
    "InstanceId": "f23fc323-3d6d-48aa-95dc-EXAMPLE012"
},
"JobStatus": "COMPLETED",
"LanguageCode": "en-US",
"Participants": [
    {
        "ParticipantId": "e9b36a6d-12aa-4c21-9745-1881648ecfc8",
        "ParticipantRole": "CUSTOMER"
    }
],

```

```

    {
      "ParticipantId": "2b2288b4-ff6e-4996-8d8e-260fd5a8ac02",
      "ParticipantRole": "SYSTEM"
    },
    {
      "ParticipantId": "f36a545d-67b2-4fd4-89fb-896136b609a7",
      "ParticipantRole": "AGENT"
    }
  ],
  "Transcript": [
    {
      "AbsoluteTime": "2022-10-27T03:31:50.735Z",
      "ContentType": "application/
vnd.amazonaws.connect.event.participant.joined",
      "DisplayName": "John",
      "Id": "740c494d-9df7-4400-91c0-3e4df33922c8",
      "ParticipantId": "e9b36a6d-12aa-4c21-9745-1881648ecfc8",
      "ParticipantRole": "CUSTOMER",
      "Type": "EVENT"
    },
    {
      "AbsoluteTime": "2022-10-27T03:31:53.390Z",
      "Content": "Hello, thanks for contacting us. This is an example of what the
Amazon Connect virtual contact center can enable you to do.",
      "ContentType": "text/plain",
      "DisplayName": "SYSTEM_MESSAGE",
      "Id": "78aa8229-714a-4c87-916b-ce7d8d567ab2",
      "ParticipantId": "2b2288b4-ff6e-4996-8d8e-260fd5a8ac02",
      "ParticipantRole": "SYSTEM",
      "Type": "MESSAGE"
    },
    {
      "AbsoluteTime": "2022-10-27T03:31:55.131Z",
      "Content": "The time in queue is less than 5 minutes.",
      "ContentType": "text/plain",
      "DisplayName": "SYSTEM_MESSAGE",
      "Id": "1276382b-facb-49c5-8d34-62e3b0f50002",
      "ParticipantId": "2b2288b4-ff6e-4996-8d8e-260fd5a8ac02",
      "ParticipantRole": "SYSTEM",
      "Type": "MESSAGE"
    },
    {
      "AbsoluteTime": "2022-10-27T03:31:56.618Z",
      "Content": "You are now being placed in queue to chat with an agent.",

```

```

      "ContentType": "text/plain",
      "DisplayName": "SYSTEM_MESSAGE",
      "Id": "88c2363e-8206-4781-a353-c15e1ccacc12",
      "ParticipantId": "2b2288b4-ff6e-4996-8d8e-260fd5a8ac02",
      "ParticipantRole": "SYSTEM",
      "Type": "MESSAGE"
    },
    {
      "AbsoluteTime": "2022-10-27T03:32:00.951Z",
      "ContentType": "application/
vnd.amazonaws.connect.event.participant.joined",
      "DisplayName": "Jane",
      "Id": "c05cca74-d50b-4aa5-b46c-fdb5ae8c814c",
      "ParticipantId": "f36a545d-67b2-4fd4-89fb-896136b609a7",
      "ParticipantRole": "AGENT",
      "Type": "EVENT"
    },
    {
      "AbsoluteTime": "2022-10-27T03:32:03.462Z",
      "Content": "Hello, thanks for reaching Example Corp. This is Jane. How may
I help you?",
      "ContentType": "text/markdown",
      "DisplayName": "Jane",
      "Id": "e4949dd1-aaa1-4fbd-84e7-65c95b2d3d9a",
      "ParticipantId": "f36a545d-67b2-4fd4-89fb-896136b609a7",
      "ParticipantRole": "AGENT",
      "Redaction": {
        "CharacterOffsets": [
          {
            "BeginOffsetChar": 46,
            "EndOffsetChar": 53
          }
        ]
      },
      "Type": "MESSAGE"
    },
    {
      "AbsoluteTime": "2022-10-27T03:32:08.102Z",
      "Content": "I'd like to see if I can get a refund or an exchange, because
I ordered one of your grow-it-yourself indoor herb garden kits and nothing sprouted
after a couple weeks so I think something is wrong with the seeds and this product may
be defective.",
      "ContentType": "text/markdown",
      "DisplayName": "John",

```

```
"Id": "bcc51949-3a79-4398-be1b-a27345a8a8ad",
"ParticipantId": "e9b36a6d-12aa-4c21-9745-1881648ecfc8",
"ParticipantRole": "CUSTOMER",
>Type": "MESSAGE"
},
{
  "AbsoluteTime": "2022-10-27T03:32:14.137Z",
  "Content": "My wife is blind and sensitive to the sun so I was going to
surprise her for her birthday with all the herbs that she loves so you guys actually
really let me down.",
  "ContentType": "text/markdown",
  "DisplayName": "John",
  "Id": "7d5c07d7-3d26-4b34-ae91-39aeaeef685c",
  "ParticipantId": "e9b36a6d-12aa-4c21-9745-1881648ecfc8",
  "ParticipantRole": "CUSTOMER",
>Type": "MESSAGE"
},
{
  "AbsoluteTime": "2022-10-27T03:32:18.781Z",
  "Content": "I should be taking my business elsewhere. I don't see why
I should be giving money to a company that isn't even going to sell a product that
works.",
  "ContentType": "text/markdown",
  "DisplayName": "John",
  "Id": "e0efbd17-9139-439b-8c80-ebf2b9b703b9",
  "ParticipantId": "e9b36a6d-12aa-4c21-9745-1881648ecfc8",
  "ParticipantRole": "CUSTOMER",
>Type": "MESSAGE"
},
{
  "AbsoluteTime": "2022-10-27T03:32:24.123Z",
  "Content": "Ok. Can I get your first and last name please?",
  "ContentType": "text/markdown",
  "DisplayName": "Jane",
  "Id": "3673d926-6e75-4620-a6f0-7ea571790a15",
  "ParticipantId": "f36a545d-67b2-4fd4-89fb-896136b609a7",
  "ParticipantRole": "AGENT",
>Type": "MESSAGE"
},
{
  "AbsoluteTime": "2022-10-27T03:32:29.879Z",
  "Content": "Yeah. My first name is John and last name is Doe.",
  "ContentType": "text/markdown",
  "DisplayName": "John",
```

```
"Id": "8fbb8dd4-9fd4-4991-83dc-5f06eeead9aa",
"ParticipantId": "e9b36a6d-12aa-4c21-9745-1881648ecfc8",
"ParticipantRole": "CUSTOMER",
"Redaction": {
  "CharacterOffsets": [
    {
      "BeginOffsetChar": 21,
      "EndOffsetChar": 26
    },
    {
      "BeginOffsetChar": 44,
      "EndOffsetChar": 49
    }
  ]
},
"Type": "MESSAGE"
},
{
  "AbsoluteTime": "2022-10-27T03:32:34.670Z",
  "Content": "Could you please provide me with the order ID number?",
  "ContentType": "text/markdown",
  "DisplayName": "Jane",
  "Id": "46d37141-32d8-4f2e-a664-bcd3f34a68b3",
  "ParticipantId": "f36a545d-67b2-4fd4-89fb-896136b609a7",
  "ParticipantRole": "AGENT",
  "Type": "MESSAGE"
},
{
  "AbsoluteTime": "2022-10-27T03:32:39.726Z",
  "Content": "Yes, just . Looking ...",
  "ContentType": "text/markdown",
  "DisplayName": "John",
  "Id": "3b856fd9-0eeb-4fb2-93ed-95ec4aeae3a6",
  "ParticipantId": "e9b36a6d-12aa-4c21-9745-1881648ecfc8",
  "ParticipantRole": "CUSTOMER",
  "Type": "MESSAGE"
},
{
  "AbsoluteTime": "2022-10-27T03:32:44.887Z",
  "Content": "Not a problem, take your time.",
  "ContentType": "text/markdown",
  "DisplayName": "Jane",
  "Id": "3c4a2a1e-6790-46a6-8ad4-4a0980b04795",
  "ParticipantId": "f36a545d-67b2-4fd4-89fb-896136b609a7",
```

```
    "ParticipantRole": "AGENT",
    "Type": "MESSAGE"
  },
  {
    "AbsoluteTime": "2022-10-27T03:32:52.978Z",
    "Content": "Okay, that should be #5376897. You know, if the product was
fine I wouldn't have to scrounge through emails.",
    "ContentType": "text/markdown",
    "DisplayName": "John",
    "Id": "ecb8c498-96d7-448b-8360-366eeddb4090",
    "ParticipantId": "e9b36a6d-12aa-4c21-9745-1881648ecfc8",
    "ParticipantRole": "CUSTOMER",
    "Type": "MESSAGE"
  },
  {
    "AbsoluteTime": "2022-10-27T03:32:59.441Z",
    "Content": "alright, perfect. And could you also just confirm the shipping
address for me?",
    "ContentType": "text/markdown",
    "DisplayName": "Jane",
    "Id": "f9cd41b6-3f68-4e83-a47d-664395f324c0",
    "ParticipantId": "f36a545d-67b2-4fd4-89fb-896136b609a7",
    "ParticipantRole": "AGENT",
    "Redaction": {
      "CharacterOffsets": [
        {
          "BeginOffsetChar": 77,
          "EndOffsetChar": 78
        }
      ]
    },
    "Type": "MESSAGE"
  },
  {
    "AbsoluteTime": "2022-10-27T03:33:05.455Z",
    "Content": "123 Any Street, Any Town, and the zip code is 98109.",
    "ContentType": "text/markdown",
    "DisplayName": "John",
    "Id": "d334058f-e3de-4cf1-a361-32e4e61f1839",
    "ParticipantId": "e9b36a6d-12aa-4c21-9745-1881648ecfc8",
    "ParticipantRole": "CUSTOMER",
    "Redaction": {
      "CharacterOffsets": [
        {
```



```

        "BeginOffsetChar": 0,
        "EndOffsetChar": 27
      },
      {
        "BeginOffsetChar": 49,
        "EndOffsetChar": 54
      }
    ]
  },
  "Type": "MESSAGE"
},
{
  "AbsoluteTime": "2022-10-27T03:33:12.764Z",
  "Content": "Thank you very much. Just waiting on my system here. .. I'll
also need the last four digits of your debit card.",
  "ContentType": "text/markdown",
  "DisplayName": "Jane",
  "Id": "21acf0fc-7259-4a08-b4cd-688eb56587d3",
  "ParticipantId": "f36a545d-67b2-4fd4-89fb-896136b609a7",
  "ParticipantRole": "AGENT",
  "Type": "MESSAGE"
},
{
  "AbsoluteTime": "2022-10-27T03:33:17.412Z",
  "Content": "Ok. Last four for my debit care are 9008",
  "ContentType": "text/markdown",
  "DisplayName": "John",
  "Id": "3ec6adb5-3f11-409c-af39-40cf7ba6f078",
  "ParticipantId": "e9b36a6d-12aa-4c21-9745-1881648ecfc8",
  "ParticipantRole": "CUSTOMER",
  "Redaction": {
    "CharacterOffsets": [
      {
        "BeginOffsetChar": 27,
        "EndOffsetChar": 31
      }
    ]
  },
  "Type": "MESSAGE"
},
{
  "AbsoluteTime": "2022-10-27T03:33:22.486Z",

```

```

      "Content": "It's just too bad. I thought this was going to be the best
gift idea. How can you guys be sending out defective seeds? Isn't that your whole
business?",
      "ContentType": "text/markdown",
      "DisplayName": "Jane",
      "Id": "2b8ba020-53ee-4053-b5b7-35364ac1c7df",
      "ParticipantId": "f36a545d-67b2-4fd4-89fb-896136b609a7",
      "ParticipantRole": "AGENT",
      "Type": "MESSAGE"
    },
    {
      "AbsoluteTime": "2022-10-27T03:33:38.961Z",
      "Content": "I apologize for the experience you had Mr. Doe, its very
uncommon that our customer will have this issue. We will look into this and get this
sorted out for you right away.",
      "ContentType": "text/markdown",
      "DisplayName": "Jane",
      "Id": "28d0a1ce-64d1-4625-bbef-4cf9b97b6742",
      "ParticipantId": "f36a545d-67b2-4fd4-89fb-896136b609a7",
      "ParticipantRole": "AGENT",
      "Redaction": {
        "CharacterOffsets": [
          {
            "BeginOffsetChar": 41,
            "EndOffsetChar": 46
          }
        ]
      },
      "Type": "MESSAGE"
    },
    {
      "AbsoluteTime": "2022-10-27T03:33:44.192Z",
      "Content": "Well, my wife's birthday already passed, so. There's not too
much you can do. But I would still like to grow the herbs for her, if possible.",
      "ContentType": "text/markdown",
      "DisplayName": "John",
      "Id": "4b292b64-4a33-45ff-89df-d5a175d16d70",
      "ParticipantId": "e9b36a6d-12aa-4c21-9745-1881648ecfc8",
      "ParticipantRole": "CUSTOMER",
      "Type": "MESSAGE"
    },
    {
      "AbsoluteTime": "2022-10-27T03:33:51.310Z",

```

```
    "Content": "Totally understandable. Let me see what we can do for you.
Please give me couple of minutes as I check the system.",
    "ContentType": "text/markdown",
    "DisplayName": "Jane",
    "Id": "ef9b8622-32d5-4cfd-9ccc-a242502267bc",
    "ParticipantId": "f36a545d-67b2-4fd4-89fb-896136b609a7",
    "ParticipantRole": "AGENT",
    "Type": "MESSAGE"
  },
  {
    "AbsoluteTime": "2022-10-27T03:33:56.287Z",
    "Content": "Thank you sir one moment please.",
    "ContentType": "text/markdown",
    "DisplayName": "Jane",
    "Id": "03a9de67-f9e1-4884-a1a3-ecea78a4ce9e",
    "ParticipantId": "f36a545d-67b2-4fd4-89fb-896136b609a7",
    "ParticipantRole": "AGENT",
    "Type": "MESSAGE"
  },
  {
    "AbsoluteTime": "2022-10-27T03:34:01.224Z",
    "Content": "Alright are you still there Mr Doe?",
    "ContentType": "text/markdown",
    "DisplayName": "Jane",
    "Id": "cfee5ece-a671-4a11-9ec2-89aba4b7d688",
    "ParticipantId": "f36a545d-67b2-4fd4-89fb-896136b609a7",
    "ParticipantRole": "AGENT",
    "Redaction": {
      "CharacterOffsets": [
        {
          "BeginOffsetChar": 30,
          "EndOffsetChar": 35
        }
      ]
    },
    "Type": "MESSAGE"
  },
  {
    "AbsoluteTime": "2022-10-27T03:34:07.093Z",
    "Content": "Yeah.",
    "ContentType": "text/markdown",
    "DisplayName": "John",
    "Id": "2da5a3c2-9d1b-458c-ae53-759a4e63198d",
    "ParticipantId": "e9b36a6d-12aa-4c21-9745-1881648ecfc8",
```

```
    "ParticipantRole": "CUSTOMER",
    "Type": "MESSAGE"
  },
  {
    "AbsoluteTime": "2022-10-27T03:34:12.562Z",
    "Content": "We are not only refunding the cost of the grow-it-yourself indoor herb kit but we will also be sending you a replacement. Would you be okay with this?",
    "ContentType": "text/markdown",
    "DisplayName": "Jane",
    "Id": "72cc8c8d-2199-422a-b363-01d6d3fdc851",
    "ParticipantId": "f36a545d-67b2-4fd4-89fb-896136b609a7",
    "ParticipantRole": "AGENT",
    "Type": "MESSAGE"
  },
  {
    "AbsoluteTime": "2022-10-27T03:34:17.029Z",
    "Content": "Yeah! That would be great. I just want my wife to be able to have these herbs in her room. And I'm always happy to get my money back!",
    "ContentType": "text/markdown",
    "DisplayName": "John",
    "Id": "e23a2331-f3fc-4d3c-8a51-1541451186c9",
    "ParticipantId": "e9b36a6d-12aa-4c21-9745-1881648ecfc8",
    "ParticipantRole": "CUSTOMER",
    "Type": "MESSAGE"
  },
  {
    "AbsoluteTime": "2022-10-27T03:34:22.269Z",
    "Content": "Awesome! We really want to keep our customers happy and satisfied, and again I want to apologize for your less than satisfactory experience with the last product you ordered from us.",
    "ContentType": "text/markdown",
    "DisplayName": "Jane",
    "Id": "61bb2591-fe87-44e4-bba0-a3619c4cef1f",
    "ParticipantId": "f36a545d-67b2-4fd4-89fb-896136b609a7",
    "ParticipantRole": "AGENT",
    "Type": "MESSAGE"
  },
  {
    "AbsoluteTime": "2022-10-27T03:34:26.353Z",
    "Content": "Okay! No problem. Sounds great. Thank you for all your help!",
    "ContentType": "text/markdown",
    "DisplayName": "John",
    "Id": "5a27cc39-9b73-4ebe-9275-5e6723788a1b",
```

```
"ParticipantId": "e9b36a6d-12aa-4c21-9745-1881648ecfc8",
"ParticipantRole": "CUSTOMER",
"Type": "MESSAGE"
},
{
  "AbsoluteTime": "2022-10-27T03:34:31.431Z",
  "Content": "Is there anything else I can help you out with John?",
  "ContentType": "text/markdown",
  "DisplayName": "Jane",
  "Id": "1761f27e-0989-4b6d-a046-fc03d2c6bc9c",
  "ParticipantId": "f36a545d-67b2-4fd4-89fb-896136b609a7",
  "ParticipantRole": "AGENT",
  "Redaction": {
    "CharacterOffsets": [
      {
        "BeginOffsetChar": 48,
        "EndOffsetChar": 53
      }
    ]
  },
  "Type": "MESSAGE"
},
{
  "AbsoluteTime": "2022-10-27T03:34:36.704Z",
  "Content": "Nope!",
  "ContentType": "text/markdown",
  "DisplayName": "John",
  "Id": "540368c7-ec19-4fc0-8c86-0a5ee62d31a0",
  "ParticipantId": "e9b36a6d-12aa-4c21-9745-1881648ecfc8",
  "ParticipantRole": "CUSTOMER",
  "Type": "MESSAGE"
},
{
  "AbsoluteTime": "2022-10-27T03:34:41.448Z",
  "Content": "Ok great! Have a great day.",
  "ContentType": "text/markdown",
  "DisplayName": "Jane",
  "Id": "8cdf161-dc25-44e6-986f-fc0e08ee0a7d",
  "ParticipantId": "f36a545d-67b2-4fd4-89fb-896136b609a7",
  "ParticipantRole": "AGENT",
  "Type": "MESSAGE"
},
{
  "AbsoluteTime": "2022-10-27T03:34:42.799Z",
```

```

    "ContentType": "application/vnd.amazonaws.connect.event.participant.left",
    "DisplayName": "John",
    "Id": "d1ba54ba-61d4-4a48-9a9a-6cd17d70b8fb",
    "ParticipantId": "e9b36a6d-12aa-4c21-9745-1881648ecfc8",
    "ParticipantRole": "CUSTOMER",
    "Type": "EVENT"
  },
  {
    "AbsoluteTime": "2022-10-27T03:34:43.192Z",
    "ContentType": "application/vnd.amazonaws.connect.event.chat.ended",
    "Id": "2d9a0e4f-faec-485f-97af-2767dde1f30a",
    "Type": "EVENT"
  }
],
"Version": "CHAT-2022-11-30"
}

```

Example redacted chat file

```

{
  "AccountId": "123456789012",
  "Categories": {
    "MatchedCategories": [
      "agent-intro"
    ],
    "MatchedDetails": {
      "agent-intro": {
        "PointsOfInterest": [
          {
            "TranscriptItems": [
              {
                "CharacterOffsets": {
                  "BeginOffsetChar": 0,
                  "EndOffsetChar": 71
                },
                "Id": "e4949dd1-aaa1-4fbd-84e7-65c95b2d3d9a"
              }
            ]
          }
        ]
      }
    }
  }
},

```

```
"Channel": "CHAT",
"ChatTranscriptVersion": "2019-08-26",
"ContentMetadata": {
  "Output": "Redacted",
  "RedactionTypes": [
    "PII"
  ],
  "RedactionTypesMetadata": {
    "PII": {
      "RedactionMaskMode": "PII"
    }
  }
},
"ConversationCharacteristics": {
  "ContactSummary": {
    "SummaryItemsDetected": [
      {
        "ActionItemsDetected": [],
        "IssuesDetected": [
          {
            "TranscriptItems": [
              {
                "CharacterOffsets": {
                  "BeginOffsetChar": 72,
                  "EndOffsetChar": 244
                },
                "Id": "2b8ba020-53ee-4053-b5b7-35364ac1c7df"
              }
            ]
          }
        ],
        "OutcomesDetected": [
          {
            "TranscriptItems": [
              {
                "CharacterOffsets": {
                  "BeginOffsetChar": 0,
                  "EndOffsetChar": 150
                },
                "Id": "72cc8c8d-2199-422a-b363-01d6d3fdc851"
              }
            ]
          }
        ]
      }
    ]
  }
}
```

```

    }
  ]
  "ContactSummary": {
    "PostContactSummary": {
      "Content": "The customer and agent's conversation did not
have any clear issues, outcomes or next steps. Agent verified customer information and
finished the call."
    }
  },
},

"ResponseTime": {
  "AgentGreetingTimeMillis": 2511,
  "DetailsByParticipantRole": {
    "AGENT": {
      "Average": {
        "ValueMillis": 5575
      },
      "Maximum": {
        "TranscriptItems": [
          {
            "Id": "21acfc0fc-7259-4a08-b4cd-688eb56587d3"
          }
        ],
        "ValueMillis": 7309
      }
    },
    "CUSTOMER": {
      "Average": {
        "ValueMillis": 5875
      },
      "Maximum": {
        "TranscriptItems": [
          {
            "Id": "c71ad383-f876-4bb3-b254-7837b6a3d395"
          }
        ],
        "ValueMillis": 11366
      }
    }
  }
},
"Sentiment": {

```



```
"DetailsByTranscriptItemGroup": [
  {
    "ParticipantRole": "AGENT",
    "ProgressiveScore": 0,
    "Sentiment": "NEUTRAL",
    "TranscriptItems": [
      {
        "Id": "e4949dd1-aaa1-4fbd-84e7-65c95b2d3d9a"
      }
    ]
  },
  {
    "ParticipantRole": "AGENT",
    "ProgressiveScore": 0,
    "Sentiment": "NEUTRAL",
    "TranscriptItems": [
      {
        "Id": "3673d926-6e75-4620-a6f0-7ea571790a15"
      }
    ]
  },
  {
    "ParticipantRole": "AGENT",
    "ProgressiveScore": 0,
    "Sentiment": "NEUTRAL",
    "TranscriptItems": [
      {
        "Id": "46d37141-32d8-4f2e-a664-bcd3f34a68b3"
      }
    ]
  },
  {
    "ParticipantRole": "AGENT",
    "ProgressiveScore": 0,
    "Sentiment": "NEUTRAL",
    "TranscriptItems": [
      {
        "Id": "3c4a2a1e-6790-46a6-8ad4-4a0980b04795"
      }
    ]
  },
  {
    "ParticipantRole": "AGENT",
    "ProgressiveScore": 0,
```

```
    "Sentiment": "NEUTRAL",
    "TranscriptItems": [
      {
        "Id": "f9cd41b6-3f68-4e83-a47d-664395f324c0"
      }
    ]
  },
  {
    "ParticipantRole": "AGENT",
    "ProgressiveScore": 1.6666666666666667,
    "Sentiment": "POSITIVE",
    "TranscriptItems": [
      {
        "Id": "21acf0fc-7259-4a08-b4cd-688eb56587d3"
      }
    ]
  },
  {
    "ParticipantRole": "AGENT",
    "ProgressiveScore": 1.6666666666666667,
    "Sentiment": "NEUTRAL",
    "TranscriptItems": [
      {
        "Id": "2b8ba020-53ee-4053-b5b7-35364ac1c7df"
      }
    ]
  },
  {
    "ParticipantRole": "AGENT",
    "ProgressiveScore": 1.6666666666666667,
    "Sentiment": "NEUTRAL",
    "TranscriptItems": [
      {
        "Id": "28d0a1ce-64d1-4625-bbef-4cfeb97b6742"
      }
    ]
  },
  {
    "ParticipantRole": "AGENT",
    "ProgressiveScore": 0,
    "Sentiment": "NEUTRAL",
    "TranscriptItems": [
      {
        "Id": "ef9b8622-32d5-4cfd-9ccc-a242502267bc"
      }
    ]
  }
}
```

```
    },
    {
      "Id": "03a9de67-f9e1-4884-a1a3-ecea78a4ce9e"
    },
    {
      "Id": "cfee5ece-a671-4a11-9ec2-89aba4b7d688"
    }
  ]
},
{
  "ParticipantRole": "AGENT",
  "ProgressiveScore": 0,
  "Sentiment": "NEUTRAL",
  "TranscriptItems": [
    {
      "Id": "72cc8c8d-2199-422a-b363-01d6d3fdc851"
    }
  ]
},
{
  "ParticipantRole": "AGENT",
  "ProgressiveScore": 1.6666666666666667,
  "Sentiment": "POSITIVE",
  "TranscriptItems": [
    {
      "Id": "61bb2591-fe87-44e4-bba0-a3619c4cef1f"
    }
  ]
},
{
  "ParticipantRole": "AGENT",
  "ProgressiveScore": 1.6666666666666667,
  "Sentiment": "NEUTRAL",
  "TranscriptItems": [
    {
      "Id": "1761f27e-0989-4b6d-a046-fc03d2c6bc9c"
    }
  ]
},
{
  "ParticipantRole": "AGENT",
  "ProgressiveScore": 3.3333333333333335,
  "Sentiment": "POSITIVE",
  "TranscriptItems": [
```

```
        {
            "Id": "8cdf161-dc25-44e6-986f-fc0e08ee0a7d"
        }
    ],
},
{
    "ParticipantRole": "CUSTOMER",
    "ProgressiveScore": -1.6666666666666667,
    "Sentiment": "NEGATIVE",
    "TranscriptItems": [
        {
            "Id": "bcc51949-3a79-4398-be1b-a27345a8a8ad"
        }
    ]
},
{
    "ParticipantRole": "CUSTOMER",
    "ProgressiveScore": -3.75,
    "Sentiment": "NEGATIVE",
    "TranscriptItems": [
        {
            "Id": "7d5c07d7-3d26-4b34-ae91-39aeaeef685c"
        },
        {
            "Id": "e0efbd17-9139-439b-8c80-ebf2b9b703b9"
        }
    ]
},
{
    "ParticipantRole": "CUSTOMER",
    "ProgressiveScore": -3.75,
    "Sentiment": "NEUTRAL",
    "TranscriptItems": [
        {
            "Id": "8fbb8dd4-9fd4-4991-83dc-5f06eeead9aa"
        }
    ]
},
{
    "ParticipantRole": "CUSTOMER",
    "ProgressiveScore": -2.5,
    "Sentiment": "NEUTRAL",
    "TranscriptItems": [
        {
```

```
        "Id": "3b856fd9-0eeb-4fb2-93ed-95ec4aeae3a6"
      }
    ]
  },
  {
    "ParticipantRole": "CUSTOMER",
    "ProgressiveScore": 0,
    "Sentiment": "NEUTRAL",
    "TranscriptItems": [
      {
        "Id": "ecb8c498-96d7-448b-8360-366eeddb4090"
      }
    ]
  },
  {
    "ParticipantRole": "CUSTOMER",
    "ProgressiveScore": 0,
    "Sentiment": "NEUTRAL",
    "TranscriptItems": [
      {
        "Id": "d334058f-e3de-4cf1-a361-32e4e61f1839"
      }
    ]
  },
  {
    "ParticipantRole": "CUSTOMER",
    "ProgressiveScore": 0,
    "Sentiment": "NEUTRAL",
    "TranscriptItems": [
      {
        "Id": "3ec6adb5-3f11-409c-af39-40cf7ba6f078"
      }
    ]
  },
  {
    "ParticipantRole": "CUSTOMER",
    "ProgressiveScore": 0,
    "Sentiment": "NEUTRAL",
    "TranscriptItems": [
      {
        "Id": "c71ad383-f876-4bb3-b254-7837b6a3d395"
      }
    ]
  },
},
```

```
{
  "ParticipantRole": "CUSTOMER",
  "ProgressiveScore": 0,
  "Sentiment": "NEUTRAL",
  "TranscriptItems": [
    {
      "Id": "4b292b64-4a33-45ff-89df-d5a175d16d70"
    }
  ]
},
{
  "ParticipantRole": "CUSTOMER",
  "ProgressiveScore": 0,
  "Sentiment": "NEUTRAL",
  "TranscriptItems": [
    {
      "Id": "2da5a3c2-9d1b-458c-ae53-759a4e63198d"
    }
  ]
},
{
  "ParticipantRole": "CUSTOMER",
  "ProgressiveScore": 1.6666666666666667,
  "Sentiment": "POSITIVE",
  "TranscriptItems": [
    {
      "Id": "e23a2331-f3fc-4d3c-8a51-1541451186c9"
    }
  ]
},
{
  "ParticipantRole": "CUSTOMER",
  "ProgressiveScore": 3.75,
  "Sentiment": "POSITIVE",
  "TranscriptItems": [
    {
      "Id": "5a27cc39-9b73-4ebe-9275-5e6723788a1b"
    }
  ]
},
{
  "ParticipantRole": "CUSTOMER",
  "ProgressiveScore": 3.75,
  "Sentiment": "NEUTRAL",
```

```
        "TranscriptItems": [
          {
            "Id": "540368c7-ec19-4fc0-8c86-0a5ee62d31a0"
          }
        ]
      },
    ],
    "OverallSentiment": {
      "DetailsByInteraction": {
        "DetailsByParticipantRole": {
          "CUSTOMER": {
            "WithAgent": 0
          }
        }
      },
      "DetailsByParticipantRole": {
        "AGENT": 1.1538461538461537,
        "CUSTOMER": 0
      }
    },
    "SentimentShift": {
      "DetailsByInteraction": {
        "DetailsByParticipantRole": {
          "CUSTOMER": {
            "WithAgent": {
              "BeginScore": -3,
              "EndScore": 3.75
            }
          }
        }
      },
      "DetailsByParticipantRole": {
        "AGENT": {
          "BeginScore": 0,
          "EndScore": 2.5
        },
        "CUSTOMER": {
          "BeginScore": -3.75,
          "EndScore": 3.75
        }
      }
    }
  },
},
```

```

"CustomerMetadata": {
  "ContactId": "b49644f6-672f-445c-b209-f76b36482830",
  "InputS3Uri": "path to the json file in s3",
  "InstanceId": "f23fc323-3d6d-48aa-EXAMPLE012"
},
"JobStatus": "COMPLETED",
"LanguageCode": "en-US",
"Participants": [
  {
    "ParticipantId": "e9b36a6d-12aa-4c21-9745-1881648ecfc8",
    "ParticipantRole": "CUSTOMER"
  },
  {
    "ParticipantId": "2b2288b4-ff6e-4996-8d8e-260fd5a8ac02",
    "ParticipantRole": "SYSTEM"
  },
  {
    "ParticipantId": "f36a545d-67b2-4fd4-89fb-896136b609a7",
    "ParticipantRole": "AGENT"
  }
],
"Transcript": [
  {
    "AbsoluteTime": "2022-10-27T03:31:50.735Z",
    "ContentType": "application/
vnd.amazonaws.connect.event.participant.joined",
    "DisplayName": "[PII]",
    "Id": "740c494d-9df7-4400-91c0-3e4df33922c8",
    "ParticipantId": "e9b36a6d-12aa-4c21-9745-1881648ecfc8",
    "ParticipantRole": "CUSTOMER",
    "Type": "EVENT"
  },
  {
    "AbsoluteTime": "2022-10-27T03:31:53.390Z",
    "Content": "Hello, thanks for contacting us. This is an example of what the
Amazon Connect virtual contact center can enable you to do.",
    "ContentType": "text/plain",
    "DisplayName": "SYSTEM_MESSAGE",
    "Id": "78aa8229-714a-4c87-916b-ce7d8d567ab2",
    "ParticipantId": "2b2288b4-ff6e-4996-8d8e-260fd5a8ac02",
    "ParticipantRole": "SYSTEM",
    "Type": "MESSAGE"
  },
  {

```



```

    "AbsoluteTime": "2022-10-27T03:31:55.131Z",
    "Content": "The time in queue is less than 5 minutes.",
    "ContentType": "text/plain",
    "DisplayName": "SYSTEM_MESSAGE",
    "Id": "1276382b-facb-49c5-8d34-62e3b0f50002",
    "ParticipantId": "2b2288b4-ff6e-4996-8d8e-260fd5a8ac02",
    "ParticipantRole": "SYSTEM",
    "Type": "MESSAGE"
  },
  {
    "AbsoluteTime": "2022-10-27T03:31:56.618Z",
    "Content": "You are now being placed in queue to chat with an agent.",
    "ContentType": "text/plain",
    "DisplayName": "SYSTEM_MESSAGE",
    "Id": "88c2363e-8206-4781-a353-c15e1ccacc12",
    "ParticipantId": "2b2288b4-ff6e-4996-8d8e-260fd5a8ac02",
    "ParticipantRole": "SYSTEM",
    "Type": "MESSAGE"
  },
  {
    "AbsoluteTime": "2022-10-27T03:32:00.951Z",
    "ContentType": "application/
vnd.amazonaws.connect.event.participant.joined",
    "DisplayName": "[PII]",
    "Id": "c05cca74-d50b-4aa5-b46c-fdb5ae8c814c",
    "ParticipantId": "f36a545d-67b2-4fd4-89fb-896136b609a7",
    "ParticipantRole": "AGENT",
    "Type": "EVENT"
  },
  {
    "AbsoluteTime": "2022-10-27T03:32:03.462Z",
    "Content": "Hello, thanks for reaching Example Corp. This is [PII]. How may
I help you?",
    "ContentType": "text/plain",
    "DisplayName": "[PII]",
    "Id": "e4949dd1-aaa1-4fbd-84e7-65c95b2d3d9a",
    "ParticipantId": "f36a545d-67b2-4fd4-89fb-896136b609a7",
    "ParticipantRole": "AGENT",
    "Redaction": {
      "CharacterOffsets": [
        {
          "BeginOffsetChar": 46,
          "EndOffsetChar": 51
        }
      ]
    }
  }

```

```
    ]
  },
  "Type": "MESSAGE"
},
{
  "AbsoluteTime": "2022-10-27T03:32:08.102Z",
  "Content": "I'd like to see if I can get a refund or an exchange, because
I ordered one of your grow-it-yourself indoor herb garden kits and nothing sprouted
after a couple weeks so I think something is wrong with the seeds and this product may
be defective.",
  "ContentType": "text/plain",
  "DisplayName": "[PII]",
  "Id": "bcc51949-3a79-4398-be1b-a27345a8a8ad",
  "ParticipantId": "e9b36a6d-12aa-4c21-9745-1881648ecfc8",
  "ParticipantRole": "CUSTOMER",
  "Type": "MESSAGE"
},
{
  "AbsoluteTime": "2022-10-27T03:32:14.137Z",
  "Content": "My wife is blind and sensitive to the sun so I was going to
surprise her for her birthday with all the herbs that she loves so you guys actually
really let me down.",
  "ContentType": "text/plain",
  "DisplayName": "[PII]",
  "Id": "7d5c07d7-3d26-4b34-ae91-39aeaeef685c",
  "ParticipantId": "e9b36a6d-12aa-4c21-9745-1881648ecfc8",
  "ParticipantRole": "CUSTOMER",
  "Type": "MESSAGE"
},
{
  "AbsoluteTime": "2022-10-27T03:32:18.781Z",
  "Content": "I should be taking my business elsewhere. I don't see why
I should be giving money to a company that isn't even going to sell a product that
works.",
  "ContentType": "text/plain",
  "DisplayName": "[PII]",
  "Id": "e0efbd17-9139-439b-8c80-ebf2b9b703b9",
  "ParticipantId": "e9b36a6d-12aa-4c21-9745-1881648ecfc8",
  "ParticipantRole": "CUSTOMER",
  "Type": "MESSAGE"
},
{
  "AbsoluteTime": "2022-10-27T03:32:24.123Z",
  "Content": "Ok. Can I get your first and last name please?",
```

```

    "ContentType": "text/plain",
    "DisplayName": "[PII]",
    "Id": "3673d926-6e75-4620-a6f0-7ea571790a15",
    "ParticipantId": "f36a545d-67b2-4fd4-89fb-896136b609a7",
    "ParticipantRole": "AGENT",
    "Type": "MESSAGE"
  },
  {
    "AbsoluteTime": "2022-10-27T03:32:29.879Z",
    "Content": "Yeah. My first name is [PII] and last name [PII].",
    "ContentType": "text/plain",
    "DisplayName": "[PII]",
    "Id": "8fbb8dd4-9fd4-4991-83dc-5f06eeead9aa",
    "ParticipantId": "e9b36a6d-12aa-4c21-9745-1881648ecfc8",
    "ParticipantRole": "CUSTOMER",
    "Redaction": {
      "CharacterOffsets": [
        {
          "BeginOffsetChar": 21,
          "EndOffsetChar": 26
        },
        {
          "BeginOffsetChar": 44,
          "EndOffsetChar": 49
        }
      ]
    },
    "Type": "MESSAGE"
  },
  {
    "AbsoluteTime": "2022-10-27T03:32:34.670Z",
    "Content": "Could you please provide me with the order ID number?",
    "ContentType": "text/plain",
    "DisplayName": "[PII]",
    "Id": "46d37141-32d8-4f2e-a664-bcd3f34a68b3",
    "ParticipantId": "f36a545d-67b2-4fd4-89fb-896136b609a7",
    "ParticipantRole": "AGENT",
    "Type": "MESSAGE"
  },
  {
    "AbsoluteTime": "2022-10-27T03:32:39.726Z",
    "Content": "Yes, just . Looking ...",
    "ContentType": "text/plain",
    "DisplayName": "[PII]",

```

```
"Id": "3b856fd9-0eeb-4fb2-93ed-95ec4aeae3a6",
"ParticipantId": "e9b36a6d-12aa-4c21-9745-1881648ecfc8",
"ParticipantRole": "CUSTOMER",
>Type": "MESSAGE"
},
{
  "AbsoluteTime": "2022-10-27T03:32:44.887Z",
  "Content": "Not a problem, take your time.",
  "ContentType": "text/plain",
  "DisplayName": "[PII]",
  "Id": "3c4a2a1e-6790-46a6-8ad4-4a0980b04795",
  "ParticipantId": "f36a545d-67b2-4fd4-89fb-896136b609a7",
  "ParticipantRole": "AGENT",
>Type": "MESSAGE"
},
{
  "AbsoluteTime": "2022-10-27T03:32:52.978Z",
  "Content": "Okay, that should be #5376897. You know, if the product was
fine I wouldn't have to scrounge through emails.",
  "ContentType": "text/plain",
  "DisplayName": "[PII]",
  "Id": "ecb8c498-96d7-448b-8360-366eeddb4090",
  "ParticipantId": "e9b36a6d-12aa-4c21-9745-1881648ecfc8",
  "ParticipantRole": "CUSTOMER",
>Type": "MESSAGE"
},
{
  "AbsoluteTime": "2022-10-27T03:32:59.441Z",
  "Content": "alright, perfect. And could you also just confirm the shipping
address for me, [PII]",
  "ContentType": "text/plain",
  "DisplayName": "[PII]",
  "Id": "f9cd41b6-3f68-4e83-a47d-664395f324c0",
  "ParticipantId": "f36a545d-67b2-4fd4-89fb-896136b609a7",
  "ParticipantRole": "AGENT",
  "Redaction": {
    "CharacterOffsets": [
      {
        "BeginOffsetChar": 77,
        "EndOffsetChar": 82
      }
    ]
  }
},
>Type": "MESSAGE"
```

```

    },
    {
      "AbsoluteTime": "2022-10-27T03:33:05.455Z",
      "Content": "[PII], and the zip code [PII].",
      "ContentType": "text/plain",
      "DisplayName": "[PII]",
      "Id": "d334058f-e3de-4cf1-a361-32e4e61f1839",
      "ParticipantId": "e9b36a6d-12aa-4c21-9745-1881648ecfc8",
      "ParticipantRole": "CUSTOMER",
      "Redaction": {
        "CharacterOffsets": [
          {
            "BeginOffsetChar": 0,
            "EndOffsetChar": 5
          },
          {
            "BeginOffsetChar": 27,
            "EndOffsetChar": 32
          }
        ]
      },
      "Type": "MESSAGE"
    },
    {
      "AbsoluteTime": "2022-10-27T03:33:12.764Z",
      "Content": "Thank you very much. Just waiting on my system here. .. I'll
also need the last four digits of your debit card.",
      "ContentType": "text/plain",
      "DisplayName": "[PII]",
      "Id": "21acf0fc-7259-4a08-b4cd-688eb56587d3",
      "ParticipantId": "f36a545d-67b2-4fd4-89fb-896136b609a7",
      "ParticipantRole": "AGENT",
      "Type": "MESSAGE"
    },
    {
      "AbsoluteTime": "2022-10-27T03:33:17.412Z",
      "Content": "Ok. Last four for my debit card [PII]",
      "ContentType": "text/plain",
      "DisplayName": "[PII]",
      "Id": "3ec6adb5-3f11-409c-af39-40cf7ba6f078",
      "ParticipantId": "e9b36a6d-12aa-4c21-9745-1881648ecfc8",
      "ParticipantRole": "CUSTOMER",
      "Redaction": {
        "CharacterOffsets": [

```

```

        {
            "BeginOffsetChar": 27,
            "EndOffsetChar": 32
        }
    ],
    "Type": "MESSAGE"
},
{
    "AbsoluteTime": "2022-10-27T03:33:33.852Z",
    "Content": "It's just too bad. I thought this was going to be the best
gift idea. How can you guys be sending out defective seeds? Isn't that your whole
business?",
    "ContentType": "text/plain",
    "DisplayName": "[PII]",
    "Id": "c71ad383-f876-4bb3-b254-7837b6a3d395",
    "ParticipantId": "e9b36a6d-12aa-4c21-9745-1881648ecfc8",
    "ParticipantRole": "CUSTOMER",
    "Type": "MESSAGE"
},
{
    "AbsoluteTime": "2022-10-27T03:33:38.961Z",
    "Content": "I apologize for the experience you had Mr [PII], its very
uncommon that our customer will have this issue. We will look into this and get this
sorted out for you right away.",
    "ContentType": "text/plain",
    "DisplayName": "[PII]",
    "Id": "28d0a1ce-64d1-4625-bbef-4cfef97b6742",
    "ParticipantId": "f36a545d-67b2-4fd4-89fb-896136b609a7",
    "ParticipantRole": "AGENT",
    "Redaction": {
        "CharacterOffsets": [
            {
                "BeginOffsetChar": 41,
                "EndOffsetChar": 46
            }
        ]
    },
    "Type": "MESSAGE"
},
{
    "AbsoluteTime": "2022-10-27T03:33:44.192Z",
    "Content": "Well, my wife's birthday already passed, so. There's not too
much you can do. But I would still like to grow the herbs for her, if possible.",

```

```

    "ContentType": "text/plain",
    "DisplayName": "[PII]",
    "Id": "4b292b64-4a33-45ff-89df-d5a175d16d70",
    "ParticipantId": "e9b36a6d-12aa-4c21-9745-1881648ecfc8",
    "ParticipantRole": "CUSTOMER",
    "Type": "MESSAGE"
  },
  {
    "AbsoluteTime": "2022-10-27T03:33:51.310Z",
    "Content": "Totally understandable. Let me see what we can do for you.
Please give me couple of minutes as I check the system.",
    "ContentType": "text/plain",
    "DisplayName": "[PII]",
    "Id": "ef9b8622-32d5-4cfd-9ccc-a242502267bc",
    "ParticipantId": "f36a545d-67b2-4fd4-89fb-896136b609a7",
    "ParticipantRole": "AGENT",
    "Type": "MESSAGE"
  },
  {
    "AbsoluteTime": "2022-10-27T03:33:56.287Z",
    "Content": "Thank you sir one moment please.",
    "ContentType": "text/plain",
    "DisplayName": "[PII]",
    "Id": "03a9de67-f9e1-4884-a1a3-ecea78a4ce9e",
    "ParticipantId": "f36a545d-67b2-4fd4-89fb-896136b609a7",
    "ParticipantRole": "AGENT",
    "Type": "MESSAGE"
  },
  {
    "AbsoluteTime": "2022-10-27T03:34:01.224Z",
    "Content": "Alright are you still there Mr [PII]?",
    "ContentType": "text/plain",
    "DisplayName": "[PII]",
    "Id": "cfee5ece-a671-4a11-9ec2-89aba4b7d688",
    "ParticipantId": "f36a545d-67b2-4fd4-89fb-896136b609a7",
    "ParticipantRole": "AGENT",
    "Redaction": {
      "CharacterOffsets": [
        {
          "BeginOffsetChar": 30,
          "EndOffsetChar": 35
        }
      ]
    }
  },

```

```
    "Type": "MESSAGE"
  },
  {
    "AbsoluteTime": "2022-10-27T03:34:07.093Z",
    "Content": "Yeah.",
    "ContentType": "text/plain",
    "DisplayName": "[PII]",
    "Id": "2da5a3c2-9d1b-458c-ae53-759a4e63198d",
    "ParticipantId": "e9b36a6d-12aa-4c21-9745-1881648ecfc8",
    "ParticipantRole": "CUSTOMER",
    "Type": "MESSAGE"
  },
  {
    "AbsoluteTime": "2022-10-27T03:34:12.562Z",
    "Content": "We are not only refunding the cost of the grow-it-yourself indoor herb kit but we will also be sending you a replacement. Would you be okay with this?",
    "ContentType": "text/plain",
    "DisplayName": "[PII]",
    "Id": "72cc8c8d-2199-422a-b363-01d6d3fdc851",
    "ParticipantId": "f36a545d-67b2-4fd4-89fb-896136b609a7",
    "ParticipantRole": "AGENT",
    "Type": "MESSAGE"
  },
  {
    "AbsoluteTime": "2022-10-27T03:34:17.029Z",
    "Content": "Yeah! That would be great. I just want my wife to be able to have these herbs in her room. And I'm always happy to get my money back!",
    "ContentType": "text/plain",
    "DisplayName": "[PII]",
    "Id": "e23a2331-f3fc-4d3c-8a51-1541451186c9",
    "ParticipantId": "e9b36a6d-12aa-4c21-9745-1881648ecfc8",
    "ParticipantRole": "CUSTOMER",
    "Type": "MESSAGE"
  },
  {
    "AbsoluteTime": "2022-10-27T03:34:22.269Z",
    "Content": "Awesome! We really want to keep our customers happy and satisfied, and again I want to apologize for your less than satisfactory experience with the last product you ordered from us.",
    "ContentType": "text/plain",
    "DisplayName": "[PII]",
    "Id": "61bb2591-fe87-44e4-bba0-a3619c4cef1f",
    "ParticipantId": "f36a545d-67b2-4fd4-89fb-896136b609a7",
```



```
"ParticipantRole": "AGENT",
  "Type": "MESSAGE"
},
{
  "AbsoluteTime": "2022-10-27T03:34:26.353Z",
  "Content": "Okay! No problem. Sounds great. Thank you for all your help!",
  "ContentType": "text/plain",
  "DisplayName": "[PII]",
  "Id": "5a27cc39-9b73-4ebe-9275-5e6723788a1b",
  "ParticipantId": "e9b36a6d-12aa-4c21-9745-1881648ecfc8",
  "ParticipantRole": "CUSTOMER",
  "Type": "MESSAGE"
},
{
  "AbsoluteTime": "2022-10-27T03:34:31.431Z",
  "Content": "Is there anything else I can help you out with Mr [PII]?",
  "ContentType": "text/plain",
  "DisplayName": "[PII]",
  "Id": "1761f27e-0989-4b6d-a046-fc03d2c6bc9c",
  "ParticipantId": "f36a545d-67b2-4fd4-89fb-896136b609a7",
  "ParticipantRole": "AGENT",
  "Redaction": {
    "CharacterOffsets": [
      {
        "BeginOffsetChar": 48,
        "EndOffsetChar": 53
      }
    ]
  },
  "Type": "MESSAGE"
},
{
  "AbsoluteTime": "2022-10-27T03:34:36.704Z",
  "Content": "Nope!",
  "ContentType": "text/plain",
  "DisplayName": "[PII]",
  "Id": "540368c7-ec19-4fc0-8c86-0a5ee62d31a0",
  "ParticipantId": "e9b36a6d-12aa-4c21-9745-1881648ecfc8",
  "ParticipantRole": "CUSTOMER",
  "Type": "MESSAGE"
},
{
  "AbsoluteTime": "2022-10-27T03:34:41.448Z",
  "Content": "Ok great! Have a great day.",
```

```
    "ContentType": "text/plain",
    "DisplayName": "[PII]",
    "Id": "8cdff161-dc25-44e6-986f-fc0e08ee0a7d",
    "ParticipantId": "f36a545d-67b2-4fd4-89fb-896136b609a7",
    "ParticipantRole": "AGENT",
    "Type": "MESSAGE"
  },
  {
    "AbsoluteTime": "2022-10-27T03:34:42.799Z",
    "ContentType": "application/vnd.amazonaws.connect.event.participant.left",
    "DisplayName": "[PII]",
    "Id": "d1ba54ba-61d4-4a48-9a9a-6cd17d70b8fb",
    "ParticipantId": "e9b36a6d-12aa-4c21-9745-1881648ecfc8",
    "ParticipantRole": "CUSTOMER",
    "Type": "EVENT"
  },
  {
    "AbsoluteTime": "2022-10-27T03:34:43.192Z",
    "ContentType": "application/vnd.amazonaws.connect.event.chat.ended",
    "Id": "2d9a0e4f-faec-485f-97af-2767dde1f30a",
    "Type": "EVENT"
  }
],
"Version": "CHAT-2022-11-30"
}
```

Troubleshoot issues in Contact Lens

Why don't I see color-coded bars on my Amazon Connect admin website?

If your Amazon Connect admin website doesn't include color-coded bars similar to those shown in the preceding image, check whether the conversation that you're trying to analyzed occurred before June 30, 2020.

This view of conversations works only if the Contact Lens is enabled, and then the conversation occurred after June 30, 2020. This is because the feature that displays analyzed conversations in this format was released on June 30, 2020, and it can only be applied to conversations that happen after that time.

Why don't I see or hear unredacted content?

If your organization is using the Contact Lens redaction feature, by default only redacted content appears in the Amazon Connect admin website.

You must have permissions to view unredacted content. For more information, see [Security profile permissions for Contact Lens](#).

Evaluate agent performance

Amazon Connect helps you to assess, track, and improve how agents interact with customers and resolve issues. For example, you can search for a contact, choose the appropriate evaluation form, review the contact audio, transcript, or both, and then evaluate how the agent interacted with the customer. You can then use that feedback to help the agent deliver improved customer experiences.

Tip

IT administrators: To enable Amazon Connect evaluation capabilities, go to the Amazon Connect console, choose your instance alias, choose **Data storage, Content evaluations, Edit**. You'll be prompted to create or choose an S3 bucket. After the bucket is created, you can store evaluations and export them.

To evaluate performance

1. Log in to Amazon Connect with a user account that has [permissions to perform evaluations](#).
2. Access the contact that you want to evaluate. There are a few ways you can do this. For example, someone may have shared the contact URL with you, or assigned you a task that has the URL. Or, you may have the contact ID, which lets you search for the contact record by doing the following: on the navigation pane, choose **Analytics and optimization, Contact search**, and then search for the contact that you want to evaluate.
3. On the **Contact details** page, choose **Evaluations** or the < icon.

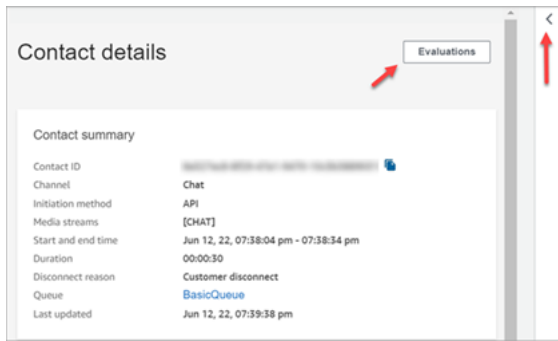

- The **Evaluations** pane lists any evaluations that are in progress or completed for the contact.

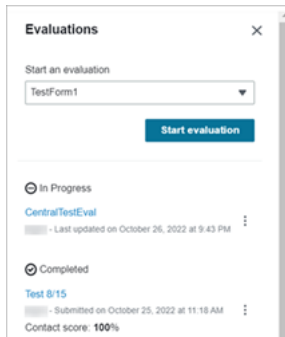

- To start an evaluation, choose an evaluation from the dropdown menu, and then choose **Start evaluation**.
- To navigate an especially long evaluation form, use the arrows next to each section to collapse or expand it.

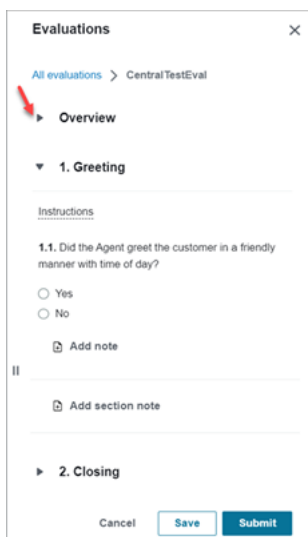

- Choose **Save** to save a form in progress. The status of the form becomes **Draft**. You can return to it any time to continue, or you can delete it and start over.

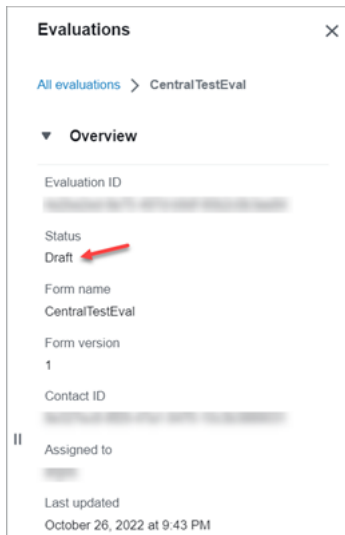

8. When you're done, choose **Submit**. The status of the form is **Completed**.

Create an evaluation form with a title

In Amazon Connect, you can create [many different evaluation forms](#). For example, you may need a different evaluation form for each business unit and type of interaction. Each form can contain multiple sections and questions. You can assign [weights](#) to each question and section to indicate how much their score impacts the agent's total score. You can also configure automation on each question, so that answers to those questions are automatically filled using insights and metrics from Contact Lens conversational analytics.

This topic explains how to create a form configure automation using the Amazon Connect admin website. To create and manage forms programmatically, see the [Evaluation actions](#) in the *Amazon Connect API Reference*.

Contents

- [Step 1: Create an evaluation form with a title](#)
- [Step 2: Add sections and questions](#)
- [Step 3: Add answers](#)
- [Step 4: Assign scores and ranges to answers](#)
- [Step 5: Enable automated evaluations](#)
- [Step 6: Preview the evaluation form](#)
- [Step 7: Assign weights for final score](#)

- [Step 8: Activate an evaluation form](#)

Step 1: Create an evaluation form with a title

The following steps explain how to create or duplicate an evaluation form and set a title.

1. Log in to Amazon Connect with a user account that has permissions to create evaluation forms.
2. Choose **Analytics and optimization**, then choose **Evaluation forms**.
3. On the **Evaluation forms** page, choose **Create new form**.

—or—

Select an existing form and choose **Duplicate**.

4. Enter a title for the form, such as **Sales evaluation**, or change the existing title. When finished, choose **Ok**.



The screenshot shows a dialog box titled "Set form title" with a close button (X) in the top right corner. Below the title, there is a text input field containing "Sales evaluation". A red arrow points to the input field. To the right of the input field, the character count "16 / 128" is displayed. Below the input field, there is a message: "Characters <>{}^\\ cannot be used." At the bottom of the dialog box, there are two buttons: "Cancel" and "Ok".

The following tabs appear at the top of the evaluation form page:

- **Sections and questions.** Add sections, questions, and answers to the form.
 - **Scoring.** Enable scoring on the form. You can also apply scoring to sections or questions.
5. Choose **Save** at any time while creating your form. This enables you to navigate away from the page and return to the form later.
 6. Continue to the next step to add sections and questions.

Step 2: Add sections and questions

1. While on the **Sections and questions** tab, add a title to the section 1, for example, **Greeting**.

2. Choose **Add question** to add a question.
3. In the **Question title** box, enter the question that will appear on the evaluation form. For example, **Did the agent state their name and say they are here to assist?**

4. In the **Instructions to evaluators** box, add information to help the evaluators or generative AI to answer the question. For example, for the question *Did the agent try to validate the customer identity?* you may provide additional instructions such as, *The agent is required to always ask a customer their membership ID and postal code before addressing the customer's questions.*
5. In the **Question type** box, choose one of the following options to appear on the form:
 - **Single selection:** The evaluator can choose from a list of options, such as **Yes, No, or Good, Fair, Poor.**
 - **Text field:** The evaluator can enter free form text.

- **Number:** The evaluator can enter a number from a range that you specify, such as 1-10.
6. Continue to the next step to add answers.

Step 3: Add answers

1. On the **Answers** tab, add answer options that you want to display to evaluators, such as **Yes**, **No**.
2. To add more answers, choose **Add option**.

The following image shows example answers for a **Single selection** question.

▼ 1.1. Did the agent state their name and say they are here to assist?

Question title: Did the agent state their name and say they are here to assist? Question type: Single selection

Reference ID: qfc78ac5 63 / 350

► Instructions to evaluators — optional

Answers | Scoring | Automation | Display options

Answers
Add answer options that you want to display to evaluators

Yes
Reference ID: o56bc61bd 3 / 128

No
Reference ID: o5e6be749 2 / 128

+ Add option

Enable "Not Applicable"
Evaluators will be able to skip this question and mark it as "Not Applicable"

✕ Add section Add sub-section Add question

The following image shows an answer range for a **Number** question.

▼ 1.2. How many times did the agent interrupt the customer? ⋮

Question title: How many times did the agent interrupt the customer? Question type: Number

Reference ID: q80981c1e 52 / 350

▶ Instructions to evaluators — optional

Answers | Scoring | Automation

Min value: 0 Max value: 10

Enter a range for how many interruptions the evaluator may count.

Enable "Not Applicable"
Evaluators will be able to skip this question and mark it as "Not Applicable"

- When you're finished adding answers, continue to the next step to enable scoring, and add ranges for scoring **Number** answers.

Step 4: Assign scores and ranges to answers

- Go to the top of the form. Choose the **Scoring** tab, and then choose **Enable scoring**.

Evaluation forms > Create a new evaluation form

Sales evaluation ✎

Draft · Scoring enabled

Sections and questions | Scoring

Scoring

Enable scoring

Assign scores to questions and weights to questions or sections that are used to determine a final score. [Learn more](#)

This enables scoring for the entire form. It also enables you to add ranges for answers to **Number** question types.

- Return to the **Sections and questions** tab. Now you have the option to assign scores to **Single selection**, and add ranges for **Number** question types.

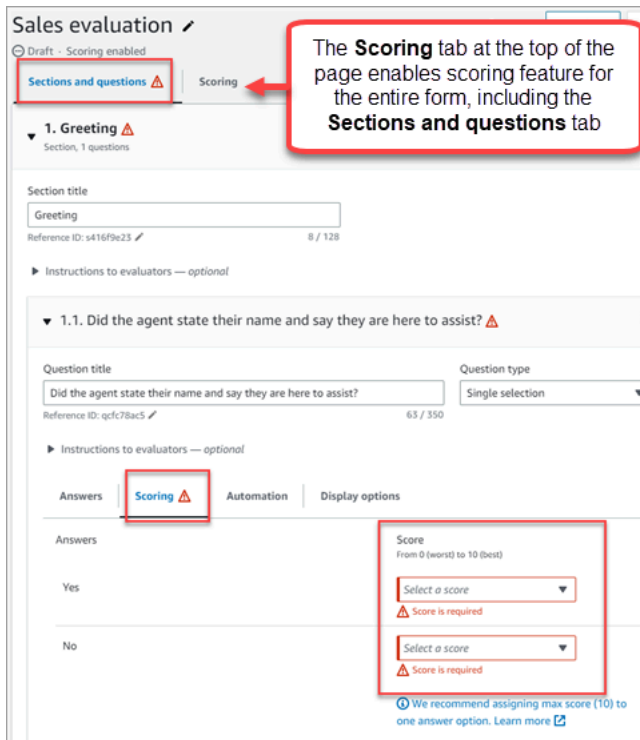

- When you create a **Number** type question, on the **Scoring** tab, choose **Add range** to enter a range of values. Indicate the worst to best score for the answer.

The following image shows an example of ranges and scoring for a **Number** question type.

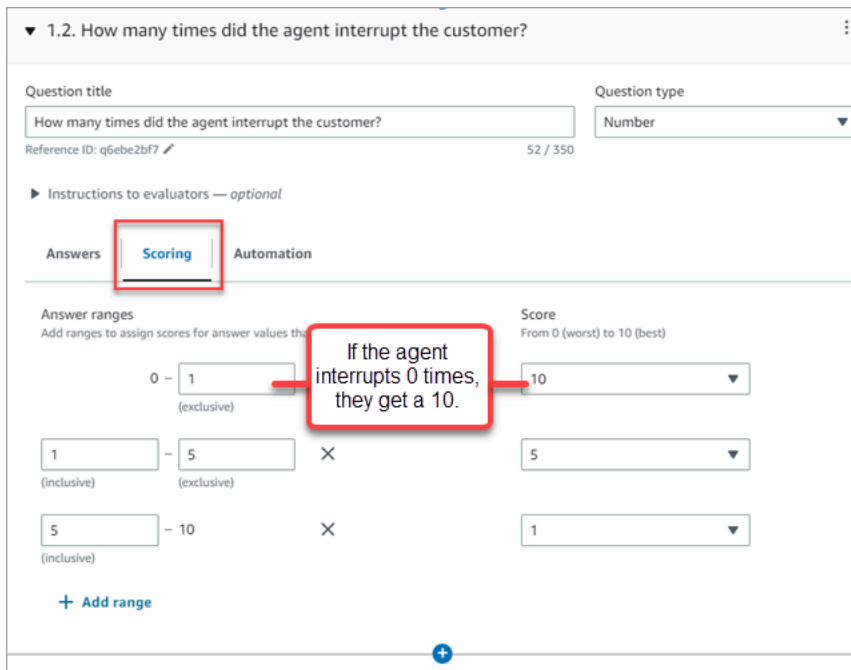

- If the agent interrupted the customer 0 times, they get a score of 10 (best).

- If the agent interrupted the customer 1-4 times, they get a score of 5.
- If the agent interrupted the customer 5-10 times, they get a score of 1 (worst).

Important

If you assign a score of **Automatic fail** to a question, *the entire evaluation form is assigned a score of 0*. The **Automatic fail** option is shown in the following image.

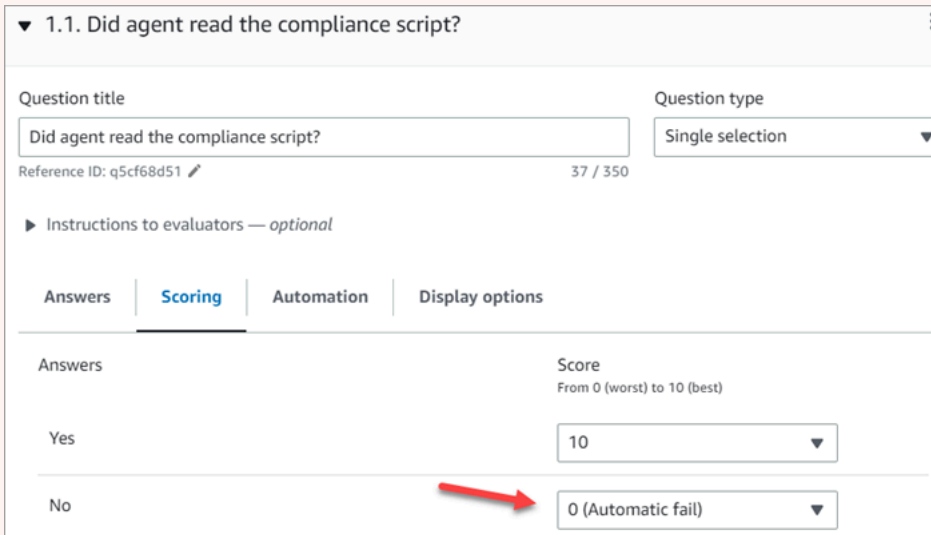

▼ 1.1. Did agent read the compliance script?

Question title: Did agent read the compliance script? Question type: Single selection

Reference ID: q5cf68d51 37 / 350

► Instructions to evaluators — optional

Answers | **Scoring** | Automation | Display options

Answers	Score From 0 (worst) to 10 (best)
Yes	10
No	0 (Automatic fail)

4. After you assign scores to all the answers, choose **Save**.
5. When you're finished assigning scores, continue to the next step to automate the question of certain questions, or continue to [preview the evaluation form](#).

Step 5: Enable automated evaluations

Contact Lens enables you to define agent performance criteria as questions within evaluation forms (for example, did the agent adhere to the greeting script?), and then use insights and metrics from conversational analytics to automatically provide responses to these questions. Automation can be used to:

- **Assist evaluators with performance evaluations:** by providing automated responses to questions on evaluation forms. These responses can be overridden by an evaluator before submission.

- **Perform fully automated evaluations:** Automatically fill responses to all of the questions within an evaluation form and submit evaluations for up to 100% of customer interactions. These fully automated evaluations can be edited and re-submitted by evaluators.

For both scenarios, you need to first setup automation on individual questions within an evaluation form. The following are examples of setting up automated evaluations, one for a Single section question and another for a Numeric question:

Example automation for a Single selection question

- If the agent mentioned X or Y in the script, score this question as Yes.

The following image shows that when Contact Lens detects the words or phrases in the **ScriptCompliance** category, the question will automatically be answered **Yes**.

▼ 1.1. Did the agent greet the customer politely?

Question title: Did the agent greet the customer politely? Question type: Single selection

Reference ID: qb79146d0 42 / 350

▶ Instructions to evaluators — optional

Answers | Scoring | **Automation** | Display options

Configure automation settings
You can specify automated responses using Contact Lens categories. [Learn more](#)

When this condition occurs: When Contact Lens category "ScriptCompliance" is present

Automatic answer: Yes

+ Add condition

Otherwise the default value is: No

For information about setting up the criteria, see [Automatically categorize contacts based on keywords and phrases used during a conversation](#).

Example automation for a Numeric question

- If the agent interaction duration was less than 30 seconds, score the question as a 10.

▼ 1.3. How long was the customer hold time to locate the part number?

Question title: How long was the customer hold time to locate the part number? Question type: Number
Reference ID: q3015c29f 62 / 350

▶ Instructions to evaluators — optional

Answers | **Scoring** | Automation

Answer ranges: Add ranges to assign scores for answer values that fall within a range. Score: From 0 (worst) to 10 (best)

No limit – 30 (exclusive) → 10
30 (inclusive) – 240 (exclusive) × 4

If the customer hold time is less than 30 seconds, score this question 10.

- On the **Automation** tab, choose the metric that is used to automatically evaluate the question.

▼ 1.1. How long was the customer hold time to locate the part number?

Question title: How long was the customer hold time to locate the part number? Question type: Number
Reference ID: q0894173e 62 / 350

▶ Instructions to evaluators — optional

Answers | Scoring | **Automation**

Configure automation settings: You can specify automated responses using Contact Lens or contact data. [Learn more](#)

Customer hold time seconds ✓
Min value: 0, Max value: 28800

Choose the metric that is used to automatically evaluate the question.

- You can use any metadata that is a number. For example, first response time, sentiment score, and non-talk time.

Once an evaluation form is activated with automation configured on some of the questions, then evaluators will receive automated responses to those questions when they start an evaluation from within the Amazon Connect admin website.

To perform fully automated evaluations that are automatically filled and submitted

1. Setup automation on every question within an evaluation form as previously described.

2. Turn on **Enable fully automated evaluations** before activating the evaluation form.

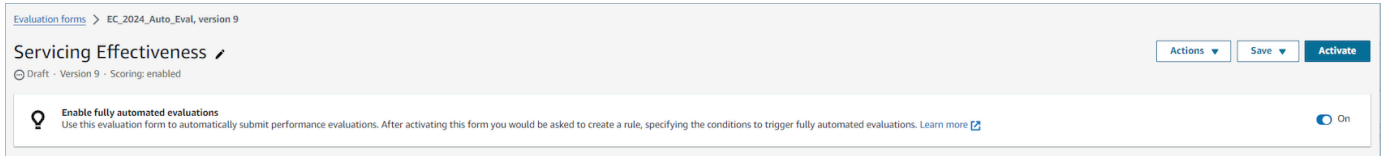

3. [Create a rule that submits an automated evaluation](#) which enables you to specify which contacts should be automatically evaluated using the evaluation form.

Step 6: Preview the evaluation form

The **Preview** button is active only after you have assigned scores to answers for all of the questions.

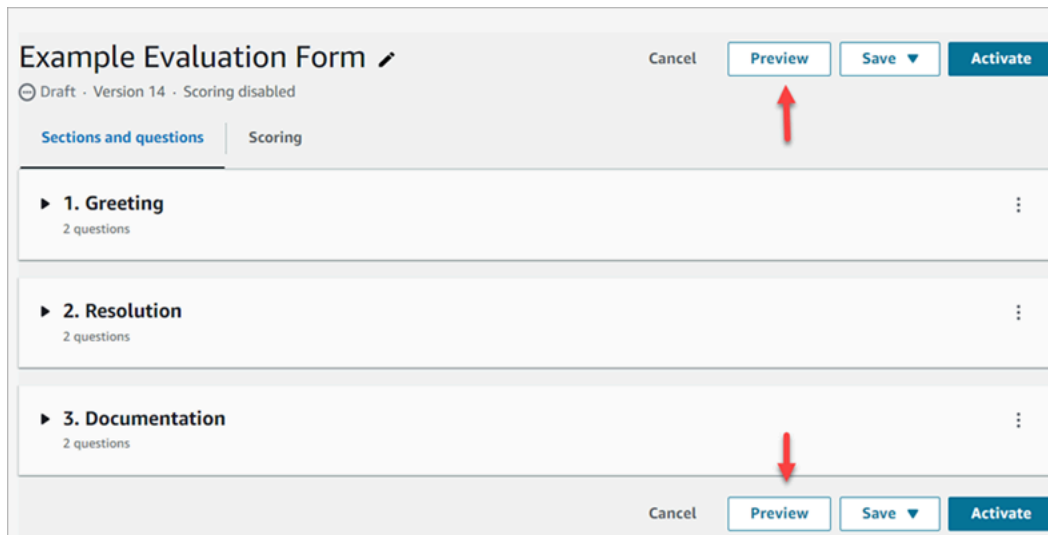

The following image shows the form preview. Use the arrows to collapse sections and make the form easier to preview. You can edit the form while viewing the preview, as shown in the following image.

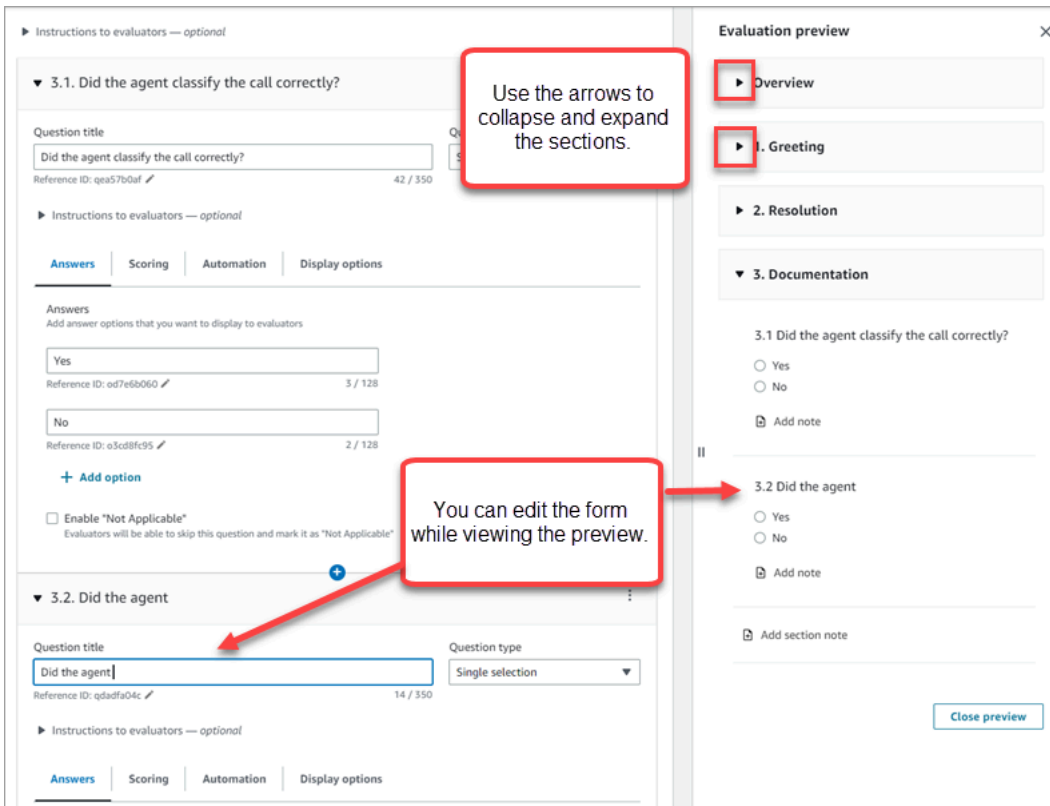

Step 7: Assign weights for final score

When scoring is enabled for the evaluation form, you can assign *weights* to sections or questions. The weight raises or lowers the impact of a section or question on the final score of the evaluation.

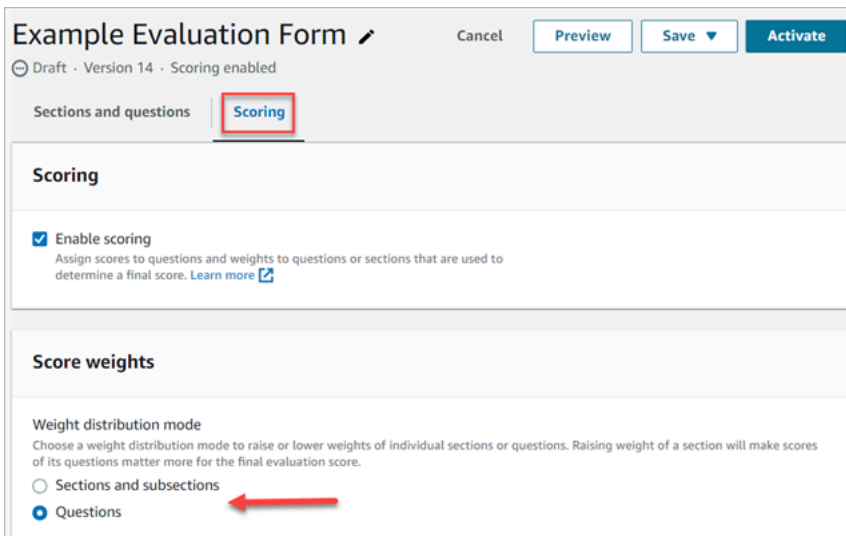

Weight distribution mode

With **Weight distribution mode**, you choose whether to assign weight by section or question:

- **Weight by section:** You can evenly distribute the weight of each question in the section.
- **Weight by question:** You can lower or raise the weight of specific questions.

When you change a weight of a section or question, the other weights are automatically adjusted so the total is always 100 percent.

For example, in the following image, three of the questions were manually set to 10 percent. The weights that display in italics were adjusted automatically.

Example Evaluation Form Preview Delete Save Activate

Draft - Version 15 - Scoring enabled

Sections and questions | **Scoring**

Scoring

Enable scoring
Assign scores to questions and weights to questions or sections that are used to determine a final score. [Learn more](#)

Score weights

Weight distribution mode
Choose a weight distribution mode to raise the importance of a question. This mode will make scores of its questions matter more for the final evaluation score.

Sections and subsections

Questions

Total weight: 100%

Section	Question	Weight
1. Greeting	1.1. Did the agent greet the customer politely? (Single selection)	10 %
	1.2. Did the agent actively listen to the caller's needs to understand the situation? (Single selection)	18 %
2. Resolution	2.1. Did the agent address all the issues raised by the caller? (Single selection)	18 %
	2.2. Did the agent communicate the resolution to the customer? (Single selection)	18 %
3. Documentation	3.1. Did the agent classify the call correctly? (Single selection)	18 %
	3.2. Did the agent record the component number? (Single selection)	18 %

Step 8: Activate an evaluation form

Choose **Activate** to make the form available to evaluators. Evaluators will no longer be able to choose the previous version of the form from the dropdown list.

Previous versions of the form are linked to the completed evaluations based on them. This allows you to view the version of the form that the evaluation is based on.

View an evaluation form audit trail

1. Select the evaluation form that you want to research.

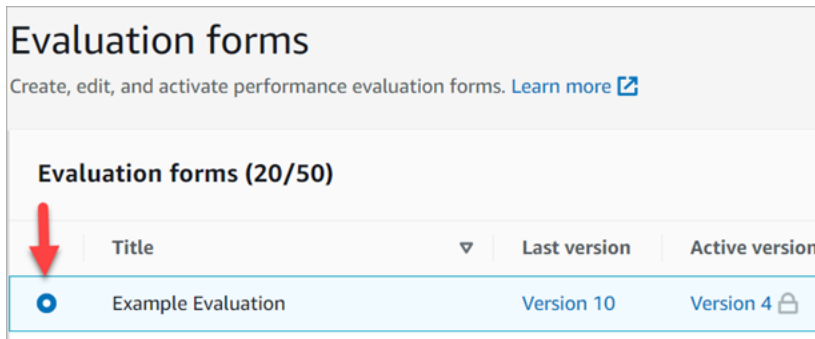

- At the bottom of the page, under **Example Evaluation**, use the dropdown menu to view previous versions, who accessed them, and when. The following image shows an example audit trail.

Version 4 Active, locked, last modified on April 28, 2022 by
Version 3 Draft, locked, last modified on April 11, 2022 by
Version 2 Draft, locked, last modified on April 8, 2022 by
Version 1 Draft, locked, last modified on April 8, 2022 by
Choose a version

- Optionally, choose one of the forms to open it.

What do Active, Draft, and Locked mean?

An form is in one of the following states:

- Active.** A published version of the form that is available to evaluators.
- Draft.** An inactive, locked version of the form. A draft is unlocked only when you are working on it.
- Locked.** An evaluation form is locked when you activate or publish it. Even after you deactivate the form, it stays locked, and becomes a historical version of the form. However, you can activate the historical version to save it as new version.

Evaluate performance using generative AI (preview)

This is prerelease documentation for a service in preview release. It is subject to change.

Note

Powered by Amazon Bedrock: AWS implements [automated abuse detection](#). Because Amazon Q in Connect is built on Amazon Bedrock, users can take full advantage of the controls implemented in Amazon Bedrock to enforce safety, security, and the responsible use of artificial intelligence (AI).

Managers can perform evaluations faster and more accurately with generative AI-powered recommendations for answers to questions in agent evaluation forms. Managers can receive extra insights into agent behavior, along with context and justification for recommended answers. These insights are derived from reference points in the transcript that were used to provide the answers.

Generative AI-powered performance evaluations are provided by analyzing the conversation transcript to answer the evaluation form questions, using the criteria specified within the [instructions to evaluators](#) associated with each question.

Region and language availability

This feature is available for Amazon Connect instances created in the US East (N. Virginia) and US West (Oregon) AWS regions, in [English locales](#).

Get generative AI-powered evaluation recommendations

1. Log into Amazon Connect with a user account that has [permissions to perform evaluations](#) and [ask AI assistant](#).
2. Choose the **Ask AI** button below a question to receive a generative AI-powered recommendation for the answer, along with context and justification (reference points from the transcript that were used to provide answers).
 - a. The answer will get automatically selected based on the generative AI recommendation, but can be changed by the user.
 - b. You can get generative AI-powered recommendations by choosing **Ask AI** for up to 5 questions per contact.
3. You can choose the time associated with a transcript reference to be directed to the point in the conversation

The screenshot displays the Amazon Connect interface for reviewing a call recording and transcript. The top section shows a recording timeline with a volume indicator and playback controls. Below the timeline is a transcript of the call, showing the agent's response to the customer. The transcript includes the following text:

Agent 00:02
Hi, [PII]. Thank you for calling any company Bank. This is [PII]. How may I assist you?

Customer 00:05
Ok. Hi [PII]. I saw a promo for a new travel credit card and had some questions about it.

Agent 00:13
Of course. Thank you. I'd be happy to help.

The right side of the interface shows an evaluation form with three questions:

- 1.5 Did the agent properly greet the customer and introduce themselves?**
Question instructions: The agent's first line of dialogue meets the criteria outlined in the question by thanking the customer for calling, introducing themselves by name and asking how they can help, therefore the answer is Yes. Here are some transcript references to support this answer:
• "Hi, [PII]. Thank you for calling any company Bank. This is [PII]. How may I assist you?" (00:02)
Options: Yes, No
- 1.6 When applicable, did the agent try to ask for more details to identify the problem the customer called about?**
Options: Yes, No, Not Applicable
- 1.7 Did the agent use inappropriate language?**
Options: Yes, No

A red arrow points to the 'AI-assisted answer' section of the evaluation form, which is currently set to 'Yes'.

Provide criteria for answering evaluation form questions using generative AI

While configuring an evaluation form, you can provide criteria for answering questions within the **instructions to evaluators** associated with each evaluation form question. Apart from driving consistency in evaluations by evaluators, these instructions are also used to provide generative AI-powered evaluations.

Amazon Connect

New Account Opening Agent Scorecard ✎

Draft · Version 13 · Scoring: disabled

Enable fully automated evaluations
Use this evaluation form to automatically submit performance evaluations. After activating this form you would be asked to create a rule, specifying the conditions to trigger fully automated evaluations.

Sections and questions | Scoring and weights

▼ **1. Generic questions**
Section, 8 questions

Section title
Generic questions
Reference ID: sd4993324 ✎ 17 / 128

► Instructions to evaluators — *optional*

▼ **1.1. Did the agent offer additional assistance?**

Question title
Did the agent offer additional assistance?
Reference ID: q715b54c3 ✎ 42 / 350

▼ Instructions to evaluators — *optional*

Answer should be "Yes" if the agent asked the customer if they needed anything else and waited for the customer to respond.

123 / 1024

Guidelines to improve generative AI accuracy

Selecting questions for getting generative AI recommendations

1. Utilize generative AI to respond to questions that can be answered using information from the conversation transcript, without the need to validate information through third-party applications such as CRM systems.
2. Using generative AI to answer questions requiring numeric responses, such as "How long did the agent interact with the customer?" is not recommended. Instead, consider [setting up automation](#) for such evaluation form questions using Contact Lens or contact metrics.
3. Avoid using generative AI to answer highly subjective questions, for example, "Was the agent attentive during the call?".

Improving phrasing of questions and associated instructions

1. Use complete sentences to word questions, for example, replacing *ID validation* with "Did the agent attempt to validate the customer's identity?", will enable the generative AI to better understand the question.
2. It is recommended that you provide detailed criteria for answering the question within the **instructions to evaluators**, especially if its not possible to answer the question based on the question text alone. For example, for the question "Did the agent try to validate the customer identity?", you may provide additional instructions such as, *The agent is required to always ask a customer their membership ID and postal code before addressing the customer's questions.*
3. If answering a question requires knowledge of some business specific terms, then specify those terms in the instruction. For example, if the agent needs to specify the name of the department in the greeting, then list the required department name(s) that the agent needs to state as part of the **instructions to evaluators** associated with the question.
4. If possible, use the term 'agent' instead of terms like 'colleague', 'employee', 'representative', 'advocate', or 'associate'. Similarly use the term 'customer', instead of terms like 'member', 'caller', 'guest', or 'subscriber'.
5. Only use double quotes in your instruction if you want to check for exact words being spoken by the agent or the customer. For example, If the instruction is to check for the agent saying "Have a nice day", then the generative AI will not detect *Have a nice afternoon*. Instead the instruction should say: The agent wished the customer a nice day.

How scoring and weights work on evaluation forms

By using *weights*, you can increase or decrease the impact of a question or section score on the overall evaluation score.

When scoring is enabled for the evaluation form, you can assign *weights* to sections or questions. The weight raises or lowers the impact of a section or question on the final score of the evaluation.

Example score

Let's say you are assigning the score to a question is that critically important to your business. If the answer is a Yes, the agent gets 10 points. For No they get 0 points. This is shown in the following image.

▼ 3.2. Did the agent recite the compliance script for the medication?

Question title: Did the agent recite the compliance script for the medication? Question type: Single selection

Reference ID: qdadfa04c 62 / 350

▶ Instructions to evaluators — optional

Answers | **Scoring** | Automation | Display options

Answers	Score From 0 (worst) to 10 (best)
Yes	10
No	0

The answer to first question is more important to your business than the answer to *Did the agent close with "Is there anything else I can assist you with today?"*, which is also worth 0-10 points, as shown in the following image.

▼ 3.3. Did the agent close with "Is there anything else I can assist you with today?"

Question title: Did the agent close with "Is there anything else I can assist you with today?" Question type: Single selection

Reference ID: q2b7f811b 78 / 350

▶ Instructions to evaluators — optional

Answers | **Scoring** | Automation | Display options

Answers	Score From 0 (worst) to 10 (best)
Yes	10
No	0

To differentiate scores of the questions, you indicate that weight of one question is more than the other.

The following image shows that the answer to *Did the agent recite the compliance script for the medication* is 50% of the agent's score. Whereas the answer to *Did the agent close with "Is there anything else I can assist you with today"* weighs only 5% of the score.

Score weights

Weight distribution mode
Choose a weight distribution mode to raise or lower weights of individual sections or questions. Raising weight of a section will make scores of its questions matter more for the final evaluation score.

Sections and subsections

Questions

Total weight: 100%

1. Greeting	18 %
1.1. Did the agent greet the customer politely? <i>(Single selection)</i>	9 %
1.2. Did the agent actively listen to the caller's needs to understand the situation? <i>(Single selection)</i>	9 %
2. Resolution	18 %
2.1. Did the agent address all the issues raised by the caller? <i>(Single selection)</i>	9 %
2.2. Did the agent communicate the resolution to the customer? <i>(Single selection)</i>	9 %
3. Documentation	64 %
3.1. Did the agent classify the call correctly? <i>(Single selection)</i>	9 %
3.2. Did the agent recite the compliance script for the medication? <i>(Single selection)</i>	50 %
3.3. Did the agent close with "Is there anything else I can assist you with today?" <i>(Single selection)</i>	5 %

The total weight must always equal 100%.

Weight distribution mode

With **Weight distribution mode**, you choose whether to assign weight by section or question:

- **Weight by section:** You can evenly distribute the weight of each question in the section.
- **Weight by question:** You can lower or raise the weight of specific questions.

When you change a weight of a section or question, the other weights are automatically adjusted so the total is always 100 percent.

For example, in the following image, three of the questions were manually set to 10 percent. The weights that display in italics were adjusted automatically.

Example Evaluation Form Preview Delete Save Activate

Draft · Version 15 · Scoring enabled

Sections and questions | **Scoring**

Scoring

Enable scoring
Assign scores to questions and weights to questions or sections that are used to determine a final score. [Learn more](#)

Score weights

Weight distribution mode
Choose a weight distribution mode to rate. This mode will make scores of its questions matter more for the final evaluation score.

Sections and subsections

Questions

Total weight: 100%

Section	Question	Weight
1. Greeting	1.1. Did the agent greet the customer politely? (Single selection)	10 %
	1.2. Did the agent actively listen to the caller's needs to understand the situation? (Single selection)	18 %
2. Resolution	2.1. Did the agent address all the issues raised by the caller? (Single selection)	18 %
	2.2. Did the agent communicate the resolution to the customer? (Single selection)	18 %
3. Documentation	3.1. Did the agent classify the call correctly? (Single selection)	18 %
	3.2. Did the agent record the component number? (Single selection)	18 %

Annotations:

- The weight for sections cannot be change manually when in **Questions** distribution mode
- Resets this weight to the default value.
- Italics* indicates the weight is automatically calculated.

Create supervisor alerts on agent performance

You can create rules that automatically send emails or tasks to supervisors based on evaluation results. This feature helps facilitate quality assurance audits, enabling supervisors to thoroughly review evaluation results.

For example, you may want supervisors to review any evaluation forms that have an answer that is a compliance risk for your company.

Contents

- [Step 1: Define rule conditions](#)
- [Step 2: Define rule actions](#)
- [Example rule with multiple conditions](#)

Step 1: Define rule conditions

1. On the navigation menu, choose **Analytics and optimization, Rules**.
2. Select **Create a rule, Evaluation forms**.

- Under **When**, use the dropdown list to choose **A Contact Lens evaluation result is available**, as shown in the following image.

Rules > New rule

1 Define conditions — 2 Define actions — 3 Review and save

When

A Contact Lens evaluation result is available

If all of these conditions are met

+ Add condition + Add group

- Choose **Add condition**.

Rules > New rule

1 Define conditions — 2 Define actions — 3 Review and save

When

A Contact Lens evaluation result is available

If all of these conditions are met

Evaluation - Form score
Set a condition to evaluate a contact by evaluation score

Example Evaluation Form with the score >= 90 %

+ Add condition + Add group

Evaluation - Form score
Evaluation - Section score
Evaluation - Question answer
Evaluation - Results available
Agents
Queues
Contact attributes

Cancel Next >

You can combine criteria from a set of conditions to build very specific Contact Lens rules. Following are the available conditions:

- **Evaluation - Form score:** Build rules that run when the score for a specific evaluation form is met.
- **Evaluation - Section score:** Build rules that run when the score for a specific section is met.

- **Evaluation - Question answer:** Build rules that run when the score for a specific question and answer is met.
- **Evaluation - Results available:** Build rules that run on any evaluation submissions.
- **Agent:** Build rules that run on a subset of agents. For example, create a rule to ensure newly hired agents comply with company standards.

To see agent names so you can add them to rules, you need **Users - View** permissions in your security profile.

- **Queues:** Build rules that run on a subset of queues. Often organizations use queues to indicate a line of business, topic, or domain. For example, you could build rules specifically for the evaluations of those agents assign to sales queues.

To see the queue names so you can add them to rules, you need **Queues - View** permissions in your security profile.

- **Contact attributes:** Build rules that run on the values of custom [contact attributes](#). For example, you can build rules for agent evaluations for a particular line of business or for specific customers, such as based on their membership level, their current country of residence, or if they have an outstanding order.

5. Choose **Next**.

Step 2: Define rule actions

1. Choose **Add action**. You can choose the following actions:

- [Create Task](#)
- [Send email notification](#)
- [Generate an EventBridge event](#)

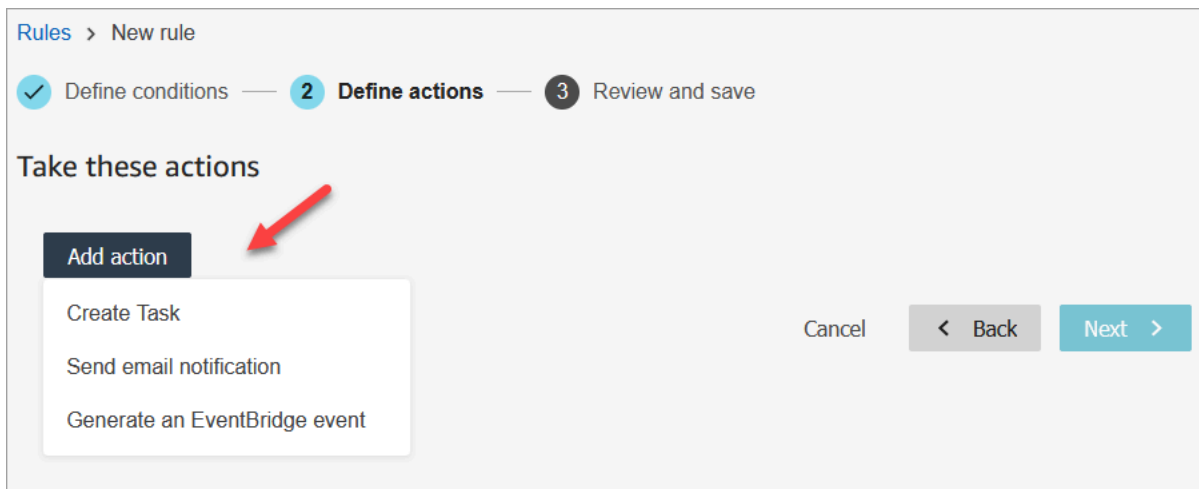

2. Choose **Next**.
3. Review and make any edits, then choose **Save**.
4. After you add rules, they are applied to new evaluation submissions that occur after the rule was added. You cannot apply rules to past, stored evaluations.

Example rule with multiple conditions

The following image shows a sample rule with six conditions. If any of these conditions are met, the action is triggered.

If any of these conditions are met

- 1 Evaluation - Form score**
Set a condition to evaluate a contact by evaluation score
Compliance Form with the score >= 50 %
- 2 Evaluation - Section score**
Set a condition to evaluate a contact by a section score
Compliance Form contains a section Greeting with the score >= 70 %
- 3 Evaluation - Question answer**
Set a condition to evaluate a contact by a question and answer
Compliance Form contains a question Did the agent greet the customer properly with the answer = Yes
- 4 Evaluation - Results available**
Set a condition to any evaluation submissions
Generated any results for evaluation form Compliance Form
- 5 Queues**
Match any of the following queues
Include Select a queue
BasicQueue X
- 6 Contact attributes**
CustomerType = VIP

- 1. Evaluation - Form score:** Does the Compliance Form have a score greater than or equal to 50%?
- 2. Evaluation - Section score:** In a Compliance Form, does the Greeting section have a score greater than or equal to 70%?
- 3. Evaluation - Question score:** Does the Compliance Form question *Did the agent greet the customer properly* equal **Yes**?
- 4. Evaluation - Results available:** Have any results been generated for the Compliance Form?
- 5. Queues:** Is this for the **BasicQueue**?
- 6. Contact attributes:** Does CustomerType equal VIP?

Search evaluation forms, scores, status, and evaluator

- Log in to Amazon Connect with a user account that has [permissions to access contact records](#) and the **Evaluation forms - perform evaluations** permission.
- In Amazon Connect choose **Analytics and optimization, Contact search**.
- Use the filters on the page to narrow your search. For date, you can search up to 8 weeks at a time.

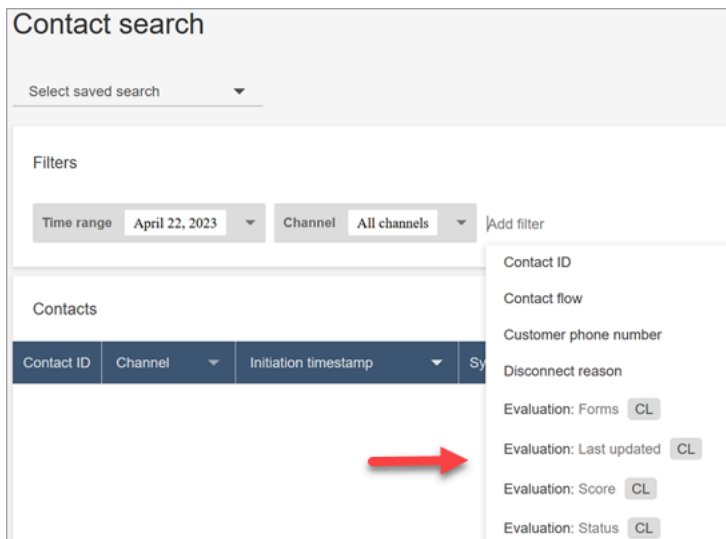

Use reference ID for questions

A *reference ID* is a token that appears in the JSON output file. It represents a specific question. When building reports, you can use it in place of the exact wording of a question.

For example, a question might be "Did agents stick to the script?" but the next day the question might be changed to "Was there good script adherence?" Regardless of how the question is worded, the reference ID always stays the same.

Example evaluation form output

This section shows the export output path for evaluations, and provides an example of evaluation form scores and metadata.

Verify your S3 bucket

When you enable **Contact evaluations** in the Amazon Connect console, you are prompted to create or choose an S3 bucket to store the evaluations. To verify the name of the bucket, go to your instance alias, choose **Data storage**, **Contact evaluations**, then **Edit**.

Example output locations

Following is the output file path for evaluation forms:

- `contact_evaluations_S3_bucket/Evaluations/YYYY/MM/DD/hh:mm:ss.sTZD-evaluation_id.json`

For example:

```
amazon-connect-s3/  
Evaluations/2022/04/14/05:04:20.869Z-11111111-2222-3333-4444-555555555555.json
```

Known issue: Two output files for the same evaluation

Contact Lens generates two output files for the same evaluation form.

- One file is written to the new default S3 path. You can configure the path in the AWS console.
- Another file, which will be deprecated, is written to a different, previous S3 path. You can disregard this file.

The previous S3 path looks like the following:

- `s3_bucket/Evaluations/contact_contactId/evaluation_evaluationId/YYYY-MM-DDThh:mm:ss.sTZD.json`

Example scores and metadata

The following example shows a typical score, plus its metadata. Text below the example describes each field.

```
{  
  "schemaVersion": "3.1",  
  "evaluationId": "fb90de35-4507-479a-8b57-970290fd5c2c",  
  "metadata": {  
    "contactId": "badd4896-75f7-43b3-bee6-c617ed3d04cb",  
    "accountId": "874551140838",  
    "instanceId": "8f753c94-9cd2-4f16-85eb-945f7f0d559a",  
    "agentId": "286bcec0-e722-4166-865f-84db80252218",  
    "evaluationDefinitionTitle": "Compliance Evaluation Form",  
    "evaluator": "jane",  
    "evaluationDefinitionId": "15d8fbf1-b4b2-4ace-869b-82714e2f6e3e",  
    "evaluationDefinitionVersion": 2,  
    "evaluationStartTimestamp": "2022-11-14T17:57:08.649Z",  
    "evaluationSubmitTimestamp": "2022-11-14T17:59:29.052Z",  
    "score": { "percentage": 100 }  
  },  
  "sections": [  
    {  
      "sectionRefId": "s1a1b58d6",
```

```

    "sectionTitle": "The title of the section",
    "notes": "Section note",
    "score": { "percentage": 100 }
  },
  {
    "sectionRefId": "s46661c49",
    "sectionTitle": "The title of the subsection",
    "parentSectionRefId": "s1a1b58d6",
    "score": { "percentage": 100 }
  }
],
"questions": [
  {
    "questionRefId": "q570b206a",
    "sectionRefId": "s46661c49",
    "questionType": "NUMERIC",
    "questionText": "How do you rate the contact between 1 and 10?",
    "answer": {
      "value": "",
      "notes": "Add more information here",
      "metadata": { "notApplicable": true }
    },
    "score": { "notApplicable": true }
  },
  {
    "questionRefId": "q73bc5b9d",
    "sectionRefId": "s46661c49",
    "questionType": "SINGLESELECT",
    "questionText": "Did the agent introduce themselves?",
    "answer": {
      "values": [
        { "valueText": "Yes", "valueRefId": "o6999aa94", "selected": true },
        { "valueText": "No", "valueRefId": "o284e4d9e", "selected": false },
        { "valueText": "Maybe", "valueRefId": "o1b2f0a14", "selected": false }
      ],
      "notes": "Add more information here",
      "metadata": { "notApplicable": false }
    },
    "score": { "percentage": 100 }
  },
  {
    "questionRefId": "qc2effc9d",
    "sectionRefId": "s46661c49",
    "questionType": "TEXT",

```

```
    "questionText": "Describe the outcome.",
    "answer": {
      "value": "Example answer text",
      "notes": "Add more information here",
      "metadata": { "notApplicable": false }
    },
    "score": { "notApplicable": true }
  }
]
}
```

The following list describes the fields in the evaluation form.

evaluationId

A unique identifier for the contact evaluation

Type – String

Length constraints – Minimum length of 1. Maximum length of 500

metadata

contactId

The identifier of the contact in this instance of Amazon Connect.

Type – String

Length constraints – Minimum length of 1, maximum length of 256

accountId

The identifier of AWS account running the instance of Amazon Connect.

Type – String

Length constraints – Constraints: 12 digits

Pattern – `^\d{12}$`

instanceId

The identifier of the Amazon Connect instance. You can [find the instance ID](#) in the Amazon Resource Name (ARN) of the instance.

Length constraints – Minimum length of 1, maximum length of 100

agentId

The identifier of the agent who performed the contact.

Type – String

Length constraints – Minimum length of 1, maximum length of 500

evaluationDefinitionTitle

The title of the evaluation form.

Type – String

Length constraints – Minimum length of 1, maximum length of 128

evaluator

Name of the user who last updated the evaluation.

Type – String

evaluationDefinitionId

The unique identifier for the evaluation form.

Type –

Length constraints – String

Pattern – Minimum length of 1, maximum length of 500

evaluationDefinitionVersion

The version of the evaluation form.

Type – Integer

Valid range – Minimum value of 1

evaluationStartTimestamp

The evaluation's creation timestamp.

Type – Timestamp

score

The evaluation's score.

sections

Array of the sections of the evaluation.

sectionRefId

The identifier of the section. An identifier must be unique within the evaluation form.

Type – String

Length constraints – Minimum length of 1, maximum length of 40

parentSectionRefId

The identifier of the parent section.

Type – String

Length constraints – Minimum length of 1, maximum length of 40

sectionTitle

The title of the section.

Type – String

Length constraints – Constraints: Minimum length of 0, maximum length of 128

notes

The notes left for the section.

Type – String

Length constraints – Minimum length of 0, maximum length of 3072

Note

Notes have the following limits:

- Individual notes have a limit of 3072 characters.
- The combined notes in an evaluation have a limit of $N \times 1024$ characters, where N is the number of questions in the evaluation.

score

The score for the section.

percentage

The score percentage for an item in a contact evaluation.

Type – Double

Valid range – Minimum value of 0, maximum value of 100

automaticFail

The flag that marks the item as automatic fail. If the item or a child item gets an automatic fail answer, this flag will be true.

Type – Boolean

notApplicable

The flag that marks the item as automatic fail. If the item or a child item gets an automatic fail answer, this flag will be true.

Type – Boolean

questions

Array of the questions of the evaluation.

questionRefId

The identifier of the question. An identifier must be unique within the evaluation form.

Type – String

Length constraints – Minimum length of 1, maximum length of 40.

sectionRefId

The identifier of the parent section.

Type – String

Length constraints – Minimum length of 1, maximum length of 40

questionType

The type of the question.

Type – StrThe combined notes in an evaluation have a limit of $N \times 1024$ characters, where N is the number of questions in the evaluation.

Valid values – TEXT | SINGLESELECT | NUMERIC

questionText

The title of the question.

Type – String

Length constraints – Minimum length of 0, maximum length of 350

answer

The answer for the question.

value

The string/numeric value for an answer in a contact evaluation.

Type – String/Double

Length constraints – String: Minimum length of 0, maximum length of 128

notes

The notes left for the section.

Type – String

Length constraints – Minimum length of 0. Maximum length of 3072

Note

Notes have two character limits. Individual notes have a limit of 3072 characters. The combined notes in an evaluation have a limit of $N \times 1024$ characters, where N is the number of questions in the evaluation.

metadata

notApplicable

Flag that marks the question as not applicable.

Type – Boolean

automation

status

The status of the automation answer.

Type – String

Valid values – UNAVAILABLE | SYSTEM_ANSWER | OVERRIDDEN_ANSWER

systemSuggestedValue

The string or numeric value for an automation answer in a contact evaluation.

Type – String or Double

Length constraints – String: Minimum length of 0, maximum length of 128

score

The [score](#) for the question.

Sample exported evaluation

The following example shows a typical exported evaluation.

```
{
  "schemaVersion": "3.1",
  "evaluationId": "fb90de35-4507-479a-8b57-970290fd5c2c",
  "metadata": {
    "contactId": "badd4896-75f7-43b3-bee6-c617ed3d04cb",
    "accountId": "874551140838",
    "instanceId": "8f753c94-9cd2-4f16-85eb-945f7f0d559a",
    "agentId": "286bcec0-e722-4166-865f-84db80252218",
    "evaluationDefinitionTitle": "Compliance Evaluation Form",
    "evaluator": "jane",
    "evaluationDefinitionId": "15d8fbf1-b4b2-4ace-869b-82714e2f6e3e",
    "evaluationDefinitionVersion": 2,
    "evaluationStartTimestamp": "2022-11-14T17:57:08.649Z",
    "evaluationSubmitTimestamp": "2022-11-14T17:59:29.052Z",
    "score": { "percentage": 100 }
  },
  "sections": [
    {
      "sectionRefId": "s1a1b58d6",
      "sectionTitle": "The title of the section",
```

```
    "notes": "Section note",
    "score": { "percentage": 100 }
  },
  {
    "sectionRefId": "s46661c49",
    "sectionTitle": "The title of the subsection",
    "parentSectionRefId": "s1a1b58d6",
    "score": { "percentage": 100 }
  }
],
"questions": [
  {
    "questionRefId": "q570b206a",
    "sectionRefId": "s46661c49",
    "questionType": "NUMERIC",
    "questionText": "How do you rate the contact between 1 and 10?",
    "answer": {
      "value": "",
      "notes": "Add more information here",
      "metadata": { "notApplicable": true }
    },
    "score": { "notApplicable": true }
  },
  {
    "questionRefId": "q73bc5b9d",
    "sectionRefId": "s46661c49",
    "questionType": "SINGLESELECT",
    "questionText": "Did the agent introduce themselves?",
    "answer": {
    "values": [
      { "valueText": "Yes", "valueRefId": "o6999aa94", "selected": true },
      { "valueText": "No", "valueRefId": "o284e4d9e", "selected": false },
      { "valueText": "Maybe", "valueRefId": "o1b2f0a14", "selected": false }
    ],
      "notes": "Add more information here",
      "metadata": { "notApplicable": false }
    },
    "score": { "percentage": 100 }
  },
  {
    "questionRefId": "qc2effc9d",
    "sectionRefId": "s46661c49",
    "questionType": "TEXT",
    "questionText": "Describe the outcome.",
```

```
    "answer": {
      "value": "Example answer text",
      "notes": "Add more information here",
      "metadata": { "notApplicable": false }
    },
    "score": { "notApplicable": true }
  }
]
```

Assign security profile permissions for evaluation forms

To allow users to create, automate, and access evaluation forms, assign the following **Analytics and optimization** security profile permissions:

- **Evaluation forms - perform evaluations:** Allows a user, such as a Quality Assurance team member, to use an evaluation form to review a contact. For an example image, see [Evaluate agent performance](#). Also allows them to [search](#) evaluations by evaluation form, score, last updated date/range, evaluator, and status.
- **Evaluation forms - manage form definitions:** Allows admins and managers to [create](#) and [manage](#) evaluation forms.
- **Rules:** Permissions to create, view, edit, and delete rules are required to [automatically categorize contacts](#) based on certain agent behaviors and customer outcomes. These contact categories can be used to [configure automation](#) on evaluation forms. In addition, rules permissions are needed to [create a rule to submit automated evaluations](#).
- **Evaluation forms - ask AI assistant:** Provides access to the **Ask AI** button while performing evaluations. The **Ask AI** button enables the user to get [generative AI-powered recommendations](#) for answers to questions in evaluation forms.

The **Admin** security profile has these permissions by default.

For information about how to add more permissions to an existing security profile, see [Update security profiles](#).

Set up and review agent screen recordings

To help coach your agents to provide great customer service, you can use the Contact Lens screen recording feature to gain quality management insights. It records the agent's desktop, which helps

you identify opportunities to improve performance. This information is also useful for ensuring compliance.

For example, let's assume it takes most agents two minutes to process a refund, but Jane Doe takes four minutes. You can watch a recording of her desktop when she's doing a refund and discover why she is taking longer.

The following diagram shows the architecture and workflow for screen recording. After the diagram there's a legend that explains each step.

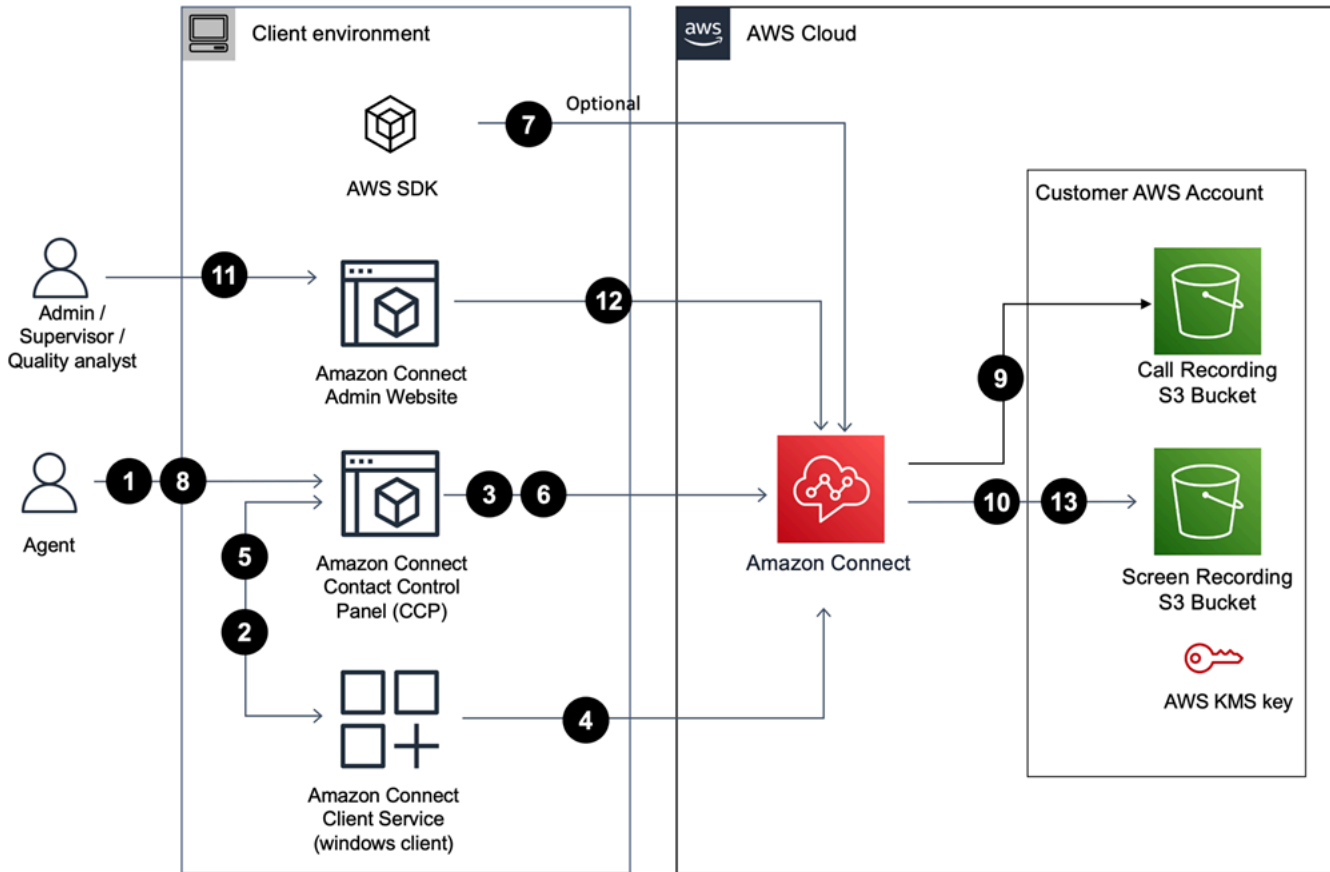

1. The agent accepts a contact that has screen recording enabled.
2. The agent's Contact Control Panel (CCP) connects with the Amazon Connect Client Service by using a web-socket (port 5431) to trigger screen recording.
- 3 - 4. The CCP and Windows client mutually authenticate each other and start the screen recording process.
5. The Amazon Connect Client Application uploads the screen recording video to the CCP.

6. The CCP uploads the screen recording to Amazon Connect in near-real time through HTTPS (port 443).
7. (Optional) You can use the [SuspendContactRecording](#) and [ResumeContactRecording](#) and APIs to pause and resume screen recording.
8. The agent closes the contact.
9. Amazon Connect initiates post processing of screen recording for the contact. It then merges the video with the call recording audio file (for voice contacts) retrieved from your Amazon S3 bucket into an MP4 file.
10. Amazon Connect uploads the final MP4 file to your Amazon S3 bucket and encrypts the MP4 file using your KMS key.
- 11-13. Supervisors and quality assurance analysts can view the screen recording by using the Amazon Connect admin website.

Important

- Amazon Connect Contact Lens screen recording is not supported when you run the Contact Control Panel (CCP) across multiple applications at the same time.

Contents

- [Amazon Connect Client Application](#)
- [Enable screen recording](#)
- [Troubleshoot: Download log files for the screen recording client app](#)
- [Assign security profile permissions for screen recordings](#)
- [Review agent screen recordings](#)
- [FAQ for screen recording capabilities](#)

Amazon Connect Client Application

Download location

Version	Release date	Download link
v2.0.0 (latest)	May 1, 2024	AmazonConnectClientWin-v2.0.0
v1.0.2.38	Sept 29, 2023	AmazonConnectClientWin-v1.0.2.38
v1.0.1.33	July 21, 2023	AmazonConnectClientWin-v1.0.1.33

Note

If your agents are using concurrent user sessions on Windows, you must download Amazon Connect Client Application version v2.0.0 or later.

The above links download the **AmazonConnectClientWin-[version].zip** file. The zip file contains the **Amazon.Connect.Client.Service.Setup.[version].msi** file. For installation instructions, see [Enable screen recording](#).

To be notified when there is an update to the Amazon Connect Client Application, we recommend subscribing to the RSS feed of this administrator guide. Choose the **RSS** link that appears under the title of this page (it's next to the PDF link).

Workstation requirements

Following are the minimum system requirements for the workstations using Screen Recording only. You'll need to scope additional memory, bandwidth, and CPU for the operating system and anything else running on the workstation to avoid resource contention.

- CPU: 2.0GHz (4 cores or 4 vCPU recommended)
- Memory: 2.5GB
- Network: 600Kbps
- Supported operating systems: 64-bit Windows 10 and 11 based on the x86-64 architecture

Note

When Windows multi-session is enabled, ensure that the agent's workstation has the recommended resource availability for each concurrent session.

Feature specifications

- **Number of open applications that can be recorded:** All open applications on a monitor are recorded, up to 3 monitors.
- **Port used for screen recording:** The Amazon Connect Client Application communicates with the Contact Control Panel through a local websocket on port 5431.
- **IP addresses to add to your firewall allowlist:** To ensure smooth screen recording functionality, add to your allowlist the IP addresses associated with Amazon S3. These IP addresses are located in the [ipranges.json](#) file specific to your AWS Region. For example, if you are in us-east-1, add the S3 IP addresses for that Region to your allowlist.

Enable screen recording

Step 1: Enable screen recording for your instance

Important

If your Amazon Connect instance was created before October, 2018, and you don't have service-linked roles set up, follow the steps in [Use service-linked roles](#), in this guide, to migrate to the Connect service-linked role.

The steps in this section explain how to update your instance settings to enable screen recording, and how to encrypt recording artifacts.

1. Open the Amazon Connect console at <https://console.aws.amazon.com/connect/>.
2. Choose your instance alias, then choose **Data storage**.

You are prompted to create or choose an Amazon S3 bucket. After the bucket is created, you can store screen recordings and export them.

3. In the navigation pane, choose **Data storage**, scroll down to **Screen recordings** and choose **Edit**.
4. Choose **Enable screen recording**, then choose **Create a new S3 bucket (recommended)** or **Select an existing S3 bucket**.
5. If you chose to create an Amazon S3 bucket, enter a name in the **Name** box. If you chose to use an existing bucket, select it from the **Name** list.
6. (Optional) To encrypt the recording artifacts in your Amazon S3 bucket, select **Enable encryption**, then choose a KMS key.

 **Note**

When you enable encryption, Amazon Connect uses the KMS key to encrypt any intermediate recording data while the service processes it.

7. When finished, choose **Save**.

For more information about instance settings, see [Update instance settings](#).

Step 2: Download and install the Amazon Connect Client Application

In this step you install the `Amazon.Connect.Client.Service` file onto the agent's desktop, or into the virtual environment that the agent uses. This is the Amazon Connect Client Application. It records the agent's open applications.

For version 2.xxx

1. [Download](#) the latest version of the `Amazon.Connect.Client.Service.Setup` file. This is an .MSI file.
2. Use your organization's software distribution mechanism, such as Software Center, to install the `Amazon.Connect.Client.Service` client app on agent desktops.

3. To verify the app is installed on the agent's desktop, navigate to `C:\Program Files\Amazon\Amazon.Connect.Client.Service`. Verify that the `Amazon.Connect.Client.Service` executable program is present.
4. Restart the agent's desktop to start `Amazon.Connect.Client.Service` in the background. Or, navigate to the installation location of `Amazon.Connect.Client.Service` and double-click to start it.

Note

In case of Windows multi-session OS, the installer needs to be run only once.

For version 1.xxx

1. [Download](#) the latest version of the `Amazon.Connect.Client.Service.Setup` file. This is an .MSI file.
2. Use your organization's software distribution mechanism, such as Software Center, to install the `Amazon.Connect.Client.Service` client app on agent desktops.
3. To verify the app is installed on the agent's desktop, navigate to `C:\Program Files\Amazon\Amazon.Connect.Client.Service`. Verify that the `Amazon.Connect.Client.Service` executable program is present.
4. Restart the agent's desktop to start `Amazon.Connect.Client.Service` in the background. Or, navigate to the installation location of `Amazon.Connect.Client.Service` and double-click to start it.

(Optional) Step 3: Verify the Amazon Connect Client Application is running and functioning correctly**For version 2.xxx****To verify that the application is running:**

1. In Windows Task Manager, check for a background process named `Amazon.Connect.Client.Service`. This is the Amazon Connect Client Application.
2. In Windows Task Manager, under Users processes, check for another process named `Amazon.Connect.Client.RecordingSession` after the user accepts the very

first contact where screen recording is enabled. The following image shows Amazon.Connect.Client.RecordingSession in Task Manager.

User	Status	28% CPU	48% Memory	2% Disk	0% Network
Amazon.Connect.Client.RecordingSession		0%	29.0 MB	0.1 MB/s	0 Mbps
Application Frame Host		0%	4.2 MB	0 MB/s	0 Mbps
Client Server Runtime Process		0.2%	1.3 MB	0 MB/s	0 Mbps
COM Surrogate		0%	1.8 MB	0 MB/s	0 Mbps
Console Window Host		0%	6.1 MB	0 MB/s	0 Mbps
Console Window Host		0%	5.8 MB	0 MB/s	0 Mbps

To verify that the application is functioning correctly and creating log files:

1. Navigate to the following directory:

```
C:\ProgramData\Amazon\Amazon.Connect.Client.Service\logs.
```

- Open log files that are present in the directory.
- In a successful installation the log files contain the following line:

```
Checking that services are still running, result : true
```

2. Navigate to the following directory:

```
%USERPROFILE%\AppData\Local\Amazon  
\Amazon.Connect.Client.RecordingSession\Logs
```

- Open log files that are present in the directory.
- In a successful installation the log files contain the following line:

```
Session initiation completed with result: True
```

For version 1.xxx

- To verify that the application is running, check the Windows Task Manager for a background process named Amazon.Connect.Client.Service. This is the Amazon Connect Client Application.
- To verify that the application is functioning correctly and creating log files, navigate to C:\ProgramData\Amazon\Amazon.Connect.Client.Service\logs.

- a. Open log files that are present in the directory.
- b. In a successful installation the log files contain the following line:

```
Checking that services are still running, result : true
```

Step 4: Configure the Set recording and analytics behavior block

- Add a [Set recording and analytics behavior](#) block immediately after the point of entry to the flow. Add the block to every flow that you want to enable for screen recording.

The following image shows the properties page of the [Set recording and analytics behavior](#) block. In the **Screen Recording** section, choose **On**.

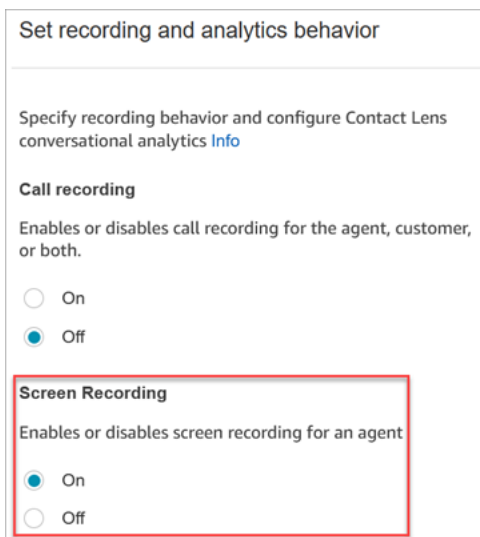

Set recording and analytics behavior

Specify recording behavior and configure Contact Lens conversational analytics [Info](#)

Call recording
Enables or disables call recording for the agent, customer, or both.

On
 Off

Screen Recording
Enables or disables screen recording for an agent

On
 Off

Configuration tips

- To enable supervisors to search for contacts that have screen recordings, add a [Set contact attributes](#) block before **Set recording and analytics behavior**. Add a custom attribute called something like **screen recording = true**. Supervisors can [search on this custom attribute](#) to find those that have screen recordings.
- You may want to add a [Distribute by percentage](#) block before **Set recording and analytics behavior**. This enables you to use screen recording for some but not all contacts.
- You may want to leverage the [SuspendContactRecording](#) and [ResumeContactRecording](#) APIs to prevent sensitive information from being captured in the screen recording.

Next steps

- Assign supervisors the required security profile permission: **Analytics and optimization - Screen recording - Access**.
- Show supervisors [how to review screen recordings](#).

Troubleshoot: Download log files for the screen recording client app

When you open an AWS Support ticket for issues with screen recordings, provide the log files for the Amazon Connect Client Application on the agent's desktop and the browser shared worker.

How to access the Amazon Connect Client Application log files

For version 2.xxx

- On the agent's desktop, navigate to:
 - **C:\ProgramData\Amazon\Amazon.Connect.Client.Service\logs** contains the logs including the Websocket connection between browser and Client Application, and another Websocket connection between Amazon.Connect.Client and Amazon.Connect.RecordingSession.
 - **%USERPROFILE%\AppData\Local\Amazon\Amazon.Connect.Client.RecordingSession\Logs** contains logs for screen recording activities.

For version 1.xxx

- On the agent's desktop, navigate to **C:\ProgramData\Amazon\Amazon.Connect.Client.Service\logs**.

How to access the screen recording shared worker logs in the browser

Important

Before doing these steps, open your CCP. It must be open so you can view the **ClientAppInterface** shared worker.

- **Chrome**

1. Open a Chrome browser. For the URL type **chrome://inspect/#workers**.
 2. In the **Shared workers** section, locate the shared worker named **ClientAppInterface**.
 3. Click **inspect** to open a DevTools instance.
 4. Choose the **Console** tab, right-click the log dump, and then select **Save as...** to store the log dump to a local file.
- **Firefox**
 1. Open a Firefox browser. For the URL type **about:debugging#workers**.
 2. In the **Shared workers** section, choose **Inspect** for **/connect/ccp-naws/static/client-app-interface.js**.
 3. Right-click the **Console** tab and select **Save all Messages to File** to store the log dump to a local file.
 - **Edge(Chromium)**
 1. Open a Chrome browser. For the URL type **edge://inspect/#workers**.
 2. In the **Shared workers** section, locate the shared worker named **ClientAppInterface**.
 3. Choose **inspect** to open a DevTools instance.
 4. Choose the **Console** tab, right-click the log dump, and then select **Save as...** to store the log dump to a local file.

Assign security profile permissions for screen recordings

To allow users to review screen recordings, assign the following **Analytics and optimization** security profile permission:

- **Screen recording - Access:** Allows a user, such as a supervisor or Quality Assurance team member, to access and review screen recordings.

Important

Screen recording merges the screen recording video with the unredacted call recording file. If users have permission to view screen recordings, they can listen to the unredacted audio.

For information about how to add more permissions to an existing security profile, see [Update security profiles](#).

Review agent screen recordings

Use screen recordings to help you evaluate agents. You can identify areas for coaching, validate activity, or identify best practices.

The screen recording is synchronized with the voice recording and contact transcript, so you can hear or read what is being said at the same time.

1. Log in to Amazon Connect with a user account that has the **Analytics and optimization - Screen recording - Access** permission in its security profile.
2. On the navigation menu, choose **Analytics and optimization, Contact search**.
3. Search for the contact you want to review.

Tip

If you've added a custom attribute to your flows to indicate when screen recording is enabled, you can [search by the custom attribute](#) to locate contact records with screen recordings. For more information, see [Configuration tips](#).

4. Click or tap the contact ID to view the **Contact details** page.
5. The **Recording** section contains a video player that displays the screen recording, as shown in the following image.

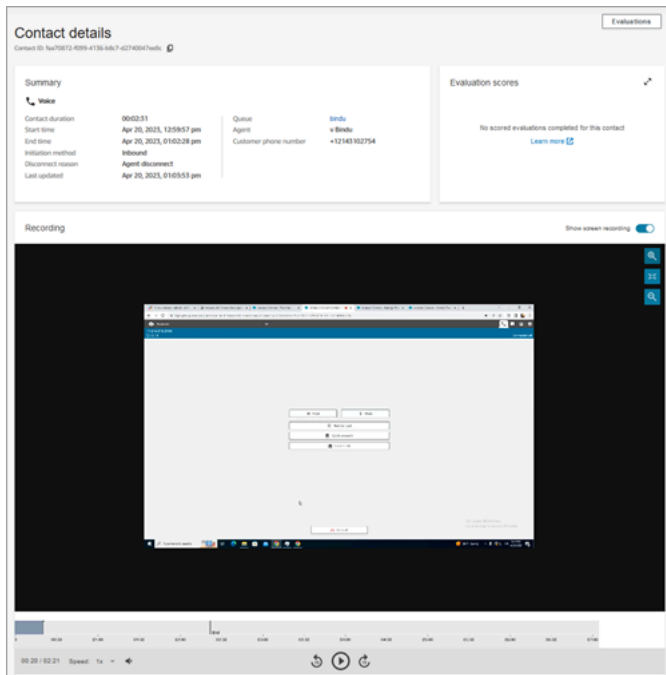

⚠ Important

Screen recording playback in the **Contact details** page is not supported in the legacy <https://your-instance-alias/awsapps.com> domain. We recommend using the <https://your-instance-alias.my.connect.aws/> domain to play screen recordings. For more information, see [Update your Amazon Connect domain](#) in this guide.

- Use the left-side controls to zoom in and out, or fit the video to the window.

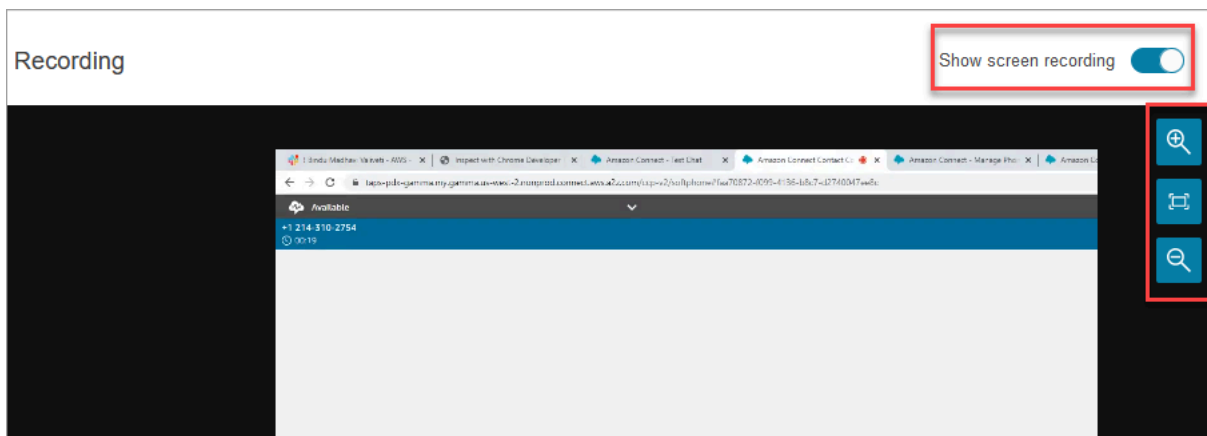

- Right-click while your cursor is on the video to display a full list of controls. They are shown in the following image.

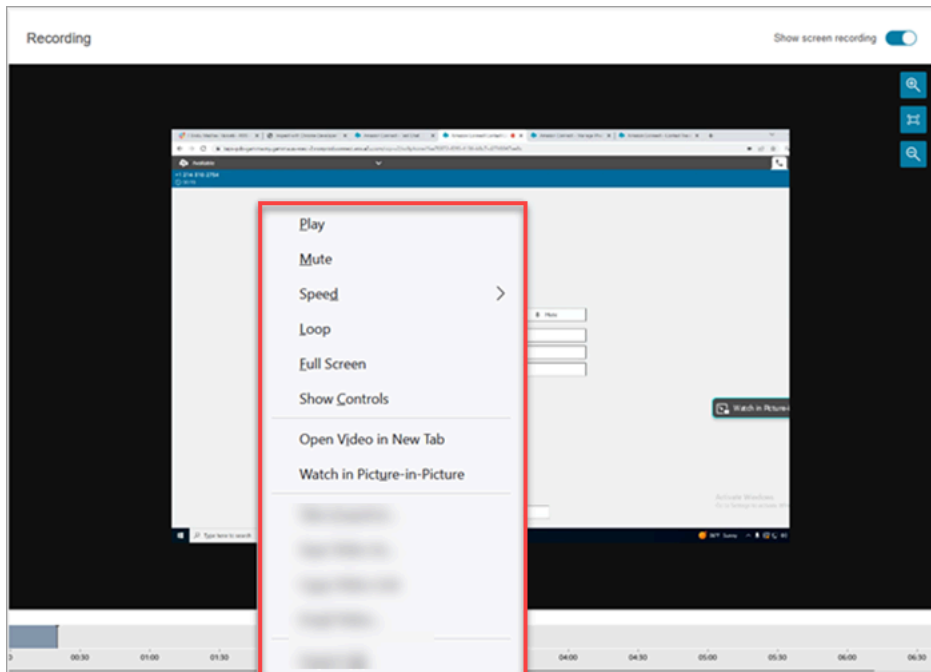

8. If you don't see a video recording, check that the **Show recording** toggle is on.

If no video appears, then the screen recording may not yet be ready (that is, uploaded into the Amazon S3 bucket). If the problem persists, contact [AWS Support Center](#).

Watch in Picture-in-picture mode

You may want to move the video elsewhere on your monitor while you watch it. For example, you can reposition the video so you can read the transcript. Use **Watch in Picture-in-picture** mode to achieve this.

1. Right-click the video to display the list of video controls.
2. Choose **Watch in Picture-in-picture**.

The video window pops out. You can move it around your monitor.

3. Choose the **X** in the top right corner to pop the window back. The following image shows the video in Picture-in-picture mode.

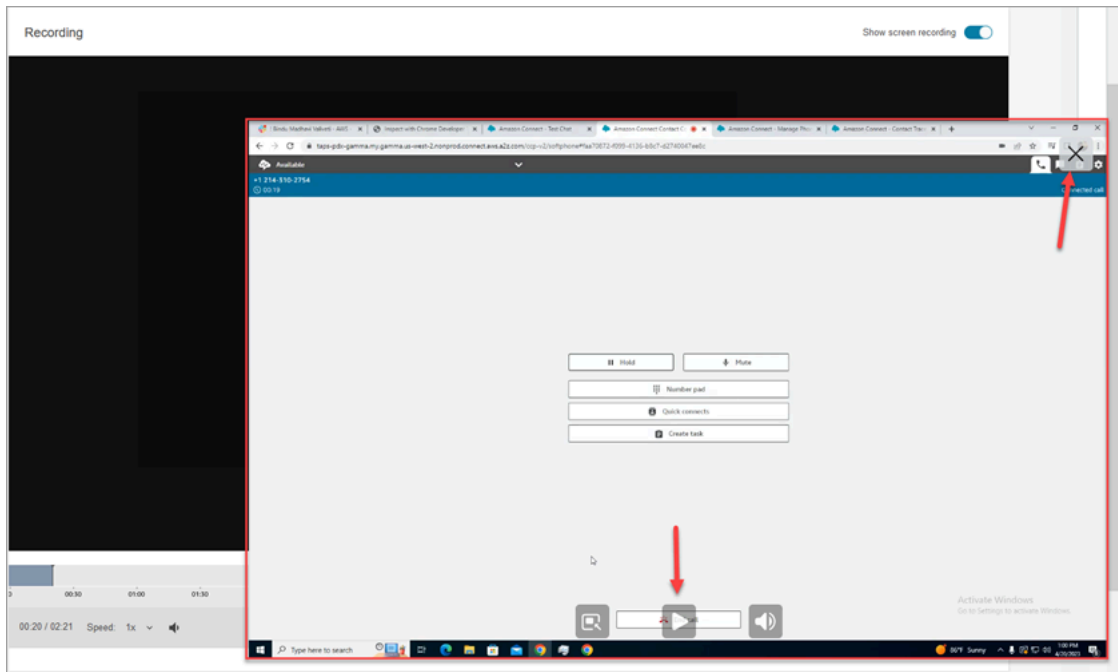

FAQ for screen recording capabilities

- **What operating systems are supported?**

Windows 10 and 11 based on the x86 architecture.

- **What is the file format of screen recordings?**

The screen recording files are saved in MP4 format.

- **Which Amazon Connect channels are supported?**

You can generate screen recordings for voice, chat, and task contacts.

- **Where the logs located for the Amazon Connect Client Application?**

You can locate the logs in `C:\ProgramData\Amazon\Amazon.Connect.Client\Logs`. If you're using version 2.xxx, also go to `%USERPROFILE%\AppData\Local\Amazon\Amazon.Connect.Client.RecordingSession\Logs` contains logs for screen recording activities.

- **Do you capture the entire screen?**

Yes, the Amazon Connect Client Service records the all the open applications on the agent's monitor, up to three monitors.

- **Does screen recording support concurrent user sessions on Windows using Virtual Desktop Infrastructure (VDI) environments?**

Yes, screen recording supports concurrent user sessions on Windows when using Amazon Connect Client Application version 2.xxxx or later.

- **Where are the screen recording files stored in my AWS account?**

The screen recordings are delivered to your Amazon S3 bucket and encrypted using the KMS key you specify. This is similar to how call recordings are stored and encrypted.

- **Where can I download the latest version of the Amazon Connect Client Application?**

The download link is on the [Amazon Connect Client Application](#) page.

- **How can I be notified when there is a latest version of the client application?**

To be notified when there is an update to the Amazon Connect Client Application, we recommend subscribing to the RSS feed of this administrator guide. Choose the **RSS** link that appears under the title of this page (it's next to the PDF link).

- **How are the recordings viewed?**

Supervisors can view the screen recordings in the contact detail page, provided they have the necessary permissions enabled in their security profiles.

- **What additional ports are used for screen recording?**

The Amazon Connect Client Application communicates with the CCP through a local websocket on port 5431.

- **What are the bandwidth requirements for screen recording?**

We recommend 500kbps per concurrent contact with screen recording enabled.

- **Can I opt only for screen recording and not for call recording?**

Yes, you can enable screen recording without call recording for a voice call.

- **How do I find the Amazon S3 location of the screen recording?**

You can find the screen recording location in the [RecordingsInfo](#) section of the contact record. See the **Location** field.

- **How do I enable screen recording for a percentage of my contacts?**

You can use the [Distribute by percentage](#) block in the flow to enable a percentage of contacts for screen recording.

- **Is screen recording PCI compliant?**

Screen recording is Payment Card Industry Data Security Standard (PCI) compliant.

- **Does screen recording work with custom CCP and agent desktops?**

Screen recording is designed to work with custom CCP and agent workspace built with the [Amazon Connect Streams JS library](#). We recommend testing your custom solution before deploying screen recording in production.

- **What additional IP addresses do I need to add to my firewall allowlist?**

To ensure smooth screen recording functionality, add to your allowlist the IP addresses associated with Amazon S3. These IP addresses are located in the [ipranges.json](#) file specific to your AWS Region. For example, if you are in us-east-1, add the S3 IP addresses for that Region to your allowlist.

- **Can I use screen recording anywhere in the world?**

Screen recording is available in all AWS commercial Regions where Amazon Connect is available. However, your use of screen recording may be subject to compliance with privacy and other laws. Please consult your compliance team before enabling this capability for your agents.

- **Are agents alerted when screen recording is enabled for a contact?**

By default Amazon Connect doesn't provide a notification feature. However, you can use the [Amazon Connect Streams JS library](#) to create a notice or other visual indicator on an agent's desktop to signal that screen recording is in use.

- **What happens if an agent closes the browser during a contact, or immediately after a contact ends?**

If the browser is closed at the beginning of contact before any screen capture data can be uploaded to Amazon Connect, the final screen recording may not be published. If the browser is closed immediately after a contact ends but before the final screen capture data can be uploaded, the screen recording is published when the agent next logs in to CCP.

Search for contacts

Note

New Feature: You can now search for in-progress contacts on the **Contact search** page. This feature will be available by the end September, 2023, in all AWS Regions where Amazon Connect is supported.

Important things to know

- You can search for contacts as far back as two years ago.
- Amazon Connect returns search results for both completed and in-progress contacts. For contacts handled by agents, a contact is only marked as completed once the agent has completed After Contact Work (ACW).
- For voice and chat contacts, the **Contact search** page displays in-progress contacts that are connected to an agent or disconnected. In-progress queued callbacks are not shown on the **Contact search** page.
- For tasks, Contact search displays all in-progress contacts after they are initiated.
- The search results for a given query are limited to the first 10K results returned.
- When you filter by Contact ID, only results for that specific contact will be returned and other criteria are ignored. For example, say you search for Contact ID 12345 and agent login Jane Doe. Results for Contact ID 12345 will be returned regardless of whether Jane Doe was the agent.
- You cannot search for multiple contact IDs at the same time.

Key search features

- [Search by custom contact attributes](#) (user-defined attributes).
- [Search for contacts that are in progress](#) or completed using the **Contact status** filter.
- Search a time range up to 8 weeks. Within the time range filter, you can specify the **Timestamp type**. This enables you to specify the time range. You can choose from initiated, connected to agent, disconnected, and scheduled timestamps.

⚠ Important

- Time range filter on Contact search has Timestamp type set to "Initiated" by default. Before the Timestamp type selection was introduced, the Timestamp type used by the Time Range filter was "Disconnected"
- Saved searches on Contact search created prior to the launch of the ability to search for in-progress contacts (launched September 2023) have been updated with the filters Contact status = "Completed" and Timestamp type = "Disconnected". These selections were implied before the launch of in-progress contacts.

- Multi-select for filters such as agent names and contact queues.
- Filters for [Contact Lens for Amazon Connect](#). You can [search for Contact categories](#) by specifying the full category name. Choose to search using **Match any** or **Match all** or **Match none**. For example, you can search contacts with both "category A" and "category B," or with either one of the two categories.

In the **Add filter** drop-down box, the Contact Lens filters have **CL** next to them. You can apply these filters only if your organization has enabled Contact Lens.

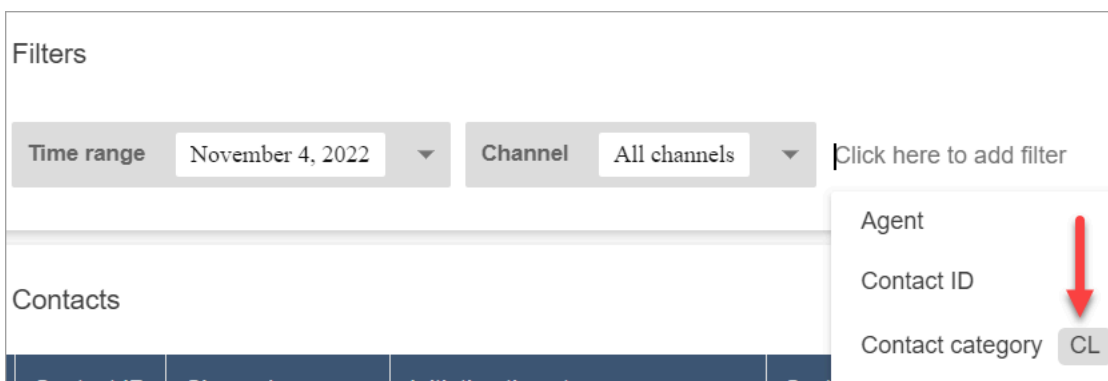

If you want to remove the Contact Lens filters from a user's drop-down list, remove the following permissions from their security profile:

- **Search contacts by conversation:** This controls access to the sentiment scores, non-talk time, and category searches.
- **Search contacts by keywords:** This controls access to the keywords search.
- **Contact Lens - conversational analytics:** On the **Contact details** page, this displays graphs that summarize conversational analytics.

- Filters for [Voice ID](#). You can search for the Voice ID authentication and fraud detection status of contacts, if your organization has enabled Voice ID. To access this functionality, on your security profile, you need **Analytics and Optimization, Voice ID - attributes and search - View** permission.

The following image shows the filters available to search Voice ID: **Authentication result, Fraud detection result, Speaker actions**.

The screenshot displays the 'Filters' panel in Amazon Connect. At the top, there are two filter boxes: 'Time range' set to 'April 13, 2022' and 'Channel' set to 'All channels'. To the right of these is a link that says 'Click here to add filter'. Below the filter boxes is a 'Contacts' table with columns for 'Contact ID', 'Channel', 'Initiation timestamp', and 'System phone number'. A dropdown menu is open on the right side of the panel, listing various filter options. Three red arrows point to specific filters in this menu: 'Authentication result' (marked with a 'V-ID' tag), 'Fraud detection result' (marked with a 'V-ID' tag), and 'Speaker actions' (marked with a 'V-ID' tag). Other filters listed include 'Agent', 'Contact ID', 'Contact category' (marked with a 'CL' tag), 'Contact flow', 'Custom contact attribute', 'Customer phone number', 'Disconnect reason', 'Initiation method', 'Interaction duration', 'Non-talk time' (marked with a 'CL' tag), 'Queue', and 'Sentiment score' (marked with a 'CL' tag').

Manage who can search for contacts and access detailed information

Before users can search for contacts in Amazon Connect, or access detailed contact information, they need to be assigned to the **CallCenterManager** security profile, or have the following **Analytics and Optimization** permissions:

- **Access metrics - Access** (Required): Grants access to metrics data.
- At least one of the following permissions is required to view contacts on **Contact search** and **Contact details** pages:
 - **Contact search - View**: Allows a user to access all contacts on **Contact search** and **Contact details** pages.
 - **View my contacts - View**: On the **Contact search** and **Contact details** pages, allows agents to view only those contacts that they handled.
- **Restrict contact access** (Optional): Manage a user's access to results on the **Contact search** page based on their agent hierarchy group.

For example, agents who are assigned to AgentGroup-1 can only view contact records for contacts handled by agents in that hierarchy group, and any groups below them. (If they have permissions for **Recorded conversations**, they can also listen to call recordings and view transcripts.) Agents assigned to AgentGroup-2 can only access contact records for contacts handled by their group, and any groups below them.

Managers and others who are in higher level groups can view contact records for contacts handled by all the groups below them, such as AgentGroup-1 and 2.

For this permission, **All** = **View** since **View** is the only action granted.

For more information about hierarchy groups, see [Set up agent hierarchies](#).

Important

- Deleting a hierarchy level severs the link to existing contacts. This action can not be reversed.
- When you change a user's hierarchy group, it may take a couple of minutes for their contact search results to reflect their new permissions.

The following table lists the typical permissions and what contacts can be views on Contact search and Contact details pages.

Contact search permission	View My Contacts permission	Restrict Contact Access permission	Which contacts can be viewed
Enabled	Disabled	Disabled	All
Enabled	Disabled	Enabled	All contacts within your agent hierarchy , handled by an agent at your hierarchy level or below.
Disabled	Enabled	Disabled	Only contacts handled by the user (agent) to whom the permission is granted.
Disabled	Disabled	Disabled	No contacts

Important

We do not recommend assigning permissions in any other combination than what is shown in the preceding table.

- **Contact Lens - conversational analytics:** On the **Contact details** page for a contact, you can view graphs that summarize conversational analytics: customer sentiment trend, sentiment, and non-talk time.
- **Recorded conversations (redacted):** If your organization uses Contact Lens for Amazon Connect, you can assign this permission so agents access only those call recordings and transcripts in which sensitive data has been removed.
- **Recorded conversations (unredacted):** If your organization isn't using Contact Lens, agents need **Recorded conversations (unredacted)** to listen to call recordings or view transcripts. If desired,

you can use **Restrict contact access** to ensure they only have access to detailed information for those contacts handled by their hierarchy group.

- **Evaluation forms - perform evaluations:** Allows users to [search for](#) evaluations by evaluation form, score, last updated date/range, evaluator, and status.
- **Voice ID - attributes and search:** If your organization uses Voice ID, users with this permission can search for and view Voice ID results in the **Contact detail** page.
- **Users - View** permission: You must have this permission to use the **Agent** filter on the **Contact search** page.

By default, the Amazon Connect **Admin** and **CallCenterManager** security profiles have these permissions.

For information about how to add more permissions to an existing security profile, see [Update security profiles](#).

How to search for a contact

1. Log in to Amazon Connect with a user account that has [permissions to access contact records](#).
2. In Amazon Connect choose **Analytics and optimization, Contact search**.
3. Use the filters on the page to narrow your search. For date, you can search up to 8 weeks at a time.

Tip

To see if a conversation was recorded, you need to be assigned to a profile that has **Manager monitor** permissions. If a conversation was recorded, by default the search result will indicate so with an icon in the **Recording** column. You won't see this icon if you don't have permission to review the recordings.

Additional fields: Add columns to your search results

Use the options under **Additional fields** to add columns in your search results. These options are not used to filter your search.

For example, if you want to include columns for **Agent Name** and **Routing profile** in your search output, choose those columns here.

Tip

The **Is transferred out** option indicates whether the contact was transferred to an external number. For the date and time (in UTC time) when the transfer was connected, see `TransferCompletedTimestamp` in the [ContactTraceRecord](#).

Download search results

You can download up to 3,000 search results at a time.

Search for in-progress contacts

For a contact that is handled by an agent, a contact is considered **In Progress** until the agent completes **After Contact Work**. For a contact that is never handled by an agent, a contact is considered **In Progress** until the contact is disconnected.

Permissions needed to search for in-progress contacts

The permissions needed to search for in-progress contacts are the same as those for searching for completed contacts. For more information, see [Manage who can search for contacts and access detailed information](#).

Contact states supported by Contact search

For voice and chat contacts, the **Contact search** page displays in-progress contacts that are connected to an agent or disconnected. For in-progress voice and chat contacts, contacts that are queued (including queued callbacks) are not displayed on the **Contact search** page.

For tasks, the **Contact search** displays all in-progress contacts after they are initiated.

How to search for in-progress contacts

1. Log in to Amazon Connect with a user account that has [permissions to access contact records](#).
2. In Amazon Connect choose **Analytics and optimization, Contact search**.

3. Select the **Contact status** filter and change the selected value to **In progress**. The default Contact status is **Completed**.

Contact ID	Channel	Contact status	Initiation timestamp
7dd1e384...	Voice	Completed	Aug 17, 2023, 01:28:16
> 8492ee4a...	Voice	Completed	Aug 17, 2023, 01:27:56 pm
7e1dcfb8-...	Voice	Completed	Aug 17, 2023, 01:27:28 pm

Filter contacts by using timestamp types

You can search for contacts in a particular contact state using **Timestamp type** within the **Time range** filter. For example, you can search for task contacts that are scheduled for the next day by selecting **Contact status = In progress**, **Timestamp type = Scheduled** and the appropriate date within **Time range**.

The following timestamp types are supported: initiated, connected (to agent), disconnected and scheduled. When you search for contacts using a certain **Timestamp type**, the search results do not contain contacts that do not have that timestamp populated, e.g. if you search for a contact with **Timestamp type = Disconnected** and **Contact status = In progress**, then you will only view contacts that are in After Contact Work state.

⚠ Important

- The **Time range** filter on the **Contact search** page has **Timestamp type** set to **Initiated** by default. Before the Timestamp type selection was introduced, the Timestamp type used by the **Time range** filter was **Disconnected**.
- Saved searches on **Contact search** created before to the launch of the ability to search for in-progress contacts (launched September 2023) have been updated with the filters **Contact status = Completed** and **Timestamp type = Disconnected**. These selections were implied before the launch of in-progress contacts.

View in progress contacts

You can click on a Contact ID within the **Contact search** results to view details of an in-progress contact.

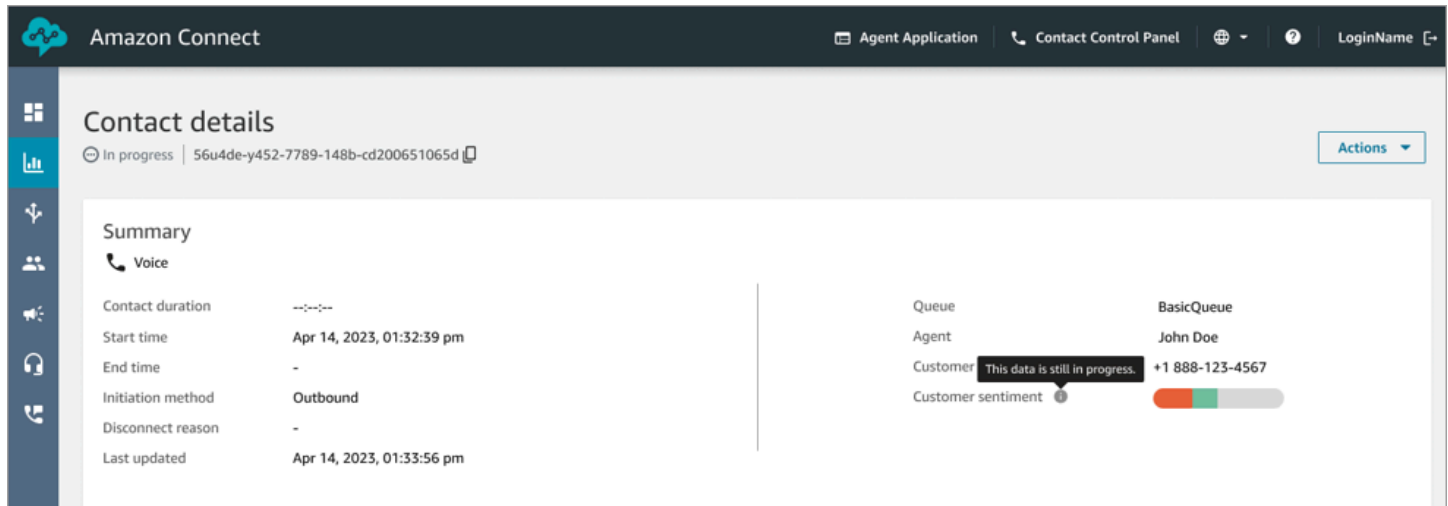

Important things to know

- The **Contact details** page for an in-progress contact shows data available at the time **Contact details** page was opened. It does not automatically refresh as the contact progresses. You need to refresh the page manually using your browser.
- Certain fields on **Contact search** and may have missing or inconsistent information while the contact is in progress. After a contact is completed, information is eventually made consistent with the underlying contact record, after the page is manually refreshed.
- There may be a delay between the contact being **Completed** and the contact being marked as **Completed** on the contact record.

Review real-time transcripts

For voice contacts, with real-time call analytics enabled, you can view transcripts of a contact in real-time on a **Contact Details** page. Scrolling down within the transcript automatically pulls the latest available turn of the conversation. Alternatively, you can choose the refresh icon on the bottom the transcript to see the latest conversation.

Transcript

Categories

testzUI FRANCIS_RESPONSE_GREATER_1_SEC

00:00

Customer has joined the conversation

System Message 00:04

This is the initial message from Diego's flow

Customer 00:07

HI

Agent (Diego) has joined the conversation

Agent (Diego) 00:17

Hi, how can I help you?

Customer 00:29

Hi, I would like to buy some products for an event

Agent (Diego) 00:38

Good! We have several products.

Agent (Diego) 00:43

Last refreshed less than 30 seconds ago 

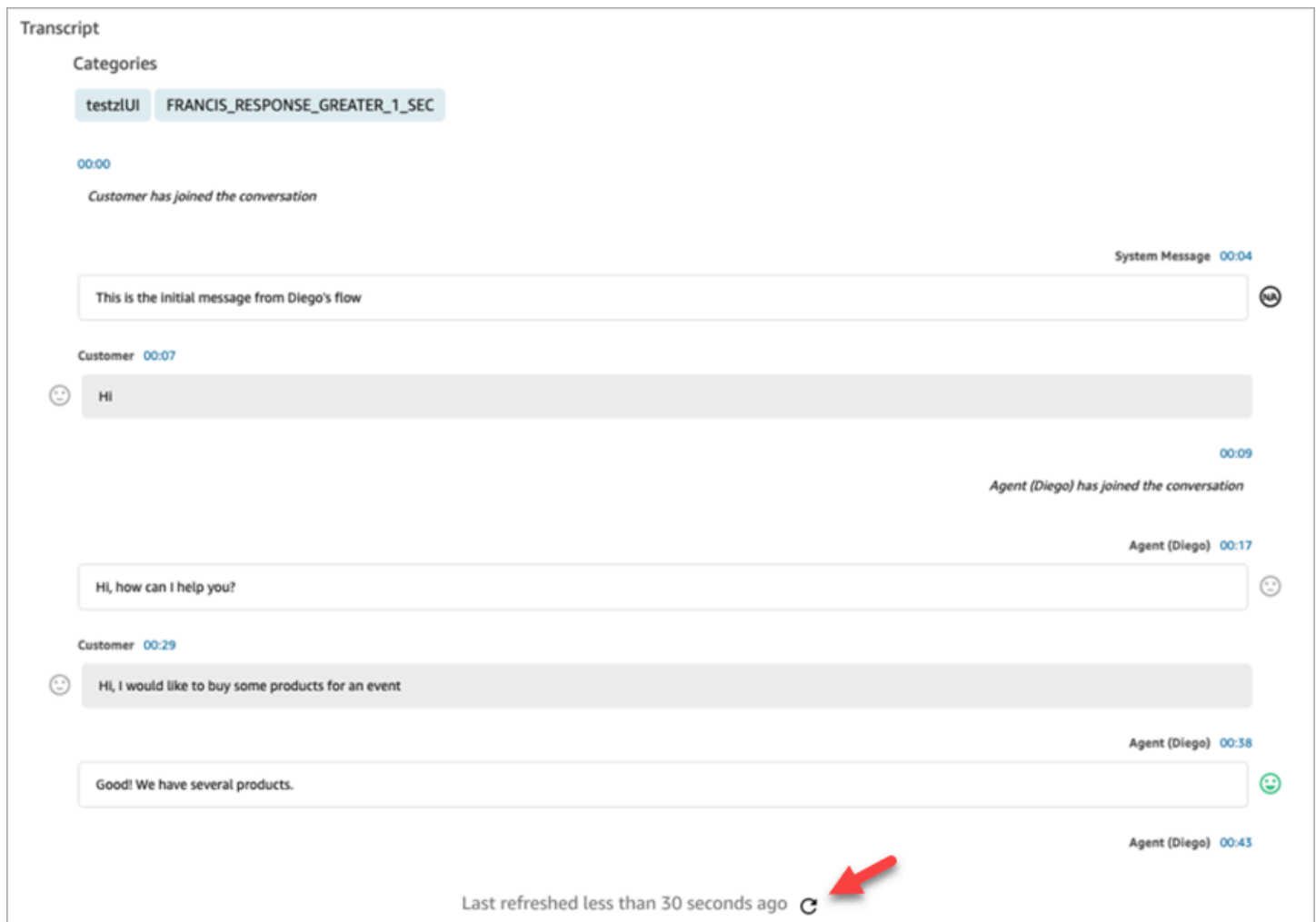

Search by custom contact attributes

You can create search filters based on custom contact attributes (also called [user-defined contact attributes](#)). For example, if you add `AgentLocation` and `InsurancePlanType` to your contact records as custom attributes, you can search for contacts with specific values in these attributes, such as calls handled by agents located in Seattle, or calls made by customers who purchased homeowners insurance.

Required permissions to configure searchable contact attributes

By default, a custom attribute isn't indexed until someone with appropriate permissions, such as an admin or manager, specifies it should be searchable. You grant permissions to select users so they can configure which custom contact attributes can be added as a search filter.

Assign the following permissions to their security profile:

- Enable one of the following permissions to access the **Contact Search** page:
 - **Contact search.** Allows you to search for all contacts.
 - **View my contacts:** Allows agents to view only those contacts that they handled.
- **Contact attributes:** Allows users to view contact attributes. Also controls access to the search filters based on contact attributes.
- **Configure searchable contact attributes - All:** People who have this permission determine what custom data will be searchable (by people who have the **Contact attributes** permission). It allows them to access the following configuration page:

Searchable custom contact attributes Cancel Save

Add the attribute keys you want to appear in Contact attributes filter. These keys will be searchable by all users with access to the filter. You can have a maximum of 15 keys.

Attribute keys

i These changes will apply to future contacts only. [Learn more.](#)

Attribute key

 + Add key

Keys are case-sensitive, and cannot be edited later. 0 / 100

Specified attribute keys (2)

AgentLocation	✕
InsurancePlan	✕

Configure searchable custom contact attributes

1. On the **Contact search** page, choose **Add filter, Custom contact attribute**. Only people with **Configure searchable contact attributes** permissions in their security profile see this option.

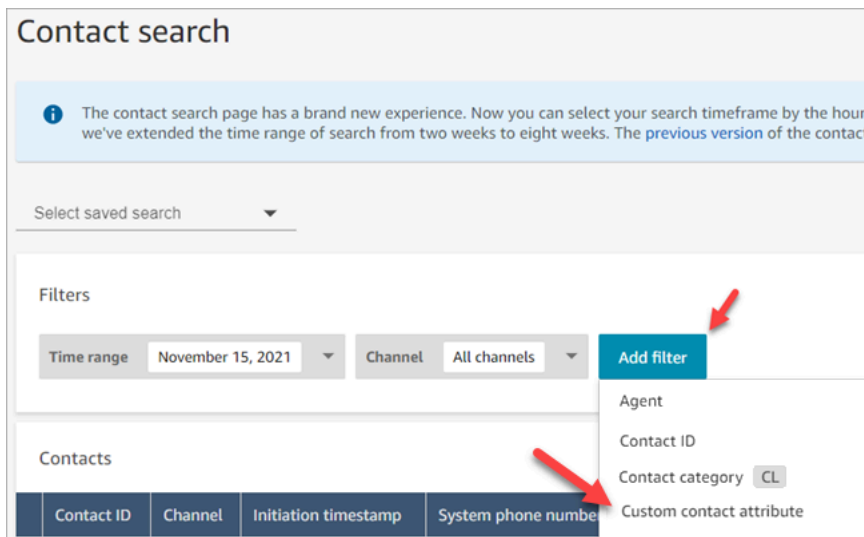

- The first time you choose **Custom contact attribute**, the following box appears, indicating no attributes have been configured for this Amazon Connect instance. Choose **Specify searchable attribute keys**.

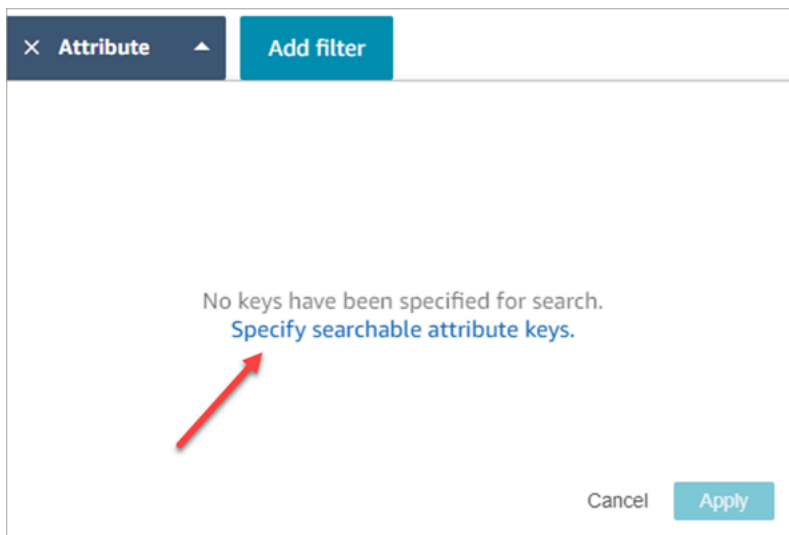

- In the **Attribute key** box, type the name of your custom attribute, and then choose **Add key**.

⚠ Important

You must type the exact key name. It is case sensitive.

- When finished, choose **Save**.

Your users will be able to search on these keys for any future contacts.

Edit, add, or remove contact attributes

To edit, add, or remove keys, choose **Attribute, Settings**. If you don't see the **Settings** option, you don't have the required permissions.

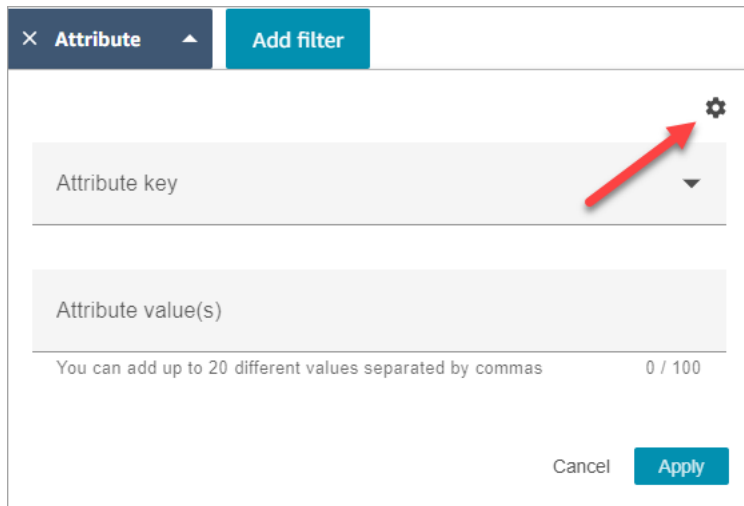

The screenshot shows a dialog box for editing contact attributes. It features a title bar with a close button, the text 'Attribute', and an 'Add filter' button. The main area contains two text input fields: 'Attribute key' and 'Attribute value(s)'. A red arrow points to a gear icon in the top right corner of the 'Attribute key' field. Below the 'Attribute value(s)' field, there is a note: 'You can add up to 20 different values separated by commas' and a character count '0 / 100'. At the bottom of the dialog are 'Cancel' and 'Apply' buttons.

Search for custom contact attributes

Users who have the **Contact attributes** permission in their security profile can find contacts by using the contact attribute filters.

1. On the **Contact search** page, choose **Add filter, Custom contact attribute**, and then choose **Specify searchable attribute keys**.
2. On the **Searchable customer contact attributes** page, in the **Attribute key** box, enter the attribute key, and choose **+Add key** and then choose **Save**.
3. Return to the **Contact search** page. Use **Add filter** to choose from the dropdown menu the attribute you just added. In the **Attribute value box**, enter the value you want to find.

Monitor live and recorded conversations

The topics in this section explain how to monitor (listen-in) on conversations between agents and contacts.

Contents

- [Set up live monitoring for voice and/or chat](#)
- [Assign permissions to monitor live conversations](#)

- [Listen to live conversations or read live chats](#)
- [Barge live voice and chat conversations](#)
- [Review recorded conversations between agents and customers using Amazon Connect](#)
- [Troubleshoot monitoring agent conversations with Amazon Connect](#)

Set up live monitoring for voice and/or chat

Managers and agents in training can monitor live conversations between agents and customers. To set this up, you need to add the **Set recording behavior** block to your voice/chat flow, assign managers and trainees the appropriate permissions, and then show them how to monitor the conversations.

Looking for how many people can monitor the same conversation at one time? See [Amazon Connect feature specifications](#).

There is no limit to the number of conversations that can be monitored in an instance.

Add a Set recording and analytics behavior block to your flow

For monitoring voice and chat conversations: This step is only required if you have not selected [Enable Multi-Party Calls and Enhanced Monitoring](#) and **Enable Barge and Enhanced Monitoring for Chat** in the Amazon Connect console, as shown in the following image.

Telephony and chat options

Amazon Connect offers the ability to accept inbound calls and chats, make outbound calls, or both. You will claim a telephone number later.

Note: You will not be able to place or receive phone calls if you don't select the corresponding telephony options.

Inbound calls

- Receive inbound calls with Amazon Connect**
Your contact center can handle incoming calls with Amazon Connect.

Outbound calls

- Make outbound calls with Amazon Connect**
You can set which users can place outbound calls in user permissions.
- Enable outbound campaigns**
Automate customer communications such as appointment reminders and delivery notifications without having to integrate third-party tools. [Learn more](#)
- Enable early media**
Agents can hear pre-connection audio such as busy signals, failure to connect errors, or other informational messages. When agents can't reach a contact, early media helps them understand why. [Learn more](#)

Enhanced contact monitoring capabilities

- Enable Multi-Party Calls and Enhanced Monitoring for Voice.**
Have up to six parties on a call. This feature includes changes to the agent call experience. [Learn more](#)
Allow selected users to monitor or barge into ongoing calls. This might affect your customized contact control panel. [Learn more](#)
- Enable Barge and Enhanced Monitoring for Chat**
Allow selected users to monitor or barge into ongoing chats. This might affect your customized contact control panel. [Learn more](#)

If you do have one or both of these options enabled for your instance, then you no longer need to add the **Set recording and analytics behavior** block to your voice or chat flow to set up monitoring. However, you still need to [assign permissions](#) to managers and trainees, and then show them [how to monitor conversations](#).

To configure a Set recording and analytics behavior block for monitoring

1. Add the [Set recording and analytics behavior](#) block to your flow. Do this to monitor calls, chats, or both.

To enable monitoring of voice and/or chat conversations, on the block's **Properties** page choose **Agent and Customer**.

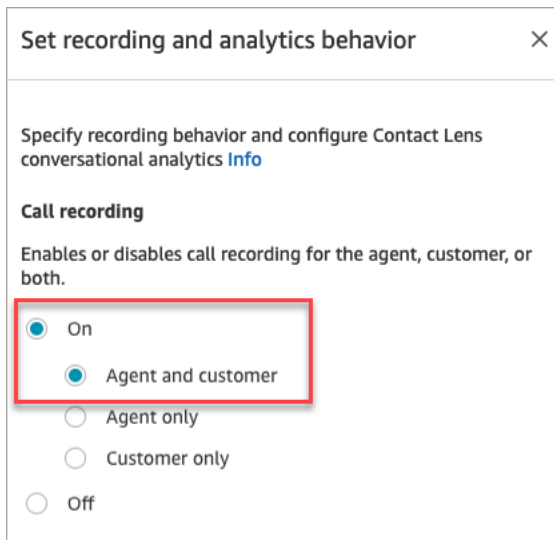

Set recording and analytics behavior ×

Specify recording behavior and configure Contact Lens conversational analytics [Info](#)

Call recording

Enables or disables call recording for the agent, customer, or both.

On

Agent and customer

Agent only

Customer only

off

For more information, see [Set up recording behavior](#).

2. Choose whether to record the conversations you monitor.

Although you need to add the **Set recording behavior** block to your flow, you don't need to record voice and/or chat conversations for monitoring to work. By default when you set up your instance, [Amazon S3 buckets are created](#) to store call recordings and chat transcripts. The existence of these buckets enables call recording and chat transcripts at the instance level.

To not record the calls or chats you're monitoring, disable the Amazon S3 buckets. For instructions, see [Update instance settings](#).

Now you're ready to assign the necessary permissions to managers so they can monitor conversations. Continue to [Assign permissions to monitor live conversations](#).

Assign permissions to monitor live conversations

For managers to monitor live conversations, you assign them the **CallCenterManager** and **Agent** security profiles. To allow agent trainees to monitor live conversations, you may want to create a security profile specific for this purpose.

To assign a manager permissions to monitor a live conversation

1. Go to **Users, User management**, choose the manager, and then choose **Edit**.

2. In the Security Profiles box, assign the manager to the **CallCenterManager** security profile. This security profile also includes a setting that makes the icon to download recordings appear in the results of the **Contact search** page.
3. Assign the manager to the **Agent** security profile so they can access the Contact Control Panel (CCP), and use it to monitor the conversation.
4. Choose **Save**.

To create a new security profile for monitoring live conversations

1. Choose **Users, Security profiles**.
2. Choose **Add new security profile**.
3. Expand **Analytics and optimization**, then choose **Access metrics** and **Real-time contact monitoring**.

Access metrics is needed so they can access the real-time metrics report, which is where they choose which conversations to monitor.

4. Expand **Contact Control Panel**, then choose **Access Contact Control Panel** and **Make outbound calls**.

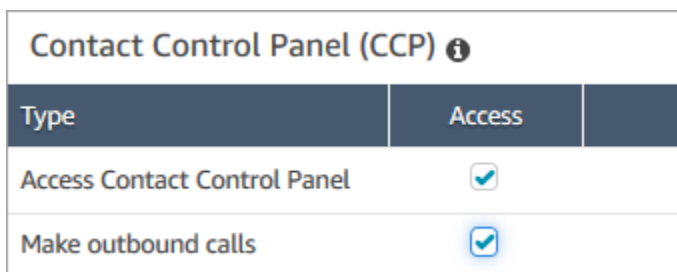

Contact Control Panel (CCP) ⓘ	
Type	Access
Access Contact Control Panel	<input checked="" type="checkbox"/>
Make outbound calls	<input checked="" type="checkbox"/>

These permissions are needed so they can monitor the conversation through the Contact Control Panel.

5. Choose **Save**.

Next, show your managers how to monitor conversations. Continue to [Listen to live conversations or read live chats](#).

Listen to live conversations or read live chats

Before you can listen to live conversations or read live chats, the Amazon Connect admin needs to [set up](#) the feature, and [assign you permissions](#). After that's done, you can do these steps.

For information about how many people can listen in to a conversation or follow a chat, see [Amazon Connect feature specifications](#).

1. Log in to Amazon Connect with a user account that is assigned the **CallCenterManager** security profile, or that has the **Real-time contact monitoring** security profile permission.
2. Open the Contact Control Panel (CCP) by choosing the phone icon in the top-right corner of your screen. You'll need the CCP open to connect to the conversation.
3. To choose the agent conversation you want to monitor, in Amazon Connect choose **Analytics and optimization, Real-time metrics, Agents**. The following image shows the **Real-time metrics** page, with an arrow pointing to the **Agents** option.

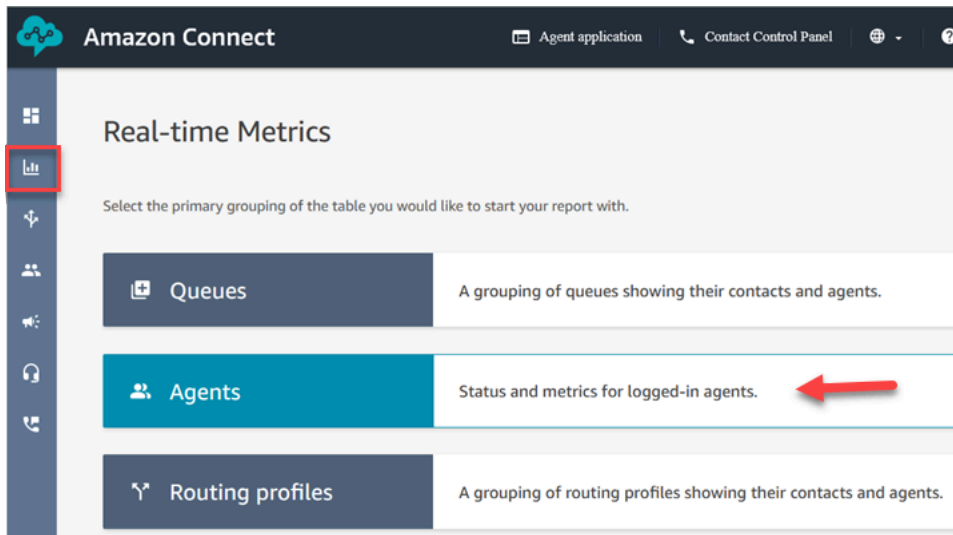

4. To monitor voice conversations: Next to the names of agents in a live voice conversation, there is an eye icon. Choose the icon to start monitoring the conversation. The following image shows the eye icon next to the **Voice** channel.

The screenshot shows the 'Real-time Metrics' page in Amazon Connect. It features a table with columns for 'Agent Login', 'Channels', 'Agent', 'Next activity', and 'Duration'. The agent 'janedoe' is listed with a 'Voice' channel selected. A tooltip 'listen in on phone conversation' is visible over the 'Voice' channel, and a red arrow points to a small icon in the 'Agent' column.

Agent Login	Channels	Agent	Next activity	Duration
janedoe	All channels		-	00:00:28
	Voice			
	Chat total			
	Task			

When you're monitoring a conversation, the status in your CCP changes to **Monitoring**.

- To monitor chat conversations: For each agent you'll see the number of live chat conversations they're in. Click on the number. Then choose the conversation you want to start monitoring.

When you're monitoring a conversation, the status in your CCP changes to **Monitoring**.

- To stop monitoring the conversation, in the CCP choose **End call** or **End chat**.

When the agent ends the conversation, monitoring stops automatically.

Barge live voice and chat conversations

Supervisors and managers can barge into live voice and chat conversations between agents and customers. To set this up, you need to turn on the **Enhanced monitoring** capability in the Amazon Connect console, provide managers with the appropriate permissions, and show them how to barge into conversations.

Looking for how many people can barge the same conversation at one time? See [Amazon Connect feature specifications](#).

There is no limit to the number of conversations that you can barge in an instance.

The barge feature is included in Amazon Connect voice service fees. For pricing, see the [Amazon Connect Pricing](#) page.

Set up barge for voice and chat

In the Amazon Connect console, select the following telephony options:

- **Enable Multi-Party Calls and Enhanced Monitoring for Voice.** This option enables access to multi-party calling, detailed contact records, silent monitoring, and barge capabilities.
- **Enable Barge and Enhanced Monitoring for Chat.** This option enables users with the appropriate security profile permissions to barge chats.

The following image shows these options on the **Telephony and chat options** page.

Telephony and chat options

Amazon Connect offers the ability to accept inbound calls and chats, make outbound calls, or both. You will claim a telephone number later.
Note: You will not be able to place or receive phone calls if you don't select the corresponding telephony options.

Inbound calls

- Receive inbound calls with Amazon Connect**
Your contact center can handle incoming calls with Amazon Connect.

Outbound calls

- Make outbound calls with Amazon Connect**
You can set which users can place outbound calls in user permissions.
- Enable outbound campaigns**
Automate customer communications such as appointment reminders and delivery notifications without having to integrate third-party tools. [Learn more](#)
- Enable early media**
Agents can hear pre-connection audio such as busy signals, failure to connect errors, or other informational messages. When agents can't reach a contact, early media lets them understand why. [Learn more](#)

Enhanced contact monitoring capabilities

- Enable Multi-Party Calls and Enhanced Monitoring for Voice.**
Have up to six parties on a call. This feature includes changes to the agent call experience. [Learn more](#)
Allow selected users to monitor or barge into ongoing calls. This might affect your customized contact control panel. [Learn more](#)
- Enable Barge and Enhanced Monitoring for Chat**
Allow selected users to monitor or barge into ongoing chats. This might affect your customized contact control panel. [Learn more](#)

Note

- If multi-party calling is already enabled, to also enable enhanced monitoring you need to use the `UpdateInstanceAttribute` API with the `ENHANCED_CONTACT_MONITORING` attribute for the first time. Or, you can turn the feature OFF and then back ON to update your settings. For more information, see [UpdateInstanceAttribute](#) in the *Amazon Connect API Reference Guide*.
- Any new instances will automatically have this feature enabled.
- Before enabling **Enhanced contact monitoring capabilities**, ensure that you are using the latest version of the [Contact Control Panel](#) (CCP) or [Agent workspace](#). If you are using [StreamsJS](#) to customize or embed the CCP, upgrade to version 2.4.2 or later.
- For instances that do not have a service-linked role, you must create one in order to enable the feature. For more information on how to enable service-linked roles, see [Use service-linked roles for Amazon Connect](#).

Assign security profile permissions

For managers to barge live conversations, you assign them the **CallCenterManager** and **Agent** security profiles.

To allow specific supervisors to barge live conversations, we recommend that you create a security profile specific for this purpose. They need the following security profile permissions:

- **Access metrics.** Enables you to access real-time metrics reports, which is where you choose which conversation you would like to monitor and barge.
- **Real-time contact monitoring:** Enables you to monitor both voice and chat conversations.
- **Real-time contact barge-in:** Enables you to barge both voice and chat conversations.
- **Access Contact Control Panel**

Barge live calls with contacts

Tip

For the number of supervisors who can monitor a call at the same time, see [Amazon Connect feature specifications](#).

1. Log in to the Amazon Connect admin website at https://instance_name.my.connect.aws/. Use an account that is assigned the **CallCenterManager** security profile or that has the required security profile permissions.
2. Open your CCP. It must be open before you can barge a call.
3. On the Amazon Connect admin website navigation menu, choose **Analytics and optimization, Real-time metrics, Agents**.
4. Choose the eye icon that appears next to the **Voice** channel of the agent that you want to monitor, as shown in the following image. You can barge into a conversation that you had been monitoring already.

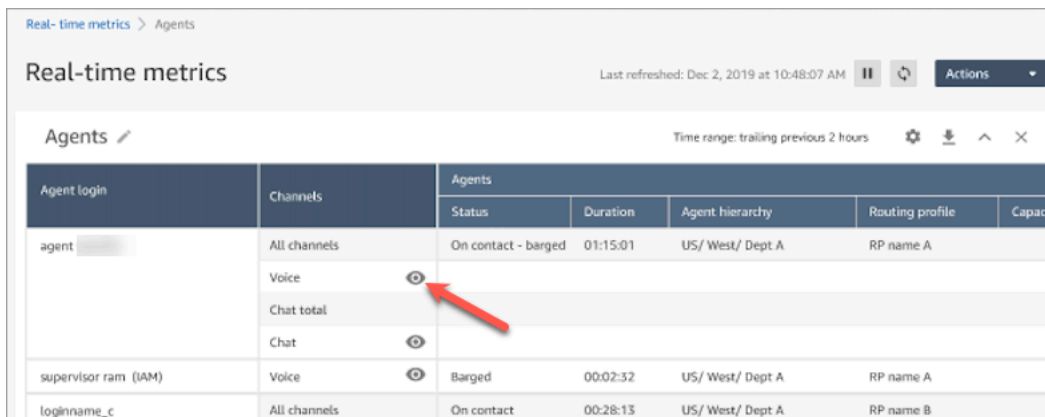

Agents		Agents				
Agent login	Channels	Status	Duration	Agent hierarchy	Routing profile	Capac
agent	All channels	On contact - barged	01:15:01	US/ West/ Dept A	RP name A	
	Voice					
	Chat total					
	Chat					
supervisor ram (IAM)	Voice	Barged	00:02:32	US/ West/ Dept A	RP name A	
loginname_c	All channels	On contact	00:28:13	US/ West/ Dept A	RP name B	

5. This takes you to the open CCP, as shown in the following image. You can monitor the call and toggle between the **Monitor** and **Barge** states. The following image shows the **Monitor** state.

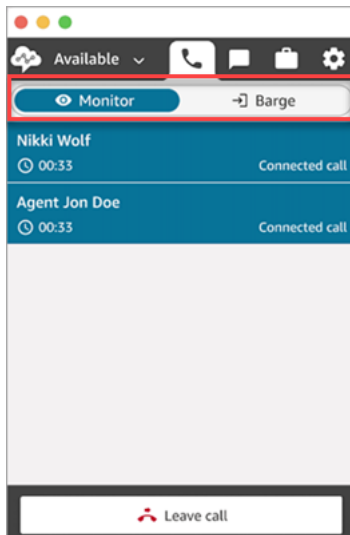

Barge live chats with contacts

1. Log in to the Amazon Connect admin website at https://instance_name.my.connect.aws/. Use an account that is assigned the **CallCenterManager** security profile or that has the required security profile permissions.
2. Open your CCP. It must be open before you can barge a chat.
3. On the Amazon Connect admin website navigation menu, choose **Analytics and optimization, Real-time metrics, Agents**.
4. Choose the eye icon that appears next to the **Chat** channel of the agent that you want to monitor, as shown in the following image. You can barge into a conversation that you had been monitoring already.

Real-time Metrics

Agents 

Agent Login	Channels	Agent				
		Activity	Next activity	Duration	Agent Hierarchy	Routing Profile
Agent1	All channels	On contact ▾	-	00:01:02	-	Basic Routing Profile
	Voice					
	Chat total					
	Chat 					
	Task					
Supervisor1	All channels	Available ▾	-	00:00:06	-	Basic Routing Profile
	Voice					
	Chat total					
	Task					

- This takes you to the open CCP, as shown in the following image. You can monitor the chat conversation and toggle between the **Monitor** and **Barge** states. The following image shows the **Monitor** state.

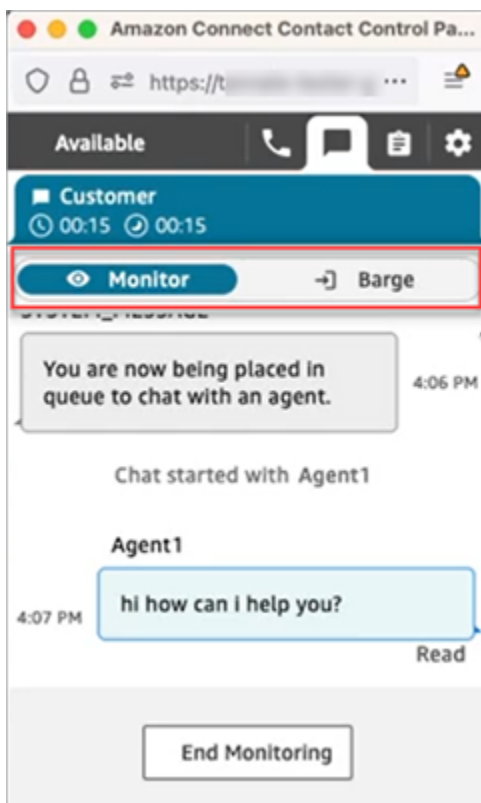

Following is an example of what the CCP looks like when a supervisor barges into a chat.

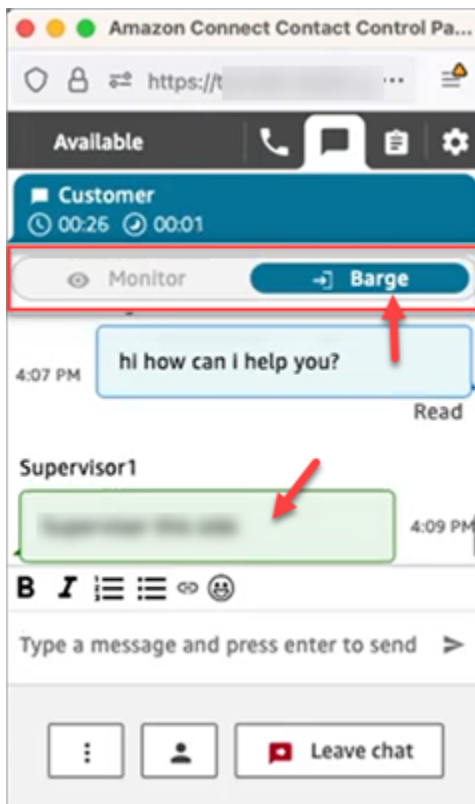

Review recorded conversations between agents and customers using Amazon Connect

Managers can review past conversations between agents and customers. To set this up, you need to [set up recording behavior](#), assign managers the appropriate permissions, and then show them how to access the recorded conversations.

When is a conversation recorded? A conversation is recorded only when the contact is connected to an agent. The contact is not recorded before then, when they are connected to the IVR or a Lex bot. If the call is transferred externally, the call recording stops when the agent drops from the call. For detailed information about call recording behavior, see [Set up recording behavior](#)

Tip

When call recording is enabled, the recording is placed in your S3 bucket shortly after the contact is disconnected. Then the recording is available for you to review it using the steps in this article.

You can also access the recording from the customer's [contact record](#). The recording is available in the contact record, however, only after the contact has left the [After Contact Work \(ACW\) state](#).

How do I manage access to recordings? Use the **Recorded conversations (unredacted)** security profile permission to manage who can listen to recordings, and access the corresponding URLs that are generated in S3. For more information about this permission, see [Assign permissions to review recordings of past conversations](#).

Assign permissions to review recordings of past conversations

Assign the **CallCenterManager** security profile so a user can listen to call recordings or review chat transcripts. This security profile also includes a setting that makes the icon to download recordings appear in the results of the **Contact search** page. The following image shows the recording play, download, and delete icons that are displayed to a user who has these permissions.

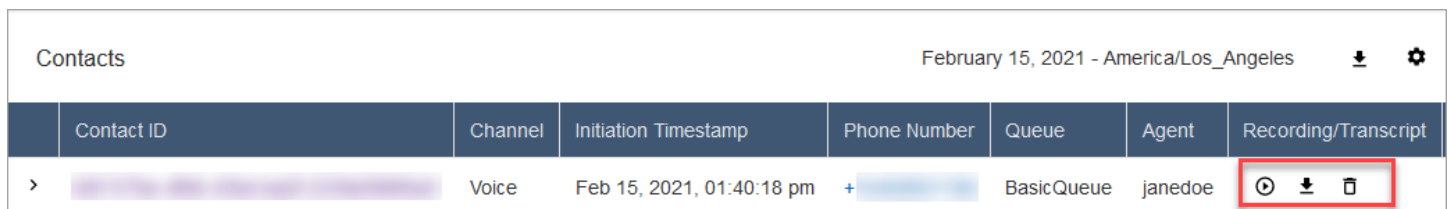

Contact ID	Channel	Initiation Timestamp	Phone Number	Queue	Agent	Recording/Transcript
> [Redacted]	Voice	Feb 15, 2021, 01:40:18 pm	+ [Redacted]	BasicQueue	janedoe	🔍 ⬇️ 🗑️

Or, assign the following individual permissions.

- Contact search:** This permission is required so users can access the **Contact search** page, which is where they can search contacts so they can listen to recordings and review transcripts.
- Restrict contact access:** Manage access to results on the **Contact search** page based on their agent hierarchy group.

For example, agents who are assigned to AgentGroup-1 can only view contact trace records (CTRs) for contacts handled by agents in that hierarchy group, and any groups below them. (If they have permissions for **Recorded conversations**, they can also listen to call recordings and view transcripts.) Agents assigned to AgentGroup-2 can only access CTRs for contacts handled by their group, and any groups below them.

Managers and others who are in higher level groups can view CTRs for contacts handled by all the groups below them, such as AgentGroup-1 and 2.

For this permission, **All = View** since **View** is the only action granted.

For more information about hierarchy groups, see [Set up agent hierarchies](#).

Note

When you change a the hierarchy group of a user, it may take a couple of minutes for their contact search results to reflect their new permissions.

3. **Recorded conversations (redacted)**: If your organization uses Contact Lens for Amazon Connect, you can assign this permission so agents access only those call recordings and transcripts in which sensitive data has been removed.

The redaction feature is provided as part of Contact Lens for Amazon Connect. For more information, see [Use sensitive data redaction](#).

4. **Manager monitor**: This permission allows users to monitor live conversations and listen to recordings.

Tip

Be sure to assign managers to the **Agent** security profile so they can access the Contact Control Panel (CCP). This enables them can monitor the conversation through the CCP.

5. **Recorded conversations (unredacted)**: If your organization isn't using Contact Lens for Amazon Connect, use this permission to manage who can access recordings on the **Details** page, through corresponding URLs that are generated in S3. From there, these users can delete recordings.

Note the following:

- To restrict access to recordings, ensure users do not have **Analytics and Optimization - Recorded conversations (unredacted) - Access** permissions, as shown in the following image.

Type	All	Access
Access metrics	<input type="checkbox"/>	<input type="checkbox"/>
Agent login	<input type="checkbox"/>	<input type="checkbox"/>
Manager monitor	<input type="checkbox"/>	<input type="checkbox"/>
Recorded conversations (unredacted)	<input type="checkbox"/>	<input type="checkbox"/>
Saved reports	<input type="checkbox"/>	<input type="checkbox"/>

- If users do not have **Recorded conversations** permission—or they're not logged in to Amazon Connect—they cannot listen to the call recording or view the chat transcript, or access the URL in S3, even if they know how the URL is formed.
- The **Enable download button** permission controls only whether the download button appears in the user interface. It does not control access to the recording.
- To enable a user to delete recordings, choose the **Delete** permission. To view the **Delete** button in the Amazon Connect admin website, you need the **Enable download button** permission. The **Enable download button** permissions are granted by default when you assign the **Delete** permission.

Review recordings/transcripts of past conversations







These are the steps that a manager does to review past recordings/transcripts of conversations.

1. Log in to Amazon Connect with a user account that has [permissions to access recordings](#).
2. In Amazon Connect choose **Analytics and optimization, Contact search**.
3. Filter the list of contacts by date, agent login, phone number, or other criteria. Choose **Search**.







Tip

We recommend using the **Contact ID** filter to [search for recordings](#). This is the best way to ensure you get the right recording for the contact. Many recordings have the same name as the contact ID, but not all.

4. Conversations that were recorded have icons in the **Recording/Transcript** column, as shown in the following image. If you don't have the appropriate permissions, you won't see these icons.

Contact ID	Channel	Initiation Timestamp	Phone number	Queue	Agent	Recording/Transcript
b3	Voice	2/3/20 7:02 PM	+1 5	BasicQueue		  
eb7	Voice	2/3/20 7:04 PM	+1 5	BasicQueue		  

5. To listen to a recording of a voice conversation, or read the transcript of a chat, choose the **Play** icon, as shown in the following image.

Contact ID	Channel	Initiation Timestamp	Phone number	Queue	Agent	Recording/Transcript
b3	Voice	2/3/20 7:02 PM	+1 5	BasicQueue		  
eb7	Voice	2/3/20 7:04 PM	+1 5	BasicQueue		  

6. If you choose the play icon for a transcript, it appears, as shown in the following image.

Chat Transcript ✕

87e3d13a-4

Customer has joined the conversation

Customer 01:19 AM
Hello Agent

01:19 AM

Jane has joined the conversation

Jane 01:19 AM
Hello

Customer 01:19 AM
I'm

01:21 AM

Customer has left the conversation

01:21 AM

Pause, rewind, or fast-forward a recording

Use the following steps to pause, rewind, or fast-forward a voice recording.

1. On the **Contact search** results, instead of choosing the **Play** icon, choose the contact ID to open the contact record.

Contacts							February 15, 2021 - Am
Contact ID	Channel	Initiation Timestamp	Phone Number	Queue	Agent	Recording/Transcript	
> bf2157b...	Voice	Feb 15, 2021, 01:40:18 pm	+1	BasicQueue	janedoe		

- On the **Contact record** page, there are more controls to navigate the recording, as shown in the following image.

Contact Trace Record

Contact Summary

Contact Id	[Redacted]
Channel	Voice
Initiation Method	Inbound
Media Streams	[AUDIO]
Start and end time	Feb 15, 21, 01:40:18 pm - 01:42:11 pm
Duration	00:01:53
Customer number	+1 [Redacted]
Agent	Doe Jane
Queue	BasicQueue
Last Updated	Feb 15, 21, 01:43:20 pm

Recording

Timeline: 00:00 / 01:05

Speed: 1x (dropdown menu: 0.5, 1x, 2x, 3x)

Playback controls: Play, Pause, Skip Backwards (10s), Skip Forwards (10s)

Annotations: 'a' points to the timeline, 'b' points to the speed dropdown, 'c' points to the playback controls.

- Click or tap to the time you want to investigate.
- Adjust the playing speed.
- Play, pause, skip backwards or forwards in 10 second increments.

Troubleshoot problems pausing, rewinding, or fast-forwarding

If you are unable to pause, rewind or fast-forward recordings on the **Contact search** page, one possible reason could be that your network is blocking HTTP range requests. See [HTTP range requests](#) on the MDN Web Docs site. Work with your network administrator to unblock HTTP range requests.

Download recordings/transcripts of past conversations

These are the steps that a manager does to download past recordings or transcripts of conversations.

- If the contact reached you by phone call (the Voice channel), you can download a .wav file.
- If the contact reached you by chat (the Chat channel), you can download a .json file.







Tip

To have Amazon Connect create transcripts of phone calls, see the Contact Lens feature.







Download a voice recording as a .wav file

1. Log in to the Amazon Connect admin website with a user account that has [permissions to access recordings](#).
2. In Amazon Connect choose **Analytics and optimization, Contact search**.
3. Filter the list of contacts by date, agent login, phone number, or other criteria. Choose **Search**.
4. Conversations that were recorded have icons in the **Recording/Transcript** column. If you don't have the appropriate permissions, you won't see these icons.

The following image shows what the icons look like for a voice recording. Note the play icon that indicates it's a voice recording.







Contact ID	Channel	Initiation Timestamp	Phone number	Queue	Agent	Recording/Transcript
b3	Voice	2/3/20 7:02 PM	+1 5	BasicQueue		  
eb7	Voice	2/3/20 7:04 PM	+1 !	BasicQueue		  

5. Choose the **Download** icon, as shown in the following image.

Contact ID	Channel	Initiation Timestamp	Phone number	Queue	Agent	Recording/Transcript
b3	Voice	2/3/20 7:02 PM	+1 5	BasicQueue		  
eb7	Voice	2/3/20 7:04 PM	+1 5	BasicQueue		  

- A voice recording is saved automatically to your **Downloads** folder as a .wav file.

The following image shows a list of .wav files in a Downloads folder. The name of the .wav file is the contact ID.



Name	Date	Type
 b3	2/3/2020 11:08 AM	WAV File
 24	11/30/2019 6:39 PM	WAV File
 2b	7/1/2019 1:49 PM	WAV File
 2b	7/1/2019 1:50 PM	WAV File
 1ff	11/30/2019 6:16 PM	WAV File
 0b	11/24/2019 2:03 PM	WAV File

Tip

In the recording, you may hear only the agent, only the customer, or both the agent and customer. This is determined by how the [Set recording and analytics behavior](#) block is [configured](#).

Download a chat transcript as a .json file

- The following image shows what the icons look like for a chat transcript.

Contact ID	Channel	Initiation timestamp	System phone number	Queue	Agent	Recording/Transcript
51d3324f-80f6-4fa9-...	Chat	Mar 3, 2023, 02:04:22 pm		BasicQueue	janedoe	  

A chat transcript is saved to the Downloads folder as a .json file.

The following image shows a .json file in the Downloads folder. The name of the .json file is the contact ID.

Name	Date modified	Type
Today (1)		
 51d3	3/3/2023 2:07 PM	JSON File

2. To view a downloaded chat transcript, right-click the .json file, and then open it with another app that enables you to view the contents in a readable format.

The following image shows a sample downloaded transcript that has been opened using Firefox. The image shows the middle of the transcript, where the agent and customer are chatting.

```
▼ 5:
  AbsoluteTime:    "2023-03-03T22:04:49.279Z"
  Content:         "Hi, I want to reset my password. Can you help? "
  ContentType:     "text/markdown"
  Id:              "926d64c9-6ae5-4232-97e2-7bcfb0012f3c"
  Type:           "MESSAGE"
  ParticipantId:   "ce936013-38b5-46ef-9e07-77ef8e5eb0fb"
  DisplayName:     "Customer"
  ParticipantRole: "CUSTOMER"
▼ 6:
  AbsoluteTime:    "2023-03-03T22:04:58.847Z"
  Content:         "Yes, I can help you with that. "
  ContentType:     "text/markdown"
  Id:              "603489ea-eea0-41dd-bec0-7581b1695ec2"
  Type:           "MESSAGE"
  ParticipantId:   "5765c887-5f21-4184-b7ed-5c7cf9bb88ae"
  DisplayName:     "Jane"
  ParticipantRole: "AGENT"
▼ 7:
  AbsoluteTime:    "2023-03-03T22:05:27.756Z"
  Content:         "Go to your Amazon Connect login page"
  ContentType:     "text/markdown"
  Id:              "adf115f6-cec6-4833-9ea5-492bcdcb182"
  Type:           "MESSAGE"
  ParticipantId:   "5765c887-5f21-4184-b7ed-5c7cf9bb88ae"
  DisplayName:     "Jane"
  ParticipantRole: "AGENT"
```

Events in a chat transcript

If you have a process that consumes events in S3 transcripts, note that chat transcripts contain the following event content types if the event has occurred during the chat session:

- application/vnd.amazonaws.connect.event.participant.left
- application/vnd.amazonaws.connect.event.participant.joined
- application/vnd.amazonaws.connect.event.chat.ended
- application/vnd.amazonaws.connect.event.transfer.succeeded
- application/vnd.amazonaws.connect.event.transfer.failed

Search for recordings by contact ID

To find a recording of a specific contact, you only need the contact ID. You don't need to know the date range, agent, or any other information about the contact.







Tip

We recommend using the contact ID to search for recordings.

Even though many call recordings for specific contact IDs may be named with the contact ID prefix itself (for example, 123456-aaaa-bbbb-3223-2323234.wav), there is no guarantee that the contact IDs and name of the contact recording file always match. By using **Contact ID** for your search on the **Contact search** page, you can find the correct recording by referring the audio file on the contact's record.

To search for recordings

1. Log in to Amazon Connect with a user account that has [permissions to access recordings](#).
2. In Amazon Connect choose **Analytics and optimization, Contact search**.
3. In the **Contact ID** box, enter the contact ID, and then choose **Search**.
4. Conversations that were recorded have icons in the **Recording/Transcript** column. The following image shows the play, download, and delete icons. If you don't have the appropriate permissions, you won't see these icons.

Contact ID	Channel	Initiation Timestamp	Phone number	Queue	Agent	Recording/Transcript
b3	Voice	2/3/20 7:02 PM	+1 5	BasicQueue		  
eb7	Voice	2/3/20 7:04 PM	+1 !	BasicQueue		  

To learn more about searching, see [Search for contacts](#).

Troubleshoot monitoring agent conversations with Amazon Connect

The following table explains how to resolve error messages (exception messages) that may be displayed when you use Amazon Connect to monitor live agent conversations with contacts.

Error message	Resolution	Exception type	Exception code
You do not have access to the agent. Contact your admin to learn more.	You must enable the the service linked role for the instance. See Use service-linked	AccessDeniedException	403

Error message	Resolution	Exception type	Exception code
	roles for Amazon Connect for information about enabling the role.		
One or more of the input parameters are invalid	A developer needs to make sure that the input parameters for the <code>MonitorContact</code> action are valid. See MonitorContact Request Syntax .	<code>InvalidRequestException</code>	400
Monitoring failed, please enable call recording	In the flow, make sure that the Set recording and analytics behavior block is configured to allow call recording for both the agent and customer.	<code>InvalidRequestException</code>	400

Error message	Resolution	Exception type	Exception code
User's phone number is invalid	<p>Check that the phone number associated with the agent's deskphone meets following requirements:</p> <ol style="list-style-type: none">1. It is a valid phone number.2. It is in the required E164 format. To express a US phone number in E.164 format, add the '+' prefix and the country code in front of the number. For example, for a US number +1-800-555-1212. A number such as 020 718 xxxxx in the UK would be formatted as +44 20 718 xxxxx.3. It is in the list of countries that Amazon Connect can call. For a list of countries allowed by default, see Countries you can call by default.	InvalidRequestException	400

Error message	Resolution	Exception type	Exception code
	<p>For example, your Amazon Connect instance is in the US East (N. Virginia) Region. Your agent has a deskphone in Germany, which is not a country that Amazon Connect can call by default. By default the agent's deskphone would not be configured correctly to start the monitoring session so they would get an error. You would need to submit a service quota increase request to add Germany to your list of allowed countries that Amazon Connect can call.</p> <p>4. The queue that is associated with the agent's routing profile has an outbound caller ID number assigned</p>		

Error message	Resolution	Exception type	Exception code
	to it. For instructions for setting the outbound caller ID number, see Set up outbound caller ID .		
The contact or agent is not in the state that can be monitored	The contact is not in an active state. The agent or customer may have disconnected from the call or chat before the monitoring request could be processed. Choose another contact to monitor.	InvalidRequestException	400
Monitoring failed, please enable multi party conferencing feature	The Amazon Connect instance must have the multi-party calls and enhanced monitoring feature enabled. In your instance settings, choose Enable Multi-Party Calls and Enhanced Monitoring . For instructions, see Update instance settings .	InvalidRequestException	400

Error message	Resolution	Exception type	Exception code
No AGENT participant found in the contact	The call or chat doesn't have an active agent who is connected to it and working on the contact. Choose another contact to monitor.	InvalidRequestException	400
MonitorContact is not supported for TASK contacts	The monitoring feature is supported only for voice and chat contacts. Choose a voice or chat contact to monitor.	InvalidRequestException	400
AllowedMonitorCapabilities must be provided and have SILENT_MONITOR value at the least	If your Amazon Connect instance has the multi-party calls and enhanced monitoring feature enabled, the developer must make sure to pass the AllowedMonitorCapabilities input parameter with at least the SILENT_MONITOR value set. See MonitorContact Request Syntax .	InvalidRequestException	400

Error message	Resolution	Exception type	Exception code
One or more of the request resources were not found	A developer needs to make sure that the resources in the <code>MonitorContact</code> input request that's being passed exist in the Amazon Connect instance.	<code>ResourceNotFoundException</code>	404
Internal service exception	The request processing has failed because of an unknown error, exception, or failure with an internal server. Wait a bit and then try again to monitor the contact.	<code>InternalServerError</code>	500
Service quota has been exceeded	There are certain limits on how many contacts a supervisor can monitor at a time or how many supervisors can monitor one contact. Check the limits for the voice and chat contacts on the Amazon Connect feature specifications page.	<code>ServiceQuotaExceededException</code>	402

Error message	Resolution	Exception type	Exception code
Another request with same clientToken is in progress	In the MonitorContact action, a ClientToken is a unique, case-sensitive identifier that developers provide to ensure the idempotency of the request. If not provided, the AWS SDK populates this field. For more information about idempotency, see Making retries safe with idempotent APIs .	IdempotencyException	409
Access denied	You don't have the appropriate permissions in your security profile to perform this action. For a list of the security profile permissions required for monitoring conversations see Assign permissions to monitor live conversations .	AccessDeniedException	403

Error message	Resolution	Exception type	Exception code
Too Many Requests	The API TPS quotas have been exceeded. Submit a request for a TPS quota increase. For instructions, see Requesting a quota increase .	ThrottlingException	429

Manage contacts from the Contact details page

On the **Contact details** page of an in-progress contact, you can manage a contact by transferring, rescheduling, or ending the contact.

You can also perform these actions programmatically using the [TransferContact](#), [UpdateContactSchedule](#), and [StopContact](#) operations.

This section explains how to transfer, reschedule, and end contacts by using the Amazon Connect admin website.

Contents

- [Transfer contacts from the Contact details page](#)
- [Reschedule contacts from the Contact details page](#)
- [End contacts from the Contact details page](#)

Transfer contacts from the Contact details page

On the **Contact details** page of an in-progress contact, you can transfer a contact to a quick connect agent or queue. This capability is currently supported only for task contacts.

To transfer contacts programmatically, use the [TransferContact](#).

Required permissions

1. Enable one of the following permissions to view contacts on the **Contact search** and **Contact details** pages:

- a. **Contact search - View:** Allows a user to view all contacts
 - b. **View my contacts - View:** Allows agents to view contacts that they themselves had handled
2. **Restrict contact access (Optional):** Restrict a user's access to contacts on the **Contact search** and **Contact details** pages within their own hierarchy group or any hierarchy groups below them. For more information about this permissions, see [Manage who can search for contacts and access detailed information](#).
 3. **Transfer Contact:** Enables a user to transfer contacts on the **Analytics & Optimization** pages. The following image shows the **Contact Actions - Transfer Contact** permission.

Contact Actions	
This group gives access to perform actions on contacts within the Analytics & Optimization pages such as Contact Search, Contact Details, and Real-time Metrics	
Type	Enable
Transfer Contact ⓘ	<input checked="" type="checkbox"/>
End contact ⓘ	<input type="checkbox"/>
Reschedule contact ⓘ	<input type="checkbox"/>

How to transfer a contact

1. Log in to Amazon Connect with a user account that has [permissions to access contact records](#).
2. In Amazon Connect choose **Analytics and optimization, Contact search**.
3. Search for an in-progress task contact to transfer:
 - a. Select the **Contact status** filter and set it to **In progress**, as shown in the following image.

Contact search

Saved searches

Filters

Time range: Initiated timestamp September 7, 2023 - September 11, 2023

Channel Task

Contact status In progress

Add filter

Contacts

Contact ID	Channel	Contact status	Initiation timestamp	System phone number	Queue	Agent	Recording/Transcription
b925dcf...	Task	In progress	Sep 11, 2023, 11:25:42 am				
c2182f9...	Task	In progress	Sep 8, 2023, 04:50:51 pm				

- b. Set the **Channel** filter to **Tasks** to view only task contacts.
 - c. Choose the task contact to view its details.
4. On the **Contact details** page for the task contact, choose **Actions, Transfer**.

Contact details

In progress | Last updated: Sep 11, 2023, 11:25:46 am | b925dcf4-1391-42ee-9ac3-15f94b89c6fd

Actions

Transfer

End

Overview

Task | Start time: 11:25 am, Sep 11, 2023 | Original contact | Previous contact

5. Select an agent or queue from a list of your quick connects and choose **Transfer**.
6. When the contact is transferred successfully, the page automatically refreshes with the **Next contact** link to the contact created as a result of the transfer. The following image shows the location of the **Next contact** link.

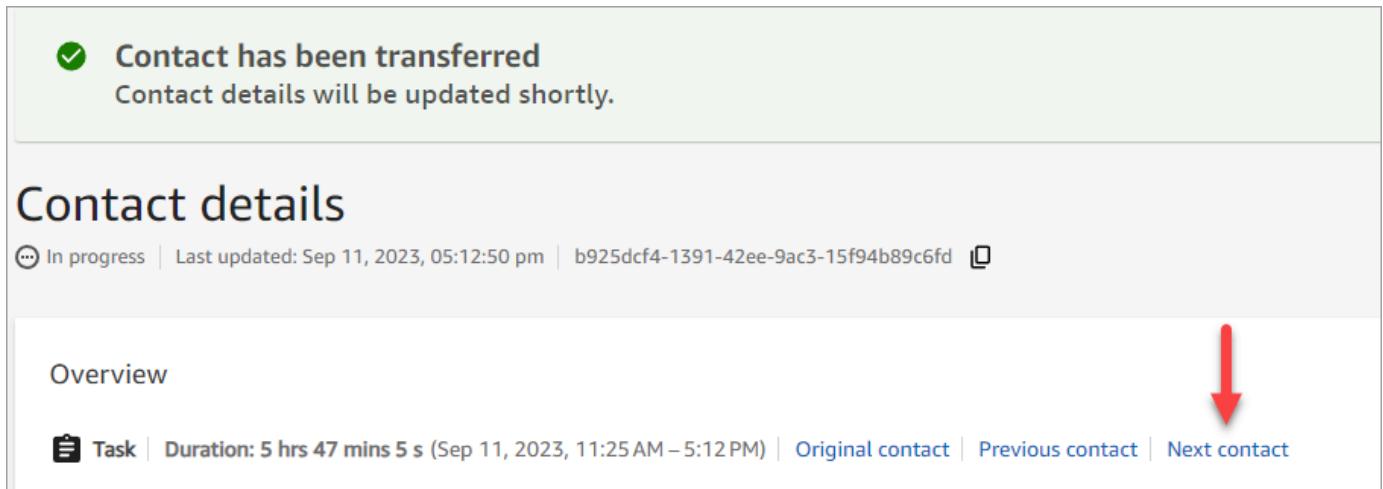

The screenshot shows a notification at the top: a green checkmark icon followed by the text "Contact has been transferred" and "Contact details will be updated shortly." Below this is the "Contact details" section, which includes a status of "In progress", a timestamp "Last updated: Sep 11, 2023, 05:12:50 pm", and a contact ID "b925dcf4-1391-42ee-9ac3-15f94b89c6fd". Underneath is an "Overview" section with a "Task" icon and a duration of "5 hrs 47 mins 5 s (Sep 11, 2023, 11:25 AM – 5:12 PM)". At the bottom, there are three links: "Original contact", "Previous contact", and "Next contact". A red arrow points down to the "Next contact" link.

Reschedule contacts from the Contact details page

On the **Contact details** page of an in-progress contact, you can reschedule a contact that was previously scheduled. This capability is currently supported only for task contacts.

To reschedule contacts programmatically, use the [UpdateContactSchedule](#).

Required permissions

1. Enable one of the following permissions to view contacts on the **Contact search** and **Contact details** pages:
 - a. **Contact search - View**: Allows a user to view all contacts
 - b. **View my contacts - View**: Allows agents to view contacts that they themselves had handled
2. **Restrict contact access** (Optional): Restrict a user's access to contacts on the **Contact search** and **Contact details** pages within their own hierarchy group or any hierarchy groups below them. For more information about this permissions, see [Manage who can search for contacts and access detailed information](#).
3. **Reschedule contact**: Enables a user to reschedule contacts on the **Analytics & Optimization** pages. The following image shows the **Contact Actions - Reschedule contact** permission.

Contact Actions	
This group gives access to perform actions on contacts within the Analytics & Optimization pages such as Contact Search, Contact Details, and Real-time Metrics	
Type	Enable
Transfer Contact ⓘ	<input type="checkbox"/>
End contact ⓘ	<input type="checkbox"/>
Reschedule contact ⓘ	<input checked="" type="checkbox"/>

How to reschedule a contact

1. Log in to Amazon Connect with a user account that has [permissions to access contact records](#).
2. In Amazon Connect choose **Analytics and optimization, Contact search**.
3. Search for an in-progress task contact to reschedule:
 - a. Select the **Contact status** filter and change the selected value to **In progress**.
 - b. Select the **Time range** filter. Set the **Timestamp type** to **Scheduled** to view only scheduled contacts. Filter for the time range. The following image shows these filters.

The screenshot shows the 'Contact search' interface. Under the 'Filters' section, three filters are applied: 'Time range: Scheduled timestamp' (with a date range of September 11, 2023 - September 15, 2023), 'Channel: Task', and 'Contact status: In progress'. Red arrows point to each of these filter boxes. The 'Contacts' table below shows one result with the following details:

Contact ID	Channel	Contact status	Initiation timestamp	System phone number	Queue	Agent	Recording/Transcript
c2182f9...	Task	In progress	Sep 8, 2023, 04:50:51 pm				

4. Choose the scheduled contact to view its details.
5. On the **Contact details** page of the task contact, choose **Actions, Reschedule**, as shown in the following image.

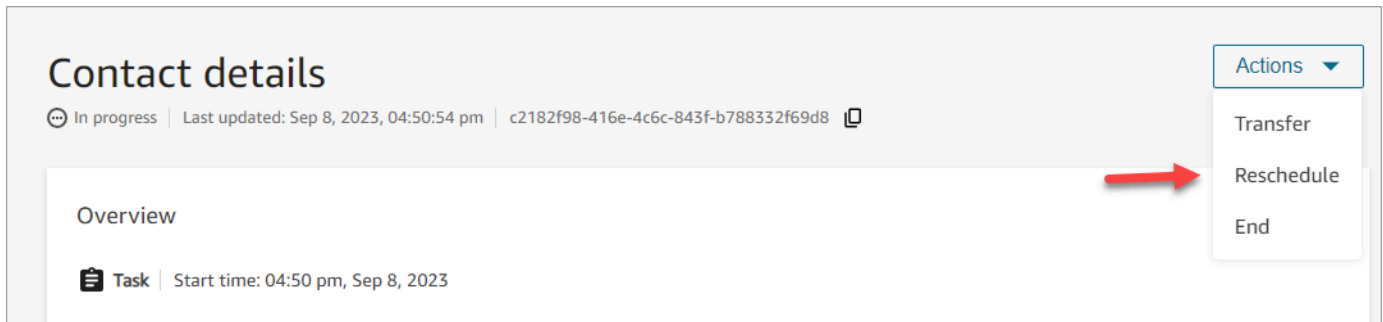

6. Select the time and range to reschedule the contact. The scheduled time must be within 6 days of when the task was initiated.
7. When the contact is rescheduled successfully, the page automatically refreshes with the new schedule time for the task.

End contacts from the Contact details page

On the **Contact details** page of an in-progress contact, you can end a contact. Ending a contact results in the contact being disconnected. If the contact was already connected to an agent, ending the contact starts After Contact Work (ACW) for the contact.

To end contacts programmatically, use the [StopContact](#).

Important things to know

- If you end a task contact after ACW is in progress, the contact is terminated. Voice and chat contacts that are in ACW state cannot be terminated by performing **End contact** action on the **Contact details** page.
- You cannot end voice contacts when they are initiated using the following methods:
 - DISCONNECT
 - TRANSFER
 - QUEUE_TRANSFER
- You can end chat and task contacts regardless of how they were initiated.

Required permissions

1. Enable one of the following permissions to view contacts on the **Contact search** and **Contact details** pages:

- a. **Contact search - View:** Allows a user to view all contacts.
 - b. **View my contacts - View:** Allows agents to view contacts that they themselves had handled.
2. **Restrict contact access (Optional):** Restrict a user's access to contacts on the **Contact search** and **Contact details** pages within their own hierarchy group or any hierarchy groups below them. For more information about this permissions, see [Manage who can search for contacts and access detailed information](#).
 3. **End Contact:** Enables a user to end contacts on the **Analytics & Optimization** pages. The following image shows the **Contact Actions - End contact** permission.

Contact Actions	
This group gives access to perform actions on contacts within the Analytics & Optimization pages such as Contact Search, Contact Details, and Real-time Metrics	
Type	Enable
Transfer Contact ⓘ	<input type="checkbox"/>
End contact ⓘ	<input checked="" type="checkbox"/>
Reschedule contact ⓘ	<input type="checkbox"/>

How to end an in-progress contact

1. Log in to Amazon Connect with a user account that has [permissions to access contact records](#).
2. In Amazon Connect choose **Analytics and optimization, Contact search**.
3. Select the **Contact status** filter and change the selected value to **In progress**.
4. Choose an in-progress contact to view its details.
5. On the **Contact details** page choose **Actions, End**.



6. Confirm the action to end the contact by choosing **End**.
7. When the contact is ended successfully, the page automatically refreshes.

Use Customer Profiles

To help agents deliver more efficient and personalized customer service, Amazon Connect enables you to combine information from external applications, such as Salesforce, Zendesk, ServiceNow, or other Customer relationship management (CRM) products, with contact history from Amazon Connect. This creates a customer profile that has all the information agents need during customer interactions in a single place.

With a single view of customer information including their product, case, and contact history, agents can quickly confirm the customer's identity and determine the reason for the call or chat.

Currently, Amazon Connect Customer Profiles can be used in compliance with [GDPR](#) and is pending additional certifications held by Amazon Connect.

The following image shows the agent workspace; for the purposes of this documentation, an Amazon Connect Customer Profiles image is featured. The agent workspace is designed for efficient multi-tasking, enabling simultaneous handling of calls, chats, and tasks, while providing quick access to customer profile information all within the same browser window.

The screenshot displays the Amazon Connect agent workspace. On the left, there is a chat window for Sofia Martinez. The main area shows the Customer Profile for Sofia Martinez, which includes the following information:

- Full name:** Sofia Martinez
- Profile ID:** ec8a6...
- Phone number:** +12223334444
- Account number:** 111-222-333
- Date of birth:** 1997-07-09
- Additional info:** Gold member
- Email address:** Sofia-Martinez@gmail.com
- Gender:** FEMALE
- Mailing address:** 111 Any street, Any Town, Alaska, US, 11123
- Billing address:** 111 Any street, Any Town, Alaska, US, 11123

Below the profile information, there are four tabs: **Cases** (highlighted with a red circle and the number 1), **More information** (highlighted with a red circle and the number 2), **Contact history** (highlighted with a red circle and the number 3), and **Product Purchase History** (highlighted with a red circle and the number 4). The **Recent cases** table is shown below the tabs:

Status	Reference Id	Title	Source	Updated date	More
open	06589632	Package missing	Connect Case	4/11/23	>>
closed	79440119	Order missing item	Connect Case	4/11/23	>>
open	88416438	Package Missing	Connect Case	4/11/23	>>

1. **Cases:** Status, reference Id, title, source, updated date, and more information related to cases ingested from 3P application such as Zendesk and ServiceNow, in addition to cases created and managed using Amazon Connect Cases.

2. **More information:** Additional information contained in the customer defined *Attributes* field of [the profile](#), as well as further profile information such as cell phone number and shipping address. This information will be sorted alphabetically to help an agent quickly locate the information they need.
3. **Contact history:** Date, times, and duration when this customer contacted your contact center in the past.
4. **Product purchase history:** All the assets purchased by a customer can be populated here. The data is ingested from an external app such as Salesforce or Zendesk that you've [integrated](#) with Customer Profiles.

What is a customer profile in Amazon Connect?

A *customer profile* is a record that stores contact history combined with information about customers, such as account number, additional information, birth date, email, multiple addresses, name, and party type.

After you enable Amazon Connect Customer Profiles, a unique customer profile is created for every contact. This allows you to create a customer profile that has all the information agents need during customer interactions in a single place at no charge.

To access customer profiles in your flows, use the [Customer profiles](#) block. [Agents access customer profiles](#) in their agent workspace.

You can use the paid features of Customer Profiles to enrich your customer profiles by [ingesting data from external applications](#). See [pricing](#) for details.

You can also add custom fields and objects to the customer profiles by using the [Amazon Connect Customer Profiles APIs](#).

How is customer profile data stored?

Amazon Connect stores contact history in unique customer profiles. It parses data ingested from external applications and stores it as customer profile attributes.

Amazon Connect does not replace or update the data in the external application. If a data source is removed, the data from the external application is no longer available in the customer profile for every voice contact.

For information about how customer profile data are secured, see [Data protection in Amazon Connect](#).

For more information about how to access the data that is stored in a customer profile, see [Access Customer Profiles in the agent workspace](#) or [Use the Customer Profiles API](#).

Enable Customer Profiles for your instance

Amazon Connect provides pre-built integrations so you can quickly combine customer information from multiple external applications, with contact history from Amazon Connect. This allows you to create a customer profile that has all the information agents need during customer interactions in a single place.

Before you begin

Following is an overview of key concepts and the information that you'll be prompted for during the setup process.

About the customer profiles domain

When you enable Amazon Connect Customer Profiles, you create a customer profiles domain: a container for all data, such as customer profiles, object types, profile keys, and encryption keys. Following are guidelines for creating Customer Profile domains:

- Each Amazon Connect instance can only be associated with one domain.
- You can create multiple domains, but they don't share external application integrations or customer data between each other.
- All the external application integrations you create are at a domain level. All of the Amazon Connect instances associated with a domain inherit the domain's integrations.
- You can change the association of your Amazon Connect instance from your current domain to a new domain at any time, by choosing a different domain. This isn't recommended, however, because the customer profiles from the earlier domain won't be moved to the new domain.

How do you want to name your customer profiles domain?

When you enable customer profiles, you are prompted to provide a friendly domain name that's meaningful to you such as your organization name, for example, *CustomerProfiles-ExampleCorp*. You can change the friendly name using the API at any time.

Do you want to use a dead-letter queue?

A dead-letter queue is used for reporting errors associated with processing data from external applications.

Amazon AppFlow handles connecting to the external application and moving data from it to Amazon Connect Customer Profiles. Amazon Connect then processes the file.

- If an error occurs during the connection or while transporting the data to Amazon Connect, Amazon AppFlow surfaces the error but it doesn't write the error to the dead-letter queue.

For example, a processing error could be that the external data didn't match the specified schema or that the format of the external data format isn't correct (currently only JSON is supported).

- If Amazon Connect encounters an error while processing the file, it writes the error to your dead-letter queue. You can look at the queue later and try to reprocess the error.
- You might find SQS messages in the dead-letter queue defined with your domain that includes the error message, along with the object.

Error Message	Recommendation
The UNIQUE key or PROFILE key does not exist in the profile object	Modify the data mapping or object, make sure keys marked as UNIQUE and PROFILE in data mapping exist in object. See data mapping page on how to set it up.
Too many objects ingested on profile per second	Too many objects assigned to same profile within short time. You can re-ingest the object or add wait time between calling the PutProfileObject API.
Customer Profiles cannot ingest the object due to the EncryptionKey does not exist in the region, the EncryptionKey does not have a grant for Customer Profiles to use, or the EncryptionKey does not have the GenerateDataKey permission	Check your KMS permission, make sure Customer Profiles has the required access. Follow Enable Customer Profiles, and specify a dead-letter queue and KMS key section.

Error Message	Recommendation
KMS key is invalid	Check your KMS permission, make sure Customer Profiles has the required access. Follow Enable Customer Profiles, and specify a dead-letter queue and KMS key section.
Customer Profiles cannot ingest the object due to invalid KMS key	Check your KMS permission, make sure Customer Profiles has the required access. Follow Enable Customer Profiles, and specify a dead-letter queue and KMS key section.
Your data contains profile object larger than # bytes	Remove any unnecessary fields and reduce data size until it falls below the specified limit mentioned in the error message.
All keys of this object are binding to more than one profiles	Modify the data mapping or object, make sure at least 1 PROFILE key in the object binds to less than or equal to 1 existing profile.

When you enable Customer Profiles, you have the option of specifying an Amazon SQS queue as your dead-letter queue. If you select this option, add the following resource policy to Amazon SQS so Customer Profiles has permissions to send messages to that queue:

```
{
  "Sid": "Customer Profiles SQS policy",
  "Effect": "Allow",
  "Principal": {
    "Service": "profile.amazonaws.com"
  },
  "Action": "SQS:SendMessage",
  "Resource": "arn:aws:sqs:region:accountID:YourQueueName"
}
```

To prevent a confused deputy security issue, see [Amazon Connect Customer Profiles cross-service confused deputy prevention](#) for an example policy to apply.

Step-by-step instructions for creating a dead-letter queue are provided later in this topic, in [Enable Customer Profiles, and specify a dead-letter queue and KMS key](#).

Create a KMS key to be used by Customer Profiles to encrypt data (required)

Note

To maintain access to Customer Profiles APIs, entities using the Customer Profiles profile APIs must have explicit `kms:Decrypt` permissions in their IAM policies. This enables them to utilize `kms:Decrypt` for the KMS key associated with resources retrieved from the API related to Customer Profiles.

When you enable Customer Profiles, you are prompted to create or provide a AWS Key Management Service [KMS key](#). Step-by-step instructions for creating a KMS key are provided later in this topic, in [Enable Customer Profiles, and specify a dead-letter queue and KMS key](#).

All data at rest for Customer Profiles is encrypted under the KMS key you choose. Your customer managed key is created, owned, and managed by you. You have full control over the KMS key (AWS KMS charges apply).

If you choose to set up a KMS key where someone else is the administrator, it must have a policy that allows `kms:GenerateDataKey`, `kms:CreateGrant`, and `kms:Decrypt` permissions to the Customer Profiles service principal. For information about how to change a key policy, see [Changing a key policy](#) in the AWS Key Management Service Developer Guide. In addition, to prevent cross-service impersonation, see [Cross-service confused deputy prevention](#) for sample policies that you should apply.

Enable Customer Profiles, and specify a dead-letter queue and KMS key

1. Open the Amazon Connect console at <https://console.aws.amazon.com/connect/>.
2. On the instances page, choose the instance alias. The instance alias is also your **instance name**, which appears in your Amazon Connect URL. The following image shows the **Amazon Connect virtual contact center instances** page, with a box around the instance alias.

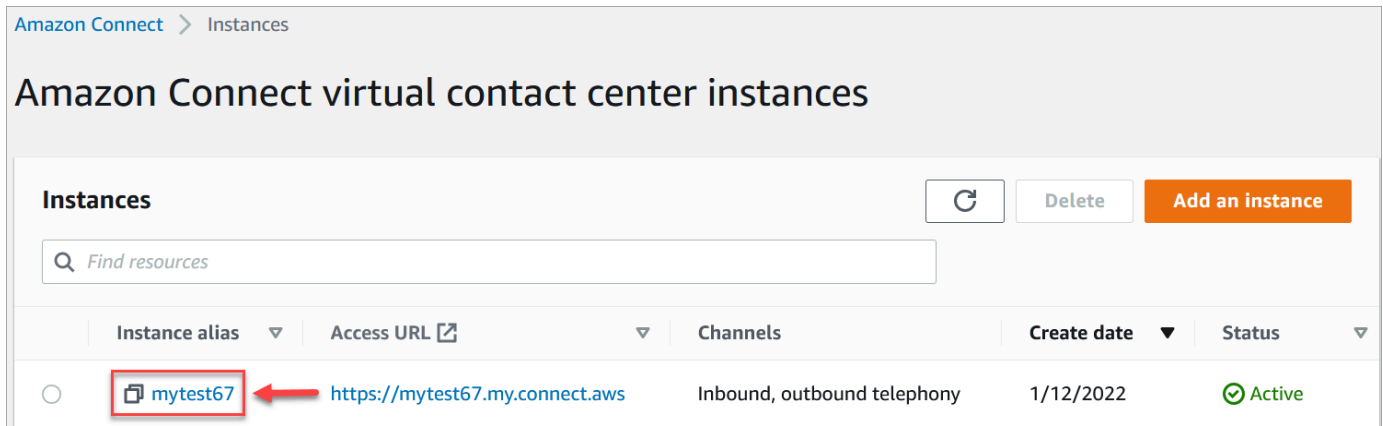

Amazon Connect > Instances

Amazon Connect virtual contact center instances

Instances Refresh Delete Add an instance

Find resources

Instance alias	Access URL	Channels	Create date	Status
mytest67	https://mytest67.my.connect.aws	Inbound, outbound telephony	1/12/2022	Active

3. In the navigation pane, choose **Customer profiles**.

The **Customer profiles domain** page lists the applications that are available for integration. In the following image, the page shows no customer profile domains have been enabled.

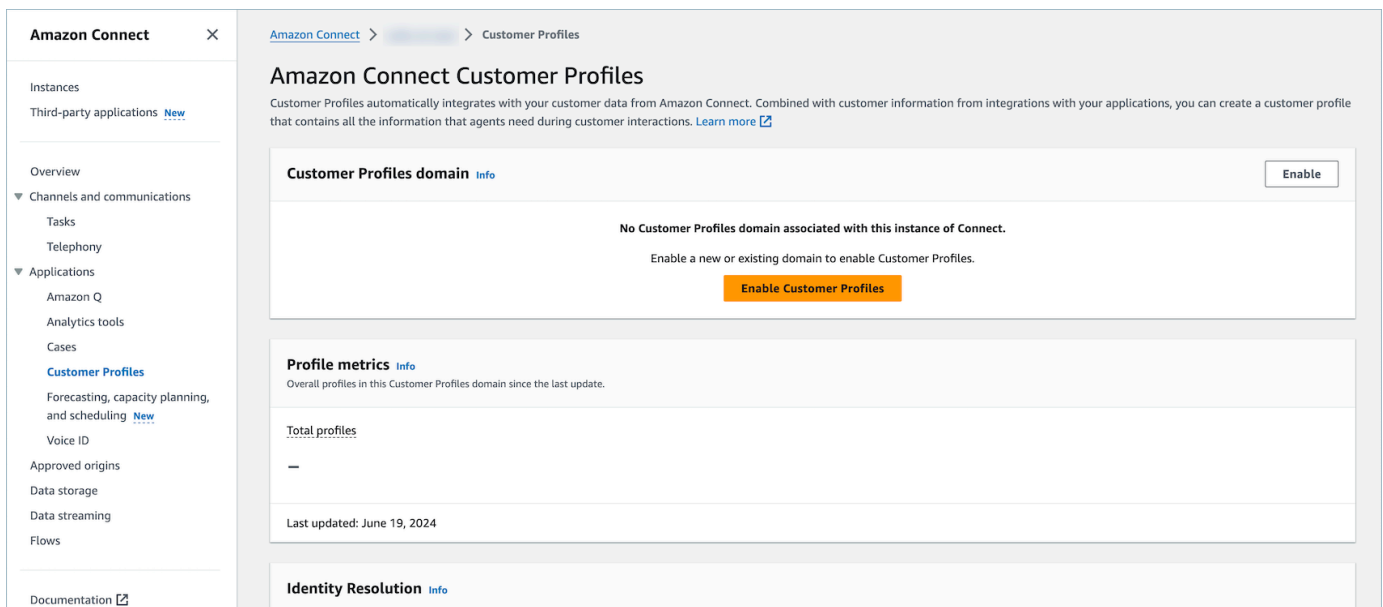

Amazon Connect > Customer Profiles

Amazon Connect Customer Profiles

Customer Profiles automatically integrates with your customer data from Amazon Connect. Combined with customer information from integrations with your applications, you can create a customer profile that contains all the information that agents need during customer interactions. [Learn more](#)

Customer Profiles domain Info Enable

No Customer Profiles domain associated with this instance of Connect.

Enable a new or existing domain to enable Customer Profiles.

Enable Customer Profiles

Profile metrics Info

Overall profiles in this Customer Profiles domain since the last update.

Total profiles

—

Last updated: June 19, 2024

Identity Resolution Info

4. Choose **Enable customer profiles** to get started.
5. At the **Customer profiles enable** page, choose **Create new domain**. Under **Specify a domain**, enter a friendly name that's meaningful to you, such as your organization name, for example, *CustomerProfiles-ExampleCorp*.

Customer profiles enable

Customer profiles domain ⓘ

Provide a domain
The domain enables customer profiles for your instance.

Create new domain ←

Select existing domain

Specify a domain

CustomerProfiles-ExampleCorp

The name must start with a letter or number. It can contain up to 128 characters, which can be letters, numbers, underscores (_), or hyphens (-).

6. Under **Specify dead-letter queue**, choose whether to send failed events to a dead-letter queue. This is helpful if you want to get visibility into data that failed to be ingested. It also gives you the option to retry these failed data ingestions in the future.

Following are the steps to create a dead-letter queue:

- On the **Customer profiles enable** page, choose **Create new or select existing SQS queue** and then choose **Create a new Dead Letter Queue**.

Customer profiles enable

Customer profiles domain ⓘ

Provide a domain
The domain enables customer profiles for your instance.

Create new domain
 Select existing domain

Specify a domain

The name must start with a letter or number. It can contain up to 128 characters, which can be letters, numbers, underscores (_), or hyphens (-).

Specify dead-letter queue - optional
The Amazon SQS queue to handle customer profile errors.

None
 Create new or select existing SQS queue ←

Choose existing SQS queue

[Create a new Dead Letter Queue ↗](#) ←

- A new tab in your browser opens for the Amazon SQS console. Choose **Create queue**.
- On the **Create queue** page, choose **Standard**, then assign a name to your queue.

Amazon SQS > Queues > Create queue

Create queue

Details

Type
Choose the queue type for your application or cloud infrastructure.

 You can't change the queue type after you create a queue.

Standard [Info](#)
At-least-once delivery, message ordering isn't preserved

- At-least once delivery
- Best-effort ordering

FIFO [Info](#)
First-in-first-out delivery, message ordering is preserved

- First-in-first-out delivery
- Exactly-once processing

Name

CustomerProfiles

A queue name is case-sensitive and can have up to 80 characters. You can use alphanumeric characters, hyphens (-), and underscores (_).

- In the **Access policy** section, choose **Advanced**.

The Version name, policy ID, and Statement appear. If needed, update this section to give access to only the appropriate roles.

- At the end of the Statement section (line 15 in the following image) add a comma after `},` and press Enter.

Access policy

Define who can access your queue. [Info](#)

Choose method

Basic
Use simple criteria to define a basic access policy.

Advanced
Use a JSON object to define an advanced access policy.

```

2  "Version": "2008-10-17",
3  "Id": "__default_policy_ID",
4  "Statement": [
5    {
6      "Sid": "_owner_statement",
7      "Effect": "Allow",
8      "Principal": {
9        "AWS": "100222783355"
10     },
11     "Action": [
12       "SQS:*"
13     ],
14     "Resource": "arn:aws:sqs:us-west-2:100222783355:CustomerProfiles"
15   },
16 ]
17 }

```

- Then copy and paste the following code:

```

{
  "Sid": "Customer Profiles SQS policy",
  "Effect": "Allow",
  "Principal": {
    "Service": "profile.amazonaws.com"
  },
  "Action": "SQS:SendMessage",
  "Resource": "arn:aws:sqs:region:accountID:YourQueueName"
}

```

- To replace *region*, *accountID*, and *YourQueueName* with your information, copy and paste the Resource information from line 14.

Access policy

Define who can access your queue. [Info](#)

Choose method

Basic
Use simple criteria to define a basic access policy.

```

12     "SQS:*"
13     },
14     "Resource": "arn:aws:sqs:us-west-2:[:redacted]:CustomerProfiles"
15     },
16     {
17     "Sid": "Customer Profiles SQS policy",
18     "Effect": "Allow",
19     "Principal": {
20     "Service": "profile.amazonaws.com"
21     },
22     "Action": "SQS:SendMessage",
23     "Resource": "arn:aws:sqs:us-west-2:[:redacted]:CustomerProfiles"
24     }
25     ]
26     }

```

- Choose **Create queue**.
- Return to the tab in your browser for the Amazon Connect console, **Customer profiles enable** page. Click or tap in the **Choose existing SQS queue** box to select the queue you just created from the dropdown list.

Specify dead-letter queue - *optional*
The Amazon SQS queue to handle customer profile errors.

None

Create new or select existing SQS queue

Choose existing SQS queue

7. Under **Specify KMS key**, create or enter your own AWS KMS key for encryption. Following are the steps to create your AWS KMS key:

- On the **Customer profiles enable** page, choose **Create an AWS KMS key**.

Amazon Connect > mytest88 > Customer profiles > Enable

Customer profiles enable

Customer profiles domain ⓘ

Provide a domain
The domain enables customer profiles for your instance.

Create new domain
 Select existing domain

Specify a domain

MyCustomerProfileDomain

The name must start with a letter or number. It can contain up to 128 characters, which can be letters, numbers, underscores (_), or hyphens (-).

Specify dead-letter queue - optional
The Amazon SQS queue to handle customer profile errors.

None
 Create new or select existing SQS queue

Specify KMS key
The encryption key for data encryption. Needed to enable customer profiles.

⚠ Use a KMS key with proper permissions to continue.

Q Choose an AWS KMS key or enter an ARN

Create an AWS KMS key ↗

Cancel Submit

- A new tab in your browser opens for the Key Management Service (KMS) console. On the **Configure key** page, choose **Symmetric**, and then choose **Next**.

KMS > Customer managed keys > Create key

Step 1
Configure key

Step 2
Add labels

Step 3
Define key administrative permissions

Step 4
Define key usage permissions

Step 5
Review and edit key policy

Configure key

Key type [Help me choose](#)

Symmetric
A single encryption key that is used for both encrypt and decrypt operations

Asymmetric
A public and private key pair that can be used for encrypt/decrypt or sign/verify operations

► **Advanced options**

Cancel **Next**

- On the **Add labels** page, add a name and description for the key, and then choose **Next**.

KMS > Customer managed keys > Create key

Step 1
Configure key

Step 2
Add labels

Step 3
Define key administrative permissions

Step 4
Define key usage permissions

Step 5
Review and edit key policy

Add labels

Create alias and description

Enter an alias and a description for this key. You can change the properties of the key at any time. [Learn more](#)

Alias

CustomerProfilesKey

Description - optional

Key for Customer Profiles

Cancel **Next**

- On the **Define key administrative permissions** page, choose **Next**.
- On the **Define key usage permissions** page, choose **Next**.
- On the **Review and edit key policy** page, choose **Finish**.

In the following example, the name of the key starts with **bcb6fdd**:

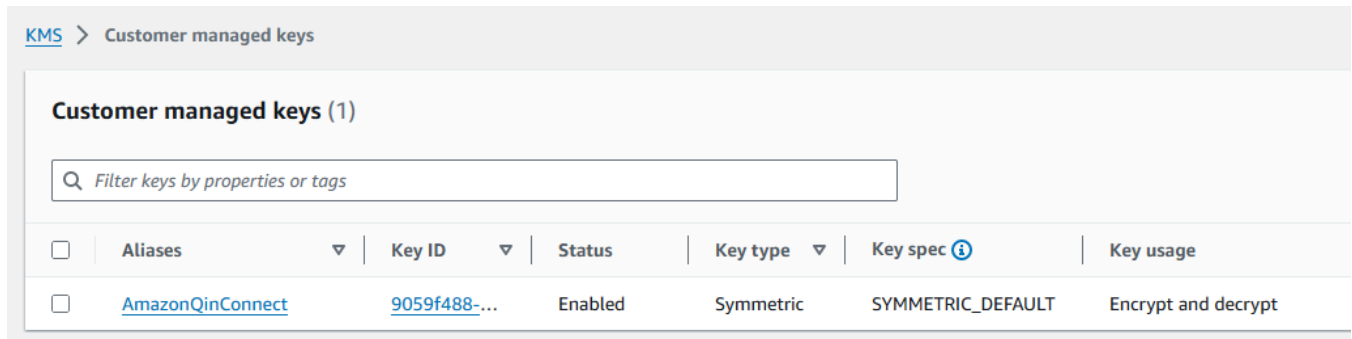

- Return to the tab in your browser for the Amazon Connect console, **Customer profiles enable** page. Click or tap in the **Specify KMS key box** for the key you created to appear in a dropdown list. Choose the key you created.

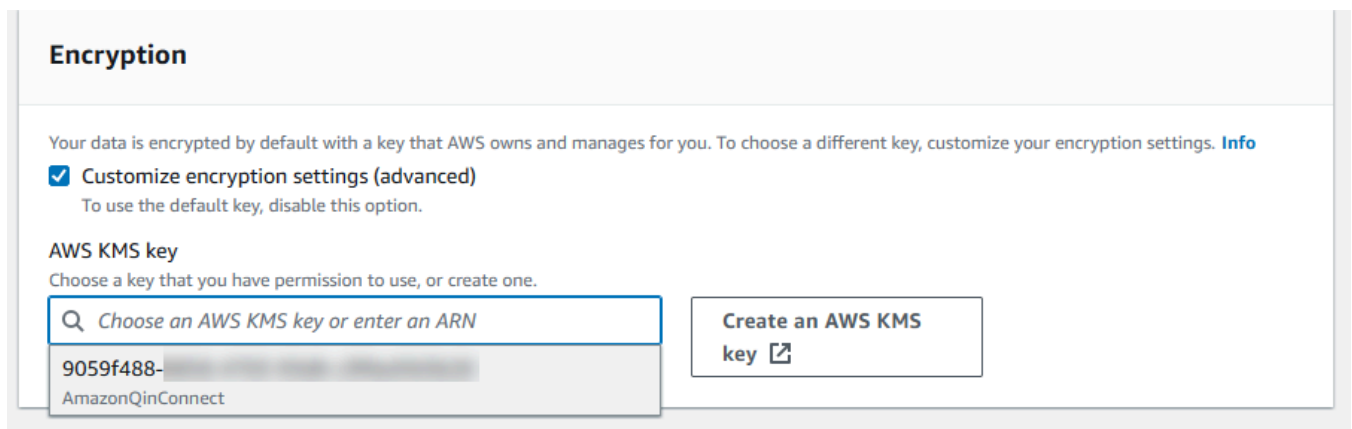

8. Choose **Submit**. The completed page looks similar to the following image. It shows the name of the customer profiles domain, the dead-letter queue, and the KMS key.

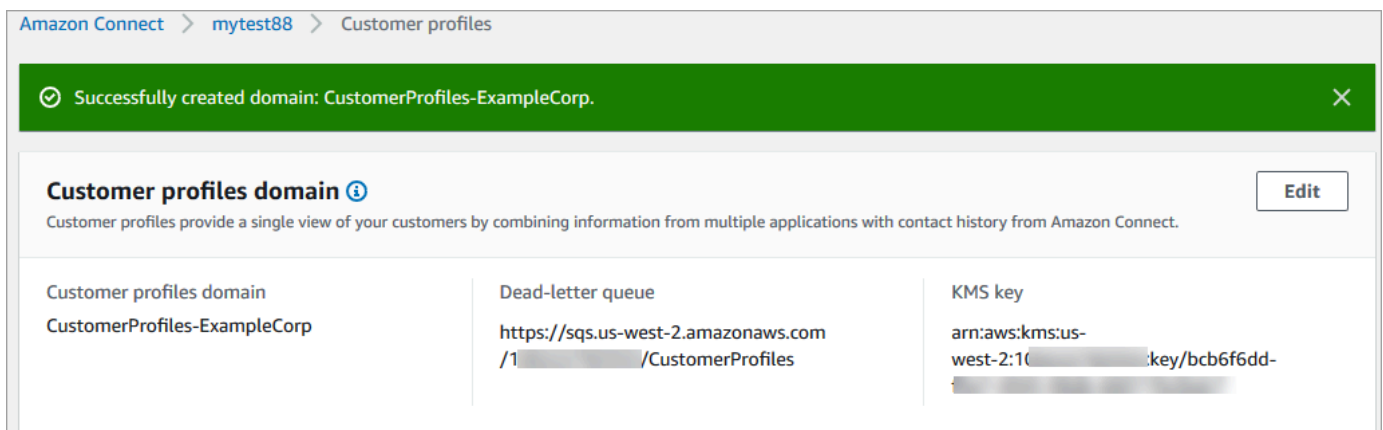

You're done! Amazon Connect Customer Profiles is enabled. Now with every new contact that comes in, Amazon Connect creates a customer profile record. It then tracks the contact history for that phone number (voice) or email address (chat).

Your agents can [create new customer profiles](#) and view contact records for your customers.

Next steps

1. [Make Customer Profiles available through the agent application.](#)
2. [Assign agents permissions to access Customer Profiles in the agent application.](#)
3. [Integrate with external applications that profile customer profile data \(optional\).](#)
4. [Enable Identity Resolution to identify two or more similar profiles, and consolidate them.](#)

Access Customer Profiles in the agent workspace

After you enable Amazon Connect Customer Profiles, agents can begin interacting with customers and access [customer information](#) to provide personalized service. This topic explains how to access the Amazon Connect agent workspace.

Tip

Make sure your agents have **Customer profiles** permissions in their security profile so they can access Customer Profiles. For more information, see [Security profile permissions for Customer Profiles](#).

Option 1: Use Customer Profiles with the CCP out-of-the-box

Customer Profiles is already embedded alongside the Contact Control Panel (CCP). Your agents can access the CCP, Customer Profiles, and Amazon Connect's Case management all in the same browser window by logging into their Amazon Connect instance and choosing the **Agent Workspace** button located at the top right corner as shown in the following image.

Amazon Connect

Agent Workspace Contact Control Panel

What's new?

We have introduced a new navigation sub-section for Contact Lens under Analytics and Optimization menu. This sub-section includes all Contact Lens features such as contact search, rules, and custom vocabulary. This menu change entails no additional charge for you and requires no change on your side to access the existing functionality of features such as contact search and rules. [Learn more](#)

Dashboard [Hide the guide](#)

Configuration guide

Now that you have Amazon Connect setup, it's easy to manage your contact center reliably at any scale. Following these steps will guide you through the basics of configuring Amazon Connect for your business.

1. Explore your channels of communication

Claim a phone number in order to receive and make calls. [Learn more](#) [View phone numbers](#)

Engage more visitors in interactions with chat. [Learn more](#) [Test chat](#) [Customize chat widget](#)

2. Set hours of operations

Hours of operation define when Amazon Connect resources, such as queues, are available, and may be referenced in flows. [Learn more](#) [View hours of operations](#)

Note

You can also access the agent workspace by using the following URL:

- [https://*instance name*.my.connect.aws/agent-app-v2/](https://instance name.my.connect.aws/agent-app-v2/)

If you access your instance using the **awsapps.com** domain, use the following URL:

- [https://*instance name*.awsapps.com/connect/agent-app-v2/](https://instance name.awsapps.com/connect/agent-app-v2/)

For help finding your instance name, see [Find your Amazon Connect instance name.](#)

Following is an example of what Customer Profiles looks like in the agent workspace.

The screenshot displays the Amazon Connect interface. On the left, a chat window shows a conversation with Sofia Martinez. The main area is titled 'Customer Profile' and shows details for Sofia Martinez, including her full name, phone number, date of birth, email address, and mailing address. Below the profile details, there is a 'Recent cases' table with the following data:

Status	Reference Id	Title	Source	Updated date	More
open	88416438	Package Missing	Connect Case	4/11/23	>>

Option 2: Embed Customer Profiles into a custom agent workspace

When you embed your Contact Control Panel (CCP), you have the option of showing or hiding the pre-built CCP user interface. For example, you may want to develop a custom agent workspace that has a user interface you design, with customized buttons to accept and reject calls. Or, you may want to embed the pre-built CCP that's included with Amazon Connect into another custom app.

Regardless of whether you display the pre-built CCP user interface, or hide it and build your own, you use the [Amazon Connect Streams](#) library to embed the CCP and Customer Profiles into the agent's workspace. This way, Amazon Connect Streams is initialized, and the agent can connect and authenticate to Amazon Connect, and Customer Profiles.

For information about embedding Customer Profiles, see [Initialization for CCP, Customer Profiles, and Wisdom](#).

To build your own widget while using raw data from Customer Profiles, see the [Github](#) documentation about how to use the CustomerProfilesJS open source library.

Tip

When you customize the agent's workspace, you determine the URL agents will use to access their agent workspace, and it might very different from the one provided by Amazon Connect. For example, your URL could be `https://example-corp.com/agent-support-app`.

Use contact attributes to autopopulate customer profiles

By default, Amazon Connect Customer Profiles uses the following values to search for and autopopulate a customer profile in its user interface:

- For voice contacts: Phone number
- For chat contacts: Email

It autopopulates a customer profile by using the Customer Profiles flow block. To customize this behavior, use the following contact attributes:

Attribute	Description	Type	JSONPath Reference
profileSearchKey	The name of the attribute you want to use to search for a profile.	User-defined	Not applicable
profileSearchValue	The value of the key you want to search for, such as customer name or account number.	User-defined	Not applicable

For example, to search by email for chat contacts, you can set the `profileSearchKey` attribute to the `_email` search key, and provide the email value as the `profileSearchValue`.

If you have defined custom keys in your profile objects, you can search by those search keys as well. To make sure your custom keys are searchable, see [Key definition details](#).

The following image shows how you might use these attributes in the [Set contact attributes](#) block.

Set contact attributes

Define and store key-value pairs as contact attributes. [Learn more](#)

Contact attributes are accessible by other areas of Amazon Connect, such as the Contact Control Panel (CCP) and Contact Trace Records (CTRs).

Attribute to save

Destination Type ✕
User Defined

Destination Attribute
profileSearchKey

Use text

Value
_email

Use attribute

Destination Type ✕
User Defined

Destination Attribute
profileSearchValue

Use text

Use attribute

Type
User Defined

Attribute
customer_email

Automatically associate a customer profile with a contact

By default, agents need to manually associate a customer profile with a contact based after they've verified the customer's identity. To change this behavior to automatically associate contacts with a profile based on the phone number, see [Automatically associate the Contact Record with one profile found using the _phone key](#).

If multiple profiles match a contact's phone number, the multiple matched profiles are shown to the agent. The agent needs to choose which profile to associate with the contact.

Security profile permissions for Customer Profiles

Contents

- [How update permissions for agents](#)
- [How update permissions for Flows](#)
- [How update permissions for Calculated Attributes](#)
- [Issue with permissions: How to assign new permissions](#)

How update permissions for agents

Assign the following **Customer profiles** permissions as needed to the agent's security profile:

- **View:** Enables agents to see the Customer profiles application. They can:
 - View profiles that are autopopulated in the agent app.
 - Search for profiles.
 - View details stored in customer profiles (for example, Name, Address).
 - Associate contact records to profiles, as shown in the following image.

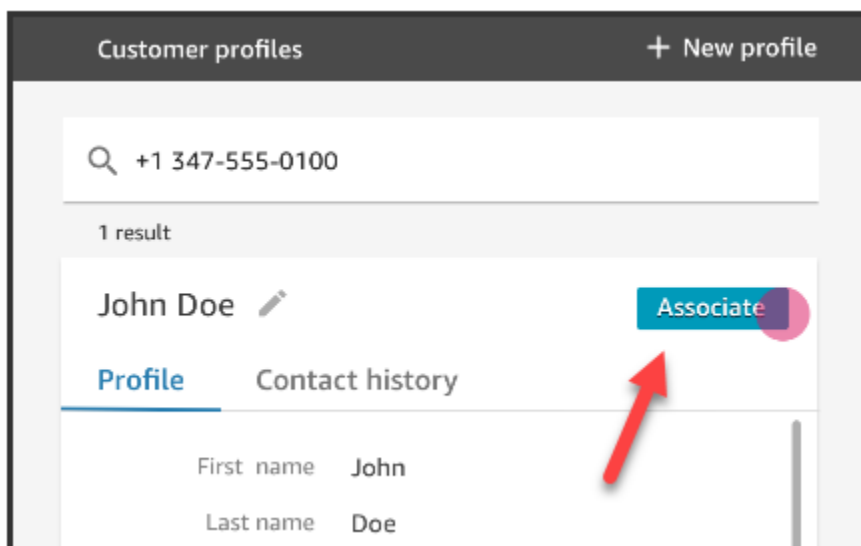

- **Edit:** Enables agents to edit details in the customer profile (for example, change address). They inherit **View** permissions by default.

- **Create:** Enables agents to create and save a new profile. They inherit **View** permissions by default, but don't inherit **Edit** permissions.

For information about how to add more permissions to an existing security profile, see [Update security profiles](#).

By default, the **Admin** security profile already has permissions to perform all Customer profiles activities.

How update permissions for Flows

1. Go to the Security profiles console, choose the security profile you would like to edit, or choose **Add new security profile**.

Customer Profiles					
This allows various access levels for handling customer profiles.					
Type	All	View	Edit	Create	Delete
Customer profiles	<input type="checkbox"/>	<input type="checkbox"/>	<input type="checkbox"/>	<input type="checkbox"/>	<input type="checkbox"/>
Calculated Attributes	<input type="checkbox"/>	<input type="checkbox"/>	<input type="checkbox"/>	<input type="checkbox"/>	<input type="checkbox"/>

2. Select the **View** permission for Customer Profiles.

Customer Profiles					
This allows various access levels for handling customer profiles.					
Type	All	View	Edit	Create	Delete
Customer profiles	<input type="checkbox"/>	<input checked="" type="checkbox"/>	<input type="checkbox"/>	<input type="checkbox"/>	<input type="checkbox"/>
Calculated Attributes	<input type="checkbox"/>	<input type="checkbox"/>	<input type="checkbox"/>	<input type="checkbox"/>	<input type="checkbox"/>

3. Choose **Save**. You can now navigate to the **User management** section and provide this security profile to the users of your choice.

How update permissions for Calculated Attributes

1. Go to the Security profiles console, choose the security profile you would like to edit, or choose **Add new security profile**.

Customer Profiles					
This allows various access levels for handling customer profiles.					
Type	All	View	Edit	Create	Delete
Customer profiles	<input type="checkbox"/>	<input type="checkbox"/>	<input type="checkbox"/>	<input type="checkbox"/>	<input type="checkbox"/>
Calculated Attributes	<input type="checkbox"/>	<input type="checkbox"/>	<input type="checkbox"/>	<input type="checkbox"/>	<input type="checkbox"/>

2. Select **All** or **View**, **Edit**, **Create**, and **Delete** permission for Calculated Attributes.

Customer Profiles					
This allows various access levels for handling customer profiles.					
Type	All	View	Edit	Create	Delete
Customer profiles	<input type="checkbox"/>	<input type="checkbox"/>	<input type="checkbox"/>	<input type="checkbox"/>	<input type="checkbox"/>
Calculated Attributes	<input checked="" type="checkbox"/>	<input checked="" type="checkbox"/>	<input checked="" type="checkbox"/>	<input checked="" type="checkbox"/>	<input checked="" type="checkbox"/>

3. Choose **Save**. You can now navigate to the **User management** section and provide this security profile to the users of your choice.

Issue with permissions: How to assign new permissions

1. In order to update permissions in case of a 403 forbidden call error for any of the backend APIs, navigate to the domain section of the Amazon Connect Customer Profiles console and choose **View details**.

[Amazon Connect](#) > [Customer Profiles](#)

Amazon Connect Customer Profiles

Customer Profiles automatically integrates with your customer data from Amazon Connect. Combined with customer information from integrations with your applications, you can create a customer profile that contains all the information that agents need during customer interactions. [Learn more](#)

Customer Profiles domain [Info](#) [View details](#)

Customer Profiles domain test	KMS key arn:aws:kms:us-west-2: :	Last modified <u>November 14, 2023, 18:20 (UTC)</u>
----------------------------------	--	--

Profile metrics [Info](#)
Overall profiles in this Customer Profiles domain since the last update.

Total profiles
1K

Last updated: November 15, 2023

Identity Resolution [Info](#) [View Identity Resolution](#)

Similar profiles in this Customer Profiles domain since the last Identity Resolution automatic profile matching run.

Match groups found	Profiles merged
--------------------	-----------------

2. Choose **Update Permissions** in the view domain details section.

The screenshot shows the 'Domain details' page in Amazon Connect. At the top, there are navigation links for 'Amazon Connect', 'Customer Profiles', and 'Domain details'. Below the navigation, the title 'Domain details' is displayed. To the right of the title are three buttons: 'Update Permissions' (highlighted with a red box and a red arrow), 'Disable domain', and 'Delete domain'. Below this is a 'Summary' section with a table of domain information:

Domain name	Last modified	Creation date
test	November 14, 2023, 18:20 (UTC)	November 1, 2023, 15:15 (UTC)

Below the summary is a 'Profile creation and auto-association' section with an 'Edit' button. The text describes automatically inferring profiles from new customer records. Below this is a section for 'Encryption' with 'KMS key details' including 'KMS ARN' (arn:aws:kms:us-west-2:...) and 'Key status' (Enabled).

3. Once this is done, the permissions will be successfully updated and the **Update Permissions** button will no longer be visible in the domain details section. This will mitigate the 403 forbidden error issue and you will be able to make API calls successfully.

✔ Successfully Updated Permissions for DomainName: testDoaminForTable

[Amazon Connect](#) > [Customer Profiles](#) > Domain details

Domain details

[Disable domain](#) [Delete domain](#)

Summary

Domain name	Last modified	Creation date
test	November 14, 2023, 18:20 (UTC)	November 1, 2023, 15:15 (UTC)

Profile creation and auto-association

Automatically infer profiles from new customer records using your Amazon Connect contact data, and create a limited profile. We provide you with three different Amazon Connect contact data mapping templates. You cannot edit these templates. [Learn more](#)

[Edit](#)

Profile creation and auto-association

Create inferred profiles only

Encryption

KMS key details

KMS ARN

[arn:aws:kms:us-west-2:](#)

Use Identity Resolution to consolidate similar profiles

A *similar profile* is when two or more profiles are determined to be for the same contact. There can be multiple profiles when customer records are captured across multiple channels and applications for the same customer, and do not share a common unique identifier.

Identity Resolution automatically finds similar profiles and helps you consolidate them. It runs an Identity Resolution Job on a weekly basis, which performs the following steps:

1. [Automatic profile matching](#)
2. [Automatic merging of similar profiles](#) based on your consolidation criteria

Each time an Identity Resolution Job runs, it displays metrics on the **Customer Profiles** page. The metrics show the number of profiles it reviewed, the number of match groups found, and the number of profiles consolidated.

Additional charges may apply for enabling Identity Resolution. For more information, see [Amazon Connect pricing](#).

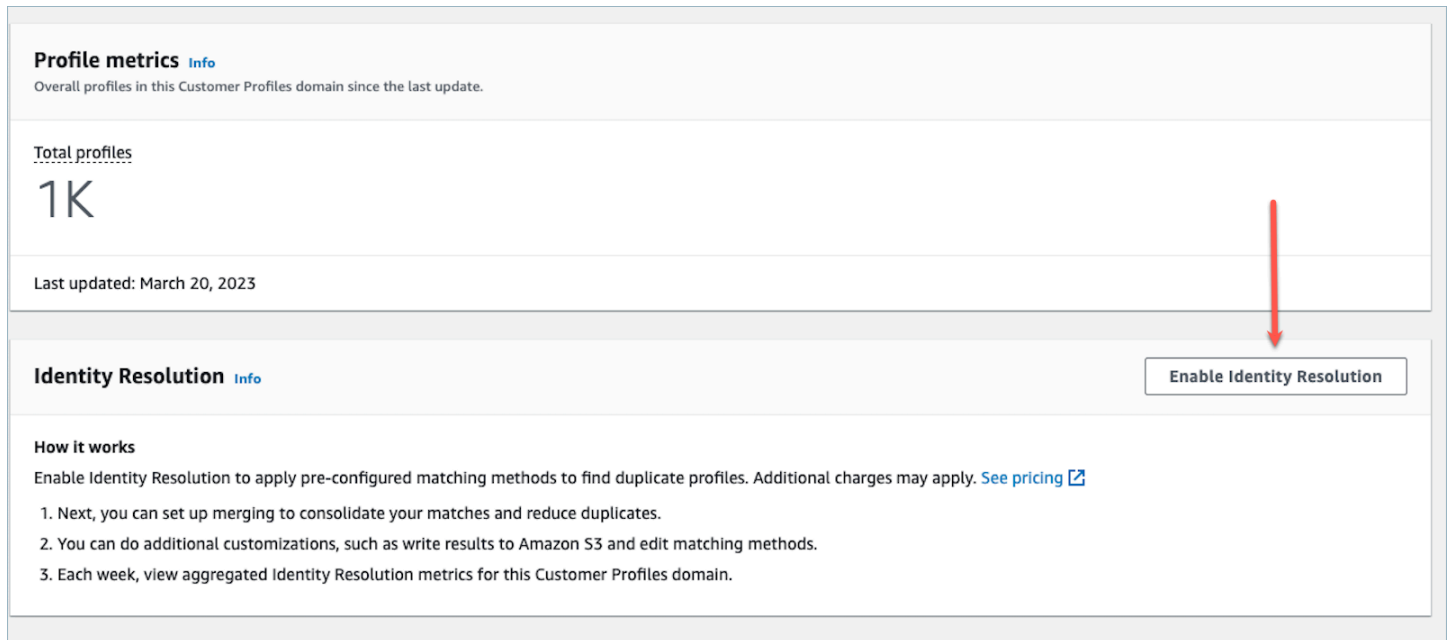

The screenshot displays the 'Customer Profiles' page in Amazon Connect. At the top, there is a 'Profile metrics' section with a sub-header 'Profile metrics Info' and a description: 'Overall profiles in this Customer Profiles domain since the last update.' Below this, a 'Total profiles' section shows '1K' profiles, with 'Last updated: March 20, 2023' below it. A red arrow points from the 'Total profiles' section down to the 'Identity Resolution' section. The 'Identity Resolution Info' section contains a button labeled 'Enable Identity Resolution' and a 'How it works' section with three numbered steps: 1. Next, you can set up merging to consolidate your matches and reduce duplicates. 2. You can do additional customizations, such as write results to Amazon S3 and edit matching methods. 3. Each week, view aggregated Identity Resolution metrics for this Customer Profiles domain.

Enable Identity Resolution for your Customer Profiles domain

When you enable Identity Resolution you specify the following information:

- When the Identity Resolution Job should run on a weekly basis. By default, it runs Saturdays at 12AM UTC.
- The Amazon S3 bucket where the Identity Resolution Job should write the results of the automatic profile matching process. If you don't have an S3 bucket, you'll have the option to create one during the enablement process.

You can query the Amazon S3 bucket or use the [GetMatches](#) API to filter results based on [confidence scores](#).

Note

After you enable Identity Resolution you'll see the option to [create consolidation criteria](#) for the optional auto-merging process.

To enable Identity Resolution

1. You must have a Customer Profiles domain enabled for your instance. For instructions, see [Enable Customer Profiles for your instance](#).
2. In the navigation pane, choose **Customer profiles**.
3. In the **Identity Resolution** section, choose **Enable Identity Resolution**.

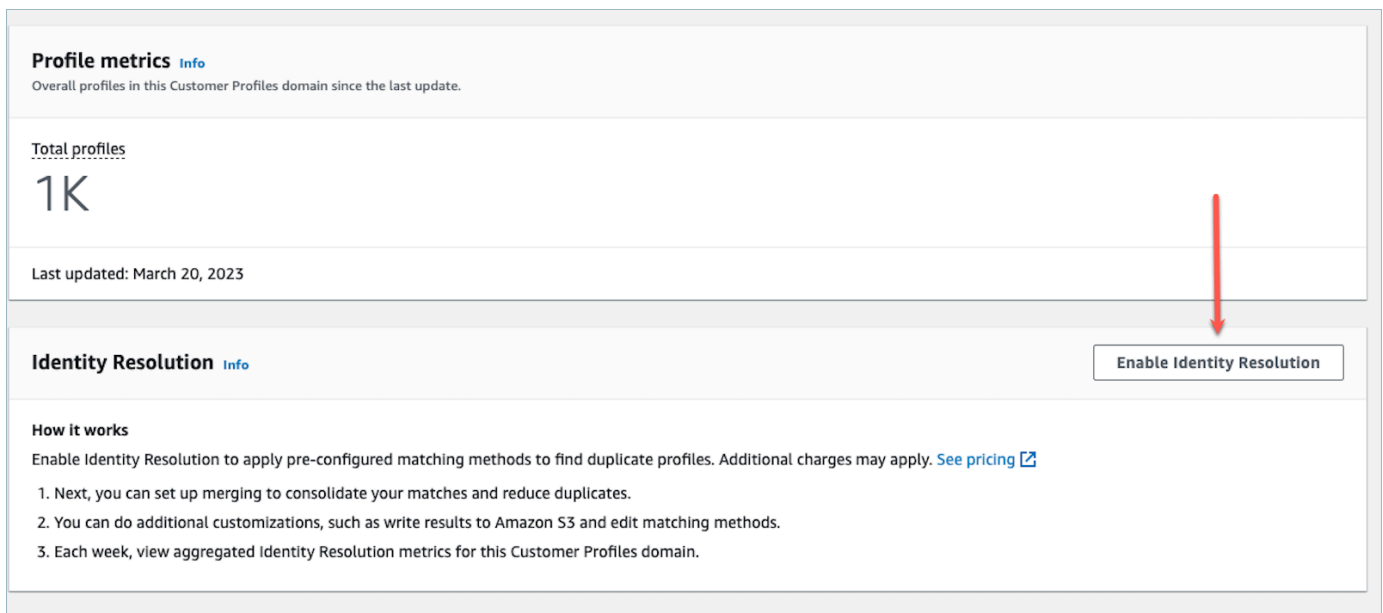

The screenshot displays the Amazon Connect console interface. At the top, there is a 'Profile metrics' section with a sub-header 'Total profiles' and a large '1K' value. Below this, it says 'Last updated: March 20, 2023'. The main section is titled 'Identity Resolution' and contains a button labeled 'Enable Identity Resolution'. A red arrow points directly to this button. Below the button, there is a 'How it works' section with three numbered steps: 1. Next, you can set up merging to consolidate your matches and reduce duplicates. 2. You can do additional customizations, such as write results to Amazon S3 and edit matching methods. 3. Each week, view aggregated Identity Resolution metrics for this Customer Profiles domain.

4. In the **Identity Resolution** pop-up box, choose **Enable Identity Resolution**.

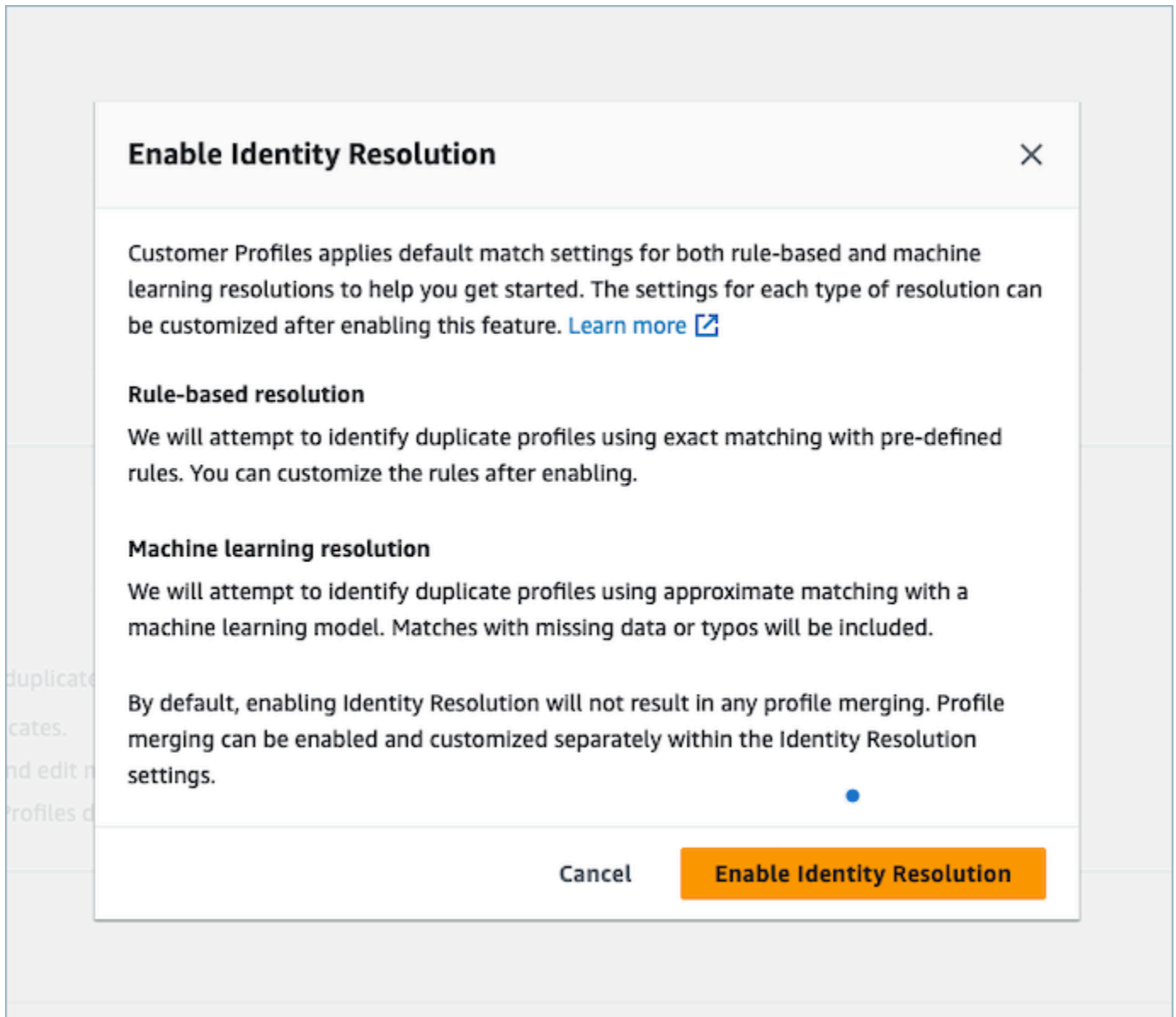

5. On the **Enable Identity Resolution** page, specify the date and time when you want the Identity Resolution Job to run.
6. If you want to review the matched profile IDs from an Amazon S3 bucket, select **Write profile ID matches to Amazon S3**. Otherwise, you can use the [GetMatches](#) API to review matching profiles.
 - Specify the Amazon S3 bucket where the Identity Resolution Job should write the profile matches.

We recommend applying a policy to prevent a confused deputy security issue. For more information and a sample policy, see [Amazon Connect Customer Profiles cross-service confused deputy prevention](#).

7. When done, choose **Enable Identity Resolution**. Both rule-based matching and ML-based matching are enabled after you enable Identity Resolution. You can disable one of them or both from the Identity Resolution page. For more information, see [Disable Identity Resolution](#).
8. Rule-based matching for Identity Resolution:
 - a. After you enable the rule-based matching with a new domain the matching will start immediately if you set up an integration and the integration is running.
 - b. After you enable the rule-based matching with an existing domain, the matching process will start within one hour.
9. ML-based matching for Identity Resolution:
 - a. After you enable Identity Resolution the Identity Resolution Job runs for the first time within 24 hours.

 **Note**

Before running an Identity Resolution Job for the first time on a new Customer Profiles domain, we recommend checking your profile metrics to make sure that profiles have been created. Otherwise, there won't be any matching results.

- b. You may want to set up consolidation criteria for auto-merging matching profiles. If so, see [Set up consolidation criteria for Identity Resolution](#).

Machine learning for Identity Resolution

Contents

- [How machine learning Identity Resolution works](#)
- [Set up machine learning for Identity Resolution](#)
- [Set up consolidation criteria for Identity Resolution](#)

How machine learning Identity Resolution works

This topic describes how Identity Resolution performs automatic profile matching, and if set up, how it automatically merges similar profiles.

Automatic profile matching

To identify similar profiles, Identity Resolution uses machine learning to review the following Personal Identifiable Information (PII) attributes in each profile:

- **Name:** All names are reviewed for similarity, including first name, middle name, and last name.
- **Email:** All email addresses are reviewed for similarity, including personal email and business email. They are not case sensitive.
- **Phone number:** All phone numbers and formats are reviewed for similarity, including home phone, mobile phone, and business phone.
- **Address:** All address types and format are reviewed for similarity, including business address, mailing address, shipping address, and billing address.
- **Date of birth:** All birth dates and formats are reviewed for similarity.

It uses this information to create match groups of similar profiles.

Match groups

A match group consists of all similar profiles which represents a customer. Each match group contains the following information:

- A match ID, which uniquely identifies the group of two or more similar profiles that represent a contact
- The number of profile IDs in the match group
- A confidence score associated with the match group

Confidence scores

After the auto-matching process runs, you can query the S3 bucket or use the [GetMatches](#) API to filter results based on confidence scores. For example, you can filter out high confidence matches for a further review.

A confidence score is a number between 0 and 1 that represents the confidence level of assigning profiles to a match group. A score of 1 likely indicates an exact match.

Automatic merging of similar profiles

After the profiles are matched, the Identity Resolution Job can optionally merge similar profiles based on your criteria. If you delete or update criteria, the updated criteria is applied to similar profiles in the next run.

Important

You cannot undo the consolidation process. We strongly recommend using the [GetAutoMergingPreview](#) API to do a dry run of the automatic merging process before running the Identity Resolution Job.

Note

When merging two profiles, profile fields manually populated through an API call or the Agent Workspace will not be overwritten by profile fields automatically ingested from an integration or custom object type mapping.

For example, suppose a profile is created with `FirstName` "John" manually by an agent in the Agent Workspace. Another profile is created using an S3 integration with `FirstName` "Peter". If these profiles are automatically merged, the `FirstName` "John" will be preserved.

How the auto-merging process works

- **All selected attributes in a consolidation criteria are connected with AND criteria with exact value comparison before merging.**
 - For example, when multiple attributes are specified in the criteria, such as `email address` and `phone number`, then all similar profiles in a match group that have the exact same value of `email address` and `phone number` are merged.
 - If one or more of the similar profiles in a match group have a different value or missing value for one or more of the attributes in a criteria, the similar profiles are merged.

For example, one match group may be five similar profiles out of which three profiles are consolidated, because these three profiles meet the criteria. The other two profiles are not merged, because they do not meet the criteria.

- **Multiple criteria are evaluated in the order of priority starting with Criteria 1.**
 - The sequence in which consolidation criteria are applied. It starts with Criteria 1 as the highest priority to Criteria 10 as the lowest priority.
 - After the Identity Resolution Job applies one criteria, it applies the next criteria to the consolidated profiles and the remaining similar profiles in a match group.
 - You can have a maximum of 10 consolidation criteria.
- **Each criteria runs independently and operates as an OR with other criteria.**
 - When you have multiple criteria, each criteria is applied individually and in the sequence of priority order before the Identity Resolution Job moves on to the next criteria.
 - All criteria is applied in the sequence in which you listed them. It doesn't matter whether the criteria fails or succeeds to consolidate similar profiles in a match group.
- **By default, profile conflicts are managed by recency.**
 - When two or more similar profiles in a match group meet a consolidation criteria, the resulting consolidated profile is created by comparing each value of the profile attributes constituent similar profiles.
 - Each attribute may have an exact match in value. In this case, any value may be selected for that attribute.
 - If there is a conflict between values of two or more constituent similar profiles, the most recently updated attribute is chosen.

For example, if Jane Doe has three different values in the `Address` attribute of the constituent similar profiles, Identity Resolution picks the most recent addressed to create the unified profile.

- By default, the **Last updated timestamp** is used to determine the record that was most recently updated.
- **Profile conflicts are managed by source object type and recency.**
 - You can also change default behavior of conflict resolution to choose a similar constituent profile from a specific source as the source of truth to inform conflict resolution.
 - If you want to specify a data source to use for profile conflicts, you can choose one of your object types as a data source if you select **Source with last updated timestamp**.

- The most recently updated record from the specified object type is used for resolving profile conflicts.
- **Last updated timestamp identifies which record was most recently updated.**
 - The timestamp attribute associated with the source record's object type is used to identify which record was most recently updated.
 - If the timestamp attribute is not available for the object type, the timestamp on which the record was ingested into your Customer Profiles domain is used.
 - If you have custom object types, you need to add timestamps. See [Missing timestamp for profile conflicts](#) for more information.
- **Consolidation is a one-way process and cannot be undone.**
 - Choose your criteria carefully before starting the consolidation process. For more information, see [Tips for creating strong criteria](#).
 - Use the [GetAutoMergingPreview](#) API to test the auto-merging settings of your Identity Resolution without merging your data.

For an example that shows how criteria is applied, see [Example: How sample criteria are applied](#).

Set up machine learning for Identity Resolution

Edit machine learning matching run schedule

Edit run schedule

You can define the weekly run schedule for Machine learning resolution.

Run schedule

You can define the weekly run schedule for Machine learning resolution.

Run schedule

Choose the day and time to start Identity Resolution's weekly run.

Saturday 4:00

Use 24 hour format. All times in UTC.

Local time for the selected UTC run schedule

Saturday at 12:00 AM

Cancel

Save

Edit machine learning merge matches

Amazon Connect > Customer Profiles > Identity Resolution > Machine learning resolution settings > Edit merge machine learning matches

Edit merge machine learning matches

You can merge profile matches to consolidate similar profiles. You cannot revert profiles after they are merged.

Merge matches

Define when to merge profile matches found by machine learning matching.

Merge matches

Use merge matches to automatically consolidate profile matches into a single profile.

Merge matches found by machine learning matching

▶ Advanced merge options

Merge rules [Info](#)

You can define rules for merging profile matches by comparing attribute values. Profiles must match all attributes within the rule exactly to be consolidated.



Tips for creating strong rules

We recommend defining rules that can uniquely identify a profile, such as Email or Account number. Avoid generic rules, such as Last name and First name attributes, which are likely to identify profiles that are not unique. [Learn more](#)



Rule 1

Attributes

Choose one or more attributes

Remove



AccountNumber X

AdditionalInformation X

Address.Address1 X

Show more chosen options (+2)

Profiles must match the attributes exactly to be consolidated. You can add up to 15 more attributes.

Rule 2

Attributes

Choose one or more attributes

Remove



Address.City X

Address.PostalCode X

FirstName X

Show more chosen options (+1)

Profiles must match the attributes exactly to be consolidated. You can add up to 16 more attributes.

Edit machine learning match location

Amazon Connect > Customer Profiles > Identity Resolution > Machine learning resolution settings > Edit match result location

Edit match result location

You can specify the S3 bucket to write your matched results to for reviewing match ID's, profile ID's, and profile attributes.

S3 location - optional

S3 bucket for reviewing matches - optional [Info](#)
Use a new or existing S3 bucket to write profile ID matches for you to download and review.

Write profile ID matches to Amazon S3

S3 bucket destination
Specify an S3 bucket that is in the same AWS Region as this instance of Amazon Connect.

s3://bucket

s3://...

Cancel

Set up consolidation criteria for Identity Resolution

Note

You must [enable Identity Resolution](#) in order to access the option to create consolidation criteria using the Amazon Connect admin console.

When similar profiles are detected by an Identity Resolution Job, the process can automatically merge them into a unified profile based on consolidation criteria that you specify.

The attributes that you select are compared across all similar profiles in a match group for exact match. For example, if you specify `email` as an attribute in the criteria, then all similar profiles in a match group that have exact same value of `email` address are merged into a unified profile.

Tip

If you want to set up your own merging logic, use the [MergeProfiles](#) API.

Limits

You can select any attribute from the [standard profile](#) to compare similar profiles. For example, you might choose phone number, email address, and name, as well as custom attributes.

You can specify up to:

- 10 consolidation criteria
- 20 attributes per criteria

Tips for creating strong criteria

To improve the targeting of unique profiles and to avoid consolidating profiles that are not duplicates, we recommend the following steps:

- Select attributes that can uniquely identify a customer and are not likely to be the same across customers, such as an account number or a form of government ID.
- Avoid single attribute criteria. Select multiple attributes to create a combination of attributes to improve targeting. For example:
 - **Phone number** with **First name, Middle name, Last name** is stronger criteria than
 - **Phone number** alone, or
 - The combination of **First name, Middle, name, Last name** alone
- Select all attributes within a specific attribute group, when applicable. For example, if you want to use name, select all the related name attributes: **First name, Middle name, Last name**. If you want to use business address, select all the related business address attributes.
- Include one of the following attributes likely to uniquely identify a customer in combination with other attributes in the criteria:
 - Account number
 - Phone number
 - Email

How to set up auto-merging criteria

Before setting up your consolidation criteria for automatic merging, or auto-merging, we recommend reviewing [How the auto-merging process works](#).

1. After you enable Identity Resolution, on the **Identity Resolution** page you'll have the option of setting up auto-merging criteria. Choose **Create consolidation criteria**.
2. If you receive a **Missing timestamp** dialog box, we recommend adding new timestamp attributes to your custom object types before continuing. See [Missing timestamp for profile conflicts](#).
3. In the **Profile conflicts** section, choose how profile conflicts should be resolved when two or more records have conflicts.
4. In the **Consolidation criteria** section, create one or more criteria. We recommend including at least two or more attributes per criteria.

Missing timestamp for profile conflicts

The **Missing timestamp** message is displayed if you have custom object type mappings.

Use the [PutProfileObjectType](#) API to add the following new attributes to your custom object type:

- `Fields.sourceLastUpdatedTimestamp`
- `sourceLastUpdatedTimestampFormat`

If the timestamp attribute is not specified, you can continue to create consolidation criteria, however, a default timestamp of when the records were ingested into Customer Profiles is used. We recommend adding the new attributes before creating your consolidation criteria.

If you have already defined a custom object type and want to update your custom object type, we run a scheduled backfill every week to update your existing profiles with the `Fields.sourceLastUpdatedTimestamp`. To opt in to the scheduled backfill:

1. Update your custom profile object type by using the [PutProfileObjectType](#) API.
2. After you update your custom profile object type, open an [AWS Support ticket](#) and we'll schedule the backfill for you. The scheduled backfill runs until end of February 2022.

Alternatively, you can delete and then re-create the ingestion/connector you have for your domain that uses the custom object type. All of your data will be re-ingested using your updated object type and `Fields.sourceLastUpdatedTimestamp` will be parsed from it.

Example: How sample criteria are applied

In this example there are three criteria:

- **Resolve profile conflicts** is set to **Use last updated timestamp**. This means when two fields have conflicting values, Identity Resolution is going to use the last updated timestamp to determine which value to use.
- Criteria 1:
 - First name, Last name
 - Email
- Criteria 2:
 - Phone number

These criteria are applied to the following profiles:

- Profile A
 - John Doe [last updated **05:00a**]
 - doefamily@anyemail.com [last updated **05:00a**]
 - 555-555-5555 [last updated **07:00a**]
- Profile B
 - John Doe [last updated **04:00a**]
 - doefamily@anyemail.com [last updated **06:00a**]
 - 555-555-5556 [last updated *04:00a*]
- Profile C
 - **Jane** Doe [last updated **06:00a**]
 - doefamily@anyemail.com [last updated **07:00a**]
 - 555-555-5555 [last updated **06:00a**]

Following are the results when Criteria 1 is applied:

- Profile A and B are merged = Profile AB

This results in ProfileAB, which looks like the following:

- John Doe [last updated **05:00a**]
- doefamily@anyemail.com [last updated **07:00a**]
- 555-555-5555 [last updated **06:00a**]

Because there's a conflict between the phone numbers, Identity Resolution uses the last timestamp to choose the 555-555-555 number.

Next, Criteria 2 is applied. Following are the results:

- Profile AB and C are merged = Profile ABC

This results in Profile ABC, which looks like the following:

- **Jane** Doe [last updated **06:00a**]
- doefamily@anyemail.com [last updated **07:00a**]
- 555-555-5555 [last updated **07:00a**]

Identity Resolution uses the First name, Last name, and Email from Profile C because they have the most recent timestamps.

Rule-based matching for Identity Resolution

Contents

- [How rule-based Identity Resolution works](#)
- [Set up rule-based matching for Identity Resolution](#)
- [Set up matching rules for rule-based Identity Resolution](#)

How rule-based Identity Resolution works

This topic describes how rule-based Identity Resolution performs automatic profile matching and how it automatically merges similar profiles.

Automatic profile matching

To identify similar profiles, the rule-based Identity Resolution uses a list of [matching rule attributes](#) to match each profile. Up to 15 MatchingRule attributes are supported in the [MatchingRules](#).

Matching rules

The following is a list of the [MatchingRule](#) attributes that can be used. You can configure up to 15 matching rule levels. For each matching rule, you can use the following Personal Identifiable Information (PII) attributes in each profile:

- **AccountNumber**
- **Address.Address:** All addresses specified in the [Attribute Type Selector](#) are reviewed for similarity, including Address, BusinessAddress, MailingAddress, and ShippingAddress
- **Address.City:** All addresses specified in the [Attribute Type Selector](#) are reviewed for similarity, including Address, BusinessAddress, MailingAddress, and ShippingAddress
- **Address.Country:** All addresses specified in the [Attribute Type Selector](#) are reviewed for similarity, including Address, BusinessAddress, MailingAddress, and ShippingAddress
- **Address.County:** All addresses specified in the [Attribute Type Selector](#) are reviewed for similarity, including Address, BusinessAddress, MailingAddress, and ShippingAddress
- **Address.PostalCode:** All addresses specified in the [Attribute Type Selector](#) are reviewed for similarity, including Address, BusinessAddress, MailingAddress, and ShippingAddress
- **Address.State:** All addresses specified in the [Attribute Type Selector](#) are reviewed for similarity, including Address, BusinessAddress, MailingAddress, and ShippingAddress
- **Address.Province:** All addresses specified in the [Attribute Type Selector](#) are reviewed for similarity, including Address, BusinessAddress, MailingAddress, and ShippingAddress
- **PhoneNumber:** The phone numbers specified in the [Attribute Type Selector](#) are reviewed for similarity, including PhoneNumber, HomePhoneNumber, and MobilePhoneNumber.
- **EmailAddress:** All email addresses specified in the [Attribute Type Selector](#) are reviewed for similarity, including EmailAddress, BusinessEmailAddress, and PersonalEmailAddress
- **BirthDate**
- **BusinessName**
- **FirstName**
- **LastName**
- **MiddleName**
- **Gender**
- **Any customized profile attributes with the *Attributes* prefix**

Matching rules are processed by priority. For example, the first rule should be the most optimized rule you want to define and should be used to achieve the most accurate result.

Attribute Type Selector

The Attribute Types Selector holds vital configuration information for rule-based identity resolution, facilitating profile matching. This allows you to fine-tune the comparison of profiles across attribute types and select the key attributes for matching within each type. Within this feature, you have the flexibility to configure three distinct attribute types, enabling precise control over the matching process.

- **Email type**

- You can choose from `EmailAddress`, `BusinessEmailAddress`, and `PersonalEmailAddress`

- **PhoneNumber type**

- You can choose from `PhoneNumberNumber`, `HomePhoneNumber`, and `MobilePhoneNumber`

- **Address type**

- You can choose from `Address`, `BusinessAddress`, `MaillingAddress`, and `ShippingAddress`

You can either choose `ONE_TO_ONE` or `MANY_TO_MANY` as the `AttributeMatchingModel`.

When choosing `MANY_TO_MANY`, the system can match attributes across the sub-types of an attribute type. For example, if the value of the `EmailAddress` field of Profile A and the value of `BusinessEmailAddress` field of Profile B matches, the two profiles are matched on the `EmailAddress` type. When choosing `ONE_TO_ONE`, the system can only match if the sub-types are exact matches. For example, only when the value of the `EmailAddress` field of Profile A and the value of the `EmailAddress` field of Profile B matches, the two profiles are matched on the `EmailAddress` type.

Max allowed rule level for matching

You can configure the max rule level you want to use to match similar profiles. For example, if your max allowed rule level for matching is 5, the system will not find similar profiles using the rule level 6.

Match groups

A match group consists of all similar profiles which represent a customer. Each match group contains the following information:

- A match ID, which uniquely identifies the group of two or more similar profiles that represent a contact

- The number of profile IDs in the match group

Match status

- **PENDING**

The first status after the configuration of a rule-based Matching rule. If it is an existing domain, the rule-based Identity Resolution waits 1 hour before creating the matching rule. If it is a new domain, the system will skip the **PENDING** stage.

- **IN_PROGRESS**

The system is creating the rule-based Matching rule. Under this status, the system is evaluating the existing data and you can no longer change the rule-based matching configuration.

- **ACTIVE**

The rule is ready to use. You can change the rule a day after the status is in an **ACTIVE** state.

How the auto-matching process works

After you create a new Amazon Connect Customer Profiles domain with the rule-based matching rule, the rule-based Identity Resolution will match similar profiles based on the rule you specified while you are ingesting the profiles. If you update the configuration of the rule-based matching, Customer Profiles will start to re-evaluate the profiles in your domain using the new configuration in an hour.

If you are enabling the rule-based matching with an existing domain, the system will move to a **PENDING** state and will start to evaluate the existing profiles in your domain using the new configuration in an hour. The time it takes to finish evaluating profiles is dependant on how many profiles exist.

- **By default, the default rule will be applied if no custom rule specified.**
 - Amazon Connect Customer Profiles provides a default matching rule if you do not provide a custom matching rule. You can check the custom matching rule [here](#).
- **All the records will go through the rule-based matching rules.**
 - The system assesses each matching rule level until a match is identified or until the maximum allowed rule level for matching is reached. The evaluation process commences at rule level 1, where the record is analyzed. If no matching group is discovered, the system proceeds to

evaluate the subsequent rule levels, searching for a match group until either a match is found or the maximum allowed rule level for matching is reached.

- **All attributes in a single matching rule level are connected using an *AND* relationship**
 - When multiple attributes are present within a single rule level, they are interconnected by an AND relationship. During profile matching, all attribute values must align for profiles to be assigned to the same match group. For example, only when the values of all attributes are identical, profiles are considered as matches and grouped together for further processing.
- **All attributes in an attribute type selector are connected with an *OR* relationship**
 - When specifying attributes within the attribute type selector, attributes of the same type are linked through an OR relationship. For instance, consider the PhoneNumber Type where HomePhoneNumber and BusinessPhoneNumber are utilized. In this scenario, two profiles can be matched if either their HomePhoneNumber or BusinessPhoneNumber aligns. Consequently, the matching process allows for flexible matches based on either home or business phone numbers.
- **The match result is eventually optimized.**
 - Due to the near real-time nature of profile matching in the system, there is a possibility that a match group for your profile may be found at a lower (less optimized) rule level. Nevertheless, if a match is available at a higher (more optimized) rule level, the system will assign the profile to that particular group.

Note

When Identity Resolution performs rule-based matching, the order in which the rules that you have configured will be processed is dependant on how the data is ingested. For example, If you configure rules 1 and 2, rule 2 might be processed before rule 1. The processing order might change, but the end result will always be the same.

Automatic merging of similar profiles

After the profiles are matched, the Identity Resolution Job can optionally merge similar profiles based on the [MaxAllowedRuleLevelForMerging](#) you specify in the rule-based matching configuration.

⚠ Important

You cannot undo the consolidation process. It is recommended to turn on matching only first to evaluate the match result using the `ListMatches` and `GetSimilarProfiles` APIs. You can turn on merging by setting the [MaxAllowedRuleLevelForMerging](#) using the [UpdateDomain](#) API.

ℹ Note

When merging two profiles, profile fields manually populated through an API call or the Agent Workspace will not be overwritten by profile fields automatically ingested from an integration or custom object type mapping.

For example, suppose a profile is created with `FirstName` "John" manually by an agent in the Agent Workspace. Another profile is created using an S3 integration with `FirstName` "Peter". If these profiles are automatically merged, the `FirstName` "John" will be preserved.

Set up rule-based matching for Identity Resolution

Edit rule-based matching attribute types

Amazon Connect > Customer Profiles > Identity Resolution > Rule-based resolution settings > Edit attribute types

Edit attribute types

You can select the attribute types, such as email or phone number, to use to find profile matches. For example, if your business wants to match on multiple types of email addresses, you can choose many to many to match across profiles and the attribute type used by your business.

Match across profiles

You can compare profiles with the same attribute type or across multiple attribute types.

Compare attribute types

One to one

Use this for more precise matching to compare on the same attribute type. For example, profile A (personal phone) and profile B (personal phone).

Many to many

Use this for broader matching to compare across multiple attribute types. For example profile A (personal phone) with all attribute types of profile B (mobile phone, personal phone, business phone).

Attribute types

Select the attribute type you want to use for matching profiles.

Email type

Select the email attributes relevant to your data.

- Email (unspecified)
- Personal email
- Business email

Phone number type

Select the phone number attributes relevant to your data.

- Phone (unspecified)
- Home phone
- Mobile phone
- Business phone

Address number type

Select the address attributes relevant to your data.

- Address (unspecified)
- Mailing address
- Shipping address
- Business address

Cancel

Save

Edit rule-based matching rules

Amazon Connect > Customer Profiles > Identity Resolution > Rule-based resolution settings > Edit rules for matching

Edit rules for matching Info

Your data will be evaluated against a set of rules to find exact matches for Rule-based matching. You can customize how matches are found by selecting attribute values to compare for each rule.

Matching rules

You can add or remove attributes for each rule, delete rules, rearrange the priority of rules and create new rules. You can also reset the rules to return them to the defaults.

[View rules](#)

[Reset](#)

Rule 1

Attributes

Choose one or more attributes

Remove

▲

▼

Address.Address X

Address.City X

Address.Country X

[+ Show more chosen options \(+8\)](#)

You can add up to 4 more attributes.

Rule 2

Attributes

Choose one or more attributes

Remove

▲

▼

Address.Address X

Address.City X

Address.Country X

[+ Show more chosen options \(+7\)](#)

You can add up to 5 more attributes.

Rule 3

Attributes

Choose one or more attributes

Remove

▲

▼

Address.Address X

Address.City X

Address.Country X

[+ Show more chosen options \(+7\)](#)

You can add up to 5 more attributes.

Reset rule-based matching rules

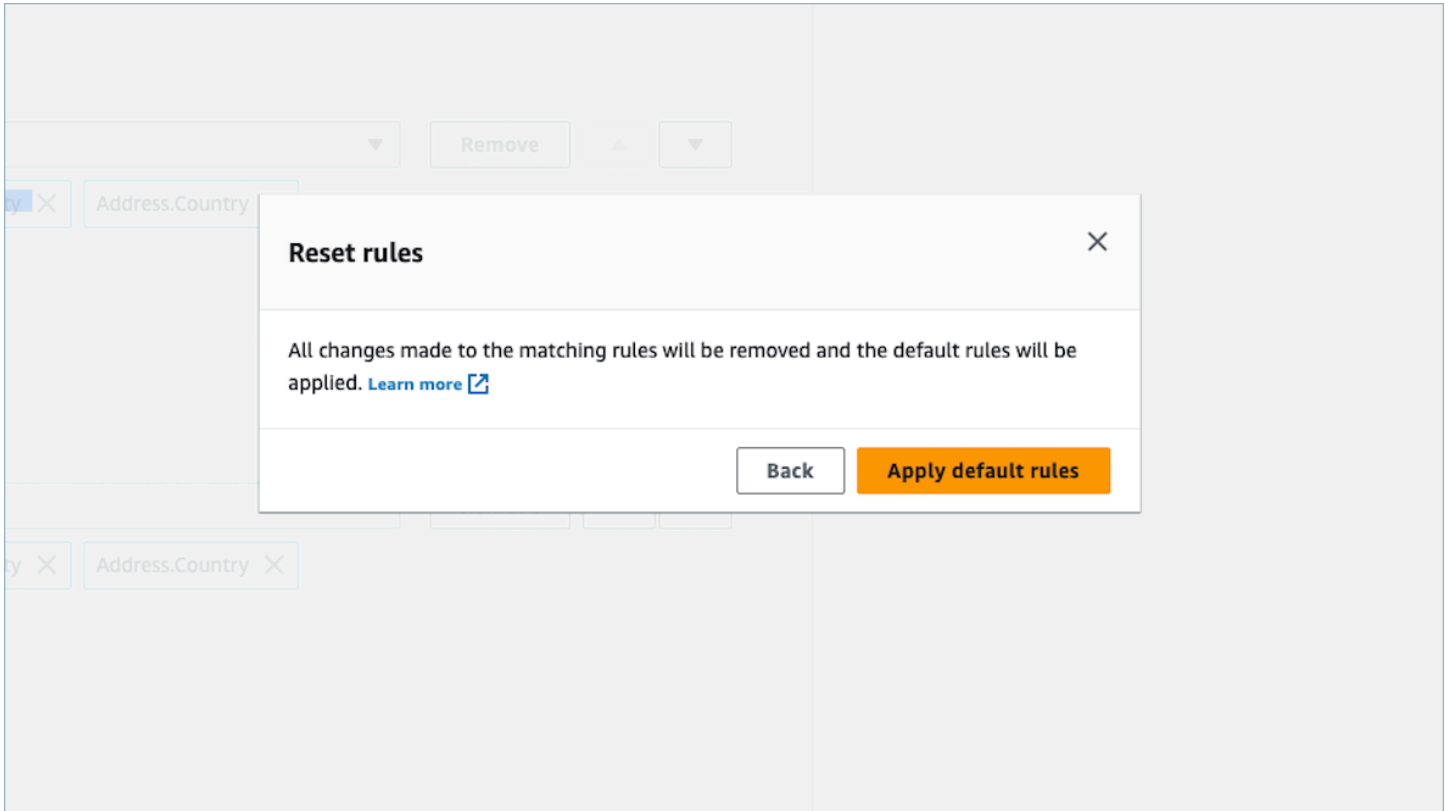

Edit rule-based matching merge rules

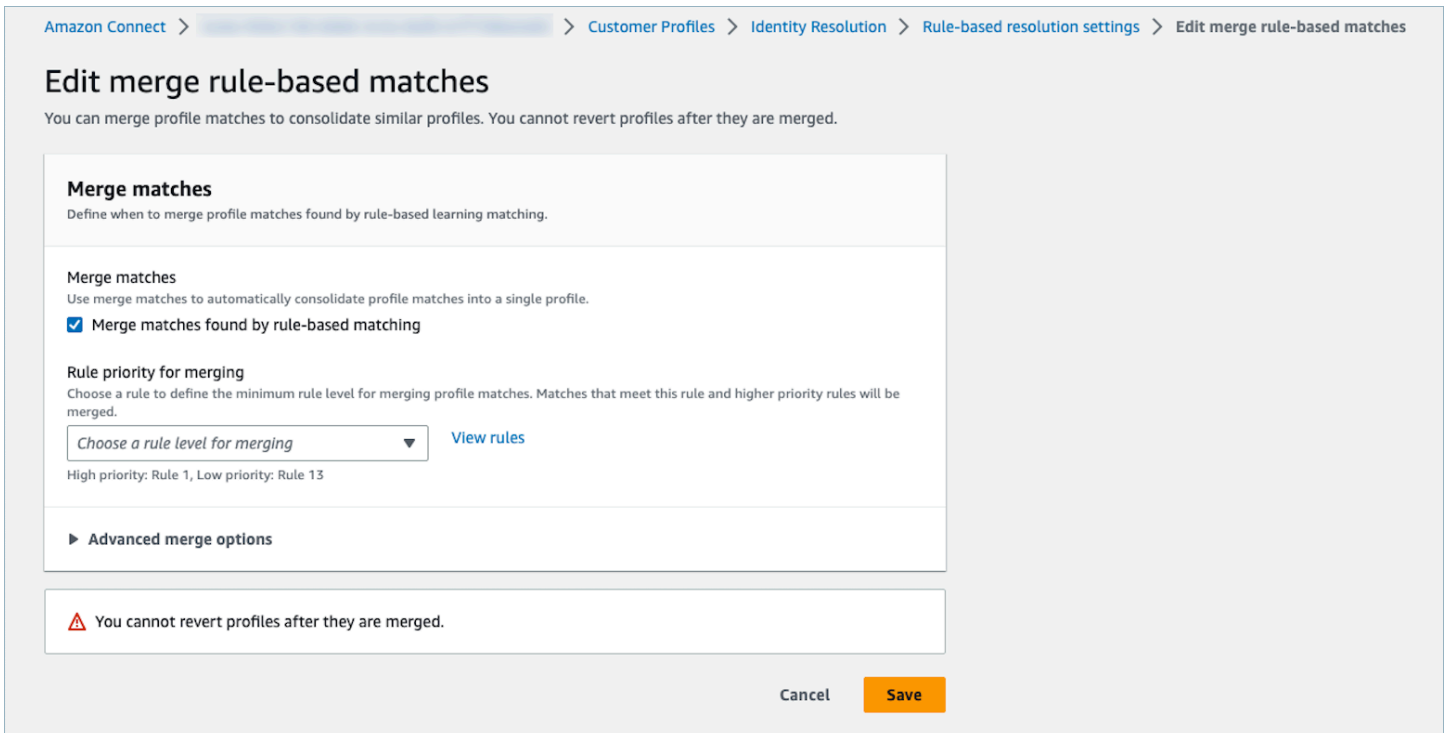

Edit rule-based match location

Amazon Connect > locke-fe9e2160-bbb6-4c4a-8a90-b7f7366a5a82 > Customer Profiles > Identity Resolution > Rule-based resolution settings > Edit match results location

Edit match results location

You can specify the S3 bucket to write your matched results to for reviewing match IDs, profile IDs, and profile attributes.

S3 location - optional

S3 bucket for reviewing matches - optional [Info](#)
Use a new or existing S3 bucket to write profile ID matches for you to download and review.

Write profile ID matches to Amazon S3

S3 bucket destination
Specify an S3 bucket that is in the same AWS Region as this instance of Amazon Connect.

s3://...

[↗](#)

Cancel

Set up matching rules for rule-based Identity Resolution

Limits

You can select any attribute from the standard profile to compare similar profiles. For example, you might choose phone number, email address, and name, as well as custom attributes.

You can create a rule-based matching rule with the following limitations:

- 15 rule levels
- Each rule level can contain up to 15 profile attributes

Tips

To improve the targeting of unique profiles and to avoid consolidating profiles that are not duplicates, the following tips are recommended:

- Include at least one high cardinality attribute that can uniquely identify a customer and that is not likely to be the same across customers, such as a phone number, an email address or an account number.
- Avoid using profile attributes that can belong to different identities without a high cardinality attribute.

- **Phone number with First name, Last name** is a stronger rule than the combination of **First name, Last name** alone.
- If at one rule level, all of the profile attributes of that rule are low cardinality attributes (the attribute that can belong to more than 500 different profiles), the system will not attempt to match the profile. You will receive the following SQS message in your DLQ if you setup one during the domain creation:
 - All attributes at rule level x are associated with more than 500 records.
- Always enable **Match only** first, check the match results, and only enable the merging by setting the **MaxAllowedRuleLevelForMerging** if you are satisfied with the match results.

Resolve Profile Conflicts for profile merging

You can define which record to use when the value of an attribute from two or more similar profiles is different, such as conflicting address records.

Last updated timestamp

By default, profile conflicts are managed by recency. When there is a conflict between the values of two or more similar profiles, the most recently updated attribute will be chosen.

Source with last updated timestamp

Allows you to prioritize records from a specific object type as your data source for managing profile conflicts. When there is a conflict between the values of two or more similar profiles, the most recently updated attribute from the specified object type will be chosen.

If a timestamp is not specified in your object type, the date the record was ingested into Customer Profiles will be used. Source with last updated timestamp is unavailable when you don't have any integrations set up. When you add an integration, your object types will be available as a source for this option.

Missing timestamp for profile conflicts

The Missing timestamp message is displayed if you have custom object type mappings.

Use the [PutProfileObjectType](#) API to add the following new attributes to your custom object type:

- `Fields.sourceLastUpdatedTimestamp`

- `sourceLastUpdatedTimestampFormat`

If the timestamp attribute is not specified, you can continue to create consolidation criteria, however, a default timestamp of when the records were ingested into Customer Profiles is used. It is recommended to add the new attributes before creating your consolidation criteria.

If you have already defined a custom object type and want to update your custom object type, we run a scheduled backfill every week to update your existing profiles with the `Fields.sourceLastUpdatedTimestamp`. To opt in to the scheduled backfill, use the following steps:

1. Update your custom profile object type by using the [PutProfileObjectType](#) API.
2. After you update your custom profile object type, open an [AWS Support ticket](#).
3. AWS will schedule the backfill on your behalf. The scheduled backfill runs until end of February 2022.

Alternatively, you can delete and then re-create the ingestion/connector you have for your domain that uses the custom object type. All of your data will be re-ingested using your updated object type and `Fields.sourceLastUpdatedTimestamp` will be parsed from it.

Example: How matching works

Example for ONE_TO_ONE

You can choose `ONE_TO_ONE` as the `AttributeMatchingModel`. When choosing `ONE_TO_ONE` the system can only match if the sub-types are exact matches.

For example:

You are using the `EmailAddress` and `BusinessEmailAddress` to represent the `EmailAddress` types. The `AttributeMatchingModel` is `ONE_TO_ONE`.

Your matching rule is:

```
Rule Level 1: EmailAddress, LastName, FirstName
Rule Level 2: AccountNumber
```

```
Profile A:  
EmailAddress: 1@email.com  
BusinessEmailAddress: john@company.com  
LastName: Doe  
FirstName: John  
AccountNumber: account1234
```

```
Profile B:  
EmailAddress: 2@email.com  
BusinessEmailAddress: john@company.com  
LastName: Doe  
FirstName: John  
AccountNumber: account1234
```

The Profile A and Profile B matches at rule level 1 since the EmailAddress type, LastName, and FirstName match.

Example for MANT_TO_MANY

You can choose MANT_TO_MANY as the AttributeMatchingModel. When choosing MANT_TO_MANY, the system can match attributes across the sub-types of an attribute type.

For example:

You are using the EmailAddress and BusinessEmailAddress to represent the EmailAddress types. The AttributeMatchingModel is MANT_TO_MANY.

Your matching rule is:

```
Rule Level 1: EmailAddress, LastName, FirstName  
Rule Level 2: AccountNumber
```

```
Profile A:
```

```
EmailAddress: 1@email.com (match with Profile B's BusinessEmailAddress)
BusinessEmailAddress: john@company.com
LastName: Doe
FirstName: John
AccountNumber: account1234
```

```
Profile B:
EmailAddress: 2@email.com
BusinessEmailAddress: 1@email.com (match with Profile A's EmailAddress)
LastName: Doe
FirstName: John
AccountNumber: account1234
```

The Profile A and Profile B matches at rule level 1 since the EmailAddress type, LastName, and FirstName match.

Identity Resolution metrics

Whenever Identity Resolution matches or merges profiles, metrics about the process are displayed on the Customer Profiles dashboard. You can review metric for the pass week on the **Identity Resolution** summary page.

The following metrics are generated each time the Identity Resolution Job runs:

- **Match groups found:** The number of match groups that were found.
 - Available for both ML-based and rule-based Identity Resolution.
- **Profiles Merged:** The number of profiles that were merged.
 - Available for both ML-based and rule-based Identity Resolution.
- **Match Group by rule:** The number of match group that were created by each rule level.
 - Only available for rule-based Identity Resolution.

Identity Resolution



Finish setting up Identity Resolution

- You can consolidate profiles and reduce duplicates, select an Identity Resolution method to customize **Merge matches**.
- You can write profile matches to an S3 bucket, select an Identity Resolution method to customize **Match results location**.



Identity Resolution settings (2) [Info](#)

View and customize settings for Identity Resolution

[Manage settings](#)

	Name	Find matches	Merge matches	S3 location 🔗	Last updated
<input type="radio"/>	Rule-based resolution	⌚ Pending	⊖ Inactive	-	March 23, 2023, 18:20 (UTC)
<input type="radio"/>	Machine learning resolution	✅ Active	⊖ Inactive	-	March 23, 2023, 18:20 (UTC)

Match groups found [Info](#)

[March 18, 2023, 0:00 \(UTC\) - March 23, 2023, 18:20 \(UTC\)](#)

Number of match groups

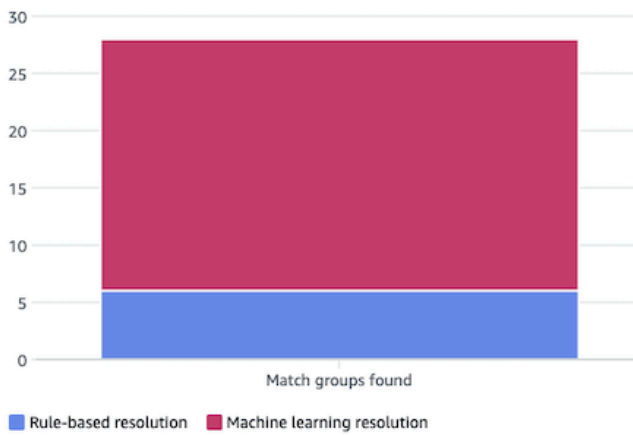

Profiles merged [Info](#)

[March 18, 2023, 0:00 \(UTC\) - March 23, 2023, 18:20 \(UTC\)](#)

Number of profiles

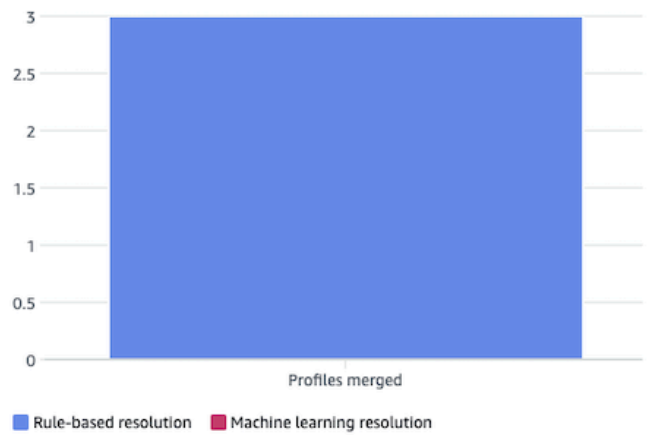

Match groups by rule (3) [Info](#)

[March 18, 2023, 0:00 \(UTC\) - March 23, 2023, 18:20 \(UTC\)](#)

[List view](#)

[Graph view](#)



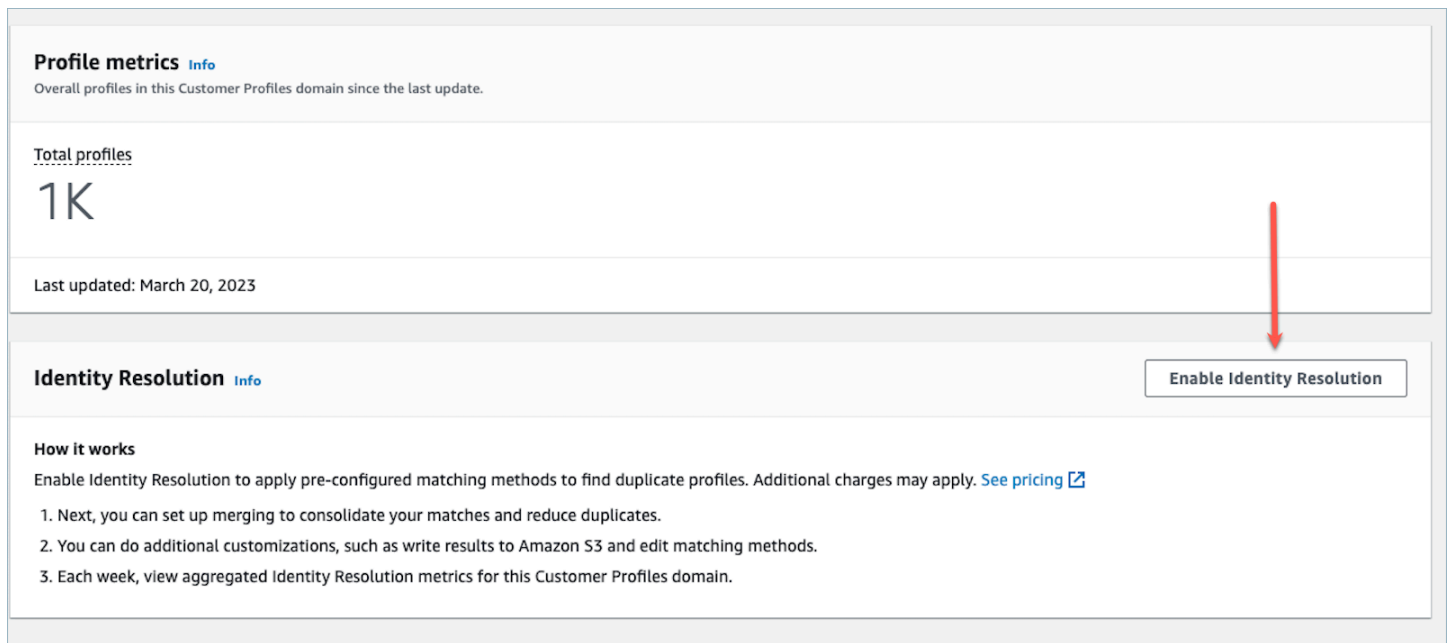

The screenshot displays the Amazon Connect Customer Profiles console. At the top, there is a 'Profile metrics' section with a sub-header 'Profile metrics Info' and a description: 'Overall profiles in this Customer Profiles domain since the last update.' Below this, a 'Total profiles' section shows a large '1K' value. Underneath, it states 'Last updated: March 20, 2023'. A red arrow points from the 'Total profiles' section down to a button labeled 'Enable Identity Resolution' in the 'Identity Resolution Info' section. Below the button, there is a 'How it works' section with a description and a list of three steps: 1. Next, you can set up merging to consolidate your matches and reduce duplicates. 2. You can do additional customizations, such as write results to Amazon S3 and edit matching methods. 3. Each week, view aggregated Identity Resolution metrics for this Customer Profiles domain.

Disable Identity Resolution

Disable machine learning-based

You can disable machine learning-based matching when you no longer want it to automatically find similar profiles. If you have consolidation criteria, all your criteria will be deleted and your profiles will no longer be automatically consolidated. Profiles that have already been consolidated will remain consolidated.

Disable rule-based matching

You can disable rule-based matching when you no longer want it to automatically find similar profiles. If you have a custom matching rule, the matching rule will be deleted and your profiles will no longer be automatically consolidated. Profiles that have already been consolidated will remain consolidated.

Integrate external applications with Customer Profiles

Amazon Connect provides a set of pre-built integrations powered by Amazon AppFlow and Amazon EventBridge. After you enable Amazon Connect Customer Profiles, you can use these integrations to combine information from external applications such as Salesforce or Zendesk, with contact history from Amazon Connect. This creates a customer profile that has all the information agents need during customer interactions in a single place.

You can also use Customer Profiles in Amazon AppFlow. Amazon AppFlow supports CustomerProfiles as a destination. You can use Amazon AppFlow APIs to send data into Customer Profiles using CustomerProfiles as the destination name.

Before you begin, make sure you are using a customer managed key. For more information about configuring KMS keys, see [Create a KMS key to be used by Customer Profiles to encrypt data \(required\)](#).

Set up integrations

You can setup an integration using either featured applications in Amazon Connect or external applications using Amazon AppFlow by choosing the method that best fits your use-case below. For more detailed information on the integration of ServiceNow and Slack, see the blog post [Combine data from multiple sources using Amazon AppFlow and build a unified Amazon Connect Customer profile for contact center agents](#).

Contents

- [Set up integration for featured applications in Amazon Connect](#)
- [Set up integration for external applications using Amazon AppFlow](#)
- [Delete/stop Customer Profiles integrations](#)

Set up integration for featured applications in Amazon Connect

These integrations use Amazon Connect featured applications to provide periodic updates to Amazon Connect Customer Profiles.

Before you begin

Bulk ingestion of data

When you set up your integration, you are prompted to enter a date how far back you want to go to ingest data. If you choose a date that is more than two months ago, Customer Profiles automatically enables bulk ingestion by creating multiple flows. It does this so you don't have to calculate how many flows you need to ingest data.

When automatic bulk ingestion is enabled, Customer Profiles does the following:

- Sets the batch size to two months.
- Retries on transient failures up to three times before failing.

You can use the [CreateIntegrationWorkflowRequest](#) API to call your own batch size.

Why am I asked to select or create an IAM role?

For Salesforce, Marketo, and ServiceNow, Customer Profiles helps improve the historical ingestion of these sources by using your IAM role to create several workflows to ingest your data quickly and efficiently.

For these sources, if you select more than 60 days back in the **Date for importing records** date picker, you will be prompted to create a new IAM role or select an existing one. This role allows Customer Profiles to manage your integration. It provides Customer Profiles with the necessary permissions to update and create a workflow to ingest your data. After the workflow is complete, Customer Profiles creates a standard, continuous integration that ingests your new data as it is updated in your source.

The role created in the console is only useable by the domain it was created on. This is because Amazon Connect limits the access of the role to only the KMS key used by the domain.

For more information, see [Grant least privilege access to your Customer Profiles execution role](#).

Grant least privilege access to your Customer Profiles execution role

If you want to create your own IAM role, we recommend using the permissions shown in the following code to limit the role to the least permissions needed. Use the snippet below to create your role manually. Use your own KMS key and specify your Region where needed.

```
{
  "Version": "2012-10-17",
  "Statement": [
    {
      "Condition": {
        "ForAnyValue:StringEquals": {
          "aws:RequestTag/awsOwningService": "customer-profiles-integration-
workflow"
        }
      },
      "Action": [
        "appflow:CreateFlow",
        "appflow:TagResource",
        "profile:TagResource",
        "profile:PutIntegration"
      ]
    }
  ]
}
```

```

        "Resource": "*",
        "Effect": "Allow",
        "Sid": "CreateFlowResources"
    },
    {
        "Action": [
            "appflow:UseConnectorProfile"
        ],
        "Resource": "*",
        "Effect": "Allow",
        "Sid": "UseConnectorResources"
    },
    {
        "Condition": {
            "ForAnyValue:StringEquals": {
                "aws:ResourceTag/awsOwningService": "customer-profiles-integration-
workflow"
            }
        },
        "Action": [
            "appflow:DescribeFlow",
            "appflow:DescribeFlowExecutionRecords",
            "appflow>DeleteFlow",
            "appflow:StartFlow",
            "appflow:StopFlow",
            "appflow:UpdateFlow",
            "profile>DeleteIntegration"
        ],
        "Resource": "*",
        "Effect": "Allow",
        "Sid": "AccessFlowResources"
    },
    {
        "Action": [
            "kms:CreateGrant",
            "kms:ListGrants"
        ],
        "Resource": "{{YourKMSKeyConsumedByTheDomain}}",
        "Condition": {
            "StringEquals": {
                "kms:ViaService": [
                    "appflow.{{region}}.amazonaws.com"
                ]
            }
        }
    }

```

```

    },
    "Effect": "Allow",
    "Sid": "KMSAppflow"
  },
  {
    "Action": [
      "kms:CreateGrant"
    ],
    "Resource": "{{YourKMSKeyConsumedByTheDomain}}",
    "Condition": {
      "StringEquals": {
        "kms:ViaService": [
          "profile.{{region}}.amazonaws.com"
        ]
      },
      "ForAllValues:StringEquals": {
        "kms:GrantOperations": [
          "Decrypt"
        ]
      }
    }
  },
  "Effect": "Allow",
  "Sid": "KMSCustomerProfiles"
}
]
}

```

Monitor your Customer Profiles integrations

After your connection is established, if it stops working, delete the integration and then re-establish it.

What to do if objects aren't being sent

If an object fails to be sent, choose **Flow details** to learn more about what's gone wrong.

You may need to delete the configuration and re-connect to the external application.

Set up integration for Salesforce, ServiceNow, Marketo, or Zendesk

To provide periodic updates to Amazon Connect Customer Profiles, you can integrate with Salesforce, ServiceNow, Marketo, or Zendesk using Amazon AppFlow. You first set up the connection in Amazon Connect and the application of your choice, and then verify the integration.

Set up the connection in Amazon Connect and Salesforce, ServiceNow, Marketo, or Zendesk

1. Open the Amazon Connect console at <https://console.aws.amazon.com/connect/>.
2. On the instances page, choose the instance alias. The instance alias is also your **instance name**, which appears in your Amazon Connect URL. The following image shows the **Amazon Connect virtual contact center instances** page, with a box around the instance alias.

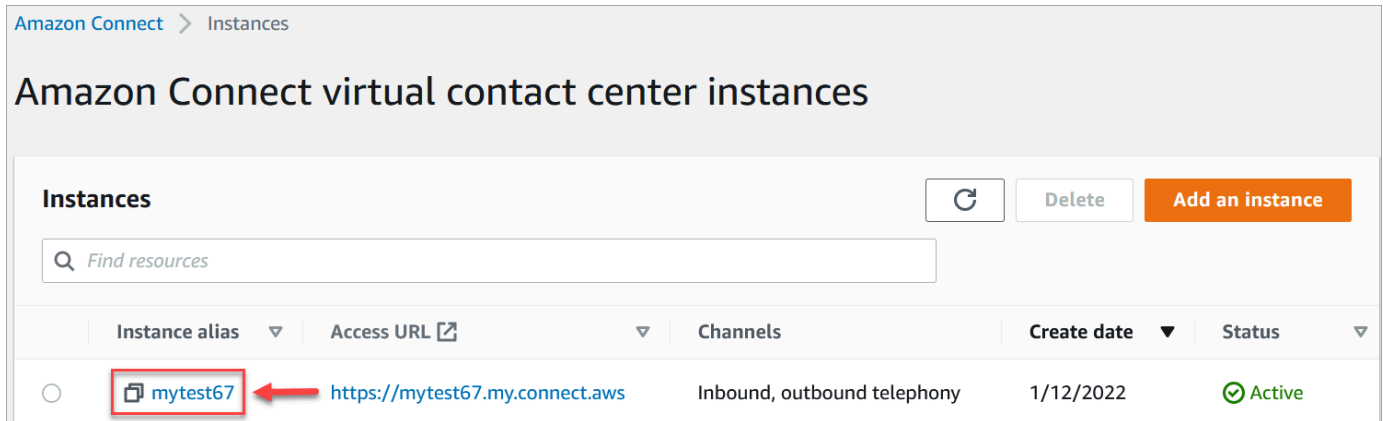

3. In the navigation pane, choose **Customer profiles**.
4. On the **Customer profiles configuration** page, choose **Add integration**, as shown in the following image.

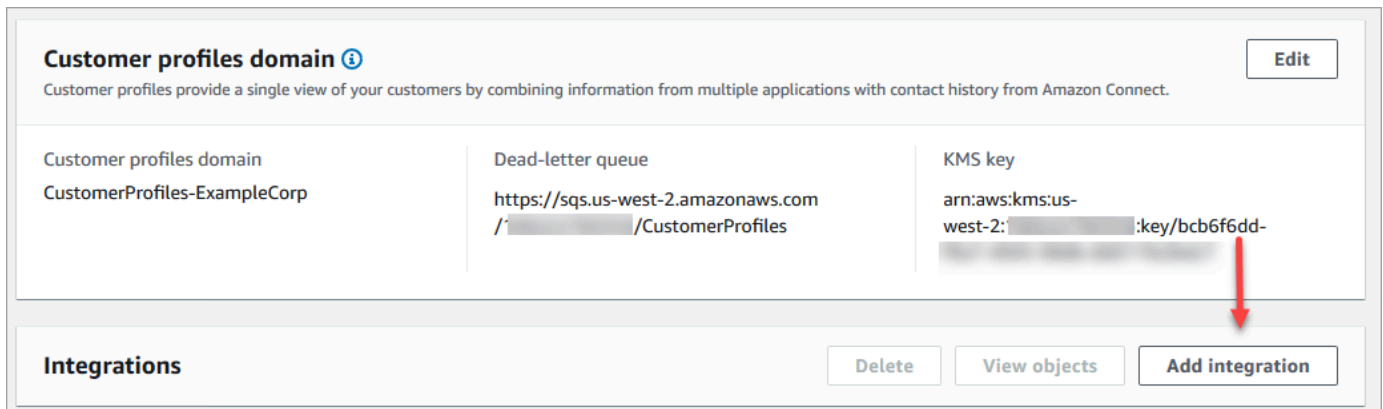

5. On the **Select data source** page, choose which external application you want to get customer profiles data from. You can view the [integration requirements](#) to better understand the connection requirements needed for your application.

Amazon Connect > test-pmt > Customer Profiles > Add data source integration

Step 1
Select data source

Step 2
Establish connection

Step 3
Select data mapping

Step 4
Review and integrate

Select data source

Amazon Connect instances integrate with multiple data sources. Additional charges may apply. [See pricing](#)

► **How it works**

Data source [Info](#)

Supported data connectors, including Amazon AppFlow supported connectors.

Data source
Choose your data source or create a flow in AppFlow if your source is not available.

Salesforce ▼ [Create new flow](#)

Cancel [Next](#)

6. On the **Establish connection** page, choose one of the following:

- **Use existing connection:** This allows you to reuse existing Amazon AppFlow resources you may have created in your AWS account..
- **Create new connection:** Enter the information required by the external application.

Establish connection

Set up your external application

Connection for batch processing

Use existing connection
Existing AWS AppFlow connection to this data source.

Create new connection
Create new AWS AppFlow connection to this data source.

Select connection

Q

new_test_servicenow_connection

7. On the **Integration options** page, choose which source objects you want to ingest and select their object type.

Object types store your ingested data. They also define how objects from your integrations are mapped to profiles when they are ingested. Customer Profiles provides default object type templates you can use that define how attributes in your source objects are mapped to

the standard objects in Customer Profiles. You can also use the object mappings that you've created from the [PutProfileObjectType](#). When adding or creating the Salesforce integration for the user created data mapping, you need to specify the specific data mapping, otherwise it will choose the Salesforce default data mapping for object type. You can create your data mapping and use it when setting up a featured data connector.

Integration options

Object type [Info](#)
Select the objects you want to ingest and choose their object type to define how the objects are mapped to profiles.

Salesforce objects

Account
Salesforce-Account ▼

Contact
Salesforce-Contact ▼

Asset
Salesforce-Asset ▼

Ingestion start date
Customer Profiles imports records created after the ingestion start date from your application.

Date for importing records
Ingest records created after this date.

2021/07/05

Permissions [Info](#)
Customer Profiles uses an IAM role with permissions to ingest your data from your source to Customer Profiles.

Execution role
Choose a role that defines the permissions of this integration.

Create a new role
An IAM role will be created to give Customer Profiles permissions to manage your integration.

Use an existing role
Select an existing IAM role with the permissions to manage your integration.

Role name

The name must start with a letter or number. It can contain up to 61 characters, which can be letters, numbers, or you can also include any of the following characters: _+@-.

IAM role details
cp-salesforce-us-west-2-role

8. For the **Ingestion start date**, Customer Profiles starts ingesting records created after this date. By default, the date for importing records is set at 30 days prior.
9. On the **Review and integrate** page, check that the **Connection status** says **Connected**, and then choose **Create integration**.

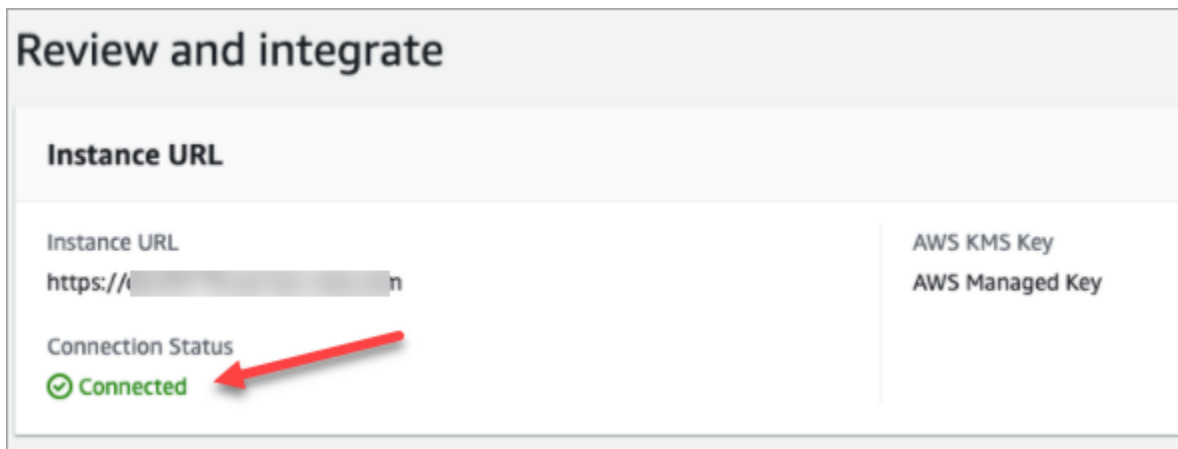

10. After the integration is set up, back on the **Customer profiles configuration** page, choose **View objects** to see what data is being batched and sent. Currently, this process ingests records that were created or modified in the last 30 days.

Customer profiles domain Edit

Customer profiles provide a single view of your customers by combining information from multiple applications with contact history from Amazon Connect.

Locke domain: CustomerProfiles-ExampleCorp

Dead-letter queue: [https://sqs.us-west-2.amazonaws.com/\[redacted\]/CustomerProfiles](https://sqs.us-west-2.amazonaws.com/[redacted]/CustomerProfiles)

KMS key: arn:aws:kms:us-west-2:[redacted]:key/[redacted]

Integrations: Salesforce View all integrations

Integration name	Object name	Last updated date	Last run status	Last run message
Salesforce	Account	Thu Oct 15 2020 14:28:12 GMT-0400 (Eastern Daylight Time)	🕒	-
Salesforce	Contact	Thu Oct 15 2020 14:28:11 GMT-0400 (Eastern Daylight Time)	🕒	-

Set up integration for Segment

To provide periodic updates to Amazon Connect Customer Profiles, you can integrate with Segment using Amazon AppFlow. You first set up the connection in Amazon Connect and Segment, and then verify the Segment integration.

Set up the connection in Amazon Connect and Segment

1. Open the Amazon Connect console at <https://console.aws.amazon.com/connect/>.

- On the instances page, choose the instance alias. The instance alias is also your **instance name**, which appears in your Amazon Connect URL. The following image shows the **Amazon Connect virtual contact center instances** page, with a box around the instance alias.

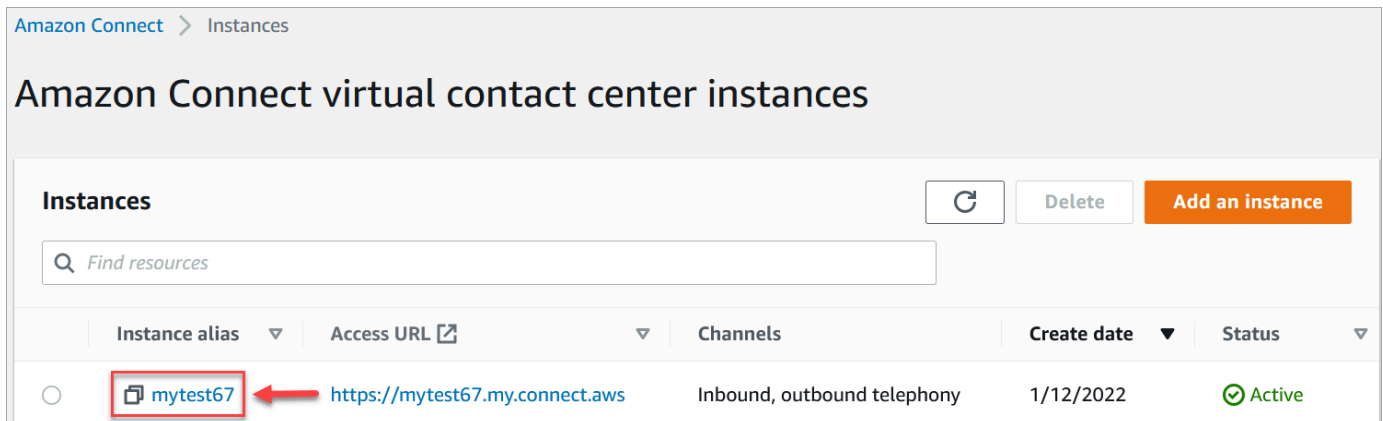

- In the navigation pane, choose **Customer profiles**.
- On the **Customer profiles configuration** page, choose **Add integration**.

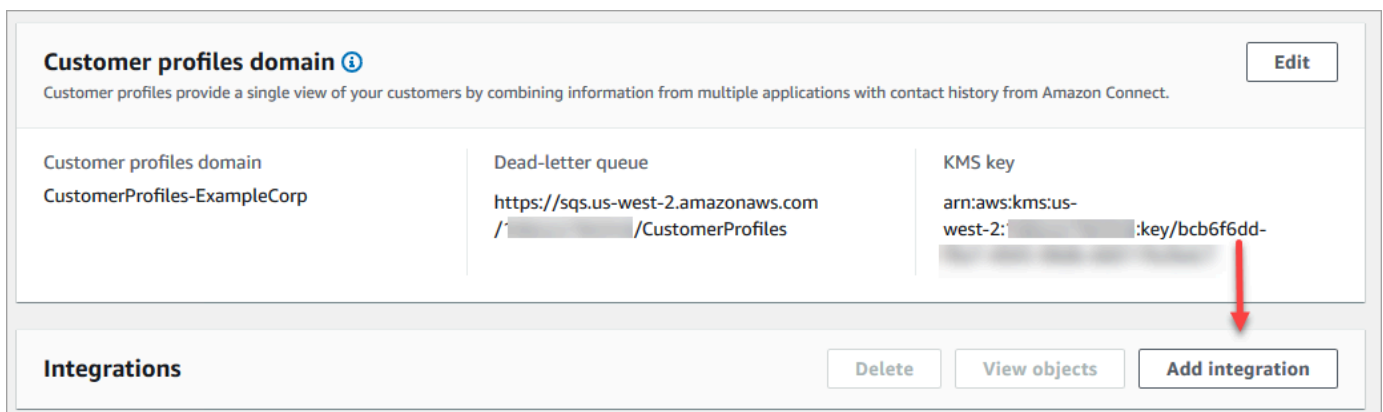

- On the **Select data source** page, choose **Segment**. Review the application requirements that are listed on the **Select application** page.

Amazon Connect > test-pmt > Customer Profiles > Add data source integration

Step 1
Select data source

Step 2
Establish connection

Step 3
Select data mapping

Step 4
Review and integrate

Select data source

Amazon Connect Instances integrate with multiple data sources. Additional charges may apply. [See pricing](#)

► **How it works**

Data source [Info](#)

Supported data connectors, including Amazon AppFlow supported connectors.

Data source
Choose your data source or create a flow in AppFlow if your source is not available.

Segment ▼ [Create new flow](#)

By creating this integration with Segment, you acknowledge the following [Info](#)

- I've confirmed that the Segment instance has a source set up in Cloud mode.
- Segment events are ingested only if a profile can be identified through a user ID.

Cancel [Next](#)

6. On the **Establish connection** page, choose one of the following:
- **Use existing connection:** This allows you to reuse existing Amazon EventBridge resources that you may have created in your AWS account.
 - **Create new connection:** Enter the information required by the external application.

Establish a connection with Segment

Customer Profiles uses Amazon EventBridge to integrate with this data source.

Connection method [Info](#)

Use existing connection
 Reuse an existing connection to ingest objects from this data source.

Create new connection
 Create a new connection to ingest objects from this data source.

Connection name

The connection name will be referenced by integrations that use this connection.

Connection URL [Info](#)

The location of your data source that you want Customer Profiles to ingest your objects from.

Client ID [Info](#)

This value distinguishes multiple clients in the same location from one another.

- **Connection name:** Provide a name for your connection. The connection name is referenced by integrations that use this connection.
- **Connection URL:** Enter your application connection URL. This URL is used for deep-linking into the objects created in your external application. The connection URL is the Segment workspace URL available on the application website.

To find your workspace URL:

1. Log in to your segment.com account.
2. Go to **Settings, General settings**.
3. Copy the URL from your browser.

7. Customer Profiles uses Amazon EventBridge for integrations with Segment. On the **Source set up** page, copy your AWS account ID to your clipboard, and then choose **Log in to Segment** to configure Amazon EventBridge.
8. Use the following instructions to set up Segment:

- a. Log in to Segment.
 - b. In your application, select a source to set up the destination to Amazon EventBridge.
 - c. Paste in your AWS account ID and select your AWS Region.
 - d. Toggle **ON**, to activate your partner event source.
9. Go to **Event Tester**, and send a test event to complete activating your partner event source.
 10. **Client ID**: This is a string that uniquely distinguishes the client in your external application. This client ID is the Source Name available on the application website. You use the ID that you specify to identify the client that you want Customer Profiles to ingest your objects from.

To find your source ID:

1. Go to **Sources**, and choose a source.
2. Go to **Settings, API Keys**.
3. Copy your **Source ID**.

After you set up the event source destination, return to the Customer Profiles console and paste the Client ID.

11. You will see an alert that indicates Amazon Connect has successfully connected with Segment.
12. On the **Integration options** page, choose which source objects you want to ingest and select their object type.

Object types store your ingested data. They also define how objects from your integrations are mapped to profiles when they are ingested. Customer Profiles provides default object type templates you can use that define how attributes in your source objects are mapped to the standard objects in Customer Profiles. You can also use the object mappings that you've created from the [PutProfileObjectType](#).

Object type [Info](#)

Select the objects you want to ingest and choose their object type to define how the objects are mapped to profiles.

Segment objects

Identify

Segment-identify (default) ▼

13. For the **Ingestion start date**, Customer Profiles starts ingesting records created after the integration is added.

Note

If you need historical records, you can [use Amazon S3 as an integration source to import them](#).

14. On the **Review and integrate** page, check that the **Connection status** says **Connected**, and then choose **Add integration**.
15. After the integration is set up, back on the **Customer profiles configuration** page, the **Integrations** page displays which integrations are currently set up. The **Last run** and **Integration health** are not currently available for this type of integration.

The screenshot shows the 'Integrations' page in Amazon Connect. At the top right, there are three buttons: 'Delete', 'View objects', and 'Add Integration'. The page displays four integration cards in a 2x2 grid:

- Marketo**: Source object enabled leads. Connector details: MyZendeskConnector. Last run: Wed July 21 2021 15:30:26 GMT-800 (PST). Integration health: Healthy.
- Salesforce**: Source object enabled Account, Asset, Contact. Connector details: MySalesforceConnector. Last run: Wed July 21 2021 15:30:26 GMT-800 (PST). Integration health: Healthy.
- Segment**: Source object enabled Identify. Connector details: MySegmentConnector. Last update: Not available for this type of integration. Integration health: Not available for this type of integration.
- Shopify**: Source object enabled Customer, Order. Connector details: MyShopifyConnector. Last update: Not available for this type of integration. Integration health: Not available for this type of integration.

To see what data is being sent, choose the integration and+ then choose **View objects**.

Verify your Segment integration

To perform this step you need the following prerequisites:

- Access to your Segment workspace.
- [Access to the Amazon Connect Contact Control Panel](#).

To verify your Segment integration

1. Go to your Segment workspace dashboard and choose **Destinations**.

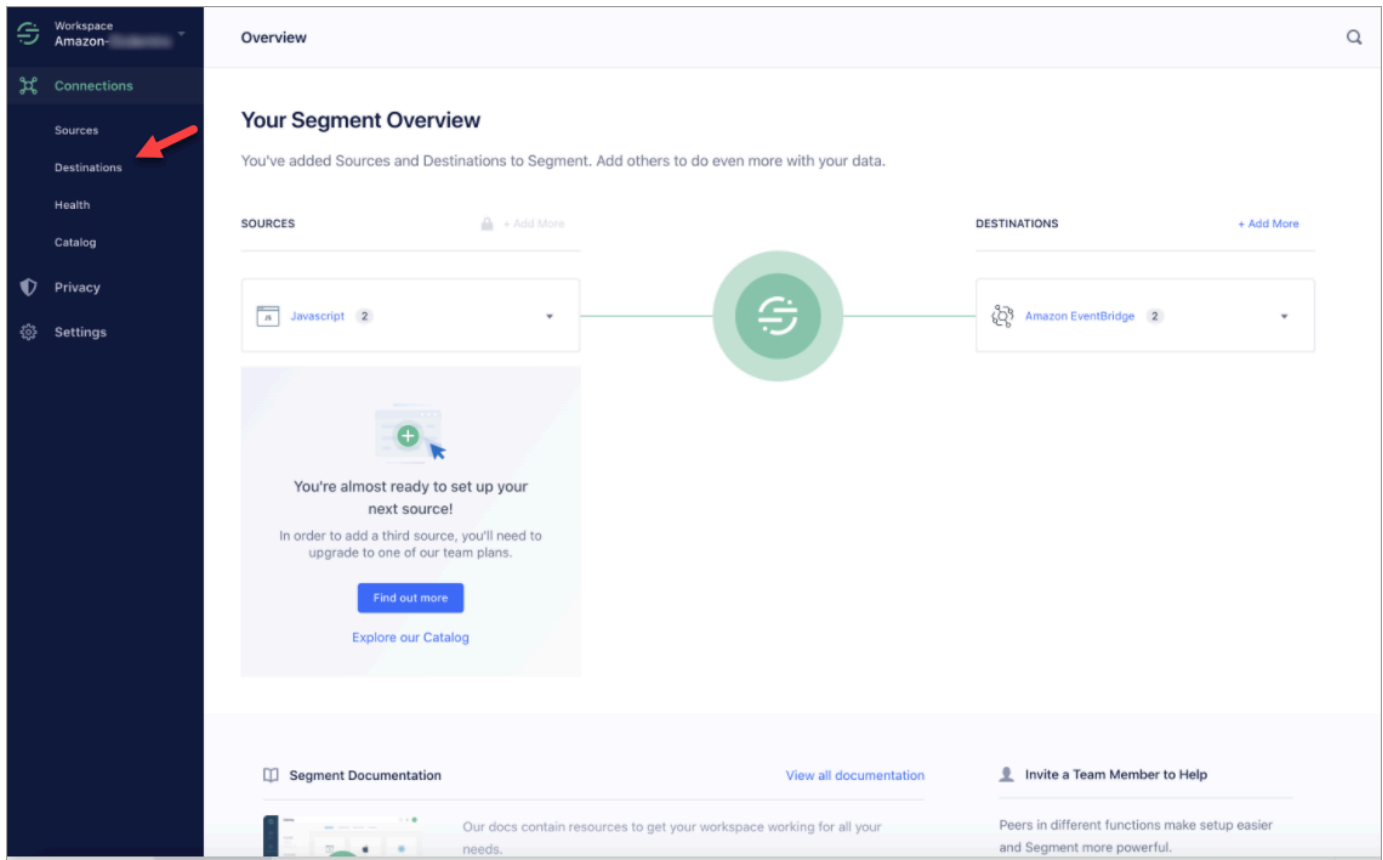

2. You will see a list of destinations where that Segment sends data. Choose the EventBridge destination for Customer Profiles.

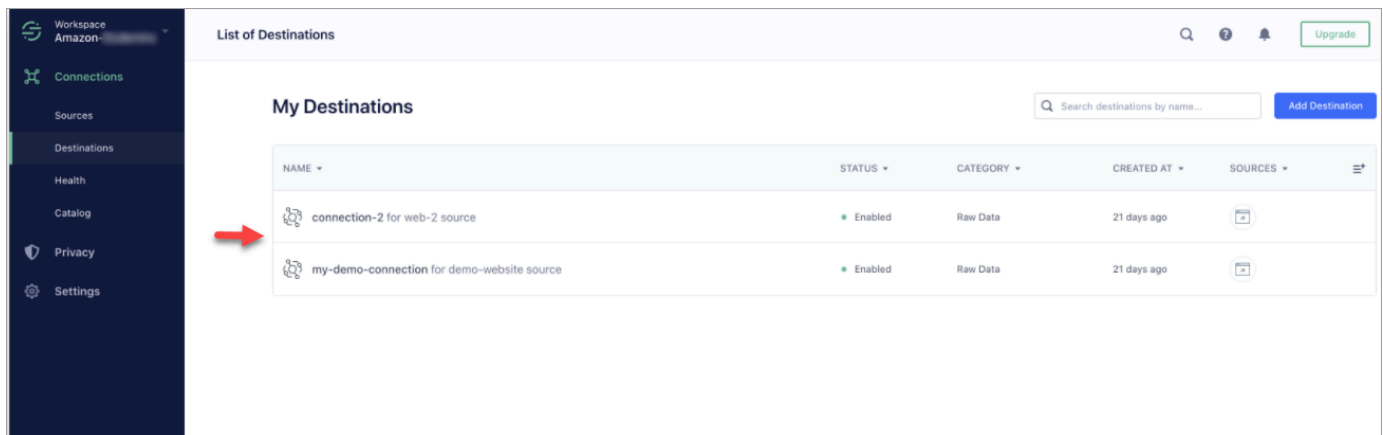

3. Choose the **Event Tester** tab. From this page you will send a test event to Customer Profiles. The event is ingested and turned into a customer profile that you can view in the Amazon Connect agent application.

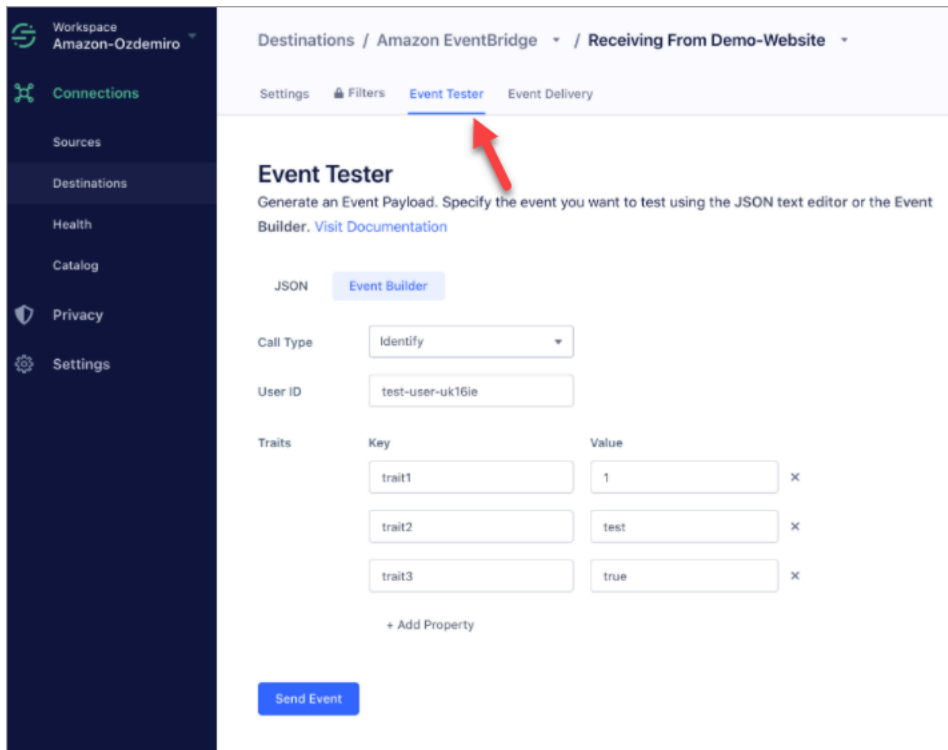

4. Select **Identify** as the event type, and select **Event Builder** as your input method.
5. You can specify a **User ID** and some traits. Agents can search for these traits in the agent application.
6. Choose **Send Event**.
7. The event delivery should be almost instantaneous but allow it a minute for it to be delivered and create a customer profile.
8. Open the Amazon Connect agent application. Search for the user ID you entered in the **Event Builder**. You should be able to see the customer profile with the user ID and the traits you entered.
9. If you cannot see the customer profile, then there is a problem with your integration. To troubleshoot:
 1. Go to the Amazon EventBridge console.
 2. Check whether the EventSource is Active and the matching EventBus exists and is running.

If these are working, contact AWS Support for assistance investigating the issue.

Monitor your Customer Profiles integrations

After your connection is established, if it stops working, delete the integration and then re-establish it.

What to do if objects aren't being sent

If an object fails to be sent, choose **Flow details** to learn more about what's gone wrong.

You may need to delete the configuration and re-connect to the external application.

Set up integration for Shopify

To provide periodic updates to Amazon Connect Customer Profiles, you can integrate with Shopify using Amazon AppIntegrations. You first set up the connection in Amazon Connect and Shopify, and then verify the Shopify integration.

Set up the connection in Amazon Connect and Shopify

1. Open the Amazon Connect console at <https://console.aws.amazon.com/connect/>.
2. On the instances page, choose the instance alias. The instance alias is also your **instance name**, which appears in your Amazon Connect URL. The following image shows the **Amazon Connect virtual contact center instances** page, with a box around the instance alias.

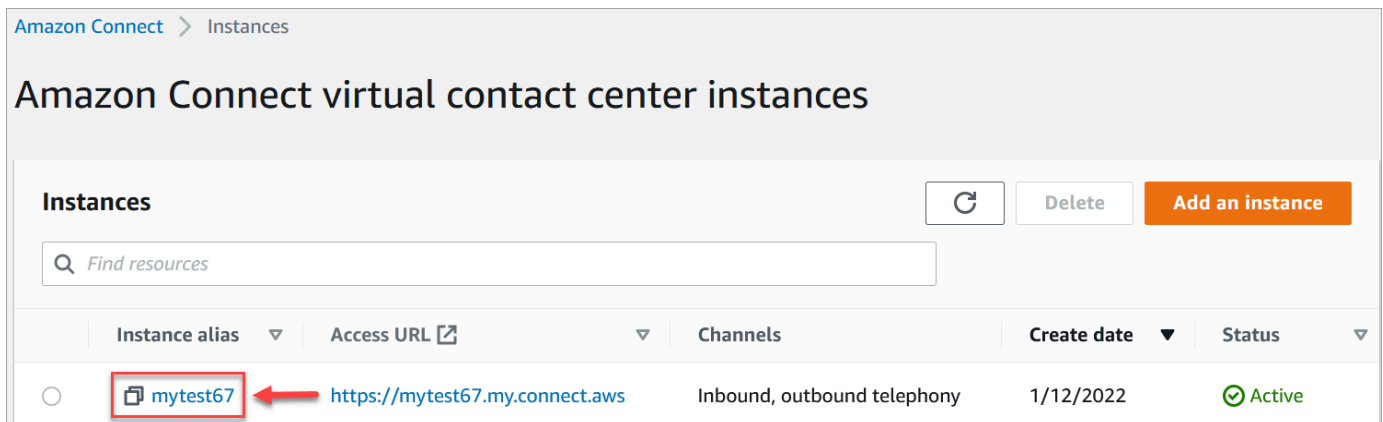

3. In the navigation pane, choose **Customer profiles**.
4. On the **Customer profiles configuration** page, choose **Add integration**.

Customer profiles domain ⓘ Edit

Customer profiles provide a single view of your customers by combining information from multiple applications with contact history from Amazon Connect.

Customer profiles domain CustomerProfiles-ExampleCorp	Dead-letter queue https://sqs.us-west-2.amazonaws.com/ / /CustomerProfiles	KMS key arn:aws:kms:us-west-2: :key/bcb6f6dd-
--	--	--

Integrations Delete View objects Add integration

- On the **Select source** page, choose **Shopify**. Review the application requirements that are listed on the **Select application** page.

Amazon Connect > test-pmt > Customer Profiles > Add data source Integration

Step 1
Select data source

Step 2
Establish connection

Step 3
Select data mapping

Step 4
Review and integrate

Select data source

Amazon Connect instances integrate with multiple data sources. Additional charges may apply. [See pricing](#)

► **How it works**

Data source ⓘ
Supported data connectors, including Amazon AppFlow supported connectors.

Data source
Choose your data source or create a flow in AppFlow if your source is not available.

Shopify ▼ Create new flow

By creating this integration with Shopify, you acknowledge the following ⓘ

I've confirmed that the Shopify instance has a custom or public app set up through Shopify Partners.

Shopify events are ingested only if a profile can be identified through a user ID.

Cancel Next

- On the **Establish connection** page, choose one of the following:
 - Use existing connection:** This allows you to reuse existing Amazon EventBridge resources that you may have created in your AWS account.
 - Create new connection:** Enter the information required by the external application.

Establish a connection with Shopify

Customer Profiles uses Amazon EventBridge to integrate with this data source.

Connection method [Info](#)

Use existing connection
Reuse an existing connection to ingest objects from this data source.

Create new connection
Create a new connection to ingest objects from this data source.

Connection name
The connection name will be referenced by integrations that use this connection.

Connection URL [Info](#)
The location of your data source that you want Customer Profiles to ingest your objects from.

Client ID [Info](#)
This value distinguishes multiple clients in the same location from one another.

- **Connection name:** Provide a name for your connection. The connection name is referenced by integrations that use this connection.
- **Connection URL:** Enter your application connection URL. This URL is used for deep-linking into the objects created in your external application. The connection URL is the Shopify Partner app URL available on the application website.

To find your Shopify Partner app URL:

- Log in to your partners.shopify.com account.
- Go to your app.
- Copy the URL from your browser.
- **Client ID:** Enter your application client ID. This is a string that uniquely distinguishes the client in your external application. This client ID is the Source Name available on the application website. You use the ID that you specify here to identify the client that you want Customer Profiles to ingest your objects from. Your client ID may be available after following the Source setup steps.

To find your source name:

- Log in to your partners.shopify.com account.
 - Go to your app.
 - Copy the source name from your Amazon EventBridge event source.
7. On the **Source set up** page, copy your AWS account ID to your clipboard, and then choose **Log in to Shopify**.
 8. Use the following instructions to set up Shopify:
 - a. Log in to partners.shopify.com.
 - b. Under Amazon EventBridge, choose **Create source**.
 - c. Paste in your AWS account ID and select your AWS Region.
 - d. After you set up the event source destination, return to Customer Profiles. You will see an alert that indicates Amazon Connect has successfully connected with Shopify.
 9. On the **Integration options** page, choose which source objects you want to ingest and select their object type.

Object types store your ingested data. They also define how objects from your integrations are mapped to profiles when they are ingested. Customer Profiles provides default object type templates you can use that define how attributes in your source objects are mapped to the standard objects in Customer Profiles. You can also use the object mappings that you've created from the [PutProfileObjectType](#).

Object type [Info](#)

Select the objects you want to ingest and choose their object type to define how the objects are mapped to profiles.

Shopify objects

Customer
Shopify-customer (default) ▼

Draft
Shopify-draft (default) ▼

Order
Shopify-order (default) ▼

10. For the **Ingestion start date**, Customer Profiles starts ingesting records created after the integration is added.

Note

If you need historical records, you can [use Amazon S3 as an integration source to import them](#).

11. On the **Review and integrate** page, check that the **Connection status** says **Connected**, and then choose **Add integration**.

Note

After adding this integration, you need to [set up webhook subscriptions](#) to allow events to start flowing into this integration.

Integration details	
Integration source Shopify	Status ✔ Connected
Connection name MyShopifyConnection1	AWS KMS key arn:aws:kms:us-east-1:555555555555:key/i- b188560f
Connection URL https://myapp.shopifypartners.com	Object type object 1 : template/mapping object 2 : template/mapping
Partner event source name aws.partner/shopify.com/xxxxxxxxxx	Ingestion start date Today
Partner event source arn arn:aws:events:us-west-2::event-source/ aws.partner/shopify.com/xxxxxxxxxx	
Event bus name aws.partner/shopify.com/xxxxxxxxxx	

12. After the integration is set up, back on the **Customer profiles configuration** page, the **Integrations** section displays which integrations are currently set up. The **Last run** and **Integration health** are not currently available for this type of integration.

The screenshot shows the 'Integrations' page in Amazon Connect. At the top right, there are three buttons: 'Delete', 'View objects', and 'Add integration'. The page displays four integration cards in a 2x2 grid:

- Marketo**: Source object enabled leads. Connector details: MyZendeskConnector. Last run: Wed July 21 2021 15:30:26 GMT-800 (PST). Integration health: Healthy.
- Salesforce**: Source object enabled Account, Asset, Contact. Connector details: MySalesforceConnector. Last run: Wed July 21 2021 15:30:26 GMT-800 (PST). Integration health: Healthy.
- Segment**: Source object enabled Identify. Connector details: MySegmentConnector. Last update: Not available for this type of integration. Integration health: Not available for this type of integration.
- Shopify**: Source object enabled Customer, Order. Connector details: MyShopifyConnector. Last update: Not available for this type of integration. Integration health: Not available for this type of integration.

To see what data is being sent, choose the integration and then choose **View objects**.

13. Go to the next step to use the API to set up **webhook subscriptions** so events can start flowing into this integration.

Set up webhook subscriptions

1. Use the following URL to make sure your app has the required permissions:

```
https://{shop}.myshopify.com/admin/oauth/authorize?
client_id={api_key}&scope={scopes}&redirect_uri={redirect_uri}&state={nonce}
```

Where:

- `shop` is the name of your Shopify store.
- `api_key` is the API Key of your Shopify app. You can find this on the Shopify **App** details page.

- scopes should have the value `read_customers, read_orders, read_draft_orders`.
- `redirect_uri` is the redirect URI you specified for your app when you created it. For our purposes it can be any valid URL.
- `nonce` can be any unique value to identify a given authorization request from others. We recommend using a timestamp.

After you have constructed the URL, paste it into your browser. An installation/authorization page similar to the following image is displayed, asking the store owner to give permissions for the defined scope.

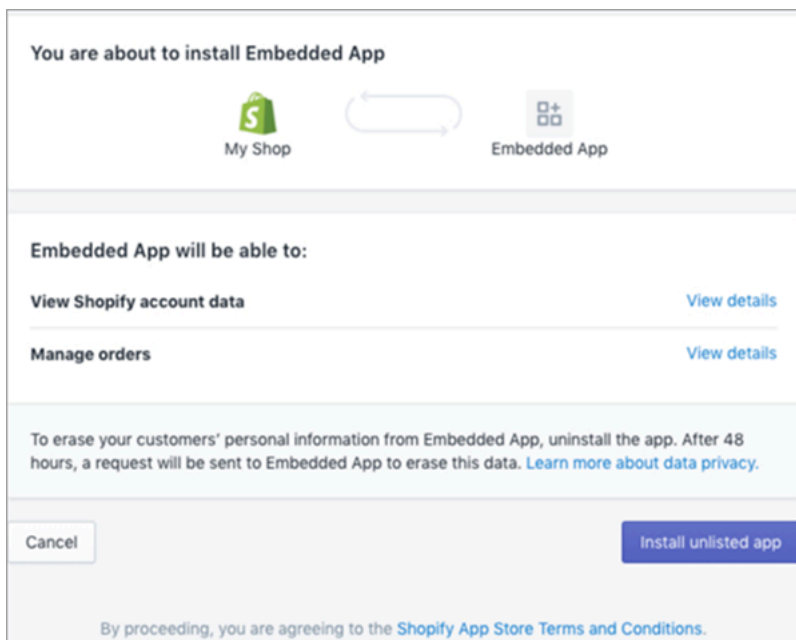

2. Choose **Install unlisted app** to install and authorize the app on behalf of your store.

You will be taken to the redirect URI that you entered with an authorization code appended to redirect URI as a query parameter. For example:

```
https://example.org/some/redirect/uri?code={authorization_code}&hmac=da9d83c171400a41f8db91a950508985&host={base64_encoded_hostname}
```

3. Copy the `authorization_code` from this URI. You're going to use it to get a permanent access token in the next steps.
4. Go to whatever tool you use to make API calls. For example, [CURL](#) or [POSTMAN](#).
5. To get a permanent access token, make a POST request to the Shopify Admin API to this endpoint:

```
https://{shop}.myshopify.com/admin/oauth/access_token
```

with the following request body:

```
{
  "code": "authorization_code_received_from_redirect_uri",
  "client_id": "your_app_api_key",
  "client_secret": "your_app_api_secret"
}
```

This request returns the following response:

```
{
  "access_token": "permanent_access_token",
  "scope": "read_customers,read_orders,read_draft_orders"
}
```

- Note the `access_token`. This is a permanent token that has the provided scope from a previous step. Now you are ready to create webhook subscriptions.
- For the following API calls, make sure you set the HTTP header key `X-Shopify-Access-Token` to the `access_token` you received from the earlier call's response.
- To setup webhook subscriptions, make the following POST request for each of the `topic` values listed in the next step:

Endpoint: `https://{shop}.myshopify.com/admin/api/2021-04/webhooks.json`

Request Body:

```
{
  "webhook": {
    "topic": "replace_this_with_one_of_the_topics_in_the_list_below",
    "address":
      "this_is_the_event_source_arn_generated_when_you_created_the_event_integration",
    "format": "json"
  }
}
```

- For each subscription replace the value for `topic` with the following values:

- customers/create
- customers/enable
- customers/update
- draft_orders/create
- draft_orders/update
- orders/cancelled
- orders/create
- orders/fulfilled
- orders/paid
- orders/partially_fulfilled
- orders/updated

You're now all set to receive events from your Shopify store. Next, verify your Shopify integration.

Verify your Shopify integration

1. Sign in as Admin to your Shopify Store.
2. In the left navigation menu, choose **Customers**.
3. Select **Add Customer**.
4. Enter your customer details. Be sure to enter a phone number and email. These don't have to belong to a real customer. You will delete this customer entry after verifying the integration.
5. Save the customer object.
6. The event delivery should be almost instantaneous but allow a minute for it to be delivered and to create a customer profile.
7. Open the Amazon Connect agent experience and look up the user by the email or phone number you entered into the Shopify Store. You should be able to see the customer profile with the same email or phone number.
8. If you cannot see the customer profile, then there is a problem with your integration. To troubleshoot:
 1. Go to the Amazon EventBridge console.
 2. Check whether the EventSource is Active and the matching EventBus exists and is running.

If these are working, contact AWS Support for assistance investigating the issue.

Monitor your Customer Profiles integrations

After your connection is established, if it stops working, delete the integration and then re-establish it.

What to do if objects aren't being sent

If an object fails to be sent, choose **Flow details** to learn more about what's gone wrong.

You may need to delete the configuration and re-connect to the external application.

Set up integration for external applications using Amazon AppFlow

These integrations use Amazon AppFlow to provide periodic updates to Amazon Connect Customer Profiles. The below steps provide guidance on configuring a connector of your choosing using Amazon AppFlow, configure data mappings, and configure integrations to ingest your customer data.

For more information on Amazon AppFlow pricing, see Amazon AppFlow [pricing](#).

For more information on Amazon AppFlow supported connectors see [Supported source and destination applications](#).

Before you begin

When you enable Amazon Connect Customer Profiles you create a Customer Profiles domain, which is a container for all data, such as customer profiles, object types, profile keys, and encryption keys. The following are guidelines for creating Customer Profile domains:

- Each Amazon Connect instance can only be associated with one domain.
- You can create multiple domains, but they don't share external application integrations or customer data between each other.
- All the external application integrations you create are at a domain level. All of the Amazon Connect instances associated with a domain inherit the domain's integrations.

Prerequisite: Enable Customer profiles in your Amazon Connect instance

1. Open the Amazon Connect console at <https://console.aws.amazon.com/connect/>.
2. On the instances page, choose the instance alias. The instance alias is also your **instance name**, which appears in your Amazon Connect URL. The following image shows the **Amazon Connect virtual contact center instances** page, with a box around the instance alias.
3. In the navigation pane, choose **Customer profiles**.
4. Choose enable Customer Profiles

In the form, you will be required to complete all the mandatory fields to create a Customer Profiles domain by following the steps below:

1. **Domain Setup.** You can Create New Domain and provide a name.
2. **Encryption.** Under Specify KMS key, you can enable encryption by either selecting an existing AWS KMS key, creating a new AWS KMS key, or you can choose **Select existing domain**.
3. **Error Reporting.** You can provide a Dead letter queue, which is an SQS queue to handle customer profile errors
4. Choose **Submit** and Customer Profiles will be get created using the Contact History information of your instance.

Set up an external application using Amazon AppFlow

You can add an external application integration to an Amazon Connect Customer Profiles domain by using Amazon AppFlow by following steps below. You must create a flow for your data source in the Amazon AppFlow console and set Amazon Connect Customer Profiles as the destination prior to continuing in the Customer Profiles console. If you created a flow more than 14 days ago, it has expired and you will need to create a new flow for your integration.

You can optionally perform data transformations such as `Arithmetic`, `Filter`, `Map`, `Map_all`, `Mask`, `Merge`, `Truncate`, and `Validate` when using the AWS CloudFormation `AWS::AppFlow::Flow` Task resource prior to ingestion.

1. Log into your AWS Management Console, select Amazon AppFlow, and choose **Create flow**.

Amazon Web Services (AWS)

Amazon AppFlow

Securely integrate apps and easily automate data flows without code

Amazon AppFlow is a fully managed integration service that lets you securely transfer data between Software-as-a-Service (SaaS) applications and AWS services. Use Amazon AppFlow to automate your data transfers in just a few minutes. No coding is required.

Launch Amazon AppFlow

Create your first flow. Select the app to connect, what data to transfer, and a trigger for starting your flow.

[Create flow](#) [View flows](#)

2. Enter the flow name and an optional flow description.

Flow details [Info](#)

Flow name

Flow description - optional
Describe the flow in your own words

3. You can leave the **Data encryption** section as it is since your Amazon Connect Customer Profiles domain already has an existing AWS KMS key that will be used for this Flow. You can optionally create tags and then choose **Next**.

Data encryption [Info](#)

Amazon AppFlow encrypts your access tokens, secret keys, and data in transit and data at rest. Encryption for data at rest is currently available for Amazon S3 only.

Your data is encrypted by default with a key that AWS owns and manages for you. To choose a different key, customize your encryption settings.

Customize encryption settings (advanced)

4. Select an external application of your choice in the **Source name** dropdown and then select the next relevant field. For example, if you wish to configure Slack, select Slack from the **Source name** dropdown. You can then either select an existing Slack flow or create a new connection.

The screenshot displays the 'Configure flow' interface. On the left, a sidebar lists five steps: Step 1 (Specify flow details), Step 2 (Configure flow), Step 3 (Map data fields), Step 4 (Add filters), and Step 5 (Review and create). The main area is titled 'Configure flow' and features a 'Source details' section. This section includes a 'Source name' dropdown menu with 'Slack' selected, accompanied by the Slack logo and the text 'Slack is a channel based messaging platform.' Below this is a 'Choose Slack connection' section with an 'Info' link, a search bar containing 'Select connection', and a 'New connection' button. At the bottom of this section is a 'Create new connection' button.

5. If you chose to create a new connection, you can then enter the external application's details such as user name, password and subdomain. You can also select the AWS KMS key for data encryption and enter the connection name to identify this connection.

Connect to Slack ✕

Client ID

Client secret

Workspace
https:// .slack.com

Data encryption
AWS KMS key
AWS managed key
KeyId:

Connection name

Cancel Continue

6. If you choose to use an existing connection you can select the specific external application object from dropdown. For example, If choosing an existing Slack connection, you can select **Conversations** as the object and then choose the specific Slack channel that will be used.

Source details [Info](#)

Source name

Choose Slack connection [Info](#)

Choose Slack object

Choose Slack channel

7. In the **Destination details** section, select Amazon Connect as the Destination name in the dropdown and select the Customer profile domain created in the previous prerequisite step.

Destination details [Info](#)

Destination name

Amazon Connect

Amazon Connect is a contact center that enables engagement at any scale.

▼

Amazon Connect

Customer Profiles

▼

Customer Profiles domain

Choose domain

▼

8. Select a flow trigger by choosing **Run on demand** or **Run flow on schedule**. Choose **Next**.
- **Run on demand** runs the flow only when you trigger it.
 - **Run flow on schedule** runs the flow at a specific time by using a schedule. The schedule frequency is limited to 5 minutes, 15 minutes, or 1 hour.

Flow trigger [Info](#)

Choose how to trigger the flow

Trigger a flow by an event, run on a schedule, or run manually by choosing the Run flow button.

Run on demand

Flow will run immediately when you trigger it.

Run flow on schedule

Flow will run at specified times.

Run flow on event

Flow will run when an event occurs.

i Your flow will run when you choose the Run flow button on the Flow details page.

Cancel Previous Next

9. Choose **Manually map fields** under **Mapping method**. Choose the source fields from external application and then choose **Map fields directly**.

Step 2
Configure flow

Step 3
Map data fields

Step 4
Add filters

Step 5
Review and create

Mapping method

- Manually map fields**
Select one or more source fields and map them to selected destination field.
- Upload a .csv file with mapped fields**
Create and upload a .csv file that has source and destination fields already mapped.
- Passthrough fields without modification**
Fields found in input files will be written to the destination without modification. Recommended for input data with hierarchical structure.

Source to destination field mapping

Choose how source fields are mapped to destination fields.

Slack → **Amazon Connect Customer Profiles**

Source field name: → Destination:

Map fields directly **Map fields with formula**

Mapped fields (20/20) [Clear selection](#) [Add formula](#) [Modify values](#) [Remove selected mappings](#)

< 1 2 >

<input checked="" type="checkbox"/>	Source field name	Destination field name	Formula	Data modifications
<input checked="" type="checkbox"/>	Attachments attachments	Attachments attachments	-	-
<input checked="" type="checkbox"/>	Bot Id bot_id	Bot Id bot_id	-	-

10. Review and choose **Create flow**.

For more information on creating flows in the Amazon AppFlow console, see [Creating flows in Amazon AppFlow](#).

For more information on the setup of external application and many other supported applications in Amazon AppFlow, see [Supported Amazon AppFlow source and destination applications](#).

Set up data mappings to define how external application data is mapped to a Customer Profile

Once Amazon AppFlow integration has been set up, you need to set up data mappings in Customer Profiles to define how data from the external application will be mapped to the Customer Profile. This will allow you to customize the data that you want to use to build your unified customer profile. Choose your mapping carefully, as you will not be able to choose a different mapping after creating the integration.

For more detailed information on data mappings, see [Object type mapping](#).

1. Log into your AWS Management Console, select **Amazon Connect**, and choose **Customer Profiles** under your connect instance alias.

Amazon Connect ×

Amazon Connect > demo-instance-pdx > Customer Profiles

Amazon Connect Customer Profiles

Customer Profiles automatically integrates with your customer data from Amazon Connect. Combined with customer information from integrations with your applications, you can create a customer profile that contains all the information that agents need during customer interactions. [Learn more](#)

Customer Profiles domain View details

Customer Profiles domain ⓘ amazon-connect-...	KMS key ⓘ arn:aws:kms:us-west-2:...	Last modified March 18, 2022, 21:34 (UTC)
--	--	--

Profile metrics
Overall profiles in this Customer Profiles domain since the last update.

Total profiles
734

Last updated: September 12, 2022

2. Choose **Data mappings** and then choose **Create data mapping**. Provide a Data Mapping name and a description.

Data source integrations | **Data mappings** | Data flows

Data mappings (4) Info

Set up data mappings to define how data from your data sources are mapped to the customer profile.

Q Search by data mapping name, status, data source, or source object < 1 > ⚙

Name ▲	Status ▼	Data source ▼	Source object ▼	Last updated
--------	----------	---------------	-----------------	--------------

Amazon Connect > Customer Profiles > Create data mapping

Step 1
Set up data mapping

Step 2
Map attributes

Step 3
Specify identifiers

Step 4
Review and create

Set up data mapping Info

Description

Data mapping name
Specify a name that will help you distinguish the source or type of data used by this mapping.

Enter name

The name must start with a letter or number. It can contain up to 128 characters, which can be letters, numbers, underscores (_), or hyphens (-).

Description

Enter description

3. Under **Mapping options**, you can choose your **Data source** as the external application, the **Flow name** that you created in the previous section, and the **Data definition method** as *Mapping destination*. Under **Mapping destination** you can choose the types of customer data that wish to define for your unified customer profiles. Choose **Next**.

Mapping options

Data source
Choose the data source you want to transfer customer data from with this mapping.

Select data source ▼

Source object
Choose the source object to build your unified customer profile. The source object contains attributes for your mapping destination.

Select source object ▼

Data definition method
Specify how you want to define the customer data that you want to ingest. For each option, you will be able to create custom data attributes on a profile, and customize the search attributes to find profiles.

Mapping destination
Choose this option to include selecting the type of customer data that you want to define.

Identifiers only
Choose this option to ingest your data without requiring a mapping destination.

Mapping destination | [Info](#)
Select the type of customer data that you want to define in the next steps for your unified customer profile.

Customer
Populate customer contact information, such as a phone number, with your data.

Product
Populate customer product purchase information, such as a book purchase, with your data.

Case
Populate customer case information, such as a customer ticket, with your data.

Order
Populate customer order information, such as a purchase confirmation, with your data.

▶ **Additional options**
To help manage costs, you can opt out of creating new profiles. You can also specify a shorter retention period.

4. Add customer, product, case and order attributes with source, destination, and content type, then choose **Next**.

Amazon Connect > test-pmt > Customer Profiles > Create data mapping

Step 1
Set up data mapping

Step 2
Map customer attributes

Step 3
Map product attributes

Step 4
Map case attributes

Step 5
Map order attributes

Step 6
Review and create

Map order attributes Info

By default, we provide a template for mapping a subset of your source data to help you get started. You can remove what you don't want populated in the customer profile, change the source, and add custom attributes.

Order attributes Info Add all sources Reset template

Map your customer order information to the standard attributes.

Source	Destination	Content type	
1. user	CreatedDate	STRING	Options

Add attribute

Cancel Previous Next

5. Under **Specify identifiers**, you can select various attributes from your data source object that helps distinguish your data from other data source objects. You can select attributes from unique, customer, product, case and order identifiers. For more information about identifiers, see [Standard identifiers](#).

Amazon Connect > test-pmt > Customer Profiles > Create data mapping

Step 1
Set up data mapping

Step 2
Map customer attributes

Step 3
Map product attributes

Step 4
Map case attributes

Step 5
Map order attributes

Step 6
Specify identifiers

Step 7
Review and create

Specify identifiers

You must set up identifiers for your data. This helps Customer Profiles resolve conflicts and match your incoming data to existing profiles. It also allows the data to be indexed so that it is searchable.

Additional identifiers - optional
Choose attributes in your data source object that you want to use as the unique, customer, product, case, and order identifier, and search attribute.

Add Identifier

Unique identifier Info
Choose one attribute in your data source object that helps distinguish your data from other data source objects.

Attribute	Identifier name
Source.user : Customer.PhoneNumber	

Customer identifier Info
Choose one or more attribute in your data source object that can distinguish the customer and be used to find profiles.

Attribute	Identifier name	
Source.user : Customer.PhoneNumber		Remove

► Additional properties

Add customer Identifier

6. Review and choose **Create Data Mapping**. The Data Mapping status will show as *Active*.

Step 6: Specify identifiers Edit

Identifiers

Identifiers

5 identifiers defined

Data object timestamp

yyyy-MM-dd'T'HH:mm:ss.SSSZ

Cancel Previous Create data mapping

Set up integrations to ingest your customer data from an external application

Once the data mapping set up is done for an external application, you will set up the Data source integration to ingest your customer data.

1. Log into your AWS Management Console, select **Amazon Connect**, and choose Customer Profiles under your connect instance alias.
2. Under the **Data source integrations** section choose **Add data source integration**.

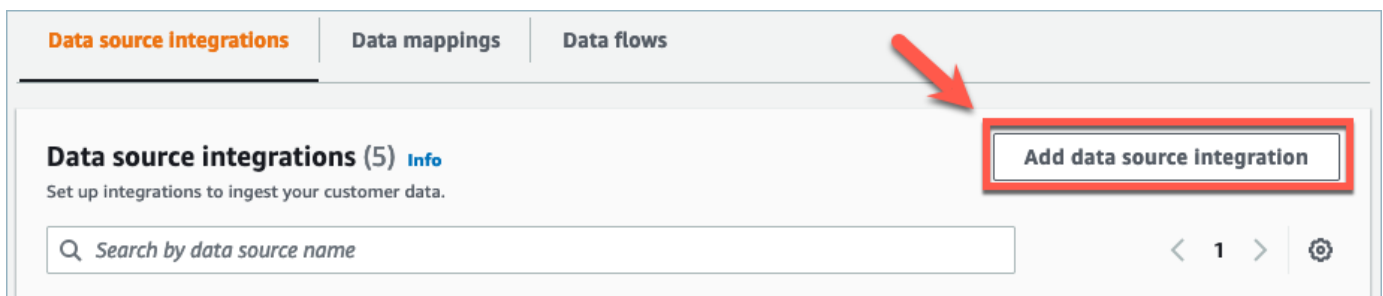

The screenshot shows the 'Data source integrations' section of the Amazon Connect console. The 'Data source integrations' tab is selected, and the 'Add data source integration' button is highlighted with a red box and a red arrow. The console displays 'Data source integrations (5) Info' and a search bar for 'Search by data source name'.

3. Under the **Data source** dropdown, select the external application and choose **Next**. You also have the option to choose **Create new flow** which will open the Amazon AppFlow console in a new tab.

Amazon Connect > Customer Profiles > Add data source integration

Step 1
Select data source

Step 2
Establish connection

Step 3
Select data mapping

Step 4
Review and integrate

Select data source

Amazon Connect instances integrate with multiple data sources. Additional charges may apply. [See pricing](#)

► **How it works**

Data source [Info](#)
Supported data connectors, including Amazon AppFlow supported connectors.

Data source
Choose your data source or create a flow in AppFlow if your source is not available.

Choose source ▼ Create new flow [↗](#)

Cancel Next

- Under the **Flow name** dropdown, select the flow you want to use from your data source and choose **Next**.

Learn more' and 'If you created a flow more than 14 days ago, it has expired and can't be used for this integration. You need to create a new flow for your data source.' At the bottom right of the main content area are 'Cancel', 'Previous', and 'Next' buttons."/>

Amazon Connect > Customer Profiles > Add data source integration

Step 1
[Select data source](#)

Step 2
Establish connection

Step 3
Select data mapping

Step 4
Review and integrate

Establish connection

Establish a connection with Slack
Customer Profiles uses Amazon AppFlow to ingest data sources offered through AppFlow.

Flow name
Choose the flow you want to use from your data source.

Choose flow ▼ Create new flow [↗](#)

Can't find your flow?

- Create a flow for your data source in Amazon AppFlow and set Amazon Connect Customer Profiles as the destination. Then return to this page to continue setting up the integration. [Learn more](#)
- If you created a flow more than 14 days ago, it has expired and can't be used for this integration. You need to create a new flow for your data source.

Cancel Previous Next

- Under the **Data Mapping** dropdown, select the external application data mapping for the object to define how your data source is mapped to profiles. Choose **Next**.

Amazon Connect > Customer Profiles > Add data source integration

Step 1
Select data source

Step 2
Establish connection

Step 3
Select data mapping

Step 4
Review and integrate

Select data mapping

Object and mapping Info
Select the object you want to ingest and choose their mapping to define how your data source is mapped to profiles.

Slack
Choose data mapping.

Object: conversations/...

Mapping: Choose data mapping

Can't find your data mapping?

- Select **Create data mapping** to create a new mapping. Then return to this page to continue setting up the integration. [Learn more](#)
- Choose your mapping carefully. You can't choose a different mapping after creating the integration.

[Create data mapping](#)

6. Review and choose **Add data Source Integration**. The datasource integration of the external application will initially show as pending before moving to an active state.

Amazon Connect > Customer Profiles > Add data source integration

Step 1
Select data source

Step 2
Establish connection

Step 3
Select data mapping

Step 4
Review and integrate

Review and integrate

Integration details

Data source
Slack - powered by AppFlow

Flow name
SlackTest3

Status
✔ **Connected**

AWS KMS key
arn:aws:kms:us-west-2-...

Data mapping

Object and mapping
conversations/... : SlackConversation

Ingestion start date
Today

Cancel [Previous](#) [Add data source integration](#)

View the unified customer profile in Amazon Connect Customer Profile Agent CCP

Your agents will now be able to view customer data that has been imported from an external application by logging in to the Amazon Connect Agent CCP. For more information on connecting to the Amazon Connect Agent CCP, see [Agent application: Everything in one place](#).

Your agent will need to have the appropriate security profile permissions to view Customer Profiles and will be able to perform searches using a key name and value in the profiles search bar.

For more information on security profile permissions, see [Security profiles](#).

Advanced users who want to build their own custom agent application and embedded customer profiles can use [StreamsJS](#) which provides more customization over the agent application.

Delete/stop Customer Profiles integrations

Note

Deleting mappings will only delete objects and data associated with that specific mapping. If there are multiple objects associated with a profile, then deleting a specific mapping may not clear the profile data. If you want to delete specific data, then you would delete the mapping, but your profiles may still exist if they contain data from other mappings. This could result in additional charges for the existing profiles. You can delete a domain and all data from Customer Profiles, including all profiles, by using the [Amazon Connect console](#) or the [DeleteDomain](#) API.

Console method

- If at any time you want to stop the ingestion of customer profile data, choose the integration/mapping and then choose **Delete**.
- To delete the integrations, customer profiles, and all the customer profile data, you can delete your customer profiles domain in the Amazon Connect console. For more information, see [Delete Customer Profiles domain](#).

API method

- To delete customer profiles data for a specific integration, use the `DeleteProfileObjectType` API.

- To delete the integrations, customer profiles, and all the customer profile data, use the `DeleteDomain` API.

To re-enable the ingestion of customer profile data, go through the setup steps again.

Object type mapping

Contents

- [Concepts and terminology for customer object type mappings](#)
- [Create an object type mapping](#)
- [Object type mapping definition details](#)
- [Additional properties of object types](#)
- [Inferred profiles](#)
- [Contact record templates](#)
- [Automatically associate the Contact Record with one profile found using the `_phone` key](#)
- [Examples of object type mappings](#)
- [Implicit profile object types](#)
- [Generative AI powered data mapping](#)
- [Customer Profiles data limits](#)

Concepts and terminology for customer object type mappings

The following terminology and concepts are central to your understanding of custom object type mappings.

Standard profile object

A standard profile object is a predefined object that all profiles contain.

A standard profile object contains standard fields, such as phone numbers, email addresses, name and other standard data. This data can be retrieved in a standard format regardless of the source (for example, Salesforce, ServiceNow, or Marketo).

Profile object

A *profile object* is a single unit of information known about a profile. For example, the information about a phone call, a ticket, a case, or even a click-stream record from a web site.

A single profile object can be up to 250 KB and can be any structured JSON document.

- Every profile object has a type. For example, the profile object can be an Amazon Connect contact record, ServiceNow Users, or Marketo Leads.
- The type refers to the object type mapping.
- The object type mapping defines how that specific object should be ingested into Customer Profiles.

Profile

A *profile* contains all the information known about a specific customer or contact. It includes a single standard profile object and any number of additional profile objects.

Object type mapping

The *object type mapping* tells Customer Profiles how to ingest a specific type of data. It provides Customer Profiles with the following information:

- How data should be populated from the object and ingested into the standard profile object.
- What fields should be indexed in the object and how those fields should then be used to assign objects of this type to a specific profile.

Mapping template

A *mapping template* is a predefined object type mapping included with the Customer Profiles service.

Customer Profiles includes mapping templates for Amazon Connect contact records, Salesforce Accounts, ServiceNow Users, and Marketo Leads. For a complete list of available mapping templates, use the [ListProfileObjectTypeTemplates](#) API.

With mapping templates you can quickly ingest data from well known sources without having to specify any additional information.

Create an object type mapping

An object type mapping tells Customer Profiles how to ingest a specific type of data from a source application—such as Salesforce, Zendesk, or S3—into a unified standard profile object. You can

then display data in that object (for example, customer address and email) to your agents using the [Amazon Connect agent application](#).

The object type mapping provides Customer Profiles with the following information:

- How data should be populated from the object and ingested into the standard profile object.
- What fields should be indexed in the object and how those fields should then be used to assign objects of this type to a specific profile.

There are two ways you can create an object type mapping:

- Use the Amazon Connect console. The user interface makes data mapping features readily accessible. For example, you can add custom attributes, and define search and unique identifiers for contact models. No coding required!
- Use the Customer Profiles API. For more information, see the [Amazon Connect Customer Profiles API Reference](#).

This topic explains how to create a mapping using the Amazon Connect console.

Create a data mapping using the Amazon Connect console

Amazon Connect provides a no-code experience for mapping customer data from homegrown and third-party applications with Amazon S3, Salesforce, ServiceNow, Zendesk, and Marketo.

To create a data mapping, you define an object type mapping that describes what the custom profile object looks like. This mapping defines how fields from your data can be used to either populate fields in the standard profile or how they can be used to assign the data to a specific profile.

Step 1: Set up data mapping

1. Open the Amazon Connect console at <https://console.aws.amazon.com/connect/>.
2. On the instances page, choose the instance alias. The instance alias is also your **instance name**, which appears in your Amazon Connect URL. The following image shows the **Amazon Connect virtual contact center instances** page, with a box around the instance alias.

Amazon Connect > Instances

Amazon Connect virtual contact center instances

Instances Refresh Delete Add an instance

Find resources

Instance alias	Access URL	Channels	Create date	Status
mytest67	https://mytest67.my.connect.aws	Inbound, outbound telephony	1/12/2022	Active

3. In the navigation pane, choose **Customer profiles, Data mappings**.
4. Choose **Create data mapping** to get started.
5. At the **Set up data mapping** page, in the **Description** section, add a name that will help you identify the source or purpose of this mapping. This is the meta-data of the object type.
6. In the **Data source** section:
 - a. Choose where the data is coming from, such as Salesforce or Zendesk. Based on your selection, Amazon Connect automatically selects the available destinations based on the predefined template.
 - b. Choose the source object. This is used for you to build your unified profile.
 - c. In the **Mapping destination** section, choose the data that you want to use to build your unified customer profile. This information can be surfaced to your flows and agents to personalize the interactions with contacts.

For more information about supported mapping destinations, see [About mapping destinations](#).

- d. In the **Additional options** section, you can choose when to opt out of creating new profiles, and how long to retain them. These options help you manage costs.

Note

By default the domain retention period is 366 days. To change the retention period set on your domain, use the [UpdateDomain](#) API.

7. If you chose a source other than S3, in the **Establish a connection with *application*** section, choose an existing Amazon AppFlow or Amazon EventBridge connection to connect your data,

or create a new connection. You can create a new connection by entering details about your account for this data source.

After the connection is established, you will choose the objects that you want to ingest from your data source.

8. Choose **Next**.

Step 2: Map attributes

On the **Map *type* attributes** page, you'll see the field mappings table filled with the predefined template, based on the mapping destination. For example, it's filled with customer, product, case, or order attributes. You can change the predefined template by choosing an attribute (such as AccountNumber) and then selecting a different destination, or enter one of your own custom attributes.

The following image shows an example of the page filled with customer attributes from the template.

The screenshot shows the 'Map customer attributes' page in Amazon Connect. The page title is 'Map customer attributes' with an 'Info' link. Below the title is a sub-header 'Customer attributes' and a description: 'Map your customer contact information to the standard attributes.' There are two buttons: 'Add all sources' and 'Reset template'. The main content is a table with three columns: 'Source', 'Destination', and 'Content type'. The table has four rows of mappings:

	Source	Destination	Content type	
1.	AccountNumber	AccountNumber	Select type	Options
2.	BillingStreet	BillingAddress.Address1	Select type	Options
3.	BillingCity	BillingAddress.City	Select type	Options
4.	BillingCountry	BillingAddress.Country	Select type	Options

You can remove what you don't want populated in the customer profile, change the source, and add custom attributes.

This mapping uses your data source to populate customer contact information, such as a phone number in the customer profile. It uses attributes from the standard profile template.

Tip

- If you choose to add custom attributes, the destination will always have the prefix `Attributes.` added to it. This enables Amazon Connect to recognize that it is a custom attribute.

The screenshot shows the 'Map customer attributes' page in Amazon Connect. The page title is 'Map customer attributes' with an 'Info' link. Below the title is a subtitle: 'You can add attributes individually or add all attributes from your source to populate the customer profile.' There are two buttons: 'Add all sources' and 'Reset'. The main content is a table with three columns: 'Source', 'Destination', and 'Content type'. The table has five rows:

	Source	Destination	Content type	
1.	AccountNumber	AccountNumber	Select type	Options
2.	BillingCity	BillingAddress.City	Select type	Options
3.	BillingCountry	BillingAddress.Country	Select type	Options
4.	Social Security	Attributes.Social Security	Select type	Options
5.	Loyalty Status	Attributes.Loyalty Status	Select type	Options

Below the table is an 'Add attribute' button. A red arrow points to this button. At the bottom right of the form are 'Cancel', 'Previous', and 'Next' buttons.

- Agents can now view custom attributes in the Connect Agent Application under the **Additional Information** tab sorted in alphabetical order. You can create the name of your choice for each attribute that will be displayed to agents by using the following format: `/^Attributes\[a-zA-Z0-9\]+(?:[_-]+[a-zA-Z0-9]+)*$/`
- All ingested custom attributes will be displayed in the Connect Agent Application. If you do not wish to show certain information to your agents, do not ingest custom attributes at this time.

Step 3: Specify identifiers

On the **Specify identifiers** page, complete the following sections. Depending on what data you're mapping, it's possible not all of these will appear on your page.

Note

The names `_profileId`, `_orderId`, `_caseId`, and `_assetId` are reserved for internal use. If you decide to use these names as one of your identifier names, they must be declared as `LOOKUP_ONLY`, which means our system will not save them to match with profiles, standard assets, standard orders, standard cases, or save them for searching your profile, asset, case, or order. If you would like these keys to be usable for searching and matching, you must rename your key. For more information on the `LOOKUP_ONLY` standard identifier, see [Standard identifiers](#).

- **Unique identifier:** You must have a unique identifier for your data in order to avoid an error when it is ingested. This identifier is also known as the unique key. Customer Profiles uses it to distinguish this data from other data source objects, and to index for search and update data.

There can be only one unique identifier.

- **Customer identifier:** You must have at least one customer identifier for your data in order to avoid an error when it is ingested. The identifier is also known as the profile key.

Customer Profiles uses it to determine if the data case be associated to an existing profile or used to create a new profile by searching other profiles for this identifier.

You can have multiple customer identifiers.

Tip

Agents can use any of these customer Identifiers in the Agent Workspace to find the profile that belongs to customer on the interaction.

- **Product identifier:** You must have at least one product identifier for your data in order to avoid an error when it is ingested. The identifier is also known as the asset key.

Customer Profiles uses it to distinguish this data from other customer product purchase data. It is also used to determine if the data can be associated to an existing profile or used to create a new profile by searching other profiles for this identifier.

You can have multiple product identifiers.

- **Case identifier:** You must have at least one case identifier for your data in order to avoid an error when it is ingested. The identifier is also known as the case key.

Customer Profiles uses it to distinguish this data from other customer case data. It is also used to determine if the data can be associated to an existing profile or used to create a new profile by searching other profiles for this identifier.

You can have multiple case identifiers.

- **Order identifier:** You must have at least one order identifier for your data in order to avoid an error when it is ingested. The identifier is also known as the order key.

Customer Profiles uses it to distinguish this data from other customer order data. It is also used to determine if the data can be associated to an existing profile or used to create a new profile by searching other profiles for this identifier.

You can have multiple order identifiers.

- **Additional search attributes - optional:** You can choose attributes in your data source object that you want to index to be searchable. By default, all your identifiers are indexed.
- **Data object timestamp:** The data object timestamp is used to resolve profile conflicts when Identity Resolution is enabled for consolidating similar profiles. When two or more similar profiles have conflicting records, the records from the profile with the most recently updated timestamp will be used.

You can choose an attribute in your object to reference for when your object was last updated.

Step 4: Review and create

After the data mapping is created, you can choose **Add data source integration** to use this object type.

Amazon Connect > [Customer Profiles](#) > sample

sample Edit Delete

Add your data source
Add a data source integration to ingest your data objects according to this data mapping. Add data source integration

Summary

Data mapping name sample	Data source object Salesforce - Account	Integration status Inactive
Description sample	Creates profiles Yes	Last updated March 1, 2022, 3:11 (UTC)
	Data retention 366 days	Date created March 1, 2022, 3:11 (UTC)

About mapping destinations

A mapping destination is your mapping from a source to a standard definition that is already defined in Amazon Connect.

The following table lists the supported mapping destinations.

Source object	Destination: Customer, Product, Order, Case
S3	Any
Salesforce-Account	Customer
Salesforce-Contact	Customer
Salesforce-Asset	Product
Zendesk-users	Customer
Marketo-leads	Customer
Servicenow-sys_user	Customer

Source object	Destination: Customer, Product, Order, Case
Segment-Identify	Customer
Segment-Customer	Customer
Shopify-Customer	Customer
Shopify-DraftOrder	Order
Zendesk-tickets	Case
Servicenow-task	Case
Servicenow-incident	Case

Object type mapping requirements

The following information needs to be in your object type mapping so Customer Profiles can process the incoming data:

- A definition of all the fields in the ingested object that should be mapped to the standard profile, or used for assigning the data to a profile. This tells Customer Profiles which fields in the ingested **source** object should be mapped to given fields in the standard profile object.
- Which fields in the source object from your custom data should be indexed and how.

When the source data is ingested by Customer Profiles, the indexed fields determine:

- Which profile a specific object belongs to.
- Which objects are related to each other and should be placed in the same profile. For example, an account number or a contact ID in a contact record.
- What values can be used to find a profile. For example, the contact's name can be indexed. This would allow agents to find all profiles that belong to customers with a specific name.

Key requirements

You must define at least one key. Customer Profiles uses this key to map your custom profile object to a profile.

The custom profile object mapping also needs at least one key that uniquely identifies the object so that it can be updated by specifying the same value of this field (these requirements can be satisfied with a single key).

Each key can be made up of one or more fields.

Field requirements

A field definition specifies how to read a value for that field name from a source object. The field definition also specifies what kind of data is stored in the field.

Object type names can be any alpha numerical string or the '-' and '_' character, they also cannot start with a '_' character, which is used for reserved standard object types.

Object type mapping definition details

The object type mapping definition has two parts: the field definition and the key definition.

Tip

To learn how to create an object type mapper, see this blog post: [Unify and organize customer information with Amazon Connect Customer Profiles with the pre-built Amazon S3 connector](#). Or, check out this video on YouTube: [How to Integrate Customer Profile Data into your Contact Center Experiences](#).

Field definition details

The field definition defines the source, destination (target), and type of field. For example:

```
"Fields": {
  "{fieldName}": {
    "Source": "{source}",
    "Target": "{target}",
    "ContentType": "{contentType}"
  }, ...
}, ...
```

- **Source:** This can be a JSON accessor for the field or a Handlebar macro for generating the value of the field.

The source object being parsed is named `_source` so all fields in the source fields need to be prefaced by this string. Only the `_source` object is supported.

Use the Handlebar macro solution for generating constants and combining multiple source object fields into a single field. This is useful for indexing.

- **Target:** Specifies where in a standard object type the data of this field should be mapped.

Populating the standard profile allows you to use data ingested from any data source with applications built on top of Customer Profiles without any specific knowledge of the format of the data being ingested.

This field is optional. You might want to define fields solely for the purpose of including them in a key.

The format of this field is always a JSON accessor. The only supported target object is `_profile`.

- **ContentType:** The following values are supported `STRING`, `NUMBER`, `PHONE_NUMBER`, `EMAIL_ADDRESS`, `NAME`. If no `ContentType` is specified `STRING` is assumed.

`ContentType` is used to determine how to index the value so agents can search for it. For example, if `ContentType` is set to `PHONE_NUMBER`, a phone number is processed so agents can search for it in any format: the string `"+15551234567"` matches `"(555)-123-4567"`.

Key definition details

A key contains one or more fields that together define a key that can be used to search for objects (or the profiles they belong to) using the [SearchProfiles](#) API. The key can also be defined to uniquely identify a profile or uniquely identify the object itself.

```
"Keys": {
  "{keyName}": [{
    "StandardIdentifiers": [...],
    "FieldNames": [ "{fieldname}", ...]
  }], ...
}, ...
```

Key names are global to a domain. If you have two keys, with the same name in two different object type mappings:

- Those keys should occupy the same namespace
- They can be used to potentially link profiles together between different objects. If they match between the objects, Customer Profiles places the two objects in the same profile.

To phrase this in another way: keys should have the same key name in a domain if, and only if, the same value means that they are related. For example, a phone number specified in one type of object would be related to the same phone number specified in another type of object. An internal identifier specified for an imported object from Salesforce might not be related to another object imported from Marketo, even if they have exactly the same value.

Keys definitions are used in two ways:

- Inside of Customer Profiles during ingestion, they are used to figure out what profile the object should be assigned to.
- They allow you to use the [SearchProfiles](#) API to search for the key value and find the profile.

Default search keys

Default search keys, such as `_phone` and `_email`, are predefined by the [Standard Profile](#), [Standard Asset](#), [Standard Order](#), and [Standard Case](#) object template. You can use the default search keys as a key name with the [SearchProfiles API](#) to find a profile.

Standard identifiers

Standard identifiers allow you to set attributes on the key. Decide which identifiers to use based on how you want the data to be ingested in the profiles. For example, you mark phone number with the identifier `PROFILE`. This means phone number is to be treated as unique identifier. If Customer Profiles gets two contacts with the same phone number, the contacts are going to be merged into a single profile.

Identifier name	Description
UNIQUE	This identifier must be specified by exactly one index for each object type. This key is used to uniquely identify objects of the object type for either fetching them or if needed update a submitted object at a later date.

Identifier name	Description
	<p>All the fields that make up the UNIQUE keys are required to be specified when submitting a new object or it is rejected.</p>
PROFILE	<p>This identifier means that this key uniquely identifies a profile. When this identifier is specified, it means that during ingestion, Customer Profiles looks for any profile that has this key associated with it.</p> <ul style="list-style-type: none">• If a profile is found, then the object is assigned to that profile.• If more than one profile is found when searching for this key, the match is rejected. (Only keys that uniquely identify a profile should be used as unique keys except for special circumstances.)

Identifier name	Description
LOOKUP_ONLY	<p>This identifier indicates the key is not stored after ingesting the object. The key is only to be used for determining the profile during ingestion.</p> <p>The key value is not associated with the profile during ingestion, which means it can't be used to allow searching for it or matching later ingested objects to the same key.</p> <div data-bbox="829 667 1511 1402"><p>Note</p><ul style="list-style-type: none">• You cannot specify a key as both a UNIQUE identifier and a LOOKUP_ONLY identifier.• You can only use PROFILE together with LOOKUP_ONLY if there is at least one other key that has the PROFILE identifier without the NEW_ONLY or LOOKUP_ONLY identifiers. The only exception is the <code>_profileId</code> key, which can have the PROFILE and LOOKUP_ONLY identifier combination on its own.</div>

Identifier name	Description
NEW_ONLY	<p>If the profile does not already exist before the object is ingested, the key is associated with the profile. Otherwise the key is only used for matching objects to profiles.</p> <div data-bbox="829 447 1507 982"><p> Note</p><ul style="list-style-type: none">• You cannot specify a key as both a UNIQUE identifier and a NEW_ONLY identifier.• You can only use PROFILE together with NEW_ONLY if there is at least one other key that has the PROFILE identifier without the NEW_ONLY or LOOKUP_ONLY identifiers.</div>
SECONDARY	<p>During the matching of an object to a profile, Customer Profiles first looks up all PROFILE keys that do not have the SECONDARY identifier. These are considered first. SECONDARY keys are only considered if no matching profile is found using these keys.</p>

Identifier name	Description
ASSET	<p>This identifier means that this key uniquely identifies an asset. When this identifier is specified, it means that during ingestion, Customer Profiles looks for any asset that has this key associated with it.</p> <ul style="list-style-type: none">• If an asset is found, then the object is assigned to that asset.• If more than one asset is found when searching for this key, the match is rejected. (Only keys that uniquely identify an asset should be used as unique keys except for special circumstances.)
ORDER	<p>This identifier means that this key uniquely identifies an order. When this identifier is specified, it means that during ingestion, Customer Profiles looks for any order that has this key associated with it.</p> <ul style="list-style-type: none">• If an order is found, then the object is assigned to that order.• If more than one order is found when searching for this key, the match is rejected. (Only keys that uniquely identify an order should be used as unique keys except for special circumstances.)

Identifier name	Description
CASE	<p>This identifier means that this key uniquely identifies a case. When this identifier is specified, it means that during ingestion, Customer Profiles looks for any case that has this key associated with it.</p> <ul style="list-style-type: none"> • If a case is found, then the object is assigned to that case. • If more than one case is found when searching for this key, the match is rejected. (Only keys that uniquely identify a case should be used as unique keys except for special circumstances.)

Compatible identifiers

	Identifiers								Key Names						
	UNIQU E	PROFIL E	ASSE T	CAS E	ORDE R	LOOKUP_ONL Y	NEW_ONL Y	SECONDAR Y	<regularKey>	_profileId	_assetI d	_caseI d	_orderI d	_phone	_email
UNIQUE		✓	✓	✓	✓	✗	✗	✓	✓	✗	✗	✗	✗	✓	✓
PROFILE	✓		✓	✓	✓	✓	✓	✓	✓	✓	✓	✓	✓	✓	✓
ASSET	✓	✓		✓	✓	✓	✓	✓	✓	✓	✓	✓	✓	✓	✓
CASE	✓	✓	✓		✓	✓	✓	✓	✓	✓	✓	✓	✓	✓	✓
ORDER	✓	✓	✓	✓		✓	✓	✓	✓	✓	✓	✓	✓	✓	✓
LOOKUP_ONLY	✗	✓	✓	✓	✓		✓	✓	✓	✓	✓	✓	✓	✓	✓
NEW_ONLY	✗	✓	✓	✓	✓	✓		✓	✓	✓	✓	✓	✓	✓	✓
SECONDARY	✓	✓	✓	✓	✓	✓	✓		✓	✓	✓	✓	✓	✓	✓

✓: Allowed
✓: Allowed with limitations
✗: Not allowed

How profile assignment works using key definitions

When Customer Profiles ingests the custom object mappings, it processes the key definitions. The following diagram shows how it processes standard identifiers in key definitions to determine which profile to assign the object to.

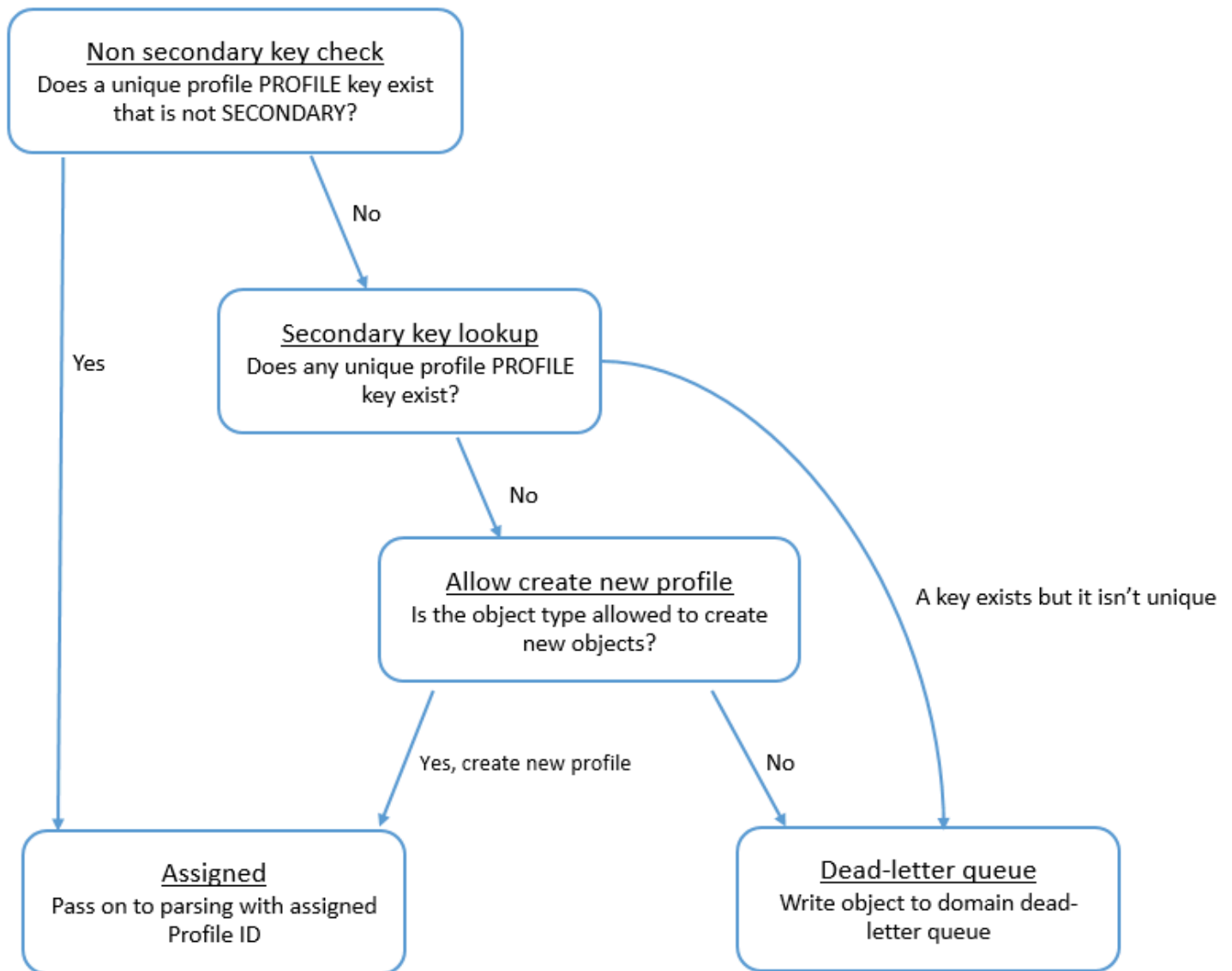

How keys are added to the index for future look ups

The following diagram shows how Customer Profiles processes the standard identifiers to determine whether to persist the key.

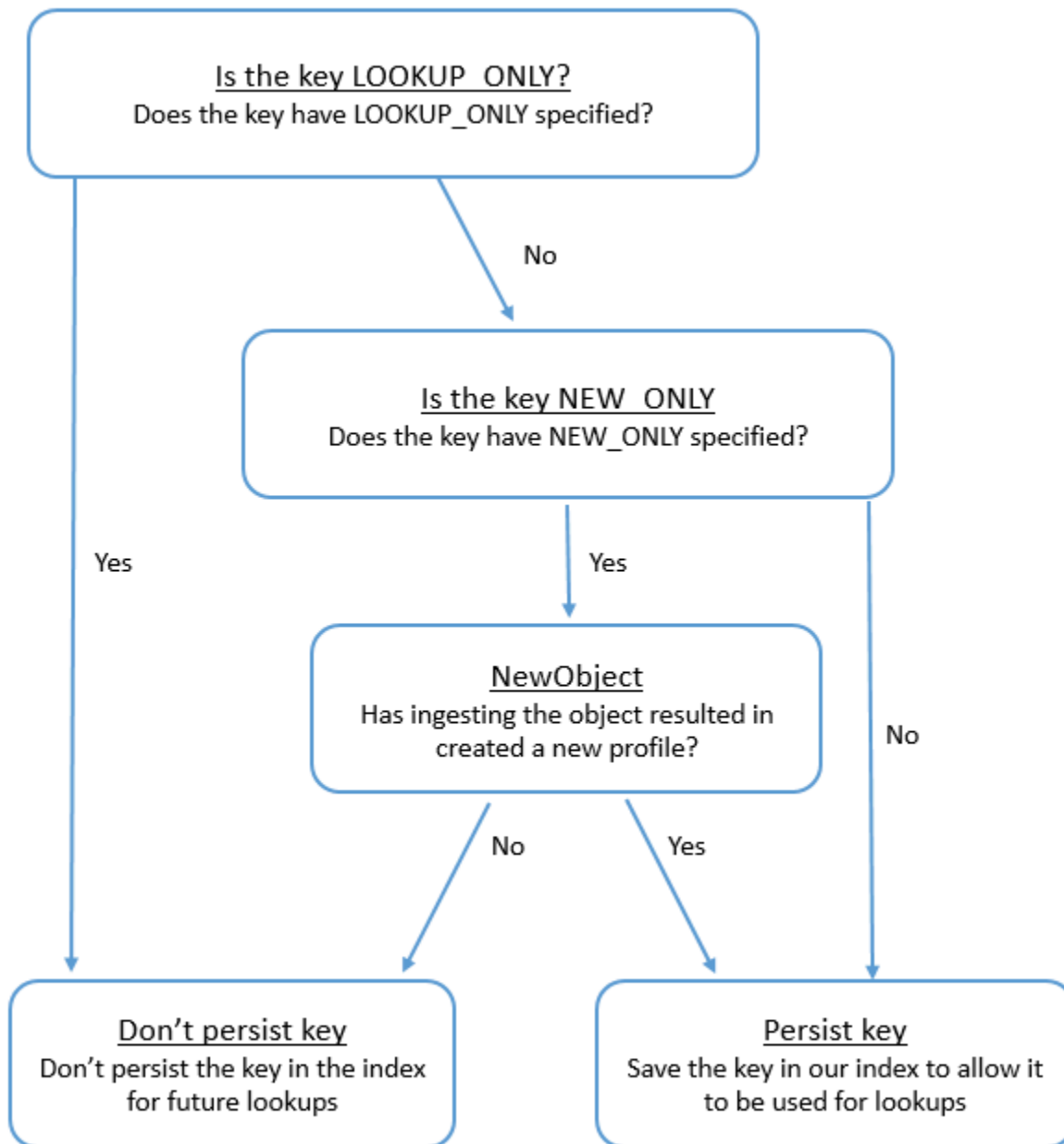

Object type mapping for the standard profile

The topics in this section provide the standard profile definition, and the object type mapping from external applications to the standard profile.

Contents

- [Amazon AppFlow access requirements](#)
- [Amazon AppIntegrations access requirements](#)

- [Amazon EventBridge access requirements](#)
- [Standard profile definition](#)
- [Mapping Salesforce objects to the standard profile](#)
- [Mapping Zendesk objects to the standard profile](#)
- [Mapping Marketo objects to the standard profile](#)
- [Mapping ServiceNow objects to the standard profile object](#)
- [Mapping Segment objects to the standard profile object](#)
- [Mapping Shopify objects to the standard profile object](#)

Amazon AppFlow access requirements

Following are the Amazon AppFlow access requirements to create and delete Zendesk, Marketo, Salesforce, and ServiceNow integrations:

- appflow:CreateFlow
- appflow>DeleteFlow

Amazon AppIntegrations access requirements

Following are the Amazon AppIntegrations access requirements to create and delete Segment and Shopify integrations:

- app-integrations:GetEventIntegration
- app-integrations>ListEventIntegrationAssociations
- app-integrations>CreateEventIntegrationAssociation
- app-integrations>DeleteEventIntegrationAssociation

Amazon EventBridge access requirements

Following are the Amazon EventBridge access requirements to create and delete Segment and Shopify integrations:

- events:ListTargetsByRule
- events:PutRule
- events:PutTargets

- events:DeleteRule
- events:RemoveTargets

Standard profile definition

The following table lists all the fields in the Customer Profiles standard profile object.

Standard profile field	Data type	Description
ProfileId	String	The unique identifier of a customer profile.
AccountNumber	String	A unique account number that you have given to the customer.
AdditionalInformation	String	Any additional information relevant to the customer's profile.
PartyType	String	The type of profile used to describe the customer. Valid values: INDIVIDUAL BUSINESS OTHER
BusinessName	String	The name of the customer's business.
FirstName	String	The customer's first name.
MiddleName	String	The customer's middle name.
LastName	String	The customer's last name.
BirthDate	String	The customer's birth date.
Gender	String	The gender with which the customer identifies.

Standard profile field	Data type	Description
PhoneNumber	String	The customer's phone number, which has not been specified as a mobile, home, or business number.
MobilePhoneNumber	String	The customer's mobile phone number.
HomePhoneNumber	String	The customer's home phone number.
BusinessPhoneNumber	String	The customer's business phone number.
EmailAddress	String	The customer's email address, which has not been specified as a personal or business address.
BusinessEmailAddress	String	The customer's business email address.
Address	Address	A generic address associated with the customer that is not mailing, shipping, or billing.
ShippingAddress	Address	The customer's shipping address.
MailingAddress	Address	The customer's mailing address.
BillingAddress	Address	The customer's billing address.
Attributes	String-to-string map	Key-value pair of attributes of a customer profile.

The standard profile objects are indexed by the keys in the following table.

Standard index name	Standard profile field
_phone	PhoneNumber, MobilePhoneNumber, HomePhoneNumber, or BusinessPhoneNumber
_email	EmailAddress, PersonalEmailAddress, or BusinessEmailAddress
_account	AccountNumber
_profileId	ProfileId
_fullName	"FirstName MiddleName LastName"

For example, you can use `_phone` as a key name with the [SearchProfiles API](#) to find a profile whose `PhoneNumber`, `MobilePhoneNumber`, `HomePhoneNumber`, or `BusinessPhoneNumber` attribute matches with the search value.

Address data type

Standard profile field	Data type	Description
Address1	String	The first line of a customer address.
Address2	String	The second line of a customer address.
Address3	String	The third line of a customer address.
Address4	String	The fourth line of a customer address.
City	String	The city in which the customer lives.

Standard profile field	Data type	Description
Country	String	The country in which the customer lives.
County	String	The county in which the customer lives.
PostalCode	String	The postal code of the customer address.
Province	String	The province in which the customer lives.
State	String	The state in which the customer lives.

Mapping Salesforce objects to the standard profile

This topic lists which fields in Salesforce objects map to fields in the standard profile object in Customer Profiles.

Salesforce-Account object

Following is a list of all the fields in a Salesforce-Account object. The fields in your Salesforce-Account object may vary depending on the configuration of your Salesforce instance.

- Id
- IsDeleted
- MasterRecordId
- Name
- Type
- ParentId
- BillingStreet
- BillingCity
- BillingState
- BillingPostalCode

- BillingCountry
- BillingLatitude
- BillingLongitude
- BillingGeocodeAccuracy
- BillingAddress.City
- BillingAddress.Country
- BillingAddress.geocodeAccuracy
- BillingAddress.latitude
- BillingAddress.longitude
- BillingAddress.postalCode
- BillingAddress.state
- BillingAddress.street
- ShippingStreet
- ShippingCity
- ShippingState
- ShippingPostalCode
- ShippingCountry
- ShippingLatitude
- ShippingLongitude
- ShippingGeocodeAccuracy
- ShippingAddress.city
- ShippingAddress.country
- ShippingAddress.latitude
- ShippingAddress.longitude
- ShippingAddress.postalCode
- ShippingAddress.state
- ShippingAddress.street
- Phone
- Fax
- AccountNumber

- Website
- PhotoUrl
- Sic
- Industry
- AnnualRevenue
- NumberOfEmployees
- Ownership
- TickerSymbol
- Description
- Rating
- Site
- OwnerId
- CreatedDate
- CreatedById
- LastModifiedDate
- LastModifiedId
- SystemModstamp
- LastActivityDate
- LastViewedDate
- LastReferencedDate
- Jigsaw
- JigsawCompanyId
- CleanStatus
- AccountSource
- DunsNumber
- Tradestyle
- NaicsCode
- NaicsDesc
- YearStarted
- SicDesc

- DandbCompanyId
- IsBuyer

Mapping a Salesforce-Account object to a standard profile

A subset of the fields in the Salesforce-Account object map to the standard profile object in Customer Profiles.

The following table lists which fields can be mapped from the Salesforce-Account object to the standard profile. (The table includes the mapping for a Salesforce instance that has been configured to include Person fields.)

Salesforce-Account source field	Standard profile target field
Id	Attributes.sfdcAccountId
Name	BusinessName
Phone	PhoneNumber
BillingStreet	BillingAddress.Address1
BillingCity	BillingAddress.City
BillingState	BillingAddress.State
BillingCountry	BillingAddress.Country
BillingPostalCode	BillingAddress.PostalCode
ShippingStreet	ShippingAddress.Address1
ShippingCity	ShippingAddress.City
ShippingState	ShippingAddress.State
ShippingCountry	ShippingAddress.Country
ShippingPostalCode	ShippingAddress.PostalCode
IsPersonAccount	PartyType

Salesforce-Account source field	Standard profile target field
PersonMobilePhone	MobilePhoneNumber
PersonHomePhone	HomePhoneNumber
PersonEmail	PersonalEmailAddress
PersonMailingAddress.Street	MailingAddress.Address1
PersonMailingAddress.City	MailingAddress.City
PersonMailingAddress.State	MailingAddress.State
PersonMailingAddress.Country	MailingAddress.Country
PersonMailingAddress.PostalCode	MailingAddress.PostalCode
PersonBirthDate	BirthDate
PersonOtherStreet	Address.Address1
PersonOtherCity	Address.City
PersonOtherState	Address.State
PersonOtherCountry	Address.Country
PersonOtherPostalCode	Address.PostalCode
FirstName	FirstName
LastName	LastName
MiddleName	MiddleName
AccountNumber	AccountNumber

The Salesforce-Account customer data from the Salesforce object is associated with an Amazon Connect customer profile using the indexes in the following table.

Standard Index Name	Salesforce-Account source field
<code>_salesforceAccountId</code>	<code>Id</code>

For example, you can use `_salesforceAccountId` as a key name with the [SearchProfiles](#) API to find a profile. You can find the Salesforce-Account objects associated with a specific profile by using the [ListProfileObjects](#) API with the `ProfileId` and `ObjectTypeName` set to `Salesforce-Account`.

Salesforce-Contact object

Following is a list of all the fields in a Salesforce-Contact object.

- `Id`
- `IsDeleted`
- `MasterRecordId`
- `AccountId`
- `LastName`
- `FirstName`
- `Salutation`
- `Name`
- `OtherStreet`
- `OtherCity`
- `OtherState`
- `OtherPostalCode`
- `OtherCountry`
- `OtherLatitude`
- `OtherLongitude`
- `OtherGeocodeAccuracy`
- `OtherAddress.city`
- `OtherAddress.country`
- `OtherAddress.geocodeAccuracy`
- `OtherAddress.latitude`

- OtherAddress.postalCode
- OtherAddress.state
- OtherAddress.street
- MailingStreet
- MailingCity
- MailingState
- MailingPostalCode
- MailingCountry
- MailingLatitude
- MailingLongitude
- MailingGeocodeAccuracy
- MailingAddress.city
- MailingAddress.country
- MailingAddress.geocodeAccuracy
- MailingAddress.latitude
- MailingAddress.longitude
- MailingAddress.postalCode
- MailingAddress.state
- MailingAddress.street
- Phone
- Fax
- MobilePhone
- HomePhone
- OtherPhone
- AssistantPhone
- ReportsTold
- Email
- Title
- Department
- AssistantName

- LeadSource
- Birthdate
- Description
- OwnerId
- CreatedDate
- CreatedById
- LastModifiedDate
- LastModifiedById
- SystemModstamp
- LastActivityDate
- LastCURequestDate
- LastCUUpdateDate
- LastViewedDate
- LastReferencedDate
- EmailBouncedReason
- EmailBouncedDate
- IsEmailBounced
- PhotoUrl
- Jigsaw
- JigsawContactId
- CleanStatus
- IndividualId

Mapping a Salesforce-Contact object to a standard profile

A subset of the fields in the Salesforce-Contact object map to the standard profile object in Customer Profiles. The following table lists which fields can be mapped from the Salesforce-Contact object to the standard profile object.

Salesforce-Contact source field	Standard profile target field
Id	Attributes.sfdcContactId

Salesforce-Contact source field	Standard profile target field
AccountId	Attributes.sfdcAccountId
LastName	LastName
FirstName	FirstName
MiddleName	MiddleName
OtherStreet	Address.Address1
OtherCity	Address.City
OtherState	Address.State
OtherCountry	Address.Country
OtherPostalCode	Address.PostalCode
MailingStreet	MailingAddress.Address1
MailingCity	MailingAddress.City
MailingState	MailingAddress.State
MailingCountry	MailingAddress.Country
MailingPostalCode	MailingAddress.PostalCode
Phone	PhoneNumber
HomePhone	HomePhoneNumber
MobilePhone	MobilePhoneNumber
Email	EmailAddress
Birthdate	BirthDate

The Salesforce-Contact customer data from a Salesforce object is associated with an Amazon Connect customer profile using the indexes in the following table.

Standard Index Name	Salesforce-Contact source field
_salesforceContactId	Id
_salesforceAccountId	AccountId

For example, you can use `_salesforceAccountId` and `_salesforceContactId` as a key name with the [SearchProfiles](#) API to find a profile. You can find the Salesforce-Contact objects associated with a specific profile by using the [ListProfileObjects](#) API with the `ProfileId` and `ObjectTypeName` set to `Salesforce-Contact`.

Mapping Zendesk objects to the standard profile

This topic lists which fields in Zendesk objects map to fields in the standard profile in Customer Profiles.

Zendesk-users object

Following is a list of all the fields in a Zendesk-users object.

- id
- url
- external_id
- email
- active
- chat_only
- customer_role_id
- role_type
- details
- last_login_at
- locale
- locale_id
- moderator

- notes
- only_private_comments
- default_group_id
- phone
- shared_phone_number
- photo
- restricted_agent
- role
- shared
- tags
- signature
- suspended
- ticket_restriction
- time_zone
- two_factor_auth_enabled
- user_fields
- verified
- report_csv
- created_at
- updated_at

Mapping Zendesk users to a standard profile

A subset of the fields in the Zendesk-users object map to the standard profile in Customer Profiles. The following table lists which fields can be mapped from the Zendesk-users object to the standard profile.

Zendesk-users source field	Standard profile target field
id	Attributes.ZendeskUserId
external_id	Attributes.ZendeskExternalId

Zendesk-users source field	Standard profile target field
email	EmailAddress
phone	PhoneNumber

The Zendesk-users customer data from the Zendesk object is associated with a Amazon Connect customer profile using the following indexes.

Standard Index Name	Zendesk-user source field
_zendeskUserId	Id
_zendeskExternalId	external_id

For example, you can use `_zendeskUserId` and `_zendeskExternalId` as a key name with the [SearchProfiles](#) API to find an Amazon Connect customer profile. You can find the Zendesk-users objects associated with a specific customer profile by using the [ListProfileObjects](#) API with the `ProfileId` and `ObjectTypeName` set to `Zendesk-users`.

Mapping Marketo objects to the standard profile

This topic lists which fields in Marketo objects map to fields in the standard profile object in Customer Profiles.

Marketo-leads object

Following is a list of all the fields in a Marketo-leads object

- id
- firstName
- lastName
- middleName
- email
- phone
- mobilePhone
- billingStreet

- billingCity
- billingState
- billingCountry
- billingPostalCode
- address
- city
- state
- country
- postalcode
- gender
- dateOfBirth

Mapping Marketo-leads to a standard profile

A subset of fields in the Marketo-leads object map to the standard profile.

Marketo-leads source field	Standard profile target field
id	Attributes.MarketLeadId
sfdcAccountId	Attributes.sfdcAccountId
sfdcContactId	Attributes.sfdcContactId
firstName	FirstName
lastName	LastName
middleName	MiddleName
email	EmailAddress
phone	PhoneNumber
mobilePhone	MobilePhoneNumber
mobilePhone	MobilePhoneNumber

Marketo-leads source field	Standard profile target field
billingStreet	BillingAddress.Address1
billingCity	BillingAddress.City
billingState	BillingAddress.State
billingCountry	BillingAddress.Country
billingPostalCode	BillingAddress.PostalCode
address	Address.Address1
city	Address.City
state	Address.State
country	Address.Country
postalcode	Address.PostalCode
gender	Gender
dataOfBirth	BirthDate

The Marketo-leads customer data from Marketo is associated with an Amazon Connect customer profile using the indexes in the following table.

Standard Index Name	Marketo-leads source field
_marketoLeadId	id
_salesforceAccountId	sfdcAccountId
_salesforceContactId	sfdcContactId

For example, you can use `_marketoLeadId`, `_salesforceAccountId`, and `_salesforceContactId` as a key name with the [SearchProfiles](#) API to find an Amazon Connect

customer profile. You can find the Marketo-leads objects associated with a specific customer profile by using the [ListProfileObjects](#) API with the `ProfileId` and `ObjectTypeName` set to `Marketo-leads`.

Mapping ServiceNow objects to the standard profile object

This topic lists which fields in ServiceNow objects map to fields in the standard profile object in Amazon Connect Customer Profiles.

ServiceNow-sys_user object

Following is a list of all the fields in a ServiceNow-sys_user object

- `sys_id`
- `active`
- `building`
- `calendar_integration`
- `city`
- `company`
- `cost_center`
- `country`
- `date_format`
- `default_perspective`
- `department`
- `edu_status`
- `email`
- `employee_number`
- `enable_multifactor_authn`
- `failed_attempts`
- `first_name`
- `gender`
- `home_phone`
- `internal_integration_user`
- `introduction`

- last_login
- last_login_device
- last_login_time
- last_name
- last_password
- ldap_server
- location
- locked_out
- manager
- middle_name
- mobile_phone
- name
- notification
- password_needs_reset
- phone
- photo
- preferred_language
- roles
- schedule
- source
- state
- street
- sys_class_name
- sys_created_by
- sys_created_on
- sys_domain.link
- sys_domain.value
- sys_domain_path
- sys_id
- sys_mod_count

- sys_updated_by
- sys_udpated_on
- time_format
- time_zone
- title
- user_name
- user_password
- web_service_access_only
- zip

Mapping Servicenow-sys_users to a standard profile object

A subset of the fields in the Servicenow-sys_users object map to the standard profile object in Customer Profiles.

The following table lists which fields can be mapped from the Servicenow-sys_users object to the standard profile.

Servicenow-sys_users source field	Customer profiles target field
sys_id	Attributes.ServiceNowSystemId
first_name	FirstName
last_name	LastName
middle_name	MiddleName
gender	Gender
email	EmailAddress
phone	PhoneNumber
home_phone	HomePhoneNumber
mobile_phone	MobilePhoneNumber

ServiceNow-sys_users source field	Customer profiles target field
street	Address.Address1
city	Address.City
state	Address.State
country	Address.Country
zip	Address.PostalCode

The ServiceNow-sys_user customer data from ServiceNow object is associated with an Amazon Connect customer profile using the indexes in the following table.

Standard Index Name	ServiceNow-sys_user source field
_serviceNowSystemId	sys_id

For example, you can use `_serviceNowSystemId` and `_serviceNowIncidentId` as a key name with the [SearchProfiles](#) API to find an Amazon Connect customer profile. You can find the ServiceNow-sys_user objects associated with a specific profile by using the [ListProfileObjects](#) API with the `ProfileId` and `ObjectTypeName` set to `ServiceNow-sys_user`.

Mapping Segment objects to the standard profile object

This topic lists which fields in Segment objects map to fields in the standard profile object in Amazon Connect Customer Profiles.

Segment-Identify object

Following is a list of all the fields in a Segment-Identify object.

- `userId`
- common fields - see [Spec: Common Fields](#) in the Segment documentation
- Segment reserved traits - see [Traits](#) in the Segment documentation
- `traits.address.street`

- traits.address.city
- traits.address.state
- traits.address.postalCode
- traits.address.country
- traits.age
- traits.avatar
- traits.birthday
- traits.company.name
- traits.company.id
- traits.company.industry
- traits.company.employee_count
- traits.company.plan
- traits.createdAt
- traits.description
- traits.email
- traits.firstName
- traits.gender
- traits.id
- traits.lastName
- traits.name
- traits.phone
- traits.title
- traits.username
- traits.website

Mapping a Segment-Identify to a standard profile object

A subset of the fields in the Segment-Identify object map to the standard profile object in Customer Profiles.

The following table lists which fields can be mapped from the Segment-Identify object to the standard profile.

Segment-Identify source field	Standard profile target field
userId	Attributes.SegmentUserId
traits.company.name	BusinessName
traits.firstName	FirstName
traits.lastName	LastName
traits.birthday	BirthDate
traits.gender	Gender
traits.phone	PhoneNumber
traits.email	EmailAddress
traits.address.street	Address.Address1
traits.address.city	Address.City
traits.address.state	Address.State
traits.address.country	Address.Country
traits.address.postalCode	Address.PostalCode

Example

The following example shows how to map a source field to a target field.

```
"segmentUserId": {
  "Source": "_source.detail.event.detail.userId",
  "Target": "_profile.Attributes.SegmentUserId"
}
```

The Segment-Identify customer data from the Segment object is associated with an Amazon Connect customer profile using the following index.

Standard Index Name	Segment-Identify source field
_segmentUserId	userId

For example, you can use `_segmentUserId` as a key name with the [SearchProfiles](#) API to find an Amazon Connect customer profile. You can find the Segment-Identify objects associated with a specific profile by using the [ListProfileObjects](#) API with the `ProfileId` and `ObjectTypeName` set to `Segment-Identify`.

Mapping Shopify objects to the standard profile object

This topic lists which fields in Shopify objects map to fields in the standard profile object in Amazon Connect Customer Profiles.

Shopify-Customer object

Following is a list of all the fields in a Shopify-Customer object.

- `accepts_marketing`
- `accepts_marketing_updated_at`
- `addresses`
- `currency`
- `created_at`
- `default_address.address1`
- `default_address.address2`
- `default_address.city`
- `default_address.company`
- `default_address.country`
- `default_address.country_code`
- `default_address.country_name`
- `default_address.customer_id`
- `default_address.default`
- `default_address.first_name`
- `default_address.id`

- `default_address.last_name`
- `default_address.name`
- `default_address.phone`
- `default_address.province`
- `default_address.province_code`
- `default_address.zip`
- `email`
- `first_name`
- `id`
- `last_name`
- `last_order_id`
- `last_order_name`
- `metafield.key`
- `metafield.value`
- `metafield.namespace`
- `metafield.value_type`
- `marketing_opt_in_level`
- `multipass_identifier`
- `note`
- `orders_count`
- `phone`
- `sms_marketing_consent.state`
- `sms_marketing_consent.opt_in_level`
- `sms_marketing_consent.consent_updated_at`
- `sms_marketing_consent.consent_collected_from`
- `state`
- `tags`
- `tax_exempt`
- `tax_exemptions`
- `total_spent`

- updated_at
- verified_email

Mapping a Shopify-Customer object to a standard profile

A subset of the fields in the Shopify-Customer object map to the standard profile object in Customer Profiles.

The following table lists which fields can be mapped from the Shopify-Customer object to the standard profile.

Shopify-Customer source field	Standard profile target field
id	Attributes.ShopifyCustomerId
email	EmailAddress
first_name	FirstName
last_name	LastName
note	AdditionalInformation
phone	PhoneNumber
default_address.address1	Address.Address1
default_address.address2	Address.Address2
default_address.city	Address.City
default_address.province	Address.Province
default_address.country	Address.Country
default_address.zip	Address.PostalCode

Example

The following example shows how to map a source field to a target field.

```
"shopifyCustomerId": {
  "Source": "_source.detail.event.detail.payload.id",
  "Target": "_profile.Attributes.ShopifyCustomerId"
}
```

The Shopify-Customer customer data from the Shopify object is associated with an Amazon Connect customer profile using the following index.

Standard Index Name	Shopify-Customer source field
_shopifyCustomerId	id

For example, you can use `_shopifyCustomerId` as a key name with the [SearchProfiles](#) API to find an Amazon Connect customer profile. You can find the Shopify-Customer objects associated with a specific profile by using the [ListProfileObjects](#) API with the `ProfileId` and `ObjectTypeName` set to `Shopify-Customer`.

Object type mapping for the standard order

The topics in this section provide the standard order definition, and the object type mapping from external applications to the standard order.

Contents

- [Amazon AppIntegrations access requirements](#)
- [Amazon EventBridge access requirements](#)
- [Standard order definition](#)
- [Mapping Shopify objects to the standard order](#)

Amazon AppIntegrations access requirements

Following are the Amazon AppIntegrations access requirements to create and delete Shopify integrations:

- `app-integrations:GetEventIntegration`
- `app-integrations:ListEventIntegrationAssociations`
- `app-integrations>CreateEventIntegrationAssociation`

- `app-integrations:DeleteEventIntegrationAssociation`

Amazon EventBridge access requirements

Following are the Amazon EventBridge access requirements to create and delete Shopify integrations:

- `events:ListTargetsByRule`
- `events:PutRule`
- `events:PutTargets`
- `events>DeleteRule`
- `events:RemoveTargets`

Standard order definition

The following table lists all the fields in the Customer Profiles standard order object.

Standard order field	Data type	Description
<code>OrderId</code>	String	The unique identifier of a standard order.
<code>CustomerEmail</code>	String	The customer's email address.
<code>CustomerPhone</code>	String	The customer's phone number.
<code>CreatedDate</code>	String	The order's date created.
<code>UpdatedDate</code>	String	The order's date updated.
<code>ProcessedDate</code>	String	The order's date processed.
<code>ClosedDate</code>	String	The order's date closed.
<code>CancelledDate</code>	String	The order's date cancelled.
<code>CancelReason</code>	String	The order's cancel reason.

Name	String	The order's name.
AdditionalInformation	String	Any additional information relevant to the order.
Gateway	String	The order's payment gateway.
Status	String	The order's status.
StatusCode	String	The order's status code. Valid values: DRAFT ACTIVATED
StatusUrl	String	The order's status URL.
CreditCardNumber	String	The customer's credit card last four digits.
CreditCardCompany	String	The customer's credit card company.
FulfillmentStatus	String	The order's fulfillment status.
TotalPrice	String	The order's total price.
TotalTax	String	The order's total tax.
TotalDiscounts	String	The order's total discounts.
TotalItemsPrice	String	The order's total items price.
TotalShippingPrice	String	The order's total shipping price.
TotalTipReceived	String	The order's total tip received.
Currency	String	The order's currency.
TotalWeight	String	The order's total weight.
BillingAddress	OrderAddress	The customer's billing address.

ShippingAddress	OrderAddress	The customer's shipping address.
OrderItems	OrderItem list	The order's items.
Attributes	String-to-string map	Key-value pair of attributes of a standard order.

The standard order objects are indexed by the keys in the following table.

Standard index name	Standard order field
_orderId	OrderId

For example, you can use `_orderId` as a key name with the [SearchProfiles API](#) to find a profile that has an order whose `OrderId` matches with the search value. You can find the standard order objects associated with a specific profile by using the [ListProfileObjects API](#) with the `ProfileId` and `ObjectTypeName` set to `_order`.

OrderAddress data type

Standard order field	Data type	Description
Name	String	The name associated with an order address.
Address1	String	The first line of an order address.
Address2	String	The second line of an order address.
Address3	String	The third line of an order address.
Address4	String	The fourth line of an order address.

City	String	The city of an order address.
County	String	The county of an order address.
State	String	The state of an order address.
Province	String	The province of an order address.
Country	String	The country of an order address.
PostalCode	String	The postal code of an order address.

OrderItem data type

Standard order field	Data type	Description
Title	String	The title of an order item.
Price	String	The price of an order item.
Quantity	String	The quantity of an order item.

Mapping Shopify objects to the standard order

This topic lists which fields in Shopify objects map to fields in the standard order object in Customer Profiles.

Shopify-DraftOrder object

For a list of all the fields in a Shopify-DraftOrder object see [The DraftOrder object](#) in the Shopify documentation.

Mapping a Shopify-DraftOrder object to a standard order

A subset of the fields in the Shopify-DraftOrder object map to the standard order object in Customer Profiles.

The following table lists which fields can be mapped from the Shopify-DraftOrder object to the standard order.

The StatusCode is ACTIVATED if order_status_url exists in the source. Otherwise, the StatusCode is DRAFT.

Shopify-DraftOrder source field	Standard order target field
id	Attributes.ShopifyOrderId
customer.id	Attributes.ShopifyCustomerId
note	AdditionalInformation
email	CustomerEmail
currency	Currency
created_at	CreatedDate
updated_at	UpdatedDate
name	Name
status	Status
order_status_url	StatusCode
billing_address.address1	BillingAddress.Address1
billing_address.address2	BillingAddress.Address2
billing_address.city	BillingAddress.City
billing_address.zip	BillingAddress.PostalCode
billing_address.province	BillingAddress.Province
billing_address.country	BillingAddress.Country
billing_address.name	BillingAddress.Name

shipping_address.address1	ShippingAddress.Address1
shipping_address.address2	ShippingAddress.Address2
shipping_address.city	ShippingAddress.City
shipping_address.zip	ShippingAddress.PostalCode
shipping_address.province	ShippingAddress.Province
shipping_address.country	ShippingAddress.Country
shipping_address.name	ShippingAddress.Name
invoice_url	StatusUrl
total_price	TotalPrice
total_tax	TotalTax
line_items[].title	OrderItems[].Title
line_items[].price	OrderItems[].Price
line_items[].quantity	OrderItems[].Quantity

Example

The following example shows how to map a source field to a target field.

```
"shopifyOrderId": {
  "Source": "_source.detail.event.detail.payload.id",
  "Target": "_order.Attributes.ShopifyOrderId"
}
```

The Shopify-DraftOrder customer data from the Shopify object is associated with an Amazon Connect standard order using the following index.

Standard Index Name	Shopify-DraftOrder source field
_shopifyOrderId	id

For example, you can use `_shopifyOrderId` as an `ObjectFilter.KeyName` with the the [ListProfileObjects](#) API to find a standard order. You can find the Shopify-DraftOrder objects associated with a specific profile by using the [ListProfileObjects](#) API with the `ProfileId` and `ObjectTypeName` set to `Shopify-DraftOrder`.

Shopify-Order object

For a list of all the fields in a Shopify-Order object see [The Order object](#) in the Shopify documentation.

Mapping a Shopify-Order object to a standard order

A subset of the fields in the Shopify-Order object map to the standard order object in Customer Profiles.

The following table lists which fields can be mapped from the Shopify-Order object to the standard order.

The `StatusCode` is `ACTIVATED` if `order_status_url` exists in the source. Otherwise, the `StatusCode` is `DRAFT`.

Shopify-Order source field	Standard order target field
<code>id</code>	<code>Attributes.ShopifyOrderId</code>
<code>customer.id</code>	<code>Attributes.ShopifyCustomerId</code>
<code>cancelled_at</code>	<code>CancelledDate</code>
<code>cancel_reason</code>	<code>CancelReason</code>
<code>closed_at</code>	<code>ClosedDate</code>
<code>created_at</code>	<code>CreatedDate</code>
<code>currency</code>	<code>Currency</code>
<code>email</code>	<code>CustomerEmail</code>
<code>financial_status</code>	<code>Status</code>
<code>order_status_url</code>	<code>StatusCode</code>

fulfillment_status	FulfillmentStatus
gateway	Gateway
name	Name
note	AdditionalInformation
order_status_url	StatusUrl
phone	CustomerPhone
processed_at	ProcessedDate
total_discounts	TotalDiscounts
total_line_items_price	TotalItemsPrice
total_price	TotalPrice
total_shipping_price_set.shop_money.amount	TotalShippingPrice
total_tax	TotalTax
total_tip_received	TotalTipReceived
total_weight	TotalWeight
updated_at	UpdatedDate
billing_address.address1	BillingAddress.Address1
billing_address.address2	BillingAddress.Address2
billing_address.city	BillingAddress.City
billing_address.zip	BillingAddress.PostalCode
billing_address.province	BillingAddress.Province
billing_address.country	BillingAddress.Country
billing_address.name	BillingAddress.Name

payment_details.credit_card_number	CreditCardNumber
payment_details.credit_card_company	CreditCardCompany
shipping_address.address1	ShippingAddress.Address1
shipping_address.address2	ShippingAddress.Address2
shipping_address.city	ShippingAddress.City
shipping_address.zip	ShippingAddress.PostalCode
shipping_address.province	ShippingAddress.Province
shipping_address.country	ShippingAddress.Country
shipping_address.name	ShippingAddress.Name
line_items[].title	OrderItems[].Title
line_items[].price	OrderItems[].Price
line_items[].quantity	OrderItems[].Quantity

Example

The following example shows how to map a source field to a target field.

```
"shopifyOrderId": {
  "Source": "_source.detail.event.detail.payload.id",
  "Target": "_order.Attributes.ShopifyOrderId"
}
```

The Shopify-Order customer data from the Shopify object is associated with an Amazon Connect standard order using the following index.

Standard Index Name	Shopify-Order source field
_shopifyOrderId	id

For example, you can use `_shopifyOrderId` as an `ObjectFilter.KeyName` with the [ListProfileObjects](#) API to find a standard order. You can find the Shopify-Order objects associated with a specific profile by using the [ListProfileObjects](#) API with the `ProfileId` and `ObjectTypeName` set to `Shopify-Order`.

Object type mapping for the standard asset

The topics in this section provide the standard asset definition, and the object type mapping from external applications to the standard asset.

Contents

- [Amazon AppFlow access requirements](#)
- [Standard asset definition](#)
- [Mapping Salesforce objects to the standard asset](#)

Amazon AppFlow access requirements

Following are the Amazon AppFlow access requirements to create and delete Salesforce integrations:

- `appflow:CreateFlow`
- `appflow>DeleteFlow`

Standard asset definition

The following table lists all the fields in the Customer Profiles standard asset object.

Standard asset field	Data type	Description
AssetId	String	The unique identifier of a standard asset.
AssetName	String	The asset's name.
SerialNumber	String	The asset's serial number.
ModelNumber	String	The asset's model number.

Standard asset field	Data type	Description
ModelName	String	The asset's model name.
ProductSKU	String	The asset's stock keeping unit.
PurchaseDate	String	The asset's purchase date.
UsageEndDate	String	The asset's usage end date.
Status	String	The asset's status.
Price	String	The asset's price.
Quantity	String	The asset's quantity.
Description	String	The asset's description.
AdditionalInformation	String	Any additional information relevant to the asset.
DataSource	String	The asset's data source.
Attributes	String-to-string map	Key-value pair of attributes of a standard asset.

The standard asset objects are indexed by the keys in the following table.

Standard index name	Standard asset field
_assetId	AssetId
_assetName	AssetName
_serialNumber	SerialNumber

For example, you can use `_assetName` as a key name with the [SearchProfiles API](#) to find a profile that has an asset whose `AssetName` matches with the search value. You can find the standard asset

objects associated with a specific profile by using the [ListProfileObjects API](#) with the ProfileId and ObjectTypeName set to _asset.

Mapping Salesforce objects to the standard asset

This topic lists which fields in Salesforce objects map to fields in the standard asset object in Customer Profiles.

Salesforce-Asset object

Following is a list of all the fields in a Salesforce-Asset object.

- Id
- ContactId
- AccountId
- ParentId
- RootAssetId
- Product2Id
- ProductCode
- IsCompetitorProduct
- CreatedDate
- CreatedById
- LastModifiedDate
- LastModifiedById
- SystemModstamp
- IsDeleted
- Name
- SerialNumber
- InstallDate
- PurchaseDate
- UsageEndDate
- LifecycleStartDate
- LifecycleEndDate

- Status
- Price
- Quantity
- Description
- OwnerId
- AssetProvidedById
- AssetServiceById
- IsInternal
- AssetLevel
- StockKeepingUnit
- HasLifecycleManagement
- CurrentMrr
- CurrentLifecycleEndDate
- CurrentQuantity
- CurrentAmount
- LastViewedDate
- LastReferencedDate

Mapping a Salesforce-Asset object to a standard asset

A subset of the fields in the Salesforce-Asset object map to the standard asset object in Customer Profiles.

The following table lists which fields can be mapped from the Salesforce-Asset object to the standard asset.

Salesforce-Asset source field	Standard asset target field
Id	Attributes.sfdcAssetId
ContactId	Attributes.sfdcContactId
AccountId	Attributes.sfdcAccountId

Salesforce-Asset source field	Standard asset target field
SerialNumber	SerialNumber
StockKeepingUnit	ProductSKU
UsageEndDate	UsageEndDate
Status	Status
Price	Price
Quantity	Quantity
Description	Description

The Salesforce-Asset customer data from the Salesforce object is associated with an Amazon Connect standard asset using the indexes in the following table.

Standard Index Name	Salesforce-Asset source field
_salesforceAssetId	Id
_salesforceContactId	ContactId
_salesforceAccountId	AccountId

For example, you can use `_salesforceAssetId` and `_salesforceAccountId` as an `ObjectFilter.KeyName` with the [ListProfileObjects](#) API to find a standard asset. You can find the Salesforce-Asset objects associated with a specific profile by using the [ListProfileObjects](#) API with the `ProfileId` and `ObjectTypeName` set to `Salesforce-Asset`.

Object type mapping for the standard case

The topics in this section provide the standard case definition, and the object type mapping from external applications to the standard case.

Contents

- [Amazon AppFlow access requirements](#)

- [Standard case definition](#)
- [Mapping Zendesk objects to the standard case](#)
- [Mapping ServiceNow objects to the standard case](#)

Amazon AppFlow access requirements

Following are the Amazon AppFlow access requirements to create and delete Zendesk and ServiceNow integrations:

- appflow:CreateFlow
- appflow>DeleteFlow

Standard case definition

The following table lists all the fields in the Customer Profiles standard case object.

Standard case field	Data type	Description
CaseId	String	The unique identifier of a standard case.
Title	String	The case's title
Summary	String	The case's summary.
Status	String	The case's status.
Reason	String	The case's reason.
CreatedBy	String	The case's creator.
CreatedDate	String	The case's date created.
UpdatedDate	String	The case's date updated.
ClosedDate	String	The case's date closed.
AdditionalInformation	String	Any additional information relevant to the case.

Standard case field	Data type	Description
DataSource	String	The case's data source.
Attributes	String-to-string map	Key-value pair of attributes of a standard case.

The standard case objects are indexed by the keys in the following table.

Standard index name	Standard case field
_caseId	Caseld

For example, you can use `_caseId` as a key name with the [SearchProfiles API](#) to find a profile that has a case whose `Caseld` matches with the search value. You can find the standard case objects associated with a specific profile by using the [ListProfileObjects API](#) with the `ProfileId` and `ObjectTypeName` set to `_case`.

Mapping Zendesk objects to the standard case

This topic lists which fields in Zendesk objects map to fields in the standard case in Customer Profiles.

Zendesk-tickets object

Following is a list of all the fields in a Zendesk-tickets object.

- `id`
- `url`
- `type`
- `subject`
- `raw_subject`
- `description`
- `priority`
- `status`
- `recipient`

- requester_id
- submitter_id
- assignee_id
- organization_id
- group_id
- collaborator_ids
- email_cc_ids
- follower_ids
- forum_topic_id
- problem_id
- has_incidents
- due_at
- tags
- via.channel
- custom_fields
- satisfaction_rating
- sharing_agreement_ids
- followup_ids
- ticket_form_id
- brand_id
- allow_channelback
- allow_attachments
- is_public
- created_at
- updated_at

Mapping Zendesk-tickets object to a standard case

A subset of the fields in the Zendesk-tickets object map to the standard case in Customer Profiles. The following table lists which fields can be mapped from the Zendesk-tickets object to the standard case.

Zendesk-tickets source field	Standard case target field
requester_id	Attributes.ZendeskUserId
id	Attributes.ZendeskTicketId
subject	Title
description	Summary
status	Status
requester_id	CreatedBy
created_at	CreatedDate
updated_at	UpdatedDate

The Zendesk-tickets customer data from the Zendesk object is associated with a Amazon Connect standard case using the following indexes.

Standard Index Name	Zendesk-tickets source field
_zendeskUserId	requester_id
_zendeskTicketId	id

For example, you can use `_zendeskUserId` and `_zendeskTicketId` as an `ObjectFilter.KeyName` with the [ListProfileObjects](#) API to find a standard case. You can find the Zendesk-tickets objects associated with a specific profile by using the [ListProfileObjects](#) API with the `ProfileId` and `ObjectName` set to `Zendesk-tickets`.

Mapping ServiceNow objects to the standard case

This topic lists which fields in ServiceNow objects map to fields in the standard case in Amazon Connect Customer Profiles.

ServiceNow-task object

Following is list of all the fields in a ServiceNow-task object.

- sys_id
- active
- activity_due
- additional_assignee_list
- approval
- approval_history
- approval_set
- assigned_to
- assignment_group
- business_duration
- business_service
- calendar_duration
- closed_at
- closed_by
- cmdb_ci.display_value
- cmdb_ci.link
- comments
- comments_and_work_notes
- company
- contact_type
- contract
- correlation_display
- active
- correlation_id
- delivery_plan
- delivery_task

- description
- due_date
- escalation
- expected_start
- follow_up
- group_list
- impact
- knowledge
- location
- made_sla
- number
- opened_at
- opened_by.display_value
- order
- parent
- priority
- reassignment_count
- service_offering
- short_description
- sla_due
- state
- sys_class_name
- sys_created_by
- sys_created_on
- active
- sys_domain.global
- sys_domain.link
- sys_domain_path

- sys_mod_count
- sys_updated_by
- sys_updated_on
- time_worked
- upon_approval
- upon_reject
- urgency
- user_input
- watch_list
- work_end
- work_notes
- work_notes_list
- work_start

Mapping Servicenow-task to a standard case

A subset of the fields in the Servicenow-task object map to the standard case in Customer Profiles.

The following table lists which fields can be mapped from the Servicenow-task object to the standard case.

Servicenow-task source field	Standard case target field
sys_id	Attributes.ServiceNowTaskId
opened_by.link	Attributes.ServiceNowSystemUserId
short_description	Title
description	Summary
status	Status
sys_created_by	CreatedBy

ServiceNow-task source field	Standard case target field
sys_created_on	CreatedDate
sys_updated_on	UpdatedDate

The ServiceNow-task customer data from ServiceNow is associated with an Amazon Connect standard case using the indexes in the following table.

Standard Index Name	ServiceNow-task source field
_serviceNowTaskId	sys_id
_serviceNowSystemId	open_by.link

For example, you can use `_serviceNowTaskId` and `_serviceNowSystemId` as an `ObjectFilter.KeyName` with the [ListProfileObjects](#) API to find a standard case. You can find the ServiceNow-task objects associated with a specific profile by using the [ListProfileObjects](#) API with the `ProfileId` and `ObjectTypeName` set to `ServiceNow-task`.

ServiceNow-incident object

Following is a list of all the fields in a ServiceNow-incident object.

- `sys_id`
- `business_stc`
- `calendar_stc`
- `caller_id.link`
- `caller_id.value`
- `category`
- `caused_by`
- `child_incidents`
- `close_code`
- `hold_reason`

- incident_state
- notify
- parent_incident
- problem_id
- reopened_by
- reopened_time
- reopen_count
- resolved_at
- resolved_by.link
- resolved_by.value
- rfc
- severity
- subcategory

Mapping Servicenow-incident to a standard case

A subset of the fields in the Servicenow-incident object map to the standard case in Customer Profiles.

The following table lists which fields can be mapped from the Servicenow-incident object to the standard case.

Servicenow-Incident source field	Standard case target field
sys_id	Attributes_ServiceNowIncidentId
caller_id.link	Attributes_ServiceNowSystemUserId
incident_status	Status
caller_id.link	CreatedBy
resolved_at	ClosedDate
category	Reason

The Servicenow-incident customer data from the Servicenow object is associated with an Amazon Connect standard case using the indexes in the following table.

Standard Index Name	Servicenow source field
_serviceNowIncidentId	sys_id
_serviceNowSystemId	caller_id.link

For example, you can use `_serviceNowIncidentId` and `_serviceNowSystemId` as a `ObjectFilter.KeyName` with the [ListProfileObjects](#) API to find a standard case. You can find the Servicenow-incident objects associated with a specific profile by using the [ListProfileObjects](#) API with the `ProfileId` and `ObjectTypeName` set to `Servicenow-incident`.

Additional properties of object types

A property type defines which key should be used to encrypt any data of the object type.

There is an option that defines if new profiles can be created by the ingestion of this object. Normally when an object is ingested that cannot be matched to an existing profile, a new profile is created as long as this option is true. If it is not true then the ingested object is created and written to the domain dead-letter queue.

It also contains how long data of this object type should be retained in Customer Profiles.

Note

Retention on individual objects is set at the time of ingestion of data. Changing the retention for a specific object type only applies to new data being ingested. It does not apply to existing data already ingested.

Note

If this object matches with an existing profile, it will not overwrite fields manually populated through an API call or the Agent Workspace, to prevent automated ingestions from overwriting manual ones.

For example, suppose a profile is created with `FirstName` "John" manually by an agent in the Agent Workspace. An object mapping data to the Standard Profile's `FirstName` field is ingested. If this object associates with the profile, it will not overwrite the `FirstName` "John".

Inferred profiles

When a profile is created by the ingestion of an object that has no fields, the standard profile object of this new profile is empty. This empty standard profile object is an **inferred profile**.

When creating an inferred profile, the following two fields are populated in the standard object from the profile object, if available.

- If there is any field defined with the content type of `EMAIL_ADDRESS` in the ingested object then this value will be populated into the `EmailAddress` field of the standard profile.
- If there is any field with the content type of `PHONE_NUMBER` in the ingested object then this value will be populated into the `PhoneNumber` field of the standard profile.

Values for these fields are populated into the standard profile even if the fields do not have a target defined in the field definition.

Contact record templates

What is a Contact Record? A Contact Record serves as a profile object that captures essential meta-data from various contact events, such as phone calls or chats. It plays a vital role in documenting and analyzing interactions with customers. When a contact event takes place, we offer three distinct default templates that can be applied to your domain. These templates serve as configuration options, governing how the contact event is handled within the system. Each template defines specific rules and actions, allowing you to tailor the processing of contact events according to your business needs.

Create inferred profiles and auto-associate profiles (CTR-NoInferred)

Description

When the CTR-NoInferred template is utilized and a contact event, such as a phone call takes place, a specific process is initiated to handle the data. Initially, the system uses the `_ctrContactId` key to search for an existing profile associated with the contact event. If a matching profile is

found, the contact event is automatically associated with that profile. However, if no existing profile is found using the `_ctrContactId` key, the system proceeds to search for a profile using a secondary key called `_phone`. This key is used to locate an existing profile based on the phone number associated with the contact event. When a matching profile is found, the contact event is automatically associated with that profile.

In cases where neither the `_ctrContactId` key nor the `_phone` key yield an existing profile, the system creates a new inferred profile. This inferred profile is then populated with the meta-data from the contact event, ensuring that the information is captured and stored within the system.

This process ensures efficient handling of contact events, promoting auto-association with existing profiles and enabling the creation of inferred profiles when necessary. By leveraging these mechanisms, organizations can maintain a comprehensive record of customer interactions and effectively manage their contact event data within the system.

It is recommended to use the CTR-NoInferred template as the default behavior due to its significant advantages, especially in reducing duplicate profiles

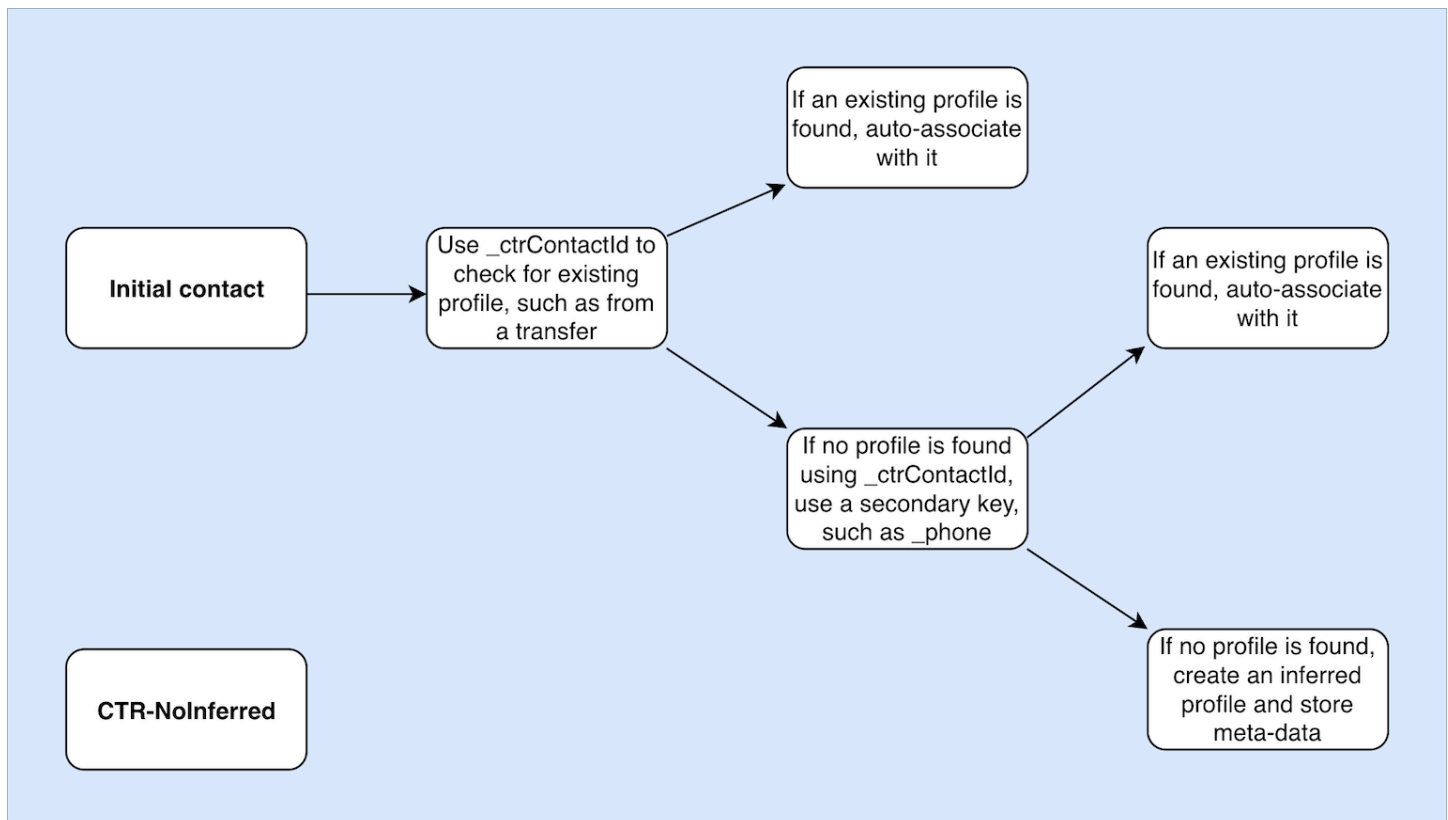

Auto-associate profiles only (CTR-AutoAssociateOnly)

Description

The CTR-AutoAssociateOnly template functions similarly to the CTR-NoInferred template with one important distinction: it does not create an inferred profile when no existing profile can be found for auto-association.

When a contact event, such as a phone call, takes place, the CTR-AutoAssociateOnly template utilizes the `_ctrContactId` key to search for a matching existing profile. If a profile is found, the contact event is automatically associated with that profile.

However, if no existing profile is found using the `_ctrContactId` key, the template employs a secondary search mechanism using the `_phone` key. It searches for an existing profile associated with the same phone number as the contact event. If a matching profile is found, the contact event is auto-associated with that profile.

The purpose of using the CTR-AutoAssociateOnly template is to enable automatic association with existing profiles while maintaining strict control over profile creation. Unlike the CTR-NoInferred template, this template prevents the creation of inferred profiles when no match is found. It ensures that profiles are only created manually, providing organizations with a higher level of control and accuracy in profile management.

By utilizing the CTR-AutoAssociateOnly template, organizations can leverage auto-association while adhering to specific rules regarding profile creation. This approach allows for streamlined contact event handling and precise control over the profile ecosystem, ensuring accurate data representation and facilitating efficient customer management.

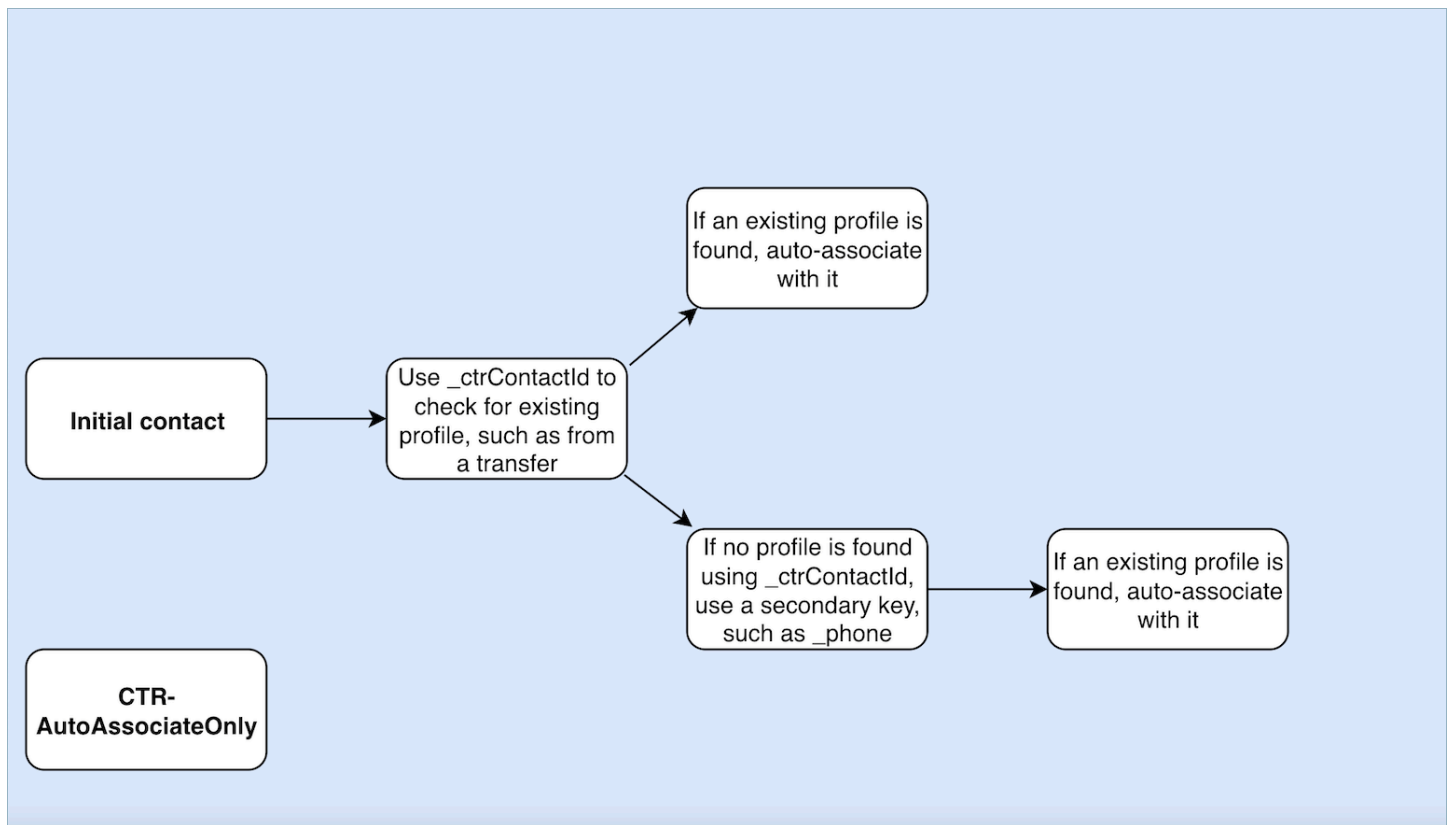

Create inferred profiles only (CTR)

Description

The CTR template relies solely on the `_ctrContactId` key to search for an existing profile, and it automatically associates the contact event with the profile if a match is found. However, in cases where no existing profile is found, the template creates an inferred profile and populates it with the contact event meta-data.

Although this behavior ensures that contact events are captured even when no pre-existing profile exists, it can potentially result in the creation of numerous inferred profiles. This abundance of inferred profiles may lead to the issue of duplicate profiles within the system.

To address this concern and promote better profile management practices, we highly recommend utilizing the CTR-NoInferred template as the default option. By using the CTR-NoInferred template, the system eliminates the creation of inferred profiles, thereby reducing the occurrence of duplicate profiles. This template allows for a more streamlined and efficient handling of contact events, resulting in improved data integrity and accuracy.

By adopting the CTR-NoInferred template as the default choice, organizations can optimize their profile management processes, minimize data duplication, and ensure a more reliable representation of customer interactions.

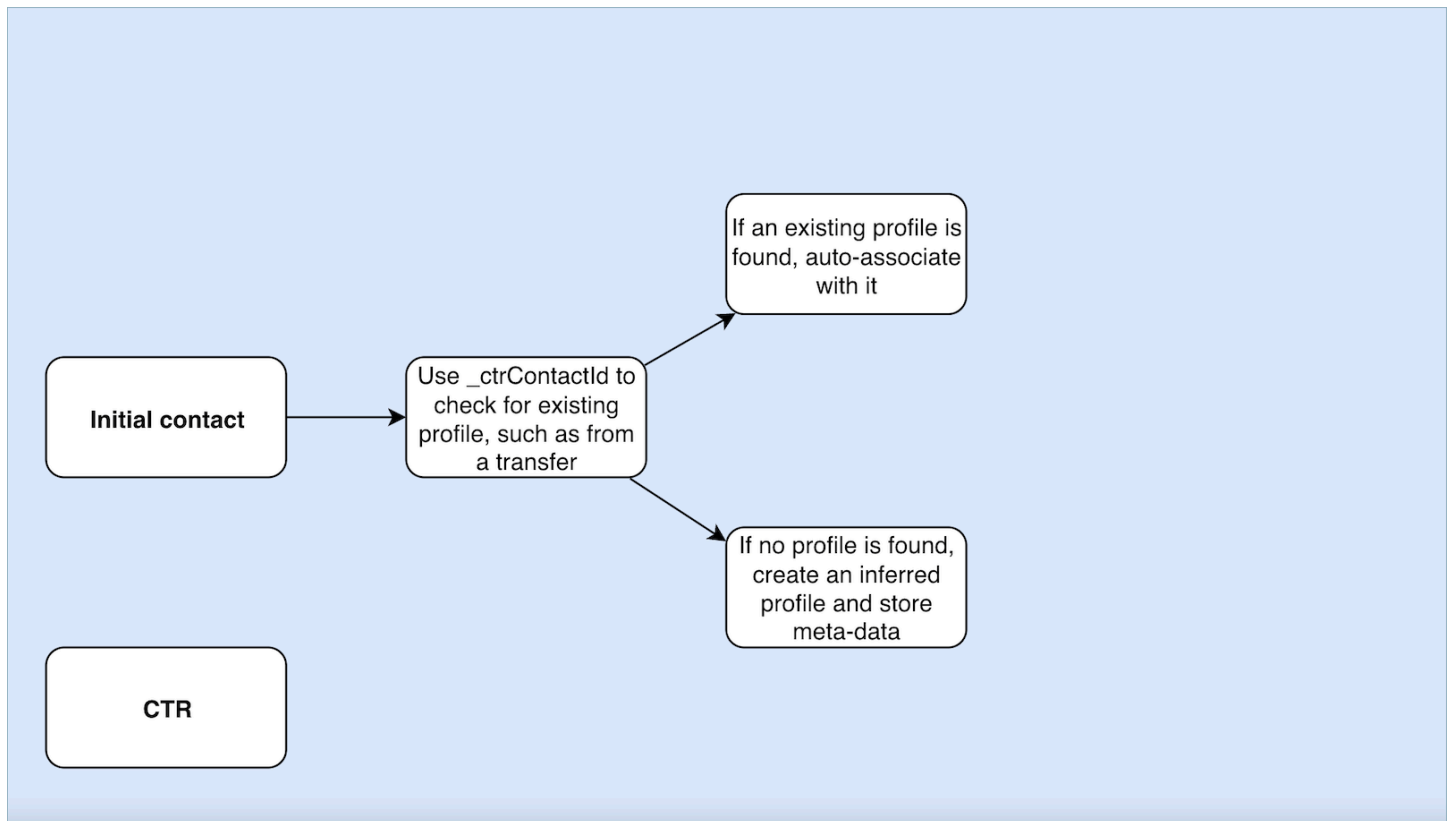

Contact record template usage examples

Amazon Connect admin center

- In the console UI, when creating a new domain, you have the option to select the desired CTR behavior. This can be done through the radio button options available in the **Profile creation and auto-association** section. Similarly, when selecting an existing domain, the radio button option will reflect the behavior previously associated with that domain.
- When editing a currently enabled domain, the Domain details page will display the currently applied behavior in the **Profile creation and auto-association** section. By choosing the **Edit** button in the header of this section, you will be redirected to the **Edit Profile creation and auto-association** page. Here, you can choose a different behavior according to your requirements.
- Alternatively, if you are viewing the CTR mapping from the **Data mapping** page, you can choose the **Change template** button. This action will also take you to the **Edit Profile creation and auto-association** page, where you can select a different behavior that suits your needs.

These options provide you with flexibility in managing the CTR behavior for your domains, allowing you to easily customize and modify the settings based on your specific preferences or evolving business requirements.

AWS CLI

- To use the **CTR-NoInferred** template, run the following command on the CLI:

```
aws customer-profiles put-profile-object-type --domain-name {domain} --object-type-name CTR --description "Creates inferred profiles and auto-associates profiles" --template-id CTR-NoInferred
```

- To use the **CTR-AutoAssociateOnly** template, run the following command on the CLI:

```
aws customer-profiles put-profile-object-type --domain-name {domain} --object-type-name CTR --description "Auto-associate with profiles only" --template-id CTR-AutoAssociateOnly
```

- To use the **CTR** template, run the following command on the CLI:

```
aws customer-profiles put-profile-object-type --domain-name {domain} --object-type-name CTR --description "Creates inferred profiles only" --template-id CTR
```

API

For information on using the API, see [PutProfileObjectType](#)

Automatically associate the Contact Record with one profile found using the `_phone` key

You can automatically associate the Contact Record with one profile found using the `_phone` key.

Example

In the domain, the following profile is created by the `CreateProfile` API:

```
{
  "FirstName": "John",
  "LastName": "Doe",
  "PhoneNumber": "+11234567890"
```

```
}
```

When a call is received from the `PhoneNumber +11234567890` using the default CTR template, the Contact Record will not be automatically associated with the above profile unless an agent has already manually associated the Contact Record with the same caller to the above profile. If the Contact Record was not associated manually or automatically, Customer Profiles will create an inferred profile with the information from the Contact Record.

To automatically associate the above profile with contact records without manual agent intervention, you can use the CTR-NoInferred template. When a call is received from the `PhoneNumber +11234567890` using the CTR-NoInferred template, the Contact Record will automatically associate with the above profile using the `_phone` profile key.

There are two scenarios in which Customer Profiles will *not* be able to automatically associate Contact Records to a profile:

- If more than one profile is found using the `_phone` profile key, Customer Profiles cannot associate the Contact Record to a unique profile and the request will be rejected.
- If no profile is found for the `_phone` profile key, Customer Profiles will create an inferred profile.

To use the CTR-NoInferred template to replace the default CTR template, run the following command on the CLI:

```
aws customer-profiles put-profile-object-type --domain-name {domain} --  
object-type-name CTR --description "No inferred contact record profiles" --  
template-id CTR-NoInferred
```

To revert to the default behavior, run the following command on the CLI:

```
aws customer-profiles put-profile-object-type --domain-name {domain} --  
object-type-name CTR --description "Revert to inferred contact record  
profiles" --template-id CTR
```

Examples of object type mappings

An object type mapping that generates a profile

The following example shows data that populates the standard profile.

Following is the incoming object:

```
{
  "account": 1234,
  "email": "john@examplecorp.com",
  "address": {
    "address1": "Street",
    "zip": "Zip",
    "city": "City"
  },
  "firstName": "John",
  "lastName": "Doe"
}
```

The following code shows that incoming object mapping into a standard profile object and indexing `PersonalEmailAddress`, `fullName`, and `accountId`, which is a unique key.

```
{
  "Fields": {
    "accountId": {
      "Source": "_source.account",
      "Target": "_profile.AccountNumber",
      "ContentType": "NUMBER"
    },
    "shippingAddress.address1": {
      "Source": "_source.address.address1",
      "Target": "_profile.ShippingAddress.Address1"
    },
    "shippingAddress.postalCode": {
      "Source": "_source.address.zip",
      "Target": "_profile.ShippingAddress.PostalCode"
    },
    "shippingAddress.city": {
      "Source": "_source.address.city",
      "Target": "_profile.ShippingAddress.City"
    },
    "personalEmailAddress": {
      "Source": "_source.email",
      "Target": "_profile.PersonalEmailAddress",
      "ContentType": "EMAIL_ADDRESS"
    },
    "fullName": {
```



```

        "Source": "{{_source.firstName}} {{_source.lastName}}"
    },
    "firstName": {
        "Source": "_source.firstName",
        "Target": "_profile.FirstName"
    },
    "lastName": {
        "Source": "_source.lastName",
        "Target": "_profile.LastName"
    }
},
"Keys": {
    "_email": [
        {
            "FieldNames": ["personalEmailAddress"]
        }
    ],
    "_fullName": [
        {
            "FieldNames": ["fullName"]
        }
    ],
    "_account": [
        {
            "StandardIdentifiers": ["PROFILE", "UNIQUE"],
            "FieldNames": ["accountId"]
        }
    ]
}
}

```

Note that email and fullname are indexed, but they aren't used to search for the profile. The account is the unique key. It is required to specify the object. Any time an object with the same account ID is ingested it overwrites the previous object with the same account ID.

Several fields are populated in the standard profile object (see the fields that have Target defined).

An object type mapping that doesn't populate the standard profile

This example shows a more complicated use case. It ingests data related to a profile but it doesn't necessarily populate the standard profile object.

Following is the incoming object:

```
{
  "email": "john@examplecorp.com",
  "timestamp": "2010-01-01T12:34:56Z",
  "subject": "Whatever this is about",
  "body": "Body of ticket"
}
```

Following is one way of mapping this data:

```
{
  "Fields": {
    "email": {
      "Source": "_source.email",
      "ContentType": "EMAIL_ADDRESS"
    },
    "timestamp": {
      "Source": "_source.timestamp"
    }
  },
  "Keys": {
    "_email": [
      {
        "StandardIdentifiers": ["PROFILE", "LOOKUP_ONLY"],
        "FieldNames": ["email"]
      }
    ],
    "ticketEmail": [
      {
        "StandardIdentifiers": ["PROFILE", "SECONDARY", "NEW_ONLY"],
        "FieldNames": ["email"]
      }
    ],
    "uniqueTicket": [
      {
        "StandardIdentifiers": ["UNIQUE"],
        "FieldNames": ["email", "timestamp"]
      }
    ]
  }
}
```

This example ingests the data and, at first lookup, it ingests the email address.

- If the email address matches a single profile, it is used to attach the data to that specific profile. The unique identifier for the ticket is comprised of the email and the timestamp since no other unique identifier exists.
- If no profile exists with the specified email, a new profile is created with the single field of `EmailAddress` filled in. The ingested object is attached to this new **inferred profile**. The two searchable keys that can find the profile are `_email` and `uniqueTicket`.
- If more than one profile exists with the specified email address, a new profile is created with the single field of `EmailAddress` filled in and the object is attached to this new profile. This profile is created with the `ticketEmail` key defined, in addition to `_email` and `uniqueTicket`. Any subsequent tickets from that email are assigned to this new **inferred profile**. The reason for this is that the `_email` key is referring to three profiles and is thus discarded, however the `ticketEmail` key only refers to a single profile (the new inferred one) and is still valid.
- In cases where a new **inferred profile** is created, the `EmailAddress` field is populated from the first object that created it.

Implicit profile object types

You can use any object type that matches the name of a template ID (as returned by the [ListProfileObjectTypeTemplates](#) API) without explicitly defining it. The object type will exactly match the definition of the template definition of this object type. If an explicit object type is defined, it replaces the implicit one.

Implicit object types are included in the [ListProfileObjectTypes](#) API or returned by [GetProfileObjectType](#) operations, but they can still be deleted if you want to remove all data ingested from that object type.

Generative AI powered data mapping

Amazon Connect Customer Profiles provides a generative AI powered customer data mapping capability that significantly reduces the time needed to create unified profiles, enabling you to help provide more personalized customer experiences.

With this capability, when contact center administrators add customer data from any of the 70+ available no-code data connectors such as Adobe Analytics, Salesforce, or Amazon Simple Storage Service (S3), Amazon Connect Customer Profiles will analyze the data from these sources

to automatically determine how to organize and combine data that exists in different formats across disparate sources into unified profiles in Amazon Connect. Contact center administrators can review and complete the setup of customer profiles, so they can provide agents with relevant customer information and dynamically personalize IVRs and chatbots to improve customer satisfaction and agent productivity.

Generative AI powered customer data mapping is available in the following regions:

- US East (N. Virginia)
- US West (Oregon)
- Africa (Cape Town)
- Asia Pacific (Singapore)
- Asia Pacific (Sydney)
- Asia Pacific (Tokyo)
- Asia Pacific (Seoul)
- Canada (Central)
- Europe (Frankfurt)
- Europe (London)

Set up generative AI powered data mapping

1. Open the Amazon Connect Customer Profiles console.
2. On the **Data source integrations** tab, choose **Add data source integration**.
3. Set up the connection. Select the data source from drop-down that has all supported connectors available.

Amazon Connect > Customer Profiles > Add data source integration

Step 1
Set up connection

Step 2
Map data

Step 3
Review and customize mapping

Step 4
Review and integrate

Set up connection

▼ How it works



Select data source
Choose from a list of featured connectors or connectors powered by Amazon AppFlow. [Learn more](#)

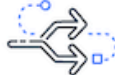

Select data mapping
Choose from pre-defined data mapping templates or create a custom data mapping to define your unified customer profile. [Learn more](#)



Set up data integration
Complete the set up by attaching a data mapping to your data source. [Learn more](#)

Data source

Supported data connectors, including Amazon AppFlow supported connectors.

Data source [Info](#)
Choose your data source or create a flow in AppFlow if your source is not available.

Choose source [Create new flow](#)

Featured

- Marketo
- S3
- Salesforce
- Segment
- ServiceNow
- Shopify
- Zendesk

Powered by AppFlow

- SAP OData
- Slack
- Zendesk Sell
- Other data connector

Cancel [Next](#)

4. Map data. Select the option to auto-generate data mapping, or select an already existing mapping template or create one from scratch..

Amazon Connect > Customer Profiles > Add data source integration

Step 1
[Set up connection](#)

Step 2
Map data

Step 3
Review and customize mapping

Step 4
Review and Integrate

Map data

Define how data brought in from source systems is mapped to the Customer Profiles data model.

Mapping

Choose a mapping method or manually create your own mapping [?](#)

Mapping method [info](#)

Auto-generate mapping
Customize a mapping for your data automatically using our industry-trained Large Language Model (LLM).



Use existing mapping
Choose from standard templates or reuse custom mappings.



When we generate a mapping specific to your data:

- You can review the mapping before you submit it.
- You can provide a friendly name and description for the mapping.

Mapping Details

Mapping name

The name must start with a letter. It can contain up to 255 characters, which can be letters, numbers, underscores (_), or hyphens (-).

Description

Character count: 43/836

Cancel Previous **Next**

5. Review mapping summary. Review the auto-generated mapping results summary that shows all the customer attributes. Make edits to ingestion keys and confirm before starting data ingestion. For more on field mappings and keys, see [Object type mapping definition details](#).

Amazon Connect > Customer Profiles > Add data source integration

Step 1
[Set up connection](#)

Step 2
[Map data](#)

Step 3
Review and customize mapping

Step 4
Review and integrate

Review and customize mapping

 **Mapping successfully generated**
You can customize the mapping or choose **Next** to continue.

 **How we mapped your data**
We reviewed 8 attributes in your data and created Order object, Profile object. We set **Orderid** as a unique key that uniquely identifies your source object. We set **Customerid** as a profile key that uniquely identifies your profiles. We set **Orderid** as an order key that links your orders to a customer.

Mapping summary

Data objects	Profile attributes	Attribute properties
2	9	2

▼ Profile object (1)
Attributes mapped to the [standard profile object](#)

Source	Attribute	Properties Info	Actions
Customerid	Attributes.Customerid	Profile key	⋮

▼ Order object (8)
Attributes mapped to the [standard order object](#)

Source	Attribute	Properties Info	Actions
Currency	Currency		⋮
Customerid	Attributes.Customerid		⋮
Orderid	Attributes.Orderid	Unique key Order key	⋮
OrderName	Name		⋮
OrderStatus	Status		⋮
OrderedAt	Attributes.OrderedAt		⋮
Price	TotalPrice		⋮
Tax	TotalTax		⋮

Cancel Previous Next

How it works

The system works in four phases. In the first phase, Customer Profiles fetches source attributes and, if available, samples data from your data source, subsequently determining the most appropriate object type for the target. For an Amazon S3 data source, the first CSV file found

in the selected Amazon S3 bucket and prefix will be used as the sample data. For other data sources, Customer Profiles fetches source attributes through AppFlow. In the second phase, a large language model (LLM) is leveraged to further process each of the custom attributes and map them to standard customer profile attributes. LLM is used again in the third phase to select the suitable attributes that can serve as keys, such as customer identifiers. Finally in the fourth phase, the timestamp format detector parses the timestamps to maintain the right chronological order of the records. The system is able to generate the mapping for up to 120 attributes in less than 20 seconds after combining the prediction results.

Generative AI powered data mapping troubleshooting

The following sections display the possible error messages that you may encounter. It also provides the cause and resolution for each issue.

Error: Could not parse object string into JSON

The object string in the request is not a valid JSON. Review the object string in the request and verify that it is valid JSON.

Error: Value at 'objects' failed to satisfy constraint: Member must have length less than or equal to 5

There are too many objects in the request. Up to five objects are allowed in a request. Reduce the number of objects to five or less.

Error: Breached limit of 120 attributes

Up to 120 attributes are allowed in a JSON object, including nested JSON attributes. Remove some attributes that don't need to be mapped from the JSON object.

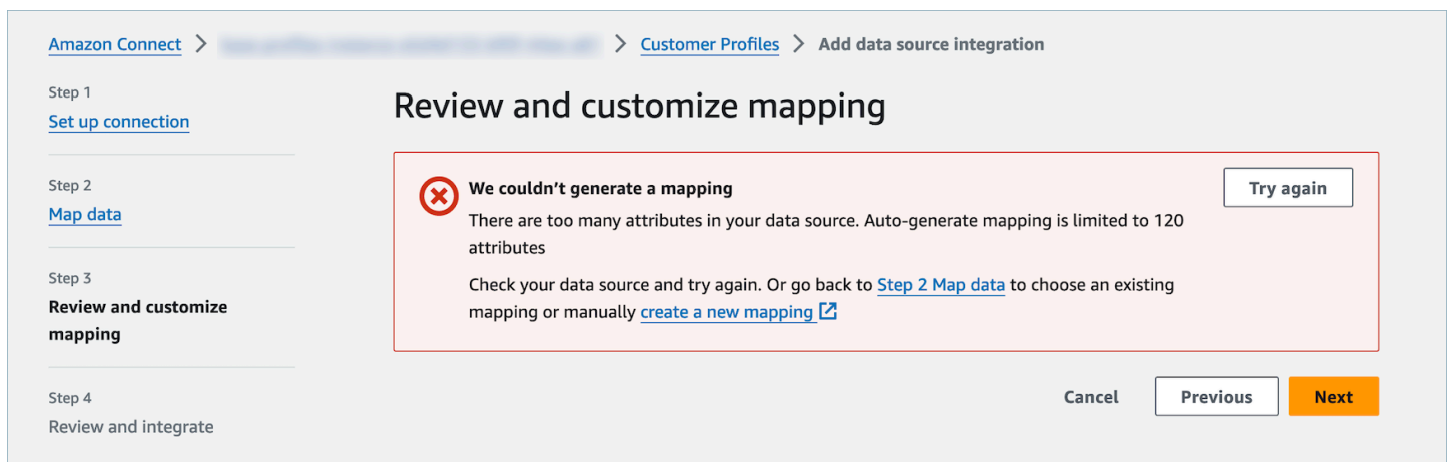

The screenshot shows the Amazon Connect console interface for 'Add data source integration'. The breadcrumb navigation is 'Amazon Connect > [Account ID] > Customer Profiles > Add data source integration'. The left sidebar shows a progress indicator with four steps: Step 1 'Set up connection', Step 2 'Map data', Step 3 'Review and customize mapping' (which is the active step), and Step 4 'Review and integrate'. The main content area is titled 'Review and customize mapping'. A red-bordered error box is displayed, containing a red 'X' icon and the text: 'We couldn't generate a mapping. There are too many attributes in your data source. Auto-generate mapping is limited to 120 attributes. Check your data source and try again. Or go back to [Step 2 Map data](#) to choose an existing mapping or manually [create a new mapping](#).' A 'Try again' button is located in the top right corner of the error box. At the bottom right of the main content area, there are three buttons: 'Cancel', 'Previous', and 'Next'.

Warning: We couldn't find a unique key, which distinguishes your data. We couldn't find a profile key, which identifies your profiles.

The model could not find a valid object type from given object. Change the input or use manual mapping approach as suggested.

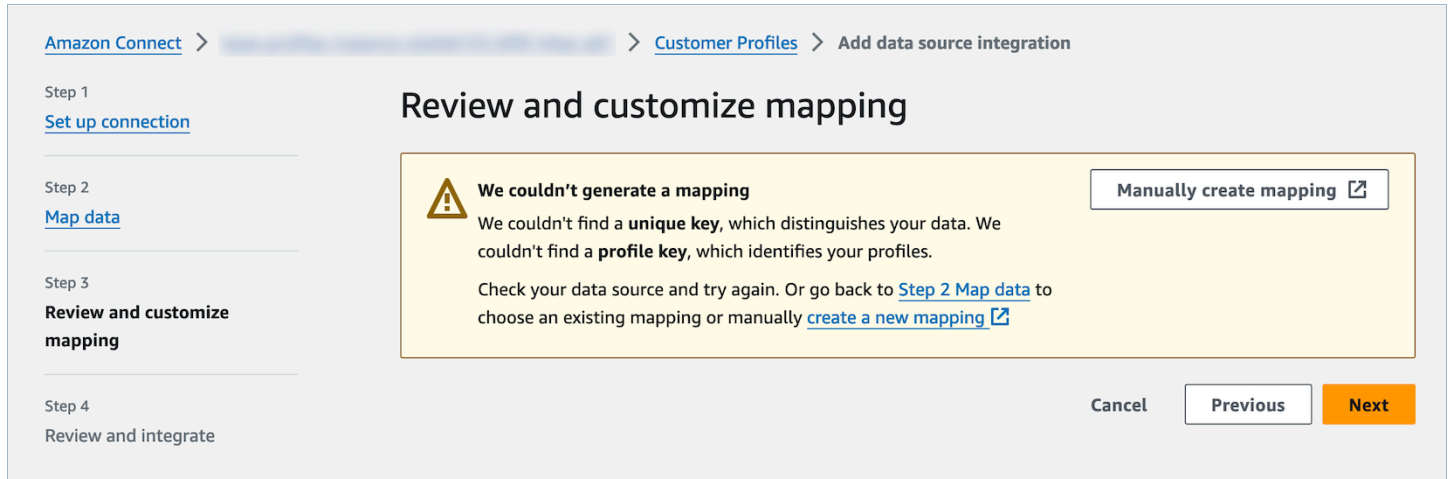

The screenshot shows the Amazon Connect console interface for 'Add data source integration'. The breadcrumb trail is 'Amazon Connect > Customer Profiles > Add data source integration'. The current step is 'Step 3: Review and customize mapping'. A yellow warning box is displayed with the following text: 'We couldn't generate a mapping. We couldn't find a **unique key**, which distinguishes your data. We couldn't find a **profile key**, which identifies your profiles. Check your data source and try again. Or go back to [Step 2 Map data](#) to choose an existing mapping or manually [create a new mapping](#)'. A 'Manually create mapping' button is located in the top right of the warning box. At the bottom right of the console, there are 'Cancel', 'Previous', and 'Next' buttons.

Customer Profiles data limits

Amazon Connect Customer Profiles allows you to customize your data onboarding by setting data ingestion limits on various types of customer data that you use to create a unified profile. Setting limits on your data mappings enables you to prioritize how much data to ingest across mappings. The default maximum limit across all mappings per profile is 1000.

Note

Data limits are estimates and may vary slightly, with a possible deviation of a few units in either direction during periods of high ingestion on a single profile.

How to configure Customer Profiles data limits

1. Open the Amazon Connect Customer Profiles console.
2. Choose the **Data limits** tab to configure limits for data objects.

Data source integrations | Data mappings | **Data limits** | Data export

Data limits (22) Clear Limit

Set up limits for your data mappings to prioritize how much data to ingest across mappings. Default maximum limit across all mappings per profile is 1000. Available Limit: 943

Search by data objects or limits

Data objects	Limits
<input type="radio"/> _asset	4
<input checked="" type="radio"/> _case	-
<input checked="" type="radio"/> _order	-
<input checked="" type="radio"/> AutoMap-S3-	-
<input checked="" type="radio"/> CTR	-
<input type="radio"/> CTR-AutoAssociateOnly	6
<input type="radio"/> CTR-NoInferred	8
<input type="radio"/> Marketo-leads	9
<input type="radio"/> newTest	10
<input type="radio"/> Salesforce-Account	2

3. Hover over the desired data object's limit and choose the edit icon.

Data source integrations | Data mappings | **Data limits** | Data export

Data limits (22) Clear Limit

Set up limits for your data mappings to prioritize how much data to ingest across mappings. Default maximum limit across all mappings per profile is 1000. Available Limit: 943

Search by data objects or limits

Data objects	Limits
<input type="radio"/> _asset	4
<input checked="" type="radio"/> _case	-
<input checked="" type="radio"/> _order	-
<input checked="" type="radio"/> AutoMap-S3-	-
<input checked="" type="radio"/> CTR	-
<input type="radio"/> CTR-AutoAssociateOnly	6
<input type="radio"/> CTR-NoInferred	8
<input type="radio"/> Marketo-leads	9
<input type="radio"/> newTest	10
<input type="radio"/> Salesforce-Account	2

4. Enter the limit and choose the check-mark icon to save or update the limit.

Data source integrations | Data mappings | **Data limits** | Data export

Data limits (22) Clear Limit

Set up limits for your data mappings to prioritize how much data to ingest across mappings. Default maximum limit across all mappings per profile is 1000. Available Limit: 939

Search by data objects or limits

Data objects	Limits
<input type="radio"/> _asset	4
<input checked="" type="radio"/> _case	-
<input checked="" type="radio"/> _order	-
<input type="radio"/> AutoMap-S3- [redacted]	4
<input checked="" type="radio"/> CTR	-
<input type="radio"/> CTR-AutoAssociateOnly	6
<input type="radio"/> CTR-NoInferred	8
<input type="radio"/> Marketo-leads	9
<input type="radio"/> newTest	10
<input type="radio"/> Salesforce-Account	2

1

2

How to clear Customer Profiles data limits

1. Select the radio button for the data object whose limit you want to clear. You will then be able to choose **Clear limit**.

Data source integrations | Data mappings | **Data limits** | Data export

Data limits (22) Clear Limit

Set up limits for your data mappings to prioritize how much data to ingest across mappings. Default maximum limit across all mappings per profile is 1000. Available Limit: 939

Search by data objects or limits

Data objects	Limits
<input type="radio"/> _asset	4
<input checked="" type="radio"/> _case	-
<input checked="" type="radio"/> _order	-
<input checked="" type="radio"/> AutoMap-S3- [redacted]	4
<input checked="" type="radio"/> CTR	-
<input type="radio"/> CTR-AutoAssociateOnly	6
<input type="radio"/> CTR-NoInferred	8
<input type="radio"/> Marketo-leads	9
<input type="radio"/> newTest	10
<input type="radio"/> Salesforce-Account	2

1

2

2. Type *confirm* to clear the limit value of the data object that you selected.

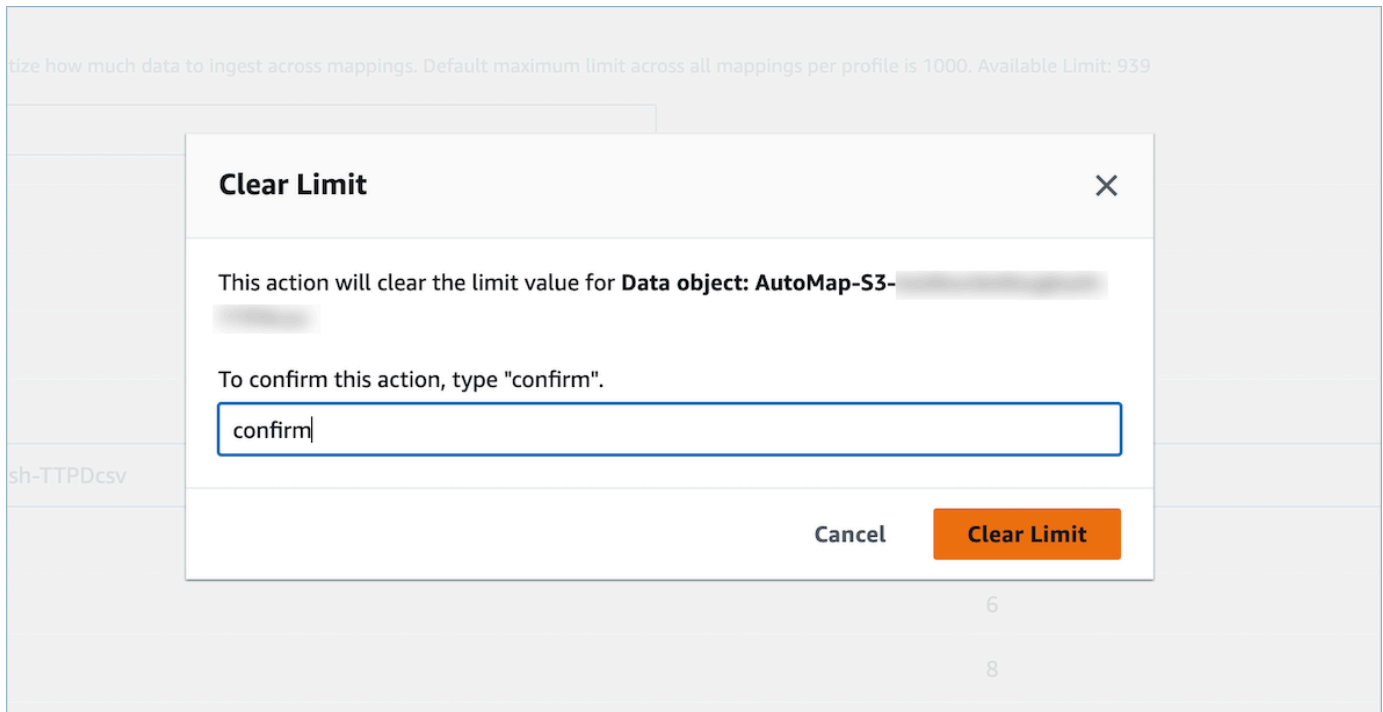

Create and ingest customer data into Customer Profiles by using Amazon S3

You can define data from any source using Amazon S3 and seamlessly enrich a customer profile without the need for custom or pre-built integrations. For example, say you want to provide agents with relevant purchase history information. You can import purchase transaction data from an internal application into a spreadsheet file on S3 and then link it to a customer profile.

To set this up, you need to define an [object type mapping](#) that describes what the custom profile object looks like. This mapping defines how fields from your data can be used to either populate fields in the standard profile or how it can be used to assign the data to a specific profile.

After you create the object type mapping, you can use the [PutProfileObject](#) API to upload the custom profile data from your CRM into the custom profile object.

Note

Customer Profiles does not support ingesting data from CSV headers that contain dot notation.

Set up real-time export

Amazon Connect Customer Profiles provides real-time data export of unified customer profiles to an Amazon Kinesis Data Stream. You can enable data streaming and automatically receive data for new profiles and updates to existing profiles into your Amazon Kinesis Data Stream.

You can keep your source systems data, such as CRMs and marketing automation tools, up-to-date with the latest information from Amazon Connect Customer Profiles. For example, when a customer calls your contact center to update their address, an agent can make the change to add the new customer address, and the updated profile information is sent to a Kinesis Data Stream in real-time.

To set this up, you need to enable **Data export** in the Customer Profiles console.

Enable real-time export

To enable data streaming for your domain

1. Open the Amazon Connect Customer Profiles console.
2. Select the **Data export** tab and choose **Enable data streaming**

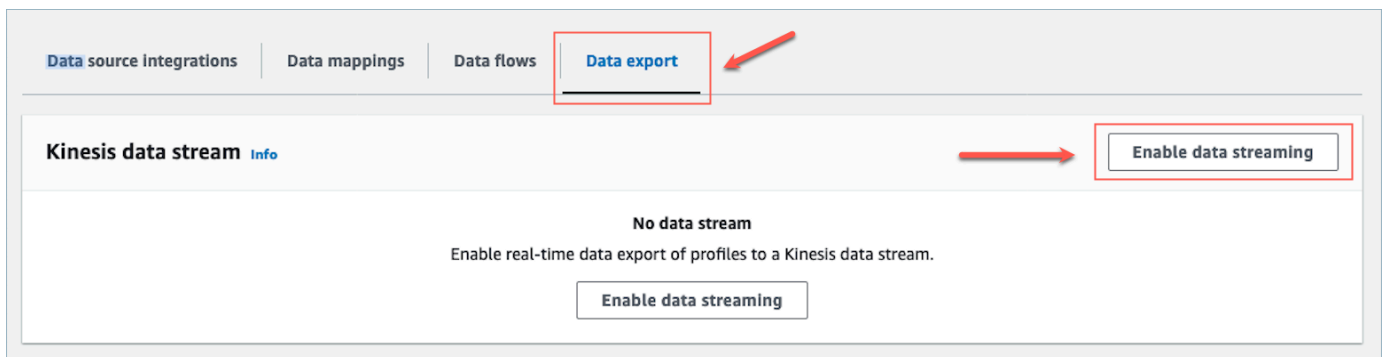

3. Choose **Enable data streaming** and select an existing Kinesis data stream from the drop-down menu, or choose **create a new Kinesis data stream** to open the Kinesis console and create the stream. For more information, see [Creating and Managing Streams](#).

Enable data streaming

Kinesis data stream [Info](#)

Set up real-time data streaming to export your customer profiles to a Kinesis data stream.

Enable data streaming

You are granting Customer Profiles permission to export new and updated customer profiles to your Kinesis data stream.

Kinesis data stream

Specify the location for delivering your data or [create a new Kinesis data stream](#)

Choose data stream

i By enabling data streaming, you are granting Amazon Connect Customer Profiles permission to export new and updated customer profiles to your Kinesis data stream. [Learn more](#)

Cancel

Enable data streaming

- Choose the **Enable data streaming** button to save your settings.

Enable real-time export

To disable data streaming for your domain

- Open the Amazon Connect Customer Profiles console.
- Select the **Data export** tab and choose **Disable data streaming**.

The screenshot shows the Amazon Connect console interface. At the top, there are navigation tabs: 'Data source integrations', 'Data mappings', 'Data flows', and 'Data export'. The 'Data export' tab is selected and highlighted with a red box and an arrow. Below the tabs, the 'Kinesis data stream' configuration page is visible. On the right side of this page, there is a button labeled 'Disable data streaming', which is also highlighted with a red box and an arrow. The main content area displays details for a Kinesis data stream, including its name, capacity mode (Provisioned), KMS key, and status (Active).

Data stream	Capacity mode	KMS key	Last update
arn:aws:kinesis:us-west-2:stream/Sample	Provisioned	arn:aws:kms:us-west-2:key/	-
Status: ✔ Active	Provisioned shards: 1		Last 15-day export summary: 0 events processed, 0 events throttled. View in CloudWatch
	Data retention period: 1 day		

Real-time export Kinesis payload

Sample output event in JSON

```
{
  "SchemaVersion": 0,
  "EventId": "eventId",
  "EventTimestamp": "2020-01-01T00:00:00Z",
  "EventType": "CREATED",
  "DomainName": "domainName",
  "ObjectTypeName": "objectTypeName",
  "AssociatedProfileId": "associatedProfileId",
  "ProfileObjectUniqueKey": "profileObjectUniqueKey",
  "Object": {
    "map": {
      "k1": [
        "a",
        "b",
        "c"
      ]
    }
  },
  "IsMessageRealTime": true
}
```

SchemaVersion

The current version of the schema.

EventId

The unique event ID.

EventTimestamp

Timestamp of the event using the ISO8601 standard.

EventType

The type of event exported.

Values: CREATED, UPDATED, HEALTH_CHECK

- **CREATED:** The export event was for CreateProfile.
- **UPDATED:** The export event was for a UpdateProfile.
- **HEALTH_CHECK:** The export event was for a HealthCheck event to make sure Customer Profiles could successfully putEvent in Kinesis Stream.

DomainName

The domain the event belongs to. /Domain of the event

ObjectTypeName

Object type of the event

Values: `_profile`, `_asset`, `_order`, `_case`. You can also use predefined template name such as `Salesforce-Account` or a custom defined object name that you can create using the [PutProfileObjectType](#) API.

AssociatedProfileId

ID of the Standard Profile that the Object is associated to. It is only present if the object type is not `_profile`

ProfileObjectUniqueKey

The unique identifier of the ProfileObject generated by the service.

Type: String

Object

The Standard Profile or Standard Profile Object itself.

IsMessageRealTime

Flag to inform if the message is real-time or was re-driven.

Sample payload in JSON

```
{
  "SchemaVersion": 0,
  "EventId": "6049bf39-0000-0000-0000-b75656dd51a8",
  "EventTimestamp": "2023-02-24T07:17:05.356Z",
  "EventType": "UPDATED",
  "DomainName": "SampleDomain",
```



```

"ObjectType": "Salesforce-Account",
"AssociatedProfileId": "5ffcee99ab0000000000b3ae01225e40",
"ProfileObjectUniqueKey": "cNo77ZI000000000pCPB7RQcqfeBaRfBwrzW2MMbws=",
"Object": {
  "Id": "0012v00002kVKVuAA0",
  "IsDeleted": false,
  "Name": "Company A",
  "Phone": "+12065551234",
  "PhotoUrl": "/services/images/photo/0012v00002kVKVuAA0",
  "OwnerId": "0052v00000fmQ7sAAE",
  "CreateDate": "2019-12-13T07:56:04.000+0000",
  "CreatedBy": "0052v00000fmQ7sAAE",
  "LastModifiedDate": "2023-02-22T20:29:43.000+0000",
  "LastModifiedBy": "0052v00000fmQ7sAAE",
  "SystemModstamp": "2023-02-22T20:29:43.000+0000",
  "LastActivityDate": "2020-03-18",
  "LastViewedDate": "2023-02-23T00:09:49.000+0000",
  "LastReferencedDate": "2023-02-23T00:09:49.000+0000",
  "CleanStatus": "Pending"
},
"IsMessageRealTime": true
}

```

Real-time export troubleshooting

There may be a delay when first exporting events to your Kinesis Data Stream. This is due to the time it takes to propagate IAM permissions for the service-linked role. When an actual issue occurs, the streaming status can enter an error state.

The screenshot shows the Amazon Connect console interface for a Kinesis data stream. The 'Data export' tab is selected. The stream name is 'Kinesis data stream' with an 'Info' link. A 'Disable data streaming' button is visible in the top right. The stream details are as follows:

- Data stream:** `arn:aws:kinesis:ca-central-1:stream/Sample`
- Capacity mode:** Provisioned
- Provisioned shards:** -
- Data retention period:** 1 day
- KMS key:** Not encrypted
- Last update:** Streaming stopped since March 23, 2023, 22:45 (UTC)
- Status:** Error
- Message:** Data stream not active. We are unable to export your data at this time. You must verify the data stream is active and try again later. [Learn more](#)
- Last 15-day export summary:** 0 events processed, 0 events throttled. [View in CloudWatch](#)

The following sections display the possible error messages that you may encounter. It also provides the cause and resolution for each issue.

Error: The Kinesis Data Stream is not Active. Please check the configuration and recreate the event stream later

The destination Kinesis Data Stream is not in ACTIVE state. This can happen when your Kinesis Data Stream is being created or being deleted. To resolve the error, make sure your Kinesis Data Stream is in ACTIVE state and re-enable the data streaming setting.

Error: The Kinesis Data Stream does not exist. Please recreate the event stream with valid Kinesis Data Stream destination

The destination Kinesis Data Stream is deleted. To resolve the error, re-enable data streaming with an existing Kinesis Data Stream as the destination.

Error: The Kinesis Data Stream is being throttled. Please consider provision higher Kinesis throughput appropriately

The destination Kinesis Data Stream is being throttled (under-provisioned). To resolve the error, make sure the destination Kinesis Data Stream has enough shard count and then re-enable data streaming.

Error: The KMS key used to encrypt Kinesis Data Stream is being throttled. Please consider increasing the KMS request quota appropriately

The KMS key used by Kinesis Data Stream is being throttled. To resolve the error, re-enable data streaming.

Error: Check the KMS Key configuration of you Kinesis Data Stream

Customer Profiles cannot access the KMS key used by Kinesis Data Stream. This can happen when your KMS key has a key policy that denies access from Customer Profiles service-linked role, or the key is not in Enabled status. To resolve the error, make sure the KMS key policy does not deny access from Customer Profiles service-linked role, and the key is in Enabled status. Re-enable data streaming to resolve the error.

Delete Customer Profiles domain

Deleting mappings will only delete objects and data associated with that specific mapping. If there are multiple objects associated with a profile, then deleting a specific mapping may not clear the profile data. If you want to delete specific data, you would then delete the mapping, but your profiles may still exist if they contain data from other mappings. This could result in additional charges for the existing profiles. To avoid this from occurring, you can delete your Customer Profiles domain using the Amazon Connect console by following these steps.

1. Login to the Amazon Connect console and select Customer Profiles from the left navigation pane. Choose your Customer Profiles domain and then choose **View details**.

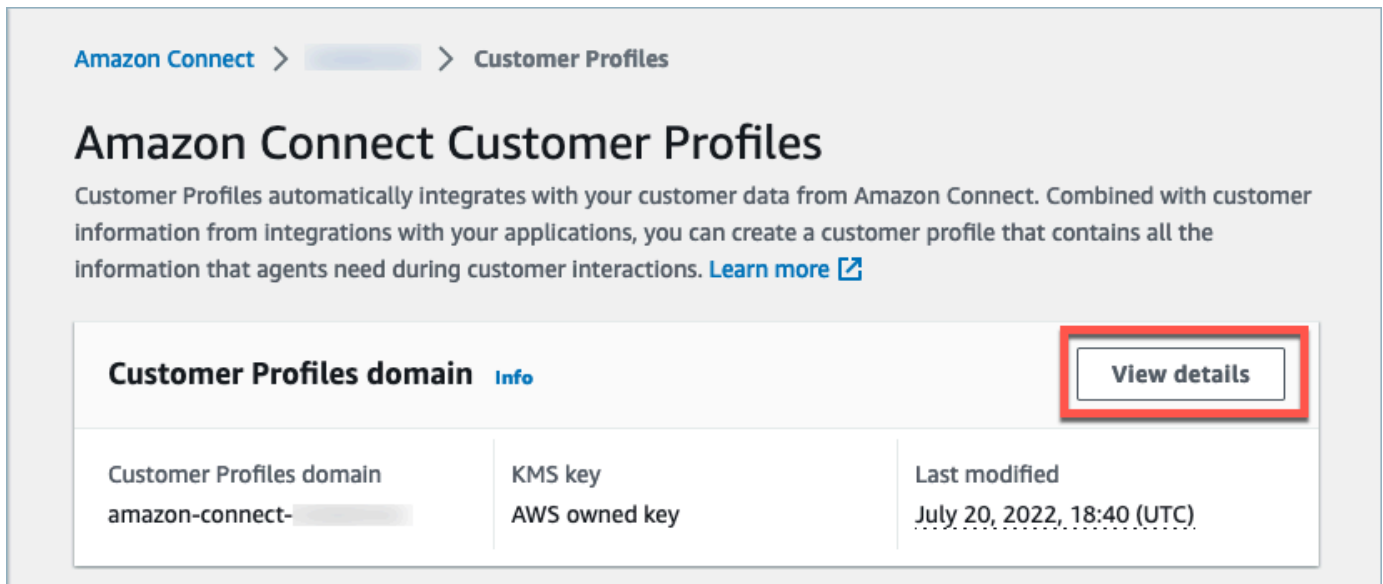

The screenshot shows the Amazon Connect console interface for Customer Profiles. The breadcrumb navigation is "Amazon Connect > [domain] > Customer Profiles". The main heading is "Amazon Connect Customer Profiles". Below the heading is a descriptive paragraph and a "Learn more" link. A table lists the domain details, with the "View details" button highlighted in red.

Customer Profiles domain Info		
Customer Profiles domain	KMS key	Last modified
amazon-connect-[domain]	AWS owned key	July 20, 2022, 18:40 (UTC)

2. Choose **Delete domain**.

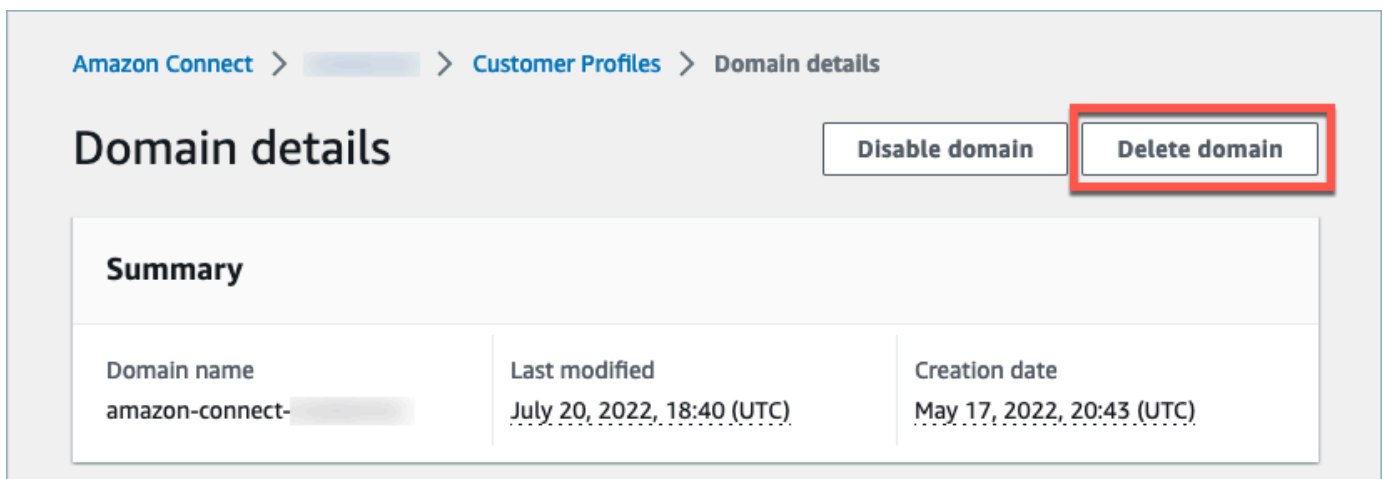

The screenshot shows the Amazon Connect console interface for Domain details. The breadcrumb navigation is "Amazon Connect > [domain] > Customer Profiles > Domain details". The main heading is "Domain details". Below the heading are two buttons: "Disable domain" and "Delete domain", with the "Delete domain" button highlighted in red. A table lists the domain summary details.

Summary		
Domain name	Last modified	Creation date
amazon-connect-[domain]	July 20, 2022, 18:40 (UTC)	May 17, 2022, 20:43 (UTC)

3. To delete your domain, enter *confirm* in the box and choose **Delete domain**.

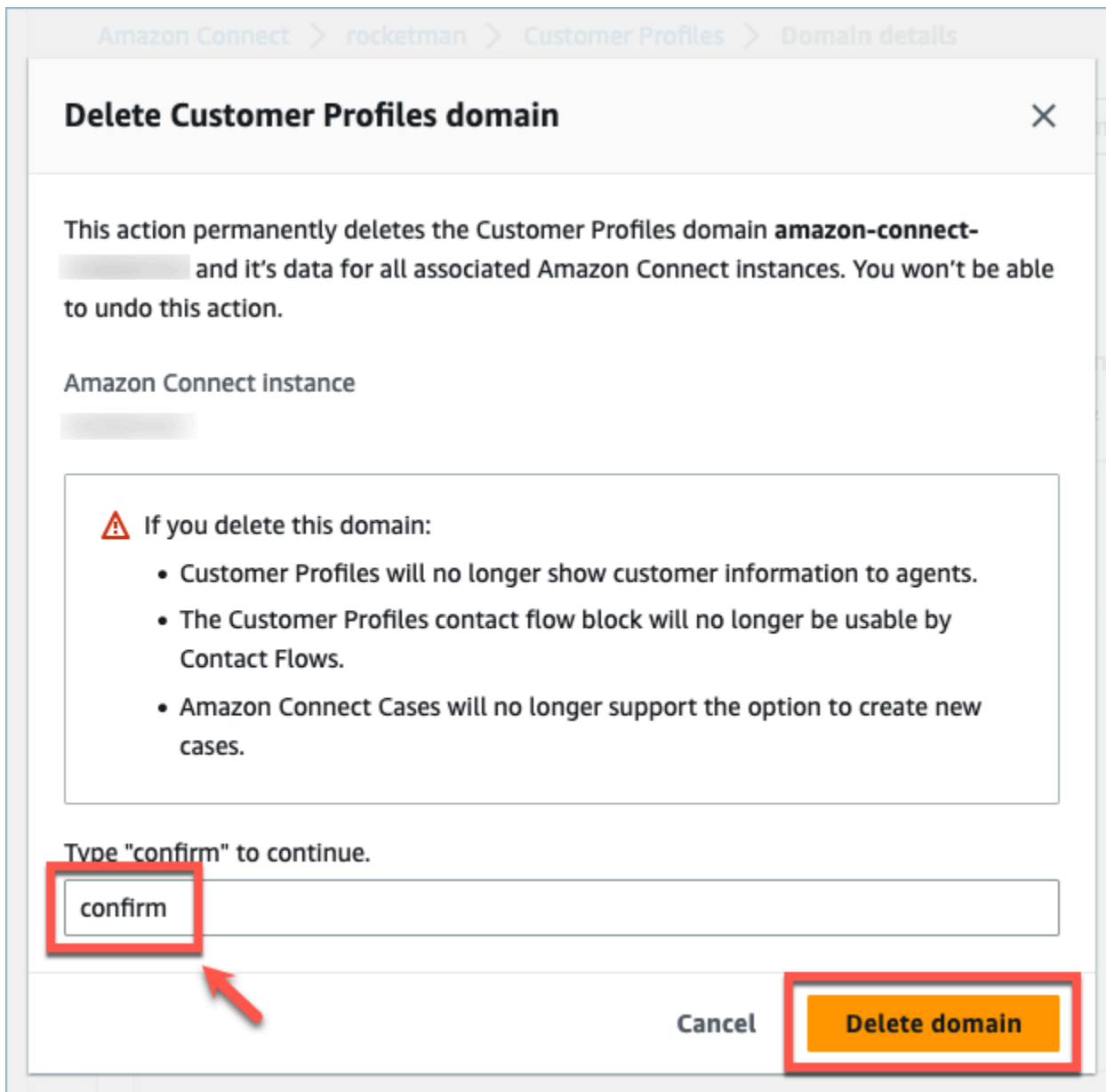

Customer Profiles Calculated Attributes

Amazon Connect Customer Profiles support the creation of calculated attributes which enables companies to define their own business logic to transform their customer profile data into actionable data points to personalize automated experiences such as interactive voice responses.

By using calculated attributes, companies can identify key attributes about their customer's past behaviour (such as the last website visited or last agent spoken to), patterns of behaviour (such as preferred channel, frequency of contact), and customer value (such as new customer, average ticket

size). Companies can use the calculated attributes API to create a new attribute using common aggregation operations such as average, count, minimum, maximum, and sum.

Calculated attributes automatically transforms raw data in real-time into actionable data points and metrics. Contact center administrators are able to define and configure calculations based on the raw data available in customer profiles. These calculated attributes make it easier for you to build automated experiences such as Interactive Voice Response (IVR) or chatbots. You can build personalized experiences and help agents understand customer context faster.

The calculated attributes API is available in the following regions:

- US East (N. Virginia)
- US West (Oregon)
- Africa (Cape Town)
- Asia Pacific (Singapore)
- Asia Pacific (Sydney)
- Asia Pacific (Tokyo)
- Asia Pacific (Seoul)
- Canada (Central)
- Europe (Frankfurt)
- Europe (London)

Contents

- [Calculated Attributes APIs](#)
- [Creating a custom calculated attribute definition](#)
- [Validating calculated attribute values using the API](#)
- [Default Calculated Attributes](#)
- [Error state and troubleshooting](#)

Calculated Attributes APIs

You can use the following Customer Profiles calculated attribute APIs

CreateCalculatedAttributeDefinition

CreateCalculatedAttributeDefinition

Create a new calculated attribute. This requires an existing object type in the domain. You can define attributes that you want to pull from a single source object and the mathematical operations to apply to them in aggregate as well as the time range and object count.

After creation, new object data ingested into Customer Profiles will be included in the calculated attribute, which can be retrieved for a profile using the `GetCalculatedAttributeForProfile` API. Defining a calculated attribute makes it available for all profiles within a domain. Each calculated attribute can only reference one `ObjectType` and at most two fields from that `ObjectType`.

Request

```
POST /domains/DomainName/calculated-attributes/CalculatedAttributeName
```

```
{
  "CalculatedAttributeName": "string",
  "DisplayName": "string",
  "Description": "string",
  "AttributeDetails": {
    "Attributes": [
      {
        "Name": "string"
      }
      ...
    ],
    "Expression": "string",
  },
  "Statistic": "AVERAGE" | "COUNT" | "SUM" | "FIRST_OCCURRENCE" |
  "LAST_OCCURRENCE" | "MINIMUM" | "MAXIMUM" | "MAX_OCCURRENCE",
  "Conditions": {
    "Range": {
      "Value": "number",
      "Units": "string"
    },
    "ObjectCount": "number",
    "Threshold": {
```

```

        "Value": "string",
        "Operator": "EQUAL_TO" | "GREATER_THAN" | "LESS_THAN" | "NOT_EQUAL_TO"
    }
},
"Tags": {}
}

```

Response

```

{
  "CalculatedAttributeName": "string",
  "DisplayName": "string",
  "Description": "string",
  "AttributeDetails": {
    "Attributes": [
      {
        "Name": "string"
      }
      ...
    ],
    "Expression": "string",
  },
  "Statistic": "AVERAGE" | "COUNT" | "SUM" | "FIRST_OCCURRENCE" |
"LAST_OCCURRENCE" | "MINIMUM" | "MAXIMUM" | "MAX_OCCURRENCE"
  "Conditions": {
    "Range": {
      "Value": "number",
      "Units": "string"
    },
    "ObjectCount": "number",
    "Threshold": {
      "Value": "string",
      "Operator": "EQUAL_TO" | "GREATER_THAN" | "LESS_THAN" | "NOT_EQUAL_TO"
    }
  },
  "CreatedAt": number,
  "LastUpdatedAt": number,
  "Tags": {}
}

```

Request body

- **CalculatedAttributeName**

The unique (per domain) name of the calculated attribute.

- Type : String
- Length Constraints: Minimum length of 1. Maximum length of 64.
- Pattern: `^[a-zA-Z0-9_-]+$`
- Required: Yes

- **DisplayName**

The display name of the calculated attribute.

- Length Constraints: Minimum length of 1. Maximum length of 64.
- Pattern: `^[a-zA-Z_][a-zA-Z_0-9-\s]*$`
- Required: No

- **Description**

The description of the calculated attribute.

- Type : String
- Length Constraints: Minimum length of 1. Maximum length of 1000.
- Required: No

- **AttributeDetails**

Details of the attributes used in the definition and the mathematical operations involved between the attributes. See the following components:

- **Attributes**

A list of attribute items specified in the mathematical expression.

- **AttributeItem**

The details of a single attribute item specified in the mathematical expression.

- Name
 - The name of an attribute defined in a profile object type.

- **Type: String**

- **Expression**

Mathematical expression that is performed on attribute items provided in the attribute list. Each element in the expression should follow the structure of `\"{ObjectTypeName.AttributeName}\"`.

- Example : `{ObjA.AttributeA} - {ObjA.AttributeB}`
- Type : String
- We only support the following mathematical operations: + - * /
- You cannot make modifications to the Expression once a calculated attribute definition is created

- **Conditions**

Defines the calculated attribute aggregation criteria and threshold.

- Type: Conditions object
 - Range
 - ObjectCount
 - Threshold

- **Range**

The relative time period over which data is included in the aggregation.

- Type: Range object
 - Value: The length of time of the specified units
 - Unit: Unit of time
 - Valid values: Days
- Required: Yes
- Initial scope: Max of 366 days

- **ObjectCount**

The number of profile objects used for the calculated attribute.

- Type: Number
- Range: 1 through 100
- Required: No

- **Threshold**

~~The comparison logic to generate a true/false calculated attribute.~~

- **Type: Threshold object**
 - **Value**
 - The value of the threshold
 - Type: String
 - Required: No
 - **Operator**
 - The operator of the threshold
 - Type: ENUM
 - Valid Values:
 - GREATER_THAN
 - LESS_THAN
 - EQUAL_TO
 - NOT_EQUAL_TO
 - Required: No

- **Statistic**

The aggregation operation to perform for the calculated attribute.

- Type: ENUM
- Valid Values:
 - FIRST_OCCURRENCE
 - LAST_OCCURRENCE
 - COUNT
 - SUM
 - MINIMUM
 - MAXIMUM
 - AVERAGE
 - MAX_OCCURRENCE

UpdateCalculatedAttributeDefinition

Update a calculated attribute definition. Updates are limited to display name, description, time range, object count, and threshold. This API supports partial updates, so only the parameters that require updating need to be included.

When updating the Conditions, note that increasing the date range of a calculated attribute will not trigger inclusion of historical data greater than the current date range.

Request

```
PUT /domains/DomainName/calculated-attributes/CalculatedAttributeName
```

```
{
  "DisplayName": "string",
  "Description": "string",
  "Conditions": {
    "Range": {
      "Value": "number",
      "Units": "string"
    },
    "ObjectCount": "number",
    "Threshold": {
      "Value": "string",
      "Operator": "EQUAL_TO" | "GREATER_THAN" | "LESS_THAN" | "NOT_EQUAL_TO"
    }
  }
}
```

Response

```
{
  "CalculatedAttributeName": "string",
  "DisplayName": "string",
  "Description": "string",
  "AttributeDetails": {
    "Attributes": [
      {
        "Name": "string"
      }
    ]
  }
}
```

```

    ...
  ],
  "Expression": "string",
},
"Statistic": "AVERAGE" | "COUNT" | "SUM" | "FIRST_OCCURRENCE" |
"LAST_OCCURRENCE" | "MINIMUM" | "MAXIMUM" | "MAX_OCCURRENCE"
"Conditions": {
  "Range": {
    "Value": "number",
    "Units": "string"
  },
  "ObjectCount": "number",
  "Threshold": {
    "Value": "string",
    "Operator": "EQUAL_TO" | "GREATER_THAN" | "LESS_THAN" | "NOT_EQUAL_TO"
  }
},
"CreatedAt": number,
"LastUpdatedAt": number,
"Tags": {}
}

```

Request body

- **DisplayName**

The display name of the calculated attribute.

- Length Constraints: Minimum length of 1. Maximum length of 64.
- Pattern: `^[a-zA-Z_][a-zA-Z_0-9-\s]*$`
- Required: No

- **Description**

The description of the calculated attribute.

- Type : String
- Length Constraints: Minimum length of 1. Maximum length of 1000.
- Required: No

- **Conditions**

Defines the calculated attribute aggregation criteria and threshold.

- **Type: Conditions object**
 - Range
 - ObjectCount
 - Threshold

- **Range**

The relative time period over which data is included in the aggregation.

- **Type: Range object**
 - Value: The length of time of the specified units
 - Unit: Unit of time
 - Valid values: Days
- Required: Yes
- Initial scope: Max of 366 days

- **ObjectCount**

The number of profile objects used for the calculated attribute.

- Type: Number
- Range: 1 through 100
- Required: No

- **Threshold**

The comparison logic to generate a true/false calculated attribute.

- **Type: Threshold object**
 - Value
 - The value of the threshold
 - Type: String
 - Required: No
 - Operator
 - The operator of the threshold
 - Type: ENUM
 - **Valid Values:**
 - GREATER_THAN

- LESS_THAN
 - EQUAL_TO
 - NOT_EQUAL_TO
- Required: No

GetCalculatedAttributeDefinition

GetCalculatedAttributeDefinition

Retrieve a calculated attribute definition.

Request

```
GET /domains/DomainName/calculated-attributes/CalculatedAttributeName
```

Request Body

The request does not have a request body.

Response

```
{
  "CalculatedAttributeName": "string",
  "DisplayName": "string",
  "Description": "string",
  "AttributeDetails": {
    "Attributes": [
      {
        "Name": "string"
      }
      ...
    ],
    "Expression": "string",
  },
  "Statistic": "AVERAGE" | "COUNT" | "SUM" | "FIRST_OCCURRENCE" |
  "LAST_OCCURRENCE" | "MINIMUM" | "MAXIMUM" | "MAX_OCCURRENCE"
  "Conditions": {
    "Range": {
```

```
        "Value": "number",
        "Units": "string"
    },
    "ObjectCount": "number",
    "Threshold": {
        "Value": "string",
        "Operator": "EQUAL_TO" | "GREATER_THAN" | "LESS_THAN" | "NOT_EQUAL_TO"
    }
},
"CreatedAt": number,
"LastUpdatedAt": number,
"Tags": {}
}
```

URI request parameters

- **DomainName**

The unique name of the domain.

- Length Constraints: Minimum length of 1. Maximum length of 64.
- Pattern: `^[a-zA-Z0-9_-]+$`
- Required: Yes

- **CalculatedAttributeName**

The unique (per domain) name of the calculated attribute.

- Type : String
- Length Constraints: Minimum length of 1. Maximum length of 64.
- Pattern: `^[a-zA-Z0-9_-]+$`
- Required: Yes

DeleteCalculatedAttributeDefinition

DeleteCalculatedAttributeDefinition

Delete an existing calculated attribute definition. Note that deleting a default calculated attribute is possible, however once deleted you will be unable to undo that action and will need to recreate it on your own using the `CreateCalculatedAttributeDefinition` API if you want it back.

Request

```
DELETE /domains/DomainName/calculated-attributes/CalculatedAttributeName
```

Request Body

The request does not have a request body.

Response

The response does not have a response body.

URI request parameters

- **DomainName**

The unique name of the domain.

- Length Constraints: Minimum length of 1. Maximum length of 64.
- Pattern: `^[a-zA-Z0-9_-]+$`
- Required: Yes

- **CalculatedAttributeName**

The unique (per domain) name of the calculated attribute.

- Type : String
- Length Constraints: Minimum length of 1. Maximum length of 64.
- Pattern: `^[a-zA-Z0-9_-]+$`
- Required: Yes

ListCalculatedAttributeDefinitions

ListCalculatedAttributeDefinitions

Retrieve all calculated attribute definitions for a domain.

Request

```
GET /domains/DomainName/calculated-attributes?max-results=MaxResults&next-token=NextToken
```

Request Body

The request does not have a request body.

Response

```
{
  "Items": [
    {
      "CalculatedAttributeName": "string",
      "DisplayName": "string",
      "Description": "string",
      "CreatedAt": "timestamp",
      "LastUpdatedAt": "timestamp"
    },
    ...
  ],
  "NextToken": "string"
}
```

URI request parameters

- **DomainName**

The unique name of the domain.

- Length Constraints: Minimum length of 1. Maximum length of 64.
- Pattern: `^[a-zA-Z0-9_-]+$`
- Required: Yes

- **MaxResults**

The maximum number of objects returned per page.

- Valid Range: Minimum value of 1. Maximum value of 100

- **NextToken**

The pagination token from the previous ListCalculatedAttributeDefinition API call.

- Length Constraints: Minimum length of 1. Maximum length of 1024

GetCalculatedAttributeForProfile

GetCalculatedAttributeForProfile

Initiates the calculation and retrieves the result of a single calculated attribute for a single profile.

Request

```
GET /domains/DomainName/profile/ProfileId/calculated-attributes/CalculatedAttributeName
```

Request Body

The request does not have a request body.

Response

```
{
  "Name": "string",
  "DisplayName": "string",
  "Value": "string",
  "IsDataPaternal": "string"
}
```

URI request parameters

- **DomainName**

The unique name of the domain.

- Length Constraints: Minimum length of 1. Maximum length of 64.

- Pattern: `^[a-zA-Z0-9_-]+$`
- Required: Yes
- **CalculatedAttributeName**

The unique (per domain) name of the calculated attribute.

- Type : String
- Length Constraints: Minimum length of 1. Maximum length of 64.
- Pattern: `^[a-zA-Z0-9_-]+$`
- Required: Yes

ListCalculatedAttributesForProfile

ListCalculatedAttributesForProfile

Initiates the calculation and retrieves the results of all calculated attributes for a single profile.

Request

```
GET /domains/DomainName/profile/ProfileId/calculated-attributes?max-  
results=MaxResults&next-token=NextToken
```

Request Body

The request does not have a request body.

Response

```
{  
  "Items": [  
    {  
      "CalculatedAttributeName": "string",  
      "DisplayName": "string",  
      "Value": "string",  
      "IsDataPartial" : "string"  
    },  
    ...  
  ]  
}
```

```
    ],  
    "NextToken": "string"  
  }
```

URI request parameters

- **DomainName**

The unique name of the domain.

- Length Constraints: Minimum length of 1. Maximum length of 64.
- Pattern: `^[a-zA-Z0-9_-]+$`
- Required: Yes

- **ProfileId**

- Pattern: `[a-f0-9]{32}`
- Required: Yes

- **MaxResults**

The maximum number of objects returned per page.

- Valid Range: Minimum value of 1. Maximum value of 100

- **NextToken**

The pagination token from the previous `ListCalculatedAttributeDefinition` API call.

- Length Constraints: Minimum length of 1. Maximum length of 1024

Creating a custom calculated attribute definition

Using the Customer Profiles [CreateCalculatedAttributeDefinition](#) API, you can programmatically create your own calculated attribute based on a custom object type.

In this topic we show how to create a calculated attribute using a custom JSON file.

Step 1: Create a JSON file

Create a JSON file with the following contents:

```

{
  "DomainName": "your-domain-name",
  "CalculatedAttributeName": "your-calculated-attribute-name",
  "DisplayName": "your-display-name",
  "Description": "your-description",
  "AttributeDetails": {
    "Attributes": [
      {
        "Name": "your-attribute-name"
      }
    ],
    "Expression": "{your-object-type.your-attribute-name}"
  },
  "Statistic": "your-statistic",
  "Conditions": {
    "Range": {
      "Value": your-range-value,
      "Unit": "days"
    },
    "ObjectCount": your-object-count,
    "Threshold": {
      "Value": "your-threshold-value",
      "Operator": "your-threshold-operator"
    }
  }
}

```

To customize the JSON with your own values, follow these guidelines:

- **Attributes:** This should contain the name of the field from your object type that you want to use for the calculated attribute. Two attributes being referenced in this list are supported.
- **Expression:** Basic math expressions to perform between attributes are supported. If you only have one attribute, this field should be `{ObjectName.AttributeName}`, otherwise if you have a math expression in mind this field should contain both attributes.
- **Statistic:** This is the operation performed when you call one of the calculate APIs that actually performs the aggregation operation. Most are self-explanatory, but we have added explanations for ones that aren't.

Supported statistics

- `FIRST_OCCURRENCE` returns the attribute specified in the expression of the earliest ingested object.

- **LAST_OCCURRENCE** returns the attribute specified in the expression of the latest ingested object.
- **COUNT** returns the count from the selected data.
- **SUM** returns the sum from the selected data.
- **MINIMUM** returns minimum from the selected data.
- **MAXIMUM** returns maximum from the selected data.
- **AVERAGE** returns average from the selected data.
- **MAX_OCCURRENCE** returns the most frequently occurring value specified in the expression.
- **Range:** Currently support DAYS and calculated attributes can be based on up to 366 days of data.
- **ObjectCount:** Indicates how many objects the calculated attribute calculation should be based on. Values of 1-100 are supported.
- **Threshold:** If instead of the exact calculated attribute value you instead want to know if it's, for example, greater than a certain value, you can use a threshold.

The threshold value can be any string, and the following threshold operators are supported.

- **GREATER_THAN**
- **LESS_THAN**
- **EQUAL_TO**
- **NOT_EQUAL_TO**

Step 2: Call the CreateCalculatedAttributeDefinition API

After you have created and customized the JSON file with your values, call the [CreateCalculatedAttributeDefinition](#) API, as shown in the following example:

```
aws customer-profiles create-calculated-attribute-definition --cli-input-json
file:///custom_calculated_attribute_cli.json --region region_name
```

You can also use the following endpoint:

```
https://profile.your-region.amazonaws.com/domains/your-domain-name/calculated-
attributes
```

Validating calculated attribute values using the API

There are two APIs, `GetCalculatedAttributeForProfile` and `ListCalculatedAttributesForProfile`, that are at the profile level.

- **`GetCalculatedAttributeForProfile`** - retrieves a single calculated attribute for a single profile.
- **`ListCalculatedAttributesForProfile`** - retrieves a list of calculated attributes for a single profile

With a valid profile ID, you should see values for your calculated attributes:

Example response

```
{
  "CalculatedAttributeName": "_average_hold_time",
  "DisplayName": "Average hold time",
  "IsDataPartial": "true",
  "Value": "24144"
}
```

IsDataPartial - This flag means that either the time range (30 days) or object count have not been achieved and therefore the calculated attribute is still being calculated. For example, if you want an average over 30 days, only after 30 days have elapsed will the `IsDataPartial` field be set to false.

Retrieve a list of calculated attributes

Use the AWS CLI

```
aws customer-profiles list-calculated-attributes-for-profile --region your-region --
domain-name your-domain-name --profile-id your-profile-id
```

Use the AWS CLI with a custom JSON file

Create a JSON file with the following contents:

```
{
  "DomainName": "your-domain-name",
```

```
"ProfileId" "some-profile-id"
}
```

```
aws customer-profiles list-calculated-attributes-for-profile --region your-region --cli-input-json file://list_calculated_attributes_for_profile_cli.json
```

Endpoint:

```
https://profile.your-region.amazonaws.com/domains/your-domain-name/profile/your-profile-id/calculated-attributes/
```

Retrieve a single calculated attribute

Use the AWS CLI:

```
aws customer-profiles get-calculated-attributes-for-profile --region your-region --domain-name your-domain-name --calculated-attribute-name your-calculated-attribute-name --profile-id your-profile-id
```

Use the AWS CLI with a custom JSON file:

Create a JSON file with the following contents:

```
{
  "DomainName": "your-domain-name",
  "CalculatedAttributeName": "your-calculated-attribute-name",
  "ProfileId" "your-profile-id"
}
```

```
aws customer-profiles get-calculated-attributes-for-profile --region your-region --cli-input-json file://list_calculated_attributes_for_profile_cli.json
```

Endpoint:

```
https://profile.your-region.amazonaws.com/domains/your-domain-name/profile/your-profile-id/calculated-attributes/your-calculated-attribute-name
```

Default Calculated Attributes

Amazon Connect Customer Profiles provides seven out-of-the box default attributes based on contact records. The attributes are as follows:

New customer

```
{
  "CalculatedAttributeName": "_new_customer",
  "DisplayName": "New customer",
  "Description": "Returns true or false for new customer profiles created.",
  "CreatedAt": null,
  "LastUpdatedAt": null,
  "Statistic": "TIME_DIFFERENCE_FROM_NOW",
  "Conditions": {
    "ObjectCount": null,
    "Threshold": {
      "Value": "30",
      "Operator": "LESS_THAN"
    }
  },
  "AttributeDetails": {
    "Attributes": [
      {
        "Name": "createdAt"
      }
    ],
    "Expression": "{_profile.createdAt}"
  },
  "Tags": {
  }
}
```

Most frequent channel

```
{
  "CalculatedAttributeName": "_most_frequent_channel",
  "DisplayName": "Most frequent channel",
  "Description": "Returns customer's frequently used communication channel. Channels include voice, chat, task.",
}
```

```

"CreatedAt": null,
"LastUpdatedAt": null,
"Statistic": "MAX_OCCURRENCE",
"Conditions": {
  "Range": {
    "Value": 30,
    "Unit": "DAYS"
  },
  "ObjectCount": null
},
"AttributeDetails": {
  "Attributes": [
    {
      "Name": "channel"
    }
  ],
  "Expression": "{CTR.channel}"
},
"Tags": {
}
}

```

Last channel

```

{
  "CalculatedAttributeName": "_last_channel",
  "DisplayName": "Last channel",
  "Description": "Returns customer's last communication channel. Channels include voice, chat, task.",
  "CreatedAt": null,
  "LastUpdatedAt": null,
  "Statistic": "LAST_OCCURRENCE",
  "Conditions": {
    "ObjectCount": null
  },
  "AttributeDetails": {
    "Attributes": [
      {
        "Name": "channel"
      }
    ]
  },
}

```

```

    "Expression": "{CTR.channel}"
  },
  "Tags": {
  }
}

```

Last agent identifier

```

{
  "CalculatedAttributeName": "_last_agent_id",
  "DisplayName": "Last agent identifier",
  "Description": "Returns identifier of the last agent customer connected with.",
  "CreatedAt": null,
  "LastUpdatedAt": null,
  "Statistic": "LAST_OCCURRENCE",
  "Conditions": {
    "ObjectCount": null
  },
  "AttributeDetails": {
    "Attributes": [
      {
        "Name": "agent.id"
      }
    ],
    "Expression": "{CTR.agent.id}"
  },
  "Tags": {
  }
}

```

Frequent caller

```

{
  "CalculatedAttributeName": "_frequent_caller",
  "DisplayName": "Frequent caller",
  "Description": "Returns true or false based on the number of times a customer has called.",
  "CreatedAt": null,
  "LastUpdatedAt": null,

```

```

"Statistic": "COUNT",
"Conditions": {
  "Range": {
    "Value": 30,
    "Unit": "DAYS"
  },
  "ObjectCount": null,
  "Threshold": {
    "Value": "5",
    "Operator": "GREATER_THAN"
  }
},
"AttributeDetails": {
  "Attributes": [
    {
      "Name": "contactId"
    }
  ],
  "Expression": "{CTR.contactId}"
},
"Tags": {
}
}

```

Average hold duration

```

{
  "CalculatedAttributeName": "_average_hold_time",
  "DisplayName": "Average hold time",
  "Description": "Returns customer's average hold time for voice calls.",
  "CreatedAt": null,
  "LastUpdatedAt": null,
  "Statistic": "AVERAGE",
  "Conditions": {
    "Range": {
      "Value": 30,
      "Unit": "DAYS"
    },
    "ObjectCount": null
  },
  "AttributeDetails": {

```

```

    "Attributes": [
      {
        "Name": "agent.customerHoldDurationMillis"
      },
      {
        "Name": "queue.durationMillis"
      }
    ],
    "Expression": "{CTR.agent.customerHoldDurationMillis} +
{CTR.queue.durationMillis}"
  },
  "Tags": {
  }
}

```

Average call duration

```

{
  "CalculatedAttributeName": "_average_call_duration",
  "DisplayName": "Average call duration",
  "Description": "Returns customer's average call duration for voice calls.",
  "CreatedAt": null,
  "LastUpdatedAt": null,
  "Statistic": "AVERAGE",
  "Conditions": {
    "Range": {
      "Value": 30,
      "Unit": "DAYS"
    },
    "ObjectCount": null
  },
  "AttributeDetails": {
    "Attributes": [
      {
        "Name": "disconnectTimestamp"
      },
      {
        "Name": "initiationTimestamp"
      }
    ],
    "Expression": "{CTR.disconnectTimestamp} - {CTR.initiationTimestamp}"
  }
}

```

```

    },
    "Tags": {
    }
  }
}

```

Error state and troubleshooting

The following table shows calculated attributes error messages, cause, and resolution for each error.

Error message	Cause	Resolution
Retrieval of a calculated attribute for a profile shows a null value	This is likely due to the calculated attribute not having data. After creation of a calculated attribute, new data must be ingested.	Ingest new data or re-ingest old data via integrations or the <code>CreateProfile</code> and <code>PutProfileObject</code> APIs.

Amazon Connect admin website

Contents

- [How to create Calculated Attributes](#)
- [How to view Calculated Attributes](#)
- [How to edit Calculated Attributes](#)
- [How to delete Calculated Attributes](#)

How to create Calculated Attributes

1. To create calculated attributes, ensure that you have created security profiles permissions as a prerequisite. For more information, see [How update permissions for Calculated Attributes](#).
2. Choose **Create attribute** in the **Calculated attributes** table view.

Calculated attributes

Customer data transformed into actionable data points. Use calculated attributes with flows to personalize customer experiences. To help you get started, we provided default calculated attributes. [Learn More](#)

Attributes (16) Edit Delete Create attribute

Attributes are calculated for individual profiles, when at least one event occurs within the specified time period.

Search by name, description

Name	Type	Description	Time period	Creation date
_average_call_duration	Default	Returns customer's average call duration for voice calls.	30 days	5/31/2023
_average_hold_time	Default	Returns customer's average hold time for voice calls.	30 days	5/31/2023
_frequent_caller	Default	Returns true or false based on the number of times a customer has called.	30 days	5/31/2023
_last_agent_id	Default	Returns identifier of the last agent customer connected with.	-	5/31/2023
_last_channel	Default	Returns customer's last communication channel. Channels include voice,...	-	5/31/2023
_most_frequent_channel	Default	Returns customer's frequently used communication channel. Channels i...	30 days	5/31/2023
_new_customer	Default	Returns true or false for new customer profiles created.	-	5/31/2023
attribute1name	Custom	-	1 day	10/25/2023
bjkbbkbn	Custom	-	7 days	10/10/2023
calculateneu	Custom	CalcuLAteneu	1 day	10/25/2023

3. To create a calculated attribute, assign a name, add the description (optional), and choose the required fields:

- **Calculation:** defines how attributes are computed (average/count/sum/minimum/first occurrence/last occurrence/max occurrence)
- **Attribute:** which is a data point from your customer profiles data

Customer Profiles: Calculated attributes > Create attribute

Create attribute

Transform customer data into actionable data points by creating a calculated attribute. The output is calculated from events ingested after the attribute is created.

Description

Name
Enter a name for the calculated attribute. This name will be used, for example in Flows.

Valid characters are a-z, A-Z, 0-9, - (hyphen), and _ (underscore). Character count: 4/64.

Description - optional

Character count: 4/1000

Definition
Specify the type of calculation to perform and the attributes to input to create the definition. The definition can not be changed after creation.

Calculation | Info
 X

Attribute | Info
 X +

Event settings | Info
Define the time period and number of events used for the calculation. An output will be returned when there is at least one event occurring within the time period.

Time period
The most recent events occurring within this time period are used.

 days
 Min: 1, Max: 366

Number of events
Up to this number of events are used.

4. Additionally, you can add another attribute by selecting the *plus* icon. You can choose up to two attributes to calculate. When multiple attributes are chosen, they must be combined by an operator. Specify an operator such as *plus* or *minus* to combine the attribute values.

Definition
Specify the type of calculation to perform and the attributes to input to create the definition. The definition can not be changed after creation.

Calculation | Info
 X

Attribute | Info X **Plus** X +

Event settings | Info
Define the time period and number of events used for the calculation. An output will be returned when there is at least one event occurring within the time period.

Time period

- Once the calculation is selected, you can select the time period (up to 366 days) and the number of events (up to 100) under the **Event settings**. An output will be returned when there is at least one event during the specified time period.

[Customer Profiles: Calculated attributes](#) > Create attribute

Create attribute

Transform customer data into actionable data points by creating a calculated attribute. The output is calculated from events ingested after the attribute is created.

Description

Name
Enter a name for the calculated attribute. This name will be used, for example in Flows.

Valid characters are a-z, A-Z, 0-9, - (hyphen), and _ (underscore). Character count: 4/64.

Description - optional

Character count: 4/1000

Definition

Specify the type of calculation to perform and the attributes to input to create the definition. The definition can not be changed after creation.

Calculation | Info
 X

Attribute | Info
 X

Event settings

 | Info

Define the time period and number of events used for the calculation. An output will be returned when there is at least one event occurring within the time period.

Time period
The most recent events occurring within this time period are used.

 days
 Min: 1, Max: 366

Number of events
Up to this number of events are used.

- Choose **Create** to create the calculated attribute.
- Once a calculated attribute has been created successfully, a banner is displayed on the table view with a link to add a flow for a calculated attribute.

✔ Successfully created attribute: **sample_test**
 You can now use the attribute to [add to flow](#) [View attribute](#)
✕

Calculated attributes

Customer data transformed into actionable data points. Use calculated attributes with flows to personalize customer experiences. To help you get started, we provided default calculated attributes. [Learn More](#)

Attributes (18) Edit Delete **Create attribute**

Attributes are calculated for individual profiles, when at least one event occurs within the specified time period.

Search by name, description

Name	Type	Description	Time period	Creation date
_average_call_duration	Default	Returns customer's average call duration for voice calls.	30 days	5/31/2023
_average_hold_time	Default	Returns customer's average hold time for voice calls.	30 days	5/31/2023
_frequent_caller	Default	Returns true or false based on the number of times a customer has called.	30 days	5/31/2023
_last_agent_id	Default	Returns identifier of the last agent customer connected with.	-	5/31/2023
_last_channel	Default	Returns customer's last communication channel. Channels include voice,...	-	5/31/2023
_most_frequent_channel	Default	Returns customer's frequently used communication channel. Channels i...	30 days	5/31/2023
_new_customer	Default	Returns true or false for new customer profiles created.	-	5/31/2023
attribute1name	Custom	-	1 day	10/25/2023
average_customer_service_time	Custom	-	2 days	11/15/2023
bjkbbn	Custom	-	7 days	10/10/2023

How to view Calculated Attributes

1. Login to Amazon Connect admin website with your credentials. Once logged in choose Calculated Attributes from the Customer Profiles menu in the left navigation panel.

The screenshot shows the Amazon Connect admin console interface. The top navigation bar includes 'Agent Workspace' and 'Contact Control Panel'. The main content area displays the 'Calculated attributes' page, which includes a table of attributes and a search bar. The left navigation panel is open, showing 'Customer Profiles' and 'Calculated Attributes' highlighted. A red arrow points to the 'Calculated Attributes' menu item.

2. Choose an item on the **Name** field in the table view to view details of the attribute.

Calculated attributes

Customer data transformed into actionable data points. Use calculated attributes with flows to personalize customer experiences. To help you get started, we provided default calculated attributes. [Learn More](#)

Attributes (18) Edit Delete Create attribute

Attributes are calculated for individual profiles, when at least one event occurs within the specified time period.

Search by name, description

Name	Type	Description	Time period	Creation date
<input type="radio"/> _average_call_duration	Default	Returns customer's average call duration for voice calls.	30 days	5/31/2023
<input type="radio"/> _average_hold_time	Default	Returns customer's average hold time for voice calls.	30 days	5/31/2023
<input type="radio"/> _frequent_caller	Default	Returns true or false based on the number of times a customer has called.	30 days	5/31/2023
<input checked="" type="radio"/> _last_agent_id	Default	Returns identifier of the last agent customer connected with.	-	5/31/2023
<input type="radio"/> _last_channel	Default	Returns customer's last communication channel. Channels include voice,...	-	5/31/2023
<input type="radio"/> _most_frequent_channel	Default	Returns customer's frequently used communication channel. Channels I...	30 days	5/31/2023
<input type="radio"/> _new_customer	Default	Returns true or false for new customer profiles created.	-	5/31/2023
<input type="radio"/> attribute1name	Custom	-	1 day	10/25/2023
<input type="radio"/> average_customer_service_time	Custom	-	2 days	11/15/2023
<input type="radio"/> 	Custom	-	7 days	10/10/2023

3. You will now be able to view the details of the attribute that you had selected.

Customer Profiles: Calculated attributes > Last agent identifier Edit Delete Next actions

Last agent identifier

The output of this attribute is calculated for individual profiles from events occurring after the attribute is created.

Details

Name
_last_agent_id

Description
Returns identifier of the last agent customer connected with.

Definition [Info](#)
LAST_OCCURRENCE (CTR.agent.id)

► **Definition details**

Creation date
May 31, 2023

Event settings [Info](#)
The output is based on the time period and number of events set. An output will be returned when there is at least one event occurring within the time period.

Time period
-

Number of events
1

How to edit Calculated Attributes

- To edit a calculated attribute, choose an attribute in the table view by selecting the radio button, which enables the **Edit** button. Choose **Edit**.

Calculated attributes

Customer data transformed into actionable data points. Use calculated attributes with flows to personalize customer experiences. To help you get started, we provided default calculated attributes. [Learn More](#)

Attributes (19)

Attributes are calculated for individual profiles, when at least one event occurs within the specified time period.

Search by name, description

Edit Delete Create attribute

< 1 2 > ⌂

Name	Type	Description	Time period	Creation date
_average_call_duration	Default	Returns customer's average call duration for voice calls.	30 days	5/31/2023
_average_hold_time	Default	Returns customer's average hold time for voice calls.	30 days	5/31/2023
_frequent_caller	Default	Returns true or false based on the number of times a customer has called.	30 days	5/31/2023
_last_agent_id	Default	Returns identifier of the last agent customer connected with.	-	5/31/2023
_last_channel	Default	Returns customer's last communication channel. Channels include voice,...	-	5/31/2023
_most_frequent_channel	Default	Returns customer's frequently used communication channel. Channels i...	30 days	5/31/2023
_new_customer	Default	Returns true or false for new customer profiles created.	-	5/31/2023
attribute1name	Custom	-	1 day	10/25/2023
average_customer_service_time	Custom	-	2 days	11/15/2023
Average-Order-Price-Per-Week	Custom	Average Order price per week for a customer	7 days	11/15/2023

- You will be able to edit the **Description**, **Time period**, and **Number of events**. Once edited choose **Save**.

Customer Profiles: Calculated attributes > Average-Order-Price-Per-Week

Edit Average-Order-Price-Per-Week

Details

Name
Average-Order-Price-Per-Week

Description - optional
Average Order price per week for a customer

Character count: 43/1000

Definition [Info](#)
AVERAGE (_order.totalItemsPrice)

▶ **Definition details**

Event settings [Info](#)

The output is based on the time period and number of events set.

Time period
7 days
Min: 1, Max: 366

Number of events
100
Min: 1, Max: 100

Cancel Save

How to delete Calculated Attributes

1. To delete a calculated attribute, choose an attribute in the table by selecting the radio button next to the attribute that you would like to delete.
2. Once selected, choose **Delete**.
3. In the **Delete Attribute** pop-up, verify the details and enter *confirm* to enable the **Delete** button.

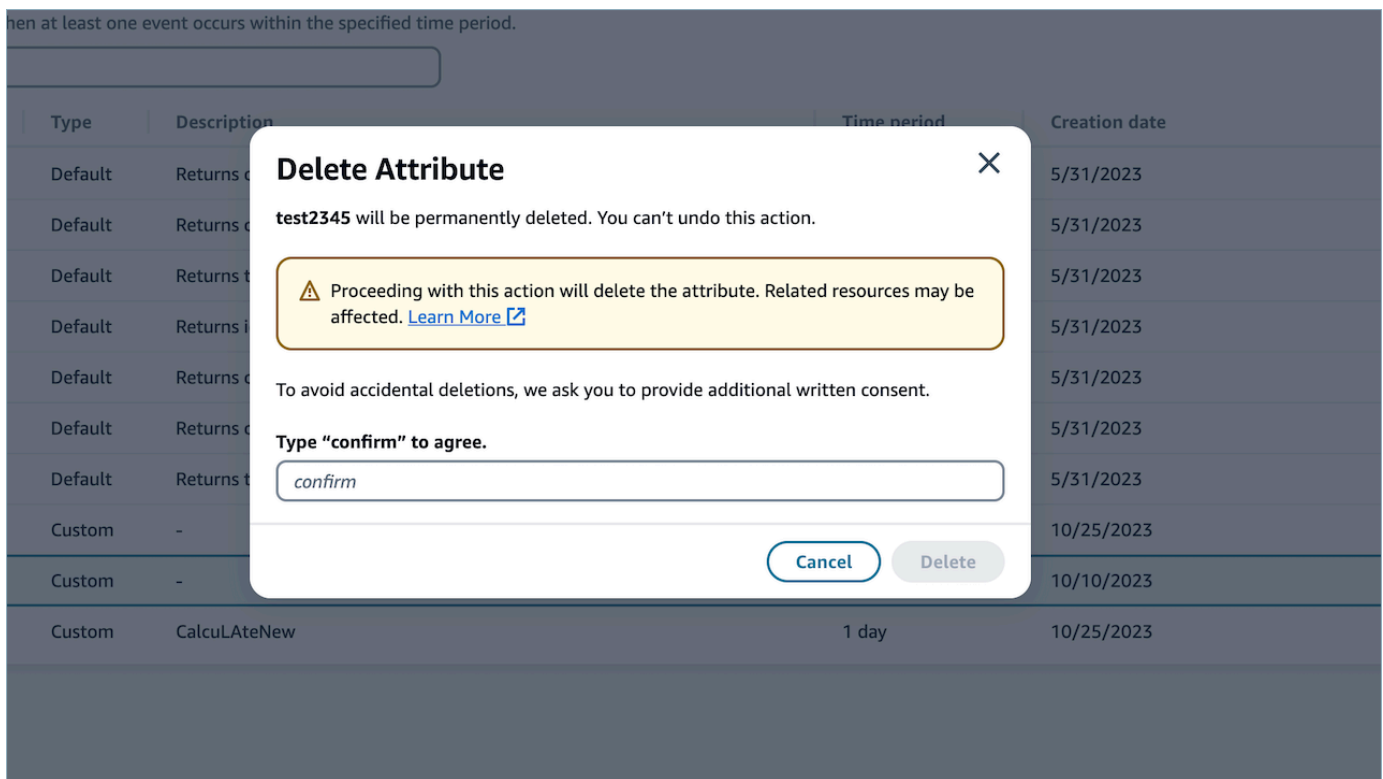

4. Choose **Delete**.

Use the Customer Profiles API

For information about how to programmatically manage domains and profiles, see the [Amazon Connect Customer Profiles API Reference](#).

We recommend using the CustomerProfileJS open source library when integrating Customer Profiles into your own agent application. For more information, see the CustomerProfilesJS repo on [Github](#).

For more information about how to integrate your existing apps with Amazon Connect use [Amazon Connect Streams](#). You can embed the Contact Control Panel (CCP) components into your app.

Example: Programmatically integrate S3 with Customer Profiles

Using the Customer Profiles [PutIntegration](#) API, you can programmatically create integrations for S3, Salesforce, Marketo, and more.

In this topic we show how to create an S3 integration with a sync interval of 15 minutes, the minimum value currently supported.

Step 1: Create a JSON file

Create a JSON file with the following contents:

```
{
  "DomainName": "your-domain",
  "ObjectName": "your-object-name",
  "FlowDefinition": {
    "FlowName": "your-flow-name",
    "KmsArn": "the key ARN is the same as your domain's key",
    "Description": "Created by Customer Profiles",
    "TriggerConfig": {
      "TriggerType": "Scheduled",
      "TriggerProperties": {
        "Scheduled": {
          "ScheduleExpression": "rate(15minutes)",
          "DataPullMode": "Incremental",
          "ScheduleStartTime": 1634244800.435,
          "FirstExecutionFrom": 1594166400
        }
      }
    },
    "SourceFlowConfig": {
      "ConnectorType": "S3",
      "SourceConnectorProperties": {
        "S3": {
          "BucketName": "your-bucket",
          "BucketPrefix": "your-prefix"
        }
      }
    },
    "Tasks": [
      {"TaskType": "Filter", "SourceFields": ["colA", "colB"], "ConnectorOperator":
{"S3": "PROJECTION"}}],

```

```

        {"ConnectorOperator":
{"S3":"NO_OP"}, "DestinationField":"colA", "TaskProperties": {}, "SourceFields":
["colA"], "TaskType":"Map"},
        {"ConnectorOperator":
{"S3":"NO_OP"}, "DestinationField":"colB", "TaskProperties": {}, "SourceFields":
["colB"], "TaskType":"Map"}
    ]
}
}

```

To customize the JSON with your own values, follow these guidelines:

- **FlowName:** Can be STRING [a-zA-Z0-9][\w!@#.-]+
- **ScheduleStartTime:** Set to the current DateTime + 5 minutes in epoch time.
- **FirstExecutionFrom:** Go to S3, look at the file date, and use a date that is before the oldest date.
- **Tasks:** Define TaskType. In the Sourcefields field you have to supply ALL the columns you have in your CSV in that array. Then, for each of the items in that array, you need to specify the ConnectorOperator. This example is for a CSV document with two columns: colA and colB.

Step 2: Call the PutIntegration API

After you have created and customized the JSON file with your values, call the [PutIntegration](#) API, as shown in the following example:

```

aws customer-profiles put-integration --cli-input-json
file:///put_integration_s3_cli.json --region us-west-2

```

The response from PutIntegration returns a flow URI. For example:

```

{
  "DomainName": "testDomain",
  "Uri": "arn:aws:appflow:us-west-2:999999999999:flow/
Customer_Profiles_testDomain_S3_Salesforce-Account_1634244122247",
  "ObjectTypeName": "your objec type",
  "CreatedAt": "2021-10-14T13:51:57.748000-07:00",
  "LastUpdatedAt": "2021-10-14T13:51:57.748000-07:00",
  "Tags": {}
}

```

```
}
```

Step 3: Call the Amazon AppFlow StartFlow API

Use the flow URI to call the Amazon AppFlow [StartFlow](#) API. For example:

```
aws appflow start-flow --flow-name uri --region us-west-2
```

Forecasting, capacity planning, and scheduling

To run a contact center, you need the right number of agents working at the right times to achieve your operational goals. It's critical to not overspend or overrun your workforce.

Amazon Connect provides a set of services powered by machine learning that help you optimize your contact center by offering the following:

- [Forecasting](#). Analyze and predict contact volume based on historical data. What will future demand—the contact volume and handle time—look like? Amazon Connect forecasting provides accurate and auto-generated forecasts that are automatically updated daily.
- [Scheduling](#). Generate agent schedules for day-to-day workloads that are flexible, and meet business and compliance requirements. Offer agents flexible schedules and work-life balance. How many agents are needed in each shift? Which agent works in which slot?
 - [Schedule Adherence](#). Enable contact center supervisors to monitor schedule adherence and improve agent productivity. Schedule adherence metrics are available after the agent schedules are published.
- [Capacity planning](#). Predict how many agents your contact center will require. Optimize plans by scenarios, service level goals, and metrics, such as shrinkage.

For information about where Amazon Connect forecasting, capacity planning, and scheduling is available, see [Availability of Amazon Connect features by Region](#).

The following diagram shows a typical end-to-end optimization workflow by persona: Amazon Connect administrator, forecaster, scheduler, capacity planner, and agent. It lists the tasks performed by each persona.

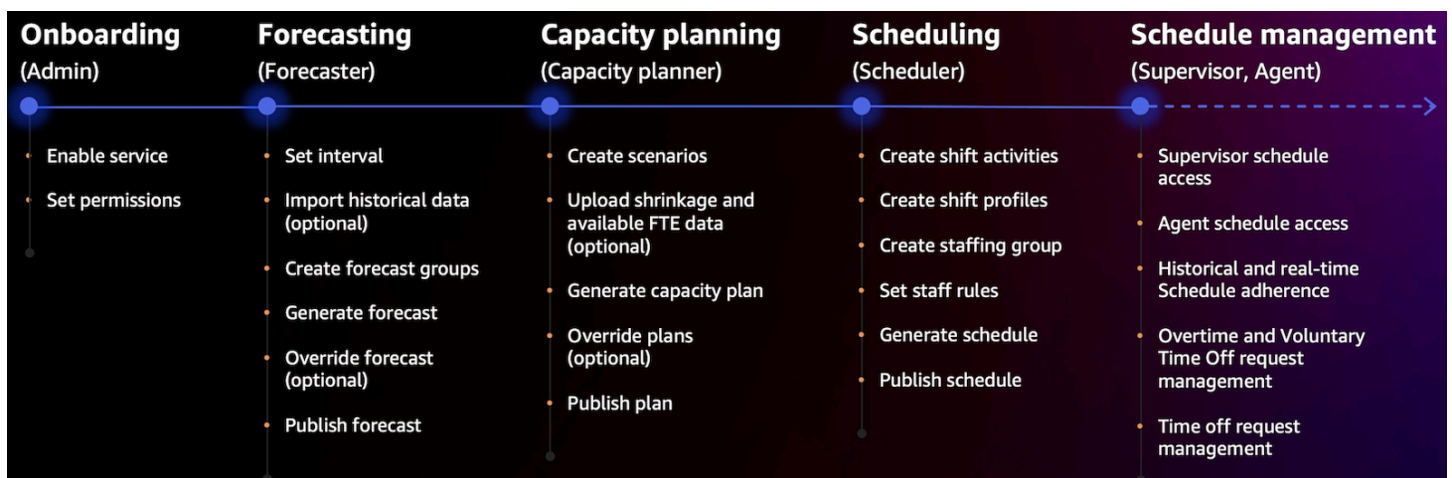

Get started with forecasting, capacity planning, and scheduling

Use these steps to set up forecasting, capacity planning, and scheduling.

1. [Enable forecasting, capacity planning, and scheduling](#) in the Amazon Connect console.

Note

After enabling Forecasting, capacity planning, and scheduling, it may take up to **24 hours** before the feature is available for use.

2. [Assign security profile permissions](#) to the Amazon Connect users who will use this feature.

Use the following steps to start using forecasting, capacity planning, and scheduling.

1. [Set the forecast and scheduling interval](#)
2. [Create forecast groups](#)
3. [Create forecasts](#)
4. [Create capacity planning scenarios](#)
5. [Create staff rules](#)

Enable forecasting, capacity planning, and scheduling

You must enable forecasting, capacity planning, and scheduling at the Amazon Connect instance level. After you enable forecasting, capacity planning, and scheduling, it may take up to 24 hours for the feature to be available for use in your AWS account.

1. Log in to the [AWS Management Console](#) using your AWS account.
2. In the AWS Management Console, at the top of the page in the search bar, type *Amazon Connect* and then choose **Amazon Connect**. This is shown in the following image.

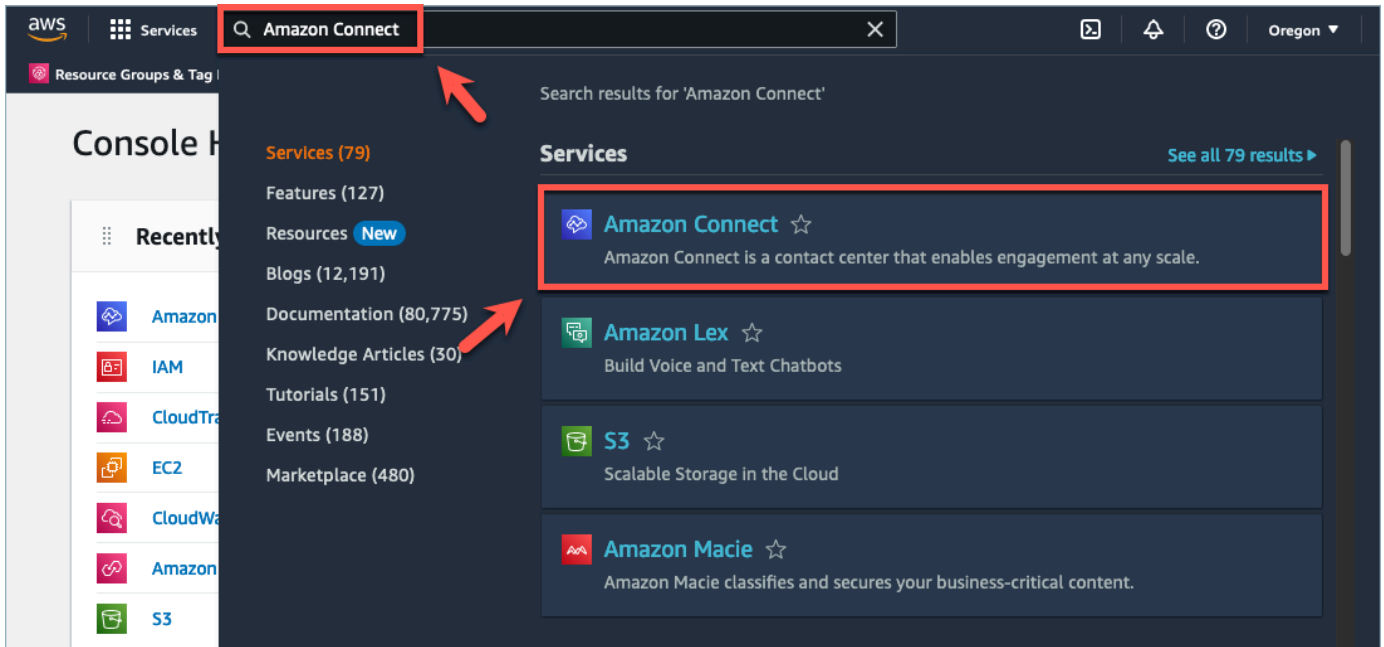

3. On the **Amazon Connect virtual contact center instances** page, choose the **Instance alias** where you want to enable forecasting, capacity planning, and scheduling.

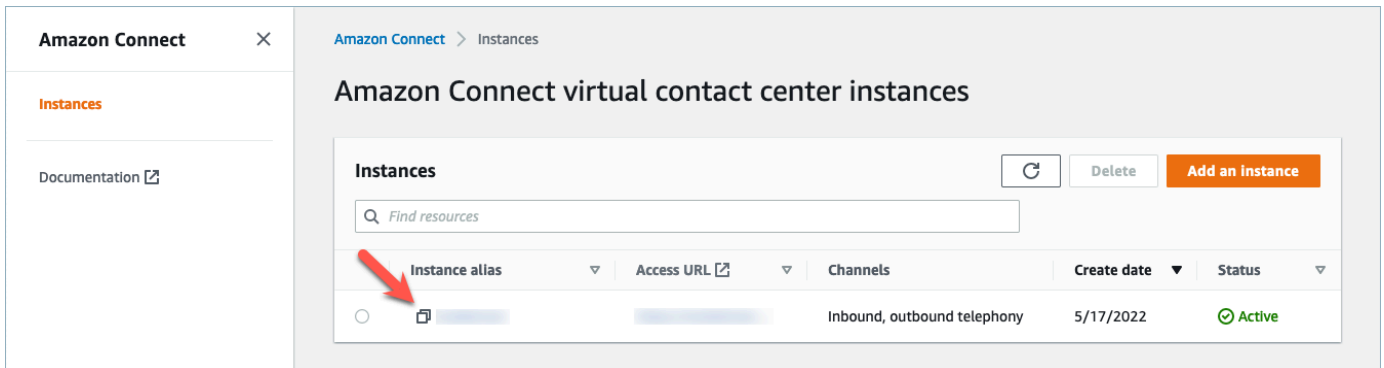

4. In the navigation pane, choose **Forecasting, capacity planning, and scheduling**.

Amazon Connect > > Forecasting, capacity planning, and scheduling

Forecasting, capacity planning, and scheduling

Amazon Connect offers the ability to forecast contact demands, plan and schedule agents to meet contact center operation goals. [Learn more](#)

How it works

- Step 1: Enable capabilities**
One-click for onboarding
- Step 2: Go to Amazon Connect Analytics**
Start forecasting, capacity planning, and scheduling capabilities
- Step 3: Review results**
Understand the outputs from each capability

Enable capabilities

Enable forecasting, capacity planning, and scheduling
Your data is encrypted by default with a key that AWS owns and manages for you.

Status ⓘ
⊖ Not enabled

5. On the **Forecasting, capacity planning, and scheduling** page, select the check box to enable forecasting, capacity planning, and scheduling.

Amazon Connect > > Forecasting, capacity planning, and scheduling

Forecasting, capacity planning, and scheduling

Amazon Connect offers the ability to forecast contact demands, plan and schedule agents to meet contact center operation goals. [Learn more](#)

How it works

- Step 1: Enable capabilities**
One-click for onboarding
- Step 2: Go to Amazon Connect Analytics**
Start forecasting, capacity planning, and scheduling capabilities
- Step 3: Review results**
Understand the outputs from each capability

Enable capabilities

Enable forecasting, capacity planning, and scheduling
Your data is encrypted by default with a key that AWS owns and manages for you.

Status ⓘ
⊖ Not enabled

6. The status changes to *In progress*, as shown in the following image.

Amazon Connect > Forecasting, capacity planning, and scheduling

Forecasting, capacity planning, and scheduling

Amazon Connect offers the ability to forecast contact demands, plan and schedule agents to meet contact center operation goals. [Learn more](#)

How it works



Step 1: Enable capabilities
One-click for onboarding



Step 2: Go to Amazon Connect Analytics
Start forecasting, capacity planning, and scheduling capabilities



Step 3: Review results
Understand the outputs from each capability

Enable capabilities

Enable forecasting, capacity planning, and scheduling
Your data is encrypted by default with a key that AWS owns and manages for you.

Status ⓘ
🔄 In-progress ↻

7. Within 24 hours the status will change to *Enabled* and forecasting, capacity planning, and scheduling will be ready to use.

Enable capabilities

Enable forecasting, capacity planning, and scheduling
Your data is encrypted by default with a key that AWS owns and manages for you.

Status ⓘ
✅ Enabled

Security profile permissions for forecasting, capacity planning, and scheduling

Assign the following security profile permissions as needed to use forecasting, capacity planning, and scheduling:

- **Approve:** Users with the Approve permission will be able to view, create, edit, and approve time off requests.
- **Capacity planning:** This permission allows you to view and edit in capacity planning pages, including scenario and capacity plans. It also allows users to import future estimated shrinkage and available FTEs.
- **Forecasting:** This permission allows you to view and edit in forecasting pages. For example, you can create, view, publish, and delete forecast groups and forecasts, import historical data from external applications, and more.
- **Individual schedule calendar:** This permission allows agents to view their schedule in their agent application.
- **Schedule manager:** This permission allows you to view and edit generated schedules from the schedule manager. The view permission also enables you to view historical schedule adherence metrics. (Note: You still need the View Metrics Permission in addition to this permission)
- **Team schedule calendar:** After a schedule is published, this permission enables you to view or edit the published schedule. You can see the schedule calendar, but agents cannot. The view permission also enables you to view historical schedule adherence metrics.

 **Note**

You still need the View Metrics permission in addition to this permission.

- **View:** Users with the View permission will be able to view time off requests in the Time off Requests drawer. Users with the View permission will not be able to create or approve time off requests.

For information about how to add more permissions to an existing security profile, see [Update security profiles](#).

By default, the **Admin** security profile already has permissions to perform all forecasting, capacity planning, and scheduling activities.

Troubleshooting forecasting, capacity planning, and scheduling

These sections outline troubleshooting scenarios and address frequently asked questions for forecasting, capacity planning, and scheduling.

- [Forecasting](#)

- [Capacity planning](#)
- [Scheduling](#)

Forecasting

- **How can I create an ad hoc forecast?**

Forecasts are processed automatically, delivering short-term forecasts daily, and long-term forecasts weekly, so users don't need to worry about running forecasts manually. However, you may want to see how a forecast is updated when you add or modify historical data. For example, if you had an anomaly in your historical contact volume, and you don't want the machine-learning model to use that anomaly in building a forecast, you can modify the historical data and then when the new forecasts are run, the new forecasts will not incorporate that data.

To see the most recent forecasts, check the **Last computed** column.

New forecasts will be generated when a user uploads or deletes historical data using the **Import data** tab or adds/removes queues from a forecast group.

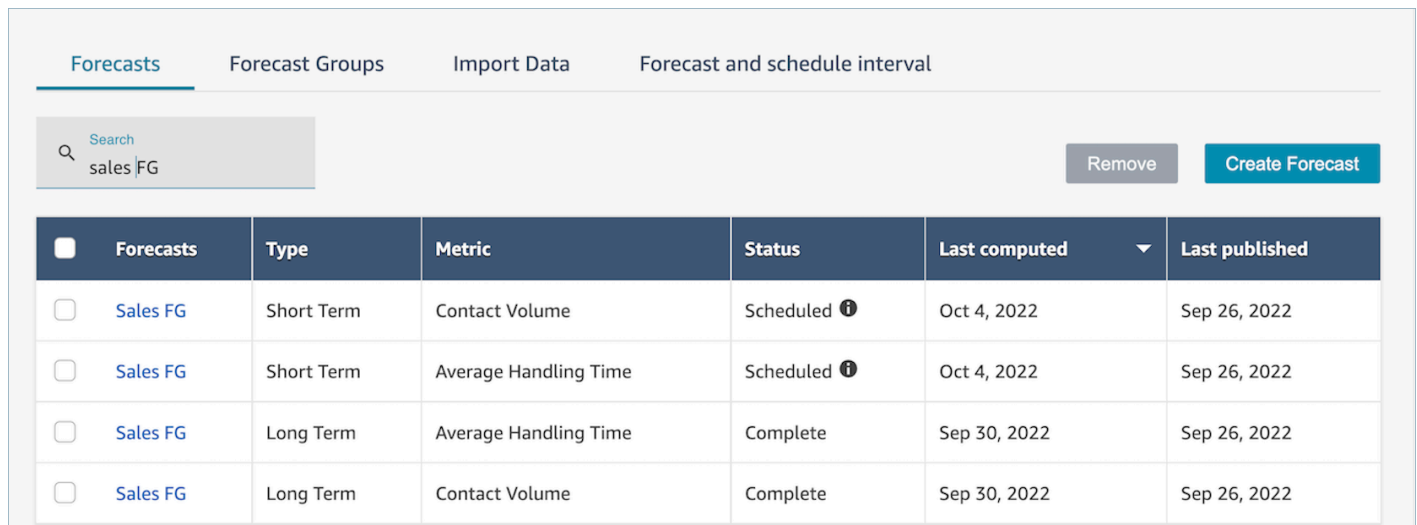

The screenshot shows the 'Forecasts' tab in the Amazon Connect interface. At the top, there are navigation tabs: 'Forecasts', 'Forecast Groups', 'Import Data', and 'Forecast and schedule interval'. Below the tabs is a search bar with the text 'Search sales FG' and a 'Remove' button. To the right of the search bar is a 'Create Forecast' button. The main content is a table with the following columns: 'Forecasts', 'Type', 'Metric', 'Status', 'Last computed', and 'Last published'. The table contains four rows of forecast data.

<input type="checkbox"/>	Forecasts	Type	Metric	Status	Last computed	Last published
<input type="checkbox"/>	Sales FG	Short Term	Contact Volume	Scheduled ⓘ	Oct 4, 2022	Sep 26, 2022
<input type="checkbox"/>	Sales FG	Short Term	Average Handling Time	Scheduled ⓘ	Oct 4, 2022	Sep 26, 2022
<input type="checkbox"/>	Sales FG	Long Term	Average Handling Time	Complete	Sep 30, 2022	Sep 26, 2022
<input type="checkbox"/>	Sales FG	Long Term	Contact Volume	Complete	Sep 30, 2022	Sep 26, 2022

- **When I import historical data it returns errors.**

Select **download details** to ensure that the imported data is in the correct format: If there are any errors, check the error details. It will provide additional details for the specific error. You must ensure that your file is in .csv format, contains no decimals, no extra rows, or column fields. For more information on the required format, see [Import historical data for forecasting](#).

<input type="checkbox"/> Uploaded CSV	Type	Interval	Date range	Status	Date uploaded
<input type="checkbox"/> test-forecast-import.csv	Historical data	-	-	In progress 	Mar 8, 2022
<input type="checkbox"/> generated-Brokerage-All-daily.csv	Historical data	-	-	 Failed, download details	Mar 7, 2022
<input type="checkbox"/> data-generator-red-widgets-daily.csv 	Historical data	Daily	Jan 1, 2021 - Feb 16, 2022	Complete	Feb 21, 2022

- **Forecast failed due to error: Insufficient data in Amazon Connect.**

When you receive this error, it could be due to three different reasons:

1. *You have less than 6 month of historical data.* To address this problem, upload more historical data. While Amazon Connect can generate forecasts with six months of data, we recommend at least 12 months of recent contact data to ensure that contact patterns (for example, seasonality) are properly captured. If you don't have 6 months of data, you can give Connect synthetic (artificial) data that will be used to generate the forecast. Alternately, you can upload your own forecast using the **Override** function.
 2. *You need at least 2,000 contacts per month across all of your forecast groups.* Amazon Connect generates forecasts using historical data for all queues that are included across all forecast groups. At least 2,000 monthly contacts in the past 6 months for the Amazon Connect instance are required to successfully generate a forecast. Amazon Connect does not require 2,000 monthly contacts for every queue. All queues in all forecast groups must total more than 2,000 monthly contacts.
 3. *You need recent data.* Amazon Connect performs a data recency check (is the data recent enough) based on the aggregation of all queues included across all forecast groups. At least one data point in the past four weeks is required to successfully generate a forecast.
- **Cannot import data, cannot download forecast, cannot create forecast group, or cannot create forecast.**

Most likely, you do not have the correct permissions. Check with your admin to ensure you have permissions for **Analytics, Forecasting - Edit**.

- **Forecasting override upload failed.**

Check the error message to make sure the .csv file format matches our data schema. For more information on the required format, see [Import historical data for forecasting](#).

 **Tip**

download the computed or published forecast .csv file. Take the time period for override, and copy the queue ID and queue name, time stamps to the override template.

Note, only the latest uploaded .csv file will be used, and the previous uploaded files will be overridden.

- **Long-term Forecast failed even after I have uploaded more than 6 months of data.**

The data uploads for long-term and short-term forecasts are independent, so you will need to upload these separately: one for long-term and one for short-term. First, check if you also uploaded the daily historical data for long-term forecast. The 15 to 30 minute interval data is for short-term forecasts only. Second, check if the long-term daily level .csv file has more than 6 consecutive months historical data counted from now.

- **Short-term forecast failed even after I uploaded more than 6 month of data.**

The data uploads for long-term and short-term forecasts are independent. The daily interval data is for long-term forecast only. First, check if you uploaded the 15 or 30 minute interval historical data for short-term forecast and the file has more than 6 consecutive month data. Second, check what is the forecast interval setting in .csv file to ensure it matches the historical intervals on the UI.

- **Why am I unable to publish a forecast?**

It's possible that you do not have permissions to publish a forecast. It's also possible that the forecasts (both contact volume and handle time for each of short-term and long-term) have not been successfully generated. Check if you have the permission for **Analytics, Forecasting - Publish** and check if the forecasts have been successfully generated (the status column should show **complete**" when the forecasts are generated).

- **How can I see data from a previous period?**

You are able to view forecasts in a specified period that occurred in the past.

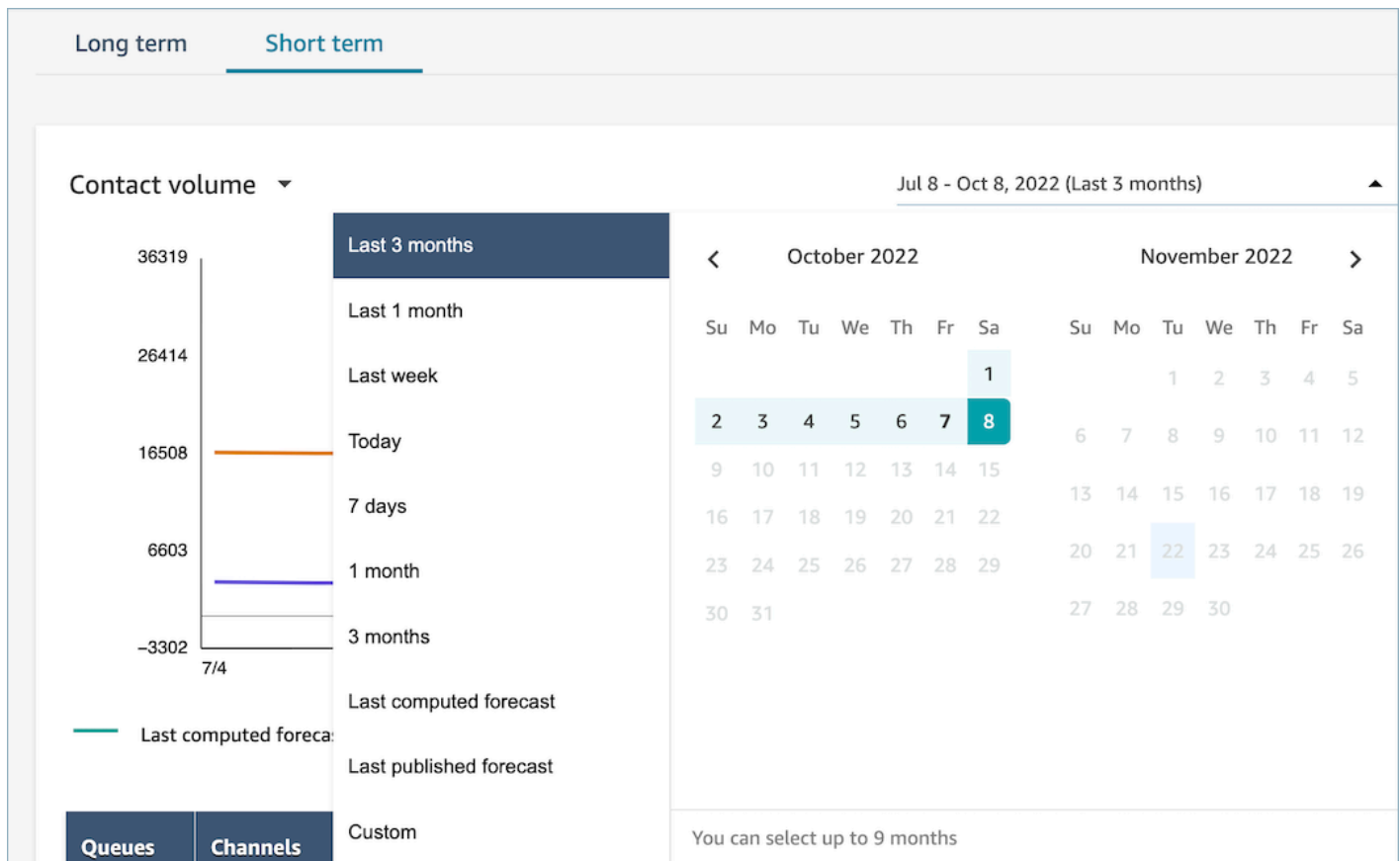

- **Can I see past forecast data?**

You can see the last published and the last computed forecast. The last computed forecast will be overwritten once the next forecast is computed. If you wish to retain this data, you can download the .csv file that contains the last computed and published forecasts.

- **Why are the forecasts used in capacity planning different than the ones I see in forecasting or scheduling?**

The forecast that is used in capacity planning is the most recent published long-term forecast. You may see a different forecast in forecasting if you are looking at the most recent computed forecast in comparison to a published forecast. You will see a different forecast in scheduling, as that is the most recently published short-term forecast.

- **Why do I see the call volume peak in short-term forecast at mid-night when no traffic is expected?**

Forecasting uses Coordinated Universal Time (UTC) as its time zone. For North American users on the Pacific or Atlantic Coasts, this is 8 hours ahead of PST, or 7 hours ahead of PDT; and 5 hours

ahead of EST, or 4 hours ahead of EDT. So for example, midnight in UTC is 4pm PST / 5pm PDT or 7pm EST / 8pm EDT.

⚠ Important

Use UTC time when uploading historical data or overrides.

- **Why am I unable to delete a forecast?**

Forecasts can only be deleted if they are not being used for a capacity plan (long-term forecast) or schedule (short-term forecast). Check if the forecast has been published and that it is used for scheduling or capacity planning. You must delete the schedule or capacity plans in order to delete the forecast.

- **Why do the long-term and short-term forecasts show different values for the same time period?**

These two forecasts have different training frequencies and different models, as they are optimized for different purposes. Short-term is designed for interval level granularity over a period of weeks and long-term is designed for daily granularity over a period of months.

- **Why is long-term average handle time flat but short-term average handle time isn't?**

A flat average handle time performs better when forecasting short-term forecast workloads as it displays interval granularity over a period of weeks. Allowing the average handle time to vary in a long-term forecast results in better performance as displays daily granularity over a period of months.

Handle time is important when calculating a workload. It generally doesn't vary much in the short term but can vary over longer time periods, which is reflected in our models.

- **Is call volume counted at the time when the call comes in, or when the call ends?**

Call volume starts counting at the time when call comes in. For example, a call started at 4:50 PM, and ends at 5:05 PM. It will be counted as the call volume for the 4:45 PM - 5:00 PM interval.

Capacity planning

- **How do I handle shrinkage in capacity planning?**

Users can increase capacity planning accuracy by providing estimated future data, which includes available full-time employees (FTE) and Shrinkage, for the existing forecast groups. Providing Available FTE and shrinkage data is optional. Amazon Connect can generate a capacity plan without it but providing it improves the accuracy of the capacity plan. In order to import that data, download the .csv template from the UI and fill out the empty cells. Note that users need to enter the exact name of the forecast groups they created. Also, users can add multiple forecast groups in this .csv file. For more information, see [Import estimated future shrinkage and available full-time employees](#).

- **I am seeing errors during data import in capacity planning.**

Confirm that the forecast group names in the .csv file match the actual forecast group names in forecasting module.

Scheduling

- **The system does not generate schedules for some or all of my agents. What should I check?**

This can occur due to the fact that the last date an agent can be scheduled is before the time of the schedule and/or the agent's maximum working hours don't allow them to work in that shift profile. Review the following steps to address this issue.

1. Check **Staff Rules** to ensure that the **End date** is not configured for agents who do not have a schedule. **End date** allows schedulers to specify the last date that an agent can be scheduled until.
2. Check shift profiles to see if the **Start time** and **End time** hourly schedule window is equal to or more than **Maximum working hours** per agent. For example, if the shift profile is configured to generate a schedule of an 8 hour duration, when the agent's staff rule is configured for them to work 4 hours per day, the system will apply the staff rule and only generate a schedule for 4 hours.

- **Why am I unable to access the scheduling page while on my company's VPN?**

It is possible that your company's VPN has security measure in place that could be preventing access to the needed endpoints. If you are unable to access the scheduling page while connected to your company's VPN, reach out to your admin or network security team to have them allowlist the following endpoints:

```
.awsapps.com/connect/markov/schedule-ui/api/graphql
```

```
.my.connect.aws/markov/schedule-ui/api/graphql
```

- **Why are lunch activities for some agents scheduled before the first break activity, even though I have specified a lunch activity to be placed after the break?**

This can be caused by having overlaps in the break and lunch activities. Check the specific shift profile to see if the placement window for both activities overlap. For example, you may have configured a break activity to be placed between 11am and 1pm and a lunch activity to be placed between 10am and 3pm, so the system may choose to place the break at 12:30pm and the lunch at 11:30am. Remove or minimize the overlap of activity placement windows to solve this issue.

- **Why do I see agents get scheduled at different start times than expected?**

This is commonly caused by challenges with time zones. Shift profiles are set using Coordinated Universal Time (UTC), and staff rules specify which time zone agents should use. Review the following steps to address this issue.

- Ensure the **shift profile** start time and end time are configured in the UTC time-zone.
- Ensure the correct user time-zones are set in the **Staff rules** UI. For example, if you want to schedule agents in Boston (EST time-zone) from 9am to 5pm, you must do the following.
 - Set **Shift profile** start time as 1:00PM and end time as 9PM. Usually shift profiles are set once and later re-used.
 - Updated the timezone for all agents to EST time zone in the **Staff rules** UI.
- **Can I view the schedule in my local time?**

Yes. Supervisors and schedulers can view schedules in their local time zone for agents they manage. Agents can view their individual schedules in their local time zone. User time zones can be set in the **Staff rules** UI.

- **Do I need to define activities for workloads like phone or chat?**

No. *Work* will be the default activity on the schedule if there is no break or lunch scheduled for the time slot. Only define the activities for the agent when they are not taking a call or responding to a chat.

- **Why did some agents did not get added to the roster for certain days?**

How agents are added to the roster depends on multiple configurations in staffing groups and staff rules, such as min/max working hours, min staff required, or min/max consecutive work days. The service will take the defined working hours and add an agent to the roster by taking into consideration other rules that have been defined in staffing groups and staff rules. For example, if the minimum working hours are 40 hours, and the agent belongs to a staff group that operates 12 hours per day and 6 days per week, then the agent is likely to have some days without schedules. The service optimizes schedules based on forecasts. As long as the minimum amount of 40 hours per week (4 days with 10 hours per day) is met, the agent may not be staffed on some days when the call volume is low. In cases where you see that an agent doesn't have a schedule for a day, check the agent's minimum working hours. Also, check if the agent has been added to the roster for the remainder of the week.

- **Why is my agent's scheduled time different than the shift profile time? For example, my shift profile has 10 hours every weekday, but my agent only gets scheduled for 6 hours?**

The shift profile operation hours apply to staffing groups. If you don't set the staffing groups rule for **shift start time**, the service will optimize your agent start time based on the forecasted workload. For example, the shift profile has 8 AM - 6 PM Monday - Friday, and the workload is light in the morning, and heavier in the afternoon. Each agent has a minimum of 6 hours and a maximum of 8 hours per day. To save agent cost, the service will schedule less agents in the morning and more agents in the afternoon. Some agents could start at 8 AM, some could start at 8:30 AM, and some could start in the afternoon. Some agents could have 6 hour schedules and some could have 8 hour schedules. In this way, you can maximize your agent resources to meet the service goal. If you want every agent to start at the same time and work an exact number of hours, you can set the rule in the staffing group **shift start time** to **start at the same time** and set the **working hour** to 10 hours every day. In this case, savings on agent cost will be less due to less flexibility to optimize based on forecasts.

Rules:

Working Time ▼	Min. hours	minutes	Max. hours	minutes	Per period	
	40	0	50	0	Week	▼
<small>Working hours should also include total time spent on non productive activities like breaks.</small>						
Minimum Staff Required ▼	Count					
	1					
Shift Start Time ▼	Strategy					
	Same Start Time					

- **My agents are all full-time employees and they work 8 hours per day. How can I set this up in my schedule?**

Set your staffing group's and staff's maximum and minimum working hours to 8 hours a day.

- **I have a mix of full-time and temporary employees. What is the best way to define it?**

The best practice is to use staffing groups to set the working hours to the 8 hours and then use staff rules to set the individual part-time agent working hours to their specific value. The value in the staff rule will override the value in the staffing group.

- **How do I add meetings or one-off events?**

Generate a schedule with daily activities first. In the schedule manager view, select any schedule, and use **add shift** to add a one-off shift activity to the schedule.

Forecasting in Amazon Connect

Forecasting is the starting point for any scheduling and capacity planning activities. Before you can generate a schedule or capacity plan, you must create a corresponding forecast.

A *forecast* attempts to predict future contact volume and average handle time. We use historical metrics to create the forecast.

Short-term forecasts are automatically updated every 15 minutes. When you come into work, you can review the forecast that was updated overnight with the most current data. You can publish the forecast to make it available to schedulers whenever you want. The **Forecasting** page displays when a forecast was last updated and published. Use short-term forecasts for scheduling up to 18 weeks ahead.

Long-term forecasts are automatically updated every week, based on the day you created the forecast. For example, if you created the forecast on a Monday, it is updated every Monday. Use long-term forecasts for capacity planning up to 64 weeks ahead.

Forecasting

[Forecasts](#)
[Forecast Groups](#)
[Import Data](#)
 Search

Remove

Create Forecast

<input type="checkbox"/>	Forecasts	Type	Metric	Status	Last computed ▼	Last published
<input type="checkbox"/>	Widget Support	Short Term	Contact Volume	Complete	Mar 4, 2022	Feb 20, 2022
<input type="checkbox"/>	Forecast_Group_20220114	Short Term	Contact Volume	Complete	Mar 4, 2022	-
<input type="checkbox"/>	Forecast [redacted]	Short Term	Contact Volume	Complete	Mar 4, 2022	Jan 28, 2022

Important

Only the most current forecast is available. Because the forecast is updated every day, if you want to keep the current day's forecast, you must download it before Amazon Connect overwrites it.

Getting started with forecasting

Use the following steps to create a forecast and then share it with other people in your organization.

1. [Set the forecast and scheduling interval](#): This is a one-time activity typically set up by forecasters. It cannot be undone.
2. [Create forecast groups](#)
3. [Import historical data](#)
4. [Create forecasts](#)
5. [Inspect a forecast](#)
6. [Publish a forecast](#)

You can take other actions on a forecast, such as [downloading it to a .csv file for offline analysis](#) or [overriding](#) it. The following steps will get you started.

Set the forecast and schedule interval

You can set the granularity for your short-term forecasts and your schedules.

Important things to know

- You must have security profile permissions for **Analytics, Forecast and schedule interval - Edit**. For more information, see [Assign permissions](#).
- You must specify an interval for short-term forecasting and scheduling.
- Amazon Connect supports 15- or 30-minute intervals. For example, if you select 30 minutes as the interval, your short-term forecasts are generated for 30-minute intervals (that is, 20 contacts between 9:00 AM-9:30 AM), and your schedules are computed for 30 minute intervals.
- You must set up a forecast and a schedule interval before you can generate forecasts or create forecast groups.
- After you set the forecast and schedule interval, you cannot change it.

To set the forecast and schedule interval

1. Log in to the Amazon Connect admin website.
2. On the Amazon Connect navigation menu, select **Analytics and optimization, Forecasting**.
3. Choose the **Forecast and schedule interval** tab. You'll see this tab only if you have the appropriate security profile permissions.

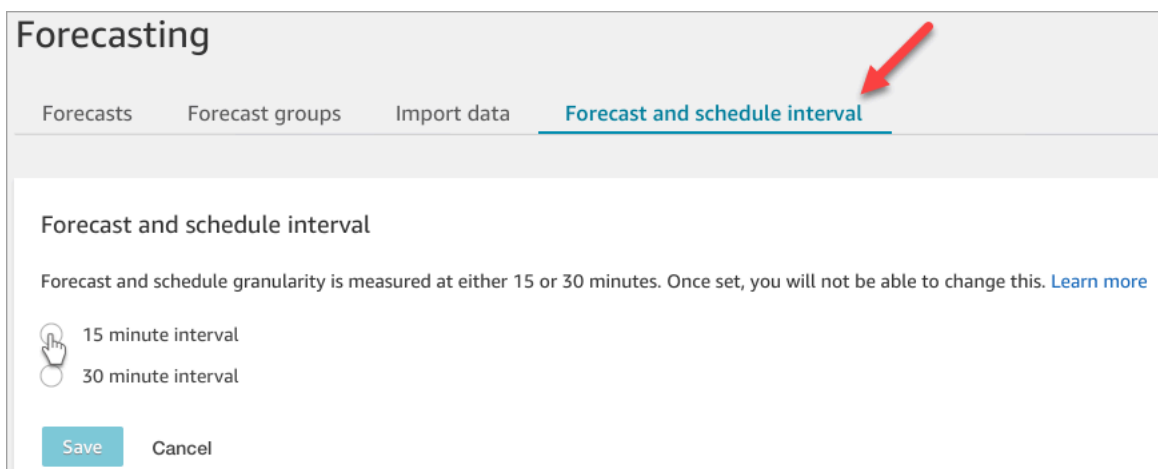

4. Choose one of the following options:
 - **15 minute interval** – Generates short-term forecasts in 15-minute intervals. For example, 20 contacts between 9:00 AM to 9:15 AM, and 30 contacts between 9:15 AM to 9:30 AM.

- **30 minute interval** – Generates short-term forecasts in 30-minute intervals. For example, 20 contacts between 9:00 AM to 9:30 AM, 30 contacts between 9:30 AM to 10:00 AM.

Set the forecast time zone

On the **Forecasting** page, you set the time zone for your forecasts. The following image shows the **Forecast time zone** tab, and the dropdown menu where you choose the time zone.

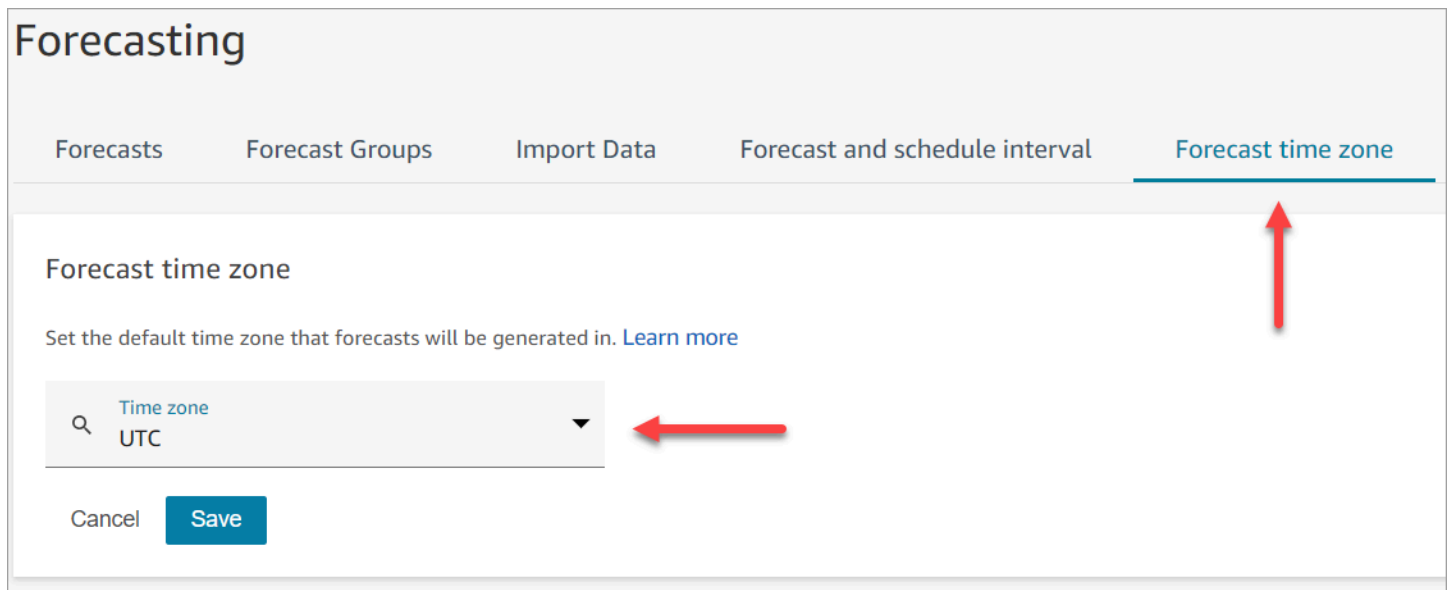

Important things to know

- To edit the forecast time zone, you must have security profile permissions for **Analytics, Forecast and schedule interval - Edit**. For more information, see [Security profile permissions for forecasting, capacity planning, and scheduling](#).
- The default value for the forecast time zone is UTC.
- When you change the forecast time zone, Amazon Connect regenerates both the short-term and long-term forecasts.
 - Updated forecasts in the selected time zone are available within 24 hours.
 - The forecasts are automatically adjusted for daylight savings if the selected time zone observes daylight savings.

Forecast time zones on the Amazon Connect admin website and in downloads

- **Short-term forecasts:** You can view short-term forecasts in the selected time zone after updating the time zone configuration.
- Downloads are in the time zone that the forecast was computed in. For example:
 - Let's say today is May 1st, and the forecast time zone is currently set to UTC.
 - The latest computed forecast generated on May 1st is in UTC.
 - Later that day (at 1PM) you change forecast time zone to US/Pacific.
 - The forecast computed on May 2nd is in US/Pacific time zone.
- **Long-term forecasts:** You will continue to view and download long-term forecasts in the time zone they were computed in. Long-term forecasts that are computed after updating the time zone configuration. You can view and download forecasts in the selected time zone.

Forecast overrides

- **Short-term forecasts:** When overriding a short-term forecast, the timestamp column must be in the ISO8601 format. You can use UTC values or time zones with the appropriate offset.

For example, if you are overriding the forecast for the May 30th 8AM - 8:15AM interval and you've configured the time zone as US/Pacific, you can use either of the following values:

- 2024-05-30T15:00:00Z
- 2024-05-30T08:00:00-07:00
- **Long-term forecasts:** When overriding a long-term forecast, the timestamp column must be in the ISO8601 format and the time value must be midnight in the configured time zone.

For example, if you are overriding the forecast for May 30th and you have configured the time zone as US/Pacific, then the following are acceptable values for the timestamp:

- 2024-05-30T07:00:00Z
- 2024-05-30T00:00:00-07:00

Note

Long-term forecast overrides are not available while the forecasts are being computed in the updated time zone.

Historical data upload

- **Interval data:** When uploading interval (15min/30min) level historical data, the timestamp column must be in the ISO8601 format. The time value can be in UTC or in the configured time zone with the appropriate offset.

For example, if you are uploading the forecast for the May 30th 8AM - 8:15AM interval and you have configured the time zone as US/Pacific, then the following are acceptable values for the timestamp:

- 2024-05-30T15:00:00Z
- 2024-05-30T08:00:00-07:00
- **Daily data:** When uploading daily aggregated historical data for long-term forecasting, the timestamp column must be in the ISO8601 format and the time value must be midnight in the configured time zone.

For example, if you are uploading the forecast for May 30th and you have configured the time zone as US/Pacific, then the following are acceptable values for the timestamp:

- 2024-05-30T07:00:00Z
- 2024-05-30T00:00:00-07:00

Create forecast groups

Forecast groups are a way for you to combine different queues into one forecast. This enables you to create a forecast from aggregated data from multiple queues, instead of from just one queue.

Important things to know

- Forecast groups are associated with a staffing group for scheduling purposes. Therefore, we recommend you group queues that share the same pool of staff (agents) under the same forecast group. It enables you to generate a more accurate forecast.
- Each queue can belong to only one forecast group. This prevents duplicates in the forecast.
- You must create at least one forecast group before you can generate any forecast.
- We strongly recommend that you create all forecast groups before creating any forecast.

Amazon Connect uses historical data for queues included in all forecast groups to train your forecasting model. By creating forecasts after all forecast groups are created, you ensure historical data of all relevant queues are included in the training.

- If a queue is associated with a forecast group and is later disabled, you don't have to remove this queue from the forecast group. This is because: Although the queue is included by the forecast group and the historical data associated with it is included in the forecast, over time, no contact reaches the disabled queue, and thus stops impacting the forecast. Only the active queues contribute to the forecast.

How to create forecast groups

1. Log in to the Amazon Connect admin website with an account that has security profile permissions for **Analytics, Forecasting - Edit**.

For more information, see [Assign permissions](#).

2. On the Amazon Connect navigation menu, select **Analytics and optimization, Forecasting**.
3. Select the **Forecast groups** tab, and then choose **Create forecast group**.
4. On the **Create Forecast Groups** page, under **Queues**, you'll see a list of queues that are not yet associated with a forecast group are listed. If no queues are listed, it means they are all associated with a forecast group already.
5. Drag and drop one or more queues to the forecast group, as shown in the following image. You can press and hold CTRL (COMMAND for macOS users) or SHIFT to select multiple queues at a time.

Forecasting: Forecast Groups > Create Forecast Groups

Create Forecast Groups

Cancel [Save](#)

Name your forecast group and select queues that make up this group. A queue can only be associated with one forecast group.

Group name

Forecast-group1

Drag queues here from the queues list...

[Support - Blue Widgets](#) 0 / 200

[Add Forecast Group](#)

Queues

Search

[Select All/None](#)

- [Support - Blue Widgets](#)
- [Widget Support 1](#)
- [Widget Support -2](#)
- [Queue_2_20220221](#)

Drag and drop the queues to the forecast group.

- Choose **Save**. The following image shows the new forecasting group, along with the number of queues in the group and the date it was last changed.

Forecasting

Forecasts Forecast Groups Import Data

Search

[Remove](#) [Create forecast group](#)

<input type="checkbox"/> Group name	No. of queues	Date modified
<input type="checkbox"/> Forecast-group1	4	Mar 4, 2022

- After creating a forecast group, you can add or remove queues. However, doing so might initiate an immediate change in associated forecasts.

For example, if you made a change for forecast group today, Amazon Connect automatically computes the new short-term and long-term forecasts tomorrow. Your change to the forecast group also impacts downstream capacity plans and schedules that are created based on the forecast group.

The following image shows a sample warning message when adding a queue may trigger an immediate change in associated forecasts. You must choose **Confirm** if you want to continue.

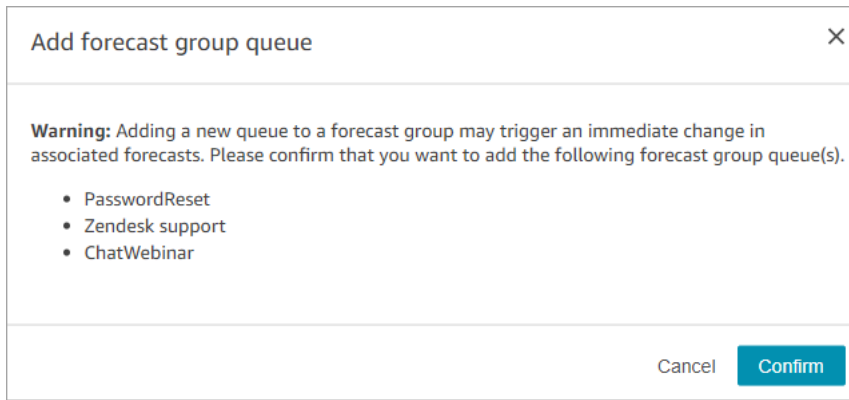

8. You can remove the forecast group by using the **Remove** function.
 - a. delete the forecasts that are associated with the forecast group you want to delete.

For example, in the following image, a forecast group named *Network_Issues* cannot be deleted because this forecast group was used to create forecasts.

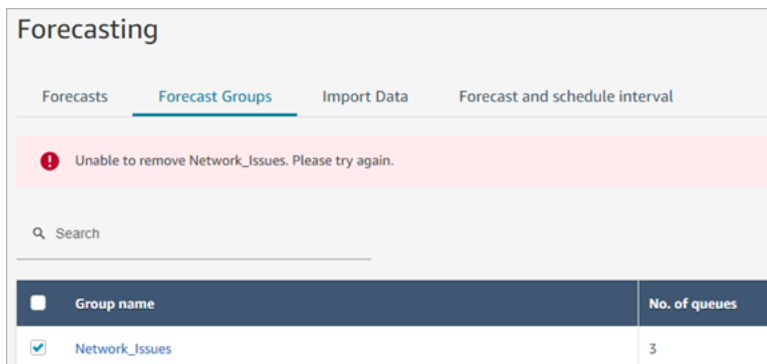

Therefore, go to **Forecasts** tab to delete those associated forecasts.

- b. Delete the forecast group.

Next steps

Now you're ready to create a forecast. For instructions, see [Create forecasts](#).

Import historical data for forecasting

Amazon Connect requires sufficient historical data to learn the contact pattern and make good forecasts. By default, it uses historical contact data in Amazon Connect for forecasting. You can import historical data from external applications for Amazon Connect to use for forecasting. When you import data, Amazon Connect uses both its data and the imported data for forecasting. However, *the imported data takes precedence over the Amazon Connect data*.

When to import data

We recommend importing historical data from external applications in the following use cases:

- **Insufficient historical data in Amazon Connect.** If you have less than one year of historical data in Amazon Connect, we strongly recommend that you extract historical data from your previous system and upload the data to Amazon Connect. It is fine to have data split between your Amazon Connect data and uploaded historical data. For example, if you want to generate forecasts on January 1, 2022, and you have nine months of historical in Amazon Connect (from April 1 to December 31, 2021), we recommend importing three additional months of data (from January 1 to March 31, 2022) to make a *continuous* one-year historical data set available.

Important

If you have less than six months of recent historical data in Amazon Connect, the forecast will fail. You must import additional historical data to unblock forecasting. For more information, see [Data requirements for forecasting](#).

- **Incorrect historical data in Amazon Connect.** If the historical contact pattern is incorrect (for example, the contact volume is abnormally low on the day of a wide-spread power outage in the contact center), you can import data that is more representative to override historical data and correct for the anomaly.

If you have more than one year of historical data in Amazon Connect, you can choose to skip data import and start [creating forecasts](#).

Important things to know

- The data file must be a .csv file and it must be in the required format. If the file format and data don't meet the requirements, the upload does not work. We recommend downloading and using the template provided through the Amazon Connect admin website (see step 4 in [How to import historical data](#)) to help you prepare the historical data.

The following image shows an example of the .csv template. There are headings in the first row for QueueName, QueueId, ChannelType, and so on.

	A	B	C	D	E	F	G	H
1	QueueName	QueueId	ChannelType	TimeStamp	IntervalDuration	IncomingContactVolume	AverageHandleTime	ContactsHandled
2								
3								

Following are the requirements for imported data:

- **QueueName:** Enter the Amazon Connect queue name.
- **QueueId:** Enter the Amazon Connect queue ID. To find the queue ID in the Amazon Connect admin website, on the left navigation, go to **Routing, Queues**, choose the queue, select **Show additional queue information**. The queue ID is the last number after `/queue/`.
- **ChannelType:** Enter CHAT or VOICE. You must capitalize the channel type.
- **TimeStamp:** Enter the timestamp in ISO8601 format. For Daily interval data, the time value must be midnight in the [selected time zone](#).
- **IntervalDuration:** Enter 15mins or 30mins for short-term forecast, depending on your forecast and schedule interval. Enter daily for long-term forecast.
- **IncomingContactVolume:** Enter the number of inbound, transfer, and callback contacts as an integer.
- **AverageHandleTime:** Enter the amount of average handle time (in seconds) as type double/decimal.
- **ContactsHandled:** Enter the number of inbound, transfer, and callback contacts handled as an integer.
- You can import multiple files. You do not have to consolidate all data in one big file. You can divide data by year, queue, interval duration types, and more, per your preference.

If duplicate data are found across multiple files, the last uploaded records are used. For example:

1. You have the original historical data (from Amazon Connect) from 7/1 to 8/1.
 2. You uploaded a new historical data file X to override 7/10 to 8/1.
 3. You uploaded another new historical file Y to override 7/15 to 8/1.
 4. And now, the historical data baseline is: 7/1 to 7/9 from original, 7/10 to 7/14 from file X, 7/15 to 8/1 from file Y.
- You need to upload historical data *separately* for short-term and long-term forecast.
 - Data aggregated in 15- or 30-minute intervals is used for short-term forecasting.
 - Data aggregated at daily grain is used for long-term forecasting.

For example, if you only upload data in 15- or 30-minute interval, you won't be able to generate long-term forecasts.

- The following special characters are allowed in the .csv file: -, ., , (, and). Space is allowed.

The following image shows an example of what the data looks like in a CSV file that has been opened with Excel.

	A	B	C	D	E	F	G	H	I
1	Column header	QueueName	QueueId	ChannelType	TimeStamp	IntervalDuration	IncomingContactVolume	AverageHandleTime	ContactsHandled
2	Accepted value/format	Queue name in Connect	36-digit queue_id in Connect	- VOICE - CHAT	UTC (ISO8601)	- 15mins - 30mins - daily	Integer	Integer	Integer
3	Notes		QueueId is available in Connect UI. (Click "show additional info" in queue page)	Has to be capitalized		Has to be one of the three values above	The number of incoming inbound, transfer, and callback contacts	Average handle time (AHT) for contacts	The number of inbound, transfer, and callback contacts handled
4	Example: a record in a file uploaded for <i>short-term</i> forecast	Queue1	qbsey48u-1522-5cac-8b17-	CHAT	2020-02-14T05:15:00Z	15mins	20	250	18
5	Example: a record in a file uploaded for <i>long-term</i> forecast	Queue1	qbsey48u-1522-5cac-8b17-	VOICE	2020-02-14T00:00:00Z	daily	150	200	130

How to import historical data

1. Log in to the Amazon Connect admin website with an account that has security profile permissions for **Analytics, Forecasting - Edit**.

For more information, see [Assign permissions](#).

2. On the Amazon Connect navigation menu, select **Analytics and optimization, Forecasting**, and then choose the **Import Data** tab.
3. Choose **Upload data**.
4. On the **Upload historical data** dialog box, choose **download the CSV template for historical data**.
5. Add historical data to the .csv file, and then choose **Upload file** to upload it. Choose **Apply**.
6. If the upload fails, choose **download details** to view the error log message for more information. The following image of the **Forecasts** page shows the location of the **download details** link, next to the **Failed** status message.

<input type="checkbox"/> Uploaded CSV	Type	Interval	Date range	Status	Date uploaded
<input type="checkbox"/> test-forecast-import.csv	Historical data	-	-	In progress ⓘ	Mar 8, 2022
<input type="checkbox"/> generated-Brokerage-All-daily.csv	Historical data	-	-	❌ Failed, download details	Mar 7, 2022
<input type="checkbox"/> data-generator-red-widgets-daily.csv	Historical data	Daily	Jan 1, 2021 - Feb 16, 2022	Complete	Feb 21, 2022

The following image shows the download details file opened by using Notepad. It indicates the error is in Row 2, the QueueId is not valid.

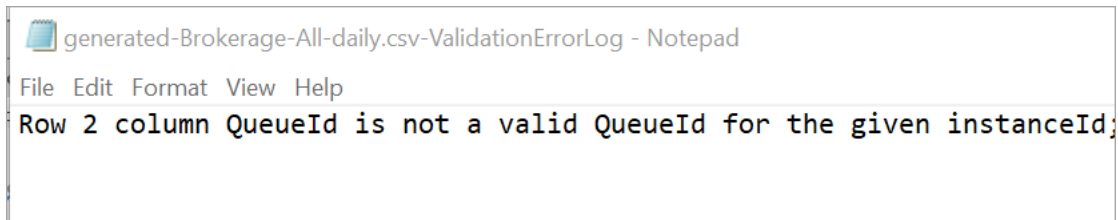

7. If the forecast was uploaded successfully, its **Status = Complete** and **Date uploaded = today**.

Delete imported historical data

You can delete previously imported historical data in Amazon Connect. Note that the historical data deletion or addition will trigger an immediate change in associated forecasts because this action will change the historical data baseline that the model is trained for. The following image shows an example warning message about the consequences of removing data.



After the imported historical data is deleted, the last previously uploaded data is used for the baseline. Take the previous example:

- You have the original historical data (from Amazon Connect) from 7/1 to 8/1.
- You uploaded a new historical data file X to override 7/10 to 8/1.
- You uploaded another new historical file Y to override 7/15 to 8/1.
- And now, the historical data baseline is: 7/1 to 7/9 from original, 7/10 to 7/14 from file X, 7/15 to 8/1 from file Y.
- If:
 1. You deleted file Y, the baseline will be: 7/1 to 7/9 from original, 7/10 to 8/1 from X.
 2. You deleted file X, the baseline will be: 7/1 to 7/14 from original, 7/15 to 8/1 is from Y.

Data requirements for forecasting

Amazon Connect generates forecasts using a machine-learning model tailored for contact center operations. It requires a sufficient amount of recent contact data to ensure the model is trained with relevant data and is able to generate high-quality forecasts.

Important things to know

- Amazon Connect generates forecasts using historical data for all queues included in all forecast groups.
- Amazon Connect performs a *data sufficiency* check (is there enough data) based on the aggregation of all queues included in all forecast groups.
 - At least 2,000 monthly contacts in the past six months are required to successfully generate a forecast.
 - Amazon Connect does not require 2,000 monthly contacts for every queue. At least one forecast group should have more than 2,000 contacts per month for the last 6 months.
 - While Amazon Connect can generate forecasts with six months of data, we recommend 12 months of recent contact data to ensure contact patterns (for example, seasonality) are properly captured.
- Additional data requirements for each queue.
 - For any gaps of more than 3 days in the data, there must be data for the same number of days before or after the gap. For example, if there was a gap of 10 days in the data, then there must be data for 10 days either before or after this gap.
 - Short-term forecasts require at least one data point older than 7 days from the forecast start date. For example, for a forecast with a start date of April 1st, 2024, each queue must have at least one data point prior to March 24th, 2024.
 - Long-term forecasts require at least one data point older than 13 weeks from the forecast start date. For example, for a forecast with a start date of April 1st, 2024, each queue must have at least one data point prior to January 1st, 2024.

Do I have a sufficient amount of recent contact data?

- If you have been using Amazon Connect for more than 12 months, you do not need to provide any additional data.

- If you have been using Amazon Connect for more than six months but less than 12, we recommend providing additional historical data. You can import historical data from a source that is external to Amazon Connect. For instructions, see [Import historical data](#).
- If you have been using Amazon Connect for less than six months, make sure it has at least six months of data. Otherwise, forecasting will fail.

For instructions about how to import more data, see [Import historical data](#).

Create forecasts

Forecasts are a projection of the workload in your contact center. Amazon Connect provides long-term and short-term forecasts for you to generate capacity plans and agent schedules. The forecasts include inbound, transfer, and callback contacts in both voice and chat channels.

After creating a forecast, you will not need to generate it manually.

- Long-term forecasts are generated for 64 weeks and automatically updated every day.
- Short-term forecasts are generated for 18 weeks, updated every 15 minutes, and they run automatically every day.
- Every forecast is computed using the most current contact data.
- The models for short-term and long-term forecasts are retrained on a weekly and monthly basis, respectively, to incorporate the latest contact patterns.
- You can delete forecasts. However, downstream capacity plans and schedules created based on the forecasts will be impacted.

To create a forecast

1. Before creating a forecast, you must create at least one forecast group. If you haven't done that, see [Create forecast groups](#). We strongly recommend creating all of your forecast groups before creating any forecasts.
2. Log in to the Amazon Connect admin website with an account that has security profile permissions for **Analytics, Forecasting - Edit**.

For more information, see [Assign permissions](#).

3. On the Amazon Connect navigation menu, select **Analytics and optimization, Forecasting**.
4. Select the **Forecast** tab, and then choose **Create Forecast**.

5. On the **Create Forecast** page, choose the forecast groups.

Forecasting: Forecasts > Create Forecasts

Create Forecast

Parameters

Forecast groups
Select forecast group(s) you want to generate a forecast for.

Basic Forecast Group X

Metrics
The forecast(s) will be generated for contact volume and average handle time.

Forecast type
Select forecast duration(s).

- Long term**
The forecast(s) will be generated for 64 weeks at daily granularity
- Short term**
Forecast will be generated for 18 weeks at 15 minute interval granularity

6. Choose the forecast type. Amazon Connect creates a forecast for each type you select.
 - **Long-term** forecasts are used for capacity planning. For example, how many Full Time Equivalent (FTE) agents you need to hire in the next few months, quarter, and year.
 - **Short-term** forecasts are used for scheduling agents and interval level agent headcount estimation.
7. Choose **Save**. If the forecast group has already been included in a forecast, an error message is displayed.
8. If the forecast was created successfully, it's Status = **Scheduled**.

The status is **Complete** when the computation finishes. You can use **Search** to find forecasts by forecast group name.

9. Amazon Connect creates a forecast for each forecast type, as shown in the following image.

Forecasts	Type	Metric	Status	Last computed	Last published
<input type="checkbox"/> Widget Support	Short Term	Contact Volume	Complete	Mar 14, 2022	Feb 20, 2022
<input type="checkbox"/> Widget Support	Short Term	Average Handling Time	Complete	Mar 14, 2022	Feb 20, 2022
<input type="checkbox"/> Widget Support	Long Term	Contact Volume	-	Feb 23, 2022	Feb 23, 2022
<input type="checkbox"/> Widget Support	Long Term	Average Handling Time	-	Feb 23, 2022	Feb 23, 2022

Inspect a forecast

You can inspect your forecasts before publishing them. You can do this in the online Amazon Connect admin website, or [download the forecasts](#) for offline analysis.

To help make it easier to inspect a forecast in the Amazon Connect admin website, the forecast data is displayed in both a graph and a table. Use the controls on the report settings panel and calendar picker to adjust and filter the data for a more granular view. For example, you can:

- Use the calendar to change the horizon. You can zoom into specific dates.
- Choose 15 minute intervals if your date range is less than a week. This enables you to see the exact contact pattern of the day.
- Compare **Last computed forecast** and **Last published forecast** as shown in the following image.
- Compare **Actuals** and forecasts to identify any abnormalities in either the line chart or the "Variance" chart. The following image shows the forecast data is displayed as graphs.

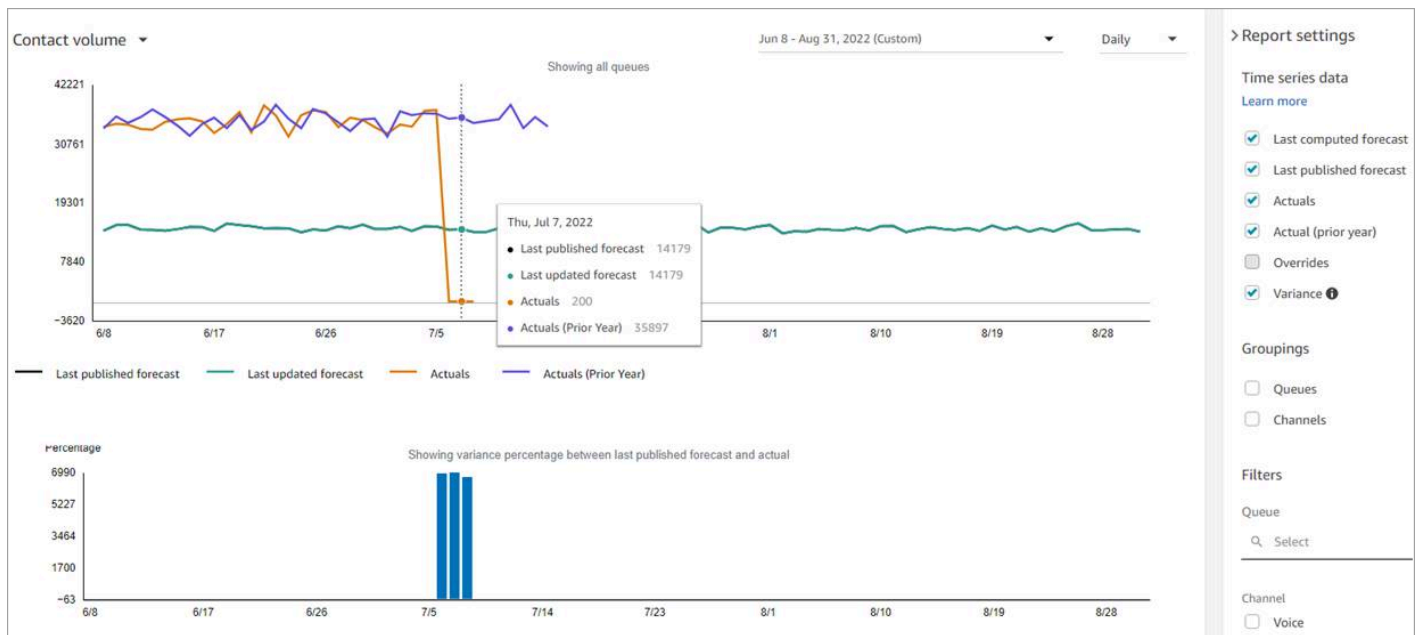

Choose the **Override** setting to inspect the effect of any override you uploaded. The **Override** option is active only after an override has been uploaded. For more information, see [Override a forecast](#).

- Filter by queues or channels to limit your forecast to one or more type.

Download a forecast

You can download a forecast so you can inspect it offline. A forecast is downloaded as a .csv file of the forecast data. It has the queue name, channel type, timestamp, incoming contact volume and average handle time data.

1. Log in to the Amazon Connect admin website with an account that has security profile permissions for **Analytics, Forecasting - Edit**.

For more information, see [Assign permissions](#).

2. On the Amazon Connect navigation menu, choose **Analytics and optimization, Forecasting**.
3. On the **Forecasts** tab, choose the forecast.
4. Choose **Actions**, and then download either the last computed forecast or the last published forecast.
5. We recommend choosing **click here**. This enables you to choose the name of the file download and where to save it, as shown in the following image. Otherwise, the file is saved to your **Downloads** folder and its name is a generated number.

Forecast for: Widget Support Last computed Mar 04, 2022 at 10:05:21 AM - UTC Actions

✔ Downloading last computed short term forecast. If download does not automatically begin, [click here](#).

Long term Short term

Contact volume Show

Volume

327

238

149

59

Opening 2968b9fa-23bd-4589-a110-54a379e29a36.csv

You have chosen to open:

2968b9fa-23bd-4589-a110-54a379e29a36.csv
 which is: Microsoft Excel Comma Separated Values File (1.5 MB)
 from: ...castingservice-forecast-export.s3.us-west-2.amazonaws.com

What should Firefox do with this file?

Open with Excel (default)

Save File

Do this automatically for files like this from now on.

OK Cancel

> Report settings

Time series data [Learn more](#)

Last computed forecast

Last published forecast

Overrides

Groupings

Queues

Override a forecast

You can override the forecast at the queue channel level by uploading a .csv file. Override allows you to modify forecasts and make sure the forecasts reflect the contact pattern in special events (for example, a one-off marketing event that can increase volume by 10 percent in a given week).

You can also remove the override if the override is no longer applicable.

Important things to know

- To override a forecast, you need to prepare and upload a .csv file with your override data. Currently Amazon Connect does not support changing the values in forecasting user interface directly.
- The override data file must be a .csv file and it must be in the required format. If the file format and data don't meet the requirements, the upload does not work. We recommend downloading and using the template provided to help you prepare the historical data.

The following image shows an example csv file with data in it.

	A	B	C	D	E	F	G	H
1	Column header	QueueName	QueueId	ChannelType	TimeStamp	IntervalDuration	AverageHandleTime	IncomingContactVolume
2	Accepted value/format	Queue name in Connect	36-digit queue_id in Connect	- VOICE - CHAT	UTC (ISO8601)	- 15mins - 30mins - daily	Integer	Integer
3	Notes		QueueId is available in Connect UI. (Click "show additional info" in queue page)	Has to be capitalized		Has to be one of the three values above	Average handle time (AHT) for contacts	The number of incoming inbound, transfer, and callback contacts
4	Example	Queue1	qbsey48u-1522-5cac-8b17- XXXXXXXXXX	CHAT	2020-02-14T05:15:00Z	15mins		20
5		Queue1	qbsey48u-1522-5cac-8b17- XXXXXXXXXX	VOICE	2020-02-14T00:00:00Z	daily	200	

Following are the requirements for imported data:

- **QueueName:** Enter the Amazon Connect queue name.
- **QueueId:** Enter the Amazon Connect queue ID. To find the queue ID in the Amazon Connect admin website, on the left navigation, go to **Routing, Queues**, choose the queue, select **Show additional queue information**. The queue ID is the last number after /queue/.
- **ChannelType:** Enter CHAT or VOICE.
- **TimeStamp:** Enter the timestamp in ISO8601 format. For long-term forecast overrides, the time value must be midnight in the [selected time zone](#).
- **IntervalDuration:** Enter 15mins or 30mins for short-term forecast, depending on your forecast and schedule interval. Enter daily for long-term forecast.
- **IncomingContactVolume:** Enter the number of inbound, transfer, and callback contacts as an integer.
- **AverageHandleTime:** Enter the amount of average handle time (in seconds) as type double/decimal.
- You can upload only one override file for a forecast group.
 - This means if you previously uploaded an override file (for example, with 120 lines of overrides), you must add new overrides to this override file (for example, add 50 new lines of overrides) and re-upload the file that now has 170 lines of overrides.
 - This also means you will need to include overrides for both short-term and long-term forecasts in one file.
- Both contact volume and Average Handle Time metrics are included in one override file. Both columns must be populated in the override file.
- The following special characters are allowed in the .csv file: -, _, ., (, and). Space is allowed.

How to override a forecast

1. Log in to the Amazon Connect admin website with an account that has security profile permissions for **Analytics, Forecasting - Edit**.

For more information, see [Assign permissions](#).

2. On the Amazon Connect navigation menu, select **Analytics and optimization, Forecasting**, and then choose the **Forecast** tab.
3. Choose the forecast.

4. Choose **Actions, Upload forecast override**.
5. Choose **Download the CSV template for override data**.

 **Note**

Amazon Connect supports one, which would be the latest, override file per forecast group.

- If you have never uploaded an override file, your template will contain headings but no data.
- If you have uploaded override file in the past, your template will be the previously uploaded file.

If you need to make changes later on to the same forecast, you must download the last uploaded file, make your changes, and then upload the file. Amazon Connect retains only the last uploaded file.

6. Add override data, and then choose **Upload file** to upload it. Choose **Apply** to confirm forecast override.

Publish a forecast

When you publish a forecast, you make it visible to other users, such as capacity planners and schedulers, so that they can use the forecasts for capacity planning and scheduling.

 **Important**

Amazon Connect retains only the last published forecast. We strongly advise you to download the last published forecast before publishing a new one because the last forecast will be permanently replaced. For instructions, see [Download last published forecast](#).

1. Log in to the Amazon Connect admin website with an account that has security profile permissions for **Analytics, Forecasting - View**.

For more information, see [Assign permissions](#).

2. On the Amazon Connect navigation menu, select **Analytics and optimization, Forecasting**.

3. On the **Forecasts** tab, choose the forecast.
4. Choose **Actions, Publish forecast**.
5. Choose the forecasts.

The status is **Complete** for successfully published forecasts. When publish fails, the status is **Publish failed**.

Download the last published forecast

1. Log in to the Amazon Connect admin website with an account that has security profile permissions for **Analytics, Forecasting - View**.

For more information, see [Assign permissions](#).

2. On the Amazon Connect navigation menu, select **Analytics and optimization, Forecasting**.
3. On the **Forecasts** tab, choose the forecast.
4. Choose **Actions, Download last published forecast**.
5. We recommend choosing **click here** as shown in the following image. This enables you to specify the name of the downloaded file and the location. Otherwise, the file is saved to your **Downloads** folder and its name is a generated number.



Capacity planning in Amazon Connect

A capacity plan helps you estimate the long-term FTE (full-time equivalent) requirements for your contact center, up to 18 months. It specifies how many FTE agents are required to meet the service level target for a certain period of time.

After you generate long-term FTE estimations, you can share this information with other stakeholders, such as Human Resources, Finance, and the Training Department, to help facilitate the hiring and training of staff. When a business launches a new product or extends into a new Region, staff hiring is needed to meet the customer service demand.

The capacity planning feature uses published long-term forecasts as input, along with scenario information that you provide. It then creates a long-term capacity plan that you can share with stakeholders. Capacity planning also uses the published short-term forecast when determining the FTE requirements. Short-term forecast is used to identify contact patterns within a day and that helps in determining the maximum number of FTEs that will be needed to meet the service level targets. The following diagram illustrates this integration among published long-term forecasts, capacity planning, and capacity planning output.

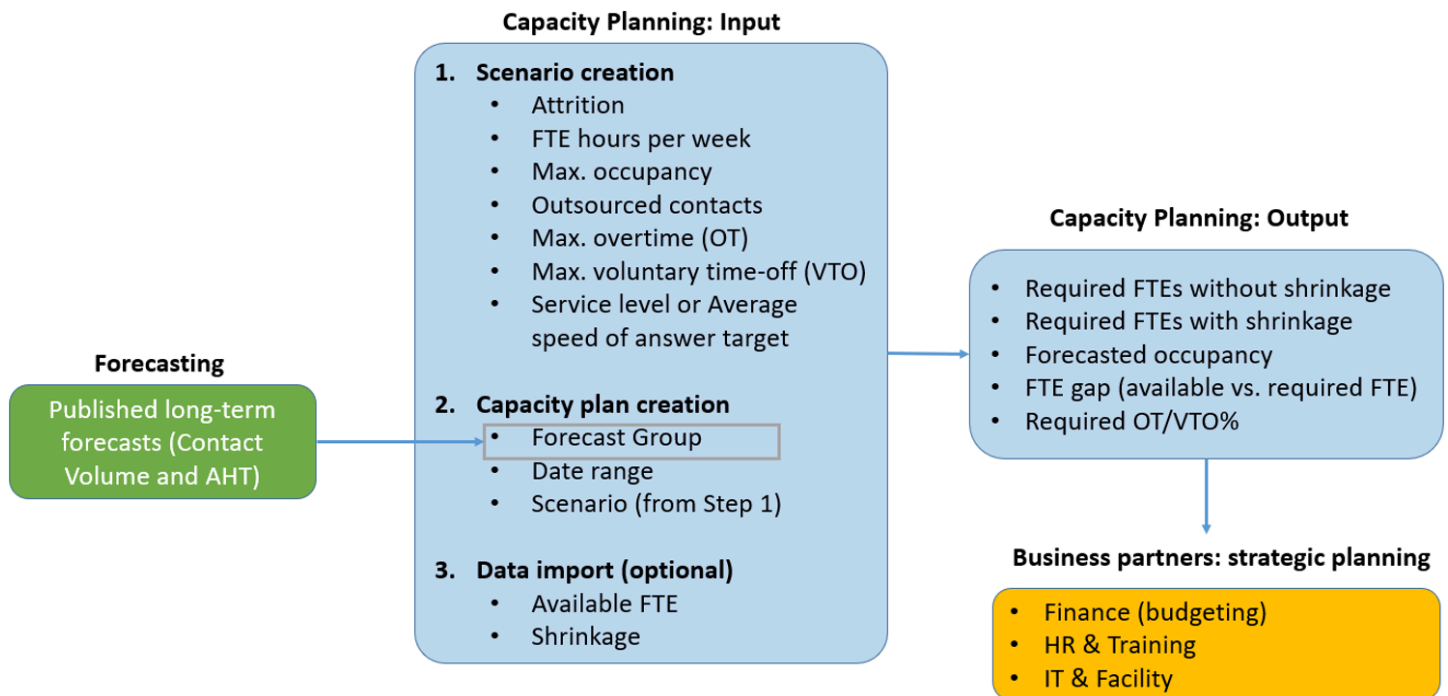

Getting started

Following is the order of steps for creating a capacity plan and sharing it with others.

1. [Create capacity planning scenarios](#)
2. [Import estimated future shrinkage and available full-time employees](#): This is an optional step but it can improve the accuracy of your capacity plan.
3. [Create capacity plans using forecasts and scenarios](#)
4. [Create capacity planning scenarios](#)
5. [Review](#), [override](#), [re-run](#), or [download](#) a capacity plan.
6. [Publish a capacity plan](#)

Create capacity planning scenarios

A scenario has two parts:

- **Scenario inputs:** The maximum occupancy, daily attrition, FTE hours per week. For example, you might enter data that represent your best case scenarios (everyone is at work) or worst case scenarios (a large number of people are out sick during winter months).
- **Optimization inputs:** The service level or average speed of answer (ASA). For example, 85% of calls are answered within 30 seconds of entering the queue.

You can then use this scenario to generate a capacity plan that represents how many people you need to hire accordingly to meet your business goals. The output includes the required FTE employees with and without shrinkage, forecasted occupancy rate, the gap between available required FTEs, and maximum overtime (OT) and voluntary time-off (VTO) rate allowed.

To create a capacity planning scenario

1. Before you can create a capacity plan, you must create and publish a long-term forecast. Amazon Connect uses the published long-term forecast as the input for creating the capacity plan. If you haven't yet created a forecast, see [Getting started with forecasting](#).
2. Log in to the Amazon Connect admin website with an account that has security profile permissions for **Analytics, Capacity planning - Edit**.

For more information, see [Assign permissions](#).

3. On the Amazon Connect navigation menu, choose **Analytics and optimization, Capacity planning**.
4. On the **Planning Scenarios** tab, choose **Create a Scenario**.
5. On the **Create scenario** page, enter a name and description.
6. In the **Scenario inputs** section, enter the following information:
 - a. **Max Occupancy (optional):** The percentage of time agents will spend handling contact volume when they log in.
 - i. **Daily attrition:** The percentage of staff leaving your contact center.

For example, if the annual attrition is 50%, the daily attrition would be $50\%/250$ working days per year = 0.2%.

- ii. **Full-time equivalent (FTE) hours per week:** How many hours each FTE employee will work per week.
- b. **Outsourced contacts (optional):** You can outsource a percentage to a third-party.
- c. **Max overtime (OT) allowed (optional):** Specify the maximum percent of overtime to plan for peaks. As a planner, you don't want to burn out your workforce.

For example, you specify 40 as FTE hours per week, with 10 percent maximum overtime. The total work week would be up to 44 hours.

- d. **Max voluntary time off (VTO) allowed (optional):** Specify the maximum percent of time off to plan for troughs, when there is a lull in contacts and you can save in costs. Be sure not to give too much time off in case traffic increases again.

For example, you specify 40 as FTE hours per week, with 10 percent maximum time off. The total work week would be at least 36 hours.

7. In the **Optimization inputs** section, enter the operational goals for your organization:

- a. **Service level:** The percentage of contacts answered within a defined target time threshold.

The following image shows service level targets where 80 percent of voice contacts and 70 percent of chat contacts will be answered within 30 seconds.

Optimization Inputs

Service level

Average speed of answer

85 % within 30 seconds of Voice

70 % within 30 seconds of Chat

- b. **Average speed of answer (ASA):** The average amount of time it takes for contacts to be answered in a call center during a specific time period.
- c. You can create one goal per channel. Choose **Add another goal** to add another goal.

Import estimated future shrinkage and available full-time employees

You can increase capacity planning accuracy by providing estimated future data (Available FTE and Shrinkage) for your existing forecast groups. Providing Available FTE and shrinkage data is optional. Amazon Connect can generate a capacity plan without it, but providing it improves the accuracy of your plan.

How to import data

1. Log in to the Amazon Connect admin website with an account that has security profile permissions for **Analytics, Capacity planning - Edit**.

For more information, see [Assign permissions](#).

2. On the Amazon Connect navigation menu, select **Analytics and optimization, Capacity Planning**.
3. On the **Import Data** tab, choose **Upload data**.

The .csv file you upload must have the following headings: FORECAST_GROUP, Date, AVAILABLE_FTE, IN_OFFICE_SHRINKAGE_OUT_OFFICE_SHRINKAGE. These are shown in the following image of a CSV file opened with Excel.

	A	B	C	D	E
		Date (use ISO 8601 format: YYYY-MM-DDThh:mm:ssZ)	AVAILABLE_FTE	IN_OFFICE_SHRINKAGE	OUT_OFFICE_SHRINKAGE
1	FORECAST_GROUP				
2	Forecast For Demo	2022-01-01T00:00:00Z	0	8%	12%
3	Forecast For Demo	2022-01-02T00:00:00Z	0	8%	12%
4	Forecast For Demo	2022-01-03T00:00:00Z	100	8%	12%
5	Forecast For Demo	2022-01-04T00:00:00Z	100	8%	12%
6	Forecast For Demo	2022-01-05T00:00:00Z	100	8%	12%
7	Forecast For Demo	2022-01-06T00:00:00Z	100	8%	12%
8	Forecast For Demo	2022-01-07T00:00:00Z	100	8%	12%
9	Forecast For Demo	2022-01-08T00:00:00Z	0	8%	12%

4. Update values in this template, and then choose **Upload CSV** to upload it. Choose **Upload**.

It usually takes between 2 - 5 minutes for the .csv file to upload. If the upload fails, check if the FORECAST_GROUP name in the .csv file matches the name of the forecast group that you created.

Important things to know about your .csv file

- **FORECAST_GROUP:** Enter the EXACT name of the forecast group you created. You can add multiple forecast groups in this .csv file.

- **Date:** Each row is one day. In the previous image, row 2 is January 1, row 3 is January 2, row 4 is January 3, and so on. Use ISO 8601 format ending with Z.
- **AVAILABLE_FTE:** Based on your estimation, how many full-time agents will be available for working that day. For example, your contact center currently has 100 FTEs and you expect this number to be the same next year.

In the previous image, 0 indicates no full-time agents are available on January 1 for the forecast group named **Forecast For Demo**. On January 3, 100 agents are available.

Tip

Required FTE (the output) is how many full-time agents are required to meet the Service Level target. For example, if the Required FTE = 120 and Available FTE = 100 for next year, then that means a deficit = 20.

- **IN_OFFICE_SHRINKAGE:** Percentage of agents in the office but not in production mode. For example, they might be in training or in meetings.
- **OUT_OFFICE_SHRINKAGE:** Percentage of agents absent from work (for example, no show or personal time off).

Note

The latest uploaded .csv file always overrides the previous one you updated. Make sure errors aren't introduced to the uploaded .csv file accidentally. For example, don't press **Enter** and add new rows to the end of the file. Otherwise, the data won't validate and an error message is displayed.

Create capacity plans using forecasts and scenarios

Before you can create a capacity plan, you must create a planning scenario and publish a long-term forecast. Amazon Connect uses the forecasts and planning scenarios as inputs for creating the capacity plan. If you haven't yet created a forecast and planning scenario, see [Getting started with forecasting](#) and [Create capacity planning scenarios](#).

How to create a capacity plan

1. Navigate to the **Capacity Plans** tab, and choose **Generate Plan**.
2. Provide the plan name, description, forecast group (which has published long-term forecasts), start/end date, and plan scenario. The following image shows example values for these fields.

Capacity Planning: Capacity Plans > Create a new plan

Generate Plan

Plan Inputs

Plan Settings Name	Description
<input type="text" value="Capacity_Plan_0322_2022"/>	<input type="text" value="Capacity_Plan_0322_2022 (voice and chat)"/>
Select Forecast Group	
<input type="text" value="Forecast For Demo"/>	
Start Date	End Date
<input type="text" value="Mar 23, 2022"/>	<input type="text" value="Apr 19, 2022"/>
Global Capacity Plan Scenario	
<input type="text" value="Test Scenario"/>	

3. Choose **Generate Capacity Plan**.
4. To quickly identify the plan that is in processing, choose **Last Computed** to sort the table list. In the following image, the status of the plan is **In Progress**.

Capacity Planning

Capacity Plans Planning Scenarios Import Data

Search by capacity plan name

Plan Name	Status	Start Date	End Date	Forecast Group	Planning Scenario	Date Created	Last Computed
Capacity_Plan_0322_2022	In Progress	Mar 23, 2022	Apr 19, 2022	Forecast For Demo	Test Scenario	Mar 18, 2022	Mar 18, 2022

It usually takes between 5-10 minutes for the plan to be generated. If the plan generation fails, try publishing the selected long-term forecasts, and then generating the capacity plan again.

Review capacity plan output

To review capacity plan output, choose the hyperlink for the plan you generated. The first half of the page summarizes the input you used in scenario and capacity plan generation.

The plan output shows a week-by-week or month-by-month calculation. To switch from weekly to monthly view, select **Monthly** from the dropdown, as shown in the following image.

Plan Outputs

Weekly ▼

Metric	Mar 4 - Mar 10, 2022	Mar 11 - Mar 17, 2022	Mar 19 - Mar 25, 2022	Mar 26 - Apr 1, 2022	Apr 2 - Apr 8, 2022	Apr 9 - Apr 15, 2022	Apr 16 - Apr 22, 2022	Apr 23 - Apr 29, 2022	Apr 30 - May 6, 2022
Forecasting Inputs									
Forecasted Contact Volume	51719	54303	53932	53228	52421	47114	51085	51124	
Forecasted Average Handling Time (AHT), seconds	173	173	173	174	173	174	175	176	
Outputs									
Required FTEs (without Shrinkage)	99	103	103	102	100	91	99	99	
Forecasted Occupancy %	64%	63%	62%	63%	63%	62%	62%	63%	
Outputs with additional input									
Required FTEs (with Shrinkage)	116	128	128	126	124	112	122	123	
Available FTEs	102	124	126	126	127	126	122	127	
Metrics calculated from available FTE input									
Gap between available FTEs and required FTEs	-14	-4	-2	0	3	14	0	4	
Gap %	-14%	-3%	-2%	0%	2%	11%	0%	3%	
Required OT %	14%	3%	2%	0%	0%	0%	0%	0%	
Required VTO %	0%	0%	0%	0%	2%	11%	0%	3%	

Rows per page: 10 1-10 of 10

Following is a description of the metrics in the plan output:

- **Forecasting Inputs**

- **Forecasted Contact Volume:** This metric is a sum of both voice and chat volume for the selected forecast group.
- **Forecasted Average Handling Time (AHT), seconds:** This metric shows the aggregated AHT for the selected forecast group.
- The forecasted contact volume and AHT in the plan output table reflects only the values from the selected forecast group. After there are newly published forecasts, consider re-running the capacity plan to reflect the latest published contact volume and AHT.

- **Outputs**

- **Required FTEs (without Shrinkage):** How many full-time equivalent agents need to be hired to meet the defined business goals (such as service level target), without considering shrinkage.
- **Forecasted Occupancy %:** How much occupancy is for the agents.

- **Outputs with additional input**

- **Required FTEs (with Shrinkage):** How many full-time equivalent agents needed to be hired to meet the defined business goals (such as service level target), with considering shrinkage.
- **Available FTEs:** How many agents are available for working that day. It can be uploaded in the **Import data** section.

- **Metrics calculated from available FTE input**

- **Gap between available FTEs and required FTEs:** The difference between available FTEs and required FTEs.
- **Gap %:** The percentage of the gap.
- **Required OT %:** if there is a supply deficit (required FTEs higher than available FTEs), required OT% indicates how much overtime would be needed to cover the deficit.
- **Required VTO %:** If there is a supply surplus (the number of required FTEs is lower than the available FTEs), required VTO % indicates how much voluntary time off could be used to lower the amount of agent idle time and thus lower costs.

Override a capacity plan

You can upload a .csv file that overrides the **Required FTEs (without Shrinkage)** data in the **Plan outputs** section of a capacity plan. This section is shown in the following image.

Plan Outputs	
Metric	Jan 6 - Jan 12, 2022
Forecasting Inputs ⓘ	
Forecasted Contact Volume ⓘ	6761
Forecasted Average Handling Time (AHT), seconds	917
Outputs ⓘ	
Required FTEs (without Shrinkage) 	79
Forecasted Occupancy %	50%
Outputs with additional input ⓘ	
Required FTEs (with Shrinkage)	97

You might want to do this, for example, to give your team of agents a buffer.

1. Log in to the Amazon Connect admin website with an account that has security profile permissions for **Analytics, Capacity planning - Edit**.

For more information, see [Security profile permissions for forecasting, capacity planning, and scheduling](#).

2. On the Amazon Connect navigation menu, select **Analytics and optimization, Capacity Planning**.
3. On the **Capacity Plans** tab, choose the plan.
4. On the detailed page for the capacity plan, choose **Actions, Upload plan override**, and then choose **download the CSV template file**. This option is shown in the following image.

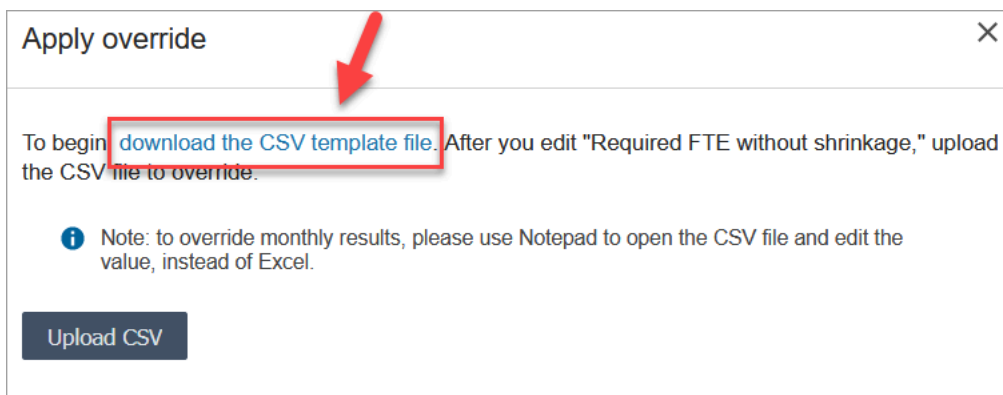

The .csv file template has one row, and it contains the values that were displayed in the **Required FTEs (without Shrinkage)** row of the **Plan outputs** table. The following image shows an example of this data in a .csv file

	A	B	C	D	E
1	Metrics	Jan 6 - Jan 12, 2022	Jan 13 - Jan 19, 2022	Jan 20 - Jan 26,	Jan 27 - Fe
2	Required FTEs (without Shrinkage)	79	78	81	78
3					
4					

- Make your changes, and save the template file with a different name. Return to the **Upload override** dialog box (you might need to choose **Actions, Upload plan override** to redisplay the dialog box), choose **Upload CSV**, and then choose **Override**.
- After you upload the .csv file, the metrics in the **Required FTEs (without Shrinkage)** row are automatically re-calculated and updated. Hover over the blue triangle to see the original value, as shown in the following image.

Plan Outputs		
Metric	Jan 6 - Jan 12, 2022	Jan 13
Forecasting Inputs ⓘ		
Forecasted Contact Volume ⓘ	6761	
Forecasted Average Handling Time (AHT), seconds	917	
Outputs ⓘ		
Required FTEs (without Shrinkage)	90	
Forecasted Occupancy %	50%	

Original value: 79

- The rest of the metrics are updated automatically to reflect the latest change for **Required FTEs (without Shrinkage)**.

Re-run a capacity plan

You can re-run capacity plans when you make any changes on the plan start and/or end date, or the scenario. When there are no changes to plan inputs or the scenario, the **Re-run plan** option is not active, as shown in the following image.

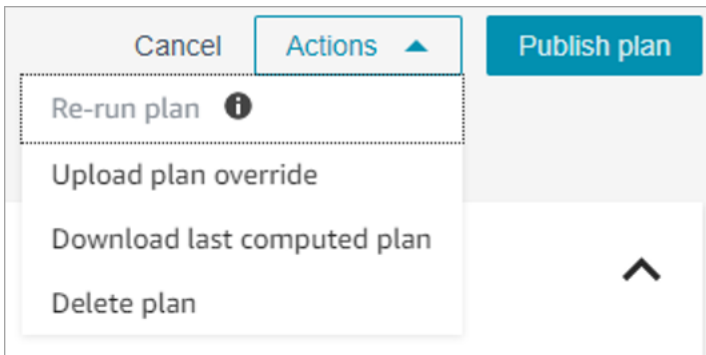

To re-run a plan

1. Go to the **Capacity Plans** tab, and choose the plan.
2. Change the start and/or end date, or select a different scenario.
3. Choose **Actions, Re-run plan**.

Download a capacity plan

When you download a capacity plan file, it downloads as a .csv file type with multiple tabs. It's helpful to open this file using Excel. The following image shows an example of what a capacity plan file looks like in Excel. It has the following worksheets: Metrics, Capacity Plan, Scenario, Generation Details.

The screenshot shows an Excel spreadsheet with the following data:

	Jan 6 - Jan 12, 2022	Jan 13 - Jan 19, 2022	Jan 20 - Jan 26, 2022	Jan 27 - Feb 2, 2022	Feb 3 - Feb 9, 2022	Feb 10 - Feb 16, 2022	Feb 17 - Feb 23, 2022	Feb 24 - Mar 2, 2022
1 Metrics								
2 Available FTEs	100	100	100	100	100	100	100	100
3 Forecasted Average Handling Time (AHT)	917	915	911	913	916	913	918	916
4 Forecasted Contact Volume	6761.177078	6727.821945	7005.703434	6683.84779	6165.038067	5886.549919	6177.246401	3341.615482
5 Forecasted Occupancy %	50%	50%	50%	50%	50%	49%	49%	47%
6 Required FTEs (without shrinkage)	79	78	81	78	72	71	74	69
7 Required FTEs (with shrinkage)	97	97	100	96	89	87	91	85
8 Required OT% (-VTO %)								
9 Gap between available FTEs and required FTEs	3	3		4	11	13	9	15
10 Gap %	3%	3%		4%	11%	13%	9%	15%

Following is a description of each worksheet:

- **Metrics:** The capacity plan output.
- **Capacity Plan:** The capacity plan metadata, such as name, starting date, and ending date of the plan.
- **Scenario:** The input defined for the capacity plan.
- **Generation Details:** The metadata indicating when someone last changed the capacity plan.

How to download capacity plan results

1. Log in to the Amazon Connect admin website with an account that has security profile permissions for **Analytics, Capacity planning - Edit**.

For more information, see [Security profile permissions for forecasting, capacity planning, and scheduling](#).

2. On the Amazon Connect navigation menu, select **Analytics and optimization, Capacity Planning**.

3. On the **Capacity Plans** tab, choose the plan.
4. On the detailed page for the capacity plan, choose **Actions, Download capacity plan**.

Publish a capacity plan

When you are satisfied with the capacity plan outputs, choose **Publish plan** to finalize your plan.

Note

You cannot edit the plan after it is published.

Your login name and the published date is displayed on the list view of the capacity plans. For example, the following image shows a plan that was first created on January 11, 2022, and then it was published on January 20, 2022 by Admin.

Date Created	Last Computed	Published Date	Published By
Jan 11, 2022	Jan 11, 2022	Jan 20, 2022	Admin

Scheduling in Amazon Connect

Contact center schedulers or managers need to create agent schedules for day-to-day workloads that are flexible and meet business and compliance requirements. Amazon Connect helps you create efficient schedules that are optimized for per-channel Service Level or Average speed of answer targets. You can generate and manage agent schedules based on the following:

- A short-term published forecast
- Shift profiles (templates for weekly shifts)
- Staffing groups (agents that can handle specific types of contacts from a specific forecast group)
- Human resources and business rules

Note

Amazon Connect scheduling is not designed to ensure compliance with any particular laws. It is your responsibility to ensure that your actions and your use of scheduling comply with

any applicable laws including employment regulations. You should confer with your legal counsel to determine your obligations.

Getting started

Following is the order of steps for creating a schedule and publishing it so supervisors and agents can view it.

1. [Add users](#) to your Amazon Connect instance.
2. Double-check with your Amazon Connect admin that users have the required security profile permissions to access scheduling features. The required permissions are described [here](#).
3. [Create staff rules for scheduling](#)
4. [Create shift activities](#)
5. [Create shift profiles](#)
6. [Create staffing groups and rules](#)
7. [Generate, review, and publish a schedule by using Schedule Manager](#)

To learn how supervisors and agents view schedules, see [How supervisors view published schedules](#) and [How agents view their schedule](#).

Scheduling roles: Who does what

There are a variety of roles for people who might create and manage schedules in a contact center, such as the following:

1. **Amazon Connect administrator** – Maintains user profiles, grants security profile permissions, sets up holiday hours for the contact center.
2. **Scheduler** – Creates manages staffing groups, creates staffing rules, configures shift components (such as creating shift activities and profiles), generates schedules, revises, and publishes schedules.

After the scheduler publishes a schedule, the supervisors and agents receive a notification in the user interface that the schedule has been published and they can view it.

3. **Supervisor** – Manages agents and schedules, updates schedules, manages requests for time off, overtime (OT), and voluntary time off (VTO).

4. **Agent** – Answers contacts, views the generated schedule, manages requests for time off, overtime (OT), and voluntary time off (VTO).

Amazon Connect provides security profile permissions that you can assign to each role, so that you can manage access to specific features by role. For more information, see [Security profile permissions for forecasting, capacity planning, and scheduling](#).

Scheduling terminology

Draft schedule

A collection of schedules for all agents in a set of staffing groups that the schedule is for.

Only schedulers can view and adjust draft schedules. Agents or their supervisors cannot view these schedules until published.

Overtime / Time off / Voluntary time off

- Requesting overtime to agents allows your contact center to handle a contact surge or agent shortages without hiring more employees.
- Requesting time off to agents allows your business to handle contacts while paying employees.
- Requesting voluntary time off to agents allows your business to handle contacts without paying employees to be idle.

Publish a schedule

An action taken by schedulers to make agent schedules formal and visible in agent and supervisor Schedule calendars (which are separate user interfaces).

Schedule

Multiple shifts tied together between the start and end dates for a specific agent.

Schedule adjustment

Before schedule publishing to supervisors or agents, the Scheduler or the person with permission can add, edit, remove, replace agent activities, or edit and remove shifts to orchestrate supply (that is, the number of agents and shift activities) vs demand (the number of contacts).

Schedule generation

The ability to generate and publish shift schedules for specific date range for a Forecast Group - Staff Group combination.

Shift activities

Daily activities that the agent does during their shift. For example, meetings, training, and lunch.

Shift profiles

The base structure of a shift, schedule window, daily shift activities that go into it.

Staffing groups

A group or team of agents who are skilled to take specific types of contacts. For example, you might create one staffing group named General Enquiry, and another named Tier 2 Support.

Create staff rules for scheduling

Use staff rules to specify optional details for individual agents and supervisors, such as their local time zone, start and end dates, and contract details.

- The individual staff rules you specify here override any staffing group rules when their schedule is generated.

For example, you might set up the staffing group to generate a schedule where everyone works 40 hours per week. In the staff rules, you can choose specific employees to schedule for 20 hours per week.

Contents

- [Create staff rules for individuals](#)
- [Import time off balance for individuals](#)

Create staff rules for individuals

1. Log in to the Amazon Connect admin website with an account that has security profile permissions for **Scheduling, Schedule manager - Edit**.

For more information, see [Assign permissions](#).

2. On the Amazon Connect navigation menu, select **Analytics and optimization, Scheduling**.
3. On the **Scheduling** page, choose the **Staff Rules** tab, and then search and choose one or more staff from the list. Every time a staff is selected, the staff count is displayed in the **Apply to Staff** button.
4. Specify optional details such as:
 - **Time zone:** Render schedules in the local time zone of the agent.
 - **Shift start and end dates:** Schedule specific agent shifts based on start or end dates.
 - **Working hours and minutes:** Define the minimum and maximum working hours per day and per week. Working hours should include non-productive time, such as breaks and meals.

For example:

- If you want to generate agent schedules that are 8 hours and 30 minutes long each day, then specify 8 hours and 30 minutes in both **min** and **max** working hour fields.
- If you want to allow the system to generate more efficient schedules, you may provide a **min** and **max** working hours window. The system will generate the most optimal schedule duration based on forecasts and agent availability.
- **Consecutive days worked or days off:** Schedule shifts based on the allowed range of consecutive days worked or days off.
- **Associate to shift profile:** You can assign a shift profile to individual agents. This is useful to do when, for example, you have part-time agents who are in the same staffing group as your full-time agents, but they require their own shift profile.

The following image shows the location of the **Associate to shift profile** dropdown menu on the **Staff rules** tab.

The screenshot shows the 'Staff rules' configuration page in Amazon Connect. The 'Apply to Staff (0)' button is highlighted with a red arrow. A dropdown menu is open, showing options to 'Associate to shift profile' with a list of profiles: 'shift profile 1', 'day shift', 'test shift profile', and 'shift profile 2'.

5. Choose **Apply to Staff**. This saves the rules, and ensures they are applied during the next scheduling cycle.

Import time off balance for individuals

For the maximum file size that you can upload, see [File size per upload of agent time off data in Forecasting, capacity planning, and scheduling feature specifications](#).

1. Log in to the Amazon Connect admin website with an account that has security profile permissions for **Scheduling, Schedule manager - Edit**.

For more information, see [Assign permissions](#).

2. On the Amazon Connect navigation menu, select **Analytics and optimization, Scheduling**.
3. On the **Scheduling** page, choose the **Staff Rules** tab.
4. Choose **Download template** and store the .csv file on your desktop. It looks similar to the following image.

	A	B	C
1	Login	Time off activity name	Time off balance in hours
2		Vacation	180.9
3		Sick day	60.5
4		Vacation	230
5		Sick day	120

5. Add data or make changes to the .csv file as needed and then save to your desktop with a new file name.
6. Choose **Upload data** to upload the .csv file. Amazon Connect does the following:

- Validates the data and provides details if there are errors.
- Prompts you for confirmation that you want to upload the data.
- Uploads the file and displays a confirmation message when complete.

After the .csv file is successfully uploaded, Amazon Connect checks the available time off balance when time off requests are submitted. If there is enough time off balance it approves the request. Otherwise, the request is declined.

- The time off balance for the requested time off type must be equal to or greater than the duration of the requested time off.

Create shift activities

Shift activities are daily activities that the staff (agents) does during their shift. For example:

- **Productive:** At work activities that agents do that are counted as productive work, such as answering contacts.
- **Non-Productive:** At work activities that agents do that are not counted as productive work, such as breaks and team meetings.
- **Time off:** Absent from work. Their status in the agent application is **Offline**.

You can create multiple shift activities to include as part of your staff shifts.

1. Log in to the Amazon Connect admin website with an account that has security profile permissions for **Scheduling, Schedule manager - Edit**.

For more information, see [Security profile permissions for forecasting, capacity planning, and scheduling](#).

2. On the Amazon Connect navigation menu, select **Analytics and optimization, Scheduling**.
3. On the **Scheduling** page, choose the **Shift Activities** tab, and then choose **Add shift activities**. Fill in the details and choose **Save**.

You can add multiple activities, and add and remove activities.

4. The next time a schedule is created as part of the scheduling cycle, the shift activities are applied.

Tip

Create shift profiles to ensure the desired sequence of the shift activities. For example, to schedule agents to go on their break two hours before lunch. For instructions, see [Create shift profiles](#).

Shift activity descriptions

The screenshot shows the 'Edit shift activities' page in Amazon Connect. The page title is 'Edit shift activities' and it includes a 'Cancel' and 'Save' button. Below the title is a description: 'Daily activities that staff do during the course of the shift, i.e. meetings, trainings, lunch, etc.' The main content is a table with the following columns: Activity name, Description (optional), Type, Hours, Minutes, Adherence, Paid, and Staff requestable. The table contains one row for 'Planned Leave' with a Type of 'Time off', Hours of '08', Minutes of '00', Adherence of 'No', and Paid of 'Yes'. The 'Staff requestable' dropdown menu is open, showing 'Yes' and 'No' options.

Activity name	Description (optional)	Type	Hours	Minutes	Adherence	Paid	Staff requestable
Planned Leave		Time off	08	00	No	Yes	Yes/No

- **Activity name:** Name of the activity
- **Description (Optional):** Additional information on the activity
- **Sub-type**
 - **If non-productive: Break or meal:** Set this subtype for breaks, lunches or meal activities. This option is only available for Non-Productive activity types. This setting allows automated break or meal time adjustments when time offs or overtimes are added or removed from staff shifts, to comply with the break rules configured in the Staffing Group and Shift Profiles.
 - **Time off: Staff Requestable:** Setting this option to **Yes** will allow agents to see and pick the respective time off activity during time off creation. Set this option to **No** for time off activities that can only be requested by supervisors on behalf of an agent.
- **Hours and minutes:** Default duration
- **Adherence:** Yes/No
- **Paid:** Yes/No

Create shift profiles

Use shift profiles to create templates for weekly shifts. The template includes the days of the week worked, the earliest start time and the latest end times the staff can be scheduled, the activities they would do during their shift, and various roles.

1. Log in to the Amazon Connect admin website with an account that has security profile permissions for **Scheduling, Schedule manager - Edit**.

For more information, see [Security profile permissions for forecasting, capacity planning, and scheduling](#).

2. On the Amazon Connect navigation menu, select **Analytics and optimization, Scheduling**.
3. Choose the **Shift Profiles** tab, and then choose **Add shift profiles**.
4. Choose a time-zone for this shift profile. This time-zone configuration will automatically adjust agent shifts for daylight saving changes. For example, an 8AM - 5PM (8:00 - 17:00) shift profile for US/Pacific time-zone will automatically switch from 8AM - 5PM (8:00 - 17:00) Pacific Standard Time to 8AM - 5PM (8:00 - 17:00) Pacific Daylight Savings Time.
5. In the **Schedule Window** section, complete the section as follows:
 - For **Work status**, choose one of the following options:
 - **Working**: This means when Amazon Connect generates the schedule, it must schedule the staff to work between the specified hours and minutes.
 - **Flex**: This means if Amazon Connect predicts enough contact volume to warrant scheduling the agent, it may schedule them to work between the specified hours and minutes.

The following image shows the **Schedule Window** section of the **Add shift profile** page.

Schedule Window

Specify what days or nights schedules must be generated for and the earliest start and the latest end times for daily shifts in US.

Day	Work status	Start Time			End Time			Shift length (Optional)	
<input type="checkbox"/> Sun	Status Working	09	:	00 AM	05	:	00 PM	Hours	Minutes
<input checked="" type="checkbox"/> Mon	Status Working	08	:	00 AM	06	:	00 PM	Hours 08	Minutes 30
<input checked="" type="checkbox"/> Tue	Status Working	08	:	00 AM	06	:	00 PM	Hours 08	Minutes 30
<input checked="" type="checkbox"/> Wed	Status Working	08	:	00 AM	06	:	00 PM	Hours 08	Minutes 30
<input checked="" type="checkbox"/> Thu	Status Flex	08	:	00 AM	06	:	00 PM	Hours 08	Minutes 30
<input checked="" type="checkbox"/> Fri	Status Flex	08	:	00 AM	06	:	00 PM	Hours 08	Minutes 30
<input type="checkbox"/> Sat	Status Working	09	:	00 AM	05	:	00 PM	Hours	Minutes

- **Start Time and End Time:** Specify the earliest start time and the latest end time for each day in the selected time zone.
- **Shift length (Optional):** Specify the maximum shift length that an agent can be scheduled on a specific day. This option is especially useful if your contact center is open for long periods of time, such as 24 hours, but each shift is shorter than that, such as 8 hours.

Depending on the contact demand pattern forecast, Amazon Connect determines the best possible start and end times for shifts, while adhering to the minimum and maximum hours per day and week worked.

6. Choose **Add shift activities**. Select the shift activities the staff will do during their shift. (You [create the shift activities](#) that appear in the list, such as Productive, Time off, and Non-Productive.)
7. For each activity, set placement rules. The rules include:
 - The time duration from the beginning to end of the shift where the activities need to be placed.
 - The time window for Amazon Connect to pick the best spot to maximize efficiency of the generated schedules to meet the goals, such as the service level percent (SL%) targets.

8. Optionally, complete the **Rules** section as follows:

⚠ Important

These rules override the settings in the **Schedule Window** section.

Choose the **Add rule** dropdown box and choose from the following options:

- **Minimum break distance**
 - **Maximum break distance**
 - **Days worked:** If you list multiple days, they are separated by OR.
 - **Days off:** If you list multiple days, they are separated by OR.
9. In the **Daily shift activities** section, complete the **Default shift activity group** section to specify when activities such as lunch breaks and training should be scheduled during the shift. The shift activities apply to everyone in the shift. In the following image, agents are scheduled for a **Break** 6 hours after starting their shift and within 7 hours.

Optionally, choose **Add new group** to add a subgroup of agents and specify shift activities for them. In the following image, the shift is 2 hours and no activities are specified. This means the agents in **Shift activity group 2** don't get a break.

10. After saving the shift profile, you can edit or remove it from the list view.

For example, if you set break to start 6 hours after the start of a shift and lunch to start 3 hours after the start of a shift, the lunch is scheduled to occur first.

Create staffing groups and rules

A *staffing group* is a group or team of agents who are skilled to take specific types of contacts. You add agents who need a schedule generated for them, and supervisors who manage agent schedules. You can also add rules that apply at the staffing group level, such as the minimum staff required and the minimum working hours per day or week for the group. If a user needs to view published agent schedules from the **Published** calendar view, then the user must be added as a supervisor within the specific staffing group.

For example, say your contact center opens at 9AM but the forecast says no contacts arrive between 9-9:30AM. You can add a rule that says, despite what the forecast predicts, there should be a minimum of one agent during this time.

If you don't have a shift start time rule, then the schedule is built using the predictions from the forecast.

For a list of staffing group limits, see [Forecasting, capacity planning, and scheduling feature specifications](#).

Example

For example, you might create one staffing group named General Enquiry, and another named Tier 2 Support. Because you map one or more staffing groups to a forecast group, here's how you would create staffing groups in this case:

1. Group all General Enquiry queues to a General Enquiry forecast group.
2. Map the General Enquiry forecast group to multiple staffing groups that have agents who can take general enquiry contacts.

Create group and add staff

1. Log in to the Amazon Connect admin website with an account that has security profile permissions for **Scheduling, Schedule manager - Edit**.

For more information, see [Security profile permissions for forecasting, capacity planning, and scheduling](#).

2. On the Amazon Connect navigation menu, select **Analytics and optimization, Scheduling**.
3. Choose the **Staffing Groups** tab, and then choose **Create staffing group**.
4. On the **Create Staffing Group** page, under **Associate to forecast group**, use the dropdown to choose the forecast group to associate with this staffing group.

In the following example, contacts from the queues in the Forecast_Group_20220124 will be routed to the agents in this staffing group.

5. Choose **Add staff** to add agents and supervisors to this staffing group. Only names for Amazon Connect users appear in the list of staff. The following image shows the name Jane Doe, which can be added to the agent list.

Add staff ✕

Add to agent list
 Add to supervisor list

🔍 Search staff

Name	Login
<input type="checkbox"/> Doe, Jane	zzDoeJ

Tip

Every agent must be in a staffing group in order for a schedule to be generated for them. You can add and remove agents in between schedule cycles and manually add shifts.

Even after an agent is in a staffing group, you can assign them their own shift profile by using the **Staff rules** tab. The agent-level shift profile overrides the profile set at the staffing group level. For more information, see [Create staff rules for scheduling](#).

Add rules

To generate a schedule, Amazon Connect uses information from the forecast group, which reflects the historical demand pattern for your contact center. Staffing rules enable you to specify conditions that must be accounted for in the schedule, regardless of what the forecast predicts.

For example, your contact center opens at 9AM but the forecast says no contacts arrive between 9AM-9:30AM. You can add a rule that, despite what the forecast predicts based on historical demand, there should be a minimum of one agent during this time. This forces Amazon Connect to keep one agent in the schedule from 9-9:30AM. In addition, you can add a rule to set the **Working Hours** to start at 9AM, even though the forecast would start it at 9:30AM.

To add rules

- In the **Rules** section, choose **+** and then use the dropdown to choose the type of rule to create for the staffing group. For example, you can specify:

- **Minimum Staff Required:** Specify the minimum number of agents that should be available, despite what the forecast indicates. For example, if the forecast says that you do not need any agents in the first half hour that your contact center opens, you can ensure that there is a minimum of one agent during this time.
- **Shift Start Time: Same Start Time:** This creates schedules with the same shift start time for all agents.
- **Working Hours:** Specify the group's minimum and maximum working hours per day or week. This setting applies to all staff in the staffing group. You can override this setting for individual staff. For instructions, see [Create staff rules for scheduling](#).

Generate, review, and publish a schedule by using Schedule Manager

Amazon Connect is designed to generate the least number of shifts for agents based on the forecasted demand pattern and configured constraints to hit the optimization goal.

After you create shift activities, shift profiles, staffing groups and staffing group rules, you can generate a schedule.

1. Log in to the Amazon Connect admin website with an account that has security profile permissions for **Scheduling, Schedule manager - Edit**.

For more information, see [Security profile permissions for forecasting, capacity planning, and scheduling](#).

2. On the Amazon Connect navigation menu, select **Analytics and optimization, Scheduling**.
3. Choose the **Schedule Manager** tab, and then choose **Generate schedule**.
4. Enter a name and description for the schedule.
5. In the **Schedule input** section, select the forecast group from the dropdown menu.

Currently you cannot schedule for multiple forecast groups.

6. Specify the duration of the schedule - the start and end dates. You can schedule up to 18 weeks out.
7. Under **Optimize schedule for**, choose **Service level** or **Average speed of answer**.
8. Average speed of answer (ASA) is an alternative to using service level percentage targets. For example, the following image shows an ASA set to 30 seconds. The capacity planning and scheduling system will optimize headcount / schedules to ensure that the goal is met.

Scheduling: Schedule manager

Generate Schedule

Schedule manager helps you generate, modify and publish draft schedules.

Cancel [Generate schedule](#)

Schedule name _____ Description (Optional) _____

Schedule input

Select forecast group ▼

Start date 11 / 01 / 2022 End date 11 / 30 / 2022

Optimize schedule for

Service level

Average speed of answer

30 seconds within patience of 5 minutes of Voice

Select Channel ▼

[+ Add another goal](#)

9. Choose **Generate schedule**.

Note

Amazon Connect generates a draft schedule. It will not be visible to agents or supervisors until you publish it.

10. In the list of schedules, the schedule you created shows a status of **In progress**. It takes 5-30 minutes to generate, depending on the number of agents, number of configured rules, schedule duration, and more. After the schedule is generated, it's status is **Complete** or **Failed**.
11. To view any warnings, breaches of rules, or constraints breaches, choose the warnings icon, as shown in the following image. More information about the warnings is displayed.

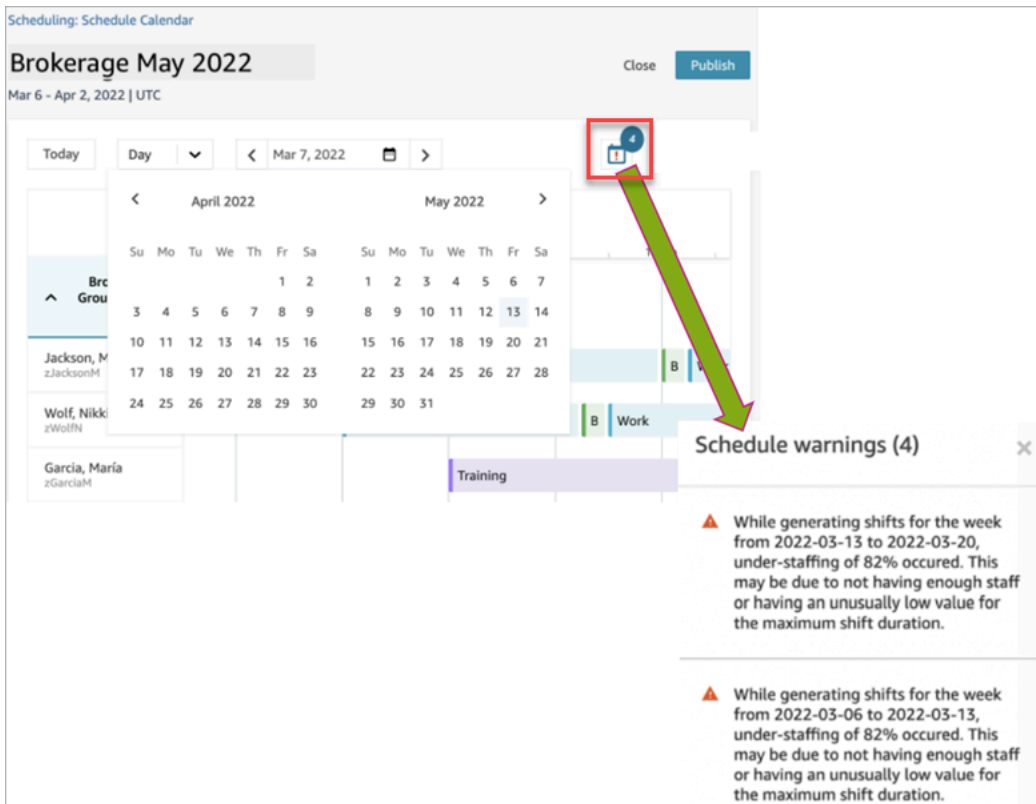

12. When the status is **Complete**, choose the draft schedule to view it. The following image shows a sample schedule for one day, for 10 agents.

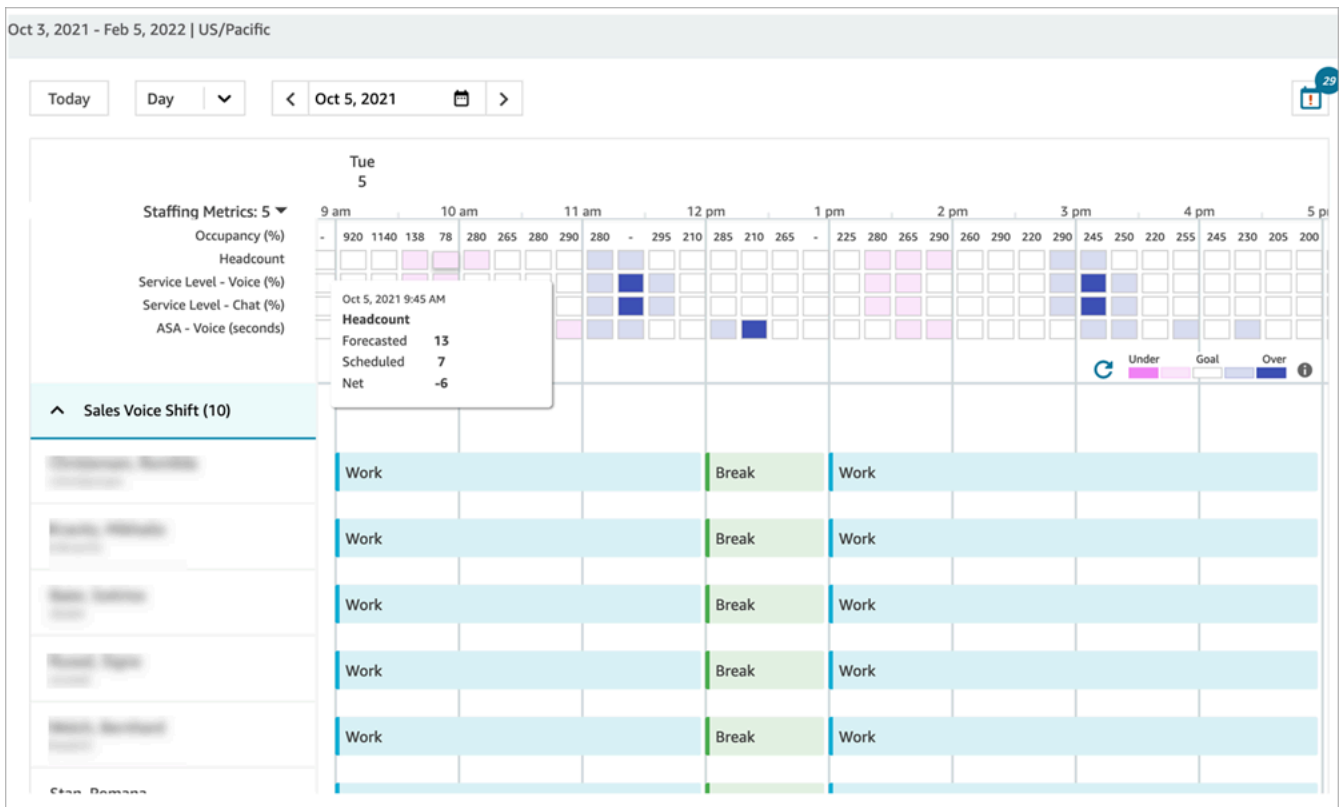

Schedulers can:

- View schedules for all agents.
- Pick a date to view a specific shift.
- Navigate back to today's date.
- View failed rules and goals.

13. When you're satisfied with the schedule, choose **Publish**. You'll get a confirmation page. Choose **Proceed** to make the schedule official!

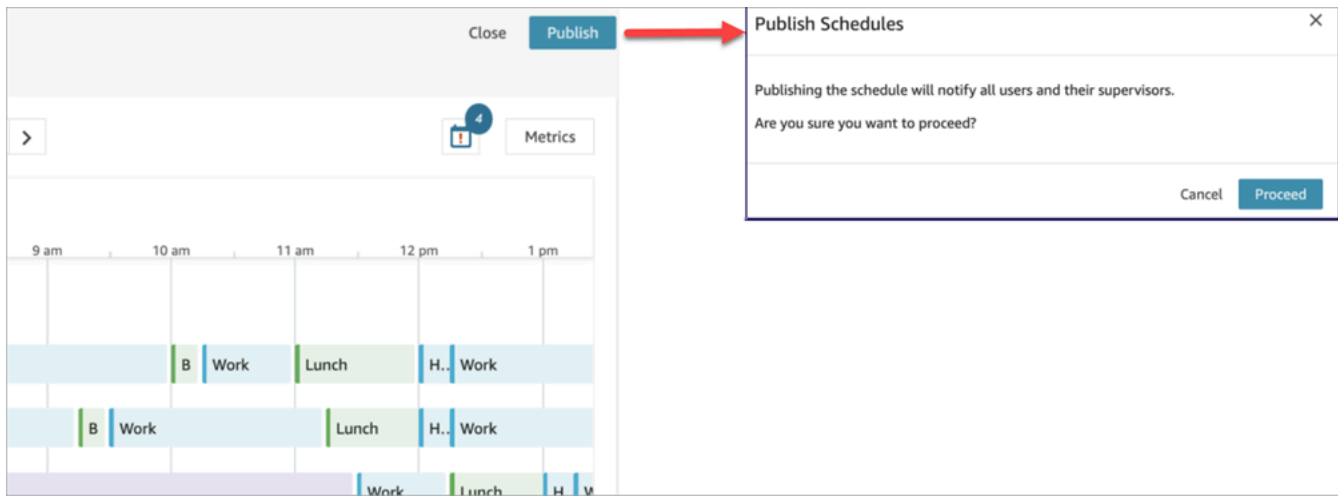

Staff (agents) and supervisors specified in the staffing groups can now view the schedule. See the following topics to learn about their experience:

- [How supervisors view published schedules](#)
- [How agents view their schedule](#)

Edit a schedule

Before publishing a schedule, you might want to edit it. For example, if you notice that all the agents are scheduled to be on break at the same time and no one is scheduled to take contacts.

You can:

- Change agent shift start and/or end time, duration.
- Change activity shift start and/or end time, duration.
- Add an activity to one or more agents shift.

- Remove or replace activity from an agent shift.
- Copy an entire shift from one agent to another.
- Recompute metrics to ensure schedule adjustments result in better service level (SL%) or occupancy.

The following image shows these options in the dropdown list: **Edit, Add, Replace, Remove, Copy.**

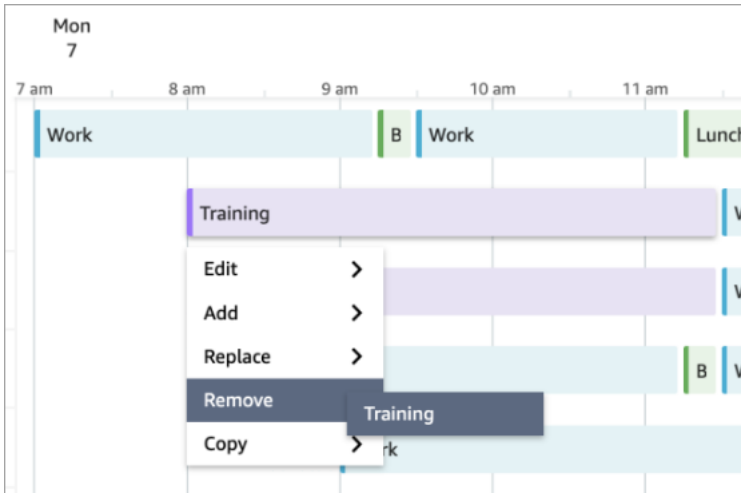

Regenerate a schedule

Managers and supervisors can regenerate agent schedules for up to six different forecast groups after making changes to the scheduling configuration.

1. To edit a schedule, select the schedule, choose **Actions**, and select **Edit Schedules**. Make your changes and choose **Save**.
2. To regenerate one or more schedules, select the schedules you want to regenerate, choose **Actions**, and select **Regenerate schedules**.

Search and sort a schedule

Managers and supervisors can search and sort schedules from within the schedule manager. Schedulers can search for schedule names using partial keywords or sort the schedule list based on start date, end date, creation date, or updated date.

The following image shows the search box on the **Scheduling** page. Entering **mar** returns schedules that have March in their name.

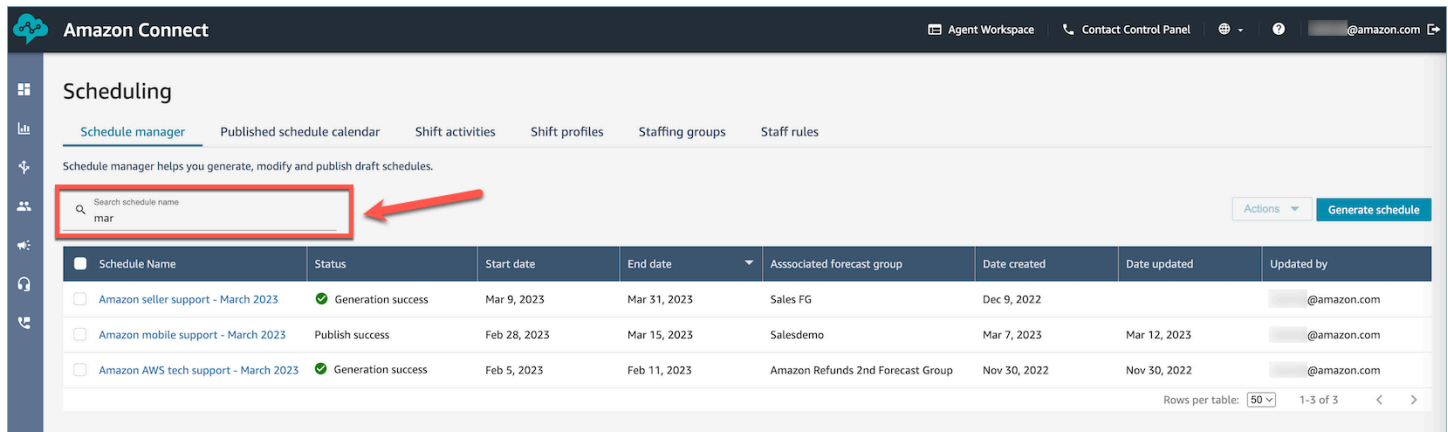

Scheduling

Schedule manager Published schedule calendar Shift activities Shift profiles Staffing groups Staff rules

Schedule manager helps you generate, modify and publish draft schedules.

Search schedule name
mar

Actions Generate schedule

Schedule Name	Status	Start date	End date	Associated forecast group	Date created	Date updated	Updated by
Amazon seller support - March 2023	Generation success	Mar 9, 2023	Mar 31, 2023	Sales FG	Dec 9, 2022		@amazon.com
Amazon mobile support - March 2023	Publish success	Feb 28, 2023	Mar 15, 2023	Salesdemo	Mar 7, 2023	Mar 12, 2023	@amazon.com
Amazon AWS tech support - March 2023	Generation success	Feb 5, 2023	Feb 11, 2023	Amazon Refunds 2nd Forecast Group	Nov 30, 2022	Nov 30, 2022	@amazon.com

Rows per table: 50 1-3 of 3

How supervisors view published schedules

After a scheduler publishes a schedule, it's official. Agents can now view their individual scheduling using their agent application. Supervisors can also view their agents schedules using the Amazon Connect admin website.

Supervisors with **Scheduling, Schedule manager - Edit** permissions in their security profile can edit agent schedules.

Important

When a supervisor edits an agent schedule and publishes it, the change appears immediately to the agent. They do not need to refresh their browser for the agent application to reflect the change.

The following image shows a sample schedule for a supervisor's team.

The screenshot displays the Amazon Connect Scheduling interface. At the top, there are navigation tabs: "Schedule manager", "Published schedule calendar" (selected), "Shift activities", "Shift profiles", "Staffing groups", and "Staff rules". Below these, the "Forecast group" is set to "Amazon Refunds 2nd Forecast Group" and the location is "US/Pacific, UTC-08:00".

The main area shows a calendar for Tuesday, February 7, 2023. A search bar at the top left contains "sa1". A dropdown menu is open, showing options for "Name and login" and "Staffing group". The calendar grid shows staffing metrics (Occupancy, Headcount, Service Level) and individual agent schedules. Agents listed include Bailey, Nikki; Giri, Rani; Major, Mary; Li, Juan; Jayashankar, Nikhil; Kaimal, Sam; Rosalez, Alejandro; Salazar, Carlos; Jone, Rony; Ratel, Alexandre; Rozario, Reiter; Doe, Jane; Carolina, Silvia Ana; and Frederick, Samuel. Each agent's schedule is represented by colored bars indicating work, break, lunch, meal, and overtime periods.

Managers and supervisors can sort or filter schedules based on the following criteria.

- **Sort** schedules based on the earliest shift start time. For example, the agents who would login first to take customer contacts will show up on top. The following example displays a manager or supervisor who searches for agents by first name, last name, or login ID with the string sa1, sorted by their shift start times.

The screenshot displays the Amazon Connect Scheduling interface. At the top, there are navigation tabs: 'Schedule manager', 'Published schedule calendar' (selected), 'Shift activities', 'Shift profiles', 'Staffing groups', and 'Staff rules'. Below these, the 'Forecast group' is set to 'Amazon Refunds 2nd Forecast Group' with a location of 'US/Pacific, UTC-08:00'. A search bar contains 'sal', and there are controls for 'Today', 'Day', and navigation arrows for 'Feb 7, 2023'. A 'Sort by' dropdown and 'Add filter' button are also present. The main area is a calendar grid for Tuesday, Feb 7, 2023, showing staffing metrics (Occupancy, Headcount, Service Level) and agent schedules for Rosalez, Alejandro and Salazar, Carlos. A 'Staffing groups' dropdown is open, showing 'Start time'.

- **Filter** schedules based on agent names or agent IDs, Staffing Groups, or Supervisor names.

The screenshot displays the Amazon Connect Scheduling interface with a search filter applied. The search bar contains 'Search by name or login'. A dropdown menu is open, showing a list of agent names and IDs: Bailey, Nikki, Alejandro, Rosalez, Salazar, Carlos, and Li, Juan. The calendar grid shows staffing metrics and agent schedules for Bailey, Nikki, Li, Juan, Rosalez, Alejandro, and Salazar, Carlos. A search dropdown is open, showing a list of agent names and IDs.

How agents view their schedule

There are two ways agents can access their schedules:

- If your organization uses the Amazon Connect agent application, agents access their schedule by entering **<https://instance name/connect/agent-app-v2/>** into their browser and then choosing the calendar icon.
- If your organization uses the Contact Control Panel (CCPv1 or CCPv2), Salesforce CTI, or a custom-built agent desktop, agents access their schedule by entering **<https://instance name/connect/agent-app-v2/scheduling>** into their browser, logging into Amazon Connect, and then choosing the calendar icon.

Following are steps agents use to view their schedule in the agent application.

1. Log on to the agent application using the URL that your admin gives you.
2. Choose the Calendar icon on the application navigation bar to launch the staff schedule manager viewer. Otherwise, the staff schedule manager viewer launches automatically.

The following image shows a sample schedule in the agent application.

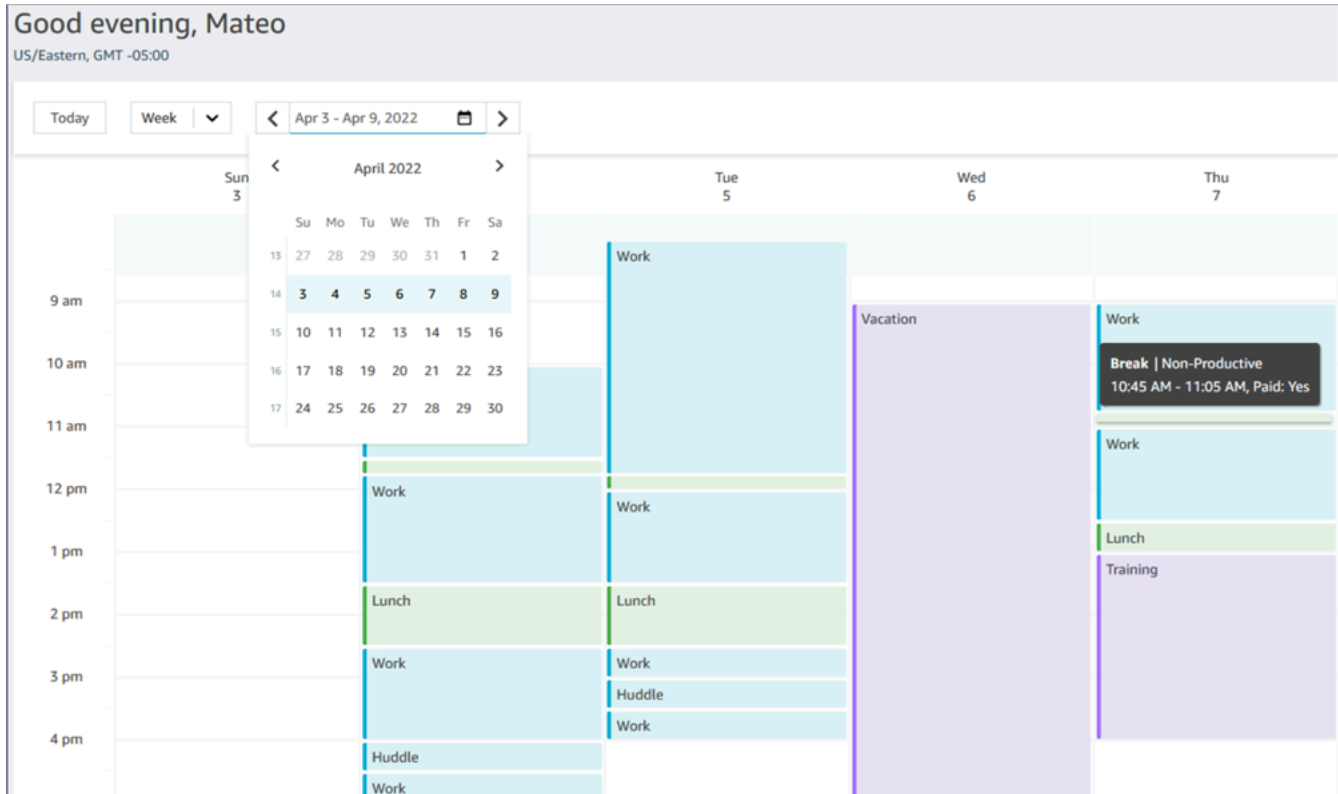

You can see a daily or weekly view of your schedule.

Add shift activities in draft or published schedules

Amazon Connect scheduling allows contact center managers, supervisors, and schedulers to insert activities into agent schedules, both draft and published. For example, activities such as team meetings, 1:1 coaching sessions, and trainings can be added into an agent's schedule.

Add a shift activity

1. Choose the agents you wish to include in the activity by selecting the check-boxes next to their names.
2. Choose the **Actions** drop-down and select **Add Shift Activity**. This action will bring up the **Add Shift Activity** screen, populated with all the agents you selected in the previous step.
 - An alternative way to access the **Add Shift Activity** screen is as follows: choose any agent's shift, then select **Add**, followed by **Activity**. This will open the **Add Shift Activity** pop-up screen, displaying the shift of the agent you initially chose. To include additional agents in the activity, choose **Edit staff**.

The screenshot displays the Amazon Connect Scheduling: Schedule calendar interface. The main view is a calendar for 'US-west-schedule' covering the period from Feb 27, 2023, to May 30, 2023. The interface includes a search bar, navigation controls (Today, Day, Feb 27, 2023, Sort by, Add filter), and a grid showing staffing metrics (Occupancy, Headcount, Service Level) and activity bars for various agents. A red box highlights the 'Add shift activity' button in the top right corner. Another red box highlights a context menu for an activity, with 'Add Activity' selected. The calendar grid shows staffing metrics and activity bars for various agents.

3. Select a shift activity from the drop-down.
4. Select an activity type of **Shared** or **Individual**:
 - a. **Shared** activity: A singular occurrence of the activity is shared among all participating agents. Any modifications made to the activity, such as adjustments to the date or time, will apply to all agents simultaneously.
 - b. **Individual** activity: Separate instances of the activity will be created for each individual agent. Any modifications made to the activity, such as adjustments to the date or time, will apply to an individual agent.
5. Select the date and time for the activity.
6. Select **Override rules check** if you want the system to ignore rules such as the minimum and maximum working hours exceeded. If unselected, any agent who violates rules due to the addition of this activity will be excluded from the activity. You can review the list of agents that didn't meet the criteria and the specific reasons for their exclusion in the **Actions log**.
7. Enter any note in the provided **Comment** text box.
8. Choose **Apply** to add the activity to agent schedules.

9. Adding activities to agent schedules using the **Optimize shifts for breaks or meals** option may take a few minutes to process. You can monitor the progress in the **Actions log**, where the status will transition from **In progress** to **Complete**.

Note

The **Actions log** is designed to track the status of long running actions, such as adding a shift activity with optimization. The **Actions log** does not track all changes made to schedules.

Edit a shift activity

1. From an agent's shift, choose the activity, select **Edit**, and then select the activity name to open the edit activity screen.
2. If the activity was added as a **Shared activity**, then all of the agents added to the activity will be listed under **Staff**.
 - a. From here, you can add or remove agents, change the date or time of the activity, apply the **Override rules check**, apply **Optimize shifts for breaks or meals** again as needed, and add or update **Comments**.
 - b. Choose **Apply** to commit the changes.
3. If the activity was added as an **Individual activity**, then only the agent whose shift you chose will be listed under **Staff**.
 - a. From here, you can: change the date or time of the activity, apply the **Override rules check**, apply **Optimize shifts for breaks or meals** again as needed, and add or update **Comments**.
 - b. Choose **Apply** to commit the changes.

The screenshot displays the Amazon Connect Scheduling: Schedule calendar for the 'US-west-schedule'. The calendar view is for Tuesday, Feb 27, 2023, showing a grid of activities for various agents. A context menu is open over a 'Meeting' activity, with the 'Remove' option highlighted. The menu also includes 'Edit', 'Add', 'Replace', and 'Copy'. The interface includes a search bar, navigation controls, and a list of agents on the left.

Remove a shift activity

1. From an agent's shift, choose the activity, select **Remove**, and then select the activity name to open the remove activity screen.
2. Choose **Override rules check** or **Optimize shifts for breaks or meals** options as needed.
3. Choose **Remove** to remove the activity.

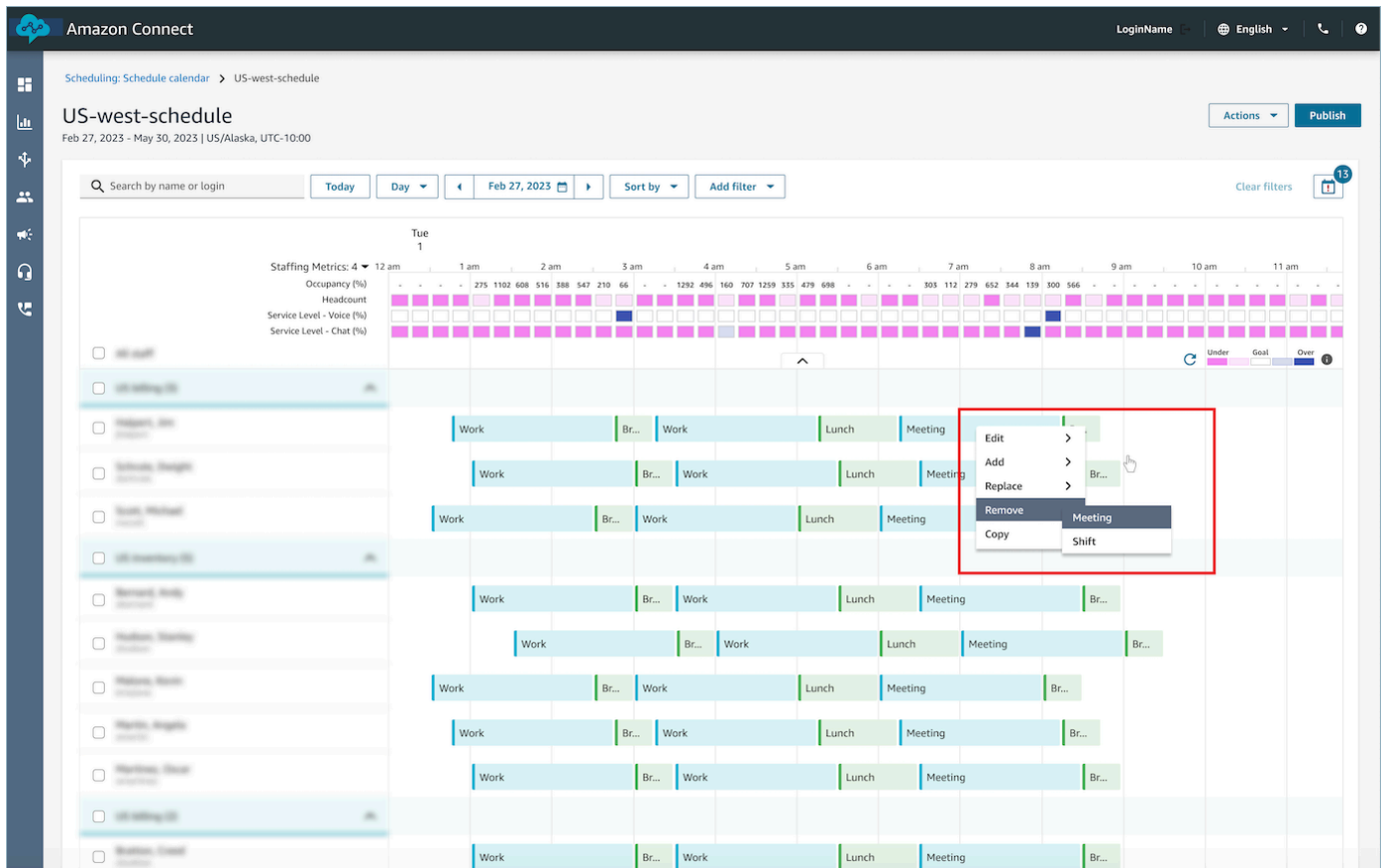

Time off management

With Amazon Connect time off management capabilities, you can manage agent time off requests that comply with pre-configured regional labor and business rules.

Administrators or managers with the appropriate security profile permissions can configure the time off settings. Amazon Connect automatically approves or rejects requests depending on how you've configured both the time off rules and the daily maximum allowed time off hours.

Supervisors or managers with permissions can view agent time off requests and override automatically approved or rejected time off.

Contents

- [Enable time off](#)
- [Set group allowance for time off](#)
- [Create a time off request](#)
- [Import an agent's time off balance in a .csv file](#)

- [Manager and Agent view request drawer](#)
- [Update / Cancel](#)

Enable time off

You enable time off management for each staffing group. The following image shows the **Request management** section of the **Edit staffing group** page where you configure time off settings.

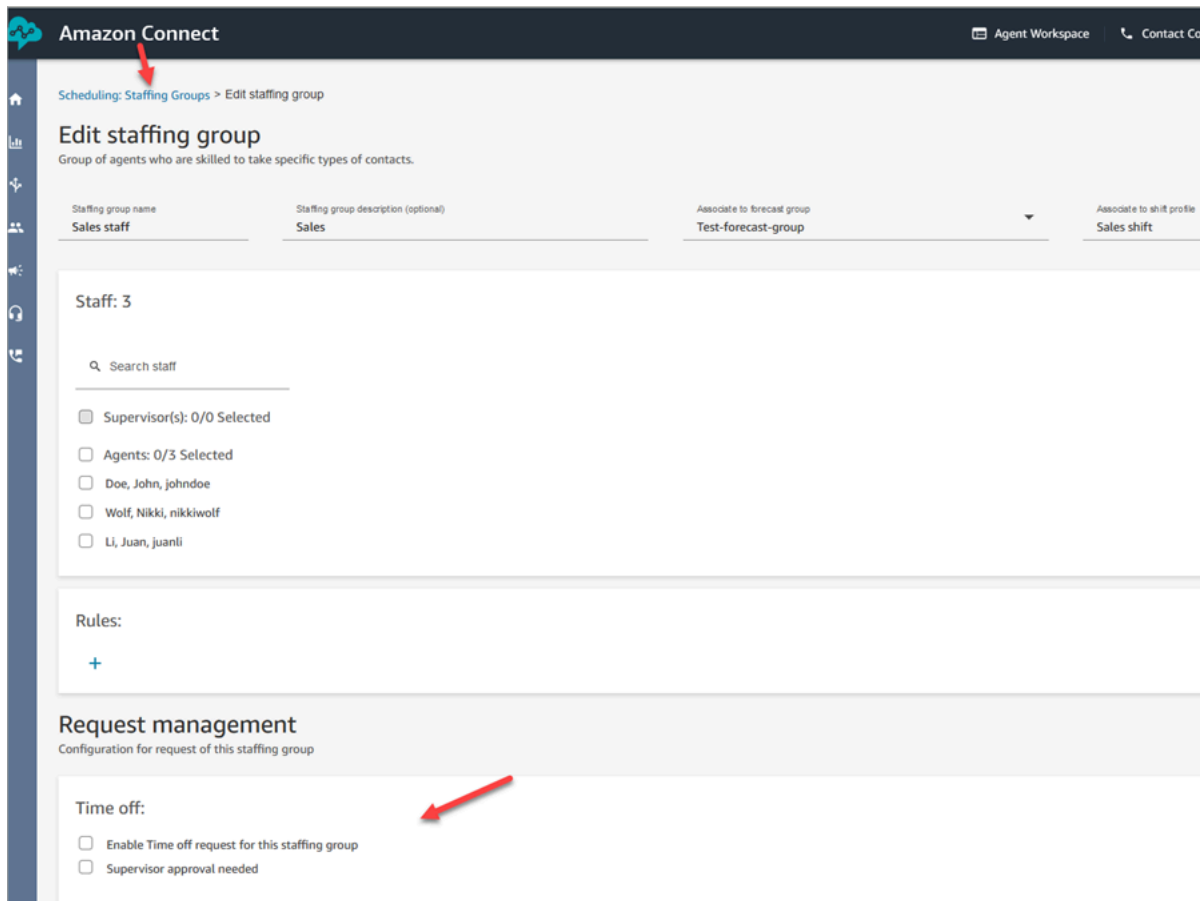

Choose from the following options:

- **Enable Time off request for this staffing group:** This option enables the time off management feature for this group of agents and supervisors. Time offs are automatically approved or rejected based on the availability of [time off allowance](#).

After you choose this option:

- Agents can see the **Time off** widget on the agent application. (Agents also require the **Agent application schedule calendar - Edit** security profile permission to see the widget.)

The following image shows an example of the **Time off** widget on the agent application.

The screenshot displays the agent application interface. At the top, it says "Good afternoon, Rani" and "US/Pacific, GMT -07:00". Below this is a navigation bar with "Today", "Week", and a date range "Jun 11 - Jun 17, 2023". The main area is a calendar grid for the week of June 11-14, 2023, with time slots from 12 am to 6 am. A "Time off" widget is highlighted with a red box, showing a calendar icon and a "Time off" button. Below the widget is a large blue "X" button. To the right, a "Request Time off" modal is open, showing the following details:

- Staff: Giri, Rani
- Type: Casual Leave time off (dropdown menu)
- Type: Time off, Paid: No, Adherence: No
- All day:
- Starts: Jun 13, 2023, 09 : 00 AM
- Ends: Jun 13, 2023, 05 : 00 PM
- Reason: Taking my family out on a day trip.

At the bottom of the modal are "Cancel" and "Request" buttons.

- Supervisors can see the **Make request** button on the **Published schedule calendar** page. Pending and completed requests are visible in the [request drawer](#).

The following image shows the location of the **Make request** button on the **Published schedule calendar** page.

The screenshot shows the Amazon Connect Scheduling interface. The 'Published schedule calendar' tab is selected. The forecast group is set to '-fg' and the time zone is 'US/Eastern, UTC-05:00'. The calendar view is for Wednesday, Nov 23, 2022. A 'Make request' button is highlighted with a red box and a red arrow pointing to it from the left. The button has a calendar icon and the text 'Make request'. The interface also displays staffing metrics, occupancy, headcount, and service level data for the selected date.

- **Supervisor approval needed:** Choose this option if supervisors need to review every timeoff request, regardless of available balances. Supervisors will need to manually approve or decline all agent time off requests before they are added to the schedule.

If this option is **not** selected for the staffing group, then a request that meets **both** of the following criteria is auto-approved:

- The request is within the agent's available time off balance.
- The request is within the [group allowance](#) set by the business for the specified time period.

Requests that are not auto-approved are displayed as follows:

- **Supervisor drawer:** Requests are listed for manual approval. The supervisor has the option to choose **Override time off rules** to override any allowances configured for the agent or group allowance. The following image shows a list of time off requests in the supervisor drawer.

- Agent application: Requests are displayed as **Awaiting Approval**.

Assign security profile permissions to agents so they can request time off

The agent's security profile needs to include the following permissions so they can access the **Time off** widget on their schedule:

- **Agent Applications - Agent application schedule calendar - Edit**

If the agent has only **View** permissions, the **Time off** widget does not appear in the agent schedule.

For more information about the agent's experience, see [Agent initiated time off request](#).

Set group allowance for time off

Managers can set the maximum time off hours that agents combined can take within the Forecast Group: by hour, for each calendar day, for specific time off activities.

You use a .csv file to quickly specify time off allowances at a hourly level, for up to 13 months. For example, you might specify Vacation, Personal time off, Casual, and other time off types that you specified when you [created shift activities](#).

Tip

IT admins: For the endpoints to add to your proxy exception list for this feature, see [Allow upload of time-off balances and allowances in Amazon Connect scheduling](#).

Contents

- [Download the time off .csv template](#)
- [Download time off for a forecast group](#)
- [Import group allowance .csv file](#)
- [Example of using the time off allowances feature](#)

Download the time off .csv template

1. On the **Scheduling** page, choose the **Time off** tab.
2. On the **Download** dropdown menu, choose **Download template**.

The following image shows an example .csv template that contains valid data.

Forecast Group	Time off activities	Start time	End time	Group allowance hours
Group 1	Vacation Personal time off Performance award time off	2023-06-01T08:00:00	2023-06-01T09:00:00	350
Group 1	Vacation Personal time off Performance award time off	2023-06-01T09:00:00	2023-06-01T10:00:00	300
Group 1	Vacation Personal time off Performance award time off	2023-06-01T10:00:00	2023-06-01T11:00:00	400

Do not change the top row of the .csv file

Separate time off types with two ||

This is June 1, 2023, 11:00AM

3. When you add your time off data to the template, note the following:
 - Do not change the top row of the .csv file template.
 - In the **Time off activities** column, separate multiple activities with two pipes **||**.
 - The **Start time** and **End time** must have a one-hour duration and set as multiples of 15 minutes. If they do not meet these criteria, the validation will fail when you attempt to upload your .csv file. The example below shows the error message that you might encounter:

Column START_TIME value [2023-08-15T05:01:00] is not a multiple of 15 minutes from top of the hour, such as HH:00, HH:15, HH:30 and HH:45

Download time off for a forecast group

1. On the **Scheduling** page, choose the **Time off** tab.
2. Choose one or more forecast groups that you want in the download csv file.

- On the **Download** dropdown menu, choose **Current group allowance balance**, as shown in the following image.

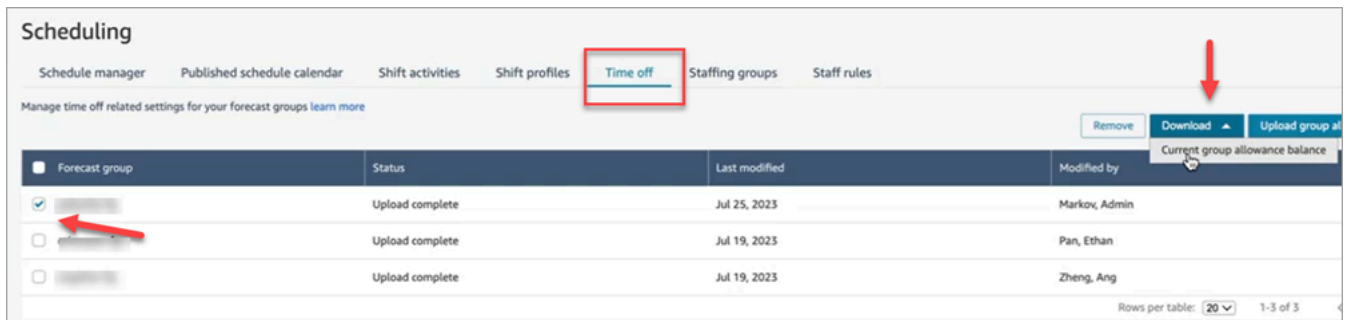

The .csv file includes the data that was last uploaded to Amazon Connect. For example, the following image shows the download time off allowance .csv file.

- LAST_UPLOADED_GROUP_ALLOWANCE_IN_HOURS:** The last upload for Group 1 was 4.4 hours of vacation.
- GROUP_ALLOWANCE_IN_HOURS** shows they have 2.4 hours remaining in their allowance, they've already used 2 hours.

	A	B	C	D	E	F
1	FORECAST_GROUP	TIME_OFF_ACTIVITIES	START_TIME	END_TIME	GROUP_ALLOWANCE_IN_HOURS	LAST_UPLOADED_GROUP_ALLOWANCE_IN_HOURS
2	Group 1	Vacation	2023-07-12T00:00:00	2023-07-12T01:00:00	2.4	4.4
3						
4						

Annotations in the image:

- A red box highlights the value 2.4 in column E, with the text: "Group 1 has 2.4 hours left because they've already taken 2 hours".
- A red box highlights the value 4.4 in column F, with the text: "Group 1 is allowed 4.4 hours off for vacation".

Import group allowance .csv file

When you upload a .csv file that contains the time off allowance for a forecast group, it overwrites data already in Amazon Connect. For example, if you have 100 agents, and a supervisor uploads data for 20 agents, the data for those 20 agents is overwritten.

For the maximum file size that you can upload, see *File size per upload of time off group allowance data* in [Forecasting, capacity planning, and scheduling feature specifications](#).

- On the **Scheduling** page, choose the **Time off** tab.
- Choose the Forecast group the group allowance applies to, and then choose **Upload group allowance**. Amazon Connect does the following:

- Validates the data and provides details if there are errors.
- Prompts you for confirmation that you want to upload the data.
- Uploads the file and displays a confirmation message when complete.

Example of using the time off allowances feature

For example, your business provides time off in December. Here's how you might use the time off allowances feature:

- Managers can allow a group of agents to take *casual leave* and *regular P.T.O* that add up to a maximum of 12 hours on December 20th, from 9AM to 9PM.
- They can automatically decline those types of time off requests on December 22nd by giving a value of 0 - Zero hours.
- Adding value 0 allows them to specify blocked days. Amazon Connect ignores a group allowance check if no value is specified.

This allows the workforce managers to balance an agent's personal time off needs with business headcount needs.

Create a time off request

Supervisor or manager initiated time off request

1. Supervisors or managers can go to the **Published schedule calendar** view, choose the floating icon on the bottom left and create a time off request. The request drawer opens on the right.

The screenshot shows the Amazon Connect Scheduling interface. A 'Request Time off' modal is open, allowing an agent to request time off. The modal includes the following fields and options:

- Staff:** Search for 'Nikki, Wolfe'.
- Type:** Search for 'Sick day off'.
- Type details:** Time off, Paid: No, Adherence: No.
- All day:** Unchecked.
- Starts:** Nov 21, 2022, 09:00 AM.
- Ends:** Nov 21, 2022, 06:00 PM.
- Override time off rules:** Checked.
- Reason:** Text input field containing 'Nikki was out sick.'.
- Buttons:** 'Cancel' and 'Request' (highlighted in red).

2. Select **Staff** and the time off **Type**. To select a time off range, you can either select **All day** or select specific start and end date times. Select **Override time off rules** if you wish to override the system and allow time off while dismissing group allowance and other rules specified in Staff, Staffing Group or Shift profile rules. Enter a **Reason** and choose **Request**.
3. The request will enter a *pending* state to allow the system to analyze existing rules (even though rules checks are overridden) and will display a list of any rule failures.
4. The agent will see the pending request in their schedule UI and will receive an in-app notification next to the **Request** icon which displays as an inbox icon at the top right above the metrics view. This allows the agent to view the request details under the **Time off** tab.
5. After the rules validation completes, the time off request status of **Approved** or **Rejected** will be displayed in both the agent and supervisor views.

Tip

When Amazon Connect evaluates time off requests, it factors in the [Forecast group allowance for time off](#) and the [individual agent's allowance for time off](#), if they've been specified.

Agent initiated time off request

Agents can go to the schedule calendar view and choose the floating icon to create a time off request. The request drawer opens and allows the agent to enter details related to their time off request.

Good afternoon, Rani
US/Pacific, GMT -07:00

Today Week Jun 11 - Jun 17, 2023

Sun 11 Mon 12 Tue 13 Wed 14

12 am
1 am
2 am
3 am
4 am
5 am
6 am

Time off

Request Time off

Staff Giri, Rani

Type Q Casual Leave time off X

Type: Time off, Paid: No, Adherence: No

All day

Starts Jun 13, 2023 09 : 00 AM

Ends Jun 13, 2023 05 : 00 PM

Reason Taking my family out on a day trip.

Cancel Request

Import an agent's time off balance in a .csv file

You can import or export a .csv file of an agent's time off balance. For example, you may download the time off balance from your HR system and then upload it to Amazon Connect.

Amazon Connect uses the time off balance to automatically approve or decline time off requests based on the agent's available net balance.

For the maximum file size that you can upload, see *File size per upload of agent time off data* in [Forecasting, capacity planning, and scheduling feature specifications](#).

Tip

IT admins: For the endpoints to add to your proxy exception list for this feature, see [Allow upload of time-off balances and allowances in Amazon Connect scheduling](#).

1. Log in to the Amazon Connect admin website with an account that has security profile permissions for **Scheduling, Schedule manager - Edit**.

For more information, see [Assign permissions](#).

2. On the Amazon Connect navigation menu, select **Analytics and optimization, Scheduling**.

3. On the **Scheduling** page, choose the **Staff Rules** tab.
4. Choose **Download template** and store the .csv file on your desktop. It looks similar to the following image.

	A	B	C
1	Login	Time off activity name	Time off balance in hours
2		Vacation	180.9
3		Sick day	60.5
4		Vacation	230
5		Sick day	120

5. Add data or make changes to the .csv file as needed and then save to your desktop with a new file name.
6. Choose **Upload data** to upload the .csv file. Amazon Connect does the following:
 - Validates the data and provides details if there are errors.
 - Prompts you for confirmation that you want to upload the data.
 - Uploads the file and displays a confirmation message when complete.

After the .csv file is successfully uploaded, Amazon Connect checks the available time off balance when time off requests are submitted. If there is enough time off balance it approves the request. Otherwise, the request is declined.

- The time off balance for the requested time off type must be equal to or greater than the duration of the requested time off.

Download snapshot

Choose **Download snapshot** to download the full set of the last uploaded time off balance and the net time off balance as of the time of download.

How the system calculates time off deductions

When a staff's time off is approved, the following logic is used to calculate how many hours are deducted from both the staff's time off balance and the group allowance balance:

- If the approved time off period overlaps with one or more staff shifts, then:
 - The system derives the deductible time off hours by taking the total number of overlapped hours and subtracting the duration of shift activities which have the setting **Deduct from time off balance** as **Yes**.

- If the approved time off period does not have staff shifts that overlap because the schedule for that time period has not been published yet, then:
 - The system would check if the staff is scheduled to work on that day based on the shift profile **Day** (check-box) setting.
 - If the staff is not scheduled to work on this day, or if the approved time off is outside of the configured shift profile time window, then no time off hours will be deducted.
 - If the staff is scheduled to work on that specific day, the system determines the effective shift length based on the configured shift profile. If the shift length is not explicitly set in the profile, the system defaults to the minimum value between the maximum working hours defined in the **Staff Rules** for that staff and the shift window duration specified in the shift profile, effectively setting the effective shift length. In the event that there is no **Maximum working hours** defined for the staff, the system resorts to the shift window duration assigned within the staff's specific shift profile.
 - Based on this effective shift duration, the system would then determine which shift activity group would be used to schedule shifts, and then subtract the duration of all shift activities in this group which have the setting **Deduct from time off balance** as **Yes**.

Time off deduction logic examples

Workforce managers and supervisors can specify which shift activities, in addition to default work activities, will be counted towards their agents' time-off balance. The following highlights an example of this feature:

There are two time offs configured:

- Vacation time - activity name: VACAY_SK
- Sick time - activity name: SICK_SK

Agent 1 has a vacation (VACAY_SK) balance of 30 hours.

Agent 2 has a sick (SICK_SK) balance of 12 hours.

Agent 3 has a vacation (VACAY_SK) balance of 15 hours.

Agent 1, 2 and 3 have a 6 hours shift. In these shifts, there is a 30 minute **Break** activity for which **Deduct from time off balance** is set to **NO**.

Scenarios

- Agent 1 requested an all day time off (VACAY_SK). Once time off is approved, the system will deduct 5 hours 30 minutes from the current time off balance of 30 hours. 30 minutes for the **Break** activity will not be deducted because the shift activity flag **Deduct from time off balance** is set to **No**. The net balance after time off deduction will become 44 hours and 30 minutes.
- Agent 2 requested time off outside of their shift hours (between **9:15 am – 10:15 am**). In this case, given the request is outside of the planned schedule, the system will not deduct from the agent's time off balance.
- Agent 3 requested time off between **2 am to 4am**, partially outside of their shift and partially overlapping the shift. The **Deduct from time off balance Break** activity falls within the time off request. In this scenario, system will deduct 1 hour 15 minutes for the duration between **2:45 am to 4:00 am**. The vacation balance for agent 3 would now be 13 hours and 45 minutes.

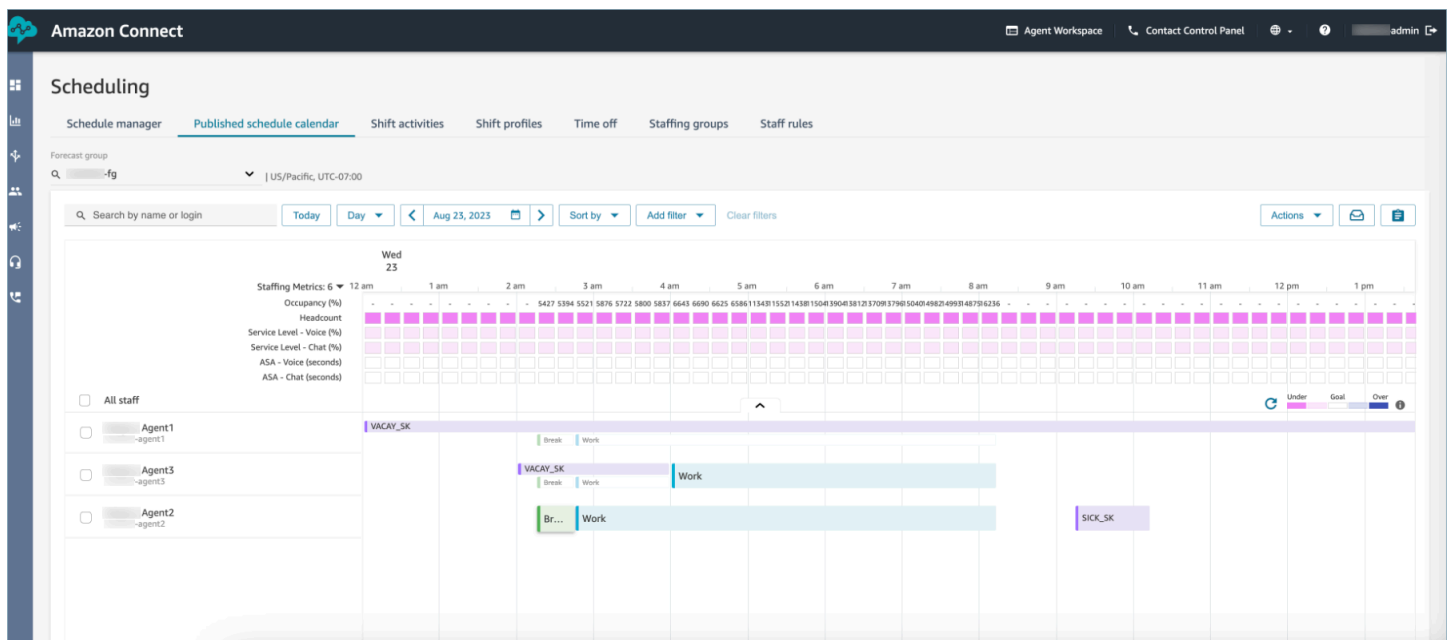

Manager and Agent view request drawer

At any time supervisors can go to the request drawer under the time off tab and search for an agent by first name, last name or login ID to view all time off requests for a specific agent.

The screenshot shows the 'Scheduling' interface with the 'Published schedule calendar' tab selected. The calendar is for Wednesday, Nov 23, 2022. On the right, a 'Requests' drawer is open, displaying a list of requests:

- Sick day off** (Nov 22, 2022, 02:02 PM) - Pending
- Sick day off** (Nov 21, 2022, 09:00 AM - 06:00 PM) - Admin Markov -admin
- Sick day off** (Nov 16, 2022, 01:32 PM) - Accepted
- Leave** (Nov 16, 2022, 05:00 AM - 10:00 AM) - Accepted
- Leave** (Nov 16, 2022, 11:08 AM) - Accepted
- Leave** (Nov 15, 2022, 07:00 AM - 09:00 AM) - Admin Markov -admin
- Leave** (Nov 14, 2022, 03:14 PM) - Cancelled
- Leave** (Nov 15, 2022, 12:00 AM - 11:59 PM) - Doe Jane

Update / Cancel

A supervisor can cancel or edit a time off request request by choosing the **Cancel Request** or **Edit Request** buttons at the bottom of the request drawer window. The following image shows the time off requests from Nikki Wolfe.

The screenshot shows the 'Scheduling' interface with the 'Published schedule calendar' tab selected. The calendar is for Monday, Nov 21, 2022. A request drawer is open on the right side, displaying details for a 'Time Off' request:

- Time Off** (Accepted)
- Time off: Sick day off** (Nov 21, 2022, 09:00 AM - 06:00 PM)
- Requested for:** Nikki Wolfe
- Requested by:** Admin Markov (On Nov 22, 2022, 2:02 PM)
- Reason:** Nikki was out sick.
- Approved by:** (On Nov 22, 2022, 2:03 PM)

At the bottom of the drawer, two buttons are visible: **Cancel Request** and **Edit Request**, both highlighted with red arrows.

An agent will see the updated time off status in their calendar and request drawer. The following image shows the status of Nikki Wolfe's time off requests. Her requests for Sick day off were Accepted.

Good afternoon, Wolfe
US/Eastern, GMT -05:00

Today Week < Nov 20 - Nov 26, 2022 >

	Sun 20	Mon 21	Tue 22	Wed 23
7 am				
8 am				
9 am		Lunch	Lunch	Lunch
10 am		Sick da...	Meeting	Meeting
11 am		Work	Work	Work
12 pm		Break	Break	Break
1 pm				

Requests

Overtime

VTO

Time Off

Sick day off Nov 22, 2022, 02:02 PM

Accepted

Admin Markov Nov 21, 2022, 09:00 AM - 06:00 PM
-admin

Sick day off Nov 16, 2022, 01:32 PM

Accepted

Doe Jane Nov 16, 2022, 05:00 AM - 10:00 AM
-supervisc

Leave Nov 14, 2022, 03:14 PM

Cancelled

Doe Jane Nov 15, 2022, 12:00 AM - 11:59 PM
-supervisc

Sick day off Nov 13, 2022, 06:56 PM

Overtime management

Simultaneously achieving Service Level (SL), Average Speed of Answer (ASA), and cost targets requires matching supply (# of agents) and demand (# of contacts * handle time). Overtime (OT) and Voluntary Time Off (VTO) are two mechanisms that the contact center management team can deploy to achieve both targets. OT allows handling a contact surge or agent shortages without the need to hire more employees while VTO allows handling a low volume contact period without the expenses of employees in an idle state.

Contents

- [Create overtime slots](#)
- [Agent accept or decline](#)
- [Supervisor override](#)

Create overtime slots

1. Choose the **Make Request** button in the **Published schedule calendar** UI and select **OT**.
2. A supervisor or manager enters the date and time range for overtime.

3. Select the productive activity from the Activity list.
4. Select by Staffing group or by Staff rules.
 - Staffing Groups send a notification to all agents regarding availability of overtime slots. Agents are approved based on a first come, first served model.
 - Staff rules allow supervisors to select specific agents to send overtime notifications to.
5. Select the number of required overtime slots.
6. Provide the reason for requesting overtime in the **Reason** text box. Agents will be able to view the reason prior to accepting or declining the overtime request.
7. Choose **Request**

Agent accept or decline

The following image shows pending Overtime requests in the agent calendars. Managers and agents can see overtime requests.

The screenshot displays the Amazon Connect interface. The main window shows the 'Published schedule calendar' for 'Nov 23, 2022'. The calendar grid includes staffing metrics such as Occupancy (%), Headcount, Service Level - Voice (%), Service Level - Chat (%), ASA - Voice (seconds), and ASA - Chat (seconds). A list of agents is visible, with one agent's row highlighted to show an 'Overtime' request. A modal window titled 'Overtime' is open, displaying the request details: 'Overtime: Overtime-2hour' for 'Nov 23, 2022, 04:00 PM - 05:00 PM'. The modal shows '0/4 accepted' and 'Waiting Accept: 39'. It includes buttons for 'Approve Request', 'Decline Request', 'Cancel Request', and 'Edit Request'.

Agents can accept or decline overtime in the Agent application schedule calendar.

Required security profile permissions

To accept or decline the request, an agent must have **Agent application schedule calendar - Edit** permissions in their security profile. This permission is shown in the following image of Agent Applications permissions on the security profiles page.

Agent Applications ⓘ				
Type	All	View	Edit	
Wisdom	<input type="checkbox"/>	<input checked="" type="checkbox"/>	<input type="checkbox"/>	
Agent application schedule calendar	<input type="checkbox"/>	<input checked="" type="checkbox"/>	<input checked="" type="checkbox"/>	

Accept and Decline overtime buttons for agents

The following image shows the Accept and Decline buttons on the agent application.

The screenshot displays the Amazon Connect interface for an agent named Carlos. The main area shows a calendar view for the week of November 20-26, 2022. The calendar includes slots for Break30, Work, Lunch, and Planned Leave. An overtime request is visible on Wednesday, November 23, from 5:00 PM to 7:00 PM. The right-hand panel shows the details of this overtime request, including the slot status (2/2 available), the reason (Need 2 agents to work overtime urgently), and a response field. At the bottom of the panel, there are two buttons: 'Decline' and 'Accept', both of which are highlighted with a red box.

Supervisor override

Mangers can override the system approval for OT/VTO and force Decline a request by clicking on the vertical ellipses next to the agent name. This option is shown in the following image of the **Overtime** pane.

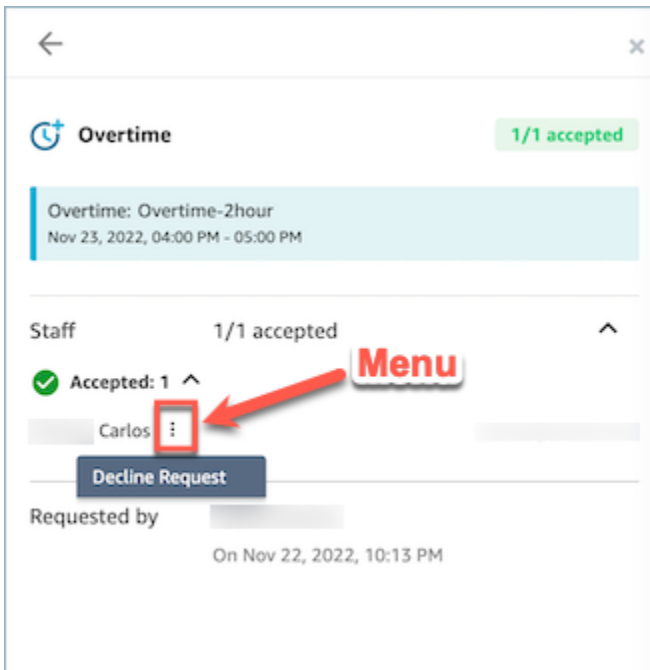

Voluntary time off management

Simultaneously achieving Service Level (SL), Average Speed of Answer (ASA), and cost targets requires matching supply (# of agents) and demand (# of contacts * handle time). Overtime (OT) and Voluntary Time Off (VTO) are two mechanisms that the contact center management team can deploy to achieve both targets. OT allows handling a contact surge or agent shortages without the need to hire more employees while VTO allows handling a low volume contact period without the expenses of employees in an idle state.

Contents

- [Create Voluntary time off slots](#)
- [Agent accept or decline](#)
- [Supervisor override](#)

Create Voluntary time off slots

1. Choose the **Make Request** button in the Published schedule calendar UI and select **VTO**.
2. A supervisor or manager enters the date and time range for voluntary time off.
3. Select the productive activity from the Activity list.
4. Select by Staffing group or by Staff rules.

- Staffing Groups send notifications to all agents regarding the availability of overtime slots. Agents are approved based on a first come, first served model.
 - Staff rules allow supervisors to select specific agents to send overtime notifications to.
5. Select the number of required voluntary time off slots.
 6. Provide the reason for requesting voluntary time off in the **Reason** text box. Agents will be able to view the reason prior to accepting or declining the overtime request.
 7. Choose **Request**

Agent accept or decline

The contact center manager and agents will see the pending voluntary time off requests in the agent calendars.

The screenshot displays the Amazon Connect Agent application interface. The main window shows a 'Published schedule calendar' for 'Sales FG' on 'Nov 23, 2022'. The calendar grid shows staffing metrics (Occupancy, Headcount, Service Level) and a row for 'xSales Evening (9)'. An 'Overtime' request is visible, with a modal overlay on the right. The modal shows the request details: 'Overtime: Overtime-2hour' for 'Nov 23, 2022, 04:00 PM - 05:00 PM'. It indicates '0/4 accepted' and 'Waiting Accept: 39'. The modal includes buttons for 'Approve Request', 'Decline Request', 'Cancel Request', and 'Edit Request'.

Agents can accept or decline voluntary time off (VTO) in the Agent application schedule calendar. In order to accept or decline the request, the agent will need to have **Edit Security Profile** permissions. For more information on Security Profile permissions, see [Update security profiles](#).

Required security profile permissions

To accept or decline the request, an agent must have **Agent application schedule calendar - Edit** permissions in their security profile. This permission is shown in the following image of Agent Applications permissions on the security profiles page.

Agent Applications ⓘ				
Type	All	View	Edit	
Wisdom	<input type="checkbox"/>	<input checked="" type="checkbox"/>	<input type="checkbox"/>	
Agent application schedule calendar	<input type="checkbox"/>	<input checked="" type="checkbox"/>	<input checked="" type="checkbox"/>	

Accept and Decline buttons for agents

The following image shows the Accept and Decline buttons on the agent application.

Good evening, Carlos
JTC, GMT +00:00

Today Week Nov 20 - Nov 26, 2022

	Sun 20	Mon 21	Tue 22	Wed 23	Thu 24
11 am		Break30		Break30	Break30
12 pm		Work	Break30	Work	Work
1 pm		Lunch	Work		
2 pm		Work			
3 pm			Lunch	Lunch	Planned Leave
4 pm			Work	Work	Lunch
5 pm				Overtime-2hour	
6 pm					
7 pm					
8 pm					
9 pm					
10 pm					
11 pm					

Overtime Waiting Accept

Overtime: Overtime-2hour
Nov 23, 2022, 05:00 PM - 07:00 PM

Slot 2/2 available

Requested by [Agent Name]
On Nov 22, 2022, 10:44 PM

Reason
Need 2 agents to work overtime urgently.

Response

Supervisor override

Mangers can override the system approval for OT/VTO and force Decline a request by clicking on the vertical ellipses next to the agent name. This option is shown in the following image of the **Overtime** pane.

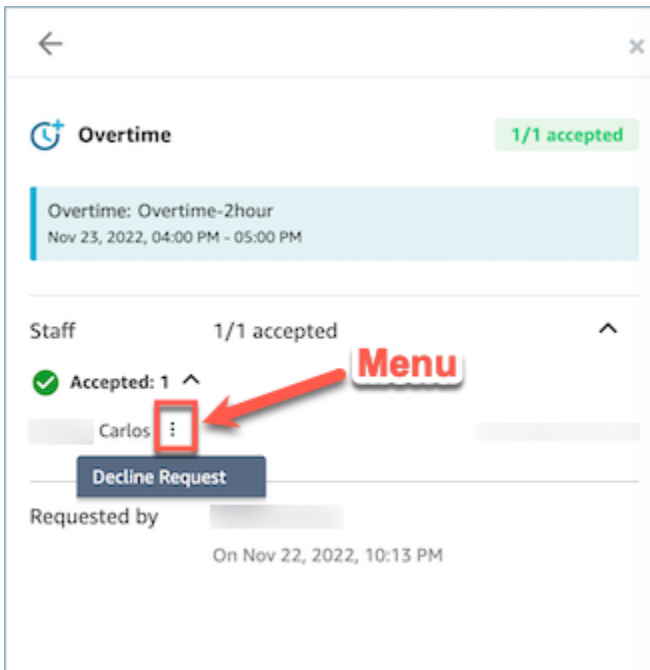

Schedule Adherence

Contact center supervisors or managers track schedule adherence to understand when agents are following the schedule that you have created. This helps ensure you achieve your service level targets, while improving agent productivity and customer satisfaction.

Amazon Connect begins generating schedule adherence automatically as soon as a published schedule starts that has shift activities where Adherence = yes.

You can view Schedule Adherence metrics on the **Historical metrics** and **Real-Time metrics** pages. The Schedule Adherence metrics are:

- Adherent time
- Adherence
- Schedule time
- Non-adherent time.

The following image shows an example of choosing Schedule Adherence metrics to appear in a historical metrics report.

Historical metrics: Agents

The "Contacts missed" metric is now renamed to "Agent idle time". Scheduled reports and exported CSV files with "Contacts missed" are not affected.

Interval: Total
Time range: Jul 26, 2022, 12:00 AM - Aug 2, 2022, 12:00 AM

Agent	Agent answer rate	Agent idle time
[blurred]	-	72:05:12
[blurred]	-	80:14:11
[blurred]	-	-
[blurred]	-	127:48:30

Table Settings

Interval & Time range | Groupings | Filters | **Metrics**

- Agent outbound connecting time
- Average agent callback connecting time
- Average agent outbound connecting time
- Non-Productive Time
- Online time
- Adherent time (Preview) ⓘ
- Scheduled time (Preview) ⓘ
- Average agent API connecting time
- Average agent incoming connecting time
- Error status time
- Occupancy
- Adherence (Preview) ⓘ
- Non-Adherent time (Preview) ⓘ

Contacts Abandoned

- Contacts abandoned in 15 seconds
- Contacts abandoned in 25 seconds
- Contacts abandoned in 45 seconds
- Contacts abandoned in 90 seconds
- Contacts abandoned in 180 seconds
- Contacts abandoned in 20 seconds
- Contacts abandoned in 30 seconds
- Contacts abandoned in 60 seconds
- Contacts abandoned in 120 seconds
- Contacts abandoned in 240 seconds

Cancel Apply

Getting started:

1. Schedule Adherence requires that schedules are created and published. For more information, see [Scheduling in Amazon Connect](#).
2. Ensure you have the right permissions to access metrics and scheduling information. For more information on the required permissions, see [security profile permissions for forecasting, capacity planning, and scheduling](#).

Historical Schedule Adherence

This section describes the values used when calculating Historical Schedule Adherence.

Adherence

Percentage of time that an agent correctly follows their schedule. This is measured by tracking if an agent is in an *Available* agent status when they should be in productive state. This percentage is calculated as follows:

$$\text{Adherence \%} = ((\text{Total Adherent Minutes}) / \text{Total Scheduled Adherence Minutes})$$

An agent is considered adherent if the agent is in an *Available* Status, when the shift activity is Productive, or if the agent is in Non-Productive Status (i.e Custom Status), when the shift activity is Non-Productive. Otherwise the agent is considered non-adherent. This means that if a shift

activity is called *Lunch* but marked as productive, the agent is considered adherent if they are in the *Available* agent status.

- Type: String
- Min value: 0.00%
- Max value: 100.00%
- Category: Agent activity-driven metric

Note

Anytime you change the schedule, Schedule Adherence is re-calculated up to 30 days in the past from the current date (not the date of the schedule), if schedules are changed.

Adherent time

Total time an agent was in an *Available* status when their shift activity is productive or was in non-productive status when the shift activity is non-productive.

- Type: String (hh:mm:ss)
- Category: Agent activity-driven metric

Non-Adherent time

Total time an agent was not in an *Available* status when their shift activity is productive or not in a non-productive status when their shift activity is non-productive.

- Type: String (hh:mm:ss)
- Category: Agent activity-driven metric

Scheduled time

Total time an agent was scheduled (either for productive or non-productive time) and Adherence for those shifts were set to Yes.

- Type: String (hh:mm:ss)
- Category: Agent activity-driven metric

Real-Time Schedule Adherence

Real-Time agent adherence is available in a table called **Agent schedule adherence**. You can select this table from both the real-time metrics landing page or within an existing report. This table has the same functionality as an existing agent's table with the following additions

Note

The real-time adherence data may take up to 3 minutes to refresh, but it will capture the complete duration of adherence or non-adherence.

Real-Time agent adherence status

- This will indicate whether an agent is adherent or non-adherent in near real-time. For a definition of schedule adherence, see [Schedule Adherence](#).

Scheduled status

- This will indicate whether an agent is scheduled to be in productive time or non-productive time. If an agent is not scheduled, it will show as blank.

Agent adherence duration

- The amount of time an agent has currently been adherent or non-adherent. When an agent changes between non-adherent or adherent, this value will reset, as it represents the current amount of time.

Agent adherence percentage

- The percentage of time an agent has been adherent to their schedule. For a definition of agent adherence percentage, see [Historical Schedule Adherence](#).

Schedule adherence usage examples

Shift activities that are tracked for adherence

Any shift activity that is marked as Adherence = Yes. If a shift is marked as Adherence = No, adherence is not calculated for that shift.

How to determine which Agent State an agent should be in for each activity

If an activity is marked as productive, an agent needs to be in an *Available* agent state. Productivity is determined by the agent being in an available state and is not impacted if the agent isn't handling live contacts. For tracking how many contacts an agent has handled, see the occupancy metric.

If an activity is marked as non-productive, an agent needs to be in a non-productive custom state. An agent does not have to be in a specific custom state to be considered adherent. For example, if the shift activity is *Lunch*, but the agent switches their status to *Break*, the agent would still be considered adherent since both states are Non-Productive.

What happens when...

- **an agent starts working before their schedule starts**

If an agent does not have a schedule, we do not track adherence for that time. This means that if an agent starts working 5 minutes before or 5 minutes after their schedule, it will not count against their adherence. However, if they decide to leave work 5 minutes early because they started 5 minutes early, they would be considered non-adherent for that 5 minute interval.

- **an agent flips to offline when they are supposed to be a non-productive state**

This would be considered non-adherent because the agent state is offline, rather than Non-Productive Time.

- **an agent leaves training to answer contacts because of high contact volume**

In this scenario, the agent would be marked as non-adherent. However, if leaving training is intended, you can adjust the schedule retroactively and adherence will be re-calculated with the new shift.

- **a historical schedule is changed**

If an agent's schedule is changed within the last 30 days from the current date (not the date of the schedule), adherence will be re-calculated with the new schedule. This allows making real-time adjustments to an agent's shift and will correctly evaluate their adherence.

Calculating Agent Adherent and Non-Adherent Time

Example

Example 1:

Agent A is scheduled to work from 8:00 to 11:00.

They begin working at 7:30 and then take a break from 10:30 to 11:00. From 7:30 to 8:00 the agent is neither adherent or non-adherent since there is no schedule.

From 8:00 to 10:30 the agent is adherent and from 10:30 to 11:00 the agent is non-adherent because they were in Non-Productive Time when they should have been productive.

This means that Agent A's Adherence was 83%. (Total Adherent Time was 150 minutes/Total Scheduled Time 180 minutes)

Example 2:

Agent B is scheduled to work from 9:00 to 10:30.

They go on Break from 10:30 to 11:00, and then a team meeting from 11:00 to 12:00. They begin working at 9:00 and end up working until 10:45. Then picking the *Break* custom Non-Productive Time status from 10:45. They forget to switch their status to *Team Meeting* and leave it as *Break* until 12:00.

From 9:00 to 10:30 the agent was adherent but from 10:30 to 10:45 the agent was non-adherent because they were in a productive state when they should have been in a non-productive state. From 10:45 to 12:00 they were adherent because they were in a non-productive state the entire time.

This means that Agent B's adherence was 92% (Total Adherent Time: 165 Minutes / Total Scheduled Time: 180 Minutes)

Private optimization APIs

Amazon Connect forecasting, capacity planning, and scheduling uses the following private API resources as actions in its IAM policy:

- `connect:BatchAssociateAnalyticsDataSet`. Grants access permissions and associates the specified datasets for the specified Amazon Connect instance with the specified AWS account.

- `connect:BatchDisassociateAnalyticsDataSet`. Revokes access permissions and disassociates the specified datasets for the specified Amazon Connect instance with the specified AWS account.

If you remove these actions from the preview role policy, the forecasting, capacity planning, and scheduling features won't work.

Use real-time caller authentication with Voice ID

Amazon Connect Voice ID provides real-time caller authentication and fraud risk detection which make voice interactions in contact centers more secure and efficient. Voice ID uses machine learning to verify the identity of genuine customers by analyzing a caller's unique voice characteristics. This allows contact centers to use an additional security layer that doesn't rely on the caller answering multiple security questions, and makes it easy to enroll and verify customers without changing the natural flow of their conversation. Voice ID also offers real-time detection of fraudsters who frequently target your contact center, thereby reducing losses due to fraud.

With Amazon Connect Voice ID you can:

- Passively enroll customers for voice authentication without requiring them to repeat a particular word or phrase.
- Migrate customers into Voice ID by enrolling them in batch.
- Verify the enrolled customer's identity by analyzing their unique voice characteristics.
- Detect fraudsters from a watchlist that you have created.
- Detect voice spoofing.

How Voice ID works

Customer enrollment

1. When a customer calls for the first time, the agent confirms the identity of the caller by using existing security measures, such as asking for mother's maiden name or a one-time passcode (OTP) delivered by SMS. This ensures that only genuine customers are enrolled in Voice ID.
2. Voice ID starts listening to the customer's speech after the contact has encountered the [Set Voice ID](#) block, where Voice ID is enabled. Voice ID listens to the call until one of the following happens:
 - It gets enough audio to evaluate the speaker for authentication, fraud, and enroll the speaker (if requested). This is 30 seconds of customer speech, excluding silence.
 - The call ends.
3. Voice ID then creates the enrollment voiceprint. A voiceprint is a mathematical representation that implicitly captures unique aspects of an individual's voice such as speech rhythm, pitch, intonation, and loudness.

The caller does not need to say or repeat any specific phrases to enroll in Voice ID.

Customer authentication

1. When the enrolled customer calls back in, they are verified through an interaction with an IVR, or during their interaction with an agent.

By default Voice ID is configured to require 10 seconds of a caller's speech to authenticate, which can be done as part of a typical customer interaction in the IVR or with the agent (such as "what's your first and last name?" and "what are you calling about?"). You can adjust the amount of required speech using the [Authentication response time](#) property in the [Set Voice ID](#) block.

2. Voice ID uses the audio to generate the caller's voiceprint and compares it with the enrolled voiceprint corresponding to the claimed identity, and returns an authentication result.

For more information about the agent's experience, see [Use Voice ID](#).

How much speech is needed for enrollment and authentication

- Enrollment: 30 seconds of customer net speech (speech that excludes any silence) to create a voiceprint and enroll a customer.
- Verification: By default, 10 seconds of customer net speech to verify that the voice belongs to the claimed identity. The speech can be from interacting with an IVR or an agent. You can adjust the amount of required speech using the [Authentication response time](#) property in the [Set Voice ID](#).

Batch enrollment

You can get a jump start on using biometrics by batch enrolling customers who have already consented for biometrics. Using stored audio recordings in your S3 bucket, and a JSON input file that provides the speaker identifier and a link to the audio recordings, you can invoke the Voice ID batch APIs.

For more information, see [Batch enrollment using audio data from prior calls](#).

Known fraudster detection

There are a few steps to setting up the real-time detection of fraudsters:

1. [Create a new watchlist](#) for storing known fraudsters. Or, use the default watchlist that is created when Voice ID is enabled.
2. [Register fraudsters](#) to the new watchlist or the default watchlist.
3. In the [Set Voice ID](#) block, specify which watchlist you want to use.

When one of the fraudsters from the watchlist that is specified in the flow calls your contact center, Voice ID analyzes the call audio to return a risk score and outcome. This score indicates how closely the caller's voiceprint matches that of the fraudster's in the watchlist. Voice ID requires 10 seconds of audio to evaluate the call audio for fraud risk from known fraudsters.

Default watchlist

When the Voice ID domain is created, Voice ID creates a default fraudster watchlist for that domain. The name and description of the default fraudster watchlist is encrypted using the KMS key that is provided in the domain and saved in Voice ID.

If you don't provide the `fraudster watchlistId` for fraud detection or fraudster registration, Voice ID uses the default fraudster watchlist.

You cannot update the metadata of the default fraudster watchlist, but you can associate or disassociate fraudsters from it.

Note

If your Voice ID domain was created before March 2023, when fraudster watchlists was launched: a default watchlist was created and all existing fraudsters have been placed in it.

Voice spoofing detection

1. When a prospective fraudster tries to spoof caller audio using audio playback or synthesized speech, Voice ID returns a risk score and outcome to indicate the how likely it is that the voice is spoofed.

2. Voice spoofing is only enabled when you enable the fraud detection feature in your contact flow. Voice spoofing scores are not returned when only speaker authentication is enabled.
3. Voice ID requires 10 seconds of audio to evaluate the call audio for fraud risk from voice spoofing.

What data is stored?

Voice ID stores audio files of the speaker's voice, voiceprints, and speaker identifiers. This data is encrypted using a KMS key that you provide.

If you enable detection of fraudsters in a watchlist, Voice ID also stores the fraudster audio and voiceprints. For more information, see [Data handled by Amazon Connect](#).

Voice ID domains

When you enable Amazon Connect Voice ID, you create a Voice ID domain: a container for all Voice ID data, such as speaker identifiers (which serves as the customer identifier), the voiceprints, the customer audio that was used for creating the enrollment voiceprints, and the enrollment statuses (enrolled, opted out, etc.) associated with the speaker identifiers. For detection of fraudsters in a watchlist, the Voice ID domain stores the fraudster identifiers, voiceprints, and audio used for creating the voiceprints.

Following are guidelines for creating Voice ID domains:

- Each Amazon Connect instance can be associated with only one Voice ID domain.
- Each Voice ID domain can be associated with multiple Amazon Connect instances. This enables you to use the same stored customer data across multiple Amazon Connect instances.
- You can create multiple domains, but they don't share customer data between each other.
- We recommend creating a new Voice ID domain to associate with a Amazon Connect instance when:
 - You are enabling Voice ID for the first time on your account in an AWS Region.
 - You want to ensure that you isolate the Voice ID domains used for your test and production environments.
- We recommend using an existing Voice ID domain when:
 - You want to use the same set of enrolled callers and fraudsters across different Amazon Connect instances (that may belong to different customer service teams)

- You want to use the same test environment across different test Amazon Connect instances.

 **Note**

Only existing Voice ID domains in the same Region in your Amazon Connect account can be shared across Amazon Connect instances in that Region.

- You can change the association of your Amazon Connect instance from your current domain to a new domain at any time, by choosing a different domain.
- To delete a Voice ID domain, use the [DeleteDomain](#) Voice ID API. DeleteDomain soft deletes the domain. Amazon Connect waits 30 days before completely erasing the domain data. During this period, Voice ID; is disabled for all the Amazon Connect instances it is associated with. To restore a domain during this window, submit an AWS Support ticket and provide the domain ID. You can find the domain ID on the Voice ID section of the Amazon Connect console, as shown in the following example:

Amazon Connect ✕

Instances
Third-party applications [New](#)

Overview

▼ Channels and communications

- Tasks
- Telephony

▼ Applications

- Amazon Q
- Analytics tools
- Cases
- Customer Profiles
- Forecasting, capacity planning, and scheduling [New](#)
- Voice ID**

Approved origins

Data storage

Data streaming

Flows

[Amazon Connect](#) > [Voice ID](#)

ⓘ Voice ID requires permissions for BIPA consent
To start using Voice ID, you must attach voiceid:D

Voice ID

Details

Domain name
[redacted] voiceid

Domain ID
[redacted]

Deleting a Voice ID domain deletes all stored customer data, such as audio recordings, voiceprints, and speaker identifiers, as well as any fraudster watchlists that you managed.

Enrollment status

Voice ID stores three different enrollment status for a speaker: ENROLLED, OPTED_OUT and EXPIRED. You can recall these speaker status using [Amazon Connect Voice ID APIs](#) and using contact flow blocks to take appropriate action.

- **ENROLLED:** When you enroll a new caller is enrolled into Voice ID, Voice ID creates a new voiceprint and set the speaker status as ENROLLED. Even if you re-enroll the same caller into Voice ID, the status stays as ENROLLED.
- **OPTED_OUT:** If a caller does not provide consent to enroll into biometrics, you can opt out the caller (in the Contact Control Panel) or using APIs. Voice ID creates a new entry for this caller and set the speaker's status OPTED_OUT. Voice ID does not generate any voiceprint or store any audio recording for the speaker. Future enrollment requests for this speaker is rejected unless their entry is deleted.
- **EXPIRED:** If a caller's voiceprint has not been accessed or refreshed for 3 years, Voice ID changes the status to EXPIRED, and you are no longer able to perform authentications for this caller. You can re-enroll the caller again or delete the caller from Voice ID.

Expired speakers

For BIPA compliance, Voice ID automatically expires speakers that have not been accessed for enrollment, re-enrollment, or successful authentication for three years.

To view a speaker's last access, look at the `lastAccessedAt` attribute that is returned by the `DescribeSpeaker` and `ListSpeakers` APIs.

If you try to use the `EvaluateSession` API to authenticate an expired speaker, a `SPEAKER_EXPIRED` authentication decision is returned.

To use the expired speaker again, they must be re-enrolled.

Speaker and fraudster identifiers

Voice ID uses speaker identifiers to refer to and retrieve the voiceprints in a Voice ID domain. We recommend that you use identifiers that do not contain any Personally Identifiable Information (PII) in the identifiers.

Voice ID creates two fields to refer to a caller:

- `CustomerSpeakerId`: A identifier provided by the customer. It can be between 1-256 characters and can only contain: **a-z**, **A-Z**, **0-9**, **-** and **_**
- `GeneratedSpeakerId`: A unique 22-character alphanumeric string that Voice ID creates and returns at the time of enrollment of the caller.

[Amazon Connect Voice ID speaker APIs](#) accept either form of speaker identifiers, but only emit `GeneratedSpeakerId` in the Voice ID event streams and contact records. If you want to re-record the caller to redo the voiceprint, you can enroll the caller with the same `CustomerSpeakerId`.

Similarly, Voice ID creates unique fraudster identifiers called `GeneratedFraudsterID` for every fraudster that you add to a watchlist in the domain. Voice ID returns the fraudster identifier if a fraudster is detected in a call when performing fraud risk detection.

Enable Voice ID

Before you begin

Before you get started, complete the following tasks.

Tasks

- [Grant the required permissions](#)
- [Decide how to name your Voice ID domain](#)
- [Create an AWS KMS key to encrypt data stored in the domain](#)

Grant the required permissions

You must grant the required permissions to users, groups, or roles. For more information, see [AmazonConnectVoiceIDFullAccess](#).

Access to Voice ID APIs using the Contact Control Panel (CCP) is disabled by default.

Decide how to name your Voice ID domain

When you enable Voice ID, you are prompted to provide a friendly domain name that's meaningful to you such as your organization name, for example, *Voice ID-ExampleCorp*.

Create an AWS KMS key to encrypt data stored in the domain

When you enable Voice ID, you are prompted to create or provide an [AWS KMS key](#). It encrypts the customer data stored by Voice ID such as audio files, voiceprints, and the speaker identifiers.

Step-by-step instructions for creating these KMS keys are provided in [Step 2: Create a new Voice ID domain and encryption key](#).

Data at rest—specifically, freeform fields that you provide plus audio files/voiceprints—are encrypted under the KMS key you choose. Your customer managed key is created, owned, and managed by you. You have full control over the KMS key (AWS KMS charges apply).

When making calls to Voice ID for anything other than `CreateDomain` or `UpdateDomain`, the user making the call requires `kms:Decrypt` permissions for the key associated with the domain. When making calls to `CreateDomain` or `UpdateDomain`, the user also requires `kms:DescribeKey` and `kms:CreateGrant` permissions for the key. When you create (or update) a Voice ID domain, it creates a grant on the KMS key so that it can be used by Voice ID asynchronous processes (such as speaker enrollment) and by the Amazon Connect service-linked role during your flows. This grant includes an encryption context specifying the domain with which the key is associated. For more on grants, see [Using grants](#) in the AWS Key Management Service Developer Guide.

If you create a domain and associate it with one key, store some data, and then change the KMS key to a different key, an asynchronous process will be triggered to re-encrypt the old data with the new KMS key. After this process completes, all of your domain's data will be encrypted under the new KMS key, and you may safely retire the old key. For more information, see [UpdateDomain](#).

Tip

You can create KMS keys or provide an existing KMS key programmatically. For more information, see [Amazon Connect Voice ID APIs](#).

Step 1: Read the BIPA Consent Acknowledgement

Reading the Biometric Privacy Act (BIPA) Consent Acknowledgement is a requirement to enable Voice ID. You need to do this once per account, across all Regions. You cannot do this step by using APIs. For more information about BIPA, see this Wikipedia article: [Biometric Information Privacy Act](#).

1. Open the Amazon Connect console at <https://console.aws.amazon.com/connect/>.
2. On the instances page, choose the instance alias. The instance alias is also your **instance name**, which appears in your Amazon Connect URL. The following image shows the **Amazon Connect virtual contact center instances** page, with a box around the instance alias.

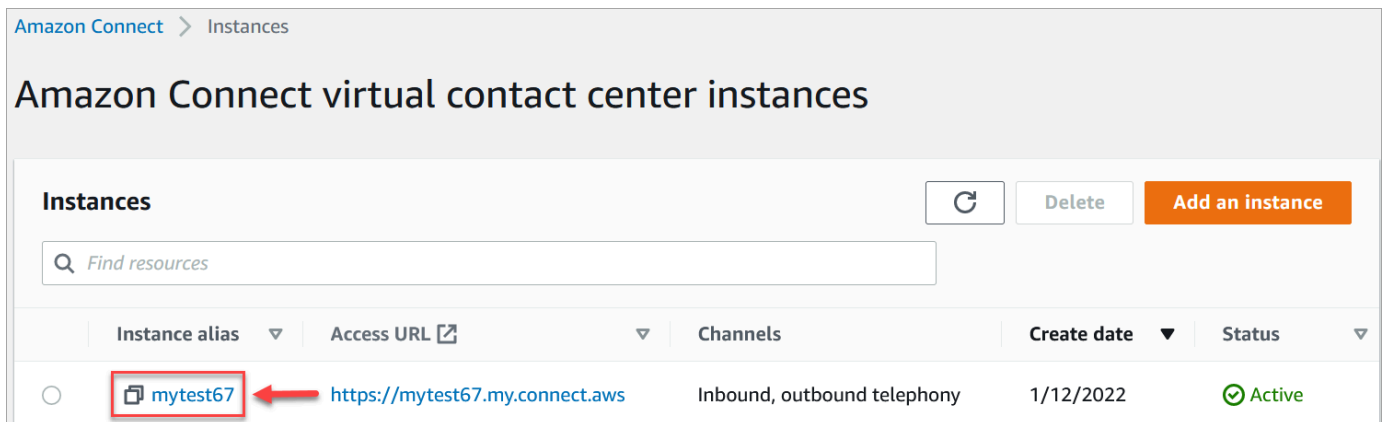

3. In the navigation pane, choose **Voice ID**. Read the BIPA Consent Acknowledgement, and accept if you agree.

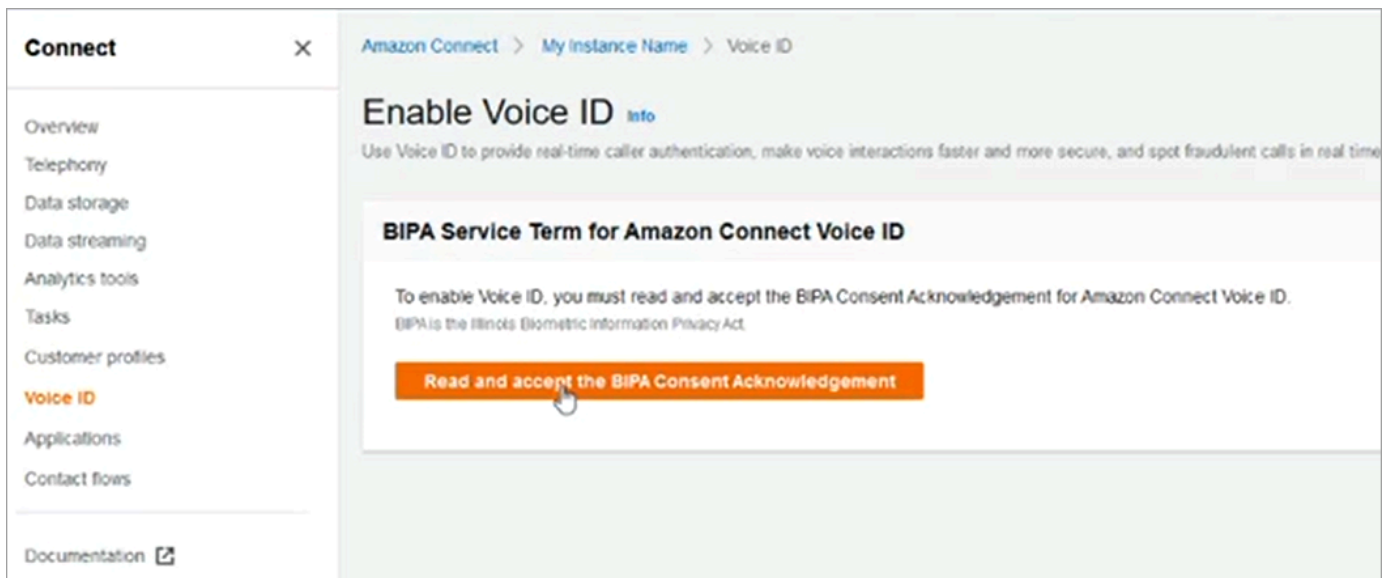

Step 2: Create a new Voice ID domain and encryption key

You can perform this step using the Amazon Connect console or by using Amazon Connect and Voice ID APIs.

Amazon Connect console instructions

1. In the **Domain setup** section, choose **Create a new domain**.

Enable Voice ID [Info](#)

Use Voice ID to provide real-time caller authentication, make voice interactions faster and more secure, and spot fraudulent calls in real time.

► BIPA Consent Acknowledgement for Amazon Connect Voice ID

Domain setup

Choose domain method

Create a new domain
Use a new domain to enable Voice ID for your instance.

Choose an existing domain
Use an existing domain to enable Voice ID for your instance.

Voice ID domain name

This is where your voice prints will be stored.

MyVoiceDomainName

Must be between 1 and 1024 characters. Valid characters are a-z, A-Z, 0-9, - (hyphen), _ (underscore), and . (period). No spaces.

 By enabling Voice ID, you are granting us permission to store voice prints in your Voice ID domain. [Learn more](#)

2. In the **Domain name** box, enter a friendly name that's meaningful to you, such as your organization name, for example, *VoiceID-ExampleCorp*.
3. Under **Encryption**, create or enter your own AWS KMS key for encrypting your Voice ID domain. Following are the steps to create your KMS key key:

1. Choose **Create KMS key**.

Encryption

KMS key for Voice ID
Create a KMS key to encrypt customer audio and voice. This key is specific to Voice ID and is paired with the domain.

Format: s3://bucket/prefix. Source files are bundled with colcon. Valid extensions are .tar and .gz.

2. A new tab in your browser opens for the Key Management Service (KMS) console. On the **Configure key** page, choose **Symmetric**, and then choose **Next**.

KMS > Customer managed keys > Create key

Step 1
Configure key

Step 2
Add labels

Step 3
Define key administrative permissions

Step 4
Define key usage permissions

Step 5
Review and edit key policy

Configure key

Key type [Help me choose](#)

Symmetric
A single encryption key that is used for both encrypt and decrypt operations

Asymmetric
A public and private key pair that can be used for encrypt/decrypt or sign/verify operations

► Advanced options

Cancel **Next**

3. On the **Add labels** page, add a name and description for the KMS key, and then choose **Next**.
 4. On the **Define key administrative permissions** page, choose **Next**.
 5. On the **Define key usage permissions** page, choose **Next**.
 6. On the **Review and edit key policy** page, choose **Finish**.
 7. Return to the tab in your browser for the Amazon Connect console, **Voice ID** page. Click or tap in the **AWS KMS key** for the key you created to appear in a dropdown list. Choose the key you created.
4. Choose **Enable Voice ID**.

API instructions

1. Call the [CreateDomain](#) API to create a new Voice ID domain.
2. Call the [CreateIntegrationAssociation](#) API to associate the Voice ID domain with the Amazon Connect instance.
 - Pass the ARN of the Voice ID domain just created into the `IntegrationArn` parameter. For `IntegrationType` use `VOICE_ID`.

You've enabled Voice ID for your instance. The following has been created:

- Your Voice ID domain and a default fraudster watchlist that will hold your fraudsters.

- A managed Amazon EventBridge rule in your account. This rule is used to ingest Voice ID events for creating contact records related to Voice ID. Additionally, Amazon Connect adds [Voice ID permissions](#) to the service-linked role for Amazon Connect.

Next, in Step 3 you configure how you want Voice ID to work in your flow.

Step 3: Configure Voice ID in your contact flow

In this step you add the required blocks to your flow and configure how you want Voice ID to work.

- [Play prompt](#): Add this block before the [Set Voice ID](#) block to stream audio properly. You can edit it to include a simple message such as "Welcome."
- [Set Voice ID](#): After the [Play prompt](#) block, add the [Set Voice ID](#) block. It should be at the start of a call. Use this block to start streaming audio to Amazon Connect Voice ID to verify the caller's identity, as soon as the call is connected to a flow.

In **Set Voice ID** block you configure the authentication threshold, response time, fraud threshold, and fraudster watchlist to be used for known fraudster detection.

- [Set contact attributes](#): Use to pass the `CustomerId` attribute to Voice ID. The `CustomerId` may be a customer number from your CRM, for example. You can create a Lambda function to pull the unique customer ID of the caller from your CRM system. Voice ID uses this attribute as the `CustomerSpeakerId` for the caller.

Note

`CustomerId` can be an alphanumeric value. It supports only `_` and `-` (underscore and hyphen) special characters. It does not need to be UUID. Since Voice ID stores biometric information for each speaker, we strongly recommend that you use an identifier that does not contain PII in the `CustomerSpeakerId` field. For more information, see `CustomerSpeakerId` in the [Speaker](#) data type.

- [Check Voice ID](#): Use to check the response from Voice ID for enrollment status, voice authentication, and fraud detection, and then branch based on one of the returned statuses.

Example Voice ID flow

Caller not enrolled

1. When a customer calls for the first time, their `CustomerId` is passed to Voice ID using the [Set contact attributes](#) block.
2. Voice ID looks for `CustomerId` in its database. Since it's not there, it sends a **Not enrolled** result message. The [Check Voice ID](#) block branches based on this result, and you can decide what the next step should be. For example, you might want agents to enroll the customer in voice authentication.
3. Voice ID starts listening to the customer's speech after the contact has encountered the [Set Voice ID](#) block, where Voice ID is enabled. It listens until it accumulates 30 seconds of net speech or the call ends, whichever happens first.

Caller enrolled

1. The next time the customer calls, Voice ID finds their `CustomerId` in the database.
2. Voice ID starts listening to the audio to create a voiceprint. The voiceprint that is created this time is used for authentication purposes so Voice ID can compare if the caller had been enrolled previously.
3. It compares the caller's current voiceprint with the stored voiceprint associated with the claimed identity. It returns a result based on the **Authentication threshold** property you configured in the [Set Voice ID](#) block.
4. After it evaluates the speech, it returns the message **Authenticated** if the voiceprints are similar. Or it returns one of the other statuses.
5. The contact is then routed down the appropriate branch by the [Check Voice ID](#) block.

Security profile permissions for Voice ID

- To enable users to search for contacts by their Voice ID status, assign the following **Analytics and Optimization** permission to their security profile:
 - **Voice ID - attributes and search:** Enables users to search for and view Voice ID results on the **Contact detail** page.
- To grant agents access to Voice ID in the Contact Control Panel, assign the following permission in the **Contact Control Panel** group:
 - **Voice ID - Access:** Enables controls in the Contact Control Panel so agents can:
 - View authentication outcomes.
 - Opt-out or re-authenticate a caller.

- Update SpeakerID.
- View fraud detection results, rerun fraud analysis (fraud detection decision, fraud type and score).

Note

The functionality to enter or update the SpeakerID is not available with the default Voice ID widget in the CCP. To include the option for updating the SpeakerID, implement the `updateVoiceIdSpeakerId` [Amazon Connect Streams](#) API in your custom CCP.

The following image shows an example of these controls on the CCP:

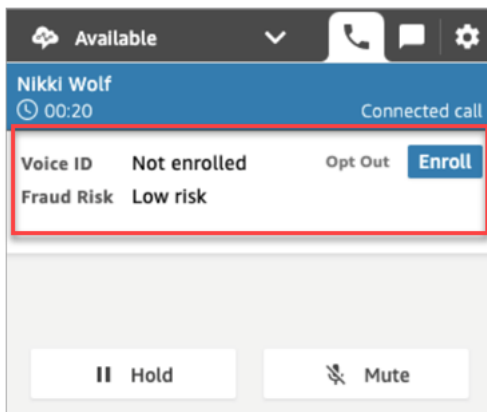

For information about how to add more permissions to an existing security profile, see [Update security profiles](#).

By default, the **Admin** security profile already has permissions to perform all Voice ID activities.

Search and review Voice ID results

Use the [Contact search](#) page to search for and review the results of enrollment status, voice authentication, and detection of fraudsters in a watchlist. With the required [security profile permissions](#) (**Analytics and Optimization - Voice ID - attributes and search - View**), you can search for Voice ID results using the following filters:

- **Speaker actions:** Use this filter to search for contacts where the caller was enrolled into Voice ID or chose to opt-out of Voice ID altogether.

- **Authentication result:** Use this filter to search for contacts where Voice ID authentication returned the following results:
 - Authenticated
 - Not authenticated
 - Opted out
 - Inconclusive
 - Not enrolled

For example, if you want to search for all contacts where the authentication status was returned as **Not authenticated** or **Opted out**, select both these options and choose **Apply**.

- **Fraud detection result:** Use this filter to search for contacts where Voice ID fraud analysis returned the following results:
 - High risk for fraud
 - Low risk for fraud
 - Inconclusive
- **Fraud detection reason:** Use this filter to search for contacts where specific fraud risk mechanisms were detected:
 - Known fraudster: the caller's voice matches a fraudster from the fraudster watchlist you have created.
 - Voice spoofing: the caller is modifying their voice or is using speech synthesis to spoof the agent.

Voice ID results in a contact record

After you search for a contact, you can choose an ID to view their contact record. The following image shows an example of the fields in the Voice ID section of the contact record:

Voice ID	
Enrollment	No
Opt-out	No
Authentication	Enabled
Speaker ID	id#o5-XXXXXXXXXXXXXXXXXXXX
Threshold	90
Minimum speech (secs)	10 secs
Score	-
Result	Not enrolled
Fraud detection	Enabled
Threshold	5
Result	High risk
Reasons	Known fraudster, Voice spoofing
Known fraudster risk score	17
Fraudster ID	id#Lb-XXXXXXXXXXXXXXXXXXXX
Watchlist ID	XTe-XXXXXXXXXXXXXXXXXXXX
Voice spoofing risk score	12

Use the Voice ID APIs

To manage Voice ID programmatically, see [Amazon Connect Voice ID APIs](#).

This section explains how to perform common scenarios using the Voice ID APIs.

Contents

- [Voice ID domain operations](#)
- [Voice ID and Amazon Connect Integration Association APIs](#)
- [Voice ID speaker, watchlist, and fraudster management APIs](#)
- [Batch enrollment using audio data from prior calls](#)
- [Input and output file schema for Speaker Enrollment Job](#)
- [Create and edit a fraudster watchlist](#)
- [Input and output file schema for Fraudster Registration Job](#)
- [Amazon Connect Streams Voice ID APIs](#)

Voice ID domain operations

Amazon Connect Voice ID provides APIs for you manage Voice ID domains. You can find equivalents for Create, Describe, List, and Update in the AWS Console.

1. [CreateDomain](#): To create a new Voice ID domain, use the `CreateDomain` Voice ID API. When the Voice ID domain is created, a default fraudster watchlist to hold your fraudsters is created at the same time.

Note the following guidelines when using the `CreateDomain` API:

- You can only invoke this for your account after you have acknowledged the BIPA Consent in the AWS console.
 - You must also specify the KMS key for the Voice ID domain at the time of creation.
 - After creating a Voice ID domain, use the [Amazon Connect association APIs](#) to associate it with an Amazon Connect instance.
2. [DeleteDomain](#): To delete a Voice ID domain, you must invoke the `DeleteDomain` Voice ID API and provide the domain ID. If this domain was associated with an Amazon Connect instance, Voice ID API calls, and Voice ID flow blocks will return runtime error. Deleting a Voice ID domain deletes all stored customer data such as audio recordings, voiceprints and speaker identifiers, as well as fraudster lists that you managed.
 3. [DescribeDomain](#): Use this API to return the name, description and encryption configuration of an existing domain identified by its `DomainID`.
 4. [ListDomains](#): Use this API to list all your Voice ID domains owned by your account in the Region.
 5. [UpdateDomain](#): To update the name and encryption configuration for a domain, you can use the `UpdateDomain` Voice ID API. This API clobbers existing attributes, and you must provide both these fields.

When you change the KMS key associated with the Voice ID domain, following the `UpdateDomain` call your domain's existing data will be asynchronously re-encrypted under the new KMS key. You can check status of this process from your domain's `ServerSideEncryptionUpdateDetails` attribute using the `DescribeDomain` API. While this update process is in progress, you must retain your old KMS key in an accessible state, otherwise this process may fail. After this process completes, the old KMS key may be safely retired.

Voice ID and Amazon Connect Integration Association APIs

You can use the following APIs to manage associations with Amazon Connect instances. You can perform these operations on the AWS Console as well.

1. [CreateIntegrationAssociation](#): To enable Voice ID on an Amazon Connect instance, you will need to associate a Voice ID domain with a Amazon Connect instance using a `CreateIntegrationAssociation` request. You can only associate one Voice ID domain to an Amazon Connect instance. If the instance is already associated with a domain, the API returns the following error:

`DuplicateResourceException (409)` - Request is trying to created a duplicate resource.

Note

When you enable Voice ID for an Amazon Connect instance (by using either the Amazon Connect console or the [CreateIntegrationAssociation](#) API), Amazon Connect creates a managed Amazon EventBridge rule in your account. This rule is used to ingest Voice ID events for creating contact records related to Voice ID. Additionally, Amazon Connect adds [Voice ID permissions](#) to the service-linked role for Amazon Connect.

2. [DeleteIntegrationAssociation](#): To delete an existing association between an Amazon Connect instance and a Voice ID domain, you will need to call the `DeleteIntegrationAssociation` APIs along with the Amazon Connect InstanceID and the `IntegrationAssociationID` returned by `CreateIntegrationAssociation`. This is a required step if you want to associate a different Voice ID domain to this Amazon Connect instance. We do not recommend deleting associations in a production setup as it can cause unpredictable behavior for Voice ID in your Amazon Connect instance.
3. [ListIntegrationAssociations](#): To list all the associations between Amazon Connect instance and Voice ID domains for your account in this Region, you can invoke `ListIntegrationAssociations` API.

Voice ID speaker, watchlist, and fraudster management APIs

Amazon Connect Voice ID includes APIs to manage speakers enrolled into a Voice ID domain and fraudsters registered in the domain. All speaker APIs, except `ListSpeakers`, accept either the `CustomerSpeakerId` or `GeneratedSpeakerId`.

Speaker management APIs

1. [DescribeSpeaker](#): Describe a speaker's [status in a domain \(ENROLLED, OPTED_OUT, EXPIRED\)](#), and to map a `GeneratedSpeakerId` to a `CustomerSpeakerId`, and vice versa.

2. [DeleteSpeaker](#): Completely remove all records for a caller/speaker from a Voice ID domain. All voiceprints and enrollment status is deleted immediately, and associated audio recordings are removed within 24 hours.
3. [ListSpeakers](#): List all the speakers whose entries are present in a Voice ID domain. This API returns both the `CustomerSpeakerId` and `GeneratedSpeakerId` for a speaker. It returns a paginated output with the page size dictated in the API request.
4. [OptOutSpeaker](#): Opt out a caller from a Voice ID domain. This API doesn't require the speaker to be present in Voice ID. A non-existing speaker can be opted-out using this API and Voice ID persists the opted out status and rejects future enrollment requests for this speaker. Opting out also removes voiceprints and any stored audio recordings for this caller.

Watchlist management APIs

1. [CreateWatchlist](#): Create a watchlist that fraudsters can be a part of.
2. [DeleteWatchlist](#): Remove a custom fraudster watchlist from the Voice ID domain. To delete a watchlist, it must be empty. That is, it must not have any fraudsters associated to it. You can use the [DeleteFraudster](#) or [DisassociateFraudster](#) APIs to remove all fraudsters from a watchlist.

You cannot delete the default watchlist from a Voice ID domain.

3. [DescribeWatchlist](#): Determine if it is a default fraudster watchlist, or a custom watchlist that you created, and obtain watchlist details.
4. [ListWatchlists](#): List all the watchlists in the Voice ID domain.
5. [UpdateWatchlist](#): Update the name and description of a custom fraudster watchlist. You cannot modify details of the default watchlist because it's managed by Voice ID.

Fraudster management APIs

1. [AssociateFraudster](#): Associate a fraudster to a watchlist in the same domain. You can associate a fraudster to multiple watchlists in a domain.
2. [DeleteFraudster](#): Delete a fraudster from a Voice ID domain. Deleting the fraudster removes the fraudster from all watchlists it is a part of. It also deletes all voiceprints and associated audio recordings within 24 hours.
3. [DescribeFraudster](#): Describe a fraudster's status in the Voice ID domain.

4. [DisassociateFraudster](#): Disassociate a fraudsters from the watchlist specified. Note that a fraudster always has to be associated with at least one fraudster watchlist; an exception is thrown if you try to disassociate a fraudster from its only watchlist.

To remove the fraudster completely, use `DeleteFraudster`.

5. [ListFraudsters](#): List all the fraudsters in a domain or a specific watchlist. This API also returns the watchlists the fraudster is a part of. It returns a paginated output with the page size dictated in the API request.

Batch enrollment using audio data from prior calls

You can get a jump start on using biometrics by batch enrolling customers who have already consented for biometrics. Using stored audio recordings in your S3 bucket, and a JSON input file that provides the speaker identifier and a link to the audio recordings, you can invoke the [Voice ID batch](#) APIs.

To enroll customers programmatically, pass the following data to the API:

1. The domain ID to specify the domain to associate recordings to.
2. The location for the output file.
3. An input file containing a list of speakers. See [Input and output file schema for Speaker Enrollment Job](#).

For each speaker the file must include:

- A link to a call audio recording in a .wav file with 8KHz sample rate and PCM-16 encoding.
 - The corresponding `CustomerSpeakerId` for the customer.
 - A channel for the caller in the audio recording. If the audio has multiple channels, you can select only one.
4. A KMS key to use when writing the output.
 5. A role that Voice ID can assume. It must have access to the S3 bucket where the audio files are stored. This role must have access to any KMS key used to encrypt the files. It must also be able to write to the specified output location and use the KMS key requested for writing the output. Specifically, it must have the following permissions:
 - `s3:GetObject` on the input bucket.
 - `s3:PutObject` on the output bucket.

- kms:Decrypt on the KMS key used for input bucket's default encryption.
- kms:Decrypt and kms:GenerateDataKey on the KMS key provided in the input which will be used for writing output file to the output bucket.

You must have iam:PassRole permissions when making the call and providing the dataAccessRole. To enable confused deputy protection for the dataAccessRole, see [Amazon Connect Voice ID cross-service confused deputy prevention](#).

6. Optionally, a fraud check skip flag in case you want to skip checks for fraud and voice spoofing on the enrollment audio.
7. Optionally, specify a fraudster watchlist that you want to perform fraud checks against. If no watchlist is specified, Voice ID uses the default fraudster watchlist for the domain.
8. Optionally, the fraud threshold in case you want to raise or lower the risk.
9. Optionally, a flag to re-enroll enrolled customers. This is useful if you want to refresh the audio recording, since the default is to ignore previously enrolled customers.

The batch enrollment returns the CustomerSpeakerId, GeneratedSpeakerId, and associated status for each entry. It stores this data in a JSON file at the output path you specify in the API.

Note

You are charged for enrolling speakers. For more information, see [Amazon Connect Voice ID Pricing](#).

Input and output file schema for Speaker Enrollment Job

Input file schema

Following is the schema of the input manifest file for the Speaker Enrollment Job:

```
{
  "Version": "string",
  "SpeakerEnrollmentRequests": [
    {
      "RequestId": "string",
      "SpeakerId": "string",
      "AudioSpecifications": [
        {
```

```
        "S3Uri": "string",
        "ChannelId": number
      }
    ]
  }
}
```

Note

All the fields in the schema are **required**.

Following is a description of each attribute of the input schema.

- **Version**: The version of the input schema document. Currently, this should be `1.0`.
- **SpeakerEnrollmentRequests**: List of speaker enrollment requests to be fulfilled as part of the job.
 - **RequestId**: An identifier for this speaker enrollment request. It must be unique within the input file. It is used for mapping and identifying entries in the output file.
 - **SpeakerId**: The client-provided identifier of the speaker who needs to be enrolled. You must pass the `CustomerSpeakerId` in this field. The `GeneratedSpeakerId` is not currently supported.
 - **AudioSpecifications**: The list of audio files that Voice ID can use for enrolling this speaker. Voice ID uses these audio files together to gather required amount of speech for enrollment. Currently, the maximum number of audio files allowed for an enrollment request is **10**. Each file can be a `.wav` file up to 20MB, containing audio with 8KHz sample rate and PCM-16 encoding.
 - **S3URI**: The Amazon S3 location of the audio file in `.wav` format that needs to be used for enrolling the speaker.
 - **ChannelId**: The audio channel to be used for enrolling the speaker in a multi-channel audio file. Voice ID supports audio files with up to two channels, so this value is restricted to either **0** or **1**.

Output file schema

Following is the schema of the output file generated for the Speaker Enrollment Job:

```
{
  "Version": "string",
  "Errors": [
    {
      "RequestId": "string",
      "ErrorCode": number,
      "ErrorMessage": "string"
    }
  ],
  "SuccessfulEnrollments": [
    {
      "RequestId": "string",
      "GeneratedSpeakerId": "string",
      "CustomerSpeakerId": "string",
      "EnrollmentStatus": "DUPLICATE_SKIPPED" | "NEW_ENROLLMENT" |
      "ENROLLMENT_OVERWRITE"
    }
  ]
}
```

Following is a description of each attribute of the output schema.

- **Version:** The version of the output schema document. Currently, this should be 1.0.
- **Errors:** The list of errors for the speaker enrollment requests that failed at some point during enrollment.
- **RequestId:** The request identifier associated with this request. This is the same as the RequestId specified in the input file for this request.
- **ErrorCode:** The HTTP error code representing the type of error. Some example error scenarios are described below.

 **Note**

This is not an exhaustive list.

- **400 (Bad Request Exception):**
 - The input JSON file is malformed and cannot be parsed.
 - The provided audio files do not have enough speech for enrollment.
 - Fraud verification checks failed for the given speaker.

- **402 (ServiceQuotaLimitExceededException):**
 - Speaker limit exceeded.
- **409 (Conflict Exception):**
 - Conflicting action: You cannot request an enrollment for an opted out speaker.
- **500 (Internal Failure):**
 - Internal Server Error (Unexpected error on the Service-side).
- **ErrorMessage:** A message describing the cause of the enrollment failure.
- **SuccessfulEnrollments:** The list of enrollment requests that succeeded.
 - **RequestId:** The request identifier associated with this request. This is the same as the `RequestId` specified in the input file for this request.
 - **CustomerSpeakerId:** The client-provided identifier for the speaker who was enrolled.
 - **GeneratedSpeakerId:** The service-generated identifier for the speaker who was enrolled.
 - **EnrollmentStatus:** The status of successful speaker enrollment
 - **DUPLICATE_SKIPPED:** The speaker is already enrolled, and the enrollment was skipped.
 - **NEW_ENROLLMENT:** The speaker was newly enrolled into the system.
 - **ENROLLMENT_OVERWRITE:** The speaker is already enrolled, but was re-enrolled/overwritten using the new audio.

Create and edit a fraudster watchlist

Use the following APIs to create a fraudster watchlist and register fraudsters:

1. Use the [CreateWatchlist](#) API to create new fraudster watchlists.
2. Use the [StartFraudsterRegistrationJob](#) API for batch registration. You can register new fraudsters to the new watchlist, or register them to the default watchlist that is associated with the Voice ID domain.

When registering a new fraudster, Voice ID compares the voiceprint against all registers fraudsters in your Voice ID domain to determine if it is a duplicate of an existing fraudster.

To add fraudsters to a specified fraudster watchlist, pass the following data to the API:

1. The domain ID to specify the domain to associate recordings to.

2. An input file containing a list of fraudsters. See [Input and output file schema for Fraudster Registration Job](#).
3. The location for output file.
4. A KMS key to use when writing the output.
5. A role that Voice ID can assume. It must have access to the S3 bucket where the audio files are stored. This role must have access to any KMS key used to encrypt the files. It must also be able to write to the specified output location and use the KMS key requested for writing the output. Specifically, it must have the following permissions:
 - `s3:GetObject` on the input bucket.
 - `s3:PutObject` on the output bucket.
 - `kms:Decrypt` on the KMS key used for input bucket's default encryption.
 - `kms:Decrypt` and `kms:GenerateDataKey` on the KMS key provided in the input which will be used for writing output file to the output bucket.

You must have `iam:PassRole` permissions when making the call and providing the `dataAccessRole`. To enable confused deputy protection for the `dataAccessRole`, see [Amazon Connect Voice ID cross-service confused deputy prevention](#).

6. A `watchlistId` to register the fraudster to. If no `watchlistId` is specified, fraudsters are registered to the default watchlist for that Voice ID domain.
7. The threshold for establishing the duplicate status of fraudsters.
8. A flag to ignore fraudster duplicates.

Voice ID updates the fraudster list with successful additions, and return a `GeneratedFraudsterID` associated with entry back to the same S3 location. If duplicates are identified, Voice ID returns a "duplicate" status for the entry and provides the closest matching `GeneratedFraudsterId`. After a fraudster is registered successfully, you can associate this fraudster identified by the `GeneratedFraudsterID` into a new watchlist by using the [AssociateFraudster](#) API.

Voice ID is not able to perform detection of fraudsters in a watchlist before the fraudster list is created.

For quotas for the fraudster list, see [Amazon Connect service quotas](#).

Note

You are charged for adding to the fraudster list. For more information, see [Amazon Connect Voice ID Pricing](#).

Input and output file schema for Fraudster Registration Job

Input file schema

Following is the schema of the input manifest file for Fraudster Registration Jobs:

```
{
  "Version": "string",
  "FraudsterRegistrationRequests": [
    {
      "RequestId": "string",
      "AudioSpecifications": [
        {
          "S3Uri": "string",
          "ChannelId": number
        }
      ]
    }
  ]
}
```

Note

All the fields in the schema are **required**.

Following is a description of each attribute of the input schema.

- **Version**: The version of the schema document. Currently, this should be 1.0.
- **FraudsterRegistrationRequests**: List of fraudster registration requests to be fulfilled as part of the job.
 - **RequestId**: An identifier for this fraudster registration request. It must be unique within the input file. It is used for mapping and identifying entries in the output file.

- **AudioSpecifications:** The list of audio files that Voice ID can use for registering this fraudster. Voice ID uses these audio files together to gather required amount of speech for registration. Currently, the maximum number of audio files allowed for a registration request is **10**. Each file can be a .wav file up to 20MB, containing audio with 8KHz sample rate and PCM-16 encoding.
- **S3URI:** The Amazon S3 location of the audio file in .wav format that needs to be used for registering the fraudster.
- **ChannelId:** The audio channel to be used for registering the fraudster in a multi-channel audio file. Voice ID supports audio files with up to two channels, so this value is restricted to either **0** or **1**.

Output file schema

Following is the schema of the output manifest file for Fraudster Registration Jobs:

```
{
  "Version": "string",
  "Errors": [
    {
      "RequestId": "string",
      "ErrorCode": number,
      "ErrorMessage": "string"
    }
  ],
  "SuccessfulRegistrations": [
    {
      "RequestId": "string",
      "GeneratedFraudsterId": "string",
      "RegistrationStatus": "DUPLICATE_SKIPPED" | "NEW_REGISTRATION",
      "FraudsterSimilarityScore": number
    }
  ]
}
```

Following is a description of each attribute of the output schema.

- **Version:** The version of the output schema document. Currently, this should be **1.0**.
- **Errors:** The list of errors for the fraudster registration requests that failed at some point during registration.

- **RequestId:** The request identifier associated with this request. This is the same as the `RequestId` specified in the input file for this request.
- **ErrorCode:** The HTTP error code representing the type of error. Some example error scenarios are described below.

 **Note**

This is not an exhaustive list.

- **400 (Bad Request Exception):**
 - The input JSON file is malformed and cannot be parsed.
 - The provided audio files do not have enough speech for registration.
- **402 (ServiceQuotaLimitExceededException):**
 - Fraudster limit exceeded.
- **500 (Internal Failure):**
 - Internal Server Error (Unexpected error on the Service-side).
- **ErrorMessage:** A message describing the cause of the fraudster registration failure.
- **SuccessfulRegistrations:** The list of registration requests that succeeded.
 - **RequestId:** The request identifier associated with this request. This is the same as the `RequestId` specified in the input file for this request.
 - **RegistrationStatus:** The status of successful fraudster registration.
 - **DUPLICATE_SKIPPED:** The fraudster was identified as a duplicate, and the registration was skipped.
 - **NEW_FRAUDSTER:** The Fraudster was newly enrolled into the system.
 - **GeneratedFraudsterId:** The service-generated identifier for the fraudster who was registered. In case the `RegistrationStatus` is `DUPLICATE_SKIPPED`, this is the identifier of the fraudster already in the domain that is the closest match to the given fraudster.
 - **FraudsterSimilarityScore:** An optional field that is populated when the fraudster registration is skipped due to it being a duplicate. This represents the similarity of the given fraudster with the closest matching fraudster already existing in the domain.

Amazon Connect Streams Voice ID APIs

Use the following [Amazon Connect Streams](#) APIs to integrate Voice ID into your existing agent web applications.

- `enrollSpeakerInVoiceId`: Enroll a customer to Voice ID after obtaining their consent to enroll.
- `evaluateSpeakerWithVoiceId`: Check the customer's Voice ID authentication status, and to detect fraudsters.
- `optOutVoiceIdSpeaker`: Opt out a customer from Voice ID.
- `getVoiceIdSpeakerStatus`: Describe the enrollment status of a customer.
- `getVoiceIdSpeakerId`: Get the `SpeakerID` for a customer.
- `updateVoiceIdSpeakerId`: Update the `SpeakerID` for a customer.

You can also use the Voice ID widget in the Contact Control Panel (CCP) if you don't want to build a custom agent interface. For more information about Voice ID in the CCP, see [Use Voice ID](#).

Voice ID event schema

Voice ID generates events for every transaction: enrollment, authentication, or detection of fraudsters in a watchlist. Events are sent to the EventBridge default event bus.

You can create an analytics pipeline for Voice ID authentication outcomes and detection of fraudsters in a watchlist by using EventBridge to monitor Voice ID events. Using the schema available in this topic, you can configure EventBridge rules to listen and filter for Voice ID events that are relevant, and then process them through Amazon Data Firehose to store in a data warehouse of your choice.

For example, you may want near real-time tracking of Voice ID analysis. To do that, you can pull all the `Evaluate-Session` events, and get the `authenticationResult` and `fraudDetectionResult`.

Events are emitted on a [best effort](#) basis.

Common fields in the event

- `version` - The version of the event data.

- `id` - A unique identifier of the event generated by EventBridge
- `detail-type` - An identifier for the details of the event.
- `source` - The source of the event. This is always `aws.voiceid`.
- `account` - AWS account ID.
- `timestamp` - The date and time that the event was published in UTC.
- `region` - The AWS Region where the API call was made.
- `resources` - Resources used by the API call.
- `detail` - Details about the event:
 - `detail.sourceId` - A unique ID generated by Voice ID that you can use for de-duplication.
 - `detail.action` - Analogous to the API being invoked.
 - `detail.status` - Specifies the status of the action: success or failure.
 - `detail.errorInfo` - Is populated when the specified action errors out at Voice ID.

Following are the schemas for the events are that emitted.

Start Session Action

Emits events on stream start (after setup), stream end, and on failures.

```
{...commonfields
  "detail-type": "VoiceId Start Session Action",
  "detail": {
    "sourceId": String,
    "action": "START_SESSION",
    "status": String,
    "domainId": String,
    "session": {
      "sessionId": String,
      "sessionName": String,
      "authenticationConfiguration": {
        "acceptanceThreshold": Integer
      },
      "fraudDetectionConfiguration": {
        "riskThreshold": Integer,
        "watchlistId": String
      },
      "streamingConfiguration": {
        "authenticationMinimumSpeechInSeconds": Integer
```

```

    },
    "enrollmentAudioProgress": {
      "audioAggregationStatus": String,
      "audioAggregationStartedAt": "Timestamp",
      "audioAggregationEndedAt": "Timestamp"
    },
    "authenticationAudioProgress": {
      "audioAggregationStartedAt": "Timestamp",
      "audioAggregationEndedAt": "Timestamp"
    },
    "fraudDetectionAudioProgress": {
      "audioAggregationStartedAt": "Timestamp",
      "audioAggregationEndedAt": "Timestamp"
    },
    "generatedSpeakerId": String
  },
  "errorInfo": {
    "errorMessage": String,
    "errorType": String,
    "errorCode": Integer
  }
}
}
}

```

Update Session Action

Emits events when the internal session update succeeds or fails.

```

{...commonfields
"detail-type": "VoiceId Update Session Action",
"detail": {
  "sourceId": String,
  "action": "UPDATE_SESSION",
  "status": String,
  "domainId": String,
  "session": {
    "sessionId": String,
    "sessionName": String,
    "authenticationConfiguration": {
      "acceptanceThreshold": Integer
    },
    "fraudDetectionConfiguration": {
      "riskThreshold": Integer,

```

```

        "watchlistId": String
    },
    "streamingConfiguration": {
        "authenticationMinimumSpeechInSeconds": Integer
    },
    "generatedSpeakerId": String
},
"errorInfo": {
    "errorMessage": String,
    "errorType": String,
    "errorCode": Integer
}
}
}

```

Evaluate Session Action

Emits events when the session evaluation succeeds or fails. Reasons can be `KNOWN_FRAUDSTER` or `VOICE_SPOOFING`.

```

{...commonfields
"detail-type": "VoiceId Evaluate Session Action",
"detail": {
    "sourceId": String,
    "action": "EVALUATE_SESSION",
    "status": String,
    "domainId": String,
    "session": {
        "sessionId": String,
        "sessionName": String,
        "generatedSpeakerId": String,
        "streamingStatus": String,
        "authenticationResult": {
            "authenticationResultId": String,
            "decision": String,
            "score": Integer,
            "audioAggregationStartedAt": "Timestamp",
            "audioAggregationEndedAt": "Timestamp",
            "configuration": {
                "acceptanceThreshold": Integer
            }
        },
        "fraudDetectionResult": {

```

```

    "fraudDetectionResultId": String,
    "decision": String,
    "reasons": [String],
    "audioAggregationStartedAt": "Timestamp",
    "audioAggregationEndedAt": "Timestamp",
    "configuration": {
        "riskThreshold": Integer
    },
    "riskDetails": {
        "knownFraudsterRisk": {
            "generatedFraudsterId": String,
            "riskScore": Integer,
            "watchlistId": String
        },
        "voiceSpoofingRisk": {
            "riskScore": Integer
        }
    }
},
"errorInfo": {
    "errorMessage": String,
    "errorType": String,
    "errorCode": Integer
}
}
}

```

Speaker Action

Emits events on the success or failure to opt out a speaker, delete a speaker, or enroll a speaker.

```

{...commonfields
"detail-type": "VoiceId Speaker Action",
"detail": {
    "sourceId": String,
    "domainID": String,
    "action": String,
    "status": String,
    "generatedSpeakerId": String,
    "data": {
        "enrollmentSource": String,
        "enrollmentSourceId": String,

```



```

        "enrollmentStatus": String
    },
    "errorInfo": {
        "errorMessage": String,
        "errorType": String,
        "errorCode": Integer
    }
}
}

```

Fraudster Action

Emits events when a fraudster is successfully registered or deleted.

Events are not sent when a fraudster is associated or disassociated with a watchlist.

```

{...commonfields
"detail-type": "VoiceId Fraudster Action",
"detail": {
    "sourceId": String,
    "domainID": String,
    "action": String,
    "status": String,
    "generatedFraudsterId": String,
    "watchlistIds": [String],
    "data": {
        "registrationSource": String,
        "registrationSourceId": String,
        "registrationStatus": String
    },
    "errorInfo": {
        "errorMessage": String,
        "errorType": String,
        "errorCode": Integer
    }
}
}
}

```

EnrollBySession

Emits this event when an enrollment request is submitted. A `Speaker` event is emitted when the actual enrollment succeeds or fails.

```
{...commonfields
"detail-type": "VoiceId Session Speaker Enrollment Action",
"detail": {
  "sourceId": String,
  "domainId": String,
  "action": "SESSION_ENROLLMENT_REQUEST",
  "status": String,
  "sessionId": String,
  "sessionName": String,
  "errorInfo": {
    "errorMessage": String,
    "errorType": String,
    "errorCode": Integer
  }
}
}
```

StartSpeakerEnrollmentJob

Emits this event when a batch enrollment request is submitted, succeeds, or fails. A `Speaker` event is emitted for each of the individual speakers to indicate if corresponding enrollment succeeds or fails.

```
{...commonfields
"detail-type": "VoiceID Batch Speaker Enrollment Action",
"detail": {
  "sourceId": String,
  "domainId": String,
  "action": "BATCH_ENROLLMENT_REQUEST",
  "status": String,
  "batchJobId": String,
  "data": {
    "dataAccessRoleArn": String,
    "enrollmentConfig": {
      "existingEnrollmentAction": String,
      "fraudDetectionConfig": {
        "fraudDetectionAction": String,
        "riskThreshold": Integer,
        "watchlistIds": [String],
      }
    },
    "inputDataConfig": {
```

```

        "s3Uri": String
      },
      "outputDataConfig": {
        "s3Uri": String,
        "kmsKeyId": String
      }
    },
    "errorInfo": {
      "errorMessage": String,
      "errorType": String,
      "errorCode": Integer
    }
  }
}
}

```

StartFraudsterRegistrationJob

Emits this event when a batch registration request is submitted, succeeds, or fails. A Fraudster event is emitted for each of the individual fraudsters to indicate if corresponding registration succeeds or fails.

```

{...commonfields
"detail-type": "VoiceId Batch Fraudster Registration Action",
"detail": {
  "sourceId": String,
  "domainId": String,
  "action": "BATCH_REGISTRATION_REQUEST",
  "status": String,
  "batchJobId": String,
  "data": {
    "dataAccessRoleArn": String,
    "registrationConfig": {
      "duplicateRegistrationAction": String,
      "fraudsterSimilarityThreshold": Integer,
      "watchlistIds": [String],
    }
  },
  "inputDataConfig": {
    "s3Uri": String
  },
  "outputDataConfig": {
    "s3Uri": String,
    "kmsKeyId": String
  }
}
}

```

```
    },  
    "errorInfo": {  
        "errorMessage": String,  
        "errorType": String,  
        "errorCode": Integer  
    }  
}  
}
```

Security in Amazon Connect

Cloud security at AWS is the highest priority. As an AWS customer, you benefit from a data center and network architecture that is built to meet the requirements of the most security-sensitive organizations.

Security is a shared responsibility between AWS and you. The [shared responsibility model](#) describes this as security *of* the cloud and security *in* the cloud:

- **Security of the cloud** – AWS is responsible for protecting the infrastructure that runs AWS services in the AWS Cloud. AWS also provides you with services that you can use securely. Third-party auditors regularly test and verify the effectiveness of our security as part of the [AWS compliance programs](#). To learn about the compliance programs that apply to Amazon Connect, see [AWS Services in Scope by Compliance Program](#).
- **Security in the cloud** – Your responsibility is determined by the AWS service that you use. You are also responsible for other factors including the sensitivity of your data, your company's requirements, and applicable laws and regulations.

This documentation helps you understand how to apply the shared responsibility model when using Amazon Connect. The following topics show you how to configure Amazon Connect to meet your security and compliance objectives. You also learn how to use other AWS services that help you to monitor and secure your Amazon Connect resources.

Contents

- [Data protection in Amazon Connect](#)
- [Identity and access management for Amazon Connect](#)
- [Logging and monitoring Amazon Connect](#)
- [Tag resources in Amazon Connect](#)
- [Compliance validation in Amazon Connect](#)
- [Resilience in Amazon Connect](#)
- [Infrastructure security in Amazon Connect](#)
- [Cross-service confused deputy prevention](#)
- [Security Best Practices for Amazon Connect](#)

Data protection in Amazon Connect

The AWS [shared responsibility model](#) applies to data protection in Amazon Connect. As described in this model, AWS is responsible for protecting the global infrastructure that runs all of the AWS Cloud. You are responsible for maintaining control over your content that is hosted on this infrastructure. You are also responsible for the security configuration and management tasks for the AWS services that you use. For more information about data privacy, see the [Data Privacy FAQ](#). For information about data protection in Europe, see the [AWS Shared Responsibility Model and GDPR](#) blog post on the *AWS Security Blog*.

For data protection purposes, we recommend that you protect AWS account credentials and set up individual users with AWS IAM Identity Center or AWS Identity and Access Management (IAM). That way, each user is given only the permissions necessary to fulfill their job duties. We also recommend that you secure your data in the following ways:

- Use multi-factor authentication (MFA) with each account.
- Use SSL/TLS to communicate with AWS resources. We require TLS 1.2 and recommend TLS 1.3.
- Set up API and user activity logging with AWS CloudTrail.
- Use AWS encryption solutions, along with all default security controls within AWS services.
- Use advanced managed security services such as Amazon Macie, which assists in discovering and securing sensitive data that is stored in Amazon S3.
- If you require FIPS 140-2 validated cryptographic modules when accessing AWS through a command line interface or an API, use a FIPS endpoint. For more information about the available FIPS endpoints, see [Federal Information Processing Standard \(FIPS\) 140-2](#).

We strongly recommend that you never put confidential or sensitive information, such as your customers' email addresses, into tags or free-form text fields such as a **Name** field. This includes when you work with Amazon Connect or other AWS services using the console, API, AWS CLI, or AWS SDKs. Any data that you enter into tags or free-form text fields used for names may be used for billing or diagnostic logs. If you provide a URL to an external server, we strongly recommend that you do not include credentials information in the URL to validate your request to that server.

Contents

- [Data handled by Amazon Connect](#)
- [Encryption at rest](#)

- [Encryption in transit](#)
- [Key management](#)
- [Amazon Connect and interface VPC endpoints \(AWS PrivateLink\)](#)
- [Opt out of using your data for service improvement](#)

Data handled by Amazon Connect

Data held within Amazon Connect is segregated by the AWS account ID and the Amazon Connect instance ID. This ensures that data can be accessed only by the authorized users of a specific Amazon Connect instance.

Amazon Connect handles a variety of data related to the contact center, including but not limited to the following categories.

- **Resources and configurations** -- This includes queues, flows, users, routing profiles, and task templates.
- **Contact metadata**-- This includes connection time, handle time, source number (ANI), destination number (DNIS), and user defined contact attributes.
- **Agent-related performance data** -- This includes login time, status changes, and contacts handled.
- **Phone call audio streams** -- When enabled, this also includes call recordings.
- **Chat transcripts** – Included only if enabled in flows.
- **Screen recordings** – Included only if enabled in flows.
- **Attachments** – Included only if enabled at the instance level.
- **Integration configuration** – Includes user defined name, description and metadata when creating integration with external applications.
- **Knowledge documents** – This includes documents used by agents to handle contacts.
- **Voiceprints** – When Amazon Connect Voice ID is enabled, a voiceprint is created from the customer's voice for future authentication. Similarly, a voiceprint is created while registering a fraudster in the Voice ID system for future fraud detection.
- **Speaker and Fraudster Audio** – When Amazon Connect Voice ID is enabled, the audio used for enrolling speakers and registering fraudsters is stored so that Voice ID can re-enroll and reregister them in future when there is a need to do so.

- **Forecasts, capacity plans, and schedules** – Included only if enabled and created.

Amazon Connect stores the following Personally Identifiable Information (PII) data related to your customers:

- The customer's phone number: ANI for inbound calls, and DNIS for outbound calls or transfers.
- If you are using Amazon Connect Customer Profiles, all this data could potentially be PII. This data is always encrypted at rest using either a customer managed key or an AWS owned key. The Amazon Connect Customer Profiles data is segregated by the AWS account ID and the domain. Multiple Amazon Connect instances can share a single Customer Profiles domain.
- For outbound campaigns, Amazon Pinpoint passes customer phone numbers and relevant attributes to Amazon Connect. On the Amazon Connect side, these are always encrypted at rest using either a customer managed key or an AWS owned key. The outbound campaigns data is segregated by the Amazon Connect instance ID and are encrypted by instance-specific keys.

External application data

Amazon AppIntegrations enables you to integrate with external applications. It stores references to other AWS resources and client-service specified metadata. No data is stored other than incidentally while being processed. When syncing data periodically with an Amazon Connect service, data is encrypted using a customer managed key and stored temporarily for one month.

Phone call media

Amazon Connect is in the audio path for calls handled by the service. It is therefore responsible for relaying the call's media stream between participants. This can include the audio between a customer and a flow / IVR, the audio between a customer and an agent, or mixing the audio between multiple parties in a conference or during a transfer. There are two types of phone calls:

- PSTN calls. This includes inbound customer calls, outbound calls placed by agents to customers, and calls to an agent's physical phone, if this option has been enabled in the Contact Control Panel (CCP).
- Softphone calls placed to the agent's browser.

PSTN calls are connected between Amazon Connect and various telecommunications carriers using either private circuits maintained between Amazon Connect and our providers or existing AWS

internet connectivity. For PSTN calls routed over the public internet, signaling is encrypted with TLS and the audio media is encrypted with SRTP.

Softphone calls are established to the agent's browser with an encrypted WebSocket connection using TLS. The audio media traffic to the browser is encrypted in transit using DTLS-SRTP.

Call recordings and screen recordings

At the instance-level, by default the call recording and screen recording capabilities are available when an Amazon S3 bucket is created for them. You determine which contacts are recorded by specifying it in the flows. This allows for more detailed control over which contacts are recorded.

Note the following behavior for call recordings:

- The call recording feature has options for choosing whether to record the agent only, customer only, or agent and customer conversations.
- A conversation is recorded only when the contact is connected to an agent. The contact is not recorded before then, when they are connected to the flow.
- Audio is NOT transmitted to Amazon Connect or recorded when the agent is not on a call. On November 9, 2023, Amazon Connect deployed an optimization to improve agent productivity that pre-configures the microphone media stream of the agent's browser before the contact arrives. This reduces setup time for both incoming and outgoing calls. As a result, the microphone icon in the agent's browser appears to be on, even when the agent is not on a call.
- When call recording is enabled, the recording begins when the call is connected to an agent and stops when the agent disconnects.
- When a customer is on hold, the agent is still recorded.
- The transfer conversation between agents is recorded.
- Any transfers to external numbers are not recorded after the agent leaves the call.
- If the agent mutes their own microphone, for example, to consult with a coworker sitting next to them, their side-bar conversation is not recorded. The customer is still recorded since their microphone hasn't been muted.
- To record the customer when they are not connected to an agent, for example, if all of their interaction is with a Lex bot, use media streaming.

Screen recording only records the agent's screen if the contact is enabled for screen recording. Screen recording begins when the agent accepts a contact and ends with the agent completes the after contact work. Screen recording supports the voice, chat, and task channels.

You can limit access to the call and screen recordings based on user permissions. Recordings can be searched and played back within the Amazon Connect admin website.

Call recording and screen recording storage

Call and screen recordings are stored in two phases:

- Recordings intermediately held within Amazon Connect during and after the contact, but before delivery.
- Recordings delivered to your Amazon S3 bucket.

The recordings that are stored in your Amazon S3 bucket are secured using a KMS key that was configured when your instance was created.

At all times, you maintain full control over the security of call recordings delivered to your Amazon S3 bucket.

Access to call recordings and screen recordings

You can search for and listen to call recordings or view screen recordings in Amazon Connect. To determine which users can do this, assign them the appropriate permissions in their security profile. If AWS CloudTrail is enabled, access to specific recordings by Amazon Connect users is captured in CloudTrail.

The capabilities of Amazon S3, AWS KMS, and IAM put you in full control of who has access to call recording data.

Contact metadata

Amazon Connect stores metadata related to contacts that flow through the system and allows authorized users to access this information. The Contact Search feature allows you to search and view contact data, such as origination phone numbers or other attributes set by the flow, that are associated with a contact for diagnostics or reporting purposes.

Contact data classified as PII that is stored by Amazon Connect is encrypted at rest using a key that is time-limited and specific to the Amazon Connect instance. Specifically, the customer origination phone number is cryptographically hashed with a key that is specific to the instance to allow for use in contact search. For contact search, the encryption key is not time-sensitive.

The following data stored by Amazon Connect is treated as sensitive:

- Origination phone number
- Outbound phone number
- External numbers dialed by agents for transfers
- External numbers transferred to by a flow
- Contact name
- Contact description
- All contact attributes
- All contact references

Contact Lens real-time processing

Content processed by Contact Lens in real-time is encrypted at rest and in transit. Data is encrypted with keys owned by Contact Lens.

Voiceprints and Voice ID audio recordings

When you enable Amazon Connect Voice ID, it computes voiceprints out of your customer's speech for authenticating them in future, and stores the data. Similarly, when you enable fraud detection, it stores the voiceprint for each fraudster registered in Voice ID.

While enrolling a customer into Voice ID for authentication and fraud detection, you must specify a `CustomerSpeakerId` for them. Since Voice ID stores biometric information for each speaker, we strongly recommend that you use an identifier that does not contain PII in the `CustomerSpeakerId` field.

Speaker and Fraudster Audio

When you enable Amazon Connect Voice ID, it stores a compacted version of the audio (called utterances) that it aggregated while enrolling a speaker or registering a fraudster. This audio is used in the future whenever the voiceprints for the speakers and fraudsters need to be regenerated. The data is retained until the speaker/fraudster is deleted. The original audio used for enrollment or evaluation is deleted after a 24 hour retention period.

The data is retained until the speaker/fraudster is deleted or opted out.

Outbound campaigns

For outbound campaigns, Amazon Pinpoint passes customer phone numbers and relevant attributes to Amazon Connect. On Amazon Connect, these are always encrypted at rest using either a customer managed key or an AWS owned key. The outbound campaigns data is segregated by the Amazon Connect instance ID and are encrypted by instance specific keys.

Task templates

Any processing of task template resources in Amazon Connect is encrypted at rest and in transit. Data is encrypted with an AWS KMS key.

Forecasts, Capacity Plans, and Schedules

When forecasts, capacity plans, and schedules are generated, they are always encrypted at rest and in transit. Data is encrypted with an AWS KMS key.

Encryption at rest

Contact data classified as PII, or data that represents customer content being stored by Amazon Connect, is encrypted at rest (that is, before it is put, stored, or saved to a disk) using AWS KMS encryption keys owned by AWS. For information about AWS KMS keys, see [What is AWS Key Management Service?](#) in the *AWS Key Management Service Developer Guide*. Contact data in non-temporary storage is encrypted such that data encryption keys generated from the KMS keys are not shared across Amazon Connect instances.

Amazon S3 server-side encryption is used to encrypt conversation recordings (voice and chat). Call recordings, screen recordings, and transcripts are stored in two phases:

- Recordings intermediately held within Amazon Connect during and after the contact, but before delivery.
- Recordings delivered to your Amazon S3 bucket.

The recordings and chat transcripts that are stored in your Amazon S3 bucket are secured using a KMS key that was configured when your instance was created.

Contents

- [Amazon AppIntegrations data encryption at rest](#)

- [Amazon Connect Cases encryption at rest](#)
- [Amazon Connect Customer Profiles encryption at rest](#)
- [Amazon Q in Connect encryption at rest](#)
- [Amazon Connect Voice ID encryption at rest](#)
- [Outbound campaigns](#)
- [Forecasts, capacity plans, and schedules](#)

Amazon AppIntegrations data encryption at rest

When you create a DataIntegration encrypted with a customer managed key, Amazon AppIntegrations creates a grant on your behalf by sending a `CreateGrant` request to AWS KMS. Grants in AWS KMS are used to give Amazon AppIntegrations access to a KMS key in your account.

You can revoke access to the grant, or remove the access that Amazon AppIntegrations has to the customer managed key at any time. If you do, Amazon AppIntegrations can not access any of the data encrypted by the customer managed key, which affects operations that are dependent on that data.

External application data that Amazon AppIntegrations processes is encrypted at rest in an S3 bucket using the customer managed key that you provided during configuration. Integration configuration data is encrypted at rest using a key that is time-limited and specific to the user account.

Amazon AppIntegrations requires the grant to use the customer managed key for the following internal operations:

- Send `GenerateDataKeyRequest` to AWS KMS to generate data keys encrypted by your customer managed key.
- Send `Decrypt` requests to AWS KMS to decrypt encrypted data keys so that they can be used to encrypt your data.

Amazon Connect Cases encryption at rest

All customer provided data in case fields, case comments, descriptions of the fields and templates stored by Amazon Connect Cases is encrypted at rest using encryption keys stored in AWS Key Management Service (AWS KMS).

Amazon Connect Cases service owns, manages, monitors, and rotates the encryption keys (that is, AWS owned keys) to meet the high security standards. Payload of the case event streams is temporarily (typically for a few seconds) stored in Amazon EventBridge before it is made available through the default-bus in customers account. EventBridge also encrypts the entire payload at rest using AWS owned keys.

Amazon Connect Customer Profiles encryption at rest

All user data stored in Amazon Connect Customer Profiles is encrypted at rest. Amazon Connect Customer Profiles encryption at rest provides enhanced security by encrypting all your data at rest using encryption keys stored in AWS Key Management Service (AWS KMS). This functionality helps reduce the operational burden and complexity involved in protecting sensitive data. With encryption at rest, you can build security-sensitive applications that meet strict encryption compliance and regulatory requirements.

Organizational policies, industry or government regulations, and compliance requirements often require the use of encryption at rest to increase the data security of your applications. Customer Profiles integrated with AWS KMS to enable its encryption at rest strategy. For more information, see [AWS Key Management Service Concepts](#) in the AWS Key Management Service Developer Guide.

When creating a new domain, you must provide a [KMS key](#) that the service will use to encrypt your data in transit and at rest. The customer managed key is created, owned, and managed by you. You have full control over the customer managed key (AWS KMS charges apply).

You can specify an encryption key when you create a new domain or profile object type or switch the encryption keys on an existing resources by using the AWS Command Line Interface (AWS CLI), or the Amazon Connect Customer Profiles Encryption API. When you choose a customer managed key, Amazon Connect Customer Profiles creates a grant to the customer managed key that grants it access to the customer managed key.

AWS KMS charges apply for a customer managed key. For more information about pricing, see [AWS KMS pricing](#).

Amazon Q in Connect encryption at rest

All user data stored in Amazon Q in Connect is encrypted at rest using encryption keys stored in AWS Key Management Service. If you optionally provide a customer managed key, Amazon Q in Connect uses it to encrypt knowledge content stored at rest outside of Amazon Q in Connect search indices. Amazon Q in Connect uses dedicated search indices per customer and they are

encrypted at rest by using AWS owned keys stored in AWS Key Management Service. Additionally, you can use CloudTrail to audit any data access using the Amazon Q in Connect APIs.

AWS KMS charges apply when using a key that you provide. For more information about pricing, see [AWS KMS pricing](#).

Amazon Connect Voice ID encryption at rest

Amazon Connect Voice ID stores customer voiceprints which cannot be reverse-engineered to obtain the enrolled customer's speech or identify a customer. All user data stored in Amazon Connect Voice ID is encrypted at rest. When creating a new Voice ID domain, you must provide a customer managed key that the service uses to encrypt your data at rest. The customer managed key is created, owned, and managed by you. You have full control over the key.

You can update the KMS key in the Voice ID domain by using the `update-domain` command in AWS Command Line Interface (AWS CLI), or the [UpdateDomain](#) Voice ID API.

When you change the KMS key, an asynchronous process will be triggered to re-encrypt the old data with the new KMS key. After this process completes, all of your domain's data will be encrypted under the new KMS key, and you may safely retire the old key. For more information, see [UpdateDomain](#).

Voice ID creates a grant to the customer managed key that grants it access to the key. For more information, see [How Amazon Connect Voice ID uses grants in AWS KMS](#).

Following is a list of data that is encrypted at rest using the customer managed key:

- **Voiceprints:** The voiceprints generated while enrolling the speakers and registering fraudsters into the system.
- **Speaker and fraudster audio:** The audio data used for enrolling the speakers and registering the fraudsters.
- **CustomerSpeakerId:** The customer-provided SpeakerId while enrolling the customer into Voice ID.
- **Customer-provided metadata:** These include free-form strings such as Domain Description, Domain Name, Job Name, and more.

AWS KMS charges apply for a customer managed key. For more information about pricing, see [AWS KMS pricing](#).

How Amazon Connect Voice ID uses grants in AWS KMS

Amazon Connect Voice ID requires a grant to use your customer managed key. When you create a domain, Voice ID creates a grant on your behalf by sending a [CreateGrant](#) request to AWS KMS. The grant is required to use your customer managed key for the following internal operations:

- Send [DescribeKey](#) requests to AWS KMS to verify that the symmetric customer managed key ID provided is valid.
- Send [GenerateDataKey](#) requests to KMS key to create data keys with which to encrypt objects.
- Send [Decrypt](#) requests to AWS KMS to decrypt the encrypted data keys so that they can be used to encrypt your data.
- Send [ReEncrypt](#) requests to AWS KMS when the key is updated to re-encrypt a limited set of data using the new key.
- Store files in S3 using the AWS KMS key to encrypt the data.

You can revoke access to the grant, or remove the service's access to the customer managed key at any time. If you do, Voice ID won't be able to access any of the data encrypted by the customer managed key, which affects all the operations that are dependent on that data, leading to `AccessDeniedException` errors and failures in the asynchronous workflows.

Customer managed key policy for Voice ID

Key policies control access to your customer managed key. Every customer managed key must have exactly one key policy, which contains statements that determine who can use the key and how they can use it. When you create your customer managed key, you can specify a key policy. For more information, see [Managing access to KMS keys](#) in the *AWS Key Management Service Developer Guide*.

Following is an example key policy which gives a user the permissions they need to call all Voice ID APIs using the customer managed key:

```
{
  "Version": "2012-10-17",
  "Statement": [
    {
      "Sid": "Allow key access to Amazon Connect VoiceID.",
      "Effect": "Allow",
      "Principal": {
```



```

        "AWS": "your_user_or_role_ARN"
    },
    "Action": [
        "kms:CreateGrant",
        "kms:Decrypt",
        "kms:DescribeKey"
    ],
    "Resource": "*",
    "Condition": {
        "StringEquals": {
            "kms:ViaService": [
                "voiceid.region.amazonaws.com"
            ]
        }
    }
}

```

For information about specifying permissions in a policy, see [Specifying KMS keys in IAM policy statements](#) in the AWS Key Management Service Developer Guide.

For information about troubleshooting key access, see [Troubleshooting key access](#) in the AWS Key Management Service Developer Guide.

Voice ID encryption context

An [encryption context](#) is an optional set of key-value pairs that contain additional contextual information about the data. AWS KMS uses the encryption context as [additional authenticated data](#) to support [authenticated encryption](#).

When you include an encryption context in a request to encrypt data, AWS KMS binds the encryption context to the encrypted data. To decrypt data, you include the same encryption context in the request.

Voice ID uses the same encryption context in all AWS KMS cryptographic operations, where the key is `aws:voiceid:domain:arn` and the value is the resource Amazon Resource Name (ARN) [Amazon Resource Name \(ARN\)](#).

```

"encryptionContext": {
    "aws:voiceid:domain:arn": "arn:aws:voiceid:us-west-2:111122223333:domain/sampleDomainId"
}

```

```
}
```

You can also use the encryption context in audit records and logs to identify how the customer managed key is being used. The encryption context also appears in logs generated by CloudTrail or Amazon CloudWatch Logs.

Using encryption context to control access to your customer managed key

You can use the encryption context in key policies and IAM policies as conditions to control access to your symmetric customer managed key. You can also use encryption context constraints in a grant.

Amazon Connect Voice ID uses an encryption context constraint in grants to control access to the customer managed key in your account or Region. The grant constraint requires that the operations that the grant allows use the specified encryption context.

The following are example key policy statements to grant access to a customer managed key for a specific encryption context. The condition in this policy statement requires that the grants have an encryption context constraint that specifies the encryption context.

```
{
  "Sid": "Enable DescribeKey",
  "Effect": "Allow",
  "Principal": {
    "AWS": "arn:aws:iam::111122223333:role/ExampleReadOnlyRole"
  },
  "Action": "kms:DescribeKey",
  "Resource": "*"
},
{
  "Sid": "Enable CreateGrant",
  "Effect": "Allow",
  "Principal": {
    "AWS": "arn:aws:iam::111122223333:role/ExampleReadOnlyRole"
  },
  "Action": "kms:CreateGrant",
  "Resource": "*",
  "Condition": {
    "StringEquals": {
      "kms:EncryptionContext:aws:voiceid:domain:arn": "arn:aws:voiceid:us-west-2:111122223333:domain/sampleDomainId"
    }
  }
}
```

```
}
}
```

Monitoring your encryption keys for Voice ID

When you use an AWS KMS customer managed key with Voice ID, you can use [AWS CloudTrail](#) or [Amazon CloudWatch Logs](#) to track requests that Voice ID sends to AWS KMS.

The following examples is a sample AWS CloudTrail event for CreateGrant operation called by Voice ID to access data encrypted by your customer managed key:

CreateGrant

```
{
  "eventVersion": "1.08",
  "userIdentity": {
    "type": "AssumedRole",
    "principalId": "AR0A5STZEFPSZE0W7NP3X:SampleUser1",
    "arn": "arn:aws:sts::111122223333:assumed-role/SampleRole/SampleUser",
    "accountId": "111122223333",
    "accessKeyId": "AAAAAAAA11111111EXAMPLE",
    "sessionContext": {
      "sessionIssuer": {
        "type": "Role",
        "principalId": "AR0A5STZEFPSZE0W7NP3X",
        "arn": "arn:aws:iam::111122223333:role/SampleRole",
        "accountId": "111122223333",
        "userName": "SampleUser"
      },
      "webIdFederationData": {},
      "attributes": {
        "creationDate": "2021-09-14T23:02:23Z",
        "mfaAuthenticated": "false"
      }
    }
  },
  "invokedBy": "voiceid.amazonaws.com"
},
"eventTime": "2021-09-14T23:02:50Z",
"eventSource": "kms.amazonaws.com",
"eventName": "CreateGrant",
"awsRegion": "us-west-2",
"sourceIPAddress": "SampleIpAddress",
"userAgent": "Example Desktop/1.0 (V1; OS)",
```

```

"requestParameters": {
  "constraints": {
    "encryptionContextSubset": {
      "aws:voiceid:domain:arn": "arn:aws:voiceid:us-
west-2:111122223333:domain/sampleDomainId"
    }
  },
  "retiringPrincipal": "voiceid.amazonaws.com",
  "keyId": "arn:aws:kms:us-west-2:111122223333:key/44444444-3333-2222-1111-
EXAMPLE11111",
  "operations": [
    "CreateGrant",
    "Decrypt",
    "DescribeKey",
    "GenerateDataKey",
    "GenerateDataKeyPair",
    "GenerateDataKeyPairWithoutPlaintext",
    "GenerateDataKeyWithoutPlaintext",
    "ReEncryptFrom",
    "ReEncryptTo"
  ],
  "granteePrincipal": "voiceid.amazonaws.com "
},
"responseElements": {
  "grantId":
"00000000000000000000000000000000cce47be074a8c379ed39f22b155c6e86af82"
},
"requestID": "ed0fe4ab-305b-4388-8adf-7e8e3a4e80fe",
"eventID": "31d0d7c6-ce5b-4caf-901f-025bf71241f6",
"readOnly": false,
"resources": [
  {
    "accountId": "111122223333",
    "type": "AWS::KMS::Key",
    "ARN": "arn:aws:kms:us-
west-2:111122223333:key/00000000-1111-2222-3333-999999999999"
  }
],
"eventType": "AwsApiCall",
"managementEvent": true,
"recipientAccountId": "111122223333",
"eventCategory": "Management"
}

```

DescribeKey

```
{
  "eventVersion": "1.08",
  "userIdentity": {
    "type": "AWSService",
    "invokedBy": "voiceid.amazonaws.com"
  },
  "eventTime": "2021-10-13T15:12:39Z",
  "eventSource": "kms.amazonaws.com",
  "eventName": "DescribeKey",
  "awsRegion": "us-west-2",
  "sourceIPAddress": "voiceid.amazonaws.com",
  "userAgent": "voiceid.amazonaws.com",
  "requestParameters": {
    "keyId": "alias/sample-key-alias"
  },
  "responseElements": null,
  "requestID": "ed0fe4ab-305b-4388-8adf-7e8e3a4e80fe",
  "eventID": "31d0d7c6-ce5b-4caf-901f-025bf71241f6",
  "readOnly": true,
  "resources": [{
    "accountId": "111122223333",
    "type": "AWS::KMS::Key",
    "ARN": "arn:aws:kms:us-west-2:111122223333:key/00000000-1111-2222-3333-999999999999"
  }],
  "eventType": "AwsApiCall",
  "managementEvent": true,
  "recipientAccountId": "111122223333",
  "eventCategory": "Management"
}
```

Decrypt

```
{
  "eventVersion": "1.08",
  "userIdentity": {
    "type": "AWSService",
    "invokedBy": "voiceid.amazonaws.com"
  },
  "eventTime": "2021-10-12T23:59:34Z",
  "eventSource": "kms.amazonaws.com",
```

```

"eventName": "Decrypt",
"awsRegion": "us-west-2",
"sourceIPAddress": "voiceid.amazonaws.com",
"userAgent": "voiceid.amazonaws.com",
"requestParameters": {
  "encryptionContext": {
    "keyId": "arn:aws:kms:us-
west-2:111122223333:key/44444444-3333-2222-1111-EXAMPLE11111",
    "encryptionContext": {
      "aws:voiceid:domain:arn": "arn:aws:voiceid:us-
west-2:111122223333:domain/sampleDomainId"
    },
    "encryptionAlgorithm": "SYMMETRIC_DEFAULT"
  },
  "responseElements": null,
  "requestID": "ed0fe4ab-305b-4388-8adf-7e8e3a4e80fe",
  "eventID": "31d0d7c6-ce5b-4caf-901f-025bf71241f6",
  "readOnly": true,
  "resources": [{
    "accountId": "111122223333",
    "type": "AWS::KMS::Key",
    "ARN": "arn:aws:kms:us-
west-2:111122223333:key/00000000-1111-2222-3333-999999999999"
  }],
  "eventType": "AwsApiCall",
  "managementEvent": true,
  "recipientAccountId": "111122223333",
  "sharedEventID": "35d58aa1-26b2-427a-908f-025bf71241f6",
  "eventCategory": "Management"
}

```

GenerateDataKeyWithoutPlaintext

```

{
  "eventVersion": "1.08",
  "userIdentity": {
    "type": "AWSService",
    "invokedBy": "voiceid.amazonaws.com"
  },
  "eventTime": "2021-10-13T00:26:41Z",
  "eventSource": "kms.amazonaws.com",
  "eventName": "GenerateDataKeyWithoutPlaintext",
  "awsRegion": "us-west-2",

```

```

    "sourceIPAddress": "voiceid.amazonaws.com",
    "userAgent": "voiceid.amazonaws.com",
    "requestParameters": {
      "keyId": "arn:aws:kms:us-west-2:111122223333:key/44444444-3333-2222-1111-EXAMPLE11111",
      "encryptionContext": {
        "aws:voiceid:domain:arn": "arn:aws:voiceid:us-west-2:111122223333:domain/sampleDomainId"
      },
      "keySpec": "AES_256"
    },
    "responseElements": null,
    "requestID": "ed0fe4ab-305b-4388-8adf-7e8e3a4e80fe",
    "eventID": "31d0d7c6-ce5b-4caf-901f-025bf71241f6",
    "readOnly": true,
    "resources": [{
      "accountId": "111122223333",
      "type": "AWS::KMS::Key",
      "ARN": "arn:aws:kms:us-west-2:111122223333:key/00000000-1111-2222-3333-999999999999"
    }],
    "eventType": "AwsApiCall",
    "managementEvent": true,
    "recipientAccountId": "111122223333",
    "sharedEventID": "35d58aa1-26b2-427a-908f-025bf71241f6",
    "eventCategory": "Management"
  }

```

ReEncrypt

```

{
  "eventVersion": "1.08",
  "userIdentity": {
    "type": "AWSService",
    "invokedBy": "voiceid.amazonaws.com"
  },
  "eventTime": "2021-10-13T00:59:05Z",
  "eventSource": "kms.amazonaws.com",
  "eventName": "ReEncrypt",
  "awsRegion": "us-west-2",
  "sourceIPAddress": "voiceid.amazonaws.com",
  "userAgent": "voiceid.amazonaws.com",
  "requestParameters": {

```

```

    "destinationEncryptionContext": {
      "aws:voiceid:domain:arn": "arn:aws:voiceid:us-
west-2:111122223333:domain/sampleDomainId"
    },
    "destinationKeyId": "arn:aws:kms:us-
west-2:111122223333:key/44444444-3333-2222-1111-EXAMPLE11111",
    "sourceEncryptionAlgorithm": "SYMMETRIC_DEFAULT",
    "sourceAAD": "SampleSourceAAD+JXBmH+ZJNM73BfHE/dwQALXp7Sf44VwvoJ0rLj",
    "destinationAAD": "SampleDestinationAAD+JXBmH+ZJNM73BfHE/
dwQALXp7Sf44VwvoJ0rLj",
    "sourceEncryptionContext": {
      "aws:voiceid:domain:arn": "arn:aws:voiceid:us-
west-2:111122223333:domain/sampleDomainId"
    },
    "destinationEncryptionAlgorithm": "SYMMETRIC_DEFAULT",
    "sourceKeyId": "arn:aws:kms:us-
west-2:111122223333:key/55555555-3333-2222-1111-EXAMPLE22222"
  },
  "responseElements": null,
  "requestID": "ed0fe4ab-305b-4388-8adf-7e8e3a4e80fe",
  "eventID": "31d0d7c6-ce5b-4caf-901f-025bf71241f6",
  "readOnly": true,
  "resources": [{
    "accountId": "111122223333",
    "type": "AWS::KMS::Key",
    "ARN": "arn:aws:kms:us-
west-2:111122223333:key/00000000-1111-2222-3333-999999999999"
  },
  {
    "accountId": "111122223333",
    "type": "AWS::KMS::Key",
    "ARN": "arn:aws:kms:us-
west-2:111122223333:key/00000000-1111-2222-3333-777777777777"
  }
],
  "eventType": "AwsApiCall",
  "managementEvent": true,
  "recipientAccountId": "111122223333",
  "sharedEventID": "35d58aa1-26b2-427a-908f-025bf71241f6",
  "eventCategory": "Management"
}

```

Outbound campaigns

For outbound campaigns, Amazon Pinpoint passes customer phone numbers and relevant attributes to Amazon Connect. On Amazon Connect, these are always encrypted at rest using either a customer managed key or an AWS owned key. The outbound campaigns data is segregated by the Amazon Connect instance ID and are encrypted by instance specific keys.

You can provide your own customer managed key when onboarding to outbound campaigns.

The service use this customer managed key to encrypt sensitive data at rest. The customer managed key is created, owned, and managed by you. You have full control over the customer managed key

If you do not provide your own customer managed key, then outbound campaigns encrypts sensitive data at rest using a AWS owned key specific to your Amazon Connect instance.

AWS KMS charges apply for a customer managed key. For more information about pricing, see [AWS KMS pricing](#).

Forecasts, capacity plans, and schedules

When you create forecasts, capacity plans, and schedules, all data are encrypted at rest using AWS owned key encryption keys stored in AWS Key Management Service.

Encryption in transit

All data exchanged with Amazon Connect is protected in transit between the user's web browser and Amazon Connect using industry-standard TLS encryption. [Which version of TLS?](#)

External data is additionally encrypted while being processed by AWS KMS.

When Amazon Connect integrates with AWS services, such as AWS Lambda, Amazon Kinesis, or Amazon Polly, data is always encrypted in transit using TLS.

When event data is forwarded from external applications to Amazon Connect it is always encrypted in transit using TLS.

Key management

You can specify AWS KMS keys, including bring your own keys (BYOK), to use for envelope encryption with Amazon S3 input/output buckets. This also applies to data used stored in Amazon Connect Customer Profiles.

Amazon Q in Connect stores knowledge documents that are encrypted at rest in S3 using a BYOK or a service-owned key. The knowledge documents are encrypted at rest in Amazon OpenSearch Service using a service-owned key. Amazon Q in Connect stores agent queries and call transcripts using a BYOK or a service-owned key.

Amazon AppIntegrations doesn't support BYOK for encryption of configuration data. When syncing external application data, periodically you are required to BYOK. Amazon AppIntegrations requires a grant to use your customer managed key. When you create a data integration, Amazon AppIntegrations sends a `CreateGrant` request to AWS KMS on your behalf. You can revoke access to the grant, or remove the service's access to the customer managed key at any time. If you do, Amazon AppIntegrations won't be able to access any of the data encrypted by the customer managed key, which affects Amazon Connect services that are dependent on that data.

The knowledge documents used by Amazon Q in Connect are encrypted by an AWS KMS key.

For using Amazon Connect Voice ID, it is mandatory to provide a customer managed key KMS key (BYOK) while creating a Amazon Connect Voice ID domain, which is used to encrypt all the customer data at rest.

Outbound campaigns encrypts all sensitive data using an AWS owned key or a customer managed key. As the customer managed key is created, owned, and managed by the you, you have full control over the customer managed key (AWS KMS charges apply).

For information about AWS KMS keys see [What is AWS Key Management Service?](#) in the *AWS Key Management Service Developer Guide*.

Amazon Connect and interface VPC endpoints (AWS PrivateLink)

You can establish a private connection between your VPC and a subset of endpoints in Amazon Connect by creating an interface VPC endpoint. Following are the supported endpoints:

- Amazon AppIntegrations
- Customer Profiles
- Outbound campaigns
- Voice ID
- Amazon Q in Connect

The core Amazon Connect service does not support AWS PrivateLink or VPC endpoints.

Interface endpoints are powered by [AWS PrivateLink](#), a technology that enables you to privately access Amazon Connect APIs without an internet gateway, NAT device, VPN connection, or AWS Direct Connect connection. Instances in your VPC don't need public IP addresses to communicate with the Amazon Connect APIs that integrate with AWS PrivateLink.

For more information, see the [AWS PrivateLink Guide](#).

Creating an interface VPC endpoint for Amazon Connect

You can create an interface endpoint using either the Amazon VPC console or the AWS Command Line Interface (AWS CLI). For more information, see [Create an interface endpoint](#) in the *AWS PrivateLink Guide*.

Amazon Connect supports the following service names:

- com.amazonaws.*region*.app-integrations
- com.amazonaws.*region*.cases
- com.amazonaws.*region*.profile
- com.amazonaws.*region*.connect-campaigns
- com.amazonaws.*region*.voiceid
- com.amazonaws.*region*.wisdom

If you enable private DNS for an interface endpoint, you can make API requests to Amazon Connect using the default DNS name for the Region. For example, voiceid.us-east-1.amazonaws.com. For more information, see [DNS hostnames](#) in the *AWS PrivateLink Guide*.

Creating a VPC endpoint policy

You can attach an endpoint policy to your VPC endpoint that controls access. The policy specifies the following information:

- The principal that can perform actions.
- The actions that can be performed.
- The resources on which actions can be performed.

For more information, see [Control access to services using endpoint policies](#) in the *AWS PrivateLink Guide*.

Example: VPC endpoint policy

The following VPC endpoint policy grants access to the listed Amazon Connect Voice ID actions for all principals on all resources.

```
{
  "Statement": [
    {
      "Effect": "Allow",
      "Action": [
        "voiceid:CreateDomain",
        "voiceid:EvaluateSession",
        "voiceid:ListSpeakers"
      ],
      "Resource": "*",
      "Principal": "*"
    }
  ]
}
```

Following is another example. In this one, the VPC endpoint policy grants access to the listed outbound campaigns actions for all principals on all resources.

```
{
  "Statement": [
    {
      "Effect": "Allow",
      "Action": [
        "connect-campaigns:CreateCampaign",
        "connect-campaigns>DeleteCampaign",
        "connect-campaigns:ListCampaigns"
      ],
      "Resource": "*",
      "Principal": "*"
    }
  ]
}
```

Opt out of using your data for service improvement

When the following Amazon Connect services are enabled, they use your customer's content that you provide to train models and continuously improve your experience:

- Amazon Connect Contact Lens: Your customer's content is stored in [DataHub](#), a metadata management platform. This data is not used to train the machine learning model.
- Amazon Connect Customer Profiles: Your customer's content is used to train the machine learning model.
- Amazon Connect forecasting, capacity planning, and scheduling: Your customer's content is used to maintain and improve forecasting models that are powered by machine learning.
- Outbound campaigns with answering machine enabled: Your customer's content is used to maintain and improve the answering machine detection models that are powered by machine learning.
- Amazon Q in Connect: Voice and messaging interactions and your knowledge content are used to train machine learning models.

This data might also be used to improve the quality of these Amazon Connect services. Only Amazon employees will have access to the data. Your trust, privacy, and the security of your content are our highest priority, and ensure that our use complies with our commitments to you. For more information, see [Data Privacy FAQ](#).

You can choose to opt out of having your data used to develop and improve Amazon Connect by using an AWS Organizations opt-out policy. For information about how to opt out, see [AI services opt-out policies](#) in the *AWS Organizations User Guide*.

Note

For you to use the opt-out policy, your AWS accounts must be centrally managed by AWS Organizations. If you haven't already created an organization for your AWS accounts, see [Creating and managing an organization](#) in the *AWS Organizations User Guide*.

Opting out results in:

- No use of your data by AWS for development and improvement.

Identity and access management for Amazon Connect

AWS Identity and Access Management (IAM) is an AWS service that helps an administrator securely control access to AWS resources. IAM administrators control who can be *authenticated* (signed in)

and *authorized* (have permissions) to use Amazon Connect resources. IAM is an AWS service that you can use with no additional charge.

Topics

- [Audience](#)
- [Authenticating with identities](#)
- [Managing access using policies](#)
- [Required permissions for using custom IAM policies to manage access to the Amazon Connect admin website](#)
- [Restrict AWS resources that can be associated with Amazon Connect](#)
- [How Amazon Connect works with IAM](#)
- [Amazon Connect identity-based policy examples](#)
- [Amazon Connect resource-level policy examples](#)
- [AWS managed policies for Amazon Connect](#)
- [Troubleshooting Amazon Connect identity and access](#)
- [Use service-linked roles for Amazon Connect](#)
- [Use service-linked roles for outbound campaigns](#)
- [Using service-linked roles for Amazon AppIntegrations](#)
- [Using service-linked roles for Amazon Connect Customer Profiles](#)
- [Using service-linked roles for Amazon Connect Managed Synchronization](#)

Audience

How you use AWS Identity and Access Management (IAM) differs, depending on the work that you do in Amazon Connect.

Service user – If you use the Amazon Connect service to do your job, then your administrator provides you with the credentials and permissions that you need. As you use more Amazon Connect features to do your work, you might need additional permissions. Understanding how access is managed can help you request the right permissions from your administrator. If you cannot access a feature in Amazon Connect, see [Troubleshooting Amazon Connect identity and access](#).

Service administrator – If you're in charge of Amazon Connect resources at your company, you probably have full access to Amazon Connect. It's your job to determine which Amazon Connect

features and resources your service users should access. You must then submit requests to your IAM administrator to change the permissions of your service users. Review the information on this page to understand the basic concepts of IAM. To learn more about how your company can use IAM with Amazon Connect, see [How Amazon Connect works with IAM](#).

IAM administrator – If you're an IAM administrator, you might want to learn details about how you can write policies to manage access to Amazon Connect. To view example Amazon Connect identity-based policies that you can use in IAM, see [Amazon Connect identity-based policy examples](#).

Authenticating with identities

Authentication is how you sign in to AWS using your identity credentials. You must be *authenticated* (signed in to AWS) as the AWS account root user, as an IAM user, or by assuming an IAM role.

You can sign in to AWS as a federated identity by using credentials provided through an identity source. AWS IAM Identity Center (IAM Identity Center) users, your company's single sign-on authentication, and your Google or Facebook credentials are examples of federated identities. When you sign in as a federated identity, your administrator previously set up identity federation using IAM roles. When you access AWS by using federation, you are indirectly assuming a role.

Depending on the type of user you are, you can sign in to the AWS Management Console or the AWS access portal. For more information about signing in to AWS, see [How to sign in to your AWS account](#) in the *AWS Sign-In User Guide*.

If you access AWS programmatically, AWS provides a software development kit (SDK) and a command line interface (CLI) to cryptographically sign your requests by using your credentials. If you don't use AWS tools, you must sign requests yourself. For more information about using the recommended method to sign requests yourself, see [Signing AWS API requests](#) in the *IAM User Guide*.

Regardless of the authentication method that you use, you might be required to provide additional security information. For example, AWS recommends that you use multi-factor authentication (MFA) to increase the security of your account. To learn more, see [Multi-factor authentication](#) in the *AWS IAM Identity Center User Guide* and [Using multi-factor authentication \(MFA\) in AWS](#) in the *IAM User Guide*.

AWS account root user

When you create an AWS account, you begin with one sign-in identity that has complete access to all AWS services and resources in the account. This identity is called the AWS account *root user* and is accessed by signing in with the email address and password that you used to create the account. We strongly recommend that you don't use the root user for your everyday tasks. Safeguard your root user credentials and use them to perform the tasks that only the root user can perform. For the complete list of tasks that require you to sign in as the root user, see [Tasks that require root user credentials](#) in the *IAM User Guide*.

Users and groups

An [IAM user](#) is an identity within your AWS account that has specific permissions for a single person or application. Where possible, we recommend relying on temporary credentials instead of creating IAM users who have long-term credentials such as passwords and access keys. However, if you have specific use cases that require long-term credentials with IAM users, we recommend that you rotate access keys. For more information, see [Rotate access keys regularly for use cases that require long-term credentials](#) in the *IAM User Guide*.

An [IAM group](#) is an identity that specifies a collection of IAM users. You can't sign in as a group. You can use groups to specify permissions for multiple users at a time. Groups make permissions easier to manage for large sets of users. For example, you could have a group named *IAMAdmins* and give that group permissions to administer IAM resources.

Users are different from roles. A user is uniquely associated with one person or application, but a role is intended to be assumable by anyone who needs it. Users have permanent long-term credentials, but roles provide temporary credentials. To learn more, see [When to create an IAM user \(instead of a role\)](#) in the *IAM User Guide*.

IAM roles

An [IAM role](#) is an identity within your AWS account that has specific permissions. It is similar to an IAM user, but is not associated with a specific person. You can temporarily assume an IAM role in the AWS Management Console by [switching roles](#). You can assume a role by calling an AWS CLI or AWS API operation or by using a custom URL. For more information about methods for using roles, see [Using IAM roles](#) in the *IAM User Guide*.

IAM roles with temporary credentials are useful in the following situations:

- **Federated user access** – To assign permissions to a federated identity, you create a role and define permissions for the role. When a federated identity authenticates, the identity is associated with the role and is granted the permissions that are defined by the role. For information about roles for federation, see [Creating a role for a third-party Identity Provider](#) in the *IAM User Guide*. If you use IAM Identity Center, you configure a permission set. To control what your identities can access after they authenticate, IAM Identity Center correlates the permission set to a role in IAM. For information about permission sets, see [Permission sets](#) in the *AWS IAM Identity Center User Guide*.
- **Temporary IAM user permissions** – An IAM user or role can assume an IAM role to temporarily take on different permissions for a specific task.
- **Cross-account access** – You can use an IAM role to allow someone (a trusted principal) in a different account to access resources in your account. Roles are the primary way to grant cross-account access. However, with some AWS services, you can attach a policy directly to a resource (instead of using a role as a proxy). To learn the difference between roles and resource-based policies for cross-account access, see [Cross account resource access in IAM](#) in the *IAM User Guide*.
- **Cross-service access** – Some AWS services use features in other AWS services. For example, when you make a call in a service, it's common for that service to run applications in Amazon EC2 or store objects in Amazon S3. A service might do this using the calling principal's permissions, using a service role, or using a service-linked role.
 - **Forward access sessions (FAS)** – When you use an IAM user or role to perform actions in AWS, you are considered a principal. When you use some services, you might perform an action that then initiates another action in a different service. FAS uses the permissions of the principal calling an AWS service, combined with the requesting AWS service to make requests to downstream services. FAS requests are only made when a service receives a request that requires interactions with other AWS services or resources to complete. In this case, you must have permissions to perform both actions. For policy details when making FAS requests, see [Forward access sessions](#).
- **Service role** – A service role is an [IAM role](#) that a service assumes to perform actions on your behalf. An IAM administrator can create, modify, and delete a service role from within IAM. For more information, see [Creating a role to delegate permissions to an AWS service](#) in the *IAM User Guide*.
- **Service-linked role** – A service-linked role is a type of service role that is linked to an AWS service. The service can assume the role to perform an action on your behalf. Service-linked roles appear in your AWS account and are owned by the service. An IAM administrator can view, but not edit the permissions for service-linked roles.

- **Applications running on Amazon EC2** – You can use an IAM role to manage temporary credentials for applications that are running on an EC2 instance and making AWS CLI or AWS API requests. This is preferable to storing access keys within the EC2 instance. To assign an AWS role to an EC2 instance and make it available to all of its applications, you create an instance profile that is attached to the instance. An instance profile contains the role and enables programs that are running on the EC2 instance to get temporary credentials. For more information, see [Using an IAM role to grant permissions to applications running on Amazon EC2 instances](#) in the *IAM User Guide*.

To learn whether to use IAM roles or IAM users, see [When to create an IAM role \(instead of a user\)](#) in the *IAM User Guide*.

Managing access using policies

You control access in AWS by creating policies and attaching them to AWS identities or resources. A policy is an object in AWS that, when associated with an identity or resource, defines their permissions. AWS evaluates these policies when a principal (user, root user, or role session) makes a request. Permissions in the policies determine whether the request is allowed or denied. Most policies are stored in AWS as JSON documents. For more information about the structure and contents of JSON policy documents, see [Overview of JSON policies](#) in the *IAM User Guide*.

Administrators can use AWS JSON policies to specify who has access to what. That is, which **principal** can perform **actions** on what **resources**, and under what **conditions**.

By default, users and roles have no permissions. To grant users permission to perform actions on the resources that they need, an IAM administrator can create IAM policies. The administrator can then add the IAM policies to roles, and users can assume the roles.

IAM policies define permissions for an action regardless of the method that you use to perform the operation. For example, suppose that you have a policy that allows the `iam:GetRole` action. A user with that policy can get role information from the AWS Management Console, the AWS CLI, or the AWS API.

Identity-based policies

Identity-based policies are JSON permissions policy documents that you can attach to an identity, such as an IAM user, group of users, or role. These policies control what actions users and roles can perform, on which resources, and under what conditions. To learn how to create an identity-based policy, see [Creating IAM policies](#) in the *IAM User Guide*.

Identity-based policies can be further categorized as *inline policies* or *managed policies*. Inline policies are embedded directly into a single user, group, or role. Managed policies are standalone policies that you can attach to multiple users, groups, and roles in your AWS account. Managed policies include AWS managed policies and customer managed policies. To learn how to choose between a managed policy or an inline policy, see [Choosing between managed policies and inline policies](#) in the *IAM User Guide*.

Resource-based policies

Resource-based policies are JSON policy documents that you attach to a resource. Examples of resource-based policies are IAM *role trust policies* and Amazon S3 *bucket policies*. In services that support resource-based policies, service administrators can use them to control access to a specific resource. For the resource where the policy is attached, the policy defines what actions a specified principal can perform on that resource and under what conditions. You must [specify a principal](#) in a resource-based policy. Principals can include accounts, users, roles, federated users, or AWS services.

Resource-based policies are inline policies that are located in that service. You can't use AWS managed policies from IAM in a resource-based policy.

Other policy types

AWS supports additional, less-common policy types. These policy types can set the maximum permissions granted to you by the more common policy types.

- **Permissions boundaries** – A permissions boundary is an advanced feature in which you set the maximum permissions that an identity-based policy can grant to an IAM entity (IAM user or role). You can set a permissions boundary for an entity. The resulting permissions are the intersection of an entity's identity-based policies and its permissions boundaries. Resource-based policies that specify the user or role in the `Principal` field are not limited by the permissions boundary. An explicit deny in any of these policies overrides the allow. For more information about permissions boundaries, see [Permissions boundaries for IAM entities](#) in the *IAM User Guide*.
- **Service control policies (SCPs)** – SCPs are JSON policies that specify the maximum permissions for an organization or organizational unit (OU) in AWS Organizations. AWS Organizations is a service for grouping and centrally managing multiple AWS accounts that your business owns. If you enable all features in an organization, then you can apply service control policies (SCPs) to any or all of your accounts. The SCP limits permissions for entities in member accounts, including each AWS account root user. For more information about Organizations and SCPs, see [How SCPs work](#) in the *AWS Organizations User Guide*.

- **Session policies** – Session policies are advanced policies that you pass as a parameter when you programmatically create a temporary session for a role or federated user. The resulting session's permissions are the intersection of the user or role's identity-based policies and the session policies. Permissions can also come from a resource-based policy. An explicit deny in any of these policies overrides the allow. For more information, see [Session policies](#) in the *IAM User Guide*.

Multiple policy types

When multiple types of policies apply to a request, the resulting permissions are more complicated to understand. To learn how AWS determines whether to allow a request when multiple policy types are involved, see [Policy evaluation logic](#) in the *IAM User Guide*.

Required permissions for using custom IAM policies to manage access to the Amazon Connect admin website

If you're using custom [IAM](#) policies to manage access to the Amazon Connect admin website, your users need some or all of the permissions listed in this article, depending on the tasks they need to do.

Note

Using **connect:*** in a custom IAM policy grants your users all of the Amazon Connect permissions listed in this article.

Note

Certain pages on the Amazon Connect admin website, such as [Tasks](#) and [Customer Profiles](#), require that you add permissions to your inline policies.

Contents

- [AmazonConnect_FullAccess policy](#)
- [AmazonConnectReadOnlyAccess policy](#)
- [Amazon Connect admin website home page](#)
- [Detailed instance pages](#)

- [Overview page](#)
- [Telephony page](#)
- [Data storage page](#)
- [Data streaming page](#)
- [Flows page](#)
- [Application integration page](#)
- [Customer Profiles page](#)
- [Tasks page](#)
- [Cases page](#)
- [Amazon Q in Connect page](#)
- [Voice ID page](#)
- [Forecasting, capacity planning, and scheduling page](#)
- [Federations](#)

AmazonConnect_FullAccess policy

To allow full read/write access to Amazon Connect, you must attach two policies to your users, groups, or roles. Attach the **AmazonConnect_FullAccess** policy and a custom policy with the following contents:

```
{
  "Version": "2012-10-17",
  "Statement": [
    {
      "Sid": "AttachAnyPolicyToAmazonConnectRole",
      "Effect": "Allow",
      "Action": "iam:PutRolePolicy",
      "Resource": "arn:aws:iam::*:role/aws-service-role/connect.amazonaws.com/
AWSServiceRoleForAmazonConnect*"
    }
  ]
}
```

To allow a user to create an instance, ensure that they have the permissions granted by the **AmazonConnect_FullAccess** policy.

When you use **AmazonConnect_FullAccess** policy, note the following:

- Additional privileges are required to create an Amazon S3 bucket with a name of your choosing, or to use an existing bucket while creating or updating an instance from the Amazon Connect admin website. If you choose default storage locations for your call recordings, chat transcripts, call transcripts, and other data, the system prepends "amazon-connect-" to those objects.
- The aws/connect KMS key is available to use as a default encryption option. To use a custom encryption key, assign users additional KMS privileges.
- Assign users additional privileges to attach other AWS resources like Amazon Polly, Live Media Streaming, Data Streaming, and Lex bots to their Amazon Connect instances.

AmazonConnectReadOnlyAccess policy

To allow read-only access, you need to attach only the **AmazonConnectReadOnlyAccess** policy.

Amazon Connect admin website home page

The following image shows a sample Amazon Connect admin website home page, with an arrow pointing to the instance alias. Choose the instance alias to navigate to the detailed instance pages.

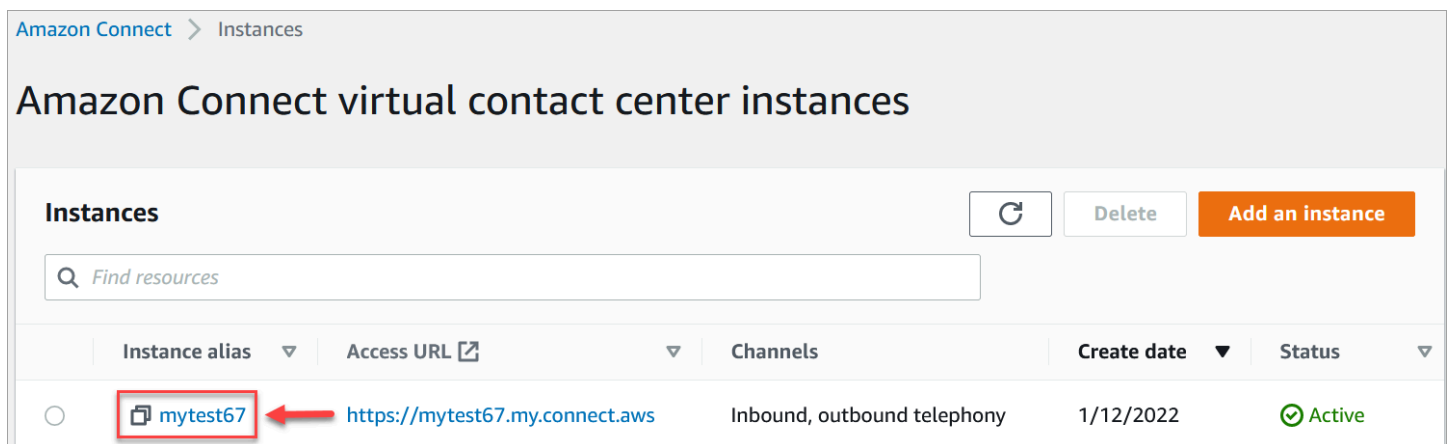

Use the permissions listed in the following table to manage access to this page.

Action/Use case	Permissions needed
List instance	connect:ListInstances ds:DescribeDirectories
Describe instance: View the details of the instance/ current settings	connect:DescribeInstance

Action/Use case	Permissions needed
	<ul style="list-style-type: none">connect:ListLambdaFunctionsconnect:ListLexBotsconnect:ListInstanceStorageConfigsconnect:ListApprovedOriginsconnect:ListSecurityKeysconnect:DescribeInstanceAttributesconnect:DescribeInstanceStorageConfigds:DescribeDirectories

Action/Use case	Permissions needed
Create instance	connect:AssociateCustomerProfilesDomain connect:CreateInstance connect:DescribeInstance connect:ListInstances connect:AssociateInstanceStorageConfig connect:UpdateInstanceAttribute ds:CheckAlias ds:CreateAlias ds:AuthorizeApplication ds:UnauthorizeApplication ds:CreateIdentityPoolDirectory ds:CreateDirectory ds:DescribeDirectories iam:CreateServiceLinkedRole iam:PutRolePolicy kms:CreateGrant kms:DescribeKey kms:ListAliases kms:RetireGrant logs:CreateLogGroup s3:CreateBucket

Action/Use case	Permissions needed
	<ul style="list-style-type: none"> s3:GetBucketLocation s3>ListAllMyBuckets servicequotas:GetServiceQuota profile:CreateDomain profile:GetDomain profile:GetProfileObjectType profile>ListAccountIntegrations profile>ListDomains profile>ListProfileObjectTypeTemplates profile:PutIntegration
Delete instance	<ul style="list-style-type: none"> connect:DescribeInstance connect>DeleteInstance connect>ListInstances ds:DescribeDirectories ds>DeleteDirectory ds:UnauthorizeApplication

Detailed instance pages

The following image shows the navigation menu you use to access each of the detailed instance pages.

To access the detailed instance pages, you need permissions to the Amazon Connect admin website home page (describe/list). Or, use the **AmazonConnectReadOnlyAccess** policy.

The following tables list the granular permissions for each detailed instance page.

Note

To perform **Edit** actions, users also need **List** and **Describe** permissions.

Overview page

Action/Use case	Permissions needed
Create service-linked role	connect:DescribeInstance connect:ListInstances connect:DescribeInstanceAttribute connect:UpdateInstanceAttribute connect:ListIntegrationAssociations profile:ListAccountIntegrations

Action/Use case	Permissions needed
	ds:DescribeDirectories iam:CreateServiceLinkedRole iam:PutRolePolicy

Telephony page

Action/Use case	Permissions needed
View telephony options	connect:DescribeInstance
Enable/Disable telephony options	connect:UpdateInstanceAttribute
View outbound campaigns	connect-campaigns:GetConnectInstanceConfig connect-campaigns:GetInstanceOnboardingJobStatus connect:DescribeInstance connect:DescribeInstanceAttribute kms:DescribeKey
Enable/disable outbound campaigns	connect-campaigns:GetConnectInstanceConfig connect-campaigns:GetInstanceOnboardingJobStatus connect-campaigns:StartInstanceOnboardingJob connect-campaigns>DeleteInstanceOnboardingJob connect-campaigns>DeleteConnectInstanceConfig

Action/Use case	Permissions needed
	<p>connect:DescribeInstance</p> <p>connect:DescribeInstanceAttribute</p> <p>connect:UpdateInstanceAttribute</p> <p>iam:CreateServiceLinkedRole</p> <p>iam>DeleteServiceLinkedRole</p> <p>iam:AttachRolePolicy</p> <p>iam:PutRolePolicy</p> <p>iam>DeleteRolePolicy</p> <p>events:PutRule</p> <p>events:PutTargets</p> <p>events>DeleteRule</p> <p>events:RemoveTargets</p> <p>events:DescribeRule</p> <p>events:ListTargetsByRule</p> <p>ds:DescribeDirectories</p> <p>kms:DescribeKey</p> <p>kms:ListKeys</p> <p>kms>CreateGrant</p> <p>kms:RetireGrant</p>

Data storage page

Call recording section

Action/Use case	Permissions needed
View call recording	connect:DescribeInstance connect:ListInstanceStorageConfigs connect:DescribeInstanceStorageConfig
Edit call recording	connect:AssociateInstanceStorageConfig connect:UpdateInstanceStorageConfig connect:DisassociateInstanceStorageConfig s3:ListAllMyBuckets s3:GetBucketLocation s3:GetBucketAcl s3:CreateBucket kms:CreateGrant kms:DescribeKey kms:ListAliases kms:RetireGrant iam:PutRolePolicy

Screen recording section

Action/Use case	Permissions needed
View screen recording	connect:DescribeInstance

Action/Use case	Permissions needed
	connect:ListInstanceStorageConfigs connect:DescribeInstanceStorageConfig
Edit screen recording	connect:AssociateInstanceStorageConfig connect:UpdateInstanceStorageConfig connect:DisassociateInstanceStorageConfig s3:ListAllMyBuckets s3:GetBucketLocation s3:GetBucketAcl s3:CreateBucket iam:PutRolePolicy kms:CreateGrant kms:DescribeKey kms:ListAliases kms:RetireGrant

Chat transcripts section

Action/Use case	Permissions needed
View chat transcripts	connect:DescribeInstance connect:DescribeInstanceStorageConfig connect:ListInstanceStorageConfigs
Edit chat transcripts	connect:AssociateInstanceStorageConfig

Action/Use case	Permissions needed
	connect:UpdateInstanceStorageConfig connect:DisassociateInstanceStorageConfig s3:ListAllMyBuckets s3:GetBucketLocation s3:GetBucketAcl s3>CreateBucket kms:CreateGrant kms:DescribeKey kms:ListAliases kms:RetireGrant iam:PutRolePolicy

Attachments section

Action/Use case	Permissions needed
View chat attachments	connect:DescribeInstance connect:DescribeInstanceStorageConfig connect:ListInstanceStorageConfigs
Edit chat attachments	connect:AssociateInstanceStorageConfig connect:UpdateInstanceStorageConfig connect:DisassociateInstanceStorageConfig s3:ListAllMyBuckets

Action/Use case	Permissions needed
	s3:GetBucketLocation s3:CreateBucket s3:GetBucketAcl kms:CreateGrant kms:DescribeKey kms:ListAliases kms:RetireGrant iam:PutRolePolicy

Live media streaming section

Action/Use case	Permissions needed
View live media streaming	connect:DescribeInstance connect:ListInstanceStorageConfigs connect:DescribeInstanceStorageConfig
Edit live media streaming	connect:AssociateInstanceStorageConfig connect:UpdateInstanceStorageConfig connect:DisassociateInstanceStorageConfig kms:CreateGrant kms:DescribeKey kms:RetireGrant iam:PutRolePolicy

Exported reports section

Action/Use case	Permissions needed
View exported reports	connect:DescribeInstance connect:ListInstanceStorageConfigs connect:DescribeInstanceStorageConfig
Edit exported reports	connect:AssociateInstanceStorageConfig connect:UpdateInstanceStorageConfig connect:DisassociateInstanceStorageConfig s3:ListAllMyBuckets s3:GetBucketLocation s3:CreateBucket kms:DescribeKey kms:ListAliases kms:RetireGrant kms:CreateGrant iam:PutRolePolicy

Data streaming page

Contact records section

Action/Use case	Permissions needed
View data streaming - Contact records	connect:DescribeInstance connect:ListInstanceStorageConfigs

Action/Use case	Permissions needed
	connect:DescribeInstanceStorageConfig
Edit contact record	connect:AssociateInstanceStorageConfig connect:UpdateInstanceStorageConfig connect:DisassociateInstanceStorageConfig firehose:ListDeliveryStreams firehose:DescribeDeliveryStream kinesis:ListStreams kinesis:DescribeStream iam:PutRolePolicy

Agent events section

Action/Use case	Permissions needed
View data streaming - Agent events	connect:DescribeInstance connect:ListInstanceStorageConfigs connect:DescribeInstanceStorageConfig
Edit agent events	connect:AssociateInstanceStorageConfig connect:UpdateInstanceStorageConfig connect:DisassociateInstanceStorageConfig kinesis:ListStreams kinesis:DescribeStream iam:PutRolePolicy

Flows page

Flows security keys section

Action/Use case	Permissions needed
View flow security keys	connect:DescribeInstance connect:ListSecurityKeys
Add/remove flow security keys	connect:AssociateSecurityKey connect:DisassociateSecurityKey

Lex bots section

Action/Use case	Permissions needed
View Lex bots	connect:ListLexBots connect:ListBots
Add/remove Lex bots	lex:GetBots lex:GetBot lex:CreateResourcePolicy lex>DeleteResourcePolicy lex:UpdateResourcePolicy lex:DescribeBotAlias lex:ListBotAliases lex:ListBots connect:AssociateBot connect:DisassociateBot

Action/Use case	Permissions needed
	connect:ListBots connect:AssociateLexBot connect:DisassociateLexBot connect:ListLexBots iam:PutRolePolicy

Lambda functions section

Action/Use case	Permissions needed
View Lambda functions	connect:ListLambdaFunctions
Add/remove Lambda functions	connect:ListLambdaFunctions connect:AssociateLambdaFunction connect:DisassociateLambdaFunction iam:PutRolePolicy lambda:ListFunctions lambda:AddPermission lambda:RemovePermission

Flow logs section

Action/Use case	Permissions needed
View flow log config	connect:DescribeInstance connect:DescribeInstanceAttribute

Action/Use case	Permissions needed
Enable/disable flow log	logs:CreateLogGroup

Amazon Polly section

Action/Use case	Permissions needed
View Amazon Polly option	connect:DescribeInstance connect:DescribeInstanceAttribute
Update Amazon Polly option	connect:UpdateInstanceAttribute

Application integration page

Action/Use case	Permissions needed
View approved origins	connect:DescribeInstance connect:ListApprovedOrigins
Edit approved origins	connect:AssociateApprovedOrigin connect:ListApprovedOrigins connect:DisassociateApprovedOrigin

Customer Profiles page

Action/Use case	Permissions needed
View customer profiles	app-integrations:ListEventIntegrations appflow:DescribeConnectorEntity appflow:DescribeConnectorProfiles

Action/Use case	Permissions needed
	appflow:DescribeFlow
	appflow:ListFlows
	appflow:ListConnectorEntities
	appflow:ListConnectorProfiles
	cloudwatch:GetMetricData
	connect:DescribeInstance
	connect:ListInstances
	ds:DescribeDirectories
	iam:ListRoles
	kinesis:DescribeStreamSummary
	kms:DescribeKey
	kms:ListKeys
	profile:GetCalculatedAttributeDefinition
	profile:GetDomain
	profile:GetEventStream
	profile:GetIdentityResolutionJob
	profile:GetIntegration
	profile:GetProfileObjectType
	profile:GetProfileObjectTypeTemplate
	profile:GetWorkflow
	profile:ListAccountIntegrations

Action/Use case	Permissions needed
	profile:ListCalculatedAttributeDefinitions profile:ListDomains profile:ListEventStreams profile:ListIdentityResolutionJobs profile:ListIntegrations profile:ListProfileObjectTypes profile:ListProfileObjectTypeTemplates sqs:ListQueues

Action/Use case	Permissions needed
Edit customer profiles	app-integrations:CreateEventIntegration app-integrations:ListEventIntegrations appflow:CreateFlow appflow:CreateConnectorProfile appflow:DescribeFlow appflow>DeleteFlow appflow:DescribeConnectorEntity appflow:DescribeConnectorProfiles appflow:ListFlows appflow:ListConnectorEntities appflow:ListConnectorProfiles appflow:StartFlow cloudwatch:GetMetricData connect:DescribeInstance connect:ListInstances ds:DescribeDirectories events:CreateEventBus events:DescribeEventBus events:DescribeEventSource events:ListEventSources iam:CreateRole

Action/Use case	Permissions needed
	iam:CreatePolicy iam:AttachRolePolicy iam:ListRoles iam:PutRolePolicy kinesis:DescribeStreamSummary kinesis:ListStreams kms:CreateGrant kms:DescribeKey kms:ListAliases kms:ListKeys kms:ListGrants profile:CreateDomain profile:CreateEventStream profile:CreateIntegrationWorkflow profile>DeleteEventStream profile>DeleteIntegration profile>DeleteDomain profile>DeleteProfileObjectType profile:DetectProfileObjectType profile:GetCalculatedAttributeDefinition profile:GetDomain

Action/Use case	Permissions needed
	<ul style="list-style-type: none">profile:GetEventStreamprofile:GetIdentityResolutionJobprofile:GetIntegrationprofile:GetProfileObjectTypeprofile:GetProfileObjectTypeTemplateprofile:GetWorkflowprofile:ListAccountIntegrationsprofile:ListCalculatedAttributeDefinitionsprofile:ListDomainsprofile:ListEventStreamsprofile:ListIdentityResolutionJobsprofile:ListIntegrationsprofile:ListProfileObjectTypesprofile:ListProfileObjectTypeTemplatesprofile:PutIntegrationprofile:PutProfileObjectTypeprofile:TagResourceprofile:UntagResourceprofile:UpdateDomains3:GetBucketLocations3:GetBucketPolicy

Action/Use case	Permissions needed
	s3:GetObject
	s3:HeadBucket
	s3:ListAllMyBuckets
	s3:ListBucket
	s3:ListObjectsV2
	s3:PutBucketPolicy
	s3>SelectObjectContent
	sqs:ListQueues

Tasks page

Action/Use case	Permissions needed
View Tasks integrations	app-integrations:GetEventIntegration connect:ListIntegrationAssociations
Edit Tasks integrations	app-integrations:CreateEventIntegration app-integrations:GetEventIntegration app-integrations:ListEventIntegrations app-integrations>DeleteEventIntegrationAssociation app-integrations>CreateEventIntegrationAssociation appflow:CreateFlow appflow:CreateConnectorProfile

Action/Use case	Permissions needed
	<p>appflow:DescribeFlow</p> <p>appflow>DeleteFlow</p> <p>appflow>DeleteConnectorProfile</p> <p>appflow:DescribeConnectorEntity</p> <p>appflow:ListFlows</p> <p>appflow:ListConnectorEntities</p> <p>appflow:StartFlow</p> <p>connect:ListIntegrationAssociations</p> <p>connect>DeleteIntegrationAssociation</p> <p>connect:ListUseCases</p> <p>connect>DeleteUseCase</p> <p>events:ActivateEventSource</p> <p>events>CreateEventBus</p> <p>events:DescribeEventBus</p> <p>events:DescribeEventSource</p> <p>events:ListEventSources</p> <p>events:ListTargetsByRule</p> <p>events:PutRule</p> <p>events:PutTargets</p> <p>events>DeleteRule</p> <p>events:RemoveTargets</p>

Action/Use case	Permissions needed
	kms:CreateGrant kms:DescribeKey kms:ListAliases kms:ListKeys kms:ListGrants

Cases page

Action/Use case	Permissions needed
View Cases domain details	connect:ListInstances ds:DescribeDirectories connect:ListIntegrationAssociations cases:GetDomain
Onboard to Cases	connect:ListInstances connect:ListIntegrationAssociations cases:GetDomain cases>CreateDomain connect>CreateIntegrationAssociation connect:DescribeInstance iam:PutRolePolicy

Amazon Q in Connect page

Action/Use case	Permissions needed
View domains and integrations	wisdom:ListAssistantAssociations appflow:DescribeConnectorProfiles app-integrations:GetDataIntegration connect:DescribeInstance connect:DescribeInstanceAttribute connect:ListIntegrationAssociations kms:DescribeKey kms:ListGrants wisdom:GetAssistant wisdom:GetKnowledgeBase wisdom:ListAssistantAssociations
Add or remove domains	connect:CreateIntegrationAssociation connect>DeleteIntegrationAssociation connect:ListIntegrationAssociations iam>DeleteRolePolicy iam:PutRolePolicy kms>CreateGrant kms:DescribeKey kms:ListAliases wisdom:CreateAssistant

Action/Use case	Permissions needed
	wisdom:DeleteAssistant wisdom:GetAssistant wisdom:ListAssistantAssociations wisdom:ListAssistants wisdom:TagResource

Action/Use case	Permissions needed
Add or remove integrations	wisdom:ListAssistantAssociations app-integrations:CreateDataIntegration app-integrations:CreateDataIntegrationAssociation app-integrations>DeleteDataIntegrationAssociation app-integrations:GetDataIntegration app-integrations:ListDataIntegrations appflow:CreateConnectorProfile appflow:CreateFlow appflow>DeleteFlow appflow:DescribeConnector appflow:DescribeConnectorEntity appflow:DescribeConnectorProfiles appflow:DescribeConnectors appflow:DescribeFlow appflow:ListConnectorEntities appflow:StartFlow appflow:StopFlow appflow:TagResource appflow:UseConnectorProfile connect:CreateIntegrationAssociation

Action/Use case	Permissions needed
	<p>connect:DeleteIntegrationAssociation</p> <p>connect:ListIntegrationAssociations</p> <p>iam:DeleteRolePolicy</p> <p>iam:PutRolePolicy</p> <p>kms:CreateGrant</p> <p>kms:Decrypt</p> <p>kms:DescribeKey</p> <p>kms:GenerateDataKey</p> <p>kms:ListAliases</p> <p>kms:ListGrants</p> <p>secretsmanager:CreateSecret</p> <p>secretsmanager:PutResourcePolicy</p> <p>wisdom:CreateAssistantAssociation</p> <p>wisdom:CreateKnowledgeBase</p> <p>wisdom>DeleteAssistantAssociation</p> <p>wisdom>DeleteKnowledgeBase</p> <p>wisdom:GetAssistant</p> <p>wisdom:GetKnowledgeBase</p> <p>wisdom:ListAssistantAssociations</p> <p>wisdom:ListKnowledgeBases</p> <p>wisdom:TagResource</p>

Voice ID page

Action/Use case	Permissions needed
View Voice ID integrations	voiceid:DescribeDomain voiceid:ListDomains voiceid:RegisterComplianceConsent voiceid:DescribeComplianceConsent connect:ListIntegrationAssociations
Edit Voice ID integrations	voiceid:DescribeDomain voiceid:ListDomains voiceid:RegisterComplianceConsent voiceid:DescribeComplianceConsent voiceid:UpdateDomain voiceid:CreateDomain connect:ListIntegrationAssociations connect:CreateIntegrationAssociation connect>DeleteIntegrationAssociation events:PutRule events>DeleteRule events:PutTargets events:RemoveTargets iam:PutRolePolicy

Forecasting, capacity planning, and scheduling page

Action/Use case	Permissions needed
View forecasting, capacity planning, and scheduling	connect:DescribeForecastingPlanningSchedulingIntegration
Enable forecasting, capacity planning, and scheduling	connect:UpdateInstanceAttribute connect:StartForecastingPlanningSchedulingIntegration
Disable forecasting, capacity planning, and scheduling	connect:UpdateInstanceAttribute connect:StopForecastingPlanningSchedulingIntegration

Federations

SAML federation

Action/Use case	Permissions needed
SAML federation	connect:GetFederationToken

Admin/Emergency federation

Action/Use case	Permissions needed
Admin/Emergency federation	connect:GetFederationTokens

Restrict AWS resources that can be associated with Amazon Connect

Each Amazon Connect instance is associated with an IAM [service-linked role](#) when the instance is created. Amazon Connect can integrate with other AWS services for use cases such as call recording storage (Amazon S3 bucket), natural language bots (Amazon Lex bots), and data streaming

(Amazon Kinesis Data Streams). Amazon Connect assumes the service-linked role to interact with these other services. The policy is first added to the service-linked role as part of corresponding APIs on the Amazon Connect service (that are in turn called by the AWS admin website). For example, if you want to use a certain Amazon S3 bucket with your Amazon Connect instance, the bucket must be passed to the [AssociateInstanceStorageConfig](#) API.

For the set of IAM actions defined by Amazon Connect, see [Actions defined by Amazon Connect](#).

Following are some examples of how to restrict access to other resources that may be associated with an Amazon Connect instance. They should be applied to the User or Role that is interacting with Amazon Connect APIs or the Amazon Connect admin website.

Note

A policy with an explicit Deny would override the Allow policy in these examples.

For more information about what resources, condition keys, and dependent APIs you can use to restrict access, see [Actions, resources, and condition keys for Amazon Connect](#).

Example 1: Restrict which Amazon S3 buckets can be associated with an Amazon Connect instance

```
{
  "Version": "2012-10-17",
  "Statement": [
    {
      "Sid": "VisualEditor0",
      "Effect": "Allow",
      "Action": [
        "connect:UpdateInstanceStorageConfig",
        "connect:AssociateInstanceStorageConfig"
      ],
      "Resource": "arn:aws:connect:region:account-id:instance/instance-id",
      "Condition": {
        "StringEquals": {
          "connect:StorageResourceType": "CALL_RECORDINGS"
        }
      }
    }
  ],
}
```

```
{
  "Sid": "VisualEditor1",
  "Effect": "Allow",
  "Action": [
    "iam:PutRolePolicy",
    "s3:GetBucketAcl",
    "s3:GetBucketLocation"
  ],
  "Resource": [
    "arn:aws:iam::account-id:role/aws-service-role/connect.amazonaws.com/*",
    "arn:aws:s3::s3-bucket-name"
  ]
},
{
  "Sid": "VisualEditor2",
  "Effect": "Allow",
  "Action": "s3:ListAllMyBuckets",
  "Resource": "*"
}
]
```

This example allows an IAM principal to associate an Amazon S3 bucket for call recordings for the given Amazon Connect instance ARN, and a specific Amazon S3 bucket named `my-connect-recording-bucket`. The `AttachRolePolicy` and `PutRolePolicy` actions are scoped to the Amazon Connect service-linked role (a wildcard is used in this example, but you can provide the role ARN for the instance if needed).

Note

To use an AWS KMS key to encrypt recordings in this bucket, an additional policy is needed.

Example 2: Restrict which AWS Lambda functions can be associated with an Amazon Connect instance

AWS Lambda functions are associated with an Amazon Connect instance, but the Amazon Connect service-linked role is not used to invoke them, and so is not modified. Instead, a policy is added to the function through the `lambda:AddPermission` API that allows the given Amazon Connect instance to invoke the function.

To restrict which functions can be associated with an Amazon Connect instance, you specify the Lambda function ARN that a user can use to invoke `lambda:AddPermission`:

```
{
  "Version": "2012-10-17",
  "Statement": [
    {
      "Sid": "VisualEditor0",
      "Effect": "Allow",
      "Action": [
        "connect:AssociateLambdaFunction",
        "lambda:AddPermission"
      ],
      "Resource": [
        "arn:aws:connect:region:account-id:instance/instance-id",
        "arn:aws:lambda:*:*:function:my-function"
      ]
    }
  ]
}
```

Example 3: Restrict which Amazon Kinesis Data Streams can be associated with an Amazon Connect instance

This example follows a similar model to the Amazon S3 example. It restricts which specific Kinesis Data Streams may be associated with a given Amazon Connect instance for delivering contact records.

```
{
  "Version": "2012-10-17",
  "Statement": [
    {
      "Sid": "VisualEditor0",
      "Effect": "Allow",
      "Action": [
        "connect:UpdateInstanceStorageConfig",
        "connect:AssociateInstanceStorageConfig"
      ],
      "Resource": "arn:aws:connect:region:account-id:instance/instance-id",
      "Condition": {
        "StringEquals": {
          "connect:StorageResourceType": "CONTACT_TRACE_RECORDS"
        }
      }
    }
  ]
}
```

```

    }
  },
  {
    "Sid": "VisualEditor1",
    "Effect": "Allow",
    "Action": [
      "kinesis:DescribeStream",
      "iam:PutRolePolicy"
    ],
    "Resource": [
      "arn:aws:iam::account-id:role/aws-service-role/connect.amazonaws.com/*",
      "arn:aws:kinesis:::account-id:stream/stream-name"
    ]
  },
  {
    "Sid": "VisualEditor2",
    "Effect": "Allow",
    "Action": "kinesis:ListStreams",
    "Resource": "*"
  }
]
}

```

How Amazon Connect works with IAM

Before you use IAM to manage access to Amazon Connect, you should understand what IAM features are available to use with Amazon Connect. To get a high-level view of how Amazon Connect and other AWS services work with IAM, see [AWS Services That Work with IAM](#) in the *IAM User Guide*.

Topics

- [Amazon Connect identity-based policies](#)
- [Authorization based on Amazon Connect tags](#)
- [Amazon Connect IAM roles](#)

Amazon Connect identity-based policies

With IAM identity-based policies, you can specify allowed or denied actions and resources as well as the conditions under which actions are allowed or denied. Amazon Connect supports specific actions, resources, and condition keys. To learn about all of the elements that you use in a JSON policy, see [IAM JSON Policy Elements Reference](#) in the *IAM User Guide*.

Actions

Administrators can use AWS JSON policies to specify who has access to what. That is, which **principal** can perform **actions** on what **resources**, and under what **conditions**.

The Action element of a JSON policy describes the actions that you can use to allow or deny access in a policy. Policy actions usually have the same name as the associated AWS API operation. There are some exceptions, such as *permission-only actions* that don't have a matching API operation. There are also some operations that require multiple actions in a policy. These additional actions are called *dependent actions*.

Include actions in a policy to grant permissions to perform the associated operation.

Policy actions in Amazon Connect use the following prefix before the action: `connect:`. Policy statements must include either an Action or NotAction element. Amazon Connect defines its own set of actions that describe tasks that you can perform with this service.

To specify multiple actions in a single statement, separate them with commas as follows:

```
"Action": [  
    "connect:action1",  
    "connect:action2"
```

You can specify multiple actions using wildcards (*). For example, to specify all actions that begin with the word Describe, include the following action:

```
"Action": "connect:Describe*"
```

To see a list of Amazon Connect actions, [Actions, Resources, and Condition Keys for Amazon Connect](#).

Resources

Amazon Connect supports resource-level permissions (specifying a resource ARN in an IAM policy). Following is a list of Amazon Connect resources:

- Instance
- Contact
- User
- Routing profile
- Security profile
- Hierarchy group
- Queue
- File
- Flow
- Hours of operation
- Phone number
- Task templates
- Customer profile domain
- Customer profile object type
- Outbound campaigns

Administrators can use AWS JSON policies to specify who has access to what. That is, which **principal** can perform **actions** on what **resources**, and under what **conditions**.

The `Resource` JSON policy element specifies the object or objects to which the action applies. Statements must include either a `Resource` or a `NotResource` element. As a best practice, specify a resource using its [Amazon Resource Name \(ARN\)](#). You can do this for actions that support a specific resource type, known as *resource-level permissions*.

For actions that don't support resource-level permissions, such as listing operations, use a wildcard (*) to indicate that the statement applies to all resources.

```
"Resource": "*"
```

The Amazon Connect instance resource has the following ARN:

```
arn:${Partition}:connect:${Region}:${Account}:instance/${InstanceId}
```

For more information about the format of ARNs, see [Amazon Resource Names \(ARNs\) and AWS Service Namespaces](#).

For example, to specify the `i-1234567890abcdef0` instance in your statement, use the following ARN:

```
"Resource": "arn:aws:connect:us-east-1:123456789012:instance/i-1234567890abcdef0"
```

To specify all instances that belong to a specific account, use the wildcard (*):

```
"Resource": "arn:aws:connect:us-east-1:123456789012:instance/*"
```

Some Amazon Connect actions, such as those for creating resources, cannot be performed on a specific resource. In those cases, you must use the wildcard (*).

```
"Resource": "*"
```

Many Amazon Connect; API actions involve multiple resources. For example,

To specify multiple resources in a single statement, separate the ARNs with commas.

```
"Resource": [  
  "resource1",  
  "resource2"
```

To see a list of Amazon Connect resource types and their ARNs, see [Actions, Resources, and Condition Keys for Amazon Connect](#). The same article explains with which actions you can specify the ARN of each resource.

Condition keys

Administrators can use AWS JSON policies to specify who has access to what. That is, which **principal** can perform **actions** on what **resources**, and under what **conditions**.

The `Condition` element (or *Condition block*) lets you specify conditions in which a statement is in effect. The `Condition` element is optional. You can create conditional expressions that use

[condition operators](#), such as equals or less than, to match the condition in the policy with values in the request.

If you specify multiple Condition elements in a statement, or multiple keys in a single Condition element, AWS evaluates them using a logical AND operation. If you specify multiple values for a single condition key, AWS evaluates the condition using a logical OR operation. All of the conditions must be met before the statement's permissions are granted.

You can also use placeholder variables when you specify conditions. For example, you can grant an IAM user permission to access a resource only if it is tagged with their IAM user name. For more information, see [IAM policy elements: variables and tags](#) in the *IAM User Guide*.

AWS supports global condition keys and service-specific condition keys. To see all AWS global condition keys, see [AWS global condition context keys](#) in the *IAM User Guide*.

Amazon Connect defines its own set of condition keys and also supports using some global condition keys. To see all AWS global condition keys, see [AWS Global Condition Context Keys](#) in the *IAM User Guide*.

All Amazon EC2 actions support the `aws:RequestedRegion` and `ec2:Region` condition keys. For more information, see [Example: Restricting Access to a Specific Region](#).

To see a list of Amazon Connect condition keys, see [Actions, Resources, and Condition Keys for Amazon Connect](#).

Examples

To view examples of Amazon Connect identity-based policies, see [Amazon Connect identity-based policy examples](#).

Authorization based on Amazon Connect tags

You can attach tags to Amazon Connect resources or pass tags in a request to Amazon Connect. To control access based on tags, you provide tag information in the [condition element](#) of a policy using the `connect:ResourceTag/key-name`, `aws:RequestTag/key-name`, or `aws:TagKeys` condition keys.

To view an example identity-based policy for limiting access to a resource based on the tags on that resource, see [Describe and update Amazon Connect users based on tags](#).

Amazon Connect IAM roles

An [IAM role](#) is an entity within your AWS account that has specific permissions.

Using temporary credentials with Amazon Connect

You can use temporary credentials to sign in with federation, assume an IAM role, or to assume a cross-account role. You obtain temporary security credentials by calling AWS STS API operations such as [AssumeRole](#) or [GetFederationToken](#).

Amazon Connect supports using temporary credentials.

Service-linked roles

[Service-linked roles](#) allow AWS services to access resources in other services to complete an action on your behalf. Service-linked roles appear in your IAM account and are owned by the service. An IAM administrator can view but not edit the permissions for service-linked roles.

Amazon Connect supports service-linked roles. For details about creating or managing Amazon Connect service-linked roles, see [Use service-linked roles for Amazon Connect](#).

Choosing an IAM role in Amazon Connect

When you create a resource in Amazon Connect, you must choose a role to allow Amazon Connect to access Amazon EC2 on your behalf. If you have previously created a service role or service-linked role, then Amazon Connect provides you with a list of roles to choose from. It's important to choose a role that allows access to start and stop Amazon EC2 instances.

Amazon Connect identity-based policy examples

By default, IAM entities don't have permission to create or modify Amazon Connect resources. They also can't perform tasks using the AWS Management Console, AWS CLI, or AWS API. An IAM administrator must create IAM policies that grant IAM entities permission to perform specific API operations on the specified resources they need. The IAM administrator must then attach those policies to the IAM entities that require those permissions.

To learn how to create an IAM identity-based policy using these example JSON policy documents, see [Creating Policies on the JSON Tab](#) in the *IAM User Guide*.

Topics

- [Policy best practices](#)
- [Allow IAM users to view their own permissions](#)
- [Grant "View User" permissions](#)
- [Allow users to integrate with external applications](#)
- [Describe and update Amazon Connect users based on tags](#)
- [Create Amazon Connect users based on tags](#)
- [Create and view Amazon AppIntegrations resources](#)
- [Create and view Amazon Q in Connect Assistants](#)
- [Manage outbound campaigns resources](#)

Policy best practices

Identity-based policies determine whether someone can create, access, or delete Amazon Connect resources in your account. These actions can incur costs for your AWS account. When you create or edit identity-based policies, follow these guidelines and recommendations:

- **Get started with AWS managed policies and move toward least-privilege permissions** – To get started granting permissions to your users and workloads, use the *AWS managed policies* that grant permissions for many common use cases. They are available in your AWS account. We recommend that you reduce permissions further by defining AWS customer managed policies that are specific to your use cases. For more information, see [AWS managed policies](#) or [AWS managed policies for job functions](#) in the *IAM User Guide*.
- **Apply least-privilege permissions** – When you set permissions with IAM policies, grant only the permissions required to perform a task. You do this by defining the actions that can be taken on specific resources under specific conditions, also known as *least-privilege permissions*. For more information about using IAM to apply permissions, see [Policies and permissions in IAM](#) in the *IAM User Guide*.
- **Use conditions in IAM policies to further restrict access** – You can add a condition to your policies to limit access to actions and resources. For example, you can write a policy condition to specify that all requests must be sent using SSL. You can also use conditions to grant access to service actions if they are used through a specific AWS service, such as AWS CloudFormation. For more information, see [IAM JSON policy elements: Condition](#) in the *IAM User Guide*.
- **Use IAM Access Analyzer to validate your IAM policies to ensure secure and functional permissions** – IAM Access Analyzer validates new and existing policies so that the policies

adhere to the IAM policy language (JSON) and IAM best practices. IAM Access Analyzer provides more than 100 policy checks and actionable recommendations to help you author secure and functional policies. For more information, see [IAM Access Analyzer policy validation](#) in the *IAM User Guide*.

- **Require multi-factor authentication (MFA)** – If you have a scenario that requires IAM users or a root user in your AWS account, turn on MFA for additional security. To require MFA when API operations are called, add MFA conditions to your policies. For more information, see [Configuring MFA-protected API access](#) in the *IAM User Guide*.

For more information about best practices in IAM, see [Security best practices in IAM](#) in the *IAM User Guide*.

Allow IAM users to view their own permissions

This example shows how you might create a policy that allows IAM users to view the inline and managed policies that are attached to their user identity. This policy includes permissions to complete this action on the console or programmatically using the AWS CLI or AWS API.

```
{
  "Version": "2012-10-17",
  "Statement": [
    {
      "Sid": "ViewOwnUserInfo",
      "Effect": "Allow",
      "Action": [
        "iam:GetUserPolicy",
        "iam:ListGroupsWithUser",
        "iam:ListAttachedUserPolicies",
        "iam:ListUserPolicies",
        "iam:GetUser"
      ],
      "Resource": ["arn:aws:iam::*:user/${aws:username}"]
    },
    {
      "Sid": "NavigateInConsole",
      "Effect": "Allow",
      "Action": [
        "iam:GetGroupPolicy",
        "iam:GetPolicyVersion",
        "iam:GetPolicy",
        "iam:ListAttachedGroupPolicies",

```

```
        "iam:ListGroupPolicies",
        "iam:ListPolicyVersions",
        "iam:ListPolicies",
        "iam:ListUsers"
    ],
    "Resource": "*"
}
]
```

Grant "View User" permissions

When you create a user or [group](#) in your AWS account, you can associate an IAM policy with that group or user, which specifies the permissions that you want to grant.

For example, imagine you have a group of entry-level developers. You can create an IAM group named `Junior application developers`, and include all entry-level developers. Then, associate a policy with that group that grants them permissions to view Amazon Connect users. In this scenario, you might have a policy such as the following sample.

```
{
  "Version": "2012-10-17",
  "Statement": [
    {
      "Effect": "Allow",
      "Action": [
        "connect:DescribeUser",
        "connect:ListUsers"
      ],
      "Resource": "*"
    }
  ]
}
```

This sample policy grants permissions to API actions listed in the `Action` element.

Note

If you don't specify a user ARN or ID in your statement, you must also grant the permission to use all resources for the action using the `*` wildcard for the `Resource` element.

Allow users to integrate with external applications

This example shows how you might create a policy that allows users to interact with their external application integrations.

```
{
  "Version": "2012-10-17",
  "Statement": [
    {
      "Sid": "AllowAllAppIntegrationsActions",
      "Effect": "Allow",
      "Action": [
        "app-integrations:ListEventIntegrations",
        "app-integrations:CreateEventIntegration",
        "app-integrations:GetEventIntegration",
        "app-integrations:UpdateEventIntegration",
        "app-integrations>DeleteEventIntegration",
        "app-integrations:ListDataIntegrations",
        "app-integrations:CreateDataIntegration",
        "app-integrations:GetDataIntegration",
        "app-integrations:UpdateDataIntegration",
        "app-integartions>DeleteDataIntegration"
      ],
      "Resource": "*"
    }
  ]
}
```

Describe and update Amazon Connect users based on tags

In an IAM policy, you can optionally specify conditions that control when a policy is in effect. For example, you can define a policy that allows users to update only an Amazon Connect user who is working in the test environment.

You can define some conditions that are specific to Amazon Connect, and define other conditions that apply to all of AWS. For more information and a list of AWS-wide conditions, see [Condition in IAM JSON Policy Elements Reference](#) in the *IAM User Guide*.

The following sample policy allows the "describe" and "update" actions for users with specific tags.

```
{
```



```
"Version": "2012-10-17",
"Statement": [
  {
    "Effect": "Allow",
    "Action": [
      "connect:DescribeUser",
      "connect:UpdateUser*"
    ],
    "Resource": "*",
    "Condition": {
      "StringEquals": {
        "aws:ResourceTag/Department": "Test"
      }
    }
  }
]
```

This policy allows "describe user" and "update user" but only for those Amazon Connect users tagged with tag "Department: Test" where "Department" is the tag key and "Test" is the tag value.

Create Amazon Connect users based on tags

The following sample policy allows the create actions for users with specific request tags.

```
{
  "Version": "2012-10-17",
  "Statement": [
    {
      "Effect": "Allow",
      "Action": [
        "connect:CreateUser",
        "connect:TagResource"
      ],
      "Resource": "*",
      "Condition": {
        "StringEquals": {
          "aws:RequestTag/Owner": "TeamA"
        }
      }
    }
  ]
}
```

This policy allows "create user" and "tag resource" but the tag "Owner: TeamA" must be present in the requests.

Create and view Amazon AppIntegrations resources

The following sample policy allows event integrations to be created, listed, and fetched.

```
{
  "Version": "2012-10-17",
  "Statement": [
    {
      "Effect": "Allow",
      "Action": [
        "app-integrations:CreateEventIntegration",
        "app-integrations:GetEventIntegration",
        "app-integrations::ListEventIntegrations",
      ],
      "Resource": "*"
    }
  ]
}
```

Create and view Amazon Q in Connect Assistants

The following sample policy allows Amazon Q in Connect assistants to be created, listed, fetched, and deleted.

```
{
  "Version": "2012-10-17",
  "Statement": [
    {
      "Effect": "Allow",
      "Action": [
        "wisdom:CreateContent",
        "wisdom>DeleteContent",
        "wisdom:CreateKnowledgeBase",
        "wisdom:GetAssistant",
        "wisdom:GetKnowledgeBase",
        "wisdom:GetContent",
        "wisdom:GetRecommendations",
        "wisdom:GetSession",
        "wisdom:NotifyRecommendationsReceived",
      ]
    }
  ]
}
```

```

        "wisdom:QueryAssistant",
        "wisdom:StartContentUpload",
        "wisdom:UpdateContent",
        "wisdom:UntagResource",
        "wisdom:TagResource",
        "wisdom:CreateSession"
    ],
    "Resource": "*",
    "Condition": {
        "StringEquals": {
            "aws:ResourceTag/AmazonConnectEnabled": "True"
        }
    }
},
{
    "Action": [
        "wisdom:ListAssistants",
        "wisdom:ListKnowledgeBases"
    ],
    "Effect": "Allow",
    "Resource": "*"
}
]
}

```

Manage outbound campaigns resources

Onboarding permissions: The following sample policy allows Amazon Connect instances to be onboarded to outbound campaigns.

```

"Sid": "VisualEditor0",
  "Effect": "Allow",
  "Action": [
    "kms:DescribeKey",
    "kms:CreateGrant"
  ],
  "Resource": [
    "arn:aws:kms:region:account-id:key/key-id"
  ]
},
{
  "Sid": "VisualEditor1",
  "Effect": "Allow",

```

```

    "Action": [
      "connect:DescribeInstance"
    ],
    "Resource": [
      "arn:aws:connect:region:account-id:instance/instance-id"
    ]
  },
  {
    "Sid": "VisualEditor2",
    "Effect": "Allow",
    "Action": [
      "events:PutTargets",
      "events:PutRule",
      "iam:CreateServiceLinkedRole",
      "iam:AttachRolePolicy",
      "iam:PutRolePolicy",
      "ds:DescribeDirectories",
      "connect-campaigns:StartInstanceOnboardingJob",
      "connect-campaigns:GetConnectInstanceConfig",
      "connect-campaigns:GetInstanceOnboardingJobStatus",
      "connect-campaigns>DeleteInstanceOnboardingJob",
      "connect:DescribeInstanceAttribute",
      "connect:UpdateInstanceAttribute",
      "connect:ListInstances",
      "kms:ListAliases"
    ],
    "Resource": "*"
  }
}

```

To disable outbound campaigns for an instance, add the following permissions:

```

{
  "Version": "2012-10-17",
  "Statement": [
    {
      "Sid": "VisualEditor0",
      "Effect": "Allow",
      "Action": [
        "kms:DescribeKey",
        "kms:RetireGrant"
      ],
      "Resource": [

```

```

        "arn:aws:kms:region:account-id:key/key-id"
    ]
},
{
    "Sid": "VisualEditor1",
    "Effect": "Allow",
    "Action": [
        "events:DeleteRule",
        "events:RemoveTargets",
        "events:DescribeRule",
        "iam:DeleteRolePolicy",
        "events:ListTargetsByRule",
        "iam:DeleteServiceLinkedRole",
        "connect-campaigns:DeleteConnectInstanceConfig"
    ],
    "Resource": "*"
}
]

```

Management permissions: The following sample policy allows all read and write operations on outbound campaigns.

```

{
    "Sid": "AllowConnectCampaignsOperations",
    "Effect": "Allow",
    "Action": [
        "connect-campaigns:CreateCampaign",
        "connect-campaigns>DeleteCampaign",
        "connect-campaigns:DescribeCampaign",
        "connect-campaigns:UpdateCampaignName",
        "connect-campaigns:GetCampaignState",
        "connect-campaigns:UpdateOutboundCallConfig",
        "connect-campaigns:UpdateDialerConfig",
        "connect-campaigns:PauseCampaign",
        "connect-campaigns:ResumeCampaign",
        "connect-campaigns:StopCampaign",
        "connect-campaigns:GetCampaignStateBatch",
        "connect-campaigns:ListCampaigns"
    ],
    "Resource": "*"
}

```

ReadOnly permissions: The following sample policy allows read-only access to the campaigns.

```
{
  "Sid": "AllowConnectCampaignsReadOnlyOperations",
  "Effect": "Allow",
  "Action": [
    "connect-campaigns:DescribeCampaign",
    "connect-campaigns:GetCampaignState",
    "connect-campaigns:GetCampaignStateBatch",
    "connect-campaigns:ListCampaigns"
  ],
  "Resource": "*",
}
```

Tag-based permissions: The following sample policy restricts access to the campaigns integrated with a particular Amazon Connect instance using tags. More permissions can be added based on the use case.

```
{
  "Sid": "AllowConnectCampaignsOperations",
  "Effect": "Allow",
  "Action": [
    "connect-campaigns:DescribeCampaign",
    "connect-campaigns:GetCampaignState"
  ],
  "Resource": "*",
  "Condition": {
    "StringEquals": {
      "aws:ResourceTag/owner":
        "arn:aws:connect:region:customer_account_id:instance/connect_instance_id"
    }
  }
}
```

Note

`connect-campaigns:ListCampaigns` and `connect-campaigns:GetCampaignStateBatch` operations cannot be restricted by Tag.

Amazon Connect resource-level policy examples

Amazon Connect supports resource-level permissions for users, so you can specify actions for them for an instance, as shown in the following policies.

Contents

- [Deny the "delete" and "update" actions](#)
- [Allow actions for integrations with specific names](#)
- [Allow "create users" but deny if you're assigned to a specific security profile](#)
- [Allow recording actions on a contact](#)
- [Allow or Deny queue API actions for phone numbers in a replica Region](#)
- [View specific Amazon AppIntegrations resources](#)
- [Grant access to Amazon Connect Customer Profiles](#)
- [Grant read-only access to Customer Profiles data](#)
- [Query Amazon Q in Connect only for a specific Assistant](#)
- [Grant full access to Amazon Connect Voice ID](#)
- [Grant access to Amazon Connect outbound campaigns resources](#)
- [Restrict the ability to search on transcripts analyzed by Amazon Connect Contact Lens](#)

Deny the "delete" and "update" actions

This following sample policy denies the "delete" and "update" actions for users in one Amazon Connect instance. It uses a wild card at the end of the Amazon Connect user ARN so that "delete user" and "update user" are denied on the full user ARN (that is, all Amazon Connect users in the provided instance, such as `arn:aws:connect:us-east-1:123456789012:instance/00fbeee1-123e-111e-93e3-11111bfbfcc1/agent/00dtcddd1-123e-111e-93e3-11111bfbfcc1`).

```
{
  "Version": "2012-10-17",
  "Statement": [
    {
      "Effect": "Deny",
      "Action": [
```

```

        "connect:DeleteUser",
        "connect:UpdateUser*"
    ],
    "Resource": "arn:aws:connect:us-
east-1:123456789012:instance/00fbee1-123e-111e-93e3-11111bfbfcc1/agent/*"
    }
]
}

```

Allow actions for integrations with specific names

```

{
  "Version": "2012-10-17",
  "Statement": [
    {
      "Sid": "AllowAllAppIntegrationsActions",
      "Effect": "Allow",
      "Action": [
        "app-integrations:ListEventIntegrations",
        "app-integrations:CreateEventIntegration",
        "app-integrations:GetEventIntegration",
        "app-integrations:UpdateEventIntegration",
        "app-integartions:DeleteEventIntegration"
      ],
      "Resource": "arn:aws:appintegrations:*:*:event-integration/MyNamePrefix-*"
    }
  ]
}

```

Allow "create users" but deny if you're assigned to a specific security profile

The following sample policy allows "create users" but explicitly denies using `arn:aws:connect:us-west-2:123456789012:instance/00fbee1-123e-111e-93e3-11111bfbfcc1/security-profile/11dtcggg1-123e-111e-93e3-11111bfbfcc17` as the parameter for security profile in [CreateUser](#) request.

```

{
  "Version": "2012-10-17",
  "Statement": [
    {
      "Effect": "Allow",
      "Action": [

```



```

        "connect:CreateUser"
    ],
    "Resource": "*",
  },
  {
    "Effect": "Deny",
    "Action": [
      "connect:CreateUser"
    ],
    "Resource": "arn:aws:connect:us-
west-2:123456789012:instance/00fbee1-123e-111e-93e3-11111bfbfcc17/security-
profile/11dtcggg1-123e-111e-93e3-11111bfbfcc17",
  }
]
}

```

Allow recording actions on a contact

The following sample policy allows "start contact recording" on a contact in a specific instance. Since `contactID` is dynamic, `*` is used.

```

{
  "Version": "2012-10-17",
  "Statement": [
    {
      "Action": [
        "connect:StartContactRecording"
      ],
      "Resource": "arn:aws:connect:us-west-2:accountID:instance/instanceId/contact/*",
      "Effect": "Allow"
    }
  ]
}

```

Set up a trusted relationship with *accountID*.

The following actions are defined for the recording APIs:

- "connect:StartContactRecording"
- "connect:StopContactRecording"
- "connect:SuspendContactRecording"

- "connect:ResumeContactRecording"

Allow more contact Actions in the same role

If the same role is used to calling other contact APIs, you can list the following contact actions:

- GetContactAttributes
- ListContactFlows
- StartChatContact
- StartOutboundVoiceContact
- StopContact
- UpdateContactAttributes

Or use a wildcard to allow all contact actions, for example: "connect:*"

Allow more resources

You can also use a wildcard to allow more resources. For example, here's how to allow all connect actions on all contact resources:

```
{
  "Version": "2012-10-17",
  "Statement": [
    {
      "Action": [
        "connect:*"
      ],
      "Resource": "arn:aws:connect:us-west-2:accountID:instance/*/contact/*",
      "Effect": "Allow"
    }
  ]
}
```

Allow or Deny queue API actions for phone numbers in a replica Region

The [CreateQueue](#) and [UpdateQueueOutboundCallerConfig](#) APIs contain an input field named `OutboundCallerIdNumberId`. This field represents a phone number resource that can be claimed to a traffic distribution group. It supports both the phone number V1 ARN format that is returned by [ListPhoneNumbers](#) and the V2 ARN format that is returned by [ListPhoneNumbersV2](#).

Following are the V1 and V2 ARN formats that `OutboundCallerIdNumberId` supports:

- **V1 ARN format:** `arn:aws:connect:your-region:your-account_id:instance/instance_id/phone-number/resource_id`
- **V2 ARN format:** `arn:aws:connect:your-region:your-account_id:phone-number/resource_id`

Note

We recommend using the V2 ARN format. The V1 ARN format is going to be deprecated in the future.

Provide both ARN formats for phone number resources in the replica Region

If the phone number is claimed to a traffic distribution group, to correctly allow/deny access to queue API actions for phone number resources while operating in the replica Region **you must provide the phone number resource in both V1 and V2 ARN formats**. If you provide the phone number resource in only one ARN format, it does not result in the correct allow/deny behavior while operating in the replica Region.

Example 1: Deny access to `CreateQueue`

For example, you're operating in the replica Region `us-west-2` with account `123456789012` and instance `aaaaaaaa-bbbb-cccc-dddd-0123456789012`. You want to deny access to [CreateQueue](#) API when the `OutboundCallerIdNumberId` value is a phone number claimed to a traffic distribution group with resource ID `aaaaaaaa-eeee-ffff-gggg-0123456789012`. In this scenario you must use the following policy:

```
{
  "Version": "2012-10-17",
  "Statement": [
    {
      "Sid": "DenyCreateQueueForSpecificNumber",
      "Effect": "Deny",
      "Action": "connect:CreateQueue",
      "Resource": [
        "arn:aws:connect:us-east-1:123456789012:phone-number/aaaaaaaa-eeee-ffff-gggg-0123456789012",
```

```

        "arn:aws:connect:us-west-2:123456789012:instance/aaaaaaaa-bbbb-cccc-
        dddd-0123456789012/phone-number/aaaaaaaa-eeee-ffff-gggg-0123456789012"
    ]
}
]
}

```

Where us-west-2 is the Region where the request is being made.

Example 2: Only allow access to UpdateQueueOutboundCallerConfig

For example, you're operating in the replica Region us-west-2 with account 123456789012 and instance aaaaaaaaa-bbbb-cccc-dddd-0123456789012. You want to only allow access to [UpdateQueueOutboundCallerConfig](#) API when the OutboundCallerIdNumberId value is a phone number claimed to a traffic distribution group with resource ID aaaaaaaaa-eeee-ffff-gggg-0123456789012. In this scenario you must use the following policy:

```

{
  "Version": "2012-10-17",
  "Statement": [
    {
      "Sid": "OnlyAllowUpdateQueueOutboundCallerConfigForSpecificNumber",
      "Effect": "Allow",
      "Action": "connect:UpdateQueueOutboundCallerConfig",
      "Resource": [
        "arn:aws:connect:us-east-1:123456789012:phone-number/aaaaaaaa-eeee-
        ffff-gggg-0123456789012",
        "arn:aws:connect:us-west-2:123456789012:instance/aaaaaaaa-bbbb-cccc-
        dddd-0123456789012/phone-number/aaaaaaaa-eeee-ffff-gggg-0123456789012"
      ]
    }
  ]
}

```

View specific Amazon AppIntegrations resources

The following sample policy allows a specific event integrations to be fetched.

```

{
  "Version": "2012-10-17",
  "Statement": [

```

```

    {
      "Effect": "Allow",
      "Action": [
        "app-integrations:GetEventIntegration"
      ],
      "Resource": "arn:aws:app-integrations:us-west-2:accountID:event-
integration/Name"
    }
  ]
}

```

Grant access to Amazon Connect Customer Profiles

Amazon Connect Customer Profiles use `profile` as the prefix for actions instead of `connect`. The following policy grants full access to a specific domain in Amazon Connect Customer Profiles.

```

{
  "Version": "2012-10-17",
  "Statement": [
    {
      "Action": [
        "profile:*"
      ],
      "Resource": "arn:aws:profile:us-west-2:accountID:domains/domainName",
      "Effect": "Allow"
    }
  ]
}

```

Set up a trusted relationship with `accountID` to domain `domainName`.

Grant read-only access to Customer Profiles data

Following is an example for granting read access to the data in Amazon Connect Customer Profiles.

```

{
  "Version": "2012-10-17",
  "Statement": [
    {
      "Action": [
        "profile:SearchProfiles",
        "profile:ListObjects"
      ]
    }
  ]
}

```

```

    ],
    "Resource": "arn:aws:profile:us-west-2:accountID:domains/domainName",
    "Effect": "Allow"
  }
]
}

```

Query Amazon Q in Connect only for a specific Assistant

The following sample policy allows querying only a specific Assistant.

```

{
  "Version": "2012-10-17",
  "Statement": [
    {
      "Effect": "Allow",
      "Action": [
        "wisdom:QueryAssistant "
      ],
      "Resource": "arn:aws:wisdom:us-west-2:accountID:assistant/assistantID"
    }
  ]
}

```

Grant full access to Amazon Connect Voice ID

Amazon Connect Voice ID uses `voiceid` as the prefix for actions instead of `connect`. The following policy grants full access to a specific domain in Amazon Connect Voice ID:

```

{
  "Version": "2012-10-17",
  "Statement": [
    {
      "Action": [
        "voiceid:*"
      ],
      "Resource": "arn:aws:voiceid:us-west-2:accountID:domain/domainName",
      "Effect": "Allow"
    }
  ]
}

```

Set up a trusted relationship with accountID to domain domainName.

Grant access to Amazon Connect outbound campaigns resources

Outbound campaigns uses connect-campaign as the prefix for actions instead of connect. The following policy grants full access to a specific outbound campaign.

```
{
  "Sid": "AllowConnectCampaignsOperations",
  "Effect": "Allow",
  "Action": [
    "connect-campaigns:DeleteCampaign",
    "connect-campaigns:DescribeCampaign",
    "connect-campaigns:UpdateCampaignName",
    "connect-campaigns:GetCampaignState",
    "connect-campaigns:UpdateOutboundCallConfig",
    "connect-campaigns:UpdateDialerConfig",
    "connect-campaigns:PauseCampaign",
    "connect-campaigns:ResumeCampaign",
    "connect-campaigns:StopCampaign"
  ],
  "Resource": "arn:aws:connect-campaigns:us-west-2:accountID:campaign/campaignId",
}
```

Restrict the ability to search on transcripts analyzed by Amazon Connect Contact Lens

The following policy allows search and describe contacts, but denies searching a contact using transcripts analyzed by Amazon Connect Contact Lens.

```
{
  "Version": "2012-10-17",
  "Statement": [
    {
      "Sid": "VisualEditor0",
      "Effect": "Allow",
      "Action": [
        "connect:DescribeContact"
      ],
      "Resource": "arn:aws:connect:region:account-id:instance/instance-id/contact/*"
    }
  ],
}
```

```
{
  "Sid": "VisualEditor1",
  "Effect": "Allow",
  "Action": [
    "connect:SearchContacts"
  ],
  "Resource": "arn:aws:connect:region:account-id:instance/instance-id"
},
{
  "Sid": "VisualEditor2",
  "Effect": "Deny",
  "Action": [
    "connect:SearchContacts"
  ],
  "Resource": "arn:aws:connect:region:account-id:instance/instance-id",
  "Condition": {
    "ForAnyValue:StringEquals": {
      "connect:SearchContactsByContactAnalysis": [
        "Transcript"
      ]
    }
  }
}
]
```

AWS managed policies for Amazon Connect

To add permissions to users, groups, and roles, it is more efficient to use AWS managed policies than to write policies yourself. It takes time and expertise to [create IAM customer managed](#) policies that provide your team with only the permissions that they need. To get started quickly, you can use AWS managed policies. These policies cover common use cases and are available in your AWS account. For more information about AWS managed policies, see [AWS managed policies](#) in the *IAM User Guide*.

AWS services maintain and update AWS managed policies. You can't change the permissions in AWS managed policies. Services occasionally add additional permissions to an AWS managed policy to support new features. This type of update affects all identities (users, groups, and roles) where the policy is attached. Services are most likely to update an AWS managed policy when a new feature is launched or when new operations become available. Services do not remove permissions from an AWS managed policy, so policy updates won't break your existing permissions.

Additionally, AWS supports managed policies for job functions that span multiple services. For example, the `ReadOnlyAccess` AWS managed policy provides read-only access to all AWS services and resources. When a service launches a new feature, AWS adds read-only permissions for new operations and resources. For a list and descriptions of job function policies, see [AWS managed policies for job functions](#) in the *IAM User Guide*.

AWS managed policy: `AmazonConnect_FullAccess`

To allow full read/write access to Amazon Connect, you must attach two policies to your IAM users, groups, or roles. Attach the `AmazonConnect_FullAccess` policy and a custom policy with the following contents:

Custom Policy

```
{
  "Version": "2012-10-17",
  "Statement": [
    {
      "Sid": "AttachAnyPolicyToAmazonConnectRole",
      "Effect": "Allow",
      "Action": "iam:PutRolePolicy",
      "Resource": "arn:aws:iam::*:role/aws-service-role/connect.amazonaws.com/AWSServiceRoleForAmazonConnect*"
    }
  ]
}
```

`AmazonConnect_FullAccess` Policy

```
{
  "Version": "2012-10-17",
  "Statement": [
    {
      "Effect": "Allow",
      "Action": [
        "connect:*",
        "ds:CreateAlias",
        "ds:AuthorizeApplication",
        "ds:CreateIdentityPoolDirectory",
        "ds>DeleteDirectory",
        "ds:DescribeDirectories",
        "ds:UnauthorizeApplication",

```

```

        "firehose:DescribeDeliveryStream",
        "firehose:ListDeliveryStreams",
        "kinesis:DescribeStream",
        "kinesis:ListStreams",
        "kms:DescribeKey",
        "kms:ListAliases",
        "lex:GetBots",
        "lex:ListBots",
        "lex:ListBotAliases",
        "logs:CreateLogGroup",
        "s3:GetBucketLocation",
        "s3:ListAllMyBuckets",
        "lambda:ListFunctions",
        "ds:CheckAlias",
        "profile:ListAccountIntegrations",
        "profile:GetDomain",
        "profile:ListDomains",
        "profile:GetProfileObjectType",
        "profile:ListProfileObjectTypeTemplates"
    ],
    "Resource": "*"
},
{
    "Effect": "Allow",
    "Action": [
        "profile:AddProfileKey",
        "profile:CreateDomain",
        "profile:CreateProfile",
        "profile>DeleteDomain",
        "profile>DeleteIntegration",
        "profile>DeleteProfile",
        "profile>DeleteProfileKey",
        "profile>DeleteProfileObject",
        "profile>DeleteProfileObjectType",
        "profile:GetIntegration",
        "profile:GetMatches",
        "profile:GetProfileObjectType",
        "profile:ListIntegrations",
        "profile:ListProfileObjects",
        "profile:ListProfileObjectTypes",
        "profile:ListTagsForResource",
        "profile:MergeProfiles",
        "profile:PutIntegration",
        "profile:PutProfileObject",
    ]
}

```

```

        "profile:PutProfileObjectType",
        "profile:SearchProfiles",
        "profile:TagResource",
        "profile:UntagResource",
        "profile:UpdateDomain",
        "profile:UpdateProfile"
    ],
    "Resource": "arn:aws:profile:*:*:domains/amazon-connect-*"
},
{
    "Effect": "Allow",
    "Action": [
        "s3:CreateBucket",
        "s3:GetBucketAcl"
    ],
    "Resource": "arn:aws:s3:::amazon-connect-*"
},
{
    "Effect": "Allow",
    "Action": [
        "servicequotas:GetServiceQuota"
    ],
    "Resource": "arn:aws:servicequotas:*:*:connect/*"
},
{
    "Effect": "Allow",
    "Action": "iam:CreateServiceLinkedRole",
    "Resource": "*",
    "Condition": {
        "StringEquals": {
            "iam:AWSServiceName": "connect.amazonaws.com"
        }
    }
},
{
    "Effect": "Allow",
    "Action": "iam:DeleteServiceLinkedRole",
    "Resource": "arn:aws:iam:*:*:role/aws-service-role/connect.amazonaws.com/
AWSServiceRoleForAmazonConnect*"
},
{
    "Effect": "Allow",
    "Action": "iam:CreateServiceLinkedRole",

```

```
    "Resource": "arn:aws:iam::*:role/aws-service-role/profile.amazonaws.com/*",
    "Condition": {
      "StringEquals": {
        "iam:AWSServiceName": "profile.amazonaws.com"
      }
    }
  }
]
```

To allow a user to create an instance, ensure that they have the permissions granted by the `AmazonConnect_FullAccess` policy.

When you use `AmazonConnect_FullAccess` policy, note the following:

- The `iam:PutRolePolicy` allows the user who gets that policy to configure any resource in the account to work with the Amazon Connect instance. Because it grants such broad permissions, only assign it when necessary. Instead, create the service-linked role with access to the necessary resources and let the user have access to pass the service-linked role to Amazon Connect (which is granted by the `AmazonConnect_FullAccess` policy).
- Additional privileges are required to create a Amazon S3 bucket with a name of your choosing, or use an existing bucket while creating or updating an instance from the Amazon Connect admin website. If you choose default storage locations for your call recordings, chat transcripts, call transcripts, and other data, the system prepends "amazon-connect-" to the names of those objects.
- The `aws/connect` KMS key is available to use as a default encryption option. To use a custom encryption key, assign users additional KMS privileges.
- Assign users additional privileges to attach other AWS resources like Amazon Polly, Live Media Streaming, Data Streaming, and Lex bots to their Amazon Connect instances.

For more information and detailed permissions, see [Required permissions for using custom IAM policies to manage access to the Amazon Connect admin website](#).

AWS managed policy: `AmazonConnectReadOnlyAccess`

To allow read-only access, you need to attach only the `AmazonConnectReadOnlyAccess` policy:

```
{
```

```

"Version": "2012-10-17",
"Statement": [
  {
    "Sid": "AllowConnectReadOnly",
    "Effect": "Allow",
    "Action": [
      "connect:Get*",
      "connect:Describe*",
      "connect:List*",
      "ds:DescribeDirectories"
    ],
    "Resource": "*"
  },
  {
    "Sid": "DenyConnectEmergencyAccess",
    "Effect": "Deny",
    "Action": "connect:AdminGetEmergencyAccessToken",
    "Resource": "*"
  }
]
}

```

AWS managed policy: AmazonConnectServiceLinkedRolePolicy

The AmazonConnectServiceLinkedRolePolicy role permissions policy allows Amazon Connect to complete the following actions on the specified resources. As you enable additional features in Amazon Connect, additional permissions are added for the [AWSServiceRoleForAmazonConnect](#) service-linked role to access the resources associated with those features:

```

{
  "Version": "2012-10-17",
  "Statement": [
    {
      "Sid": "AllowConnectActions",
      "Effect": "Allow",
      "Action": [
        "connect:*"
      ],
      "Resource": [
        "*"
      ]
    }
  ]
}

```

```

    ],
  },
  {
    "Sid": "AllowDeleteSLR",
    "Effect": "Allow",
    "Action": [
      "iam:DeleteRole"
    ],
    "Resource": "arn:aws:iam::*:role/aws-service-role/connect.amazonaws.com/
AWSServiceRoleForAmazonConnect_*"
  },
  {
    "Sid": "AllowS3ObjectForConnectBucket",
    "Effect": "Allow",
    "Action": [
      "s3:GetObject",
      "s3:GetObjectAcl",
      "s3:PutObject",
      "s3:PutObjectAcl",
      "s3:DeleteObject"
    ],
    "Resource": [
      "arn:aws:s3:::amazon-connect-*/*"
    ]
  },
  {
    "Sid": "AllowGetBucketMetadataForConnectBucket",
    "Effect": "Allow",
    "Action": [
      "s3:GetBucketLocation",
      "s3:GetBucketAcl"
    ],
    "Resource": [
      "arn:aws:s3:::amazon-connect-*"
    ]
  },
  {
    "Sid": "AllowConnectLogGroupAccess",
    "Effect": "Allow",
    "Action": [
      "logs:CreateLogStream",
      "logs:DescribeLogStreams",
      "logs:PutLogEvents"
    ],
  },

```

```

        "Resource": [
            "arn:aws:logs:*:*:log-group:/aws/connect/*:*"
        ]
    },
    {
        "Sid": "AllowListLexBotAccess",
        "Effect": "Allow",
        "Action": [
            "lex:ListBots",
            "lex:ListBotAliases"
        ],
        "Resource": "*"
    },
    {
        "Sid": "AllowCustomerProfilesForConnectDomain",
        "Effect": "Allow",
        "Action": [
            "profile:SearchProfiles",
            "profile:CreateProfile",
            "profile:UpdateProfile",
            "profile:AddProfileKey",
            "profile:ListProfileObjectTypes",
            "profile:ListCalculatedAttributeDefinitions",
            "profile:ListCalculatedAttributesForProfile",
            "profile:GetDomain",
            "profile:ListIntegrations"
        ],
        "Resource": "arn:aws:profile:*:*:domains/amazon-connect-*"
    },
    {
        "Sid": "AllowReadPermissionForCustomerProfileObjects",
        "Effect": "Allow",
        "Action": [
            "profile:ListProfileObjects",
            "profile:GetProfileObjectType"
        ],
        "Resource": [
            "arn:aws:profile:*:*:domains/amazon-connect-*/object-types/*"
        ]
    },
    {
        "Sid": "AllowListIntegrationForCustomerProfile",
        "Effect": "Allow",
        "Action": [

```

```
        "profile:ListAccountIntegrations"
    ],
    "Resource": "*"
},
{
    "Sid": "AllowReadForCustomerProfileObjectTemplates",
    "Effect": "Allow",
    "Action": [
        "profile:ListProfileObjectTypeTemplates",
        "profile:GetProfileObjectTypeTemplate"
    ],
    "Resource": "arn:aws:profile:*:*:/templates*"
},
{
    "Sid": "AllowWisdomForConnectEnabledTaggedResources",
    "Effect": "Allow",
    "Action": [
        "wisdom:CreateContent",
        "wisdom:DeleteContent",
        "wisdom:CreateKnowledgeBase",
        "wisdom:GetAssistant",
        "wisdom:GetKnowledgeBase",
        "wisdom:GetContent",
        "wisdom:GetRecommendations",
        "wisdom:GetSession",
        "wisdom:NotifyRecommendationsReceived",
        "wisdom:QueryAssistant",
        "wisdom:StartContentUpload",
        "wisdom:UpdateContent",
        "wisdom:UntagResource",
        "wisdom:TagResource",
        "wisdom:CreateSession",
        "wisdom:CreateQuickResponse",
        "wisdom:GetQuickResponse",
        "wisdom:SearchQuickResponses",
        "wisdom:StartImportJob",
        "wisdom:GetImportJob",
        "wisdom:ListImportJobs",
        "wisdom:ListQuickResponses",
        "wisdom:UpdateQuickResponse",
        "wisdom>DeleteQuickResponse",
        "wisdom:PutFeedback",
        "wisdom:ListContentAssociations"
    ],
}
```



```

    "Resource": "*",
    "Condition": {
      "StringEquals": {
        "aws:ResourceTag/AmazonConnectEnabled": "True"
      }
    }
  },
  {
    "Sid": "AllowListOperationForWisdom",
    "Effect": "Allow",
    "Action": [
      "wisdom:ListAssistants",
      "wisdom:ListKnowledgeBases"
    ],
    "Resource": "*"
  },
  {
    "Sid": "AllowCustomerProfilesCalculatedAttributesForConnectDomain",
    "Effect": "Allow",
    "Action": [
      "profile:GetCalculatedAttributeForProfile",
      "profile:CreateCalculatedAttributeDefinition",
      "profile>DeleteCalculatedAttributeDefinition",
      "profile:GetCalculatedAttributeDefinition",
      "profile:UpdateCalculatedAttributeDefinition"
    ],
    "Resource": [
      "arn:aws:profile:*:*:domains/amazon-connect-*/calculated-attributes/*"
    ]
  },
  {
    "Sid": "AllowPutMetricsForConnectNamespace",
    "Effect": "Allow",
    "Action": "cloudwatch:PutMetricData",
    "Resource": "*",
    "Condition": {
      "StringEquals": {
        "cloudwatch:namespace": "AWS/Connect"
      }
    }
  },
  {
    "Sid": "AllowSMSVoiceOperationsForConnect",
    "Effect": "Allow",

```

```

    "Action": [
      "sms-voice:SendTextMessage",
      "sms-voice:DescribePhoneNumbers"
    ],
    "Resource": "arn:aws:sms-voice:*:*:phone-number/*",
    "Condition": {
      "StringEquals": {
        "aws:ResourceAccount": "${aws:PrincipalAccount}"
      }
    }
  },
  {
    "Sid": "AllowCognitoForConnectEnabledTaggedResources",
    "Effect": "Allow",
    "Action": [
      "cognito-idp:DescribeUserPool",
      "cognito-idp:ListUserPoolClients"
    ],
    "Resource": "arn:aws:cognito-idp:*:*:userpool/*",
    "Condition": {
      "StringEquals": {
        "aws:ResourceTag/AmazonConnectEnabled": "True"
      }
    }
  },
  {
    "Sid": "AllowWritePermissionForCustomerProfileObjects",
    "Effect": "Allow",
    "Action": [
      "profile:PutProfileObject"
    ],
    "Resource": [
      "arn:aws:profile:*:*:domains/amazon-connect-*/object-types/*"
    ]
  }
]
}

```

AWS managed policy: AmazonConnectCampaignsServiceLinkedRolePolicy

The AmazonConnectCampaignsServiceLinkedRolePolicy role permissions policy allows Amazon Connect outbound campaigns to complete the following actions on the specified resources.

```
{
  "Version": "2012-10-17",
  "Statement": [
    {
      "Effect": "Allow",
      "Action": [
        "connect-campaigns:ListCampaigns"
      ],
      "Resource": "*"
    },
    {
      "Effect": "Allow",
      "Action": [
        "connect:BatchPutContact",
        "connect:StopContact"
      ],
      "Resource": "arn:aws:connect:*:*:instance/*"
    }
  ]
}
```

AWS managed policy: AmazonConnectVoiceIDFullAccess

To allow full access to Amazon Connect Voice ID, you must attach two policies to your users, groups, or roles. Attach the AmazonConnectVoiceIDFullAccess policy and the following custom policy contents to access Voice ID through the Amazon Connect admin website:

```
{
  "Version": "2012-10-17",
  "Statement": [
    {
      "Sid": "AttachAnyPolicyToAmazonConnectRole",
      "Effect": "Allow",
      "Action": "iam:PutRolePolicy",

```

```

        "Resource": "arn:aws:iam::*:role/aws-service-role/connect.amazonaws.com/
AWSServiceRoleForAmazonConnect*"
    },
    {
        "Effect": "Allow",
        "Action": [
            "connect:CreateIntegrationAssociation",
            "connect:DeleteIntegrationAssociation",
            "connect:ListIntegrationAssociations"
        ],
        "Resource": "*"
    },
    {
        "Effect": "Allow",
        "Action": [
            "events:DeleteRule",
            "events:PutRule",
            "events:PutTargets",
            "events:RemoveTargets"
        ],
        "Resource": "*",
        "Condition": {
            "StringEquals": {
                "events:ManagedBy": "connect.amazonaws.com"
            }
        }
    }
]
}

```

The manual policy configures the following:

- The `iam:PutRolePolicy` allows the user who gets that policy to configure any resource in the account to work with the Amazon Connect instance. Because it grants such broad permissions, only assign it when necessary.
- To attach a Voice ID domain with an Amazon Connect instance, you need additional Amazon Connect and Amazon EventBridge privileges. You need privileges to call Amazon Connect APIs to create, delete, and list integration associations. You need EventBridge permissions to create and delete EventBridge rules which are used to provide contact records related to Voice ID.

Since there is no default encryption option, to use your customer managed key with your Amazon Connect Voice ID, the following API operations must be permitted in the key policy. Also, you must add these permissions on the relevant key. They are not included in the managed policy.

- `kms:Decrypt` to access or store encrypted data.
- `kms:CreateGrant` – when creating or updating a domain, used to create a grant to the customer managed key for the Voice ID domain. The grant controls access to the specified KMS key which allows access to [grant operations](#) Amazon Connect Voice ID requires. For more information about using grants, see [Using grants](#) in the *AWS Key Management Service Developer Guide*.
- `kms:DescribeKey` – when creating or updating a domain, allows determining the ARN for KMS key you provided.

For more about creating domains and KMS keys, see [Enable Voice ID](#) and [Encryption at rest](#).

AWS managed policy: CustomerProfilesServiceLinkedRolePolicy

To allow Amazon Connect Customer Profiles to publish CloudWatch metrics to your AWS account, you must attach the `CustomerProfilesServiceLinkedRolePolicy` managed policy:

```
{
  "Version": "2012-10-17",
  "Statement": [
    {
      "Effect": "Allow",
      "Action": [
        "cloudwatch:PutMetricData"
      ],
      "Resource": "",
      "Condition": {
        "StringEquals": {
          "cloudwatch:namespace": "AWS/CustomerProfiles"
        }
      }
    },
    {
      "Effect": "Allow",
      "Action": [
        "iam>DeleteRole"
      ]
    }
  ]
}
```

```

        ],
        "Resource": "arn:aws:iam:::role/aws-service-role/profile.amazonaws.com/
AWSServiceRoleForProfile_*"
    }
]
}

```

AWS managed policy: AmazonConnectSynchronizationServiceRolePolicy

The AmazonConnectSynchronizationServiceRolePolicy permissions policy allows Amazon Connect Managed Synchronization to complete the following read, write, update, and delete actions on the specified resources. As resource synchronization is enabled for more resources, additional permissions are added to the [AWSServiceRoleForAmazonConnectSynchronization](#) service-linked role to access these resources.

The AmazonConnectSynchronizationServiceRolePolicy permissions policy is grouped into the following sets of permissions.

- **connect** – Connect permissions for the synchronization of Connect configurations and resources.
- **cloudwatch** – CloudWatch permissions to publish Amazon Connect usage metrics for an instance in your account.

```

{
  "Version": "2012-10-17",
  "Statement": [
    {
      "Sid": "AllowConnectActions",
      "Effect": "Allow",
      "Action": [
        "connect:CreateUser*",
        "connect:UpdateUser*",
        "connect:DeleteUser*",
        "connect:DescribeUser*",
        "connect:ListUser*",
        "connect:CreateRoutingProfile",
        "connect:UpdateRoutingProfile*",
        "connect:DeleteRoutingProfile",
        "connect:DescribeRoutingProfile",

```

```
"connect:ListRoutingProfile*",
"connect:CreateAgentStatus",
"connect:UpdateAgentStatus",
"connect:DescribeAgentStatus",
"connect:ListAgentStatuses",
"connect:CreateQuickConnect",
"connect:UpdateQuickConnect*",
"connect:DeleteQuickConnect",
"connect:DescribeQuickConnect",
"connect:ListQuickConnects",
"connect:CreateHoursOfOperation",
"connect:UpdateHoursOfOperation",
"connect:DeleteHoursOfOperation",
"connect:DescribeHoursOfOperation",
"connect:ListHoursOfOperations",
"connect:CreateQueue",
"connect:UpdateQueue*",
"connect:DeleteQueue",
"connect:DescribeQueue",
"connect:ListQueue*",
"connect:CreatePrompt",
"connect:UpdatePrompt",
"connect:DeletePrompt",
"connect:DescribePrompt",
"connect:ListPrompts",
"connect:GetPromptFile",
"connect:CreateSecurityProfile",
"connect:UpdateSecurityProfile",
"connect:DeleteSecurityProfile",
"connect:DescribeSecurityProfile",
"connect:ListSecurityProfile*",
"connect:CreateContactFlow*",
"connect:UpdateContactFlow*",
"connect:DeleteContactFlow*",
"connect:DescribeContactFlow*",
"connect:ListContactFlow*",
"connect:BatchGetFlowAssociation",
"connect:CreatePredefinedAttribute",
"connect:UpdatePredefinedAttribute",
"connect:DeletePredefinedAttribute",
"connect:DescribePredefinedAttribute",
"connect:ListPredefinedAttributes",
"connect:ListTagsForResource",
"connect:TagResource",
```

```

    "connect:UntagResource",
    "connect:ListTrafficDistributionGroups",
    "connect:ListPhoneNumbersV2",
    "connect:UpdatePhoneNumber",
    "connect:DescribePhoneNumber",
    "connect:Associate*",
    "connect:Disassociate*"
  ],
  "Resource": "*"
},
{
  "Sid": "AllowPutMetricsForConnectNamespace",
  "Effect": "Allow",
  "Action": "cloudwatch:PutMetricData",
  "Resource": "*",
  "Condition": {
    "StringEquals": {
      "cloudwatch:namespace": "AWS/Connect"
    }
  }
}
]
}

```

Amazon Connect updates to AWS managed policies

View details about updates to AWS managed policies for Amazon Connect since this service began tracking these changes. For automatic alerts about changes to this page, subscribe to the RSS feed on the [Amazon Connect Document history](#) page.

Change	Description	Date
AmazonConnectReadOnlyAccess – Renamed action <code>connect:GetFederationTokenTokens</code> and changed to <code>connect:AdminGetEmergencyAccessToken</code>	The <code>AmazonConnectReadOnlyAccess</code> managed policy has been updated due to the renaming of the Amazon Connect action <code>connect:GetFederationTokenTokens</code> to <code>connect:A</code>	June 15, 2024

Change	Description	Date
	<p><code>adminGetEmergencyAccessToken</code> . This change is backwards compatible and the <code>connect:AdminGetEmergencyAccessToken</code> action will function in the same way as the <code>connect:GetFederationTokens</code> action. If you leave the previously named <code>connect:GetFederationTokens</code> action in your policies, they will continue to function as expected.</p>	

Change	Description	Date
AmazonConnectServiceLinkedRolePolicy – Added actions for Amazon Cognito user pools and Amazon Connect Customer Profiles	<p>Added the following Amazon Cognito user pools actions to the service-linked role policy to allow select read operations on Cognito User Pool resources that have an AmazonConnectEnabled resource tag. This tag is put on the resource when the CreateIntegrationAssociations API is called:</p> <ul style="list-style-type: none">• cognito-idp:DescribeUserPool• cognito-idp:ListUserPoolClients <p>Added the following Amazon Connect Customer Profiles action to the service-linked role policy to allow permissions to put data into the Connect-adjacent service, Customer Profiles:</p> <ul style="list-style-type: none">• profile:PutProfileObject	May 23, 2024

Change	Description	Date
AmazonConnectServiceLinkedRolePolicy – Added actions for Amazon Q in Connect	<p>The following action is allowed to be performed on Amazon Q in Connect resources that have the resource tag 'AmazonConnectEnabled': 'True' on Amazon Q in Connect Knowledge Base:</p> <ul style="list-style-type: none"> • <code>wisdom:ListContentAssociations</code> 	May 20, 2024
AmazonConnectServiceLinkedRolePolicy – Added actions for Amazon Pinpoint	<p>Added the following actions to the service-linked role policy to use Amazon Pinpoint phone numbers to allow Amazon Connect to send SMS:</p> <ul style="list-style-type: none"> • <code>sms:DescribePhoneNumbers</code> • <code>sms:SendTextMessage</code> 	November 17, 2023
AmazonConnectServiceLinkedRolePolicy – Added actions for Amazon Q in Connect	<p>The following action is allowed to be performed on Amazon Q in Connect resources that have the resource tag 'AmazonConnectEnabled': 'True' on Amazon Q in Connect Knowledge Base:</p> <ul style="list-style-type: none"> • <code>wisdom:PutFeedback</code> 	November 15, 2023

Change	Description	Date
AmazonConnectCampaignsServiceLinkedRolePolicy – Added actions for Amazon Connect	Amazon Connect added new actions to retrieve outbound campaigns: <ul style="list-style-type: none">• <code>connect:BatchPutContact</code>• <code>connect:StopContact</code>	November 8, 2023
AmazonConnectSynchronizationServiceRolePolicy – Added new AWS managed policy	Added a new service-linked role managed policy for managed synchronization. The policy provides access to read, create, update, and delete Amazon Connect resources and is used to automatically synchronize AWS resources across AWS regions.	November 3, 2023

Change	Description	Date
AmazonConnectServiceLinkedRolePolicy – Added actions for Customer Profiles	<p>Added the following action to manage Amazon Connect Customer Profiles Service Linked Roles:</p> <ul style="list-style-type: none">• profile:ListCalculatedAttributesForProfile• profile:GetDomain• profile:ListIntegrations• profile:CreateCalculatedAttributeDefinition• profile>DeleteCalculatedAttributeDefinition• profile:GetCalculatedAttributeDefinition• profile:UpdateCalculatedAttributeDefinition	October 30, 2023

Change	Description	Date
AmazonConnectServiceLinkedRolePolicy – Added actions for Amazon Q in Connect	<p>The following actions are allowed to be performed on Amazon Q in Connect resources that have the resource tag 'AmazonConnectEnabled': 'True' on Amazon Q in Connect Knowledge Base:</p> <ul style="list-style-type: none">• <code>wisdom:CreateQuickResponse</code>• <code>wisdom:GetQuickResponse</code>• <code>wisdom:SearchQuickResponses</code>• <code>wisdom:StartImportJob</code>• <code>wisdom:GetImportJob</code>• <code>wisdom:ListImportJobs</code>• <code>wisdom:ListQuickResponses</code>• <code>wisdom:UpdateQuickResponse</code>• <code>wisdom>DeleteQuickResponse</code>	October 25, 2023

Change	Description	Date
AmazonConnectServiceLinkedRolePolicy – Added actions for Customer Profiles	Added the following action to manage Amazon Connect Customer Profiles Service Linked Roles: <ul style="list-style-type: none">• profile:ListCalculatedAttributeDefinitions• profile:GetCalculatedAttributeForProfile	October 6, 2023

Change	Description	Date
AmazonConnectServiceLinkedRolePolicy – Added actions for Amazon Q in Connect	<p>The following actions are allowed to be performed on Amazon Q in Connect resources that have the resource tag 'AmazonConnectEnabled': 'True' on Amazon Q in Connect knowledge bases and assistants:</p> <ul style="list-style-type: none">• <code>wisdom:CreateContent</code>• <code>wisdom>DeleteContent</code>• <code>wisdom>CreateKnowledgeBase</code>• <code>wisdom:GetAssistant</code>• <code>wisdom:GetKnowledgeBase</code>• <code>wisdom:GetContent</code>• <code>wisdom:GetRecommendations</code>• <code>wisdom:GetSession</code>• <code>wisdom:NotifyRecommendationsReceived</code>• <code>wisdom:QueryAssistant</code>• <code>wisdom:StartContentUpload</code>• <code>wisdom:UntagResource</code>• <code>wisdom:TagResource</code>	September 29, 2023

Change	Description	Date
	<ul style="list-style-type: none"> • <code>wisdom:CreateSession</code> <p>The following <code>List</code> actions are allowed to be performed on all Amazon Q in Connect resources:</p> <ul style="list-style-type: none"> • <code>wisdom:ListAssistants</code> • <code>wisdom:KnowledgeBases</code> 	
CustomerProfilesServiceLinkedRolePolicy – Added <code>CustomerProfilesServiceLinkedRolePolicy</code>	New managed policy.	March 7, 2023
AmazonConnect_FullAccess – Added permission for managing Amazon Connect Customer Profiles Service Linked Roles	<p>Added the following action to manage Amazon Connect Customer Profiles Service Linked Roles.</p> <ul style="list-style-type: none"> • <code>iam:CreateServiceLinkedRole</code> - allows you to create a service-linked role for Customer Profiles. 	January 26, 2023
AmazonConnectServiceLinkedRolePolicy – Added actions for Amazon CloudWatch	<p>Added the following action to publish usage Amazon Connect metrics for an instance to your account.</p> <ul style="list-style-type: none"> • <code>cloudwatch:PutMetricData</code> 	February 22, 2022

Change	Description	Date
<p>AmazonConnect_FullAccess – Added permissions for managing Amazon Connect Customer Profiles domains</p>	<p>Added all permissions for managing Amazon Connect Customer Profiles domains that are created for new Amazon Connect instances.</p> <ul style="list-style-type: none"> • <code>profile:ListAccountIntegrations</code> - Lists all the integrations associated with a specific URI in the AWS account. • <code>profile:ListDomains</code> - Returns a list of all the domains for an AWS account that have been created. • <code>profile:GetDomain</code> - Returns information about a specific domain. • <code>profile:ListProfileObjectTypeTemplates</code> - Allow the Amazon Connect admin website to display a list of templates that you can use to create your data mappings. • <code>profile:GetObjectTypes</code> - Allow you to view all the current Object Types (data mappings) that you've created. <p>The following permissions are allowed to be performed</p>	<p>November 12, 2021</p>

Change	Description	Date
	<p>on domains with a name that is prefixed with amazon-connect- :</p> <ul style="list-style-type: none"> • <code>profile:AddProfileKey</code> - Allows you to associate a new key value with a specific profile • <code>profile:CreateDomain</code> - Allows you to create new domains • <code>profile:CreateProfile</code> - Allows you to create new profiles • <code>profile>DeleteDomain</code> - Allows you to delete domains • <code>profile>DeleteIntegration</code> - Allows you to delete integrations with a domain • <code>profile>DeleteProfile</code> - Allows you to delete a profile • <code>profile>DeleteProfileKey</code> - Allows you to delete a profile key • <code>profile>DeleteProfileObject</code> - Allows you to delete a profile object • <code>profile>DeleteProfileObjectType</code> - 	

Change	Description	Date
	<p>Allows you to delete a profile object type</p> <ul style="list-style-type: none">• <code>profile:GetIntegration</code> - Allows you to retrieve information about an integration• <code>profile:GetMatches</code> - Allows you to retrieve possible profile matches• <code>profile:GetProfileObjectType</code> - Allows you to retrieve profile object types• <code>profile:ListIntegrations</code> - Allows you to list integrations• <code>profile:ListProfileObjects</code> - Allows you to list profile objects• <code>profile:ListProfileObjectTypes</code> - Allows you to list profile object types• <code>profile:ListTagsForResource</code> - Allows you to list tags for a resource• <code>profile:MergeProfiles</code> - Allows you to merge profile matches• <code>profile:PutIntegration</code> - Allows you to add an integration between the service and a third-par	

Change	Description	Date
	<p>ty service which includes Amazon AppFlow and Amazon Connect</p> <ul style="list-style-type: none">• <code>profile:PutProfileObject</code> - Allows you to create and update objects• <code>profile:PutProfileObjectType</code> - Allows you to create and update object types• <code>profile:SearchProfiles</code> - Allows you to search profiles• <code>profile:TagResource</code> - Allows you to tag resources• <code>profile:UntagResource</code> - Allows you to untag resources• <code>profile:UpdateDomain</code> - Allows you to update domains• <code>profile:UpdateProfile</code> - Allows you to update profiles	

Change	Description	Date
<p>AmazonConnectServiceLinkedRolePolicy – Added actions for Amazon Connect Customer Profiles</p>	<p>Added the following actions so Amazon Connect flows and the agent experience can interact with the profiles in your default Customer Profiles domain:</p> <ul style="list-style-type: none">• <code>profile:SearchProfiles</code>• <code>profile:CreateProfile</code>• <code>profile:UpdateProfile</code>• <code>profile:AddProfileKey</code> <p>Added the following action so Amazon Connect flows and the agent experience can interact with the profile objects in your default Customer Profiles domain:</p> <ul style="list-style-type: none">• <code>profile:ListProfileObjects</code> <p>Added the following action so Amazon Connect flows and the agent experience can determine whether Customer Profiles is enabled for your Amazon Connect instance:</p>	<p>November 12, 2021</p>

Change	Description	Date
	<ul style="list-style-type: none"> • <code>profile:ListAccountIntegrations</code> 	
AmazonConnectVoiceIDFullAccess – Added new AWS managed policy	<p>Added a new AWS managed policy so you can set up your users to use Amazon Connect Voice ID.</p> <p>This policy provides full access to Amazon Connect Voice ID through the AWS console, SDK, or other means.</p>	September 27, 2021
AmazonConnectCampaignsServiceLinkedRolePolicy – Added new service-linked role policy	<p>Added a new service-linked role policy for outbound campaigns.</p> <p>The policy provides access to retrieve all the outbound campaigns.</p>	September 27, 2021
AmazonConnectServiceLinkedRolePolicy – Added actions for Amazon Lex	<p>Added the following actions for the all bots created in the account across all Regions. These actions were added to support integration with Amazon Lex.</p> <ul style="list-style-type: none"> • <code>lex:ListBots</code> - Lists all the bots available in a given Region for your account. • <code>lex:ListBotAliases</code> - Lists all the aliases for a given bot. 	June 15, 2021

Change	Description	Date
AmazonConnect_FullAccess – Added actions for Amazon Lex	Added the following actions for the all bots created in the account across all Regions. These actions were added to support integration with Amazon Lex. <ul style="list-style-type: none"> • <code>lex:ListBots</code> • <code>lex:ListBotAliases</code> 	June 15, 2021
Amazon Connect started tracking changes	Amazon Connect started tracking changes for its AWS managed policies.	June 15, 2021

Troubleshooting Amazon Connect identity and access

Use the following information to help you diagnose and fix common issues that you might encounter when working with Amazon Connect and IAM.

Topics

- [I am not authorized to perform iam:PassRole](#)
- [I want to allow people outside of my AWS account to access my Amazon Connect resources](#)

I am not authorized to perform iam:PassRole

If you receive an error that you're not authorized to perform the `iam:PassRole` action, your policies must be updated to allow you to pass a role to Amazon Connect.

Some AWS services allow you to pass an existing role to that service instead of creating a new service role or service-linked role. To do this, you must have permissions to pass the role to the service.

The following example error occurs when an IAM user named `marymajor` tries to use the console to perform an action in Amazon Connect. However, the action requires the service to have

permissions that are granted by a service role. Mary does not have permissions to pass the role to the service.

```
User: arn:aws:iam::123456789012:user/marymajor is not authorized to perform:
iam:PassRole
```

In this case, Mary's policies must be updated to allow her to perform the `iam:PassRole` action.

If you need help, contact your AWS administrator. Your administrator is the person who provided you with your sign-in credentials.

I want to allow people outside of my AWS account to access my Amazon Connect resources

You can create a role that users in other accounts or people outside of your organization can use to access your resources. You can specify who is trusted to assume the role. For services that support resource-based policies or access control lists (ACLs), you can use those policies to grant people access to your resources.

To learn more, consult the following:

- To learn whether Amazon Connect supports these features, see [How Amazon Connect works with IAM](#).
- To learn how to provide access to your resources across AWS accounts that you own, see [Providing access to an IAM user in another AWS account that you own](#) in the *IAM User Guide*.
- To learn how to provide access to your resources to third-party AWS accounts, see [Providing access to AWS accounts owned by third parties](#) in the *IAM User Guide*.
- To learn how to provide access through identity federation, see [Providing access to externally authenticated users \(identity federation\)](#) in the *IAM User Guide*.
- To learn the difference between using roles and resource-based policies for cross-account access, see [Cross account resource access in IAM](#) in the *IAM User Guide*.

Use service-linked roles for Amazon Connect

What are service-linked roles (SLR) and why are they important?

Amazon Connect uses AWS Identity and Access Management (IAM) [service-linked roles](#). A service-linked role is a unique type of IAM role that is linked directly to an Amazon Connect instance.

Service-linked roles are predefined by Amazon Connect and include [all the permissions](#) that Amazon Connect requires to call other AWS services on your behalf.

You need to enable service-linked roles so you can use new features in Amazon Connect, such as tagging support, the new user interface in **User management** and **Routing profiles**, and queues with CloudTrail support.

For information about other services that support service-linked roles, see [AWS services that work with IAM](#) and look for the services that have **Yes** in the **Service-Linked Role** column. Choose a **Yes** with a link to view the service-linked role documentation for that service.

Service-linked role permissions for Amazon Connect

Amazon Connect uses the service-linked role with the prefix

AWSServiceRoleForAmazonConnect_*unique-id* – Grants Amazon Connect permission to access AWS resources on your behalf.

The AWSServiceRoleForAmazonConnect prefixed service-linked role trusts the following services to assume the role:

- `connect.amazonaws.com`

The [AmazonConnectServiceLinkedRolePolicy](#) role permissions policy allows Amazon Connect to complete the following actions on the specified resources:

- Action: all Amazon Connect actions, `connect:*`, on all Amazon Connect resources.
- Action: IAM `iam:DeleteRole` to allow deletion of the service-linked role.
- Action: Amazon S3 `s3:GetObject`, `s3:DeleteObject`, `s3:GetBucketLocation`, and `GetBucketAcl` for the S3 bucket specified for recorded conversations.

It also grants `s3:PutObject`, `s3:PutObjectAcl`, and `s3:GetObjectAcl` to the bucket specified for exported reports.

- Action: Amazon CloudWatch Logs `logs:CreateLogStream`, `logs:DescribeLogStreams`, and `logs:PutLogEvents` to the CloudWatch Logs group specified for flow logging.
- Action: Amazon Lex `lex:ListBots`, `lex:ListBotAliases` for all bots created in the account across all Regions.
- Action: Amazon Connect Customer Profiles
 - `profile:SearchProfiles`

- `profile:CreateProfile`
- `profile:UpdateProfile`
- `profile:AddProfileKey`
- `profile:ListProfileObjects`
- `profile:ListAccountIntegrations`
- `profile:ListProfileObjectTypeTemplates`
- `profile:GetProfileObjectTypeTemplate`
- `profile:ListProfileObjectTypes`
- `profile:GetProfileObjectType`
- `profile:ListCalculatedAttributeDefinitions`
- `profile:GetCalculatedAttributeForProfile`
- `profile:ListCalculatedAttributesForProfile`
- `profile:GetDomain`
- `profile:ListIntegrations`
- `profile:CreateCalculatedAttributeDefinition`
- `profile>DeleteCalculatedAttributeDefinition`
- `profile:GetCalculatedAttributeDefinition`
- `profile:UpdateCalculatedAttributeDefinition`
- `profile:PutProfileObject`

to use your default Customer Profiles domain (including profiles and all object-types in domain) with the Amazon Connect flows and agent experience applications.

- Action: Amazon Connect Amazon Q in Connect
 - `wisdom:CreateContent`
 - `wisdom>DeleteContent`
 - `wisdom:CreateKnowledgeBase`
 - `wisdom:GetAssistant`
 - `wisdom:GetKnowledgeBase`
 - `wisdom:GetContent`
 - `wisdom:GetRecommendations`
 - `wisdom:GetSession`

- `wisdom:NotifyRecommendationsReceived`
- `wisdom:QueryAssistant`
- `wisdom:StartContentUpload`
- `wisdom:UntagResource`
- `wisdom:TagResource`
- `wisdom:CreateSession`
- `wisdom:CreateQuickResponse`
- `wisdom:GetQuickResponse`
- `wisdom:SearchQuickResponses`
- `wisdom:StartImportJob`
- `wisdom:GetImportJob`
- `wisdom>ListImportJobs`
- `wisdom>ListQuickResponses`
- `wisdom:UpdateQuickResponse`
- `wisdom>DeleteQuickResponse`
- `wisdom:PutFeedback`
- `wisdom>ListContentAssociations`

with resource tag `'AmazonConnectEnabled': 'True'` on all Amazon Connect Amazon Q in Connect resources associated with your Amazon Connect instance.

- `wisdom>ListAssistants`
- `wisdom:KnowledgeBases`

on all Amazon Connect Amazon Q in Connect resources.

- Action: Amazon CloudWatch Metrics `cloudwatch:PutMetricData` to publish Amazon Connect usage metrics for an instance to your account.
- Action: Amazon Pinpoint `sms:DescribePhoneNumbers` and `sms:SendTextMessage` to allow Amazon Connect to send SMS.
- Action: Amazon Cognito user pools `cognito-idp:DescribeUserPool` and `cognito-idp>ListUserPoolClients` to allow Amazon Connect access to select read operations on Amazon Cognito user pools resources that have an `AmazonConnectEnabled` resource tag.

As you enable additional features in Amazon Connect, the following permissions are added for the service-linked role to access the resources associated with those features by using in-line policies:

- Action: Amazon Data Firehose `firehose:DescribeDeliveryStream` and `firehose:PutRecord`, and `firehose:PutRecordBatch` for the delivery stream defined for agent event streams and contact records.
- Action: Amazon Kinesis Data Streams `kinesis:PutRecord`, `kinesis:PutRecords`, and `kinesis:DescribeStream` for the stream specified for agent event streams and contact records.
- Action: Amazon Lex `lex:PostContent` for the bots added to your instance.
- Action: Amazon Connect Voice-ID `voiceid:*` for the Voice ID domains associated with your instance.
- Action: EventBridge `events:PutRule` and `events:PutTargets` for the Amazon Connect managed EventBridge rule for publishing CTR records for your associated Voice ID domains.
- Action: outbound campaigns
 - `connect-campaigns:CreateCampaign`
 - `connect-campaigns>DeleteCampaign`
 - `connect-campaigns:DescribeCampaign`
 - `connect-campaigns:UpdateCampaignName`
 - `connect-campaigns:GetCampaignState`
 - `connect-campaigns:GetCampaignStateBatch`
 - `connect-campaigns:ListCampaigns`
 - `connect-campaigns:UpdateOutboundCallConfig`
 - `connect-campaigns:UpdateDialerConfig`
 - `connect-campaigns:PauseCampaign`
 - `connect-campaigns:ResumeCampaign`
 - `connect-campaigns:StopCampaign`

for all operations related to outbound campaigns.

You must configure permissions to allow an IAM entity (such as a user, group, or role) to create, edit, or delete a service-linked role. For more information, see [Service-linked role permissions](#) in

[the IAM User Guide](#).

Create a service-linked role for Amazon Connect

You don't need to manually create a service-linked role. When you create a new instance in Amazon Connect in the AWS Management Console, Amazon Connect creates the service-linked role for you.

If you delete this service-linked role, and then need to create it again, you can use the same process to recreate the role in your account. When you create a new instance in Amazon Connect, Amazon Connect creates the service-linked role for you again.

You can also use the IAM console to create a service-linked role with the **Amazon Connect - Full access** use case. In the IAM CLI or the IAM API, create a service-linked role with the `connect.amazonaws.com` service name. For more information, see [Creating a service-linked role](#) in the *IAM User Guide*. If you delete this service-linked role, you can use this same process to create the role again.

For instances created before October 2018

Tip

Having trouble signing in to manage your AWS account? Don't know who manages your AWS account? For help, see [Troubleshooting AWS account sign-in issues](#).

If your Amazon Connect instance was created before October 2018, you don't have service-linked roles set up. To create a service-linked role, on the **Account overview** page, choose **Create service-linked role**, as shown in the following image.

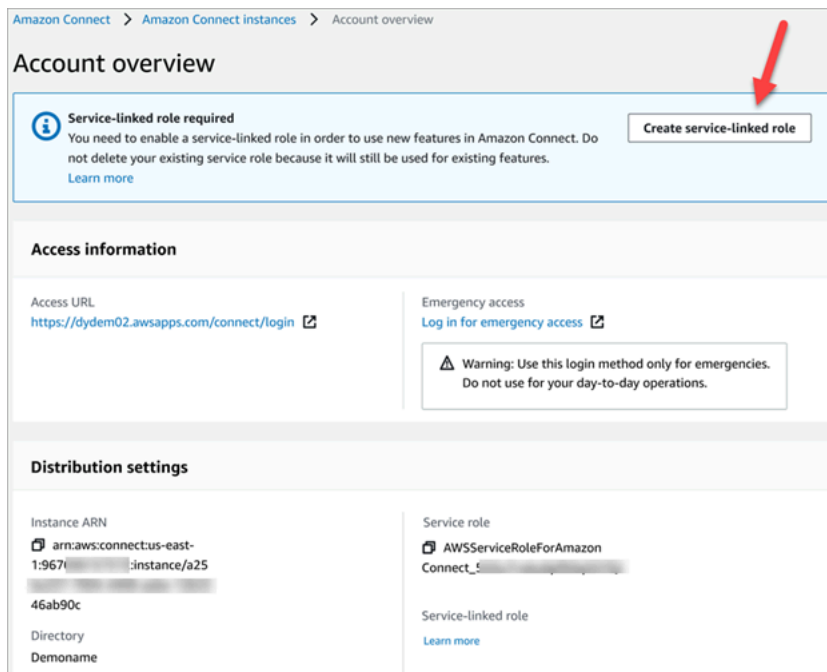

For a list of the IAM permissions required to create the service-linked role, see [Overview page](#) in the [Required permissions for using custom IAM policies to manage access to the Amazon Connect admin website](#) topic.

Edit a service-linked role for Amazon Connect

Amazon Connect does not allow you to edit the `AWSServiceRoleForAmazonConnect` prefixed service-linked role. After you create a service-linked role, you cannot change the name of the role because various entities might reference the role. However, you can edit the description of the role using IAM. For more information, see [Editing a service-linked role](#) in the *IAM User Guide*.

Checking a service-linked role has permissions for Amazon Lex

1. On the navigation pane of the IAM console, choose **Roles**.
2. Choose the name of the role to modify.

Delete a service-linked role for Amazon Connect

You don't need to manually delete the `AWSServiceRoleForAmazonConnect` prefixed role. When you delete your Amazon Connect instance in the AWS Management Console, Amazon Connect cleans up the resources and deletes the service-linked role for you.

Supported Regions for Amazon Connect service-linked roles

Amazon Connect supports using service-linked roles in all of the regions where the service is available. For more information, see [AWS Regions and Endpoints](#).

Use service-linked roles for outbound campaigns

Amazon Connect outbound campaigns uses AWS Identity and Access Management service-linked roles. When an Amazon Connect instance is enabled to use outbound campaigns, it creates a unique service linked role that allows it to perform actions on the Amazon Connect instance.

A service-linked role makes setting up outbound campaigns easier because you don't have to manually add the necessary permissions. Outbound campaigns defines the permissions of its service-linked roles, and unless defined otherwise, only outbound campaigns can assume its roles. The defined permissions include the trust policy and the permissions policy, and that permissions policy cannot be attached to any other IAM entity.

For information about other services that support service-linked roles, see [AWS services that work with IAM](#) in the *IAM User Guide*. Look for the services that have **Yes** in the **Service-Linked Role** column. Choose a **Yes** with a link to view the service-linked role documentation for that service.

Service-linked role permissions for outbound campaigns

Outbound campaigns uses the service-linked role prefixed `AWSServiceRoleForConnectCampaigns`—Grants outbound campaigns permission to access AWS resources on your behalf.

The `AWSServiceRoleForConnectCampaigns` service-linked role trusts the following services to assume the role:

- `connect-campaigns.amazonaws.com`

The [AmazonConnectCampaignsServiceLinkedRolePolicy](#) role permissions policy allows outbound campaigns to complete the following actions on the specified resources. Additional permissions are added for the service-linked role to access the resources:

- Action: Outbound campaigns `connect-campaigns:ListCampaigns` for the AWS account.
- Action: Amazon Connect `connect:BatchPutContact` and `connect:StopContact` for all Amazon Connect instances.

- Action: Amazon Connect `connect:StartOutboundVoiceContact`, `connect:GetMetricData` and `connect:GetCurrentMetricData` for the Amazon Connect instance specified.

You must configure permissions to allow an IAM entity (such as a user, group, or role) to create, edit, or delete a service-linked role. For more information, see [Service-linked role permissions](#) in the *IAM User Guide*.

Create a service-linked role for outbound campaigns

You don't need to manually create a service-linked role. When you associate an Amazon Connect instance with outbound campaigns by invoking the `StartInstanceOnboardingJob` API, outbound campaigns creates the service-linked role for you.

If you delete this service-linked role, and then need to create it again, you can use the same process to recreate the role in your account. When you associate a new Amazon Connect instance with outbound campaigns, Amazon Connect creates the service-linked role for you again.

Edit a service-linked role for outbound campaigns

Outbound campaigns does not allow you to edit the `AWSServiceRoleForConnectCampaigns` service-linked role. After you create a service-linked role, you cannot change the name of the role because various entities might reference the role. However, you can edit the description of the role using IAM. For more information, see [Editing a service-linked role](#) in the *IAM User Guide*.

Delete a service-linked role for outbound campaigns

If you no longer need outbound campaigns, we recommend that you delete the associated service-linked role. That way you don't have an unused entity that is not actively monitored or maintained. However, you must clean up the resources for your service-linked role before you can manually delete it.

To delete outbound campaigns resources used by the `AWSServiceRoleForConnectCampaigns`

- Delete all campaigns setup for the AWS account.

To manually delete the service-linked role using IAM

- Use the IAM console, the AWS CLI, or the AWS API to delete the `AWSServiceRoleForConnectCampaigns` service-linked role. For more information, see [Deleting a service-linked role](#) in the *IAM User Guide*.

Supported Regions for outbound campaigns service-linked roles

Outbound campaigns supports using service-linked roles in all of the Regions where the service is available. For more information, see [AWS Regions and Endpoints](#).

Using service-linked roles for Amazon AppIntegrations

Amazon AppIntegrations uses AWS Identity and Access Management (IAM) [service-linked roles](#). A service-linked role is a unique type of IAM role that is linked directly to Amazon AppIntegrations. Service-linked roles are predefined by Amazon AppIntegrations and include all the permissions that the service requires to call other AWS services on your behalf.

A service-linked role makes setting up Amazon AppIntegrations easier because you don't have to manually add the necessary permissions. Amazon AppIntegrations defines the permissions of its service-linked roles, and unless defined otherwise, only Amazon AppIntegrations can assume its roles. The defined permissions include the trust policy and the permissions policy, and that permissions policy cannot be attached to any other IAM entity.

You can delete a service-linked role only after first deleting their related resources. This protects your Amazon AppIntegrations resources because you can't inadvertently remove permission to access the resources.

For information about other services that support service-linked roles, see [AWS Services That Work with IAM](#) and look for the services that have **Yes** in the **Service-linked roles** column. Choose a **Yes** with a link to view the service-linked role documentation for that service.

Service-linked role permissions for Amazon AppIntegrations

Amazon AppIntegrations uses the service-linked role named `AWSServiceRoleForAppIntegrations` which allows AppIntegrations to access AWS services and resources on your behalf.

The `AWSServiceRoleForAppIntegrations` service-linked role trusts the following service to assume the role:

- `app-integrations.amazonaws.com`

The role permissions policy named `AppIntegrationsServiceLinkedRolePolicy` allows Amazon AppIntegrations to complete the following actions on the specified resources:

```
{
  "Version": "2012-10-17",
  "Statement": [
    {
      "Effect": "Allow",
      "Action": [
        "cloudwatch:PutMetricData"
      ],
      "Resource": "*",
      "Condition": {
        "StringEquals": {
          "cloudwatch:namespace": "AWS/AppIntegrations"
        }
      }
    },
    {
      "Effect": "Allow",
      "Action": [
        "appflow:DescribeConnectorEntity",
        "appflow:ListConnectorEntities"
      ],
      "Resource": "*"
    },
    {
      "Effect": "Allow",
      "Action": [
        "appflow:DescribeConnectorProfiles",
        "appflow:UseConnectorProfile"
      ],
      "Resource": "arn:aws:appflow:*:*:connector-profile/*"
    },
    {
      "Effect": "Allow",
      "Action": [
        "appflow>DeleteFlow",
        "appflow:DescribeFlow",
        "appflow:DescribeFlowExecutionRecords",
```

```

        "appflow:StartFlow",
        "appflow:StopFlow",
        "appflow:UpdateFlow"
    ],
    "Condition": {
        "StringEquals": {
            "aws:ResourceTag/AppIntegrationsManaged": "true"
        }
    },
    "Resource": "arn:aws:appflow:*:*:flow/FlowCreatedByAppIntegrations-*"
},
{
    "Effect": "Allow",
    "Action": [
        "appflow:TagResource"
    ],
    "Condition": {
        "ForAllValues:StringEquals": {
            "aws:TagKeys": [
                "AppIntegrationsManaged"
            ]
        }
    },
    "Resource": "arn:aws:appflow:*:*:flow/FlowCreatedByAppIntegrations-*"
}
]
}

```

- Action: `cloudwatch:PutMetricData` on "*" using the `StringEquals` condition `"cloudwatch:namespace": "AWS/AppIntegrations"`.
- Action: `appflow:DescribeConnectorEntity` and `appflow:ListConnectorEntities` on "*".
- Action: `appflow:DescribeConnectorProfiles` and `appflow:UseConnectorProfile` on `arn:aws:appflow:*:*:connector-profile/*`
- Action: `appflow>DeleteFlow`, `appflow:DescribeFlow`, `appflow:DescribeFlowExecutionRecords`, `appflow:StartFlow`, `appflow:StopFlow`, and `appflow:UpdateFlow` on `arn:aws:appflow:*:*:flow/FlowCreatedByAppIntegrations-*` using the `StringEquals` condition `"aws:ResourceTag/AppIntegrationsManaged": "true"`.

- Action: `appflow:TagResource` on `arn:aws:appflow:*:*:flow/FlowCreatedByAppIntegrations-*` using the `ForAllValues:StringEquals` `aws:TagKeys` condition `AppIntegrationsManaged`.

You must configure permissions to allow an IAM entity (such as a user, group, or role) to create, edit, or delete a service-linked role. For more information, see [Service-linked role permissions](#) in the *IAM User Guide*.

Creating a service-linked role for Amazon AppIntegrations

You don't need to manually create a service-linked role. When you create a data or event integration using either the Amazon Q in Connect, Customer Profiles, or Tasks widget in Amazon Connect in the AWS Management Console, the AWS CLI, or the AWS API, Amazon AppIntegrations creates the service-linked role for you.

Important

This service-linked role can appear in your account if you completed an action in another service that uses the features supported by this role. Also, if you created any new Amazon AppIntegrations resources after September 30, 2022, when it began supporting service-linked roles, then Amazon AppIntegrations created the `AWSServiceRoleForAppIntegrations` role in your account. To learn more, see [A new role appeared in my IAM account](#).

If you delete this service-linked role, and then need to create it again, you can use the same process to recreate the role in your account. When you create a data or event integration using either the Amazon Q in Connect, Customer Profiles, or Tasks widget in Amazon Connect, Amazon AppIntegrations creates the service-linked role for you again.

You can also use the IAM console to create a service-linked role with the **AppIntegrations** use case. In the AWS CLI or the AWS API, create a service-linked role with the `app-integrations.amazonaws.com` service name. For more information, see [Creating a service-linked role](#) in the *IAM User Guide*. If you delete this service-linked role, you can use this same process to create the role again.

Editing a service-linked role for Amazon AppIntegrations

Amazon AppIntegrations does not allow you to edit the `AWSServiceRoleForAppIntegrations` service-linked role. After you create a service-linked role, you cannot change the name of the role

because various entities might reference the role. However, you can edit the description of the role using IAM. For more information, see [Editing a service-linked role](#) in the *IAM User Guide*.

Deleting a service-linked role for Amazon AppIntegrations

If you no longer need to use a feature or service that requires a service-linked role, we recommend that you delete that role. That way you don't have an unused entity that is not actively monitored or maintained. However, you must clean up the resources for your service-linked role before you can manually delete it. You must first delete your data and event integration associations in the AWS Console and then delete your data and event integrations using the AWS CLI.

Note

If the Amazon AppIntegrations service is using the role when you try to delete the resources, then the deletion might fail. If that happens, wait for a few minutes and try the operation again.

To delete data integration associations used by the `AWSServiceRoleForAppIntegrations` in the AWS Console

1. Go to the Amazon Q in Connect section of the Amazon Connect Console and choose the name of the data integration association that you wish to delete.
2. Choose **Delete** on the right hand side of the **Integration details** section.
3. In the pop-box, enter the name of the integration for confirmation and choose **Delete**.

To delete data integrations used by the `AWSServiceRoleForAppIntegrations` using the AWS CLI

1. List your data integrations in order to view the names of your existing integrations.

```
aws appintegrations list-data-integrations
```

2. Delete each integration using the data integration name.

```
aws appintegrations delete-data-integration --data-integration-  
identifier DATA_INTEGRATION_NAME
```

To delete event integration associations used by the AWSServiceRoleForAppIntegrations in the AWS Console

1. Go to the Customer Profiles or the Tasks section of the Amazon Connect Console and choose the name of the event integration association that you wish to delete.
2. Once you choose an event integration on the Tasks section, a pop-up will appear. Choose the **Remove connection** button and enter the word *remove* to delete your event integration association.

To delete event integrations used by the AWSServiceRoleForAppIntegrations using the AWS CLI

1. List your event integrations in order to view the names of your existing integrations.

```
aws appintegrations list-event-integrations
```

2. Delete each integration using the data integration name.

```
aws appintegrations delete-event-integration --name
EVENT_INTEGRATION_NAME
```

To manually delete the service-linked role using IAM

Use the IAM console, the AWS CLI, or the AWS API to delete the AWSServiceRoleForAppIntegrations service-linked role. For more information, see [Deleting a service-linked role](#) in the *IAM User Guide*.

Supported regions for Amazon AppIntegrations service-linked roles

Amazon AppIntegrations supports using service-linked roles in all of the regions where the service is available. For more information, see [AWS regions and endpoints](#).

You can use the AWSServiceRoleForAppIntegrations role in the following regions.

Region name	Region identity	Support in Amazon AppIntegrations
US East (N. Virginia)	us-east-1	Yes
US West (Oregon)	us-west-2	Yes

Region name	Region identity	Support in Amazon AppIntegrations
Asia Pacific (Mumbai)	ap-south-1	Yes
Asia Pacific (Seoul)	ap-northeast-2	Yes
Asia Pacific (Singapore)	ap-southeast-1	Yes
Asia Pacific (Sydney)	ap-southeast-2	Yes
Asia Pacific (Tokyo)	ap-northeast-1	Yes
Canada (Central)	ca-central-1	Yes
Europe (Frankfurt)	eu-central-1	Yes
Europe (London)	eu-west-2	Yes
Africa (Cape Town)	af-south-1	Yes

Using service-linked roles for Amazon Connect Customer Profiles

Amazon Connect Customer Profiles uses AWS Identity and Access Management (IAM) [service-linked roles](#). A service-linked role is a unique type of IAM role that is linked directly to Customer Profiles. Service-linked roles are predefined by Customer Profiles and include all the permissions that the service requires to call other AWS services on your behalf.

A service-linked role makes setting up Amazon Connect Customer Profiles easier because you don't have to manually add the necessary permissions. Amazon Connect Customer Profiles defines the permissions of its service-linked roles, and unless defined otherwise, only Amazon Connect Customer Profiles can assume its roles. The defined permissions include the trust policy and the permissions policy, and that permissions policy cannot be attached to any other IAM entity.

For information about other services that support service-linked roles, see [AWS services that work with IAM](#) and look for the services that have **Yes** in the **Service-linked roles** column. Choose a **Yes** with a link to view the service-linked role documentation for that service.

Service-linked role permissions for Amazon Connect Customer Profiles

Amazon Connect Customer Profiles uses the service-linked role named **AWSServiceRoleForProfile_***unique-id* which allows Amazon Connect Customer Profiles to access AWS services and resources on your behalf..

The **AWSServiceRoleForProfile** prefixed service-linked role trusts the following services to assume the role:

- `profile.amazonaws.com`

The role permissions policy named `CustomerProfilesServiceLinkedRolePolicy` allows Amazon Connect Customer Profiles to complete the following actions on the specified resources:

- Action: Amazon CloudWatch Metrics `cloudwatch:PutMetricData` to publish Amazon Connect usage metrics for an instance to your account.
- Action: IAM `iam:DeleteRole` to delete the **AWSServiceRoleForProfile** prefixed service-linked role itself when associated Amazon Connect Customer Profiles Domain is deleted.

You must configure permissions to allow an IAM entity (such as a user, group, or role) to create, edit, or delete a service-linked role. For more information, see [Service-linked role permissions](#) in the *IAM User Guide*.

Creating a service-linked role for Amazon Connect Customer Profiles

You don't need to manually create a service-linked role. When you create your first Amazon Connect Customer Profiles Domain in the AWS Management Console, the AWS CLI, or the AWS API, Customer Profiles creates the service-linked role for you. Note each Amazon Connect Customer Profiles domain requires a dedicated SLR in order for Amazon Connect Customer Profiles to take actions for you.

Important

This service-linked role can appear in your account if you completed an action in another service that uses the features supported by this role. Also, if you were using the Amazon Connect Customer Profiles service before June 8, 2023, when it began supporting service-linked roles, then Amazon Connect Customer Profiles created the

AWSServiceRoleForProfile prefixed role in your account. To learn more, see [A new role appeared in my IAM account](#).

If you delete this service-linked role, and then need to create it again, you can use the same process to recreate the role in your account. When you create your first Amazon Connect Customer Profiles Domain, Customer Profiles creates the service-linked role for you again.

Editing a service-linked role for Amazon Connect Customer Profiles

Amazon Connect Customer Profiles does not allow you to edit the **AWSServiceRoleForProfile** prefixed service-linked role. After you create a service-linked role, you cannot change the name of the role because various entities might reference the role. However, you can edit the description of the role using IAM. For more information, see [Editing a service-linked role](#) in the *IAM User Guide*.

Deleting a service-linked role for Amazon Connect Customer Profiles

You don't need to manually delete the **AWSServiceRoleForProfile** prefixed role. When you delete the Amazon Connect Customer Profiles Domain in the AWS Management Console, the AWS CLI, or the AWS API, Customer Profiles cleans up the resources and deletes the service-linked role for you.

You can also use the AWS CLI or the AWS API to manually delete the service-linked role. To do this, you must first manually clean up the resources for your service-linked role and then you can manually delete it.

Note

If the Amazon Connect Customer Profiles service is using the role when you try to delete the resources, then the deletion might fail. If that happens, wait for a few minutes and try the operation again.

To delete Amazon Connect Customer Profiles resources used by the AWSServiceRoleForProfile prefixed service-linked role

- Delete the Amazon Connect Customer Profiles domain in the AWS Management Console, the AWS CLI, or the AWS API.

To manually delete the service-linked role using IAM

Use the AWS CLI or the AWS API to delete the **AWSServiceRoleForProfile** prefixed service-linked role. For more information, see [Deleting a service-linked role](#) in the *IAM User Guide*.

Supported regions for Amazon Connect Customer Profiles service-linked roles

Amazon Connect Customer Profiles supports using service-linked roles in all of the regions where the service is available. For more information, see [AWS regions and endpoints](#).

Region name	Region identity	Support in Amazon Connect
US East (N. Virginia)	us-east-1	Yes
US West (Oregon)	us-west-2	Yes
Asia Pacific (Seoul)	ap-northeast-2	Yes
Asia Pacific (Singapore)	ap-southeast-1	Yes
Asia Pacific (Sydney)	ap-southeast-2	Yes
Asia Pacific (Tokyo)	ap-northeast-1	Yes
Canada (Central)	ca-central-1	Yes
Europe (Frankfurt)	eu-central-1	Yes
Europe (London)	eu-west-2	Yes
Africa (Cape Town)	af-south-1	Yes

Using service-linked roles for Amazon Connect Managed Synchronization

Amazon Connect managed synchronization uses AWS Identity and Access Management (IAM) [service-linked roles](#). A service-linked role is a unique type of IAM role that is linked directly to Managed Synchronization. Service-linked roles are predefined by Managed Synchronization and include all the permissions that the service requires to call other AWS services on your behalf.

A service-linked role makes setting up Managed Synchronization easier because you don't have to manually add the necessary permissions. Managed Synchronization defines the permissions of its service-linked roles, and unless defined otherwise, only Managed Synchronization can assume its roles. The defined permissions include the trust policy and the permissions policy, and that permissions policy cannot be attached to any other IAM entity.

You can delete a service-linked role only after first deleting their related resources. This protects your Managed Synchronization resources because you can't inadvertently remove permission to access the resources.

For information about other services that support service-linked roles, see [AWS services that work with IAM](#) and look for the services that have **Yes** in the **Service-linked roles** column. Choose a **Yes** with a link to view the service-linked role documentation for that service.

Service-linked role permissions for Managed Synchronization

Managed Synchronization uses the service-linked role that is prefixed with **AWSServiceRoleForAmazonConnectSynchronization** which grants Amazon Connect Managed Synchronization read, write, update, and delete permission to access AWS resources on your behalf. The full name of the role in your account will contain the prefix and a unique ID that will be similar to the following:

AWSServiceRoleForAmazonConnectSynchronization_*unique-id*

The **AWSServiceRoleForAmazonConnectSynchronization** prefixed service-linked role trusts the following services to assume the role:

- `synchronization.connect.amazonaws.com`

The role permissions policy named [AmazonConnectSynchronizationServiceRolePolicy](#) allows Managed Synchronization to complete the following actions on the specified resources:

- Action: Amazon Connect for all Amazon Connect resources
 - `connect:DescribeUser*`
 - `connect:ListUser*`
 - `connect:CreateUser*`
 - `connect>DeleteUser*`
 - `connect:UpdateUser*`

- `connect:Associate*`
- `connect:Disassociate*`
- `connect:DescribePredefinedAttribute`
- `connect:ListPredefinedAttributes`
- `connect:CreatePredefinedAttribute`
- `connect>DeletePredefinedAttribute`
- `connect:UpdatePredefinedAttribute`
- `connect:BatchGetFlowAssociation`
- `connect:DescribePhoneNumber`
- `connect:UpdatePhoneNumber`
- `connect:ListPhoneNumbersV2`
- `connect:ListTrafficDistributionGroups`
- `connect:DescribeRoutingProfile`
- `connect:ListRoutingProfile*`
- `connect:CreateRoutingProfile`
- `connect>DeleteRoutingProfile`
- `connect:UpdateRoutingProfile*`
- `connect:CreateAgentStatus`
- `connect:DescribeAgentStatus`
- `connect:ListAgentStatuses`
- `connect:UpdateAgentStatus`
- `connect:CreateQuickConnect`
- `connect>DeleteQuickConnect`
- `connect:DescribeQuickConnect`
- `connect:ListQuickConnects`
- `connect:UpdateQuickConnect*`
- `connect:CreateHoursOfOperation`
- `connect>DeleteHoursOfOperation`
- `connect:DescribeHoursOfOperation`
- `connect:ListHoursOfOperations`

- `connect:UpdateHoursOfOperation`
- `connect:DescribeQueue`
- `connect:ListQueue*`
- `connect:CreateQueue`
- `connect>DeleteQueue`
- `connect:UpdateQueue*`
- `connect:CreatePrompt`
- `connect:ListPrompts`
- `connect:UpdatePrompt`
- `connect>DeletePrompt`
- `connect:DescribePrompt`
- `connect:GetPromptFile`
- `connect:CreateSecurityProfile`
- `connect>DeleteSecurityProfile`
- `connect:DescribeSecurityProfile`
- `connect:ListSecurityProfile*`
- `connect:UpdateSecurityProfile`
- `connect:CreateContactFlow*`
- `connect>DeleteContactFlow*`
- `connect:DescribeContactFlow*`
- `connect:ListContactFlow*`
- `connect:UpdateContactFlow*`
- `connect:ListTagsForResource`
- `connect:TagResource`
- `connect:UntagResource`
- Action: Amazon CloudWatch metrics `cloudwatch:PutMetricData` to publish Amazon Connect usage metrics for an instance to your account.

You must configure permissions to allow your users, groups, or roles to create, edit, or delete a

service-linked role. For more information, see [Service-linked role permissions](#) in the *IAM User Guide*.

Creating a service-linked role for Managed Synchronization

You don't need to manually create a service-linked role. When you replicate an Amazon Connect instance by invoking the `ReplicateInstance` API, Managed Synchronization creates the service-linked role for you.

If you delete this service-linked role, and then need to create it again, you can use the same process to recreate the role in your account. When you replicate the Amazon Connect instance again, Managed Synchronization creates the service-linked role for you again.

Editing a service-linked role for Managed Synchronization

Managed Synchronization does not allow you to edit the `AWSServiceRoleForAmazonConnectSynchronization` prefixed service-linked role. After you create a service-linked role, you cannot change the name of the role because various entities might reference the role. However, you can edit the description of the role using IAM. For more information, see [Editing a service-linked role](#) in the *IAM User Guide*.

Deleting a service-linked role for Managed Synchronization

If you no longer need to use a feature or service that requires a service-linked role, we recommend that you delete that role. That way you don't have an unused entity that is not actively monitored or maintained. However, you must clean up the resources for your service-linked role before you can manually delete it.

Note

If the Managed Synchronization service is using the role when you try to delete the resources, then the deletion might fail. If that happens, wait for a few minutes and try the operation again.

To delete Managed Synchronization resources used by the `AWSServiceRoleForAmazonConnectSynchronization` prefixed role

- Delete all replica Amazon Connect instances for the source instance.

To manually delete the service-linked role using IAM

Use the IAM console, the AWS CLI, or the AWS API to delete the `AWSServiceRoleForAmazonConnectSynchronization` prefixed service-linked role. For more information, see [Deleting a service-linked role](#) in the *IAM User Guide*.

Supported Regions for Managed Synchronization service-linked roles

Managed Synchronization supports using service-linked roles in all of the Regions where Amazon Connect Global Resiliency is available. For more information, see [Set up Amazon Connect Global Resiliency](#).

Region name	Region identity	Support in Managed Synchronization
US East (N. Virginia)	us-east-1	Yes
US West (Oregon)	us-west-2	Yes

Logging and monitoring Amazon Connect

Monitoring is important for maintaining the reliability, availability, and performance of your contact center.

You should collect monitoring data from all of the parts of your AWS solution so that you can more easily debug a multipoint failure if one occurs. But before you start monitoring Amazon Connect, you should create a monitoring plan that includes answers to the following questions:

- What are your monitoring goals?
- What data about your Amazon Connect instance will you monitor?
- How often will you monitor your instance?
- What monitoring tools will you use?
- Who will perform the monitoring tasks?
- Who should be notified when something goes wrong?

See the following topics to learn how to use Amazon CloudWatch Logs and AWS CloudTrail to monitor Amazon Connect and describes the Amazon Connect metrics sent to CloudWatch:

- [Monitoring your instance using CloudWatch](#)
- [Logging Amazon Connect API calls with AWS CloudTrail](#)

Tag resources in Amazon Connect

A *tag* is a custom metadata label that you can add to a resource in order to make it easier to identify, organize, and find in a search. Tags are comprised of two individual parts: A tag key and a tag value. This is referred to as a key:value pair.

A *tag key* typically represents a larger category, while a tag value represents a subset of that category. For example you could have *tag key=Color* and *tag value=Blue*, which would produce the key:value pair `Color:Blue`. Note that you can set the value of a tag to an empty string, but you can't set the value of a tag to null. Omitting the tag value is the same as using an empty string.

Tag keys can be up to 128 characters in length and tag values can be up to 256 characters in length; both are case sensitive. For more information, see:

- [Amazon Connect TagResource](#)
- [Amazon Connect Customer Profiles TagResource](#)
- [Amazon Connect Voice ID TagResource](#): You can add tags to the Voice ID domain.
- [Amazon AppIntegrations TagResource](#)

Amazon Connect services support up to 50 tags per resource. For a given resource, each tag key must be unique with only one value.

Note

Your tags cannot begin with `aws :` because AWS reserves this prefix for system-generated tags. You cannot add, modify, or delete `aws : *` tags, and they don't count against your tags-per-resource limit.

The following table describes the Amazon Connect resources that can be tagged using the AWS CLI or an AWS SDK.

Tagging support for Amazon Connect resources

Resource	Supports tagging using the Amazon Connect console	Supports tagging using the CLI/SDK	Supports tagging on creation
Agent	Yes	Yes	Yes
Agent group	No	Yes	Yes
Agent group level	No	No	Yes
Agent state	No	Yes	Yes
Contact	No	No	No
Contact evaluations	No	Yes	No
Evaluation forms	No	Yes	No
Flow	Yes	Yes	Yes
Flow module	Yes	Yes	Yes
Hours of operation	Yes	Yes	Yes
Instance	Yes	Yes	Yes
Integration association	No	Yes	Yes
Outbound campaign	No	Yes	Yes
Phone number	No	Yes	Yes
Prompts	Yes	Yes	Yes
Queue agent	No	No	Yes
Queues	Yes	Yes	Yes
Quick connects	No	Yes	Yes

Resource	Supports tagging using the Amazon Connect console	Supports tagging using the CLI/SDK	Supports tagging on creation
Routing Profile	Yes	Yes	Yes
Security profile	Yes	Yes	Yes
Task template	No	No	Yes
Traffic distribution group	No	Yes	Yes
Transfer destination	No	Yes	Yes
Use case	No	Yes	Yes
Vocabulary	No	Yes	Yes

To learn more about tagging, including best practices, see [Tagging AWS resources](#) in the *AWS General Reference*.

Tag-based access control

To use tags to control access to resources within your AWS accounts, you need to provide tag information in the condition element of an IAM policy. For example, to control access to your Voice ID domain based on the tags you've assigned to it, use the `aws:ResourceTag/key-name` condition key to specify which tag key:value pair must be attached to the domain, in order to allow given actions for it.

For more detailed information on tag-based access control in the Amazon Connect console, see [Tag-based access control](#).

For more detailed information on tag-based access control in IAM, see [Controlling access to AWS resources using tags](#) in the *IAM User Guide*

Compliance validation in Amazon Connect

To learn whether an AWS service is within the scope of specific compliance programs, see [AWS services in Scope by Compliance Program](#) and choose the compliance program that you are interested in. For general information, see [AWS Compliance Programs](#).

You can download third-party audit reports using AWS Artifact. For more information, see [Downloading Reports in AWS Artifact](#).

Your compliance responsibility when using AWS services is determined by the sensitivity of your data, your company's compliance objectives, and applicable laws and regulations. AWS provides the following resources to help with compliance:

- [Security and Compliance Quick Start Guides](#) – These deployment guides discuss architectural considerations and provide steps for deploying baseline environments on AWS that are security and compliance focused.
- [Architecting for HIPAA Security and Compliance on Amazon Web Services](#) – This whitepaper describes how companies can use AWS to create HIPAA-eligible applications.

Note

Not all AWS services are HIPAA eligible. For more information, see the [HIPAA Eligible Services Reference](#).

- [AWS Compliance Resources](#) – This collection of workbooks and guides might apply to your industry and location.
- [AWS Customer Compliance Guides](#) – Understand the shared responsibility model through the lens of compliance. The guides summarize the best practices for securing AWS services and map the guidance to security controls across multiple frameworks (including National Institute of Standards and Technology (NIST), Payment Card Industry Security Standards Council (PCI), and International Organization for Standardization (ISO)).
- [Evaluating Resources with Rules](#) in the *AWS Config Developer Guide* – The AWS Config service assesses how well your resource configurations comply with internal practices, industry guidelines, and regulations.
- [AWS Security Hub](#) – This AWS service provides a comprehensive view of your security state within AWS. Security Hub uses security controls to evaluate your AWS resources and to check your

compliance against security industry standards and best practices. For a list of supported services and controls, see [Security Hub controls reference](#).

- [Amazon GuardDuty](#) – This AWS service detects potential threats to your AWS accounts, workloads, containers, and data by monitoring your environment for suspicious and malicious activities. GuardDuty can help you address various compliance requirements, like PCI DSS, by meeting intrusion detection requirements mandated by certain compliance frameworks.
- [AWS Audit Manager](#) – This AWS service helps you continuously audit your AWS usage to simplify how you manage risk and compliance with regulations and industry standards.

Best practices for PII compliance in Amazon Connect

Following this list of best practices can help you ensure your Amazon Connect contact center is PII (Personally Identifiable Information) compliant.

- Conduct compliance eligibility audits for all services used in your contact center, as well as any third party integration points.
- AWS Key Management Service (KMS) encrypts Amazon S3 contents at the object level, which covers recordings, logs, and saved reports by default for Amazon S3. Make sure encryption in transit and at rest rules apply downstream or to third party apps.
- Use encryption in the **Store customer input** block for sensitive DTMF information.
- Use your own KMS key when ingesting data in Amazon Connect Customer Profile domains.
- Do not upload content containing customer PII to Amazon Q in Connect.
- When using Amazon Connect Voice ID, do not use PII in the `CustomerSpeakerId`.
- As with any AWS service, we strongly recommend that you not use sensitive information to name resources.
- When using pre-defined attributes in an Amazon Connect instance, do not use sensitive information in its name and values.

Best practices for PCI compliance in Amazon Connect

Following this list of best practices can help you ensure your Amazon Connect contact center is PCI-compliant.

- Conduct compliance eligibility audits for all services used in your contact center, as well as any third party integration points.

- Payment card information (PCI) should be collected using encrypted DTMF.
- If PCI is captured in call recordings, the PCI data must be scrubbed from the recording and obfuscated from any logs or transcriptions. We recommend working with an Amazon Solution Architect if you need help doing this.
- Use encryption in transit and at rest for any downstream integration points.
- Enable multi-factor authentication (MFA) for any access to PCI as Amazon Connect is a public endpoint.
- For a detailed walkthrough that explains how to encrypt PCI, see [Creating a secure IVR solution with Amazon Connect](#).
- AWS Key Management Service (KMS) encrypts Amazon S3 contents at the object level, which covers recordings, logs, and saved reports by default for Amazon S3. Make sure encryption in transit and at rest rules apply downstream or to third party apps.
- Use encryption in the **Store customer input** block for sensitive DTMF information.
- Use your own KMS key when ingesting data in Amazon Connect Customer Profile domains.
- For more information, see <https://www.pcisecuritystandards.org>.

Best practices for HIPAA compliance in Amazon Connect

Following this list of best practices can help you ensure your Amazon Connect contact center is HIPAA compliant.

- Conduct compliance eligibility audits for all services used in your contact center, as well as any third party integration points.
- AWS Key Management Service (KMS) encrypts Amazon S3 contents at the object level, which covers recordings, logs, and saved reports by default for Amazon S3. Make sure encryption in transit and at rest rules apply downstream or to third party apps.
- Use encryption in the **Store customer input** block for sensitive DTMF information.
- For more information about HIPAA compliance, see <https://www.hipaacompliance.org/>.

Resilience in Amazon Connect

The AWS global infrastructure is built around AWS Regions and Availability Zones (AZs). AWS Regions provide multiple physically separated and isolated AZs, which are connected with low-latency, high-throughput, and highly redundant networking. These AZs are physically separated

by many miles, but still close enough together (60 miles or less) to be used as a single logical data center.

Each AZ features one or more discrete data centers, each housed in its own facility with redundant power, networking, and connectivity. These measures act as safeguards, and minimize the likelihood of an issue like a power outage or earthquake impacting multiple data centers or multiple AZs.

AZs are more highly available, fault tolerant, and scalable than traditional single or multiple data center infrastructures.

For more information about AWS Regions and Availability Zones, see [AWS Global Infrastructure](#).

Amazon Connect runs on AWS proven infrastructure operating in multiple AZs within various geographic regions around the world. This makes Amazon Connect more highly available, fault tolerant, and scalable than would be possible if a contact center solution was run from a single data center.

Within each AWS Region you can create an Amazon Connect instance, with a minimum of 3 AZs. When you create an Amazon Connect instance, that instance is propagated across those AZs in an active-active-active configuration. If there is a failure in one AZ, that node is taken out of rotation without impacting production. This architecture allows you to perform maintenance, release new features, and expand infrastructure without requiring any downtime.

Single-region telephony and softphone architecture

Amazon Connect is integrated with multiple telephony providers with redundant dedicated network paths to three or more AZs in every AWS Region where the service is offered today. If a particular component, data center, or an entire AZ experiences failure, the affected endpoint is automatically taken out of rotation. This allows you to continue providing a consistent quality experience for your customers.

Inbound (US toll-free) and outbound calls in Amazon Connect are processed through multiple telecom carriers. Each carrier is connected to multiple AZs in an active-active configuration. This ensures that impairment of a network path or an entire AZ does not impact your end-customer experience. It also ensures that inbound US toll-free and outbound calls will be placed through multiple carriers so impairment at the carrier level doesn't impact your customer's experience.

The following diagram illustrates this process:

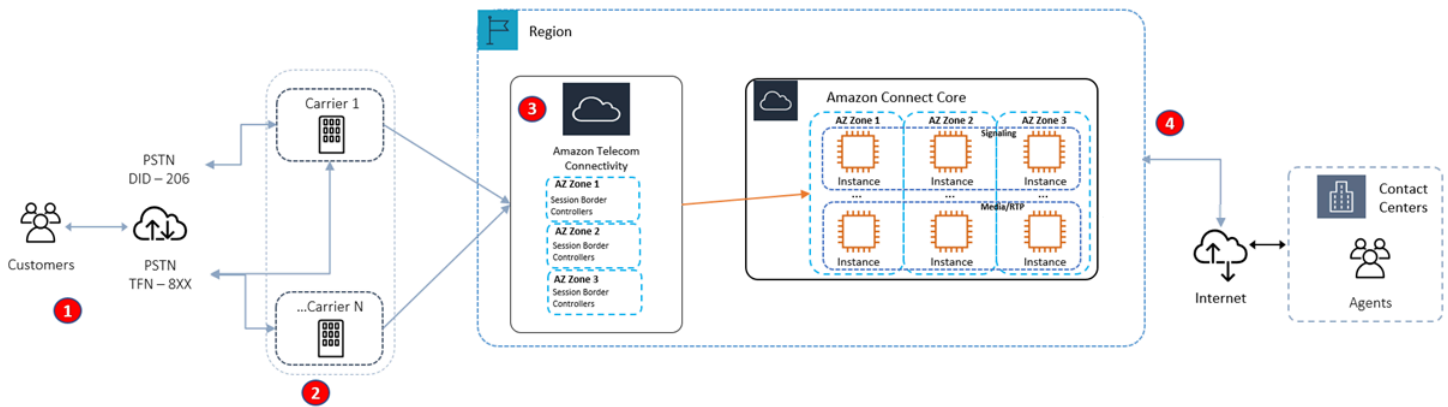

1. Callers reach your contact center using carriers that operate across multiple AZs at all times.
2. [RespOrg](#) routes US toll-free traffic across multiple carriers in an active-active fashion.
3. Outbound calling is load balanced across multiple telephony providers.
4. An agent's browser chooses from at least two servers across multiple AZs, based on reachability.

More resources

To learn more about resiliency for Amazon Connect, the following resources from AWS Workshop Studio are highly recommended:

- [Amazon Connect Global Resiliency Best Practices](#)
- [Amazon Connect Global Resiliency and AWS Services Multi-Region Best Practices](#)

Infrastructure security in Amazon Connect

As a managed service, Amazon Connect is protected by the AWS global network security procedures that are described on the [Best Practices for Security, Identity, and Compliance](#) page.

You use AWS published API calls to access Amazon Connect through the network.

Supported versions of TLS

Clients must support Transport Layer Security (TLS) 1.2 or later.

Amazon Connect offers a new website access model with a new domain (instance name.my.connect.aws) that supports TLS 1.2 or newer versions only. It is available by default for

instances created after March 2021. Existing customers can opt in to using the new domain using the following methods:

- For non-SAML Amazon Connect instances, change your access URL from **.awsapps.com/connect** to **.my.connect.aws** and log in again.
- For SAML-enabled instances, specify an extra query parameter `new_domain=true` in the relay state URL and log in again. For more information, see [Use a destination in your relay state URL](#).

Other requirements

Clients must support cipher suites with perfect forward secrecy (PFS) such as Ephemeral Diffie-Hellman (DHE) or Elliptic Curve Ephemeral Diffie-Hellman (ECDHE). Most modern systems such as Java 7 and later support these modes.

Additionally, requests must be signed by using an access key ID and a secret access key that is associated with an IAM principal. Or you can use the [AWS Security Token Service](#) (AWS STS) to generate temporary security credentials to sign requests.

You can call these API operations from any network location, but Amazon Connect does support resource-based access policies, which can include restrictions based on the source IP address.

Cross-service confused deputy prevention

The confused deputy problem is a security issue where an entity that doesn't have permission to perform an action can coerce a more-privileged entity to perform the action. In AWS, cross-service impersonation can result in the confused deputy problem. Cross-service impersonation can occur when one service (the *calling service*) calls another service (the *called service*). The calling service can be manipulated to use its permissions to act on another customer's resources in a way it should not otherwise have permission to access. To prevent this, AWS provides tools that help you protect your data for all services with service principals that have been given access to resources in your account.

We recommend using the [aws:SourceArn](#) and [aws:SourceAccount](#) global condition context keys in resource policies to limit the permissions that Amazon Connect gives another service to the resource. If you use both global condition context keys, the `aws:SourceAccount` value and the account in the `aws:SourceArn` value must use the same account ID when used in the same policy statement.

The most effective way to protect against the confused deputy problem is to use the exact Amazon Resource Name (ARN) of the resource you want to allow. If you don't know the full ARN of the resource or if you are specifying multiple resources, use the `aws:SourceArn` global context condition key with wildcards (*) for the unknown portions of the ARN. For example, `arn:aws:servicename::region-name::your AWS account ID*`.

Amazon Connect Customer Profiles cross-service confused deputy prevention

The following examples show policies that apply to cases where someone else is set up as the administrator for Amazon Connect Customer Profiles. Use these policies to prevent the confused deputy problem.

Example Amazon Connect Customer Profiles policy to create Customer Profile domains

```
{
  "Version": "2012-10-17",
  "Statement": {
    "Sid": "ConfusedDeputyPreventionExamplePolicy",
    "Effect": "Allow",
    "Principal": {
      "Service": "profile.amazonaws.com"
    },
    "Action": ["kms:GenerateDataKey", "kms:CreateGrant", "kms:Decrypt"],
    "Resource": [
      "arn:aws:kms:your region-name:your AWS account ID:key/your key ARN"
    ],
    "Condition": {
      "ArnEquals": {
        "aws:SourceArn": "arn:aws:profile:your region name:your AWS account ID:domains/your Customer Profiles domain name"
      },
      "StringEquals": {
        "aws:SourceAccount": "your AWS account ID"
      }
    }
  }
}
```

Example Amazon Connect Customer Profiles policy to create Customer Profiles object types

```

{
  "Version": "2012-10-17",
  "Statement": {
    "Sid": "ConfusedDeputyPreventionExamplePolicy",
    "Effect": "Allow",
    "Principal": {
      "Service": "profile.amazonaws.com"
    },
    "Action": ["kms:GenerateDataKey", "kms:CreateGrant", "kms:Decrypt"],
    "Resource": [
      "arn:aws:kms:your Region:your AWS account ID:key/your key ARN"
    ],
    "Condition": {
      "ArnEquals": {
        "aws:SourceArn": "arn:aws:profile:your region name:your AWS account ID:domains/your Customer Profiles domain name/objects/your object type"
      },
      "StringEquals": {
        "aws:SourceAccount": "your AWS account ID"
      }
    }
  }
}

```

Example Amazon Connect Customer Profiles policy to create and update dead-letter queues

```

{
  "Version": "2012-10-17",
  "Statement": [
    {
      "Sid": "Allow Amazon Connect Customer Profiles to publish messages to your queue",
      "Effect": "Allow",
      "Principal": {
        "Service": "profile.amazonaws.com"
      },
      "Action": "sqs:SendMessage",
      "Resource": "your dead-letter queue ARN",

      "Condition": {
        "StringEquals": {
          "aws:SourceAccount": "your AWS account ID",

```

```

        "aws:SourceArn": "arn:aws:profile:your region name:your AWS account ID:domains/your Customer Profiles domain name"
    }
}
]
}

```

Example Amazon Connect Customer Profiles policy to protect the Amazon S3 bucket used as part of the Identity Resolution process

```

{
  "Sid": "Allow Amazon Connect Customer Profiles to put S3 objects to your bucket",
  "Effect": "Allow",
  "Principal": {
    "Service": "profile.amazonaws.com"
  },
  "Action": "s3:PutObject",
  "Resource": "arn:aws:s3:::your S3 bucket name/*",
  "Condition": {
    "StringEquals": {
      "aws:SourceAccount": "your AWS account ID"
    },
    "ArnEquals": {
      "aws:SourceArn": "arn:aws:profile:your region name:your AWS account ID:domains/*"
    }
  }
}

```

Amazon Connect Voice ID cross-service confused deputy prevention

The following Voice ID example shows a resource policy to apply to prevent the confused deputy problem.

```

{
  "Version": "2012-10-17",
  "Statement": {
    "Sid": "ConfusedDeputyPreventionExamplePolicy",
    "Effect": "Allow",
    "Principal": {
      "Service": "voiceid.amazonaws.com"
    }
  }
}

```

```

    },
    "Action": "sts:AssumeRole",
    "Condition": {
      "ArnEquals": {
        "aws:SourceArn": "arn:aws:voiceid:your region name:your AWS account ID:domain/your Voice ID domain name"
      },
      "StringEquals": {
        "aws:SourceAccount": "your AWS account ID"
      }
    }
  }
}

```

Amazon Connect chat message streaming cross-service confused deputy prevention

The following Amazon Connect example shows a resource policy to apply to prevent the confused deputy problem.

```

{
  "Version": "2012-10-17",
  "Statement": [
    {
      "Effect": "Allow",
      "Principal": {
        "Service": "connect.amazonaws.com"
      },
      "Action": "sns:Publish",
      "Resource": "your SNS topic ARN",
      "Condition": {
        "StringEquals": {
          "aws:SourceAccount": "your AWS account ID"
        },
        "ArnEquals": {
          "aws:SourceArn": "your Amazon Connect instance ARN"
        }
      }
    }
  ]
}

```

Security Best Practices for Amazon Connect

Amazon Connect provides a number of security features to consider as you develop and implement your own security policies. The following best practices are general guidelines and don't represent a complete security solution. Because these best practices might not be appropriate or sufficient for your environment, treat them as helpful considerations rather than prescriptions.

Contents

- [Amazon Connect preventative security best practices](#)
- [Amazon Connect detective security best practices](#)
- [Amazon Connect Chat security best practices](#)

Amazon Connect preventative security best practices

- Ensure that all profile permissions are as restrictive as possible. Allow access to only those resources absolutely required for the user's role. For example, don't give agents permissions to create, read, or update users in Amazon Connect.
- Ensure that multi-factor authentication (MFA) is set up through your SAML 2.0 identity provider, or Radius server, if that's more applicable for your use case. After MFA is set up, a third text box becomes visible on the Amazon Connect login page to provide the second factor.
- If you use an existing directory through AWS Directory Service or SAML-based authentication for identity management, ensure that you follow all security requirements appropriate for your use case.
- Use the **Log in for emergency access** URL on the instance page of the AWS console only in emergency situations, not for daily use. For more information, see [Emergency admin login](#).

Use service control policies (SCPs)

Service control policies (SCPs) are a type of organization policy that you can use to manage permissions in your organization. An SCP defines a guardrail, or sets limits, on the actions that the account's administrator can delegate to users and roles in the affected accounts. You can use SCPs to protect critical resources associated with your Amazon Connect workload.

Set a Service Control Policy to prevent the deletion critical resources

If you're using SAML 2.0-based authentication and delete the AWS IAM Role that is used for authenticating Amazon Connect users, users won't be able to login to the Amazon Connect instance. You will need to delete and recreate users to be associated with a new Role. This results in the deletion of all data associated with those users.

To prevent the accidental deletion of critical resources and to protect the availability of your Amazon Connect instance, you can set a [Service Control Policy](#) (SCP) as an additional control.

Following is an example SCP that can be applied at the AWS Account, Organizational Unit, or Organizational Root to prevent the deletion of the Amazon Connect instance and associated Role:

```
{
  "Version": "2012-10-17",
  "Statement": [
    {
      "Sid": "AmazonConnectRoleDenyDeletion",
      "Effect": "Deny",
      "Action": [
        "iam:DeleteRole"
      ],
      "Resource": [
        "arn:aws:iam::*:role/Amazon Connect user role"
      ]
    },
    {
      "Sid": "AmazonConnectInstanceDenyDeletion",
      "Effect": "Deny",
      "Action": [
        "connect:DeleteInstance"
      ],
      "Resource": [
        "Amazon Connect instance ARN"
      ]
    }
  ]
}
```

Amazon Connect detective security best practices

Logging and monitoring are important for the availability, reliability and, performance of contact center. You should log relevant information from Amazon Connect flows to CloudWatch and build alerts and notifications based on the same.

Define log retention requirements and lifecycle policies early on, and plan to move log files to cost-efficient storage locations as soon as practical. Amazon Connect public APIs log to CloudTrail. Review and automate actions based on CloudTrail logs.

We recommend Amazon S3 for long-term retention and archiving of log data, especially for organizations with compliance programs that require log data to be auditable in its native format. After log data is in an Amazon S3 bucket, define lifecycle rules to automatically enforce retention policies and move these objects to other, cost-effective storage classes, such as Amazon S3 Standard - Infrequent Access (Standard - IA) or Amazon S3 Glacier.

The AWS Cloud provides flexible infrastructure and tools to support both sophisticated partner offerings and self-managed centralized-logging solutions. This includes solutions such as Amazon OpenSearch Service and Amazon CloudWatch Logs.

You can implement fraud detection and prevention for incoming contacts by customizing Amazon Connect flows per your requirements. For example, you can check incoming contacts against previous contact activity in Dynamo DB and then take actions such as disconnecting a contact who is on a deny list.

Amazon Connect Chat security best practices

When you integrate with the Amazon Connect Participant Service directly (or use the Amazon Connect Chat Java Script library) and use WebSocket or streaming endpoints to receive messages for your frontend applications or websites, you must protect your application from DOM-based XSS (cross-site scripting) attacks.

The following security recommendations can help safeguard against XSS attacks:

- Implement proper output encoding to help prevent malicious scripts from executing.
- Do not mutate DOM directly. For example, don't use `innerHTML` to render chat response contents. It might contain malicious Javascript code that can lead to an XSS attack. Use frontend libraries like React to escape and sanitize any executable code included in the chat response.

- Implement a Content Security Policy (CSP) to restrict the sources from which your application can load scripts, styles, and other resources. This adds an extra layer of protection.

Agent training guide for the CCP and agent workspace

Agent workspace

With the agent workspace you can access all Amazon Connect features in a single application.

You can:

- Use the Contact Control Panel (CCP) to interact with customer contacts.
- [Use Customer Profiles](#) to view customer information.
- [Use Cases](#) to create, edit, and resolve customer cases.
- [Use Amazon Q in Connect](#) to obtain the information you need from your company knowledge base.

To access the agent workspace use the following URL:

- [https://*instance name*.my.connect.aws/agent-app-v2/](https://instance_name.my.connect.aws/agent-app-v2/)

Where *instance name* is provided by your IT department or the individuals that set up Amazon Connect for your business.

The following image shows the agent workspace with the CCP, Customer Profiles, Cases, and Amazon Q in Connect.

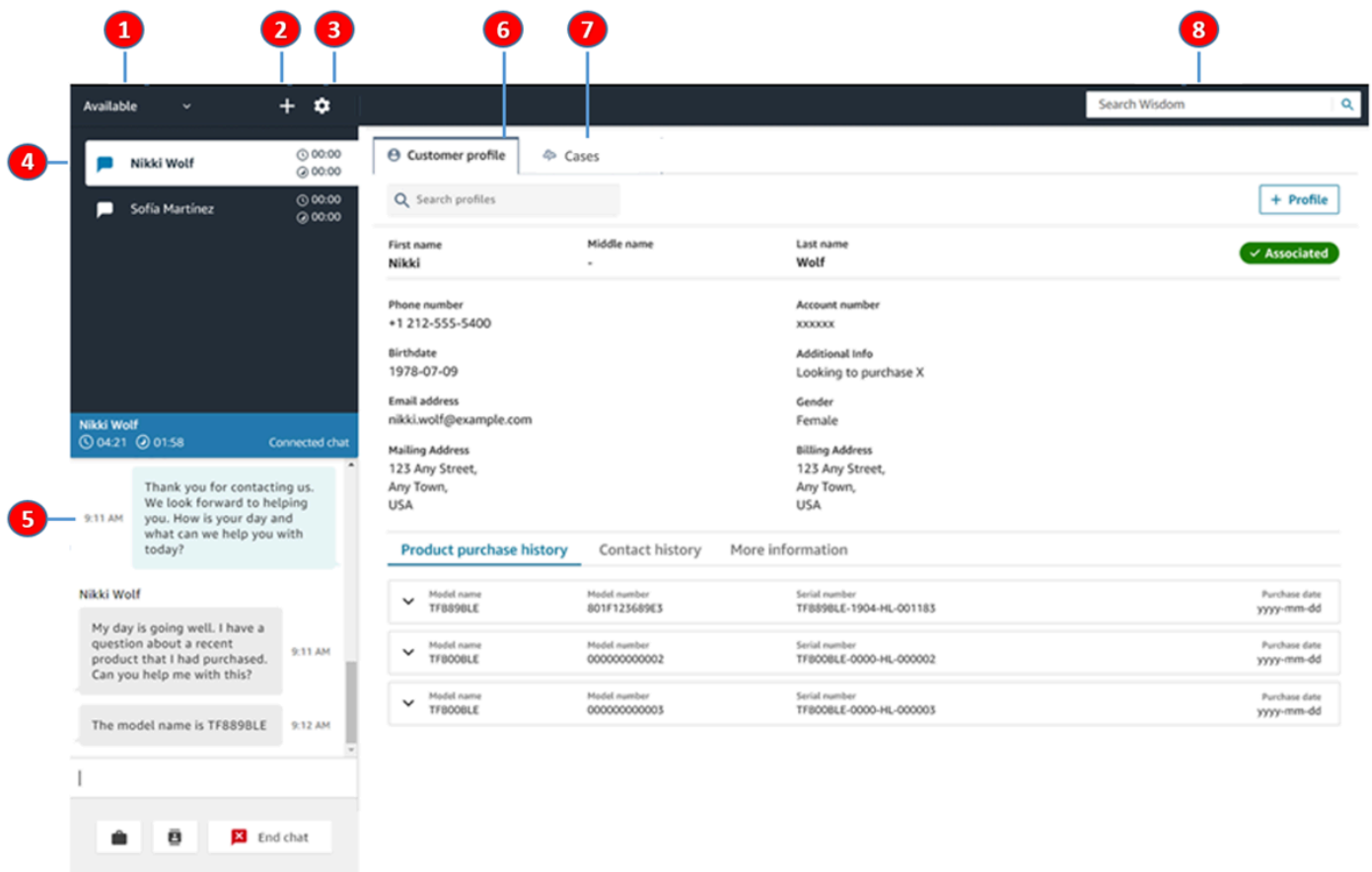

1. Set your status.
2. Access to the number pad, quick connects, and task creation.
3. Log in and out. Set your language preferences, device settings (if enabled), and phone type.
4. Inbox of inbound calls, chats, and tasks.
5. Based on the channel of the contact that is in focus in your inbox, the appropriate content shows here; for example, when a chat is selected, the chat interface appears.
6. View customer information for the contact that is in focus in your inbox.
7. Search and view cases.
8. Search for knowledge articles to solve customer issues.

CCP

You use the Amazon Connect Contact Control Panel (CCP) to interact with customer contacts. It's how you receive calls, chat with contacts, transfer them to other agents, put them on hold, and perform other key tasks.

The URL to launch the CCP is:

- [https://*instance name*.my.connect.aws/ccp-v2/](https://instance_name.my.connect.aws/ccp-v2/)

Where *instance name* is provided by your IT department or the individuals that set up Amazon Connect for your business.

Large businesses often choose to customize their CCP. For example, they might want to integrate it with a CRM. However, this section describes how CCP works before it is customized.

The following image shows the CCP.

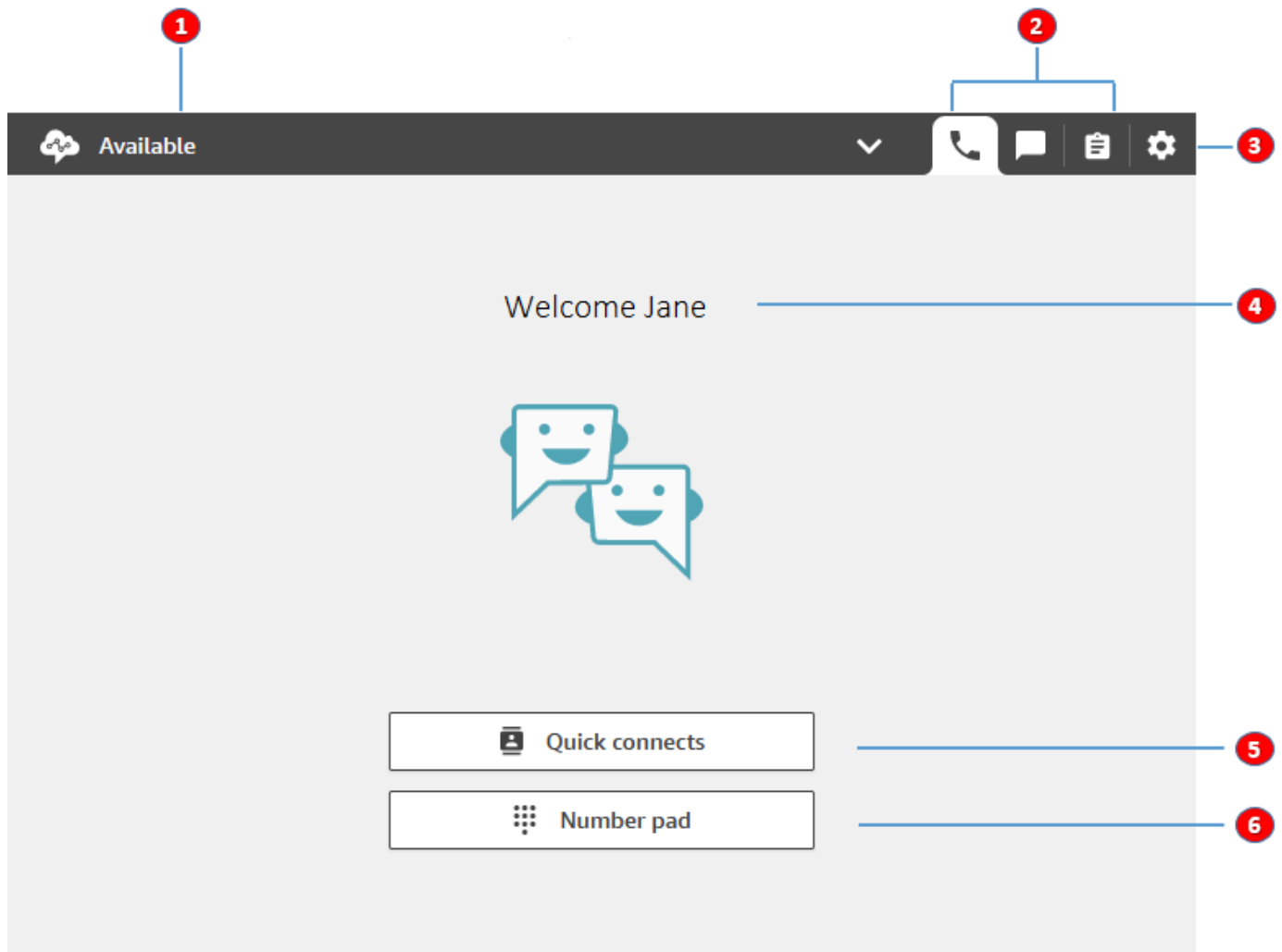

1. Set your status.
2. The channels enabled for your agent routing profile.
3. Log in and out. Set your language preferences, device settings (if enabled), and phone type.

4. Name of the agent that's currently signed in.
5. Choose a predefined destination to transfer the contact. Or call an external number.
6. Call a number or enter digits into an IVR menu.

Training video: How to use the CCP

The following video introduces you to the Contact Control Panel (CCP). It shows how to perform common tasks, such as login and setup, accept incoming calls, place calls, transfer calls, accept chat, and more.

[Amazon Connect](#)

Launch the CCP

The URL to launch the CCP is:

- [https://*instance name*.my.connect.aws/ccp-v2/](https://instance_name.my.connect.aws/ccp-v2/)

Where *instance name* is provided by your IT department or whoever set up Amazon Connect for your business. The following image shows an example URL for the CCP.

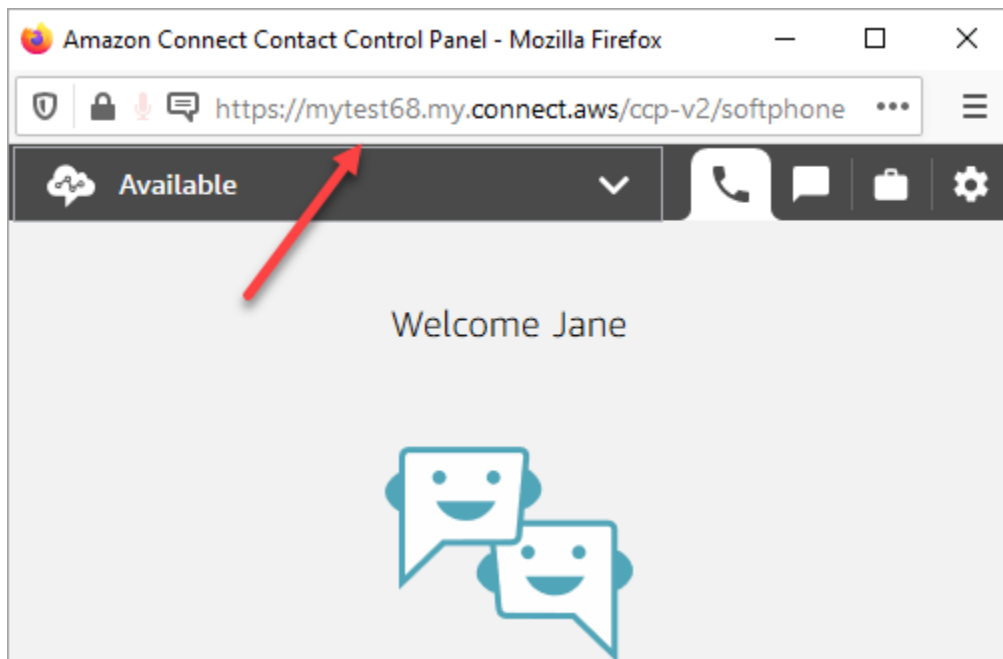

With this updated CCP, your agents can manage voice, chat, and tasks from this single interface.

As the administrator, you can also launch the CCP directly from the Amazon Connect console. Just choose the phone icon in the upper right corner.

To provide agents the ability to launch the CCP from their desktop and start handling contacts, there are a few things you need to do:

- Add agents as users to the instance. For more information, see [Manage users in Amazon Connect](#).
- Configure permissions for the agents. By default, agents assigned to the Agent security profile can access the CCP and make outbound calls. But you can create a custom security profile and add additional permissions. For more information, see [Security profiles](#).
- Give agents the URL the CCP.
- Provide agents with their user name and password so that they can log in to the CCP.

We recommend telling agents to bookmark the URL to the CCP for more convenient access.

Agents can use the CCP with a softphone on their computer, or a deskphone. If they're using a softphone, they must use Chrome, Edge, or Firefox for their web browser. For more information, see [Grant microphone access in Chrome, Firefox, or Edge](#).

Note

If you see the **Session expired** message while logging in, you probably just need to refresh the session token. Go to your identity provider and log in. Refresh the Amazon Connect page. If you still get this message, contact your IT team.

Log in and log out of the Amazon Connect CCP

Before you can log in to the Contact Control Panel (CCP), your administrator must give you the following information:

- The URL to launch the CCP:
 - `https://instance name.my.connect.aws/ccp-v2/`

Where *instance name* is provided by your IT department or whoever set up Amazon Connect for your business.

- Your agent ID.

- Your agent password.

To log in

After you have that information, here's how to log in and get started.

1. Ensure that your USB headset is securely connected to your computer.
2. Using Chrome or Firefox, open the CCP by using the URL that you received from your administrator.
3. Enter your agent ID and password, and then choose **Sign In**.



4. If you're prompted to **Allow access to cookies**, choose **Grant access**, and then choose **Allow**.

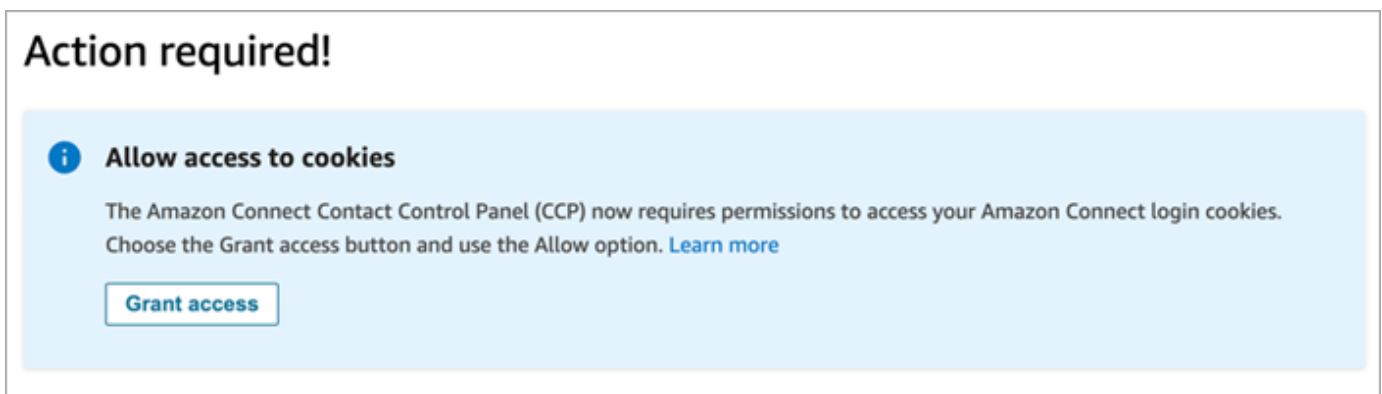

OR

Action required!

Allow access to cookies

As per your browser policy, this website now explicitly requires permission to access cookies. Request access by clicking the below 'Grant Access' button and 'Allow' your browser permissions. This will only allow access to your login cookies. [Learn more](#)

[Grant access](#)

Amazon Connect uses cookies for authentication. Google Chrome requires you to authorize the use of Amazon Connect cookies.

Tip

IT admins: For more information, see [Using Amazon Connect with third-party cookies](#).

5. If you are prompted to allow access to your microphone and speaker, choose **Allow**.

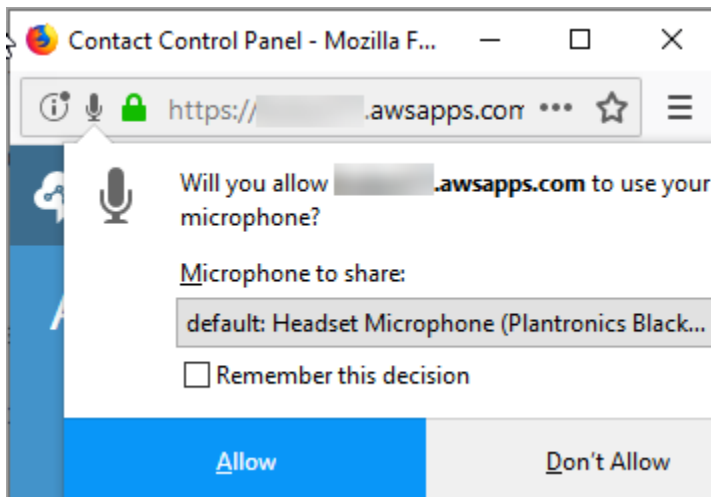

You're all set to go!

Problems logging in?

If you have problems logging in to the CCP, contact your manager for help, or the IT Department for your organization.

Note

If you see the **Session expired** message while logging in, you probably just need to refresh the session token. Go to your identity provider and log in. Refresh the Amazon Connect page. If you still get this message, contact your IT team.

Log out of the Amazon Connect CCP

Important

Closing the CCP doesn't automatically sign out an agent. Amazon Connect still tries to route contacts to them. To change this behavior, a developer can customize CCP for your contact center. For instructions, see [CCPv1: Log out agents automatically when they close their CCP](#).

1. At the top of the CCP, choose **Settings**.
2. Choose **Log out**.

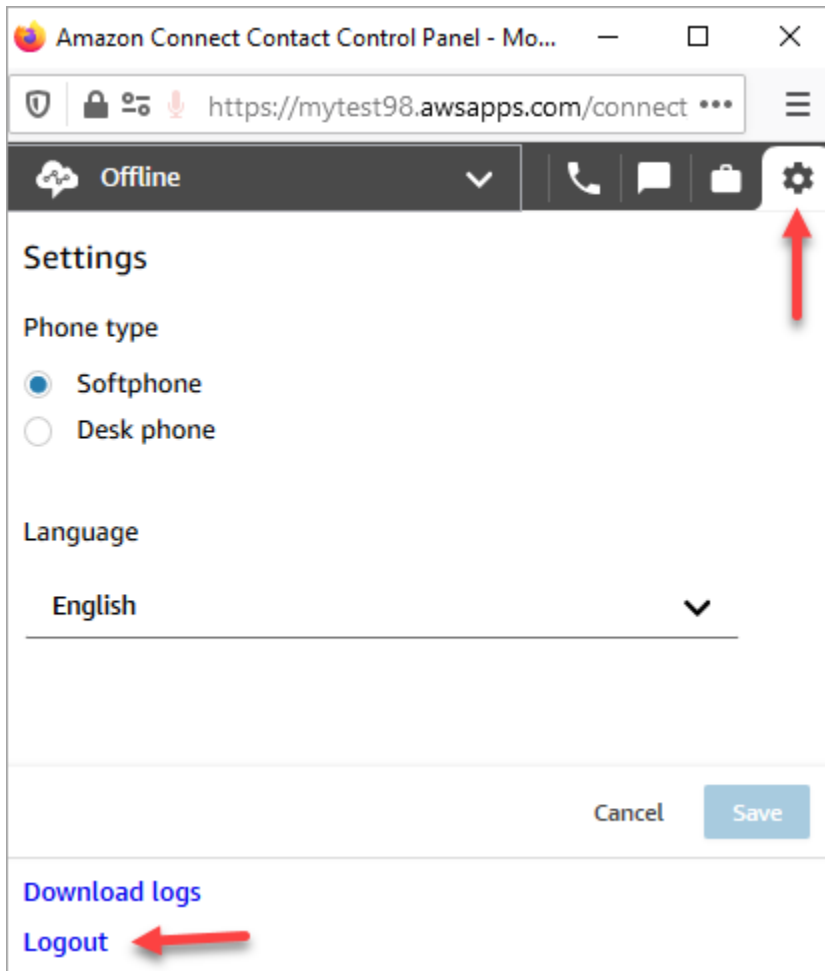

Using the CCP: Allow access to cookies

When logging into the CCP you may see one of these banners:

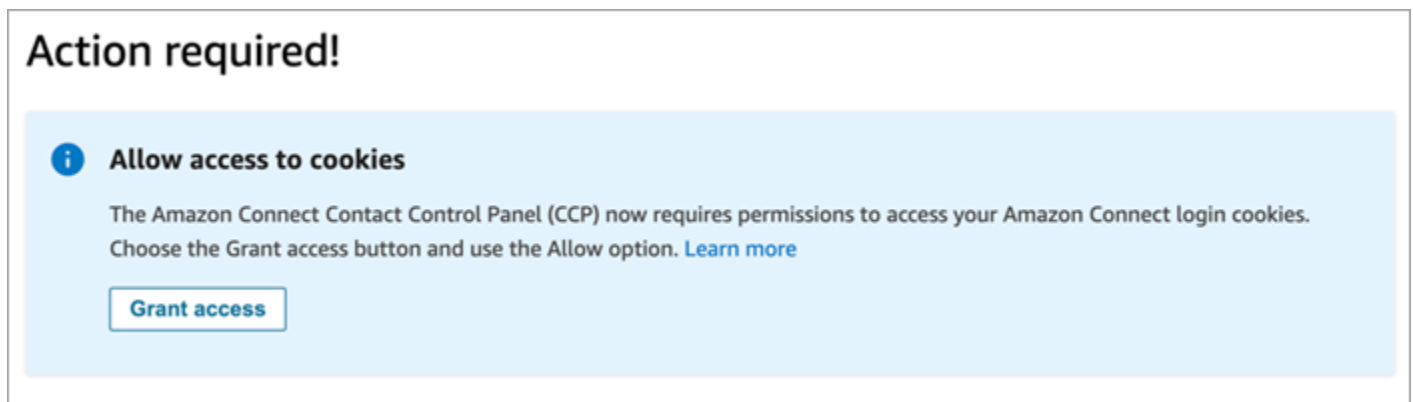

OR

Action required!

Allow access to cookies

As per your browser policy, this website now explicitly requires permission to access cookies. Request access by clicking the below 'Grant Access' button and 'Allow' your browser permissions. This will only allow access to your login cookies. [Learn more](#)

[Grant access](#)

Amazon Connect uses cookies for authentication. Google Chrome requires you to authorize the use of Amazon Connect cookies.

1. When you log in to the CCP, on the **Allow access to cookies** banner choose **Grant access**.
2. At the next prompt, choose **Allow**.

You may need to repeat these steps periodically, for example, if your organization requires it every 30 days.

What happens if you don't choose Grant access when prompted?

If you don't choose **Grant access** when prompted, you won't be able to log into the CCP. To enable access outside of the login workflow, perform the following steps:

1. Navigate to `chrome://settings/content/storageAccess`.
2. In the left navigation menu, choose **Privacy and security**.
3. Choose **Third-party cookies**.
4. Under **You blocked these sites from using info they've saved about you**, delete any entries associated with `awsapps.com` or `connect.aws` as shown in the following image.

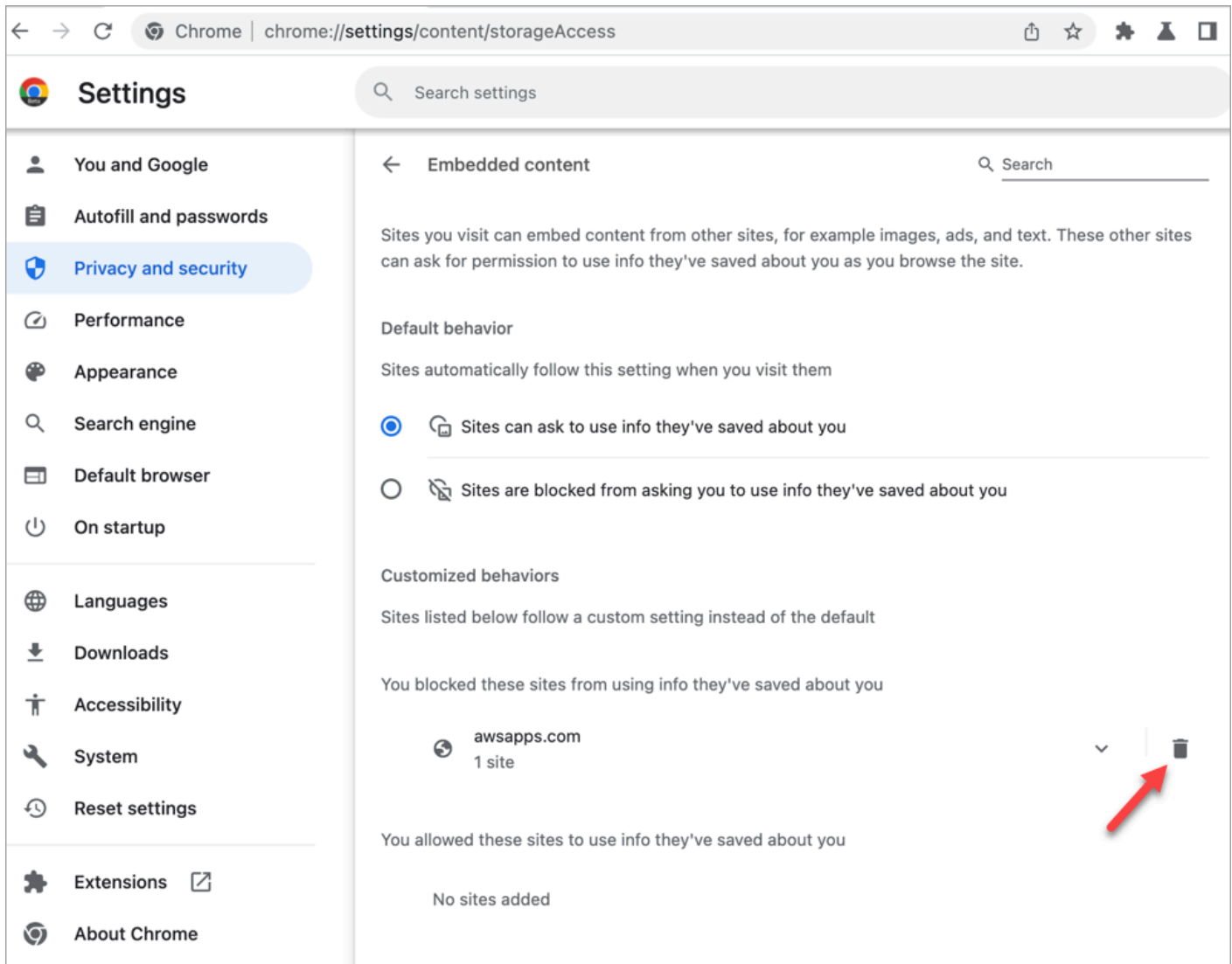

5. You can close that instance of your browser.
6. Open your CCP. When prompted, choose **Grant access**, and then choose **Allow**.

How to use the CCP or agent workspace to change your audio device settings

When you're using the CCP or agent workspace, you can choose your preferred device for the audio, microphone, and ringer. This allows you to have audio notifications to ring from a desktop/laptop speaker instead of a headset, for example.

Tip

- **IT admins:** Agents need **Contact Control Panel (CCP) - Audio device settings** permissions in their security profile to access this feature.
- **Developers:** If you are embedding the CCP into a CRM or custom desktop, you can use either the **Audio device settings** security profile permission or [Amazon Connect Streams](#) to pass the `enableAudioDeviceSettings` parameter to enable audio device settings upon initialization. If either of those flags is true, the audio device settings user interface is displayed in **Settings** on the CCP.

For granular permission, we recommend using the security profile permission. The Streams flag is supported for backward compatibility.

Change audio device settings in the CCP

1. In the CCP or agent workspace, choose **Settings**. The **Settings** dialog box appears, similar to the following image.

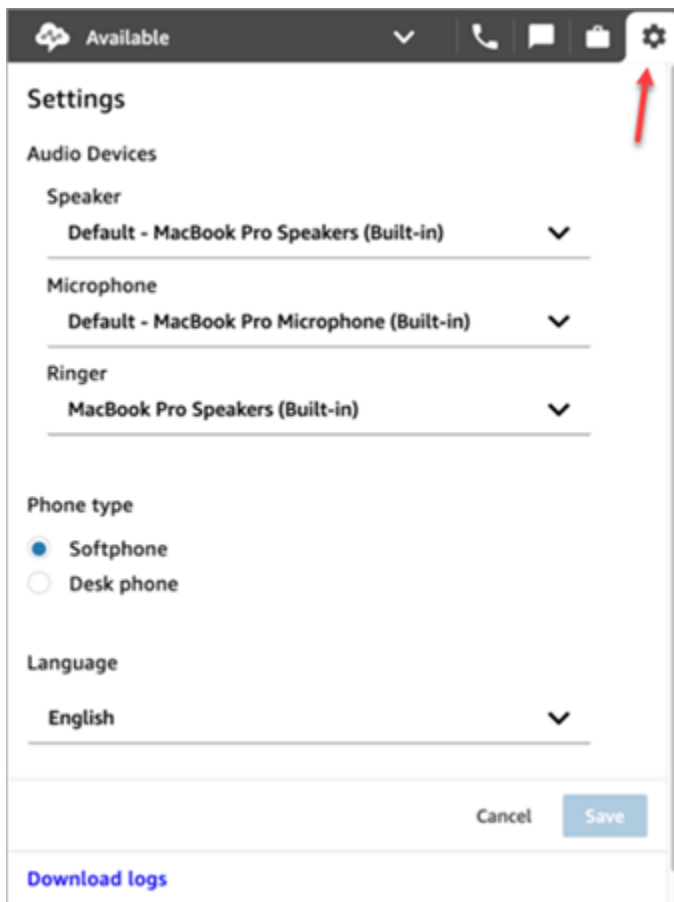

2. Under **Audio devices**, use the dropdown to select your **Speaker**, **Microphone**, and **Ringer**.

Prerequisite: Allow your browser to access your microphone

Before you can change your audio device settings in the CCP, you need to make sure you've given your browser permission to access your microphone. This populates the device list in the CCP.

If you haven't done this yet, see the instructions for your browser.

- [Chrome](#)
- [Edge](#)
- [Firefox](#)

Firefox limitations

If you use Firefox for your browser, you can change only your microphone setting using the CCP. You can't change speaker and ringer settings in CCP due to a limitation with this browser. With your

operating system's sound device settings you can change your device for audio output, however, both speaker and ringer audio will come from the same device. We recommend using another supported browser for this feature.

What to check when your audio device isn't working as expected

Following are the top tips for resolving issues with audio devices.

- Check that your headset is properly connected to your desktop.
- Ensure that Windows exclusive mode is not enabled. For instructions that are appropriate for your device, search the internet for turning off Windows exclusive mode for your audio device.
- Ensure that the device is not muted or disabled in your operating system settings. Following are instructions for a Windows computer:
 1. Press **Windows + I** to open **Settings**.
 2. Click **System**, and then click **Sound** on the left navigation pane.
 3. Scroll down the page and click **Microphone privacy settings**.
 4. Under **Allow apps to access your microphone**, set the toggle to **On**.

Forward calls to a mobile device (iPhone, Android)

You can take the audio portion of a call on your mobile device, and at the same time use your computer to access the Contact Control Panel. This topic explains how to forward calls to your mobile device.

1. In your Contact Control Panel (CCP), open Settings.
2. Under **Phone type**, choose **Desk phone**.
3. Enter the phone number for your mobile device, and choose **Save**.

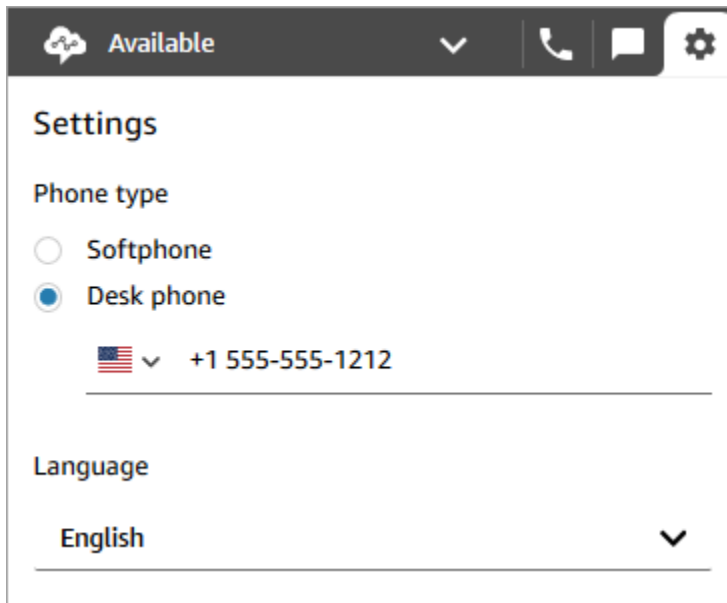

When a contact calls, the audio portion of the call goes to your mobile device. At the same time, on your computer you can manage the call using the CCP.

View your schedule in the agent workspace

If your organization uses the forecasting, capacity planning, and scheduling features of Amazon Connect you can view your schedule in the agent workspace, the Contact Control Panel (CCPv1 or CCPv2), the Salesforce CTI, or a custom-built agent desktop.

Following are steps you use to view your schedule in the agent workspace.

1. Log on to the agent workspace using the URL that your admin gives you (for example, **[https://\[instance name\].my.connect.aws/ccp-v2/](https://[instance name].my.connect.aws/ccp-v2/)**).
2. Choose the Calendar icon on the application navigation bar to launch the staff schedule manager viewer. Otherwise, the staff schedule manager viewer launches automatically.

The following image shows a sample schedule in the agent workspace.

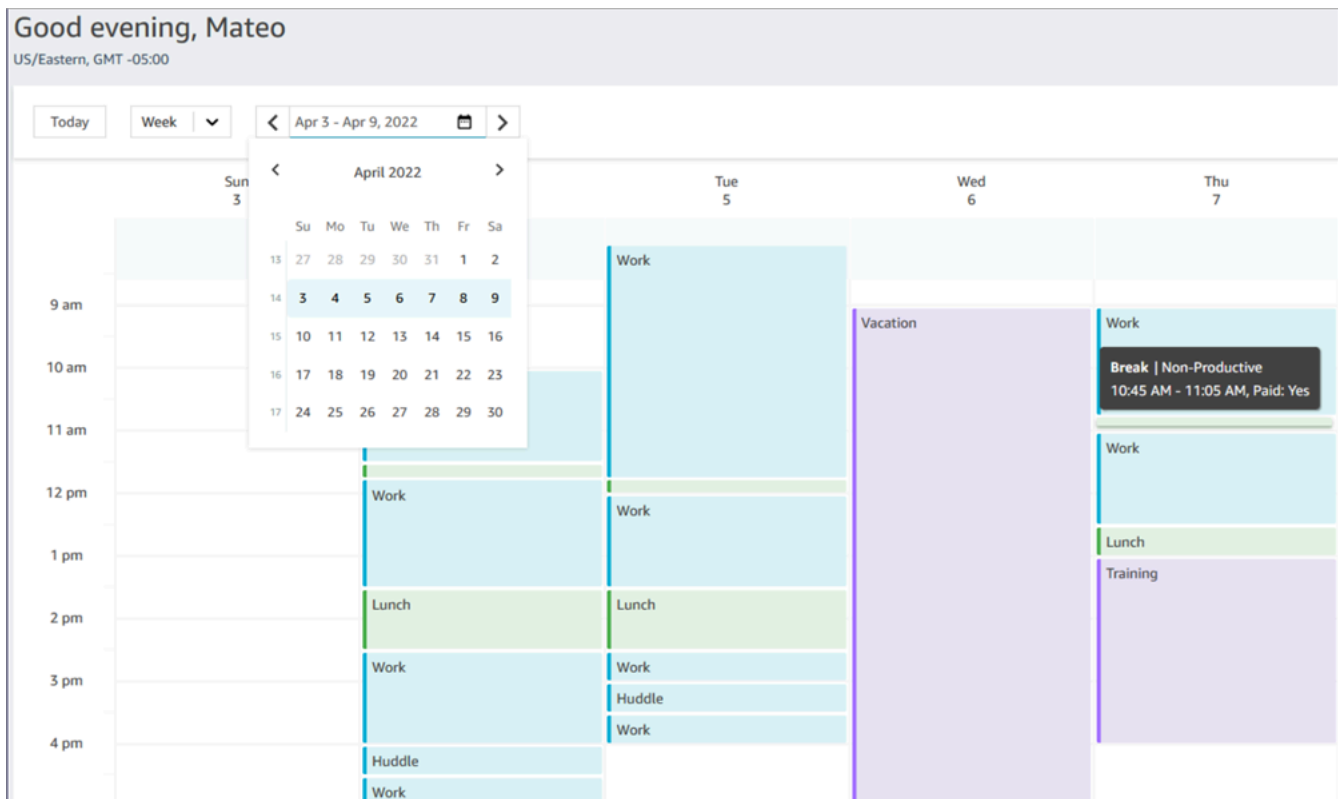

You can see a daily or weekly view of your schedule.

Set your status to "Available" in the CCP

When an agent is ready to handle calls or chats, they need to set their status in the CCP to **Available**. This tells Amazon Connect they are ready to handle contacts.

Amazon Connect uses information in the agent's [routing profile](#) to determine which contacts to route to them.

For more information about agent statuses, see [About agent status](#). For information about how Amazon Connect counts the Available status in the real-time metrics report, see [Available](#).

Set your "Next status" in the CCP

Note

"Next status" is available only to customers who are using the latest Contact Control Panel (CCP). The URL for the latest CCP ends with **ccp-v2**.

IT administrators: For more information about the **Next status** feature, such as changes to the agent event stream, see [July 2021 Updates](#) in the *Release notes*.

Use the **Next status** feature to pause new contacts being routed to you, while you finish your current contacts. When all your slots are cleared, Amazon Connect automatically sets your CCP to the next status, such as **Lunch**.

The following images of the Contact Control Panel (CCP) show how to use this feature.

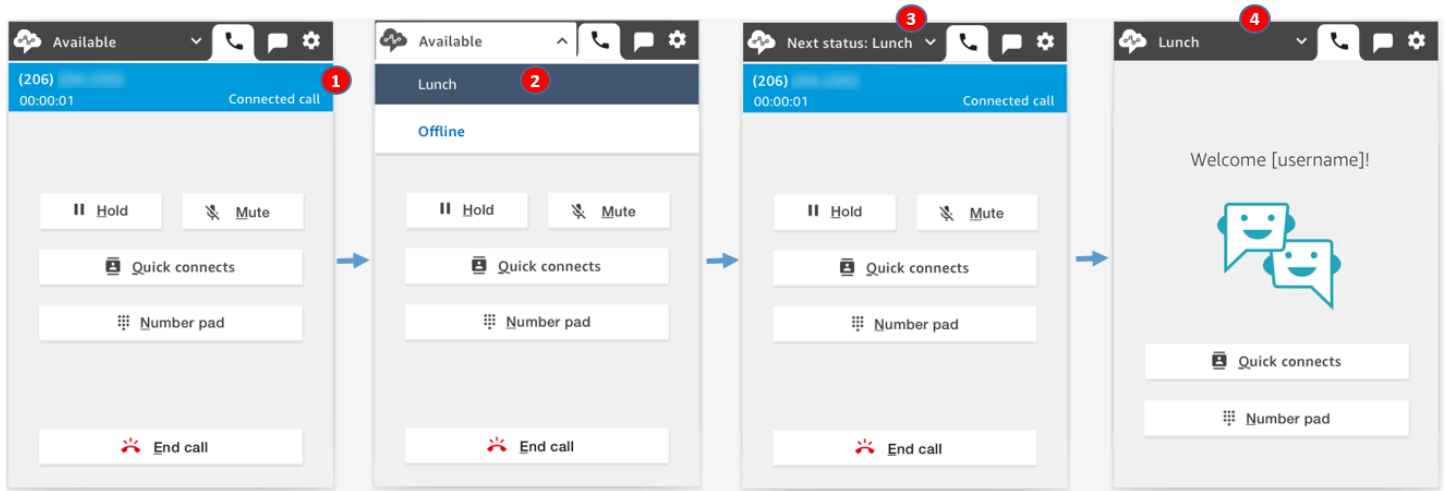

1. Available: The agent is on a contact.
2. The agent chooses their next status, such as **Lunch**. They can choose only a custom ([NPT](#)) status, or **Offline**.
3. The agent is in **Next status: Lunch**. They are still on contact. No new contacts can be routed to them.
4. The contact ends. The agent finishes ACW, and chooses **Clear contact**. Instead of going back to **Available**, their CCP is automatically set to **Lunch**.

How to cancel "Next status"

You can easily switch from **Next status** back to **Available**. The ability to switch your status is useful, for example, if you accidentally choose **Next status: Lunch**, or if you decide not to go to **Lunch** before Amazon Connect automatically sets to that status.

The following images show this workflow.

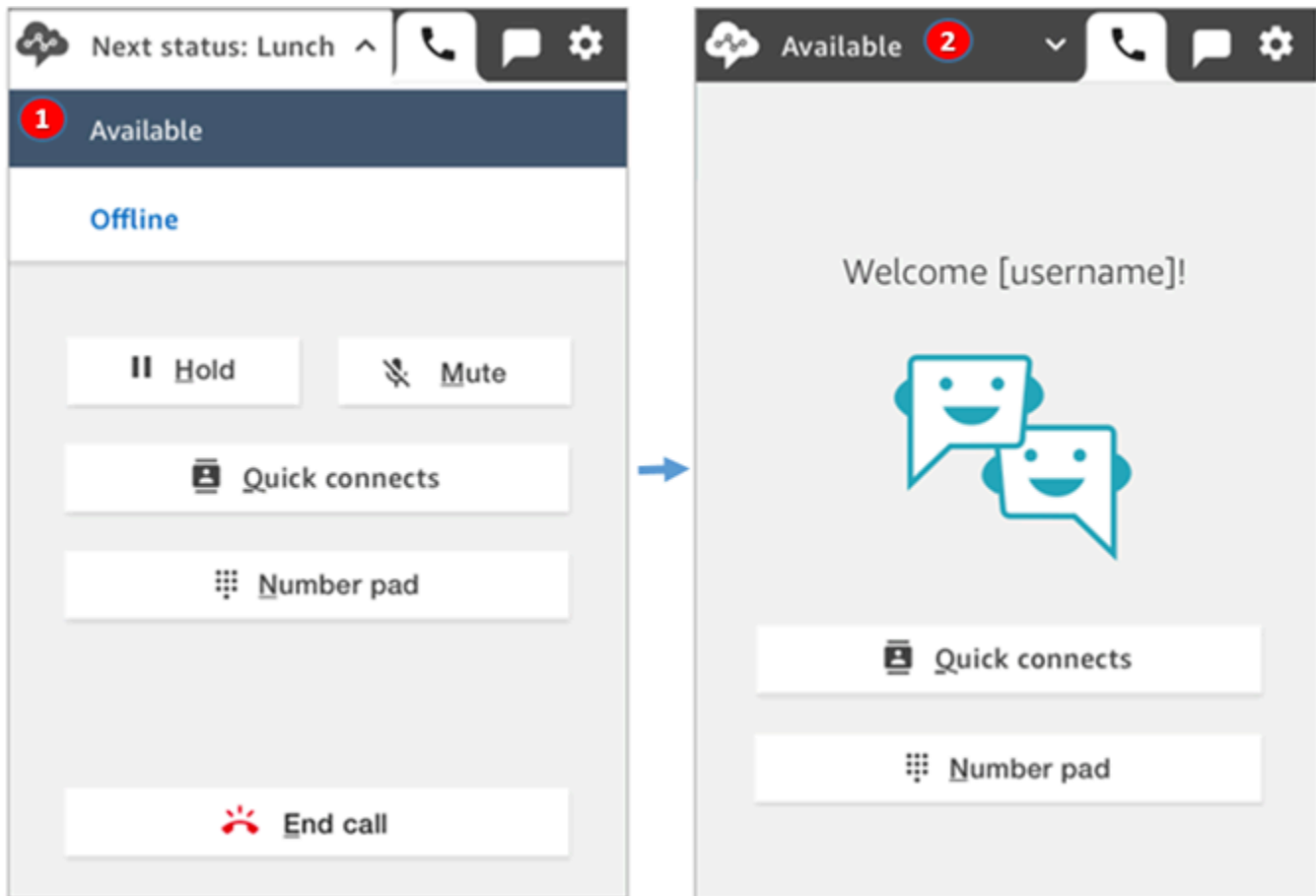

1. While working on the same contact, the agent cancels **Next status: Lunch** and goes back to **Available**.
2. The contact ends and the agent is still **Available** for new contacts to be routed to them.

Example 1: Set "Next status" while handling only ACW contacts

Let's say an agent is finishing after contact work (ACW) for one or more contacts, such as a voice contact or multiple chats. They are not on contact with anyone.

Instead of choosing **Clear contact** when the agent finishes ACW, they choose **Lunch**. This puts them in **Next status: Lunch** only briefly.

Here's what happens in this scenario:

1. Agent finishes ACW and chooses **Lunch** instead of **Clear contact**.
2. Amazon Connect stops routing new contacts to them.

3. All their slots are cleared. This is so the agent doesn't have to choose **Clear contact** to end the ACW.
4. Because all the ACWs have been cleared, Amazon Connect immediately starts the automatic transition that sets the agent's status to **Lunch**.

Agents were put into **Next status - Lunch** only briefly (milliseconds!). They might even see it in the CCP if they look fast enough.

This order of events mirrors how the CCP works when agents change their status while working on ACW. For example, an agent is finishing ACW and they set their status to **Lunch**. Here's what happens next:

1. Amazon Connect stops routing new contacts to them.
2. The ACW slot is cleared for the agent so they don't have to choose **Clear contact**.
3. The agent is set to **Lunch**.

Example 2: Set "Next status" while managing some chats on contact and other chats in ACW

Let's say an agent is managing two chats:

- Customer 1 is in ACW.
- Customer 2 is on contact.

While still on a contact, the agent sets their status to **Offline**. This puts them in the **Next status: Offline** state.

Here's what happens in this scenario:

1. The agent sets their status to **Offline**.
2. Amazon Connect stops routing new contacts to them.
3. The contact that is in ACW is cleared so the agent doesn't have to choose **Clear contact**. Only the connected chat remains.
4. The agent's status is **Next status: Offline**, and they continue working on their connected chat.
5. After they finish work on that contact, the agent chooses **Clear contact** to end the ACW.

6. Amazon Connect automatically sets the agent's status to **Offline**.

Work with calls in the CCP

The topics in this section explain how to use the Amazon Connect Contact Control Panel to manage customer calls.

Contents

- [How to use the CCP to accept incoming calls](#)
- [Transfer calls to a quick connect or external phone number](#)
- [Multi-party calls: Add additional participants to an ongoing call](#)
- [How to use the CCP to make outbound calls](#)
- [View a call transcript during ACW](#)

How to use the CCP to accept incoming calls

1. Whenever you set your status in the CCP to **Available**, Amazon Connect can deliver calls to you, based on the settings in your [routing profile](#).

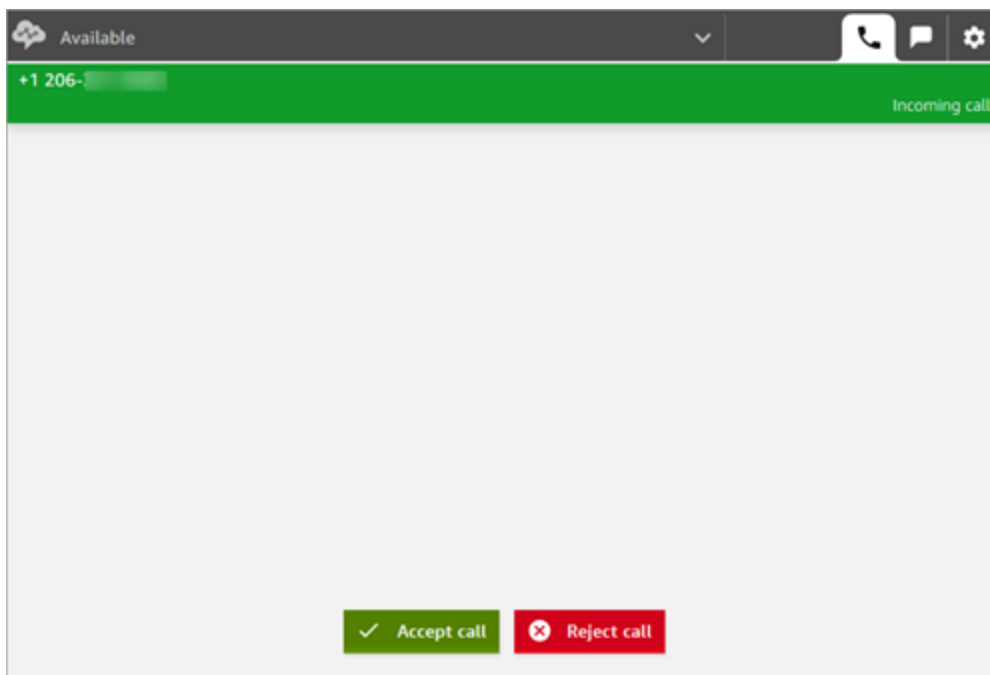

2. When a call arrives, choose the **Accept call** button.

Note

The **Accept call** button does not appear if your admin has configured your user profile for [Auto-Accept Call](#).

3. Before you're connected to the contact, Amazon Connect announces the name of the originating queue.
4. You're now talking to the contact.
5. You have 20 seconds to accept or reject a contact. If you miss a call, it will look similar to the following image. Choose **Clear contact** so you can accept another call.

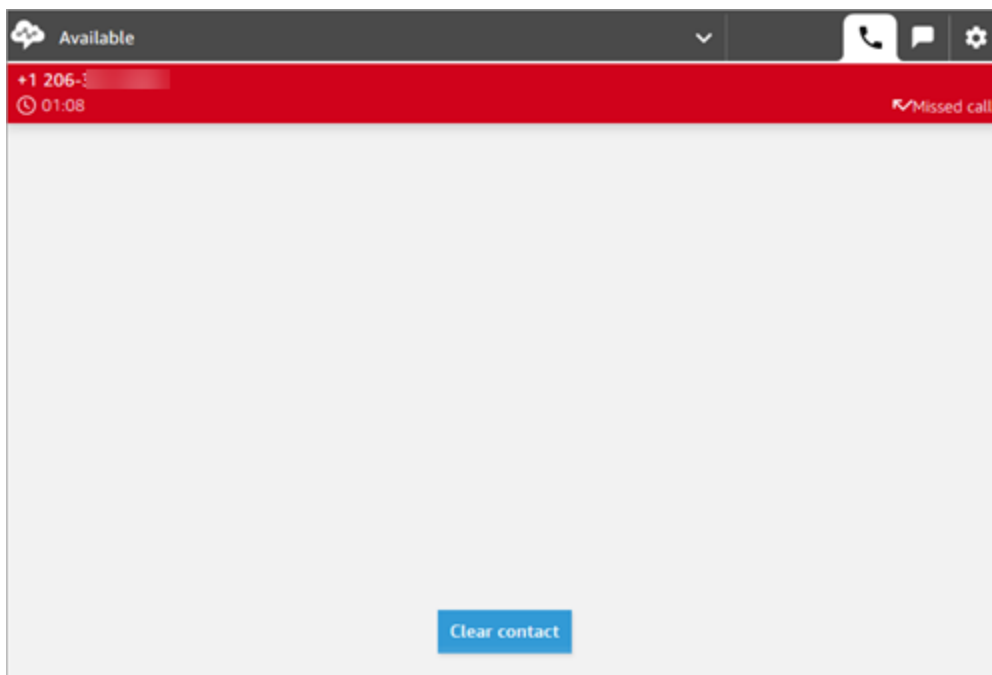

Transfer calls to a quick connect or external phone number

You can transfer calls to people in a predefined list, called quick connects. You can also transfer calls to external phone numbers that you enter.

To transfer to a quick connect or to an external number

1. While you're connected to the contact, choose **Quick connects** on the CCP.

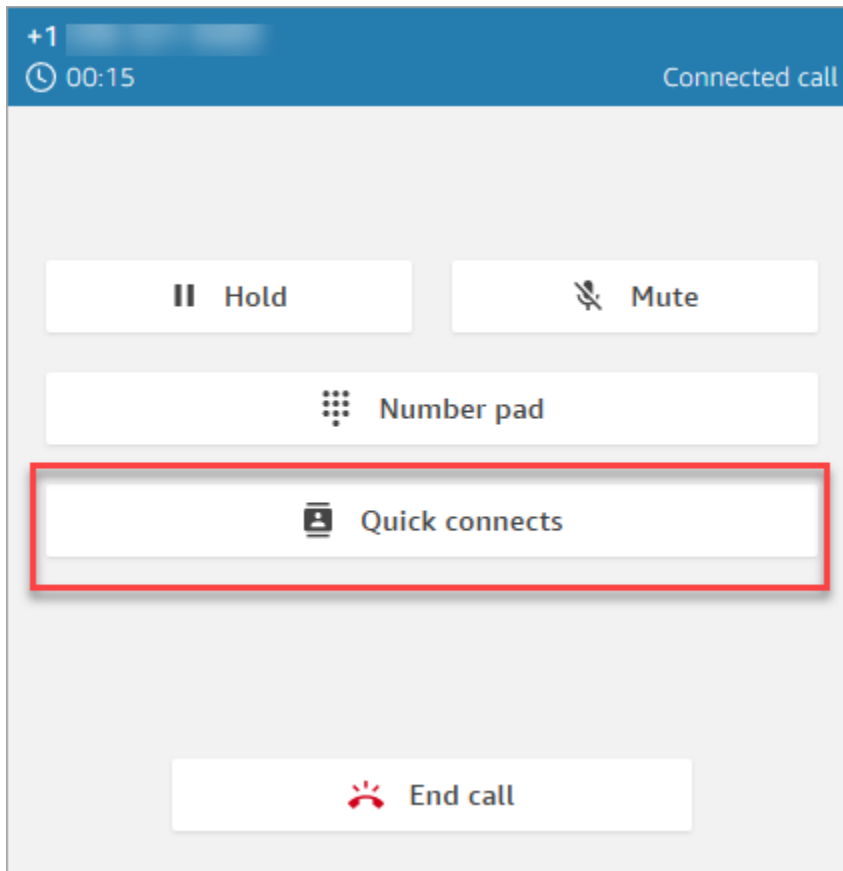

2. From the list of quick connects, choose the name of another agent to transfer the call to. (Your Amazon Connect administrator adds the names of agents to the list of quick connects.)

i Tip

Agents see the quick connects of the queues in their routing profile, including the Default outbound queue.

Or, to call an external number, choose **Number pad**, enter the number you want to call, and then choose **Call**.

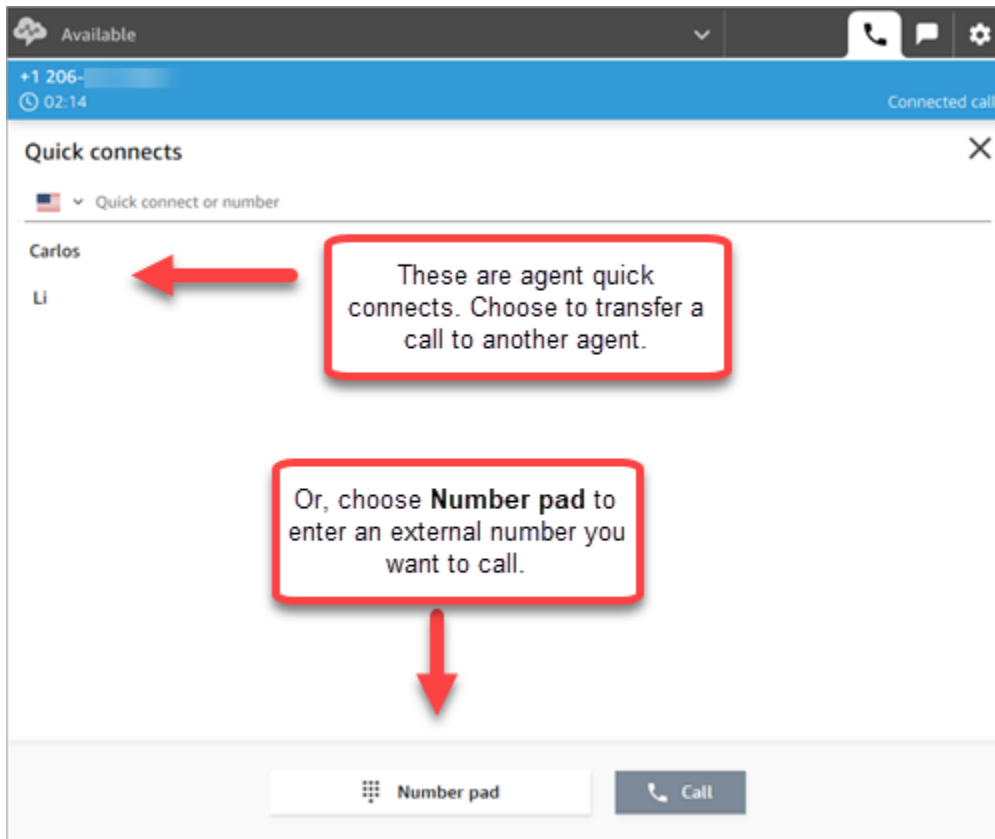

3. After the call is connected to the transfer destination, you can choose **Join** so the caller, the transfer destination, and you are in a conference call.

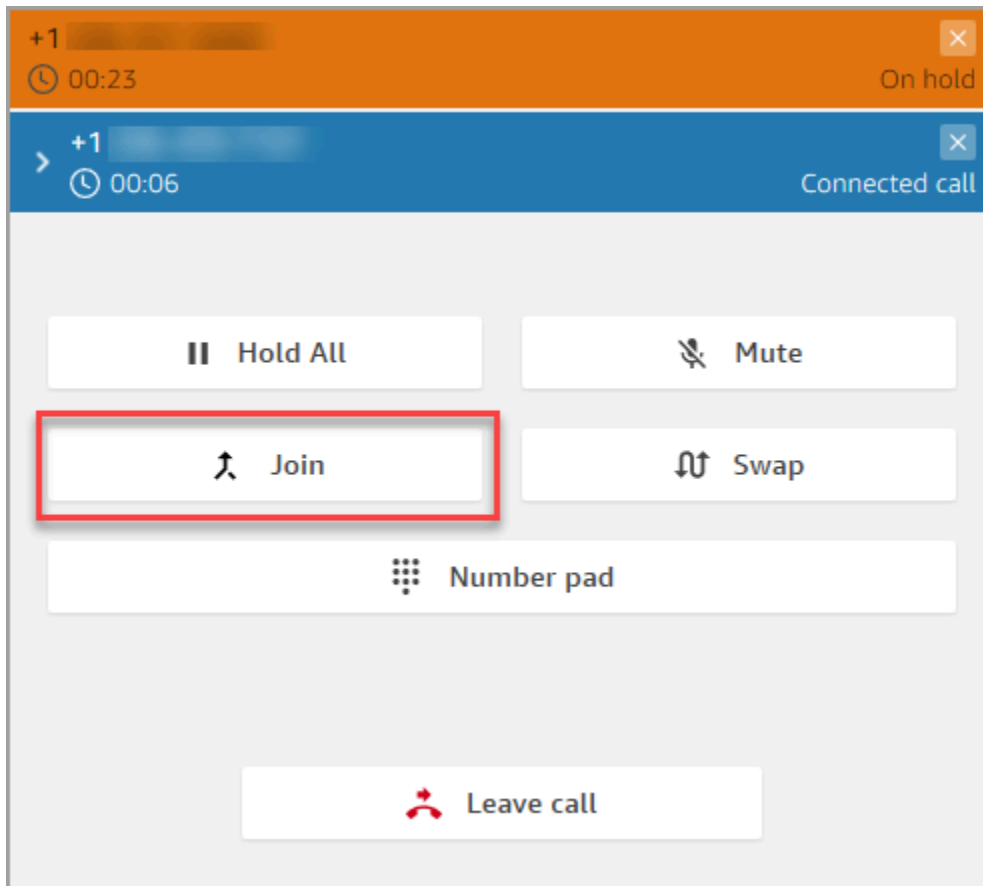

4. When the call is joined, the three of you can talk. Choose **Leave** to complete the transfer and exit the call.

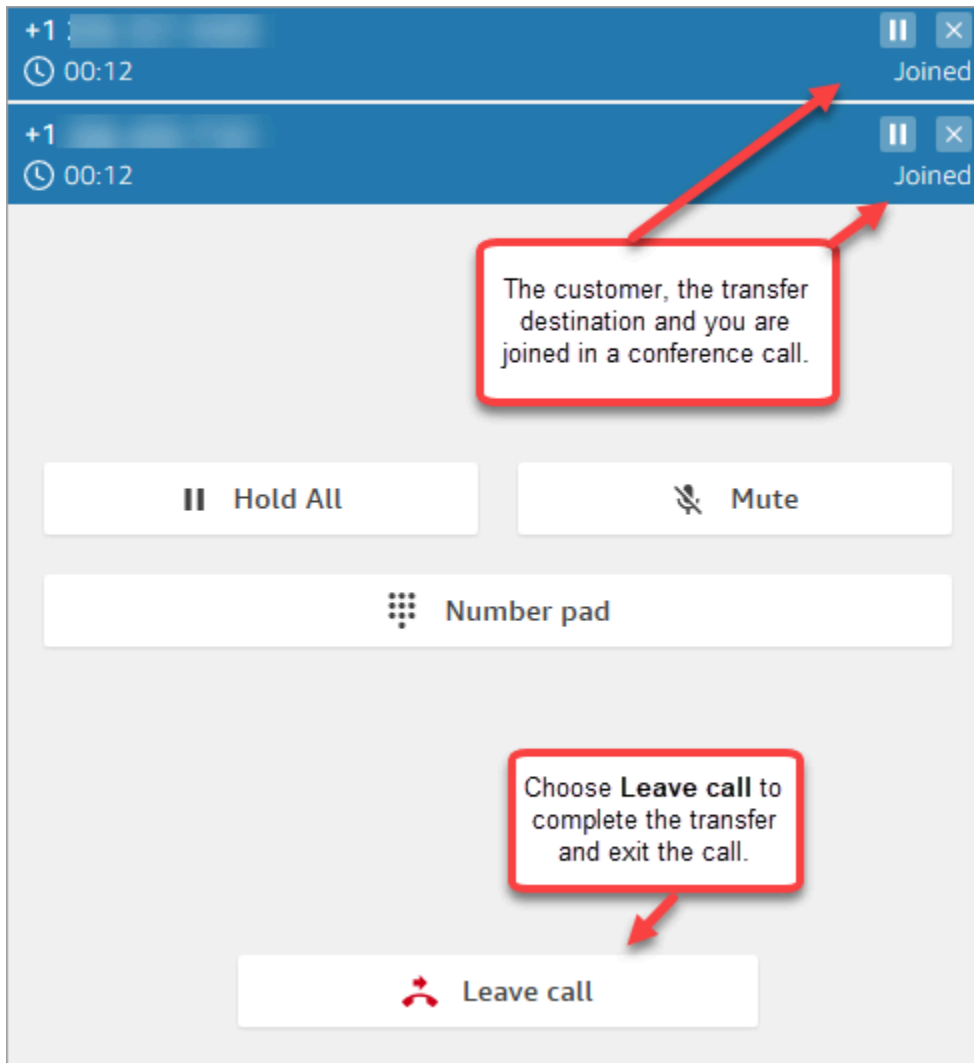

5. Complete the after contact work and then choose **Clear contact**.

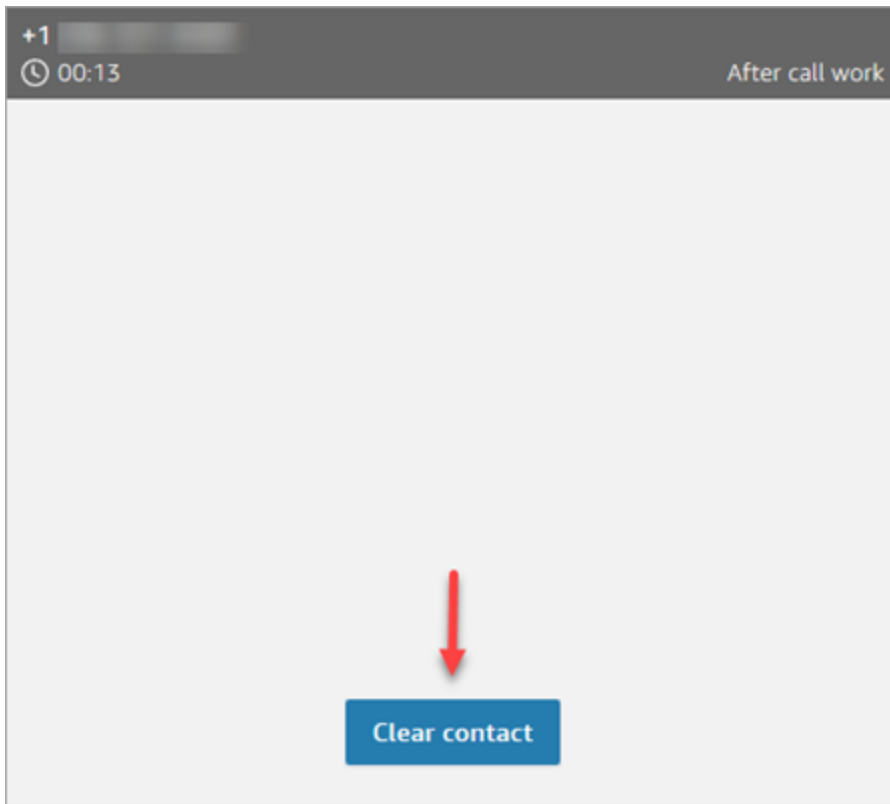

Manage transfer a call

After you initiate a transfer, the customer is placed on hold and you are connected to the transfer destination. The following image shows what actions you can take at this point.

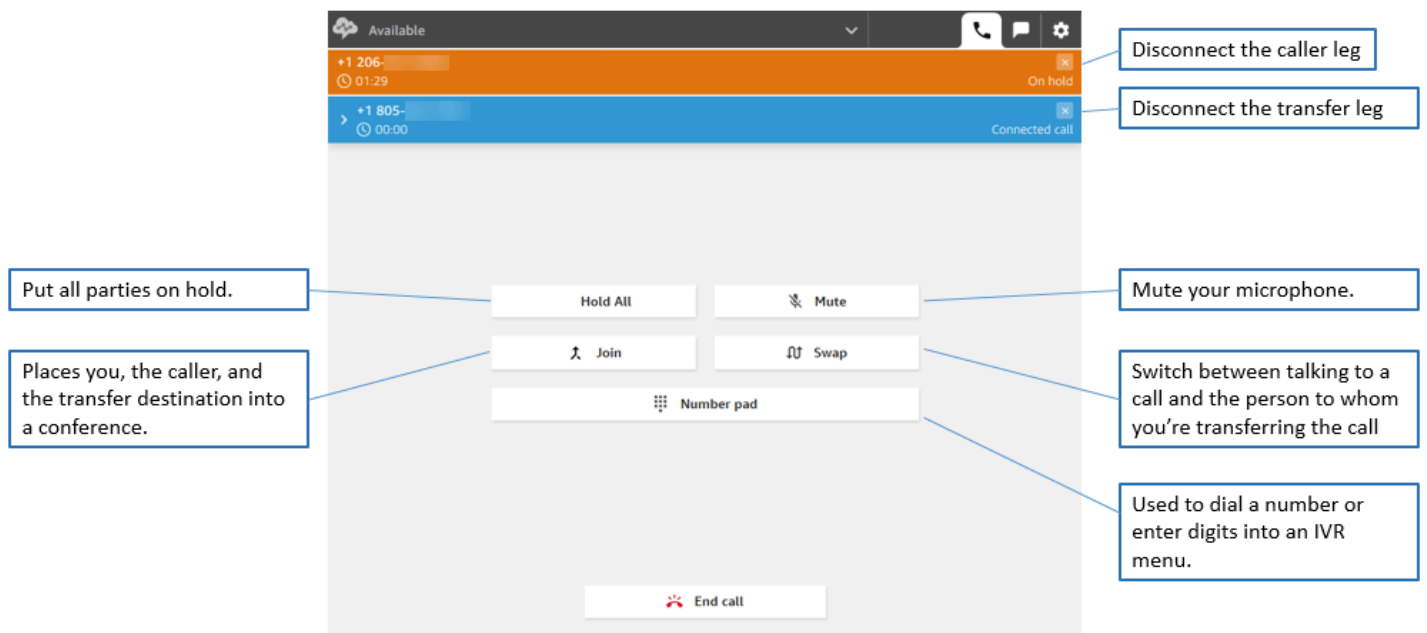

Transfers create multiple contact records

A contact record is opened for a customer when they are connected to your contact center. The contact record is completed when the interaction with the flow or agent ends (that is, the agent has completed the ACW and cleared the contact). This means it's possible for a customer to have multiple contact records.

The following diagram shows when a contact record is created for a contact. It shows three contact records for a contact:

- The first record is created when the contact is connected to Agent 1.
- The second record is created when the contact is transferred to Agent 2.
- The third record is created when the contact is connected to Agent 3 during a callback.

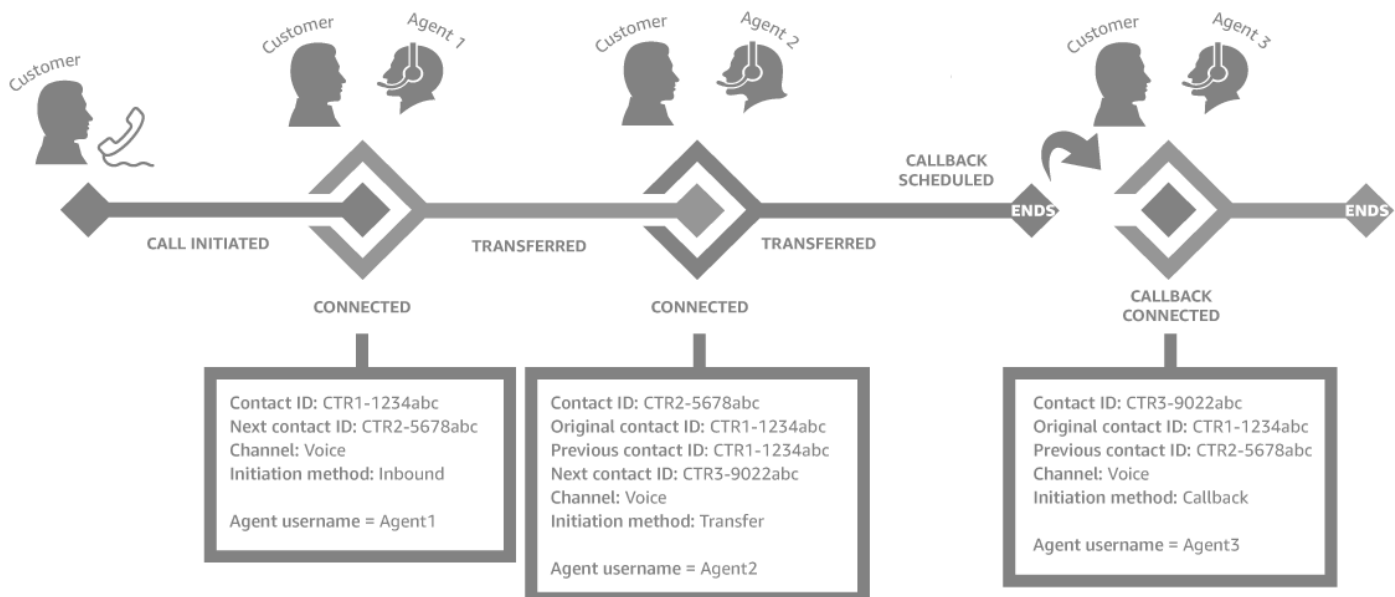

Each time a contact is connected to an agent, a new contact record is created. The contact records for a contact are linked together through the contactId fields: initial, next, and previous.

For more information, see [About contact states](#).

Multi-party calls: Add additional participants to an ongoing call

You can add up to **4** additional participants to an ongoing customer service call, for a total of **6** participants.

By using quick connects or your number pad, you can add other agents, supervisors, or external participants.

For example, to help close a mortgage transaction, an agent at a financial services company can add a mortgage broker, the customer's spouse, a translator, and a supervisor to the call to help resolve any issues quickly.

For information about how multi-party calls differ from the default three-party calls, see [Comparison: Three-party and multi-party calls](#).

Important things to know

- This feature is only available in CCPv2 and custom CCP using Amazon Connect Streams.js.
- **IT administrators:**
 - Before enabling the multi-party calls feature, if you are using Contact Lens or planning to do so in the future, see [Multi-party calls and Contact Lens](#). Contact Lens supports calls with up to 2 participants. We recommend that you disable Contact Lens in the [Set recording and analytics behavior](#) block for contacts that are expected to have 3 and more participants.
 - By default, there can be three participants on a call (for example, two agents and a caller, or an agent, a caller, and an external party). Before enabling multi-party calling, see [Comparison: Three-party and multi-party calls](#). To enable agents to connect up to six parties on a call, see [Update telephony options](#).
- **Developers:** In custom CCPs, use the updated Amazon Connect Streams API to enable multi-party calling, up to six parties. See the [Amazon Connect Streams](#) documentation on GitHub. Before enabling multi-party calling, see [Comparison: Three-party and multi-party calls](#).
- **AWS GovCloud (US-West):** You can't enable this feature using the console user interface. Instead, use the [UpdateInstanceAttribute](#) API or contact AWS Support.

How to add participants to a multi-party call

1. The following image shows the contact and you (the agent) on a call. The customer always appears at the top.

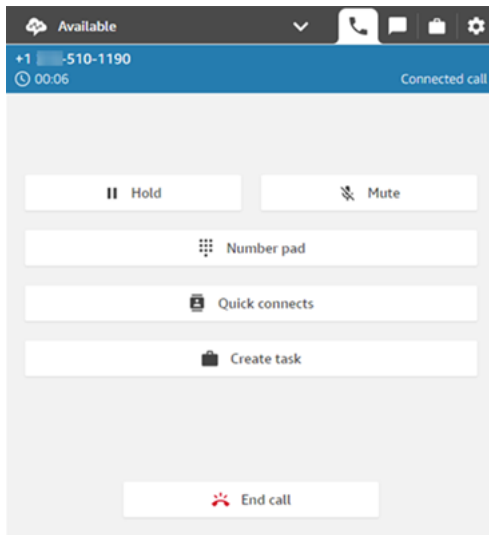

2. While you're connected to the contact, choose **Quick connects** to add another agent or the **Number pad** to make an external call. The caller is put on hold while you do this.
3. When you add the third participant to the call, you can greet and talk to them before adding them to the call (for example, tell them why you are adding them to the call).

The following image shows what the CCP looks like when you add a third participant to the call. The contact is on hold, and you're talking to the third party. Choose **Join** to take all parties off hold. Or, choose **Swap** to toggle between the parties on hold and the party you just called.

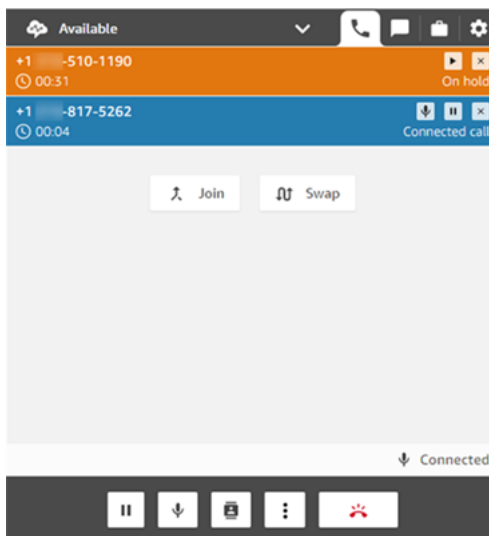

Note

Swap is only available when there are three parties on a call (for example, you, the caller, and another agent or external party). It is not available when there are more than three parties on the call.

- When there are multiple agents on the call (for example, three agents and a caller), all agents on the call can view all parties and have the option to put any participant or another agent on hold, mute, and disconnect participants from the call.

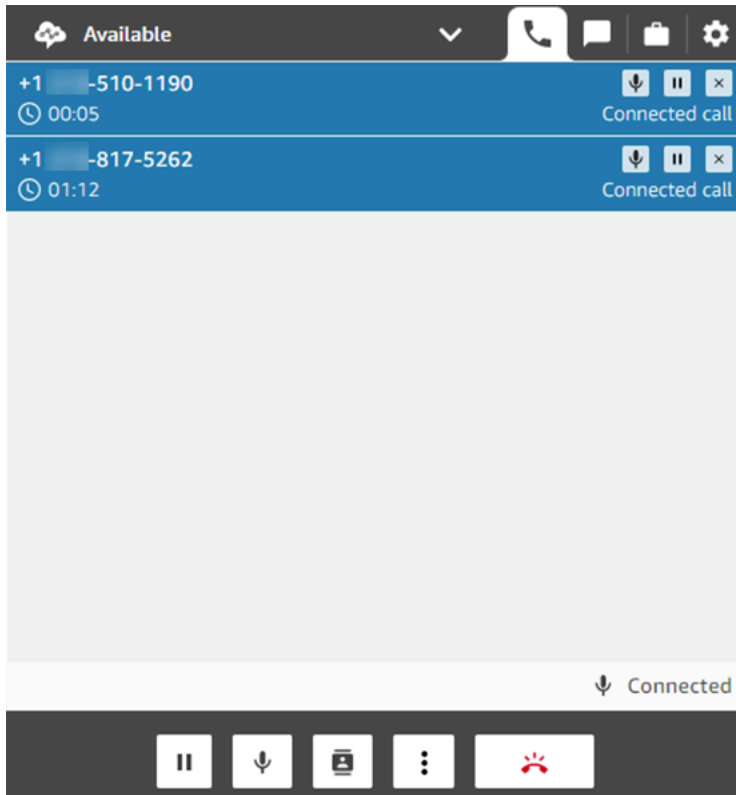

All agents and supervisors on the call can mute, hold, and disconnect other participants on the call.

- Every time you add a new participant to the call, you are prompted to greet and talk to them before adding them to the call. Choose **Join** to take all parties off hold.

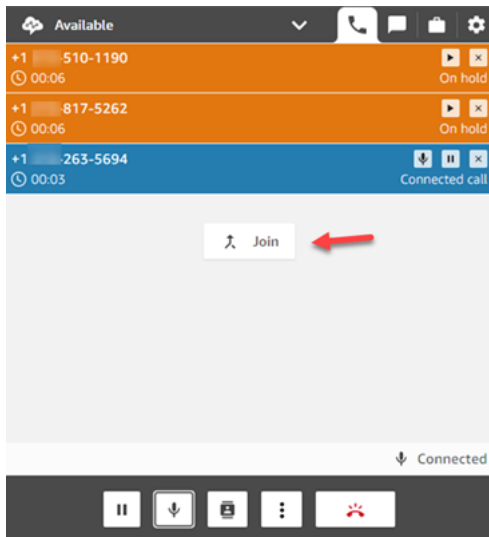

How to manage participants

Every agent on the call has access to the controls next to each participant's number to mute, hold, or disconnect individual participants.

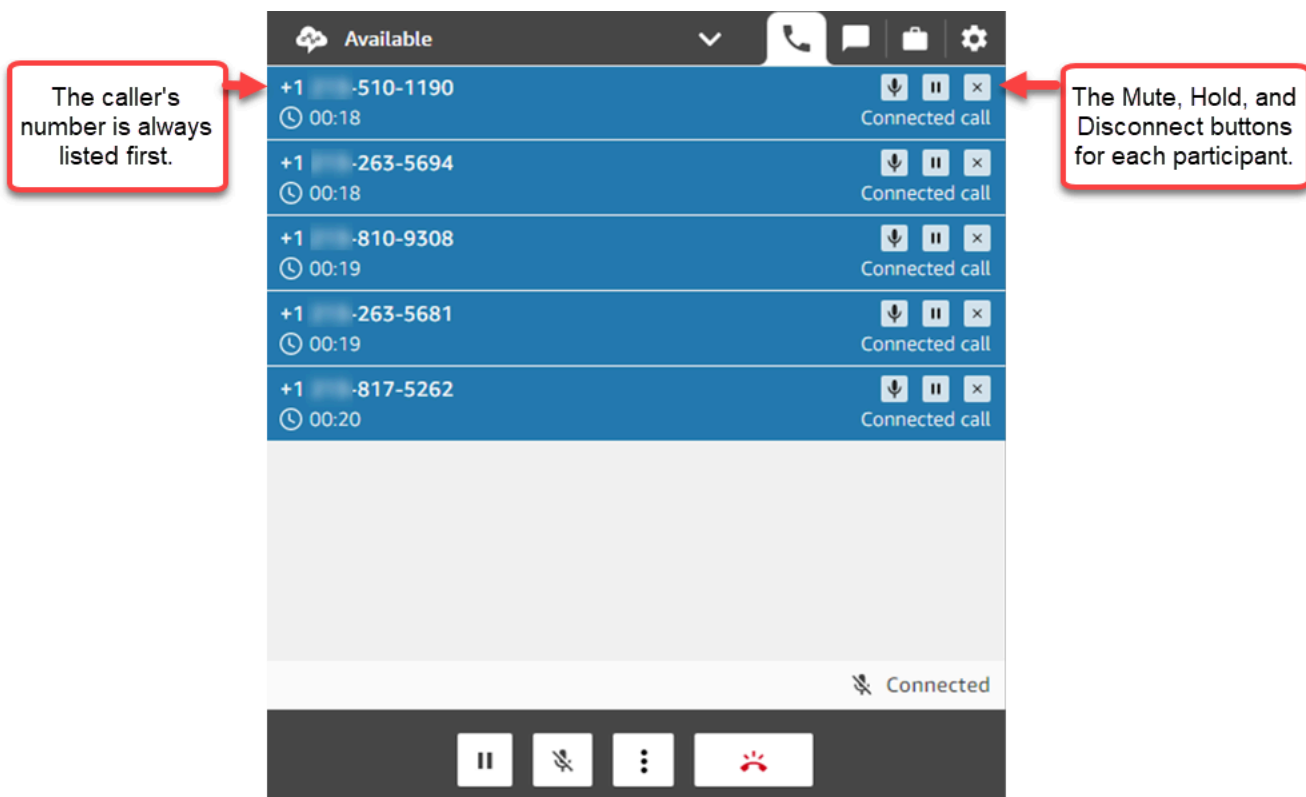

You can transfer a multi-party call to another agent, or disconnect yourself from the ongoing call.

Choose the **More** button to open the number pad and to create a task:

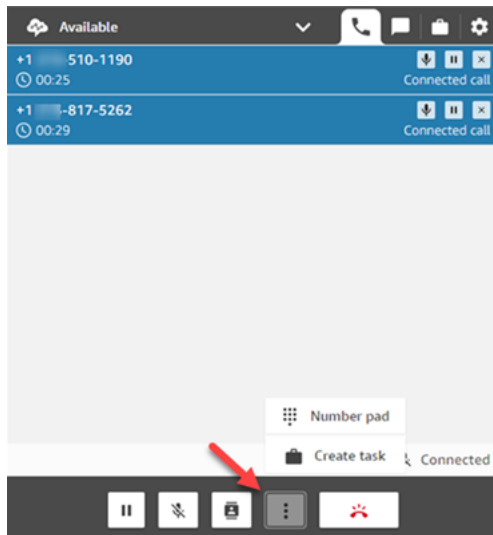

When do multi-party calls end?

A multi-party call stays up as long as the caller or the agent is on the call. For example, add an external party to a call and then you disconnect. The caller and external party continue the call.

If only third-parties are left on the line, the contact is terminated. However, as the agent you can choose to disconnect and allow only the caller and the third-party participants to remain on the call.

How to use the CCP to make outbound calls

Before you can make an outbound call, your contact center must be set up to allow agents to make calls. For more information, see [Step 3: Set telephony](#) in [Create an Amazon Connect instance](#).

For information about the caller ID that's displayed when you make an outbound call, see [Set up outbound caller ID](#).

Note

IT administrators: For a list of countries available for outbound calls based on the Region of your instance, see [Amazon Connect pricing](#). If a country is not available in your dropdown menu, open a ticket to add it to your allow list. For more information, see [Countries you can call by default](#).

To make an outbound call

1. In your Contact Control Panel, choose **Number pad**.
2. Use the dropdown menu to choose the country, then enter the number.

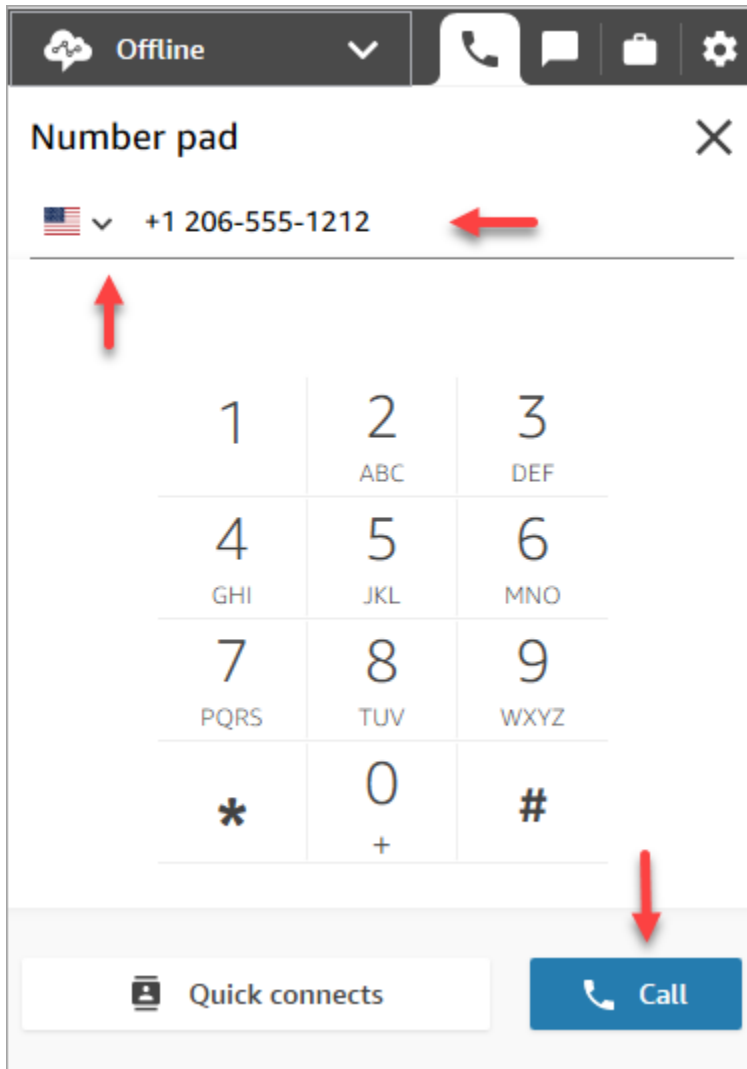

3. Choose **Call**.

View a call transcript during ACW

At the end of a call, you can see an unredacted transcript of your conversation in the CCP or agent workspace. You can view the entire transcript for reference, and copy any useful text into your notes.

The call transcript displays any [categories](#) identified by Contact Lens. For example, in the following image, an issue has been identified at 22 seconds.

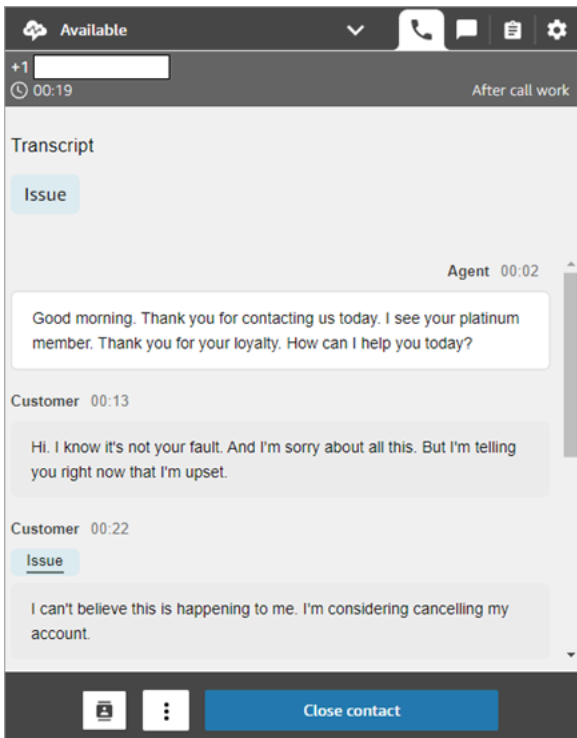

If a call is transferred to you from another agent, you will see an unredacted transcript of their conversation with the customer.

Customer sentiment score is not included in the CCP or agent workspace.

Note

IT administrators: This feature is available in the CCP and the agent workspace. To make this feature available to agents:

1. [Enable Contact Lens](#) for your Amazon Connect instance.
2. Add the following permissions to the agent's security profile:
 - **Analytics and Optimization - Contact Lens - Recorded Conversations - unredacted (Access)**
 - **Contact Control Panel (CCP) - Contact Lens data**

How to use the CCP to manage chats

The topics in this section explain how to use the Contact Control Panel (CCP) to manage chats.

Contents

- [How to use the CCP to chat with contacts](#)
- [Search for quick responses in CCP](#)
- [Transfer chats to another queue](#)
- [How to use the CCP to make a call while on a chat](#)

How to use the CCP to chat with contacts

When you set your status in the CCP to **Available**, Amazon Connect delivers calls or chats to you, based on the settings in your [routing profile](#). An administrator can specify that up to 10 chat conversations can be routed to you at the same time.

You can't initiate chat conversations from the CCP.

Note

IT Administrators: To enable customers and agents to send attachments, such as files, through the chat interface, see [Enable attachments to share files using chat and upload files to cases](#).

When a chat contact arrives, here's how you are notified:

1. If you enabled notifications in your browser, you'll get a pop-up notification at the bottom of your screen, like this:

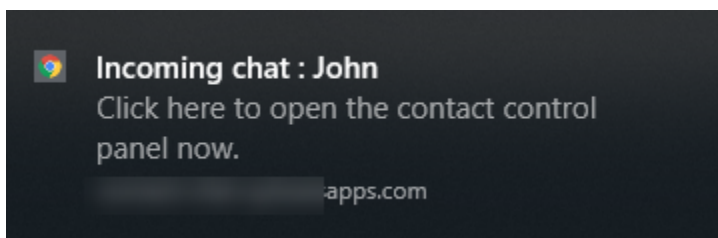

2. If you're on the chat tab, the page displays the name of the contact and a button for you to connect to the chat.

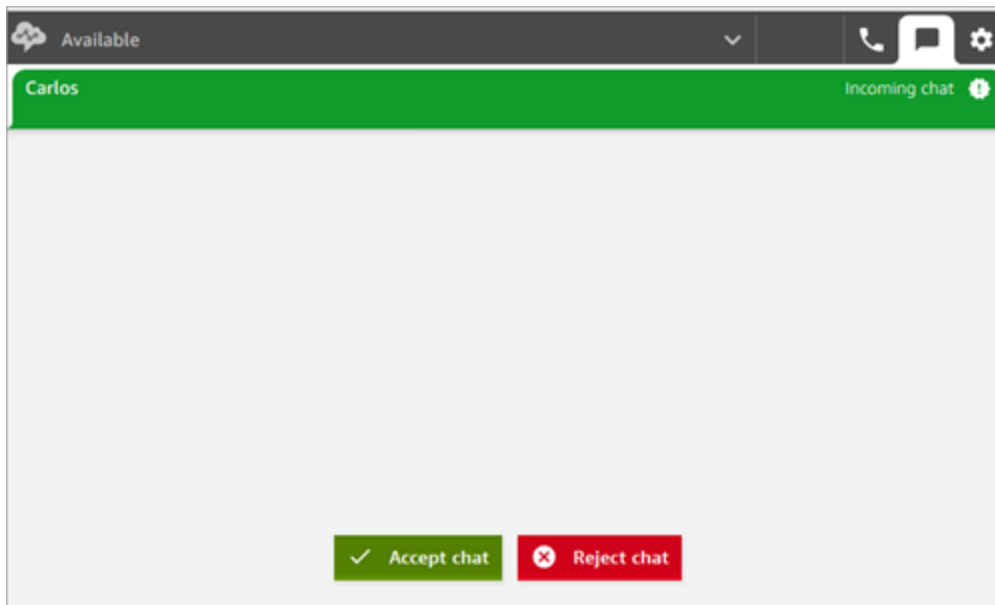

3. If you're on the phone tab, a banner displays the name of the contact and a button for you to connect to the chat.

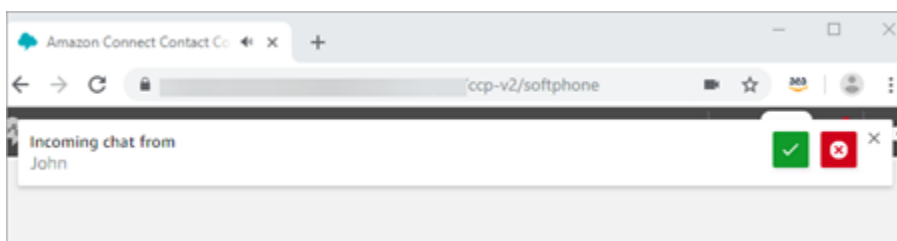

4. You have 20 seconds to accept or reject a contact. If you're on a chat, and another comes in but you don't accept it, a tab appears indicating the chat was missed.

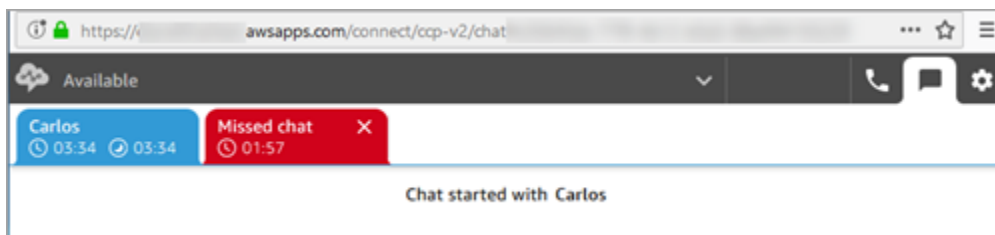

5. Choose **Accept chat** to connect to the contact.

Note

Chat conversations must be accepted manually. There's no auto-accept for these conversations.

6. You'll see the full transcript of what the contact has already typed. If applicable, you'll also see what a bot or another agent has entered. In the following image, **John** is the name of the customer, **BOT** is the Amazon Lex bot, and **Jane** is the name of the agent.

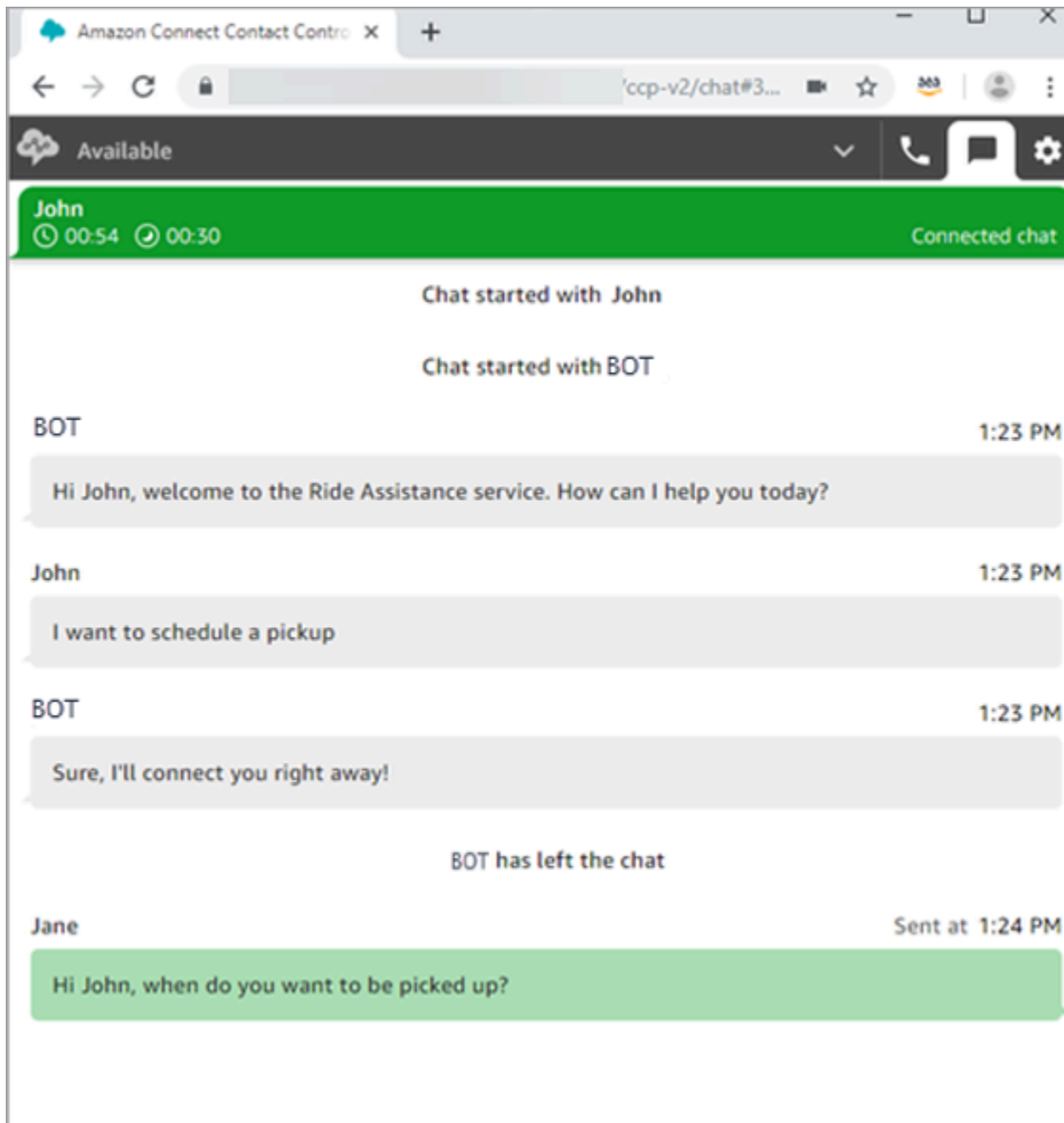

What do the timers at the top of the chat tabs mean?

When you're in a chat conversation with a contact, you'll see two timers at the top of the chat tab. These timers tell you:

- How long the contact has been connected to your contact center. This includes the time spent with the bot, if you're using one.

- How long since the last text was sent. This can be either from the customer to the agent, or from the agent to the customer. The timer is reset with texts message between the two. It is not reset with each consecutive text message sent from a participant.

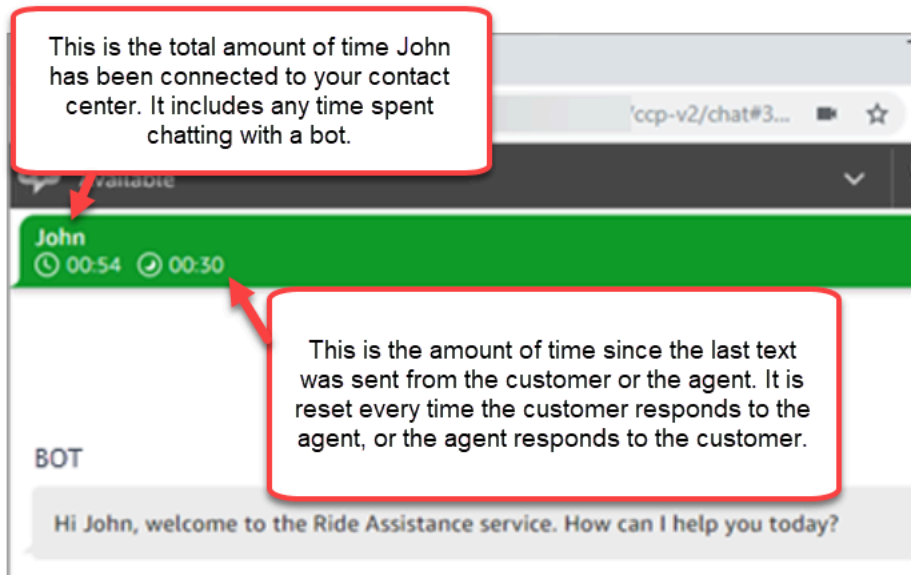

If you have multiple chat tabs open, an hour glass appears letting you know which ones are in an After Contact Work (ACW) state. The timer indicates how long the contact has been in ACW.

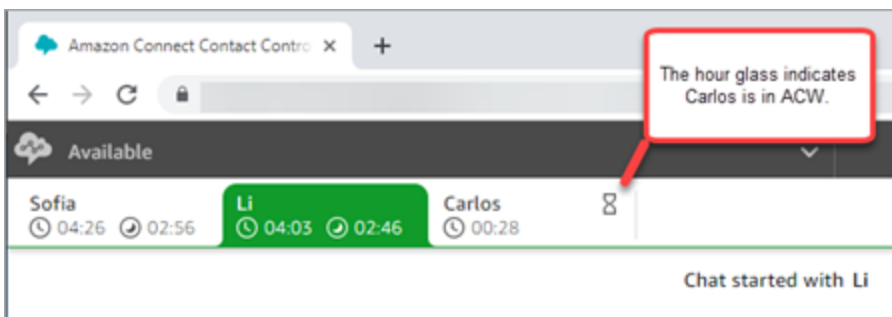

What happens to missed chats?

Let's say you take a break but forget to change your status in the CCP from **Available** to **Break**. Amazon Connect tries to route a chat to you for 20 seconds. Keep in mind that your admin can't configure this amount of time.

After 20 seconds, the contact is counted as [Agent non-response](#) in the real-time metrics report and the historical metrics report.

When you return from break and choose the chat tab, you'll see the missed contacts and how long they've been there. Each contact occupies a slot. With all of your slots are occupied, Amazon Connect won't route any more contacts to you. You must clear the missed contact so more contacts can be routed to you.

⚠ Important

If you're set up to handle contacts while already on another channel (for example, voice, chat, and task), you still must clear the missed contact before any other contacts on any other channel can be routed to you.

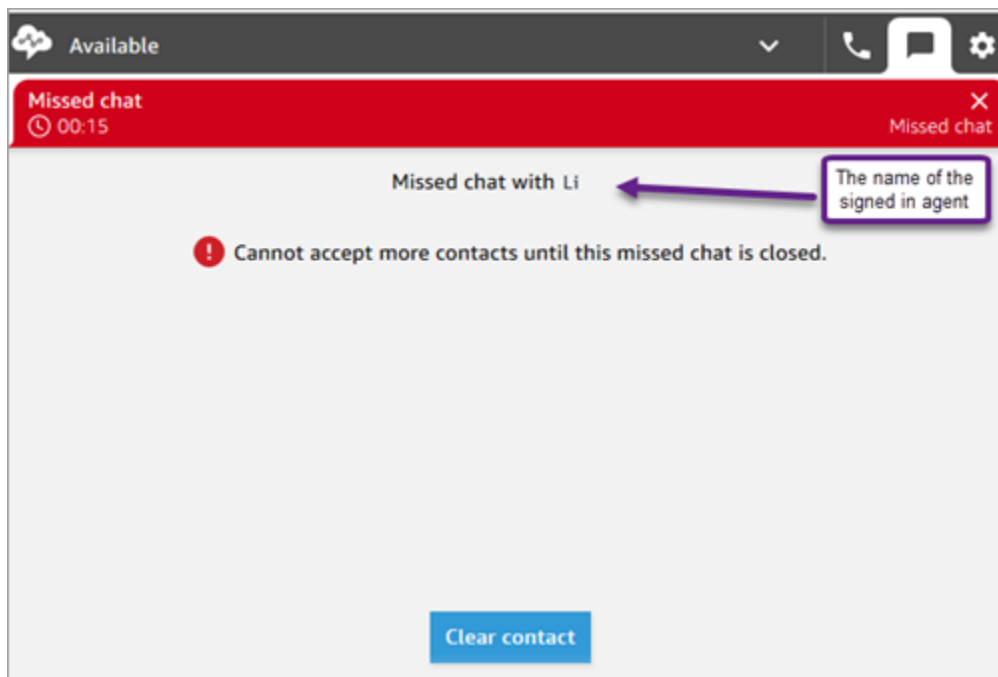

You can clear the slots so that chats are routed to you again. For each missed contact, choose the banner, and then choose **Clear contact**.

How to format messages

When composing a chat message, you have the ability to format your message. This enables you to add structure and clarity to your support messages. You can add the following formatting:

- Bold
- Italic
- Bulleted list

- Numbered list
- Hyperlinks
- Emoji
- Attachments

To get started, highlight the text you want to format, and then select a the formatting options from the toolbar at the bottom of the chat window. You can see exactly what the message looks like before sending it.

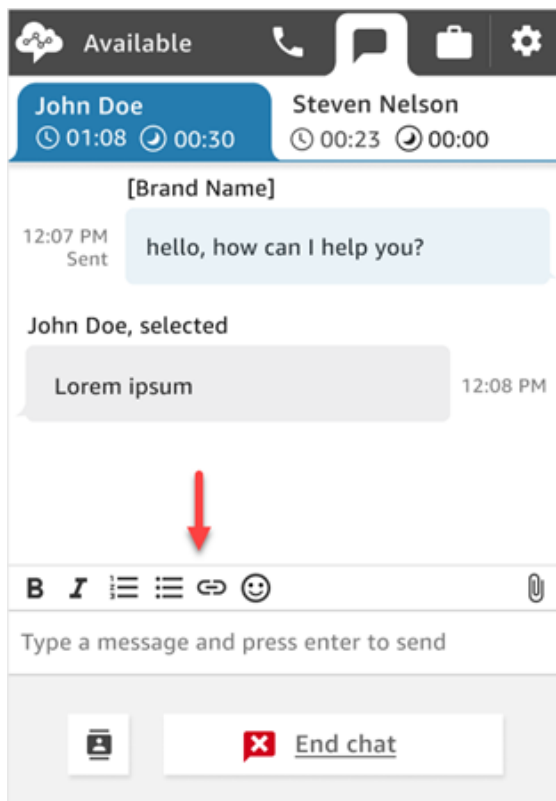

Tip

Developers: Enable this feature from the chat user interface. For instructions, see [Enable text formatting for your customer's chat experience](#).

Search for quick responses in CCP

Use either of the following methods to search for quick responses:

- Choose the star



icon in the rich text toolbar.

- Enter `/#` in the box used to compose messages.

Note

- The star icon only appears when contact is initiated.
- To see the star icon in CCP, you must have at least 1 activated quick response associated with the current agent routing profile.

The following image shows a quick response found by entering a shortcut (`/#G1`) in the agent application.

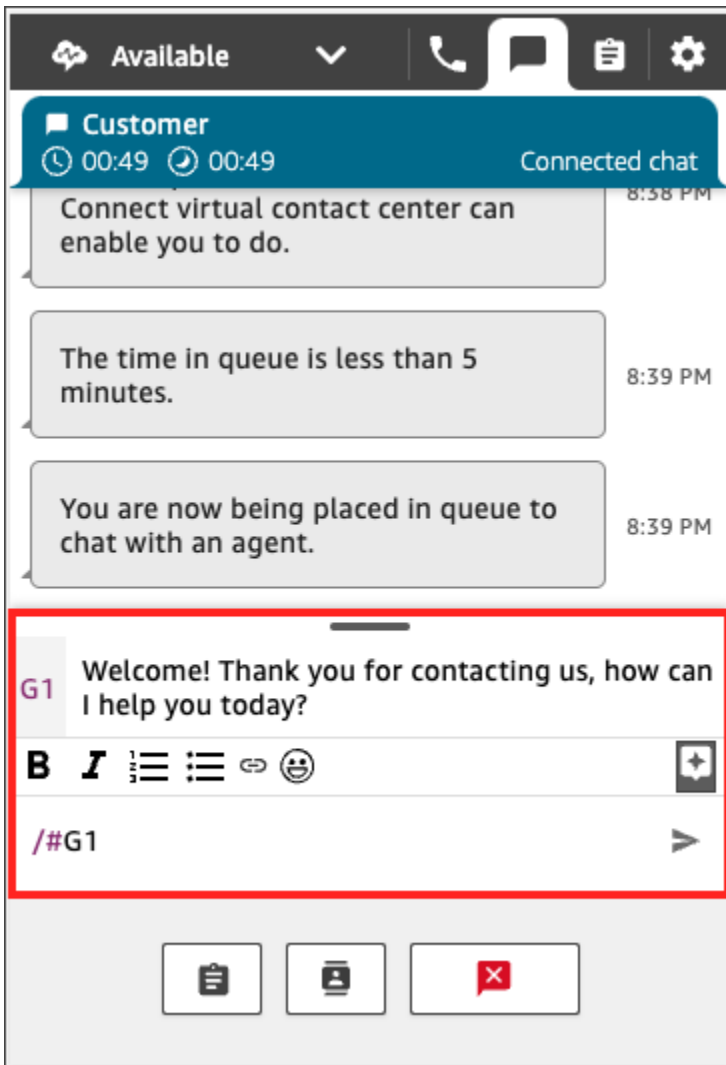

Transfer chats to another queue

When a chat is transferred from a bot to an agent, or from an agent to another queue, all context is preserved. This context lets the next agent read all previous messages in that contact.

To transfer a customer to another queue

1. Choose the **Quick Connect** button at the bottom of the CCP page.

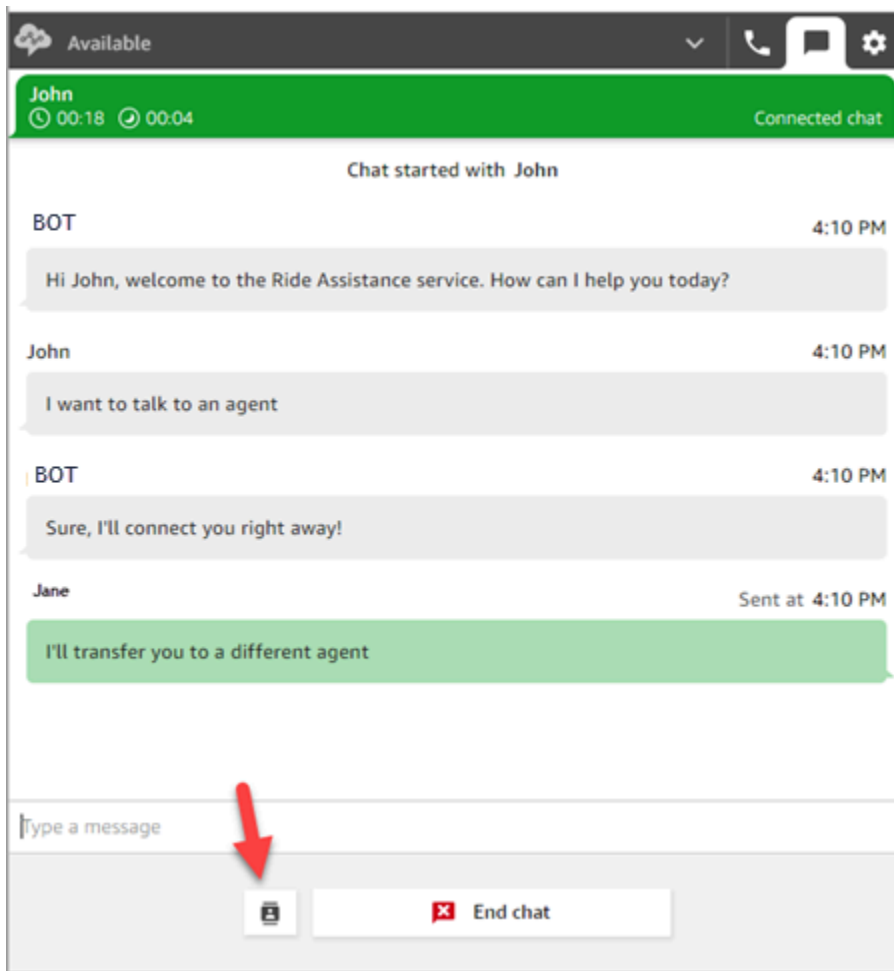

2. Choose or search for the queue you want to transfer to, and then choose the transfer button.
3. You'll see a confirmation message: Chat transferred. You're now doing After Contact Work (ACW) for the customer. Choose **Close** to end the contact.

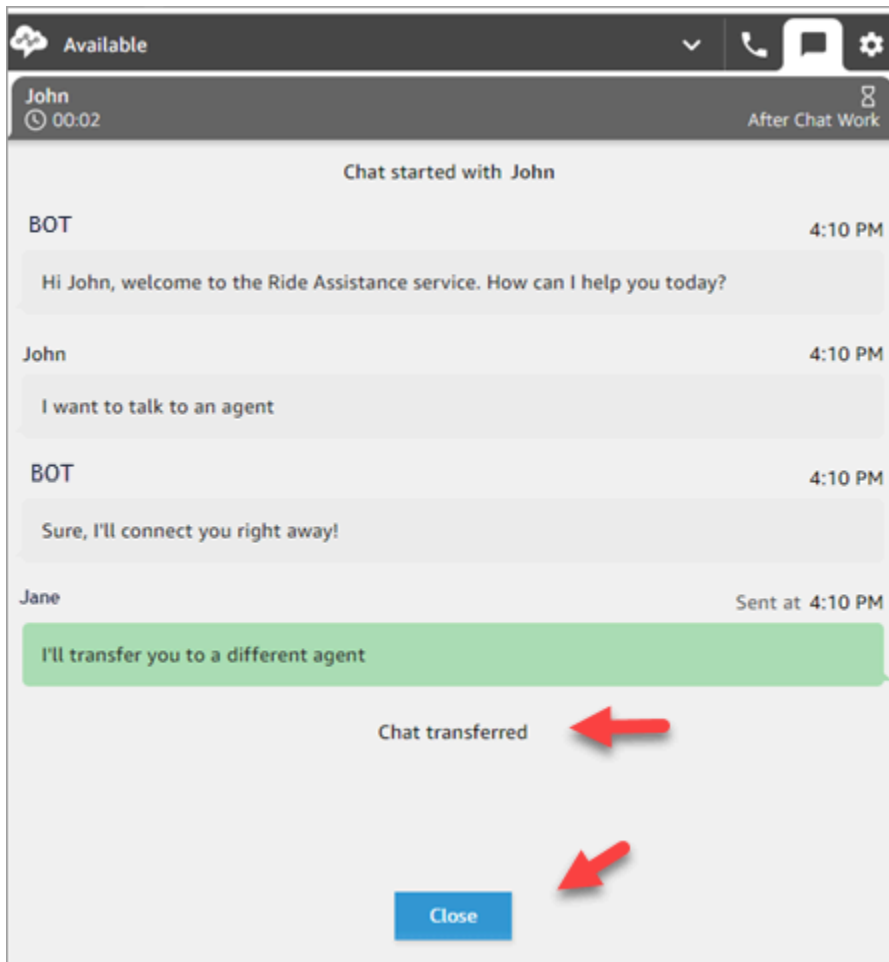

How to use the CCP to make a call while on a chat

Let's say you're chatting with a contact and you want to consult with someone else. While you're on a chat, you can use the updated CCP to make outbound calls using the number pad and [phone number quick connects](#).

Note the following limitation:

- You can't access agent quick connects while you're on a chat.
- Agents can receive calls while on a chat only if they are assigned to a routing profile that allows [cross-channel concurrency](#).

To make an external call while you're on a chat

1. In the CCP, choose the phone tab.

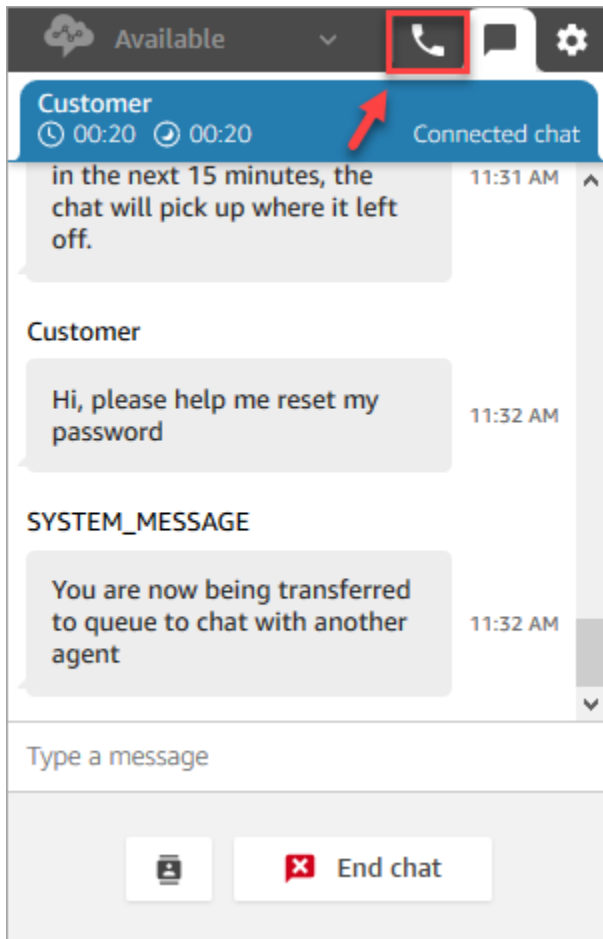

2. Choose **Number pad**.



3. Enter the external number you want to call, and then choose **Call**.

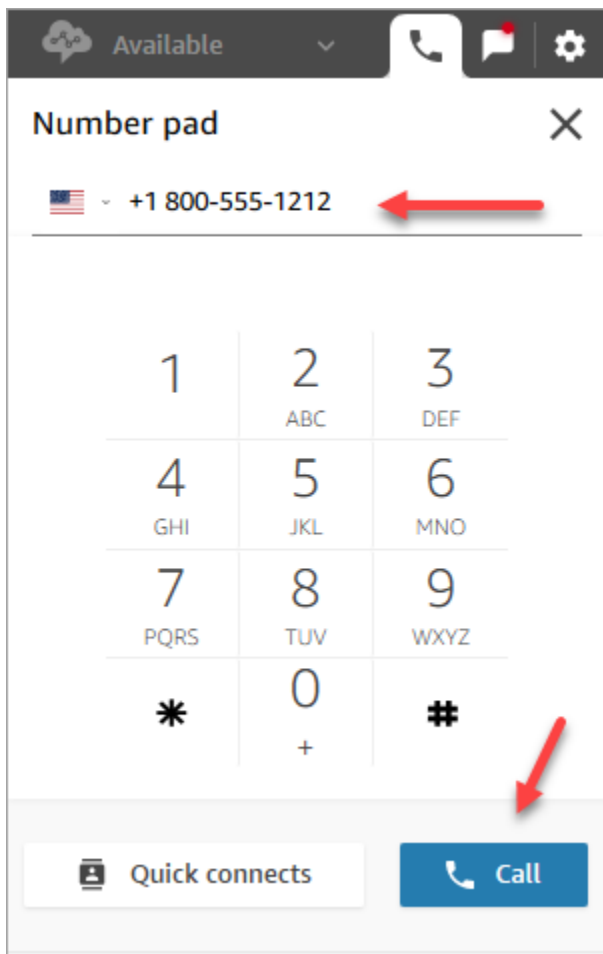

4. You'll be connected to the call at the same time the chat is still ongoing, as shown in the following image.

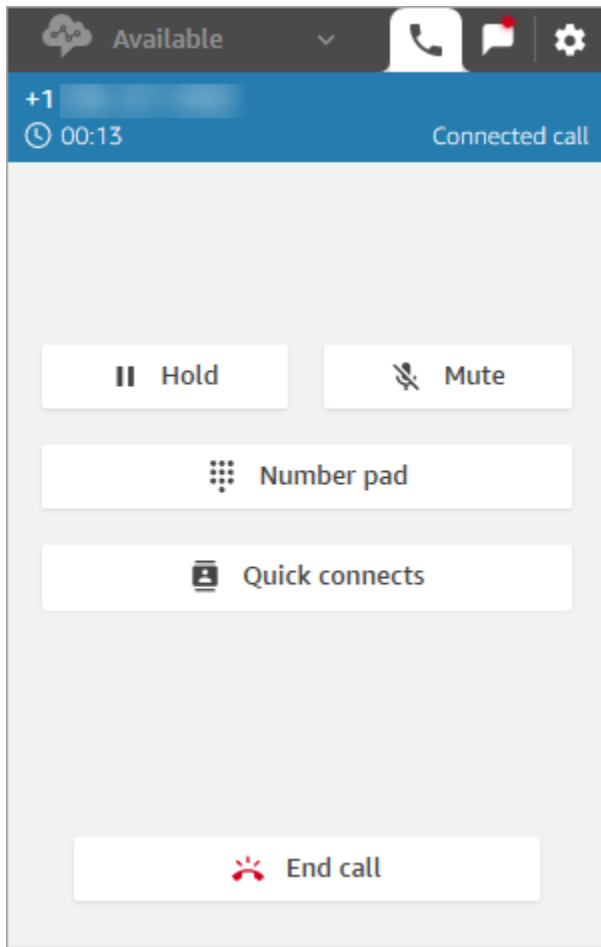

5. To go to the chat conversation while you're on the phone, choose the chat tab.
6. To end the phone conversation, choose the phone tab, choose **End call**, and then choose **Clear contact**. You're still connected to the chat conversation.

Can't make outbound call to another agent

If you're on a chat and having trouble making an outbound call to another agent, it could be because that agent's routing profile is not set up to allow them to take calls while on a chat or task contact. They need to be assigned to a routing profile that allows [cross-channel concurrency](#).

Can't see phone number quick connects in the CCP

[Agent quick connects](#) are not visible in the CCP while you're on a chat.

If you can't see [phone number quick connects](#) in your CCP, however, check that the phone number quick connect has been added to your queue as described in [Step 2: Enable agents to see quick connects](#).

Enable agent quick connects for calls during a chat

To enable agents to consult over the phone with each other while they are on chats, your Amazon Connect administrator needs to set up a direct dial number (DID) that routes to the agent. This configuration incurs additional costs.

How to use the CCP to work with tasks

The topics in this section explain how to use the Amazon Connect Contact Control Panel to manage tasks.

Contents

- [Accept a task](#)
- [Create a new task](#)
- [Transfer a task](#)

Accept a task

1. Whenever you set your status in the CCP to **Available**, Amazon Connect can deliver tasks to you, based on the settings in your [routing profile](#).

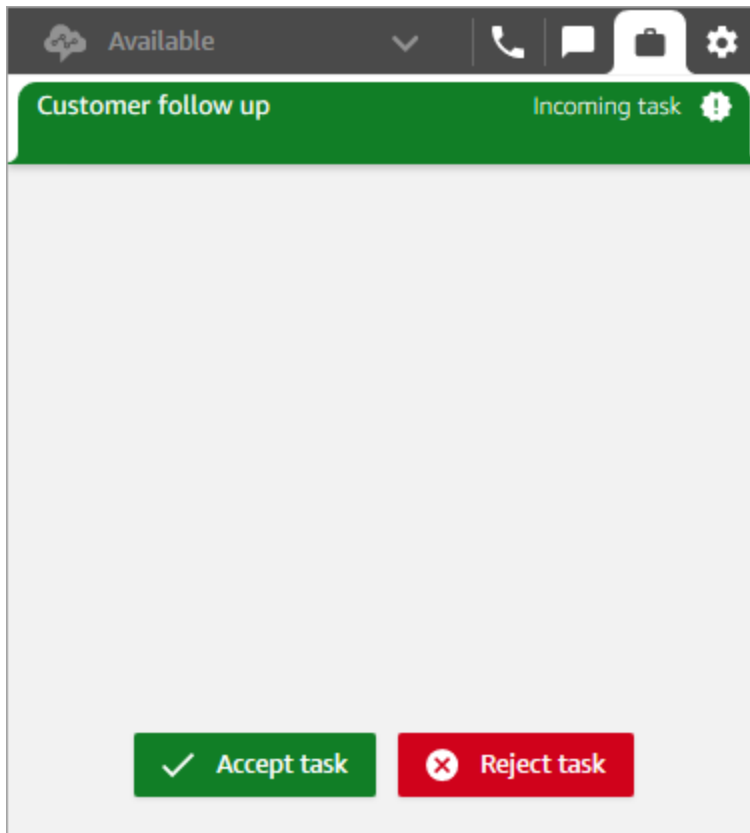

2. When a task arrives, choose **Accept task**. You have up to 30 seconds to accept a task (10 seconds more than accepting a call or chat).
3. Review the description of the task, and choose the links as needed to complete the task.

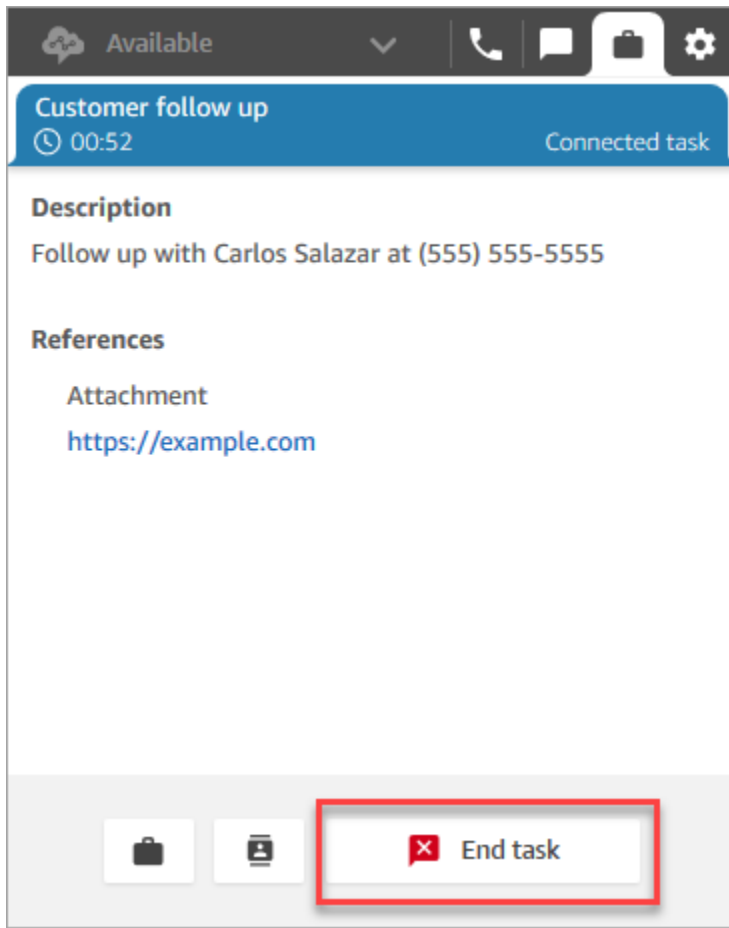

4. When you've completed the task, choose **End task**.
5. You will then be in ACW. When finished, choose **Close contact**.

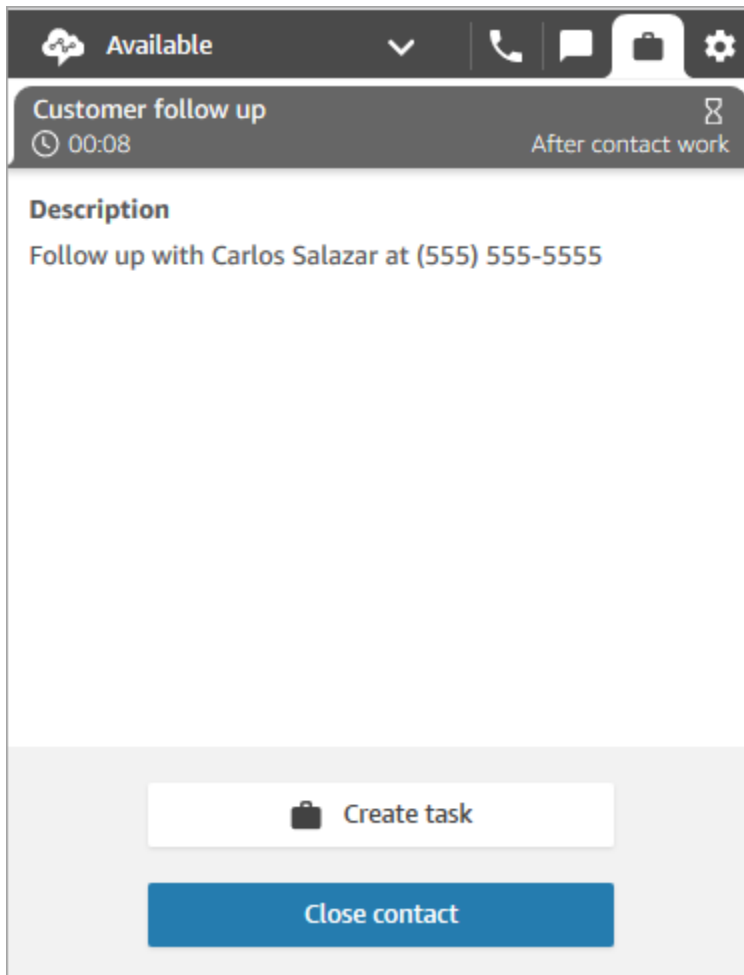

Create a new task

You can create a task any time, even when your status is Offline. And you can assign a task to anyone who has a quick connect, including yourself.

You can create a task, which starts the task immediately. Or you can schedule the task to start on a future date and time.

1. Open the CCP. Select the **Task** tab, and then choose **Create task**.

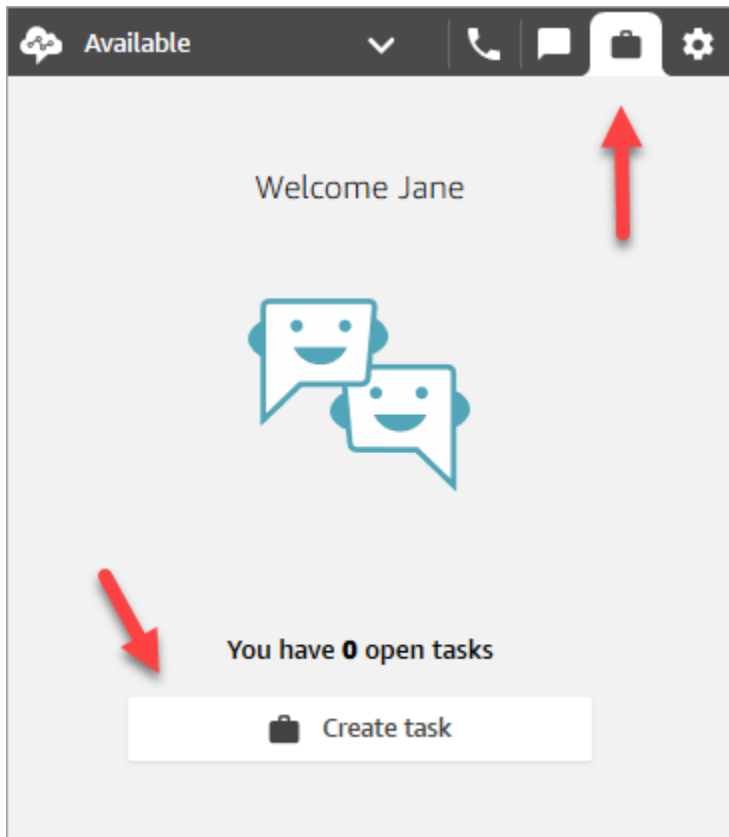

2. Complete the **Create task** page. When you choose **Assign to**, you can assign a task only to someone or a queue that has quick connect.

Choose **Create**.

CCP only

The following image shows the option to create a task in the CCP.

Create task

Task name
Customer follow up
18 / 150

Description Optional
Follow up with Carlos Salazar at (555) 555-5555
47 / 4096

References

Reference name
Attachment

Link
https://example.com

[Add reference](#)

Assign to
Jane Doe's quick connect

Scheduled date / time Optional

Date

Time
: AM Select time zone

Cancel **Create**

3. If you chose yourself, the task is routed to you. Choose **Accept task**.

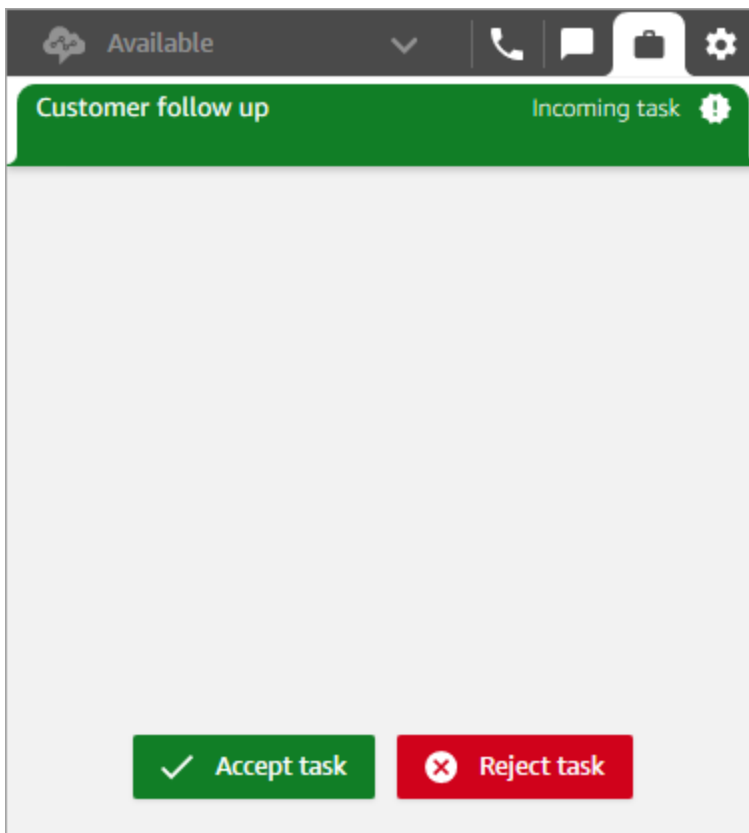

Create a scheduled task

You can schedule a task to start on a future date and time.

1. Complete the steps to create a task. For example, add a **Task name** and **Assign to** a quick connect.
2. In the **Scheduled date / time** section, choose a future date and time, and specify the timezone. You can schedule a task up to six days in future.
3. If you want to clear all values in the **Scheduled date / time** section and start over, choose **Clear scheduled date / time**.

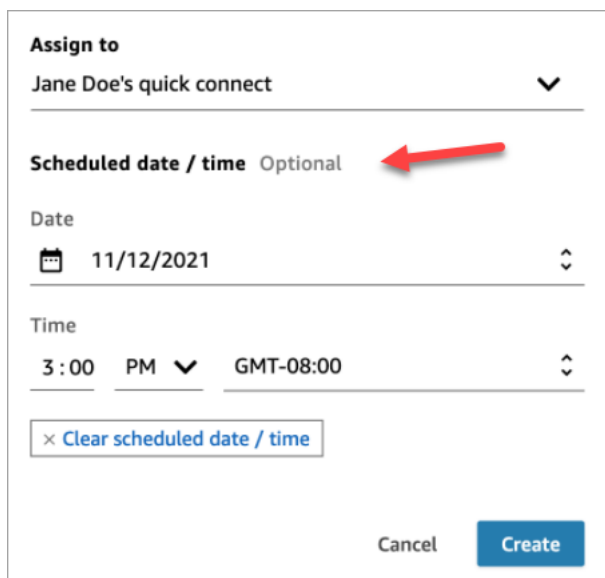

The screenshot shows a form for creating a task. At the top, there is a dropdown menu labeled 'Assign to' with the value 'Jane Doe's quick connect' and a downward arrow. Below this is the 'Scheduled date / time' section, which is marked as 'Optional' with a red arrow pointing to it. The 'Date' field is set to '11/12/2021' and the 'Time' field is set to '3:00 PM GMT-08:00'. At the bottom of the form, there is a 'Cancel' button and a blue 'Create' button. A button labeled 'x Clear scheduled date / time' is also visible.

Transfer a task

You can transfer a task that's assigned to you to another agent or queue.

1. Open the task you want to transfer, and then choose the quick connect icon.

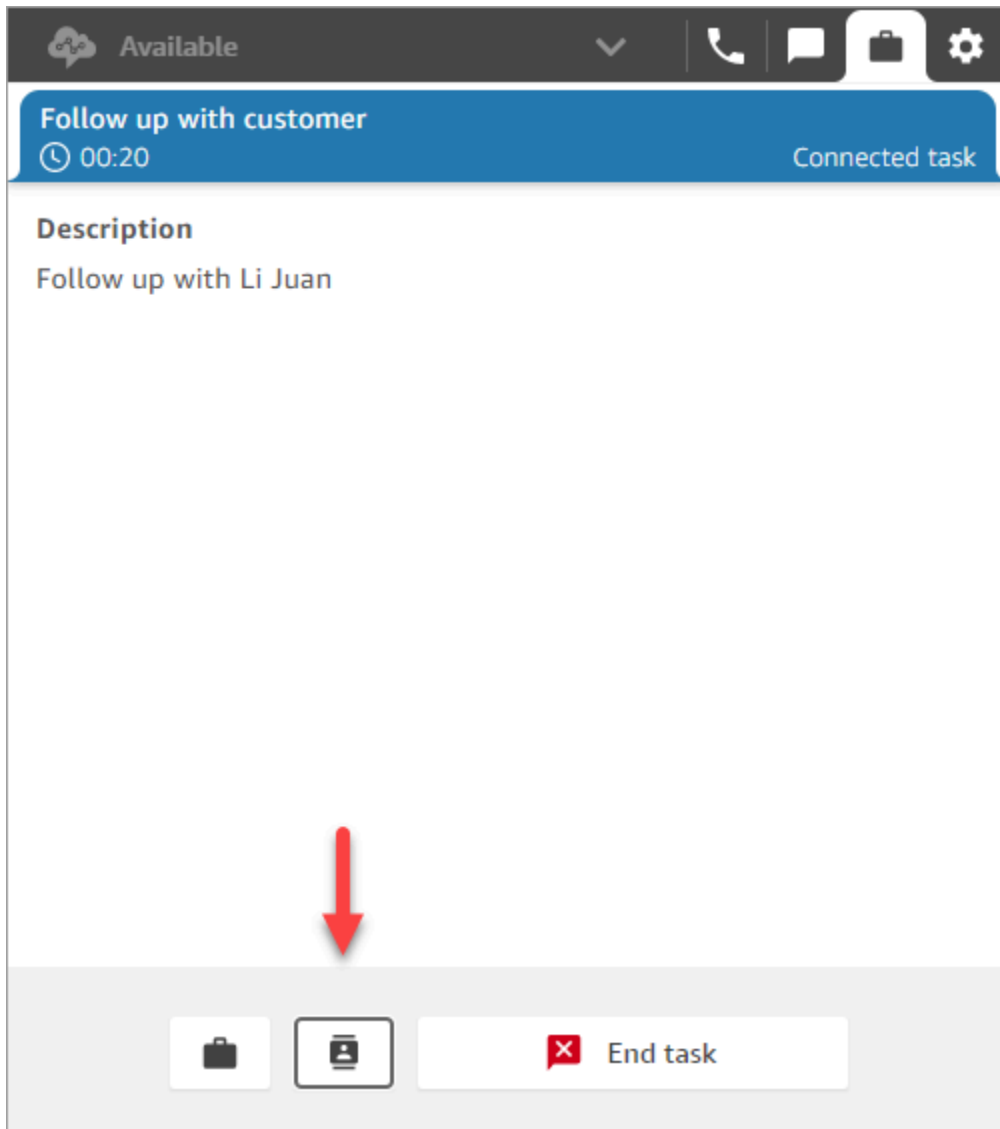

2. Choose from the list of people or destinations listed under **Quick connects**, and then choose the transfer icon.

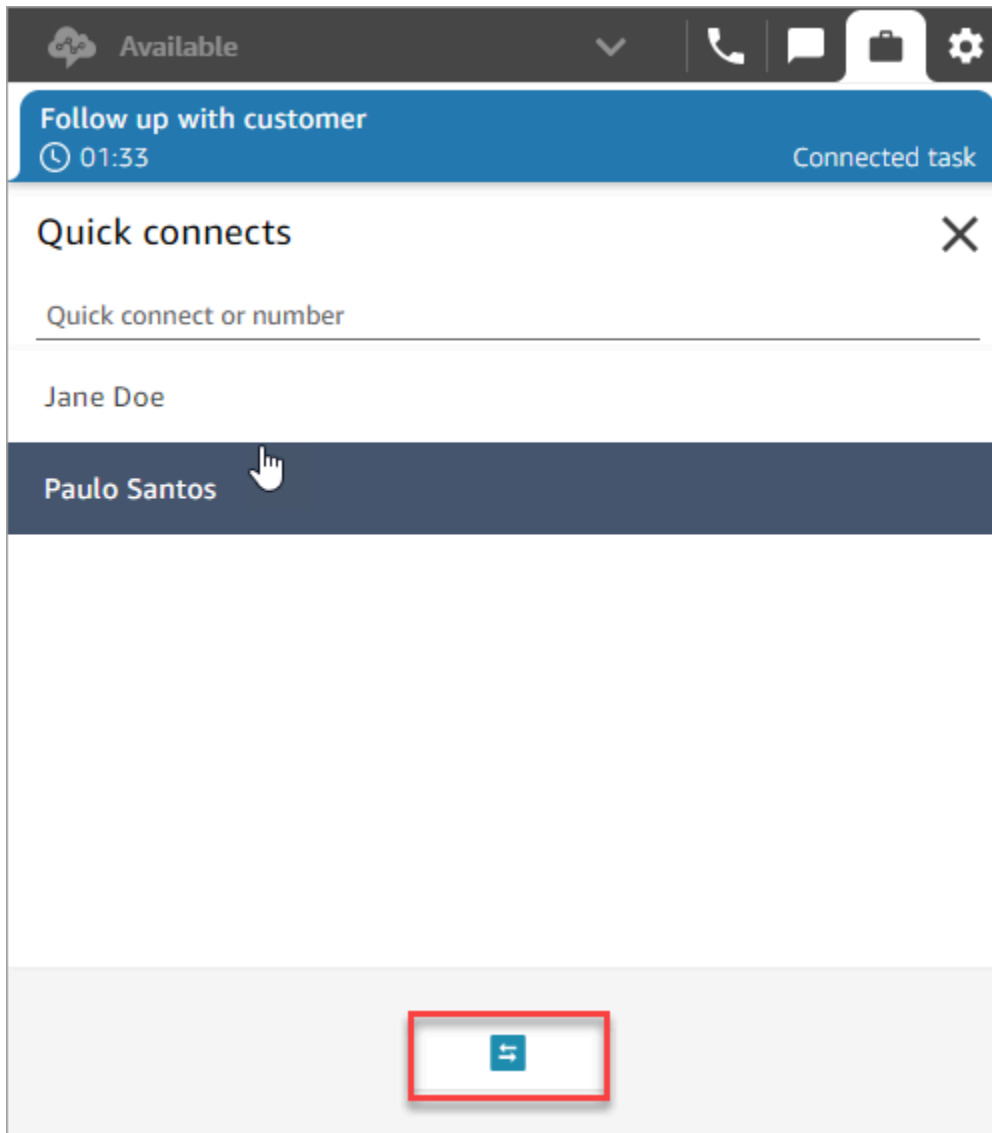

Use Customer Profiles in the agent workspace

To help agents deliver more efficient and personalized customer service, Amazon Connect enables you to combine information from external applications, such as Salesforce, Zendesk, ServiceNow, or other Customer relationship management (CRM) products, with contact history from Amazon Connect. This creates a customer profile that has all the information agents need during customer interactions in a single place.

With a single view of customer information including their product, case, and contact history, agents can quickly confirm the customer's identity and determine the reason for the call or chat.

Currently, Amazon Connect Customer Profiles can be used in compliance with [GDPR](#) and is pending additional certifications held by Amazon Connect.

The following image shows the agent workspace; for the purposes of this documentation, an Amazon Connect Customer Profiles image is featured. The agent workspace is designed for efficient multi-tasking, enabling simultaneous handling of calls, chats, and tasks, while providing quick access to customer profile information all within the same browser window.

The screenshot displays the Amazon Connect agent workspace. On the left, there is a chat window for Sofia Martinez with a message: "This is an example of what the Amazon Connect virtual contact center can enable you to do." The main workspace shows the Customer Profile for Sofia Martinez, including fields for Full name, Profile ID, Phone number, Account number, Date of birth, Additional info, Email address, Gender, Mailing address, and Billing address. Below the profile information, there are four tabs: Cases, More information, Contact history, and Product Purchase History. The Cases tab is active, showing a table of recent cases.

Status	Reference Id	Title	Source	Updated date	More
open	06589632	Package missing	Connect Case	4/11/23	>>
closed	79440119	Order missing item	Connect Case	4/11/23	>>
open	88416438	Package Missing	Connect Case	4/11/23	>>

- Cases:** Status, reference Id, title, source, updated date, and more information related to cases ingested from 3P application such as Zendesk and ServiceNow, in addition to cases created and managed using Amazon Connect Cases.
- More information:** Additional information contained in the customer defined *Attributes* field of [the profile](#), as well as further profile information such as cell phone number and shipping address. This information will be sorted alphabetically to help an agent quickly locate the information they need.
- Contact history:** Date, times, and duration when this customer contacted your contact center in the past.
- Product purchase history:** All the assets purchased by a customer can be populated here. The data is ingested from an external app such as Salesforce or Zendesk that you've [integrated](#) with Customer Profiles.

Contents

- [Accept incoming contacts with Customer Profiles](#)
- [Create a new customer profile in the agent workspace](#)
- [Search for a customer profile in the agent workspace](#)

Accept incoming contacts with Customer Profiles

When a call or chat is connected to your Contact Control Panel (CCP), Amazon Connect Customer Profiles, in the same browser window, automatically populates the customer profile that may match the incoming phone number for a voice interaction and *Name* for a chat interaction.

Tip

You can change autopopulation behavior if you wish. For more information, see [Use contact attributes to autopopulate customer profiles](#).

Before agents can access customer profiles, the Amazon Connect administrator must enable the Customer Profiles feature, grant agents the appropriate permissions, and integrate Customer Profiles into your agent workspace. For more information, see [Enable Customer Profiles for your instance](#).

Contents

- [Example 1: Auto-populate the customer profile](#)
- [Example 2: Accept incoming contact, no customer profile found](#)
- [Example 3: Search when not on contact](#)
- [Example 4: Autopopulate results in multiple profiles found](#)

Example 1: Auto-populate the customer profile

As soon as Amazon Connect Customer Profiles matches the phone number (voice) or customer name (chat) with an existing customer profile, it automatically displays the profile even though you may not have accepted the contact yet.

The following image shows what your Contact Control Panel (CCP) may look like when there's an incoming chat. A customer profile has been found that matches the customer, and Amazon Connect is loading the data.

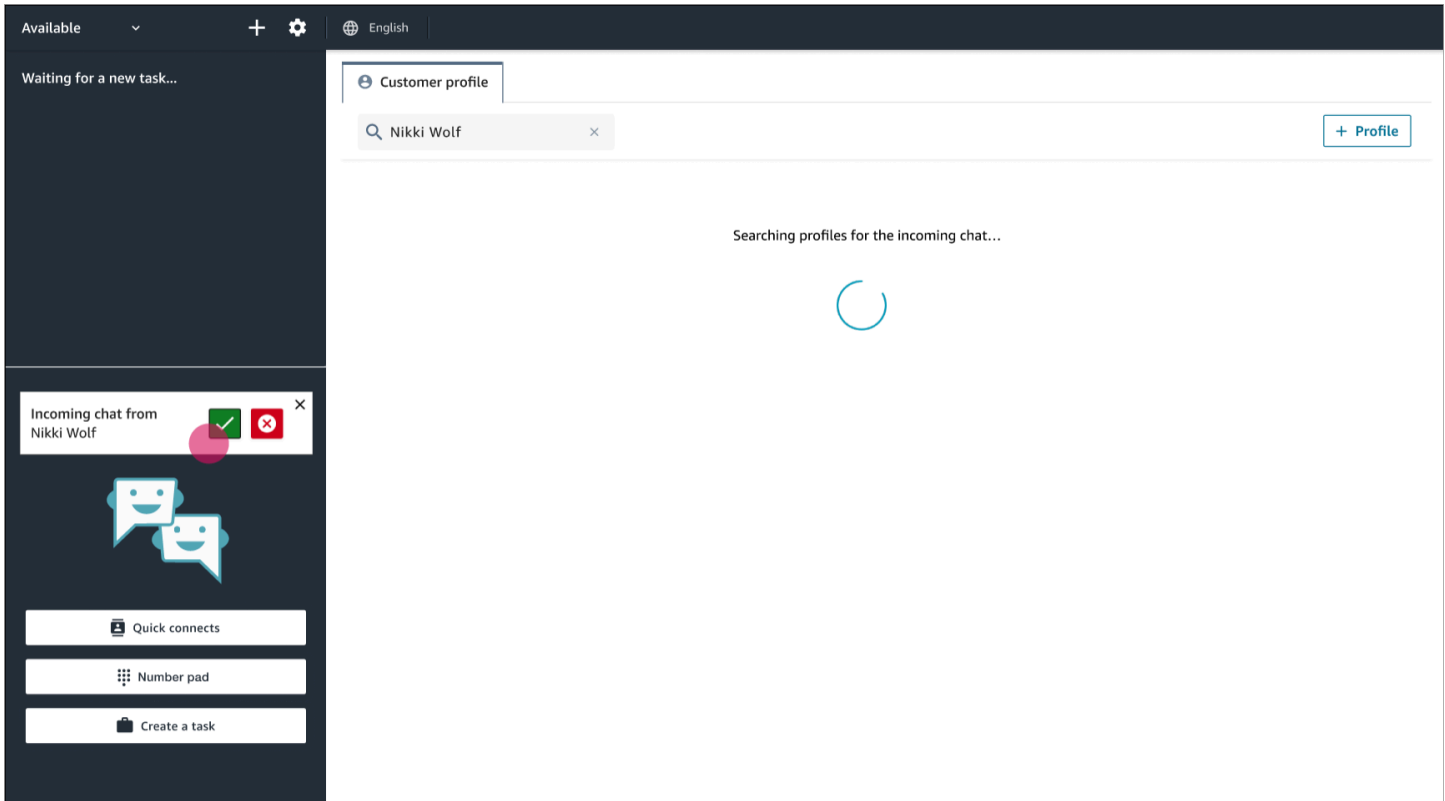

This next example shows what it might look like after you've accepted and joined the chat, and Amazon Connect displays the customer's profile. In this case, Amazon Connect found the customer's profile based on their email address. If this were a voice call, by default Amazon Connect would match the customer's profile based on their phone number. Your IT department can [customize](#) this behavior to search for the profile based on other information about the contact.

Available + English

Nikki Wolf 00:00 00:00

Customer profile

Nikki Wolf

1 result > Nikki Wolf

First name	Middle name	Last name	Edit	Associate
Nikki	-	Wolf		

Phone number: +1 212-555-5400

Account number: xxxxxx

Birthdate: 1978-07-09

Additional Info: Looking to purchase X

Email address: nikki.wolf@example.com

Gender: Female

Mailing Address: 123 Any Street, Any Town, USA

Billing Address: 123 Any Street, Any Town, USA

Product purchase history | Contact history | More information

Model name	Model number	Serial number	Purchase date
TFB89BLE	801F123689E3	TFB89BLE-1904-HL-001183	yyyy-mm-dd
TFB00BLE	000000000002	TFB00BLE-0000-HL-000002	yyyy-mm-dd
TFB00BLE	000000000003	TFB00BLE-0000-HL-000003	yyyy-mm-dd

Nikki Wolf Connected chat

Nikki Wolf

10:23 PM

10:24 PM

Type a message

End chat

- Choose **Associate** to associate the contact record of the current contact with the customer profile, and then choose **Confirm**.

The screenshot shows the Amazon Connect interface for managing customer profiles. At the top, there is a language selector set to 'English'. Below it, a search bar contains the text 'Nikki Wolf'. A search result is displayed, showing the following details:

First name	Middle name	Last name
Nikki	-	Wolf

Additional details for the contact include:

- Phone number: +1 212-555-5400
- Account number: xxxxxx
- Birthdate: 1978-07-09
- Email address: nikki.wolf@example.com
- Mailing Address: 123 Any Street, Any Town, USA

A 'Product purchase history' section is visible below the contact details, listing several items with model names like 'TFB89BLE' and 'TFB00BLE'.

A 'Confirm association' dialog box is overlaid on the contact details. It contains the following information:

First name	Last name
Nikki	Wolf

Additional details in the dialog box include:

- Email address: nikki.wolf@example.com
- Phone number: +1 212-555-5400
- Account number: xxxxxx
- Birthdate: 1978-07-09

The dialog box has a 'Cancel' button and a 'Confirm' button. A red arrow points to the 'Confirm' button.

- If you choose **Associate** by mistake, you can continue to browse other customer profiles, and associate the contact with a different customer profile. Or, if you have been [assigned Create permission](#), you can create a new profile.

You can associate a contact with customer profile multiple times during an interaction, including during After Contact Work (ACW) time. Only the most recent association remains, before you clear the contact.

Example 2: Accept incoming contact, no customer profile found

If no results are returned when a call or chat comes in, do the following:

1. Search for the customer's profile using any search key available in the search drop down menu. For example: phone, name, email, account id, or any [custom search terms](#) you specify. For example, if you have *Social security number* (SSN) defined as one of your identifiers, SSN will automatically be available as a search term for agents to use in the Agent Workspace.

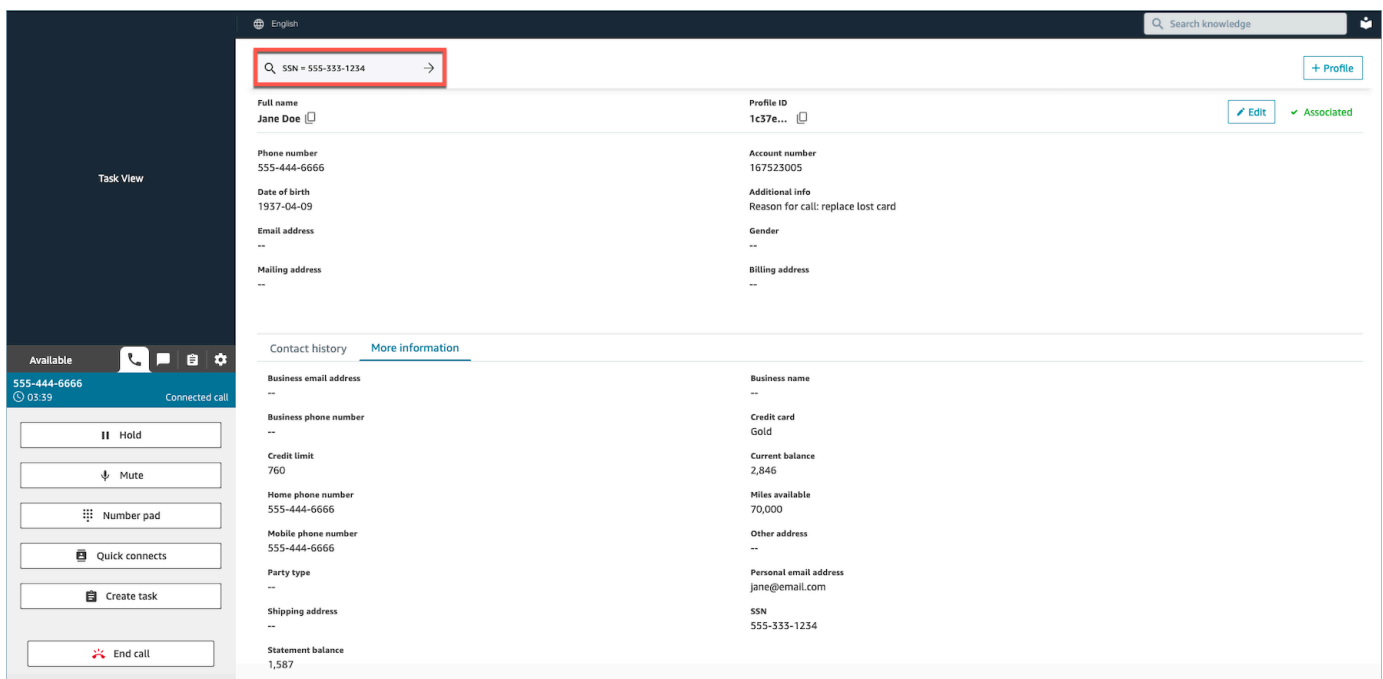
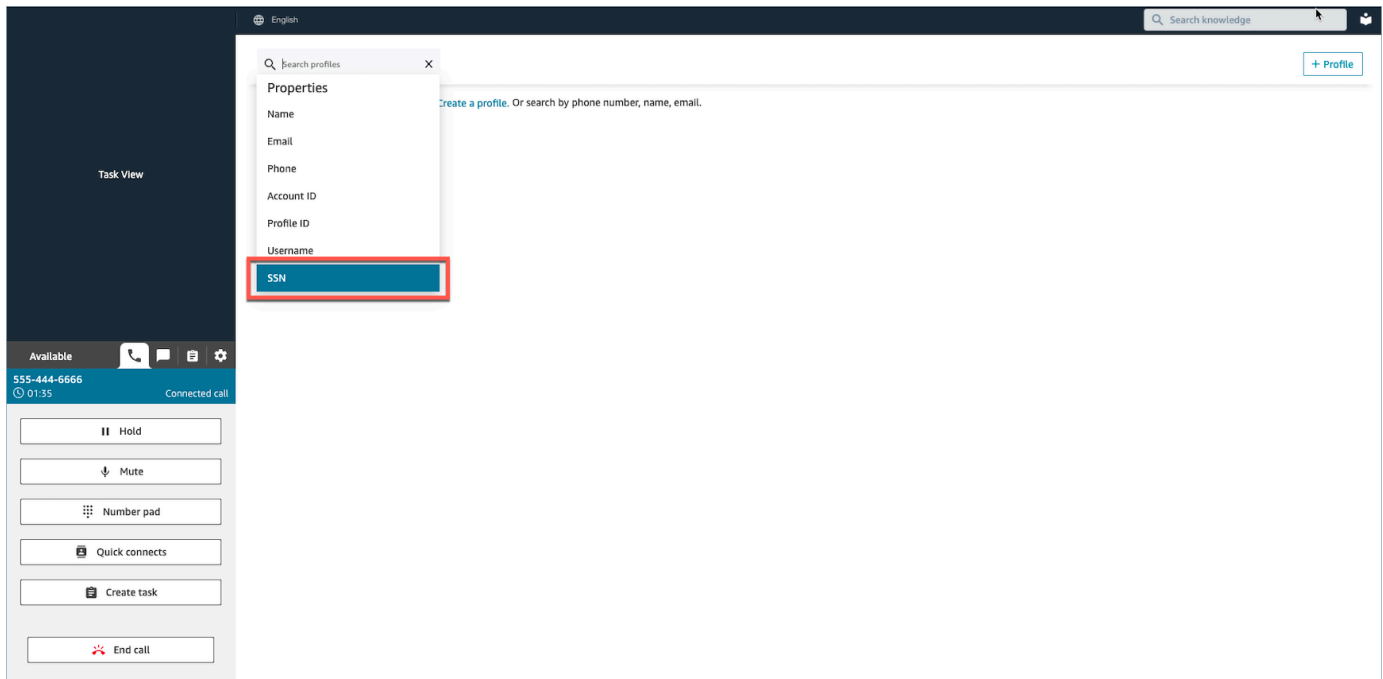

2. If no customer profile is found, [create a new profile](#) for the contact. The only required information is first name.

In the following image, the agent searched for **John Doe**. No matches were found so they chose **Create profile**.

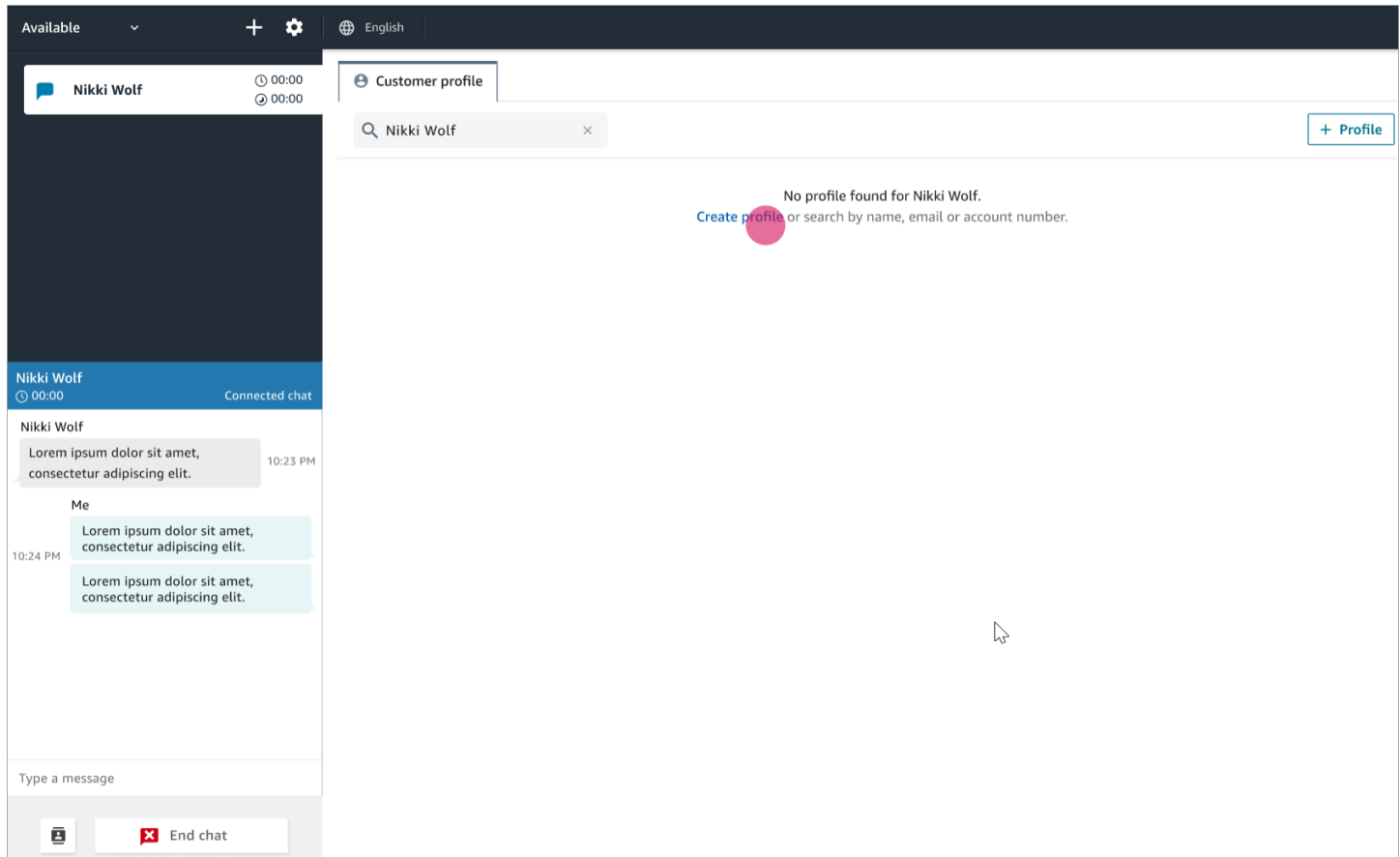

Example 3: Search when not on contact

When there are no incoming contacts, you can search for customer profiles using any search key available in search drop down menu. For example, phone, name, email, or account id. For example, you might want to use this time to search for previous contacts, or completing a profile.

Available + ⚙️ 🌐 English

Waiting for a new task...

Customer profile

Search profiles

+ Profile

Recently viewed profiles

Paulo Santos	+1 347-555-5200	paulo.santos@example.com	acctxxxxxx	Associate
Steve Kerr	+1 201-555-5201	steve.kerr@example.com	acctxxxxxx	Associate
Jorge Souza	+1 917-555-5202	jorge.souza@example.com	acctxxxxxx	Associate
John Doe	+1 646-555-5203	john.doe@example.com	acctxxxxxx	Associate
Li Juan	+1 401-555-5204	li.juan@example.com	acctxxxxxx	Associate

Welcome [Agent Name]

Quick connects

Number pad

Create a task

At any time, agents can search for customer profiles by name, email, or profile ID.

Example 4: Autopopulate results in multiple profiles found

In some cases, multiple profiles may be returned for the same call or chat. Use the profile information to verify the customer's identity. For example, ask the customer to verify their email address or account number, and then associate the contact with the right customer profile. Agents can also ask customers for additional information they can use in search and identify the right profile in order to associate it to the interaction.

The screenshot shows the Amazon Connect interface. At the top, there is a search bar with 'Jane Doe' entered and a '+ Profile' button. Below the search bar, there are 2 results in a table:

Name	Phone Number	Email Address	Account ID	Action
Jane Doe	+15554446666	janey@email.com	167523005	Associate
Jane Doe	333-222-9292	janedoe@email.com	1985043021	Associate

Below the search results, there is a chat window for 'Jane Doe'. The chat history shows:

- A system message: 'minutes.' (11:48 AM)
- A system message: 'You are now being placed in queue to chat with an agent.' (11:48 AM)
- A customer message: 'Hello, can you help me update my address?' (11:48 AM)

The chat input field contains the text 'Type a message and press enter to send' and an 'End chat' button.

This screenshot is similar to the one above, but the chat window for 'Jane Doe' has a new message:

- A customer message: 'Hello, can you help me update my address?' (11:48 AM)
- An agent response: 'Absolutely, I have a few accounts under your name, would you mind providing me with you Account ID?' (11:51 AM)

The search results table and the rest of the interface remain the same as in the previous screenshot.

The screenshot shows the Amazon Connect agent workspace interface. On the left is a 'Task View' sidebar with a 'Task View' button and a status indicator 'Available'. The main workspace is divided into a chat window and a customer profile window. The chat window shows a conversation between Jane Doe and Frances Smith. The customer profile window displays the following information:

- Account ID: 1985043021
- Multiple results > Jane Doe
- Full name: Jane Doe
- Profile ID: be7e2...
- Phone number: 333-222-9292
- Account number: 1985043021
- Date of birth: 1937-04-09
- Additional info: Reason for call: Update address
- Email address: janedoe@email.com
- Gender: --
- Mailing address: --
- Billing address: --

Below the profile information is a 'Contact history' table with columns: Timestamp, Channel, Queue Duration, Hold Duration, Call Duration, and Actions. The table contains the text 'No records found'. There are 'Edit' and 'Associate' buttons next to the Profile ID.

This screenshot is identical to the one above, but the 'Associate' button next to the Profile ID is now 'Associated', indicating that the customer profile has been successfully linked to the contact.

Create a new customer profile in the agent workspace

Let's say you're on a chat and there's no customer profile for the contact. You can create a new customer profile for them.

1. Choose **Create profile**.

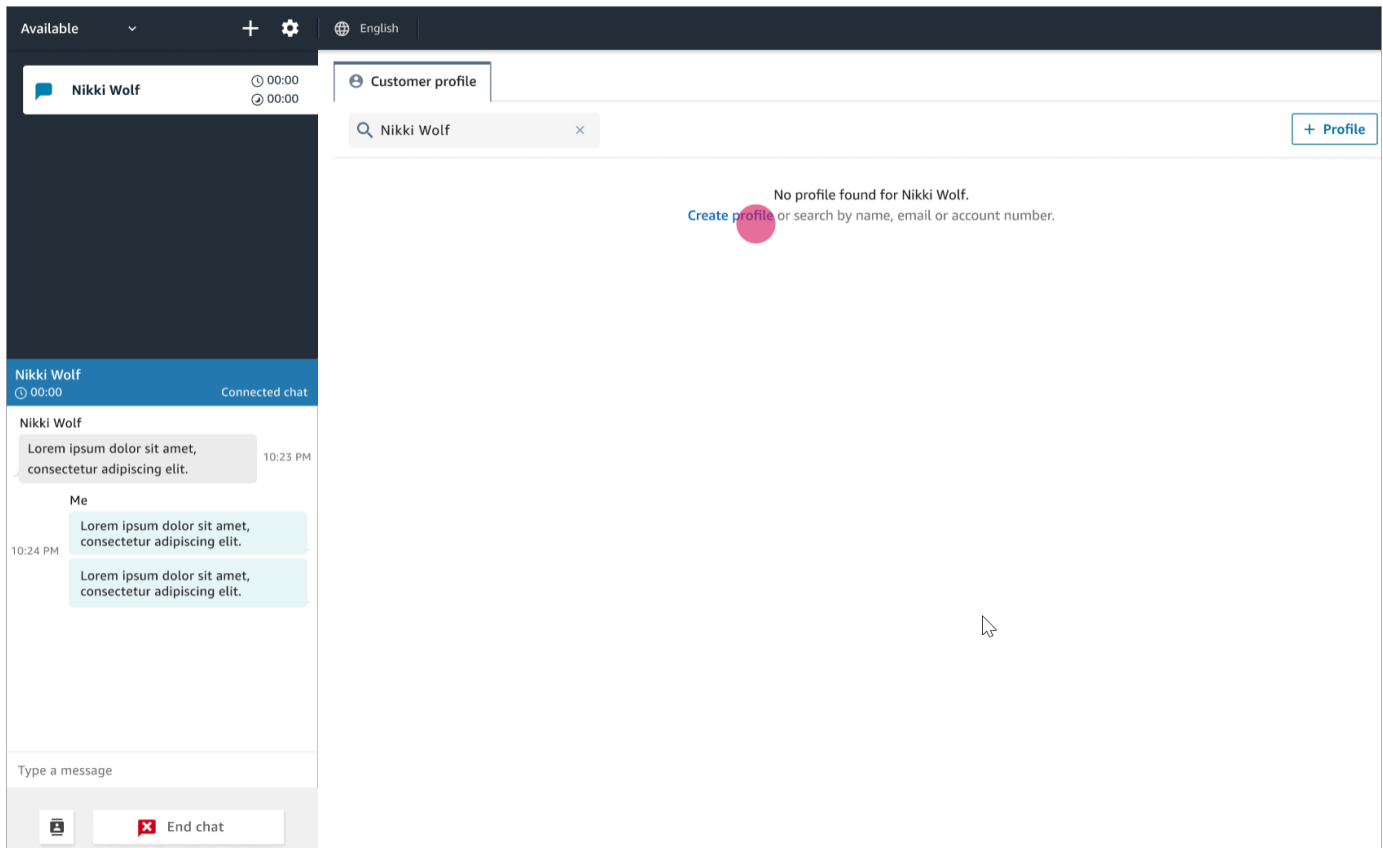

2. Choose **This is the current connected customer**. This tells Amazon Connect to link the customer profile to the contact ID for the current customer.

If you don't select this check box, the profile isn't associated with the current contact. This is useful when a contact is calling from someone else's number.

Enter information in the required boxes, and then choose **Save**.

Tip

Agents can use any of these customer Identifiers in the Agent Workspace to find the profile that belongs to the customer on the interaction.

Customer profile

Create profile Cancel Save

This is the current connected customer.

Party type ▼ First name*
Nikki
Required

Middle name Last name
Wolf

Account number Date of birth
yyyy-mm-dd

Gender ▼ Additional information
0/000

Phone numbers

Country ▼ Phone number Country ▼ Mobile number
+1 e.g. 000-000-0000 +1 e.g. 000-000-0000

Country ▼ Home number Country ▼ Business phone number
+1 e.g. 000-000-0000 +1 e.g. 000-000-0000

Emails

Email Business email

Personal email

3. You'll receive a verification page that the contact has been created.

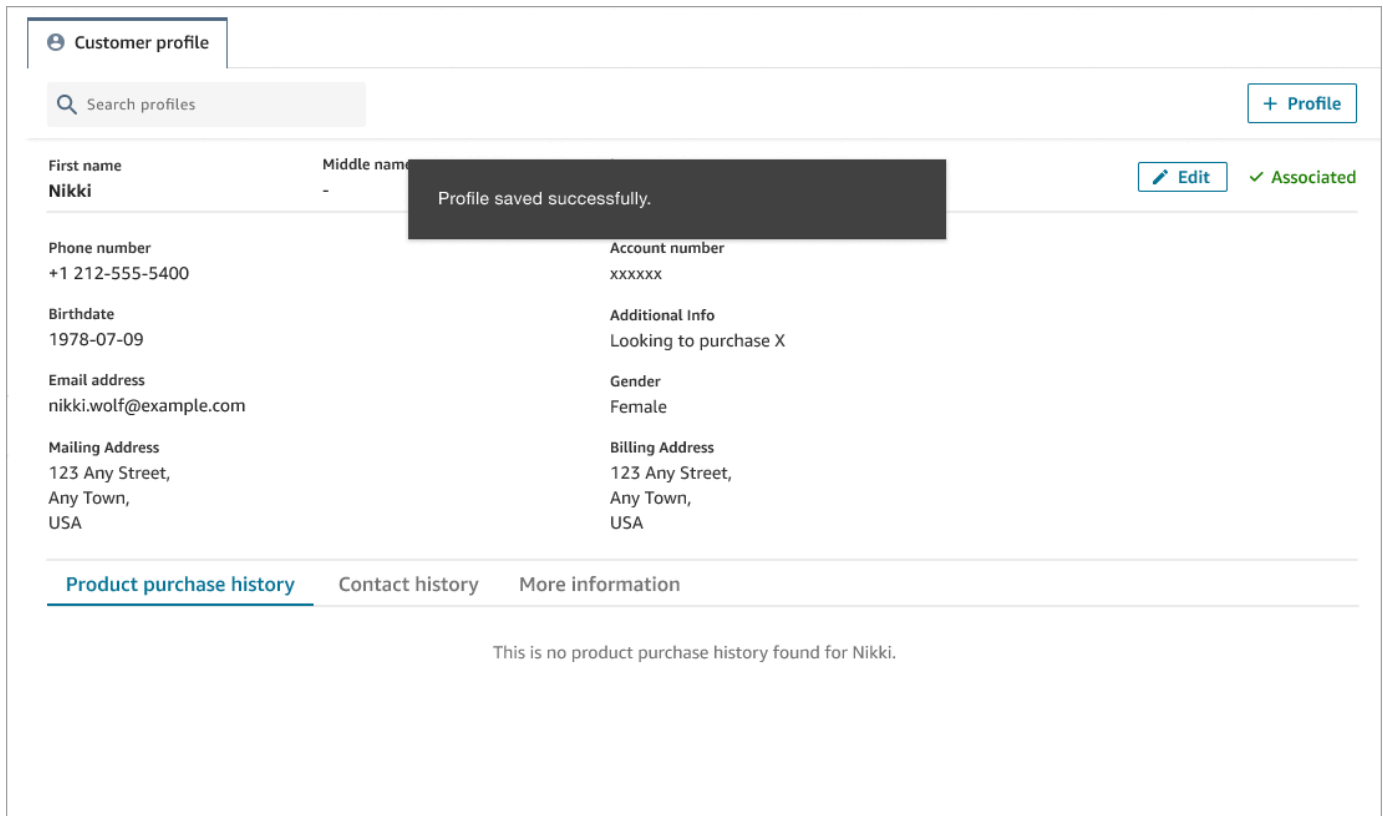

Customer profile

Search profiles + Profile

First name
Nikki

Middle name
-

Phone number
+1 212-555-5400

Birthdate
1978-07-09

Email address
nikki.wolf@example.com

Mailing Address
123 Any Street,
Any Town,
USA

Account number
xxxxxx

Additional Info
Looking to purchase X

Gender
Female

Billing Address
123 Any Street,
Any Town,
USA

Edit ✓ Associated

Profile saved successfully.

[Product purchase history](#) [Contact history](#) [More information](#)

This is no product purchase history found for Nikki.

4. You can continue the conversation with the customer.

Search for a customer profile in the agent workspace

Even when you're not on a contact you can search customer profiles. This is helpful in cases where, for example, you want to return to a customer profile.

1. In the **Search** box, select the key you wish to use to search for a profile and enter the value you wish to search with. For example, you can select *phone* from the drop down menu and enter 206-555-2322 in the input field to search.

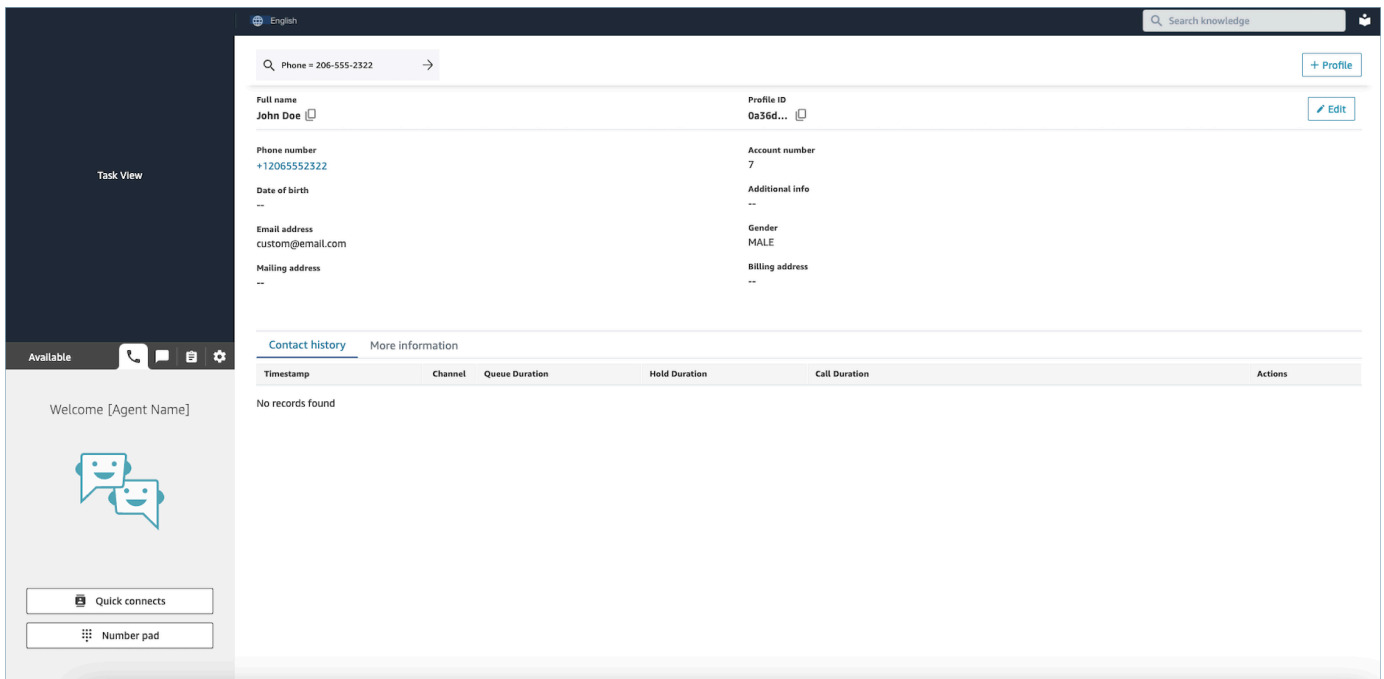
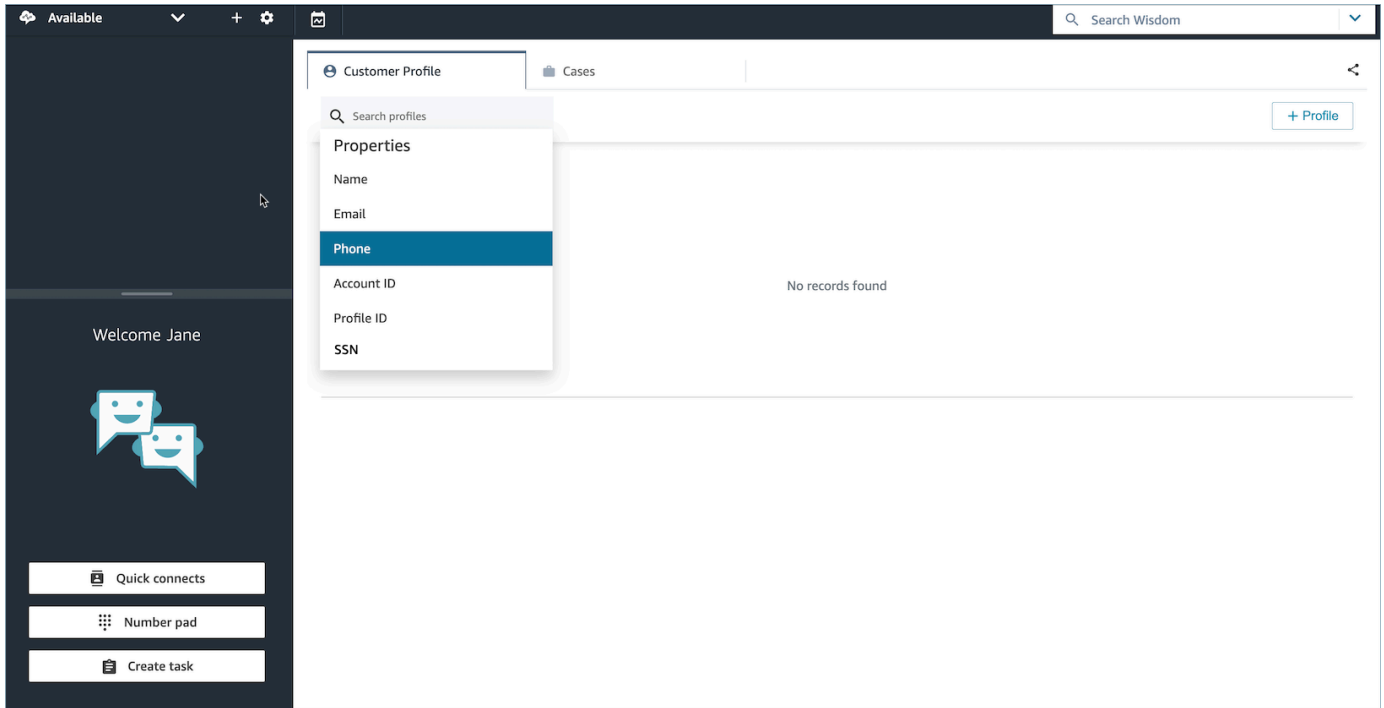

- 2. If more than one result is returned, you can review the profile information to identify the contact that you want.

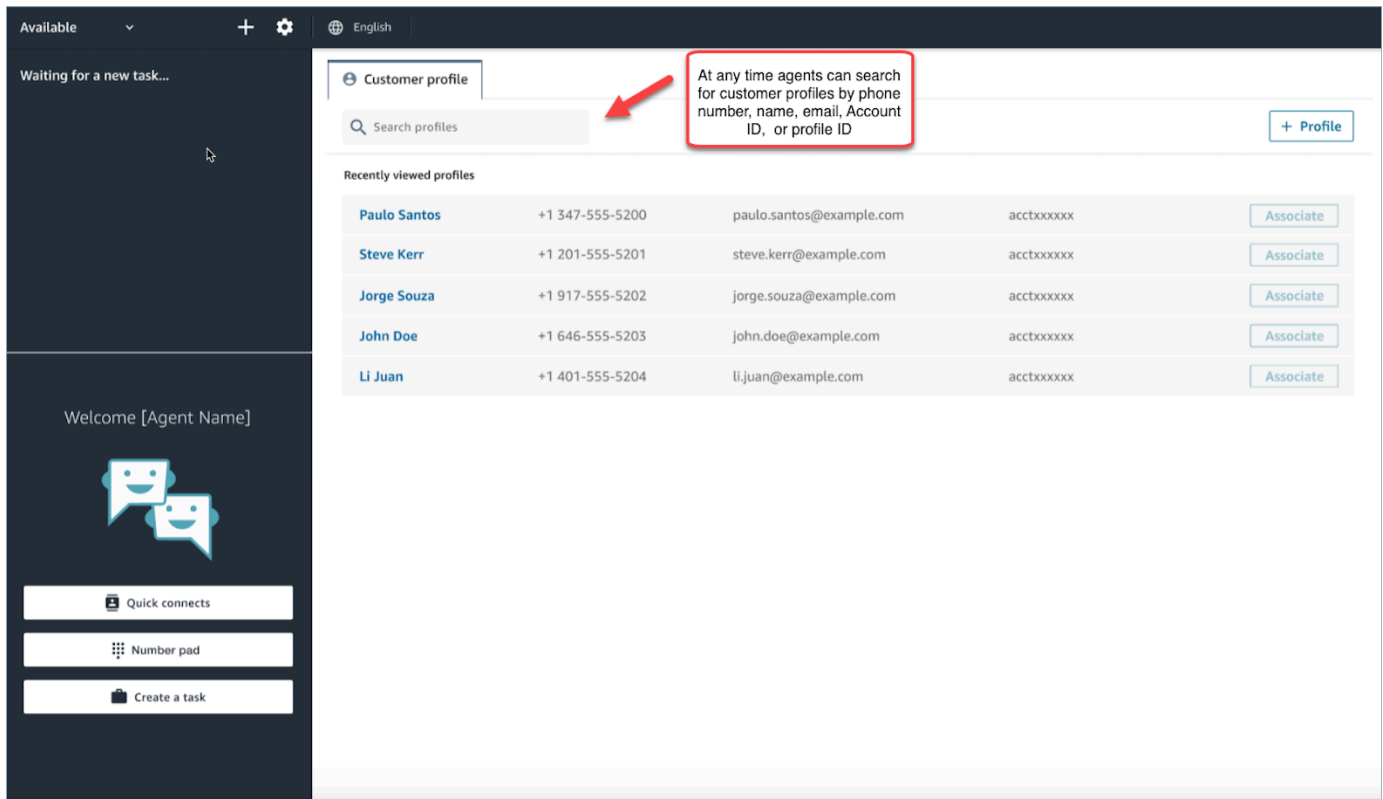

Available + ⚙️ 🌐 English

Waiting for a new task...

Customer profile

Search profiles + Profile

Recently viewed profiles

Paulo Santos	+1 347-555-5200	paulo.santos@example.com	acctxxxxxx	Associate
Steve Kerr	+1 201-555-5201	steve.kerr@example.com	acctxxxxxx	Associate
Jorge Souza	+1 917-555-5202	jorge.souza@example.com	acctxxxxxx	Associate
John Doe	+1 646-555-5203	john.doe@example.com	acctxxxxxx	Associate
Li Juan	+1 401-555-5204	li.juan@example.com	acctxxxxxx	Associate

Welcome [Agent Name]

Quick connects

Number pad

Create a task

Tip

- You can enter a search term without having to select an attribute for phone number, name, email, Account ID, or profile ID. The agent workspace will automatically detect the values type and run a search for matching profiles.
- Searching for Profiles in the agent workspace will return profiles that match your exact search value.

Use Cases

A case represents a customer's issue. A case is created to record the customer's issue, the steps and interactions taken to resolve the customer's issue, and the outcome.

If you have permission to view cases then you will see the **Cases** tab in the Amazon Connect agent workspace. The following image shows an example **Cases** tab in the agent workspace.

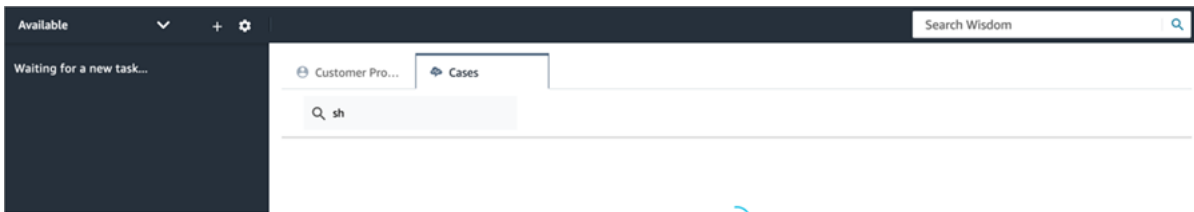

Contents

- [Search and view cases](#)
- [Add comments to a case](#)
- [Create a case](#)
- [Associate a contact with a case](#)
- [Edit a case](#)
- [Create a task from a case](#)

Search and view cases

You can search cases using a keyword match. Amazon Connect searches data across all system and custom fields. The results are sorted from most-recently to least-recently updated case.

If you are on a contact, and the contact has been associated to a customer profile, then search automatically filters to cases of current customer.

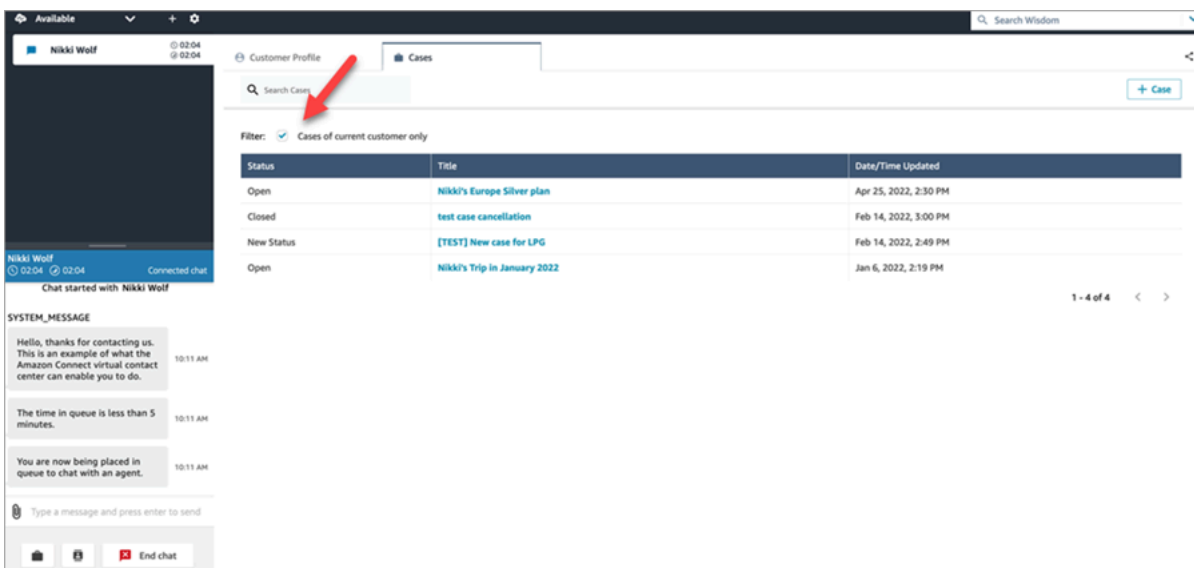

Regardless of whether you are on a contact, you have the option to do a general search. If you are on a contact and want to search beyond the current customer, clear the selection for **Cases of current customer only**.

View a case

When you select any of the cases in the search results to view the case, a new tab opens. This enables you to have multiple cases open at the same time.

If you add a [Cases](#) block to a flow, and configure it with **Link contact to case** enabled, then cases will open automatically when the agent accepts the contact.

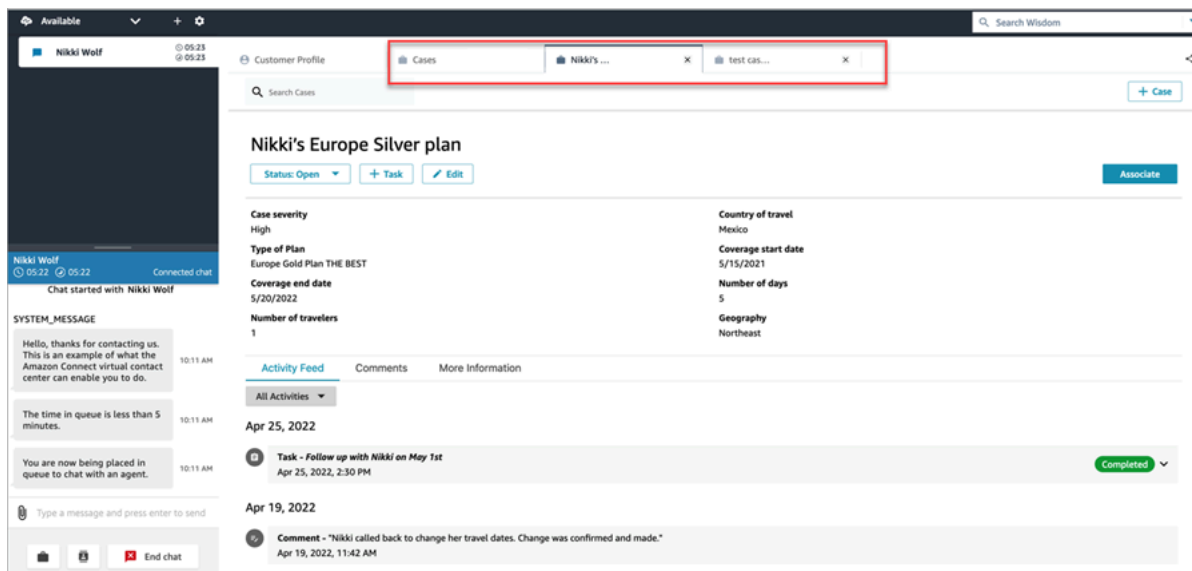

Activity feed

The activity feed shows calls, chats, tasks, and comments from the most recent to least recent Started data.

Contacts will have an indicator of Ongoing or Completed. If the contact was completed, there will be a Completed/Terminated date/time and a link to **Contact details** that takes user directly to the **Contact details** page.

Only users who have access to this page will be able to see contact details for a given contact. Even within this page, there are more granular permissions so different users may see different information. Information might include: basic contact details/contact attachments, transcripts and recordings with Contact Lens categories, sentiment, and summaries, recordings, etc.

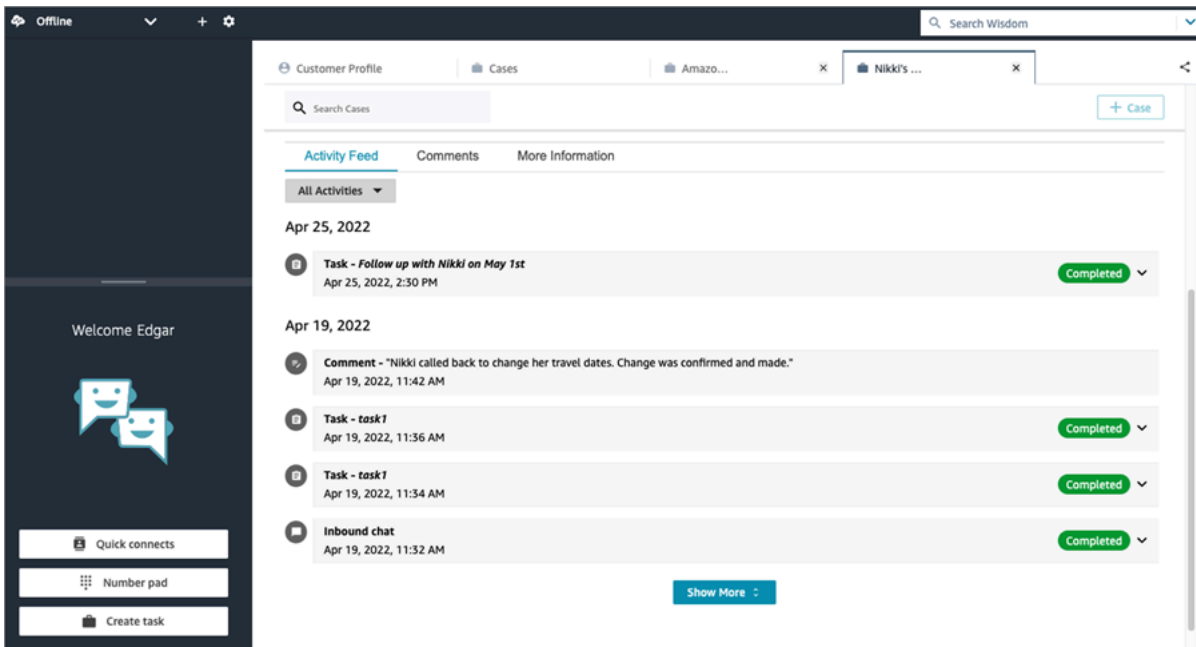

More information

There may be additional information for agents to view and populate on the **More information** tab, depending on the case template is designed.

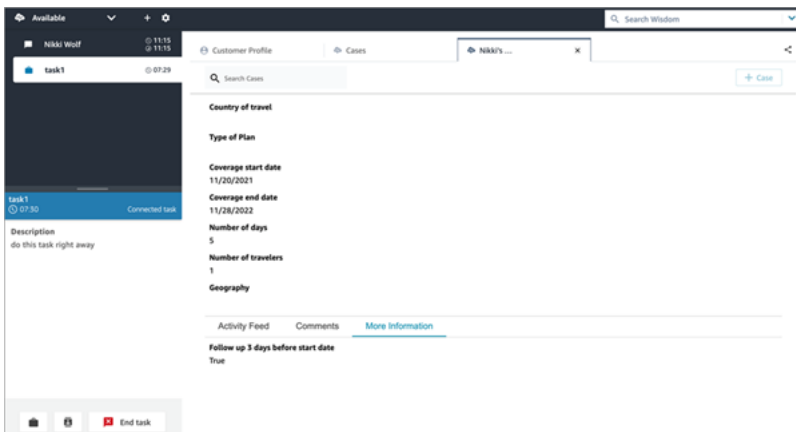

Add comments to a case

Agents have the ability to view and add comments to a case.

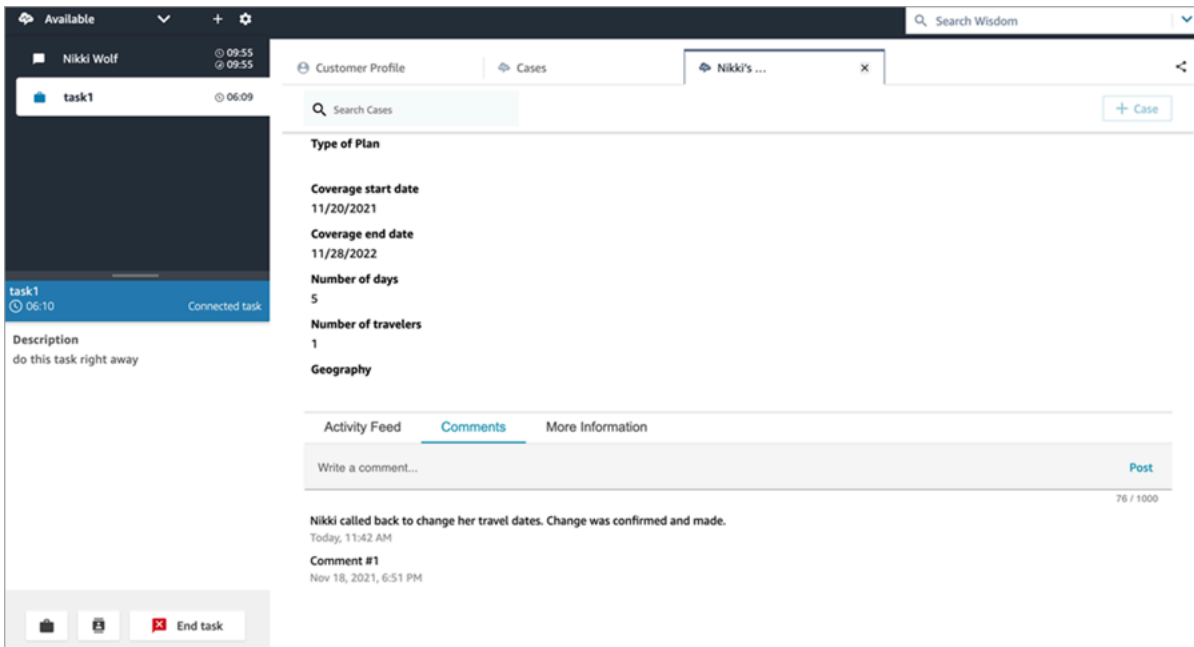

Create a case

You can create a case either by choosing **+ Case** from the **Cases** page or by choosing **+ Connect case** directly from a customer profile. If you are not on active contact, you can still create a case directly from the customer profile.

To create a case while on the Customer Profile page

1. Choose **+ Profile** to create a customer profile, as shown in the following image.

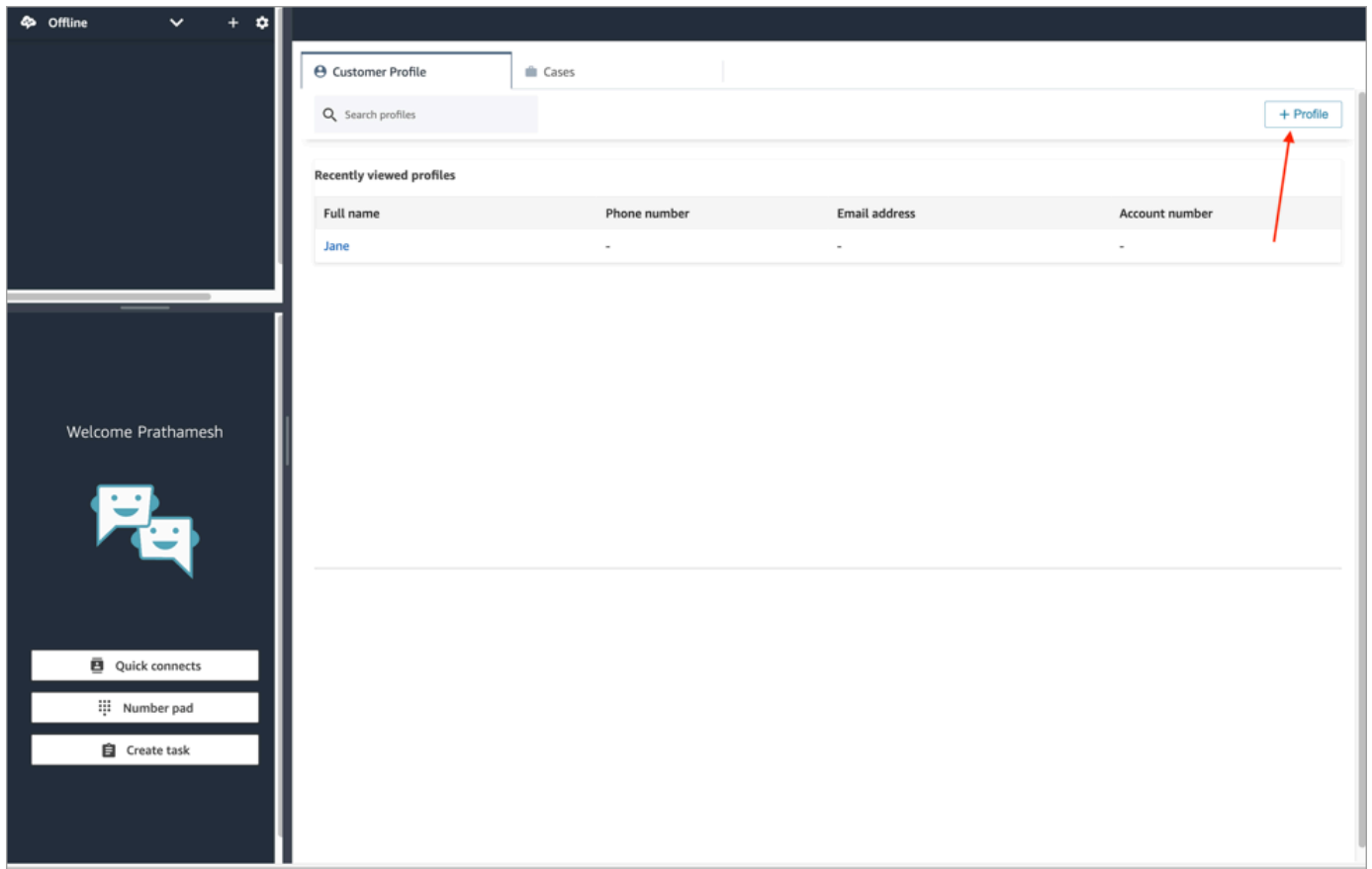

2. Choose **+ Connect Case** to create a case, as shown in the following image.

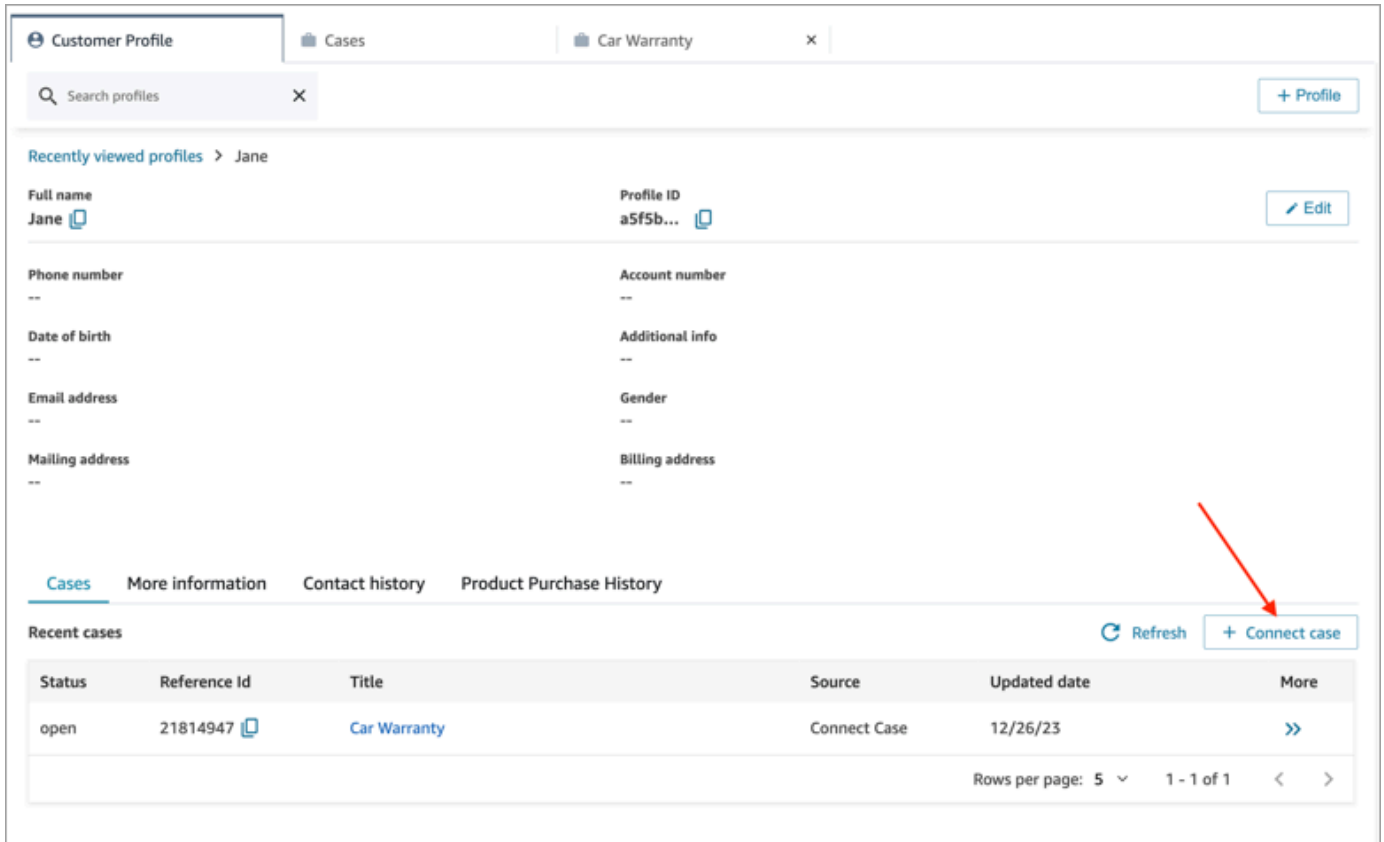

3. Complete the required information for the case, and then choose **Save**. A case is created for the customer, as shown in the following image.

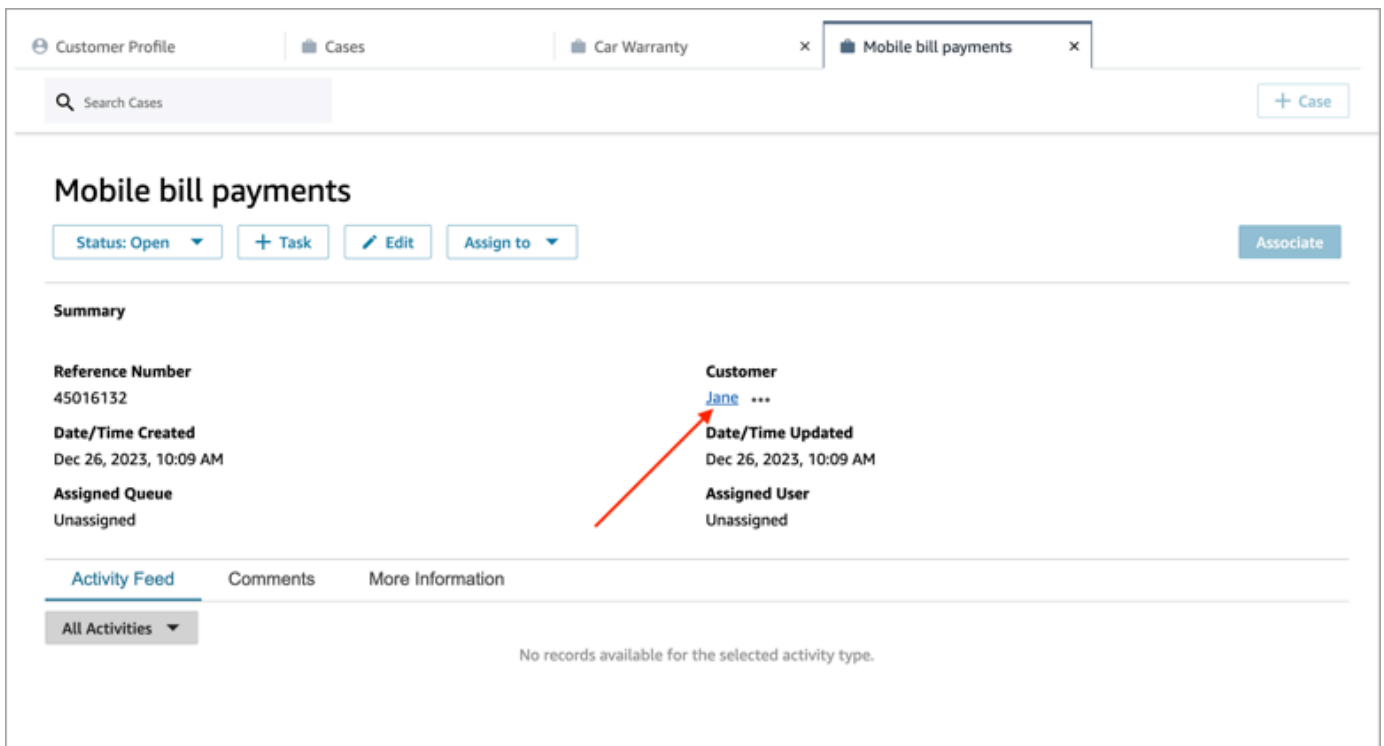

To create a case while on the Cases page

1. You must be on a contact (call, chat, or task) and the contact must already be **Associated** with a customer profile, as shown in the following image.

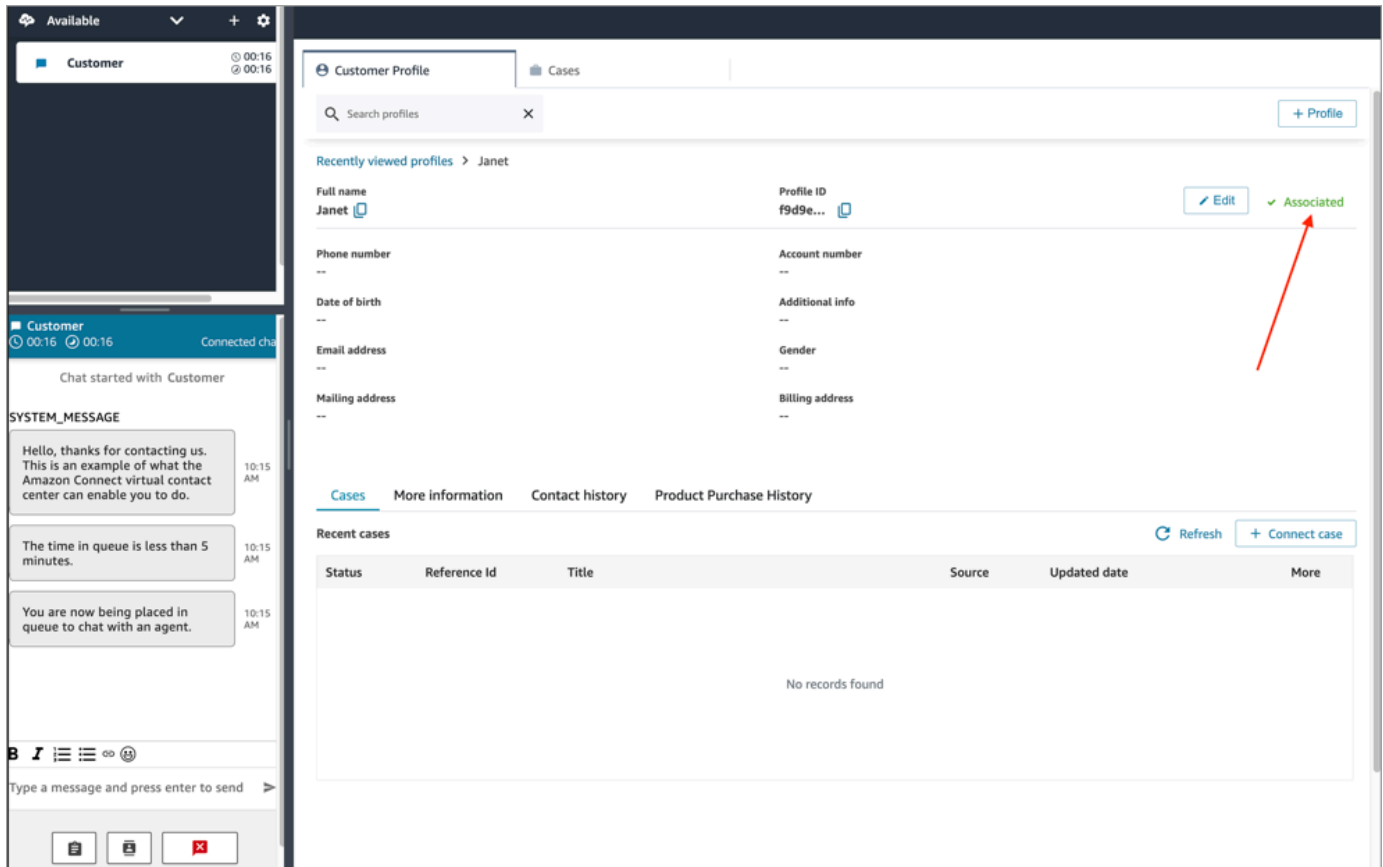

2. Choose the **Cases** tab and then choose **+ Case**, as shown in the following image.

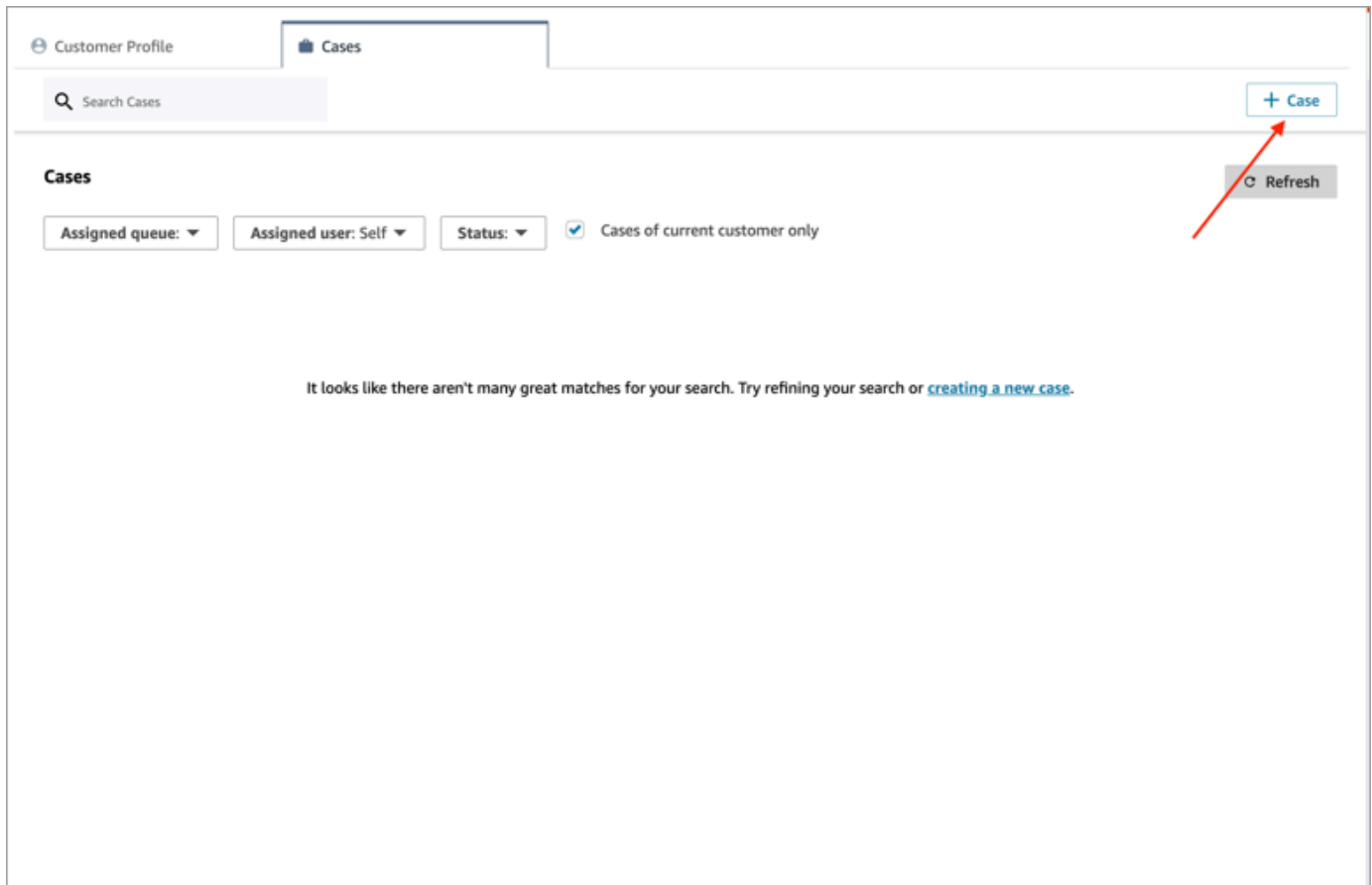

3. Complete the required information for the case, and then choose **Save**. A case is created for the customer.

Customer name

Each case that is created is connected to a customer profile from your Amazon Connect instance. While viewing the case details page, an agent can click or tap the customer's name to open the associated Customer Profile in a different tab. Or, the agent can choose **More (...)** to copy the customer name or profile ID to the clipboard. On new case templates, the customer name appears by default on the case details page. You can rearrange this field on your case template, or even remove it entirely.

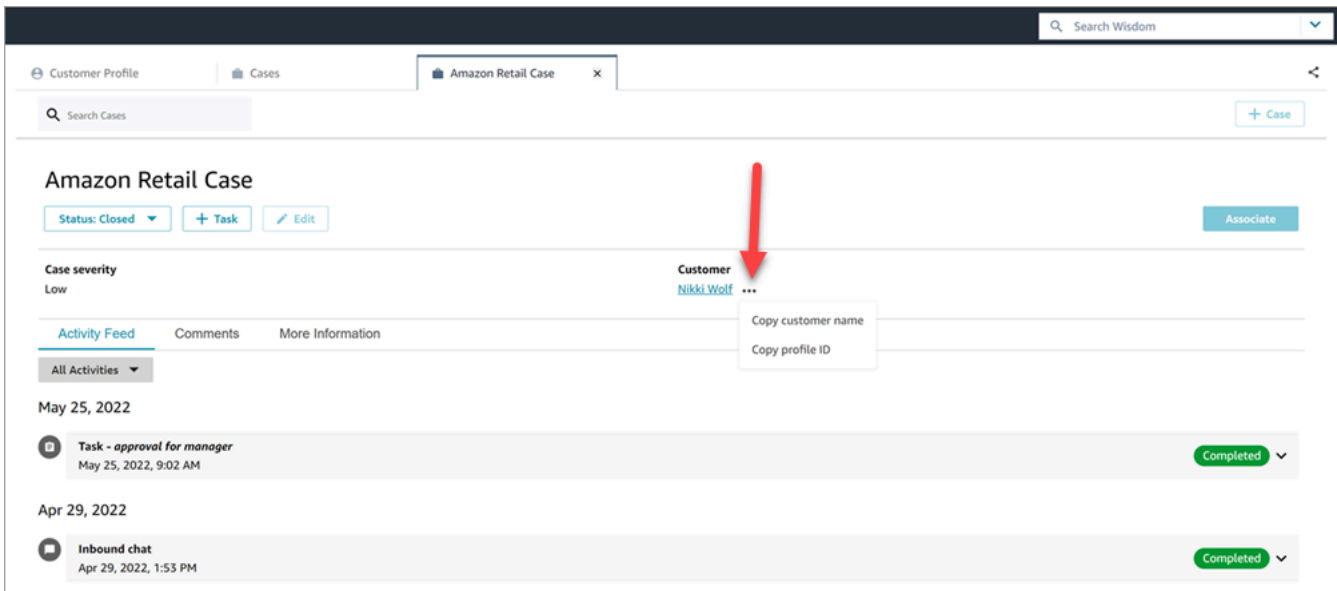

Associate a contact with a case

You can associate the contact to an existing case, such that the contact will appear on the activity feed of the case with indicator **Ongoing**.

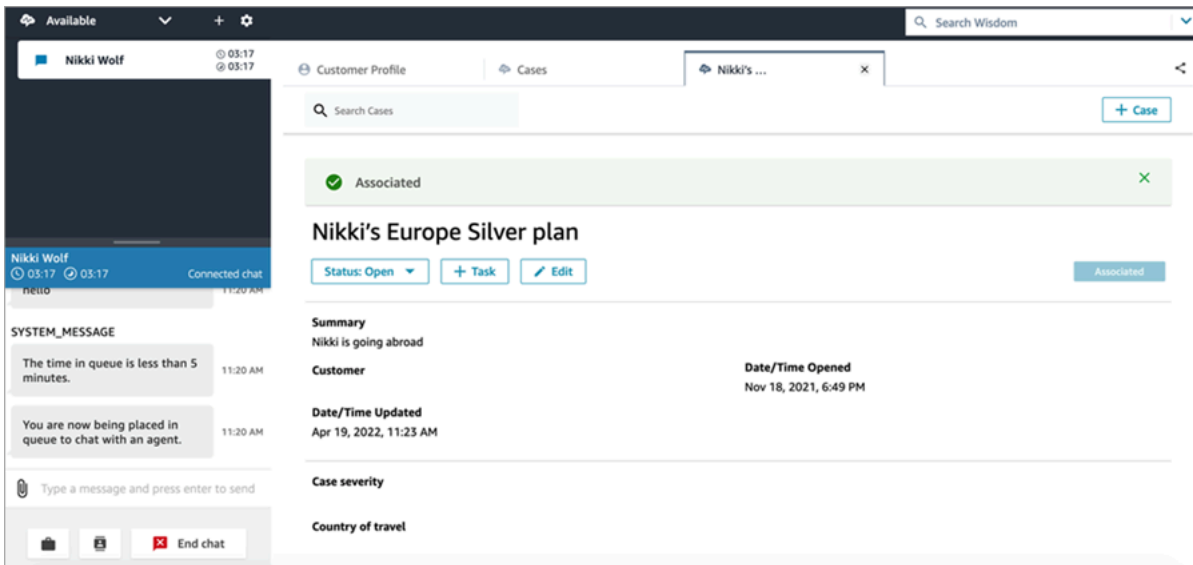

The screenshot displays the Amazon Connect interface. On the left, a chat window is open with a contact named Nikki Wolf. The chat history shows a system message: "The time in queue is less than 5 minutes." and "You are now being placed in queue to chat with an agent." On the right, the case details panel is visible. It shows the case title "Nikki's ...", a search bar, and a list of activities. The activities include "Inbound chat" (Ongoing) and "Comment #1" (Nov 18, 2021, 6:51 PM). The "Activity Feed" tab is selected, and the "All Activities" dropdown is visible.

Edit a case

To edit a case, the agent chooses **Edit** and **Save** to save any changes.

You can edit a case only when it is not in a **Closed** status. If the case is **Closed**, you must update the status, then choose **Edit** to make your changes.

The screenshot displays the Amazon Connect interface. On the left, a chat window is open with a contact named Nikki Wolf. The chat history shows a system message: "Hello, thanks for contacting us. This is an example of what the Amazon Connect virtual contact center can enable you to do." and "The time in queue is less than 5 minutes." and "You are now being placed in queue to chat with an agent." On the right, the case details panel is visible. It shows the case title "Nikki's Europe Silver plan", a status dropdown set to "Open", and a list of activities. The activities include "Task - Follow up with Nikki on May 1st" (Completed) and "Comment - Nikki called back to change her travel dates. Change was confirmed and made." (Apr 19, 2022, 11:42 AM). A red arrow points to the "Edit" button.

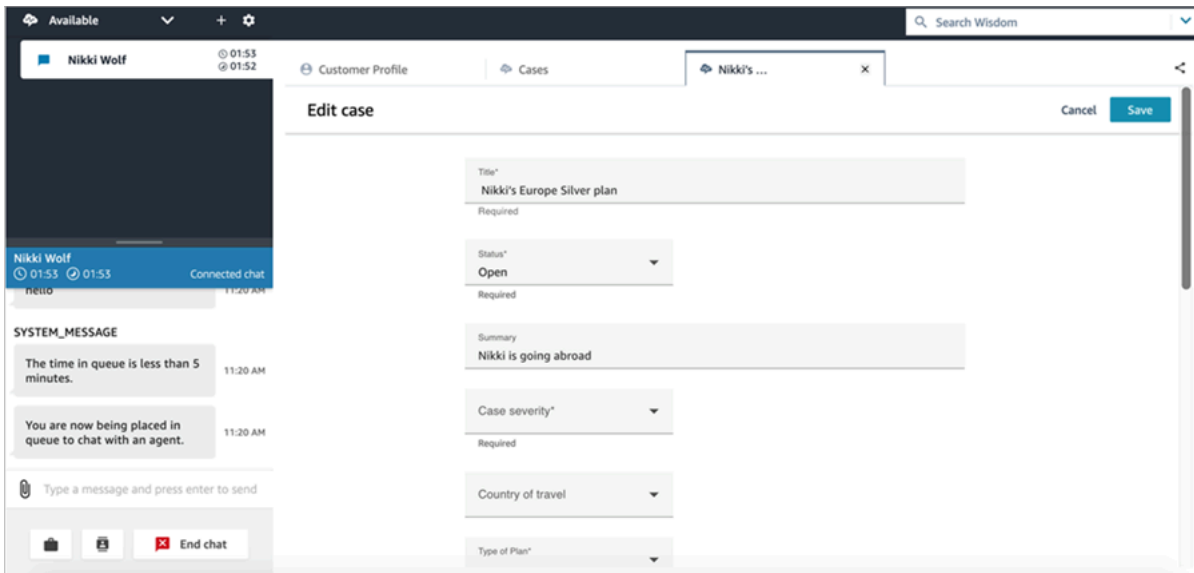

Create a task from a case

In the agent workspace, you can add a task from a case. In the Contact Control Panel (CCP), you will see the task creation form.

When you create a task from a case, the task is automatically associated with the case and it appears on the activity feed.

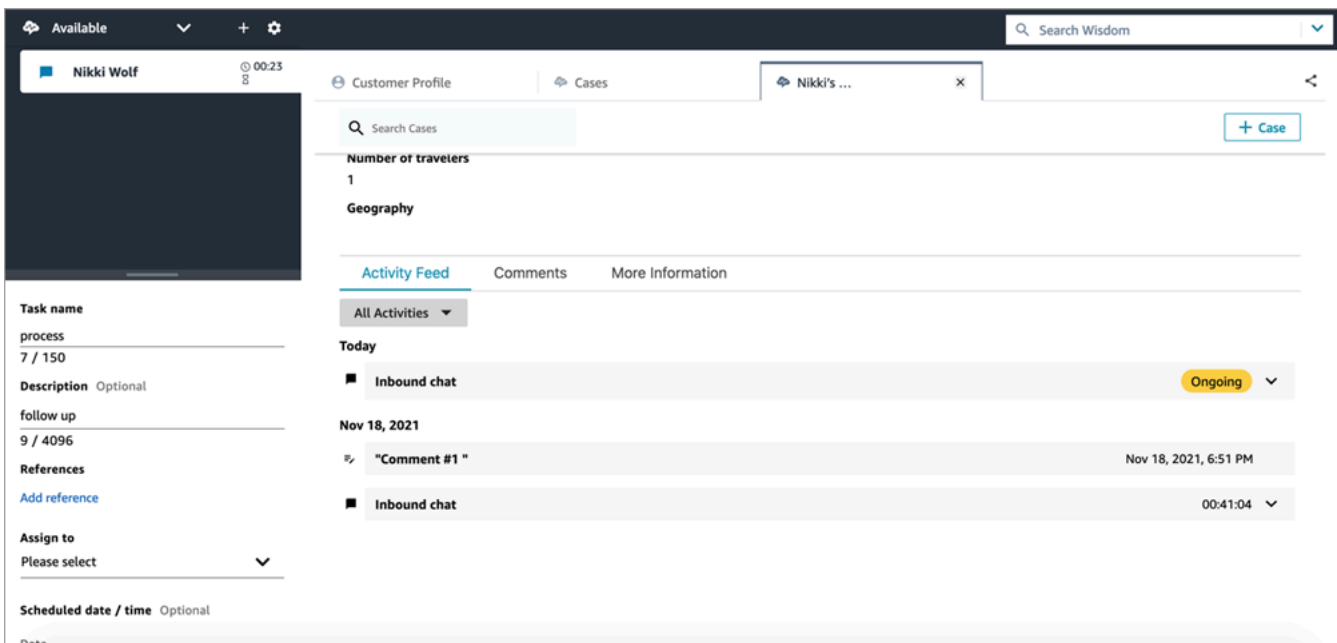

Use Amazon Q in Connect in the agent workspace

Note

Powered by Amazon Bedrock: AWS implements [automated abuse detection](#). Because Amazon Q in Connect is built on Amazon Bedrock, users can take full advantage of the controls implemented in Amazon Bedrock to enforce safety, security, and the responsible use of artificial intelligence (AI).

Amazon Q in Connect is a generative AI customer service assistant. It is an LLM-enhanced evolution of Amazon Connect Wisdom that delivers real-time recommendations to help contact center agents resolve customer issues quickly and accurately.

Amazon Q in Connect automatically detects customer intent during calls and chats using conversational analytics and natural language understanding (NLU). It then provides agents with immediate, real-time generative responses and suggested actions. It also provides links to relevant documents and articles.

In addition to receiving automatic recommendations, agents can also query Amazon Q directly using natural language or keywords to answer customer requests. Amazon Q works right within the Amazon Connect agent workspace.

The following image shows how recommendations may appear in the agent workspace when an agent is on a call or chat.

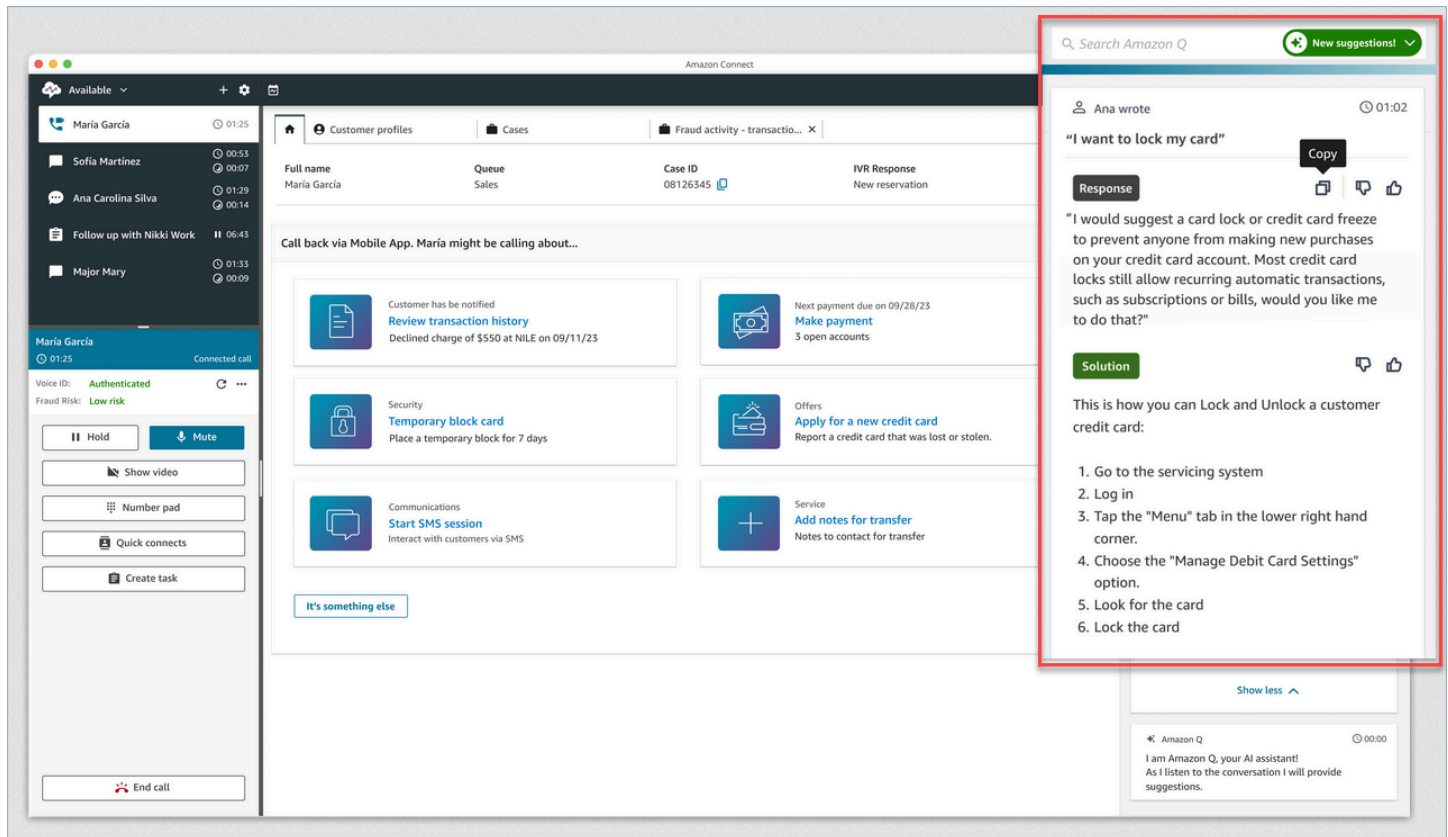

1. The agent is on a call.
2. The agent can ask natural-language questions.
3. Amazon Q in Connect provides a response that the agent can share directly with the customer. For example, they can copy and paste the response into a chat, or read it over the call.
4. Amazon Q in Connect provides more information for the agent, for example, a summary of the solution or of the next steps they should take.
5. Amazon Q in Connect provides links to specific articles.

Contents

- [Search for content using Amazon Q in Connect](#)
- [Use real-time recommendations from Amazon Q in Connect](#)

Search for content using Amazon Q in Connect

With Amazon Q in Connect agents can use natural language to search across connected knowledge sources to receive generated recommendations, like actions to take and links to more information.

For example, you can type questions or phrases in the search box (such as, "how long after purchase can handbags be exchanged?") without having to guess which keywords will work. Amazon Q in Connect searches the connected sources, and returns a specific solution generated from your knowledge content along with links to relevant information.

You can search for content at any time: while on a contact, on After Contact Work, or between contacts.

To search for content

1. In the search box, type words or phrases in natural language.

The following image shows an example of a natural language query and the solution that is displayed.

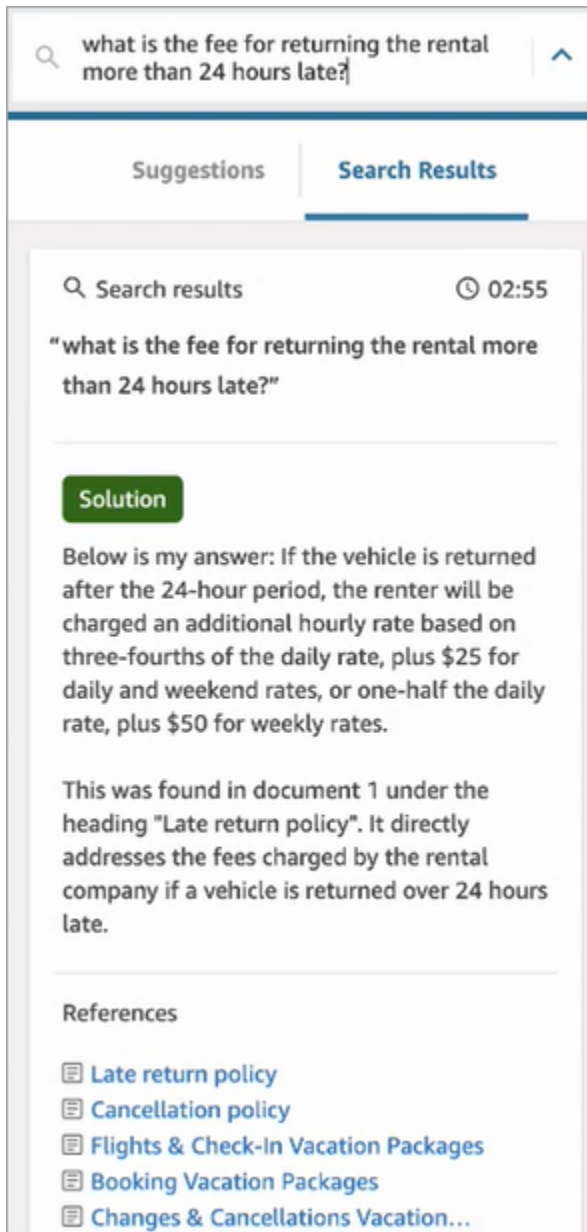

2. If more information is needed, choose the article that you want to view.
3. The article appears in a new tab. For example, the following image shows the Cancellation policy article.

The screenshot displays the Amazon Connect agent workspace. On the left, a chat window for 'Tom Jones' shows a message from an agent: 'If you need to cancel your rental car pickup that is scheduled within the next 2 hours, you will be charged a \$150 cancellation fee since you have already prepaid for the rental.' The chat is marked as 'Read'. The main workspace area is titled 'Cancellation policy' and contains the following text:

2023-07-26

MyRides Car Rental Cancellation and Change Policy

We understand that plans can change and you may need to cancel or make changes to your MyRides car rental reservation. We have different cancellation policies for reservations made on MyRides.com, through a travel agent or online booking agent, or without a credit card.

If you made a reservation on [MyRides.com](#) and have already paid for the rental:
If you need to cancel the reservation prior to the time of pick-up, we will refund the full prepaid amount less a \$150 USD processing fee, during the 24 hour period prior to the scheduled pick-up time. If you do not cancel the reservation prior to the time of pick-up and the rental vehicle is not picked up on the rental date, no portion of the prepaid amount will be refunded. If you return the vehicle before the original return date, you will not be refunded any portion of the payment.

If you made a reservation on [MyRides.com](#) and did not pay for the rental:
If you made a reservation with your credit card information but did not pay for the rental, you may cancel up to 48 hours in advance of your designated pick-up time without penalty. If you cancel less than 48 hours before your pick-up time, a \$75 U.S. fee will be assessed.

If you made a reservation without providing credit card information:
If you made a reservation without a credit card and you no longer need to rent, please cancel your reservation as soon as possible before your scheduled pick-up time.

If you made a reservation with a travel agent or online booking agent:
The travel agency or online booking agent "owns" any reservation you originally made with them, so their reservation cancellation processes and policies will apply.

If you are a MyRides Traveler, RoadWarrior or RoadMaster member, you may be entitled to additional benefits and discounts. Please call our customer service team at 800-697-4337 for more information.

On the right side of the workspace, a search results panel is visible. The search query is 'what is the fee for returning the rental more than 24 hours late?'. The search results show a 'Solution' section with the following text: 'Below is my answer: If the vehicle is returned after the 24-hour period, the renter will be charged an additional hourly rate based on three-fourths of the daily rate, plus \$25 for daily and weekend rates, or one-half the daily rate, plus \$50 for weekly rates.' Below this, it states: 'This was found in document 1 under the heading "Late return policy". It directly addresses the fees charged by the rental company if a vehicle is returned over 24 hours late.' A 'References' section lists several links: 'Late return policy', 'Cancellation policy', 'Flights & Check-In Vacation Packages', 'Booking Vacation Packages', and 'Changes & Cancellations Vacation...'

- The list of search results is cleared only after you complete ACW and choose **Clear contact**, or select the **Close** icon next to the search box.

Use real-time recommendations from Amazon Q in Connect

This topic explains how agents who are using Amazon Q in Connect in the agent workspace can interact with real-time recommendations that are generated for chats. If Contact Lens is enabled, the recommendations appear for calls as well.

The recommendations point you to information related to the current conversation with the customer.

The following image shows how an article may appear in the agent workspace when you're on a call.

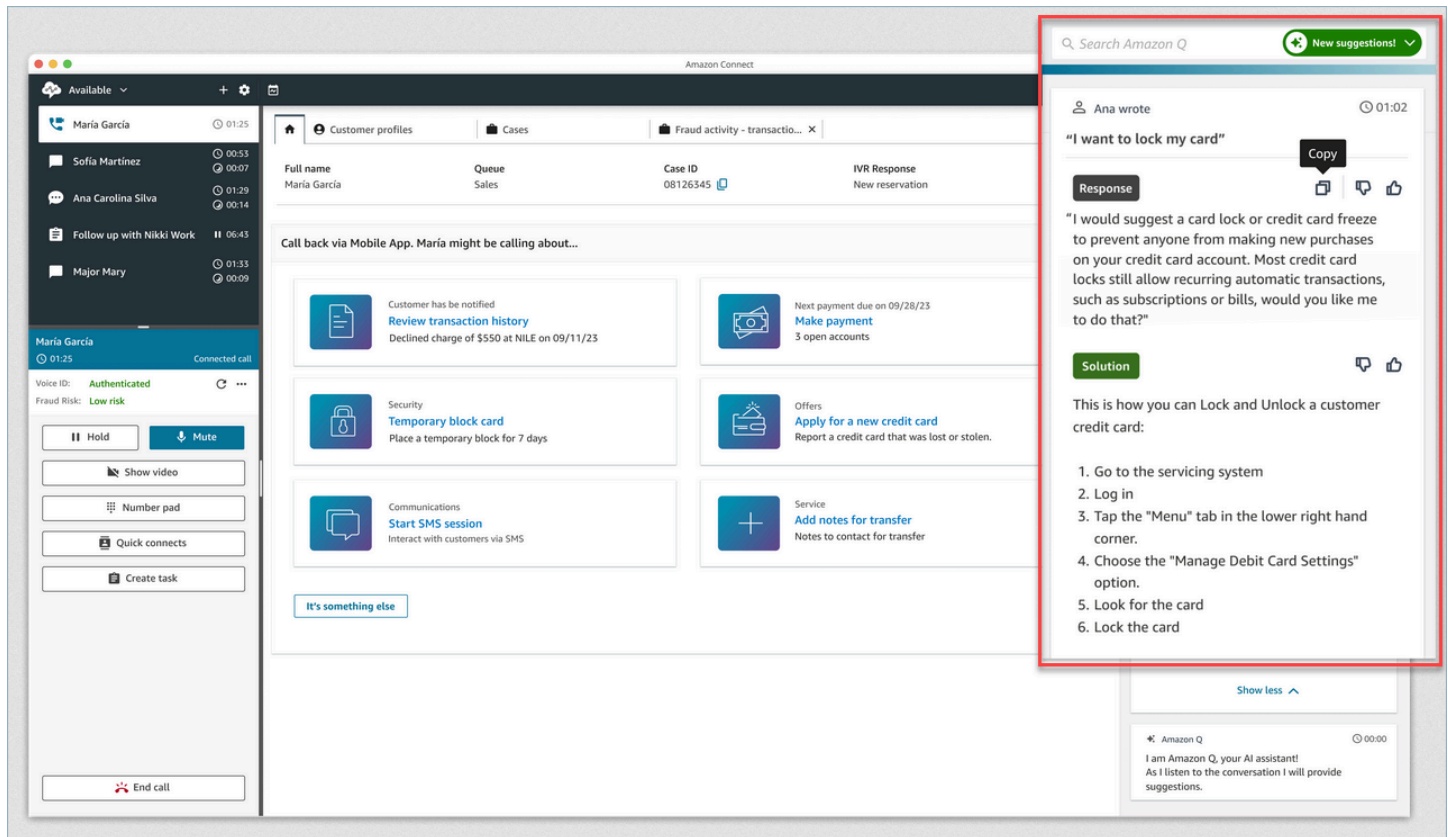

1. The agent is on a call.
2. The agent can ask natural-language questions.
3. Amazon Q in Connect provides a response that the agent can share directly with the customer. For example, they can copy and paste the response into a chat, or read it over the call.
4. Amazon Q in Connect provides more information for the agent, for example, a summary of the solution or of the next steps they should take.
5. Amazon Q in Connect provides links to specific articles.

Use Voice ID

This topic shows how Voice ID features appear in your Contact Control Panel (CCP).

Enroll a caller in Voice ID

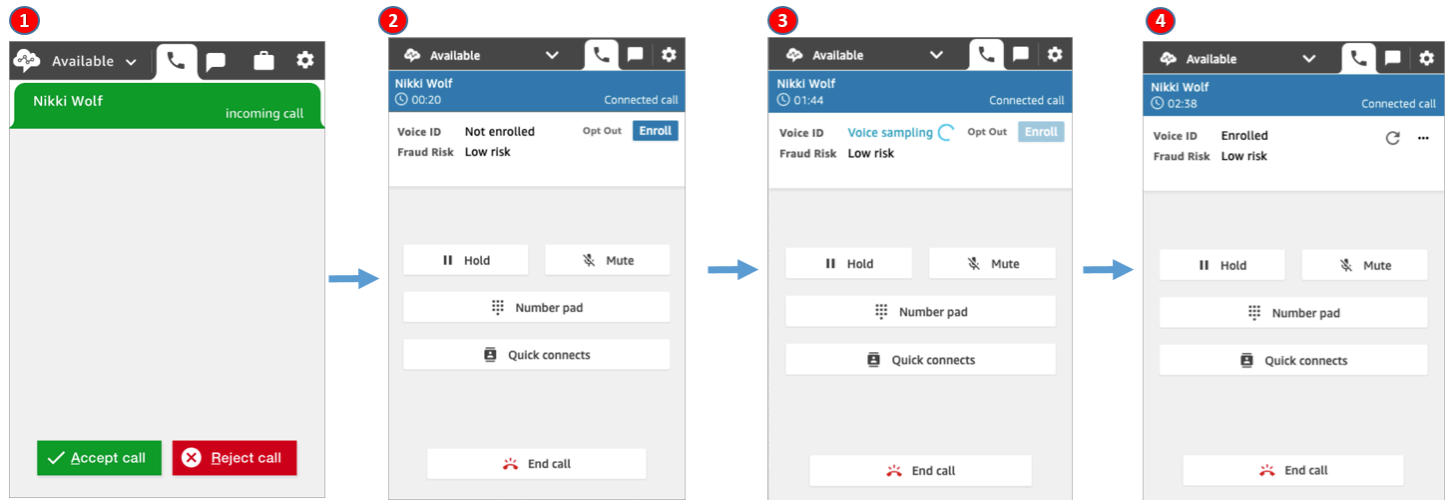

1. You receive an incoming call.
2. The caller is not yet enrolled in Voice ID so you choose **Enroll**.
3. A message is displayed that Voice ID is sampling the caller's voice. It requires 30 seconds of speech (excluding silence).
4. The caller is now enrolled in Voice ID. This example also shows the caller's **Fraud risk** as lower than the threshold.

Verification of an enrolled caller

After a customer is enrolled in Voice ID, when they call your contact center again, you can verify they are who they say they are.

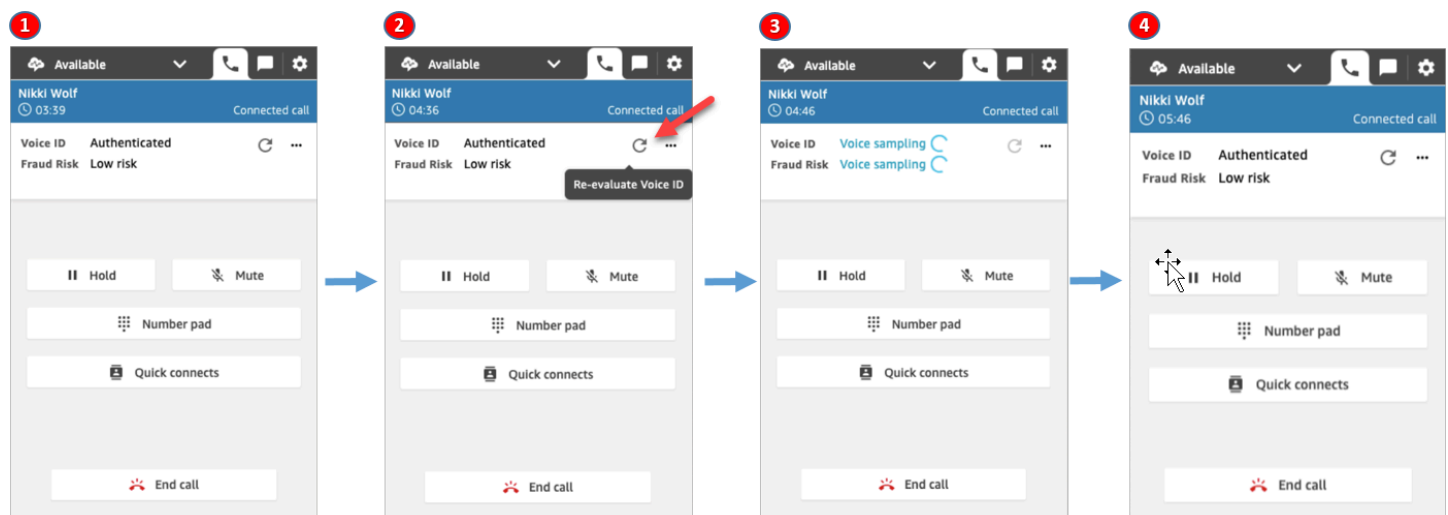

1. You receive an incoming call.
2. The caller is already enrolled in Voice ID, and their status is **Authenticated**. You can choose to re-evaluate authentication using Voice ID.
3. A message is displayed that Voice ID is evaluating the caller's speech. It requires between 5-10 seconds of speech, not including silences.
4. The caller has been authenticated by Voice ID. This example also shows the caller's **Fraud risk** is lower than the threshold.

Caller has opted out

The following image shows what appears in your CCP when a caller has opted out of Voice ID.

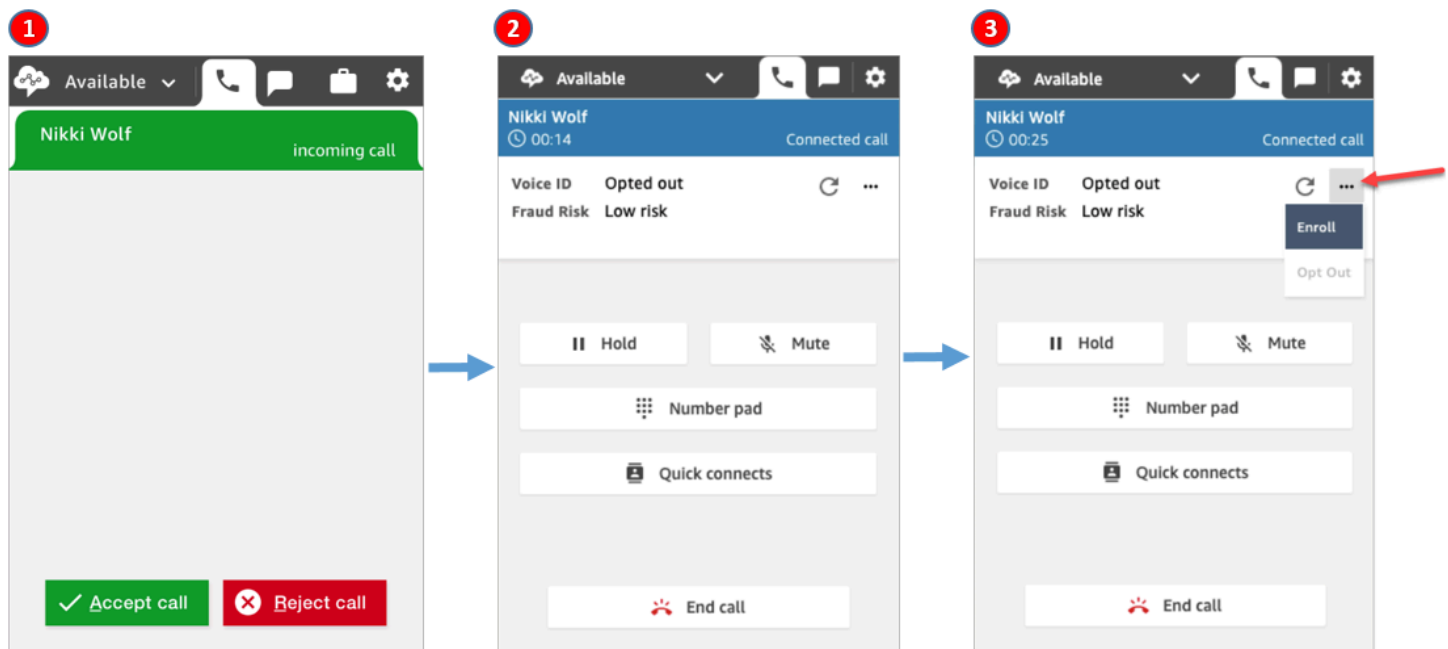

1. You receive an incoming call.
2. The caller has previously opted out of Voice ID.
3. You have the option to enroll them.

Authentication status = Not authenticated

When an enrolled caller calls your contact center, Voice ID may return a result of **Not authenticated**. This means Voice ID was unable to authenticate a caller's speech. The authentication score for the caller is lower than the configured threshold.

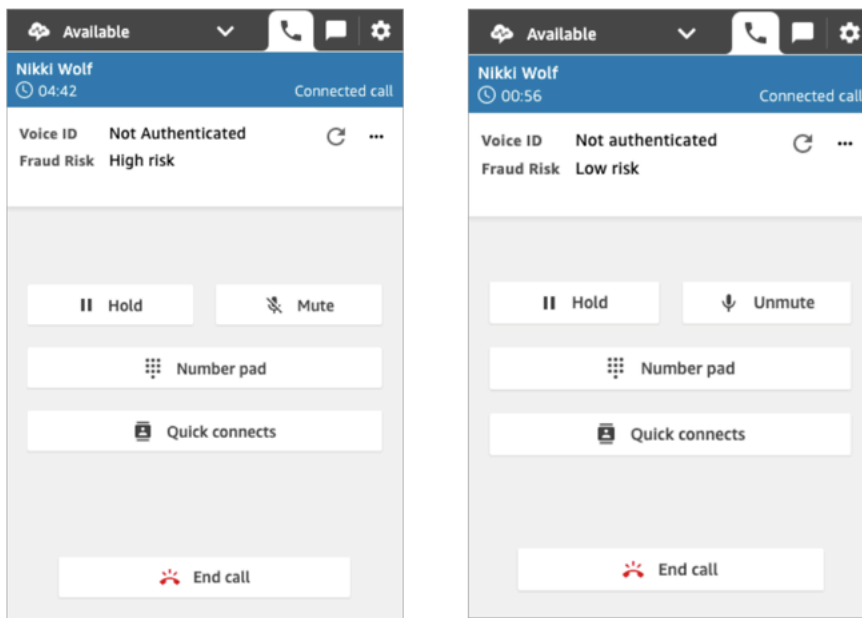

The previous images show that the **Fraud risk** can be **High** or **Low**, independent of whether the caller is authenticated.

Authentication status: Inconclusive

When an enrolled customer calls your contact center, Voice ID may return a result of **Inconclusive**: Voice ID was unable to analyze a caller's speech for authentication. This is usually because Voice ID did not get the required 10 seconds to provide a result for verification.

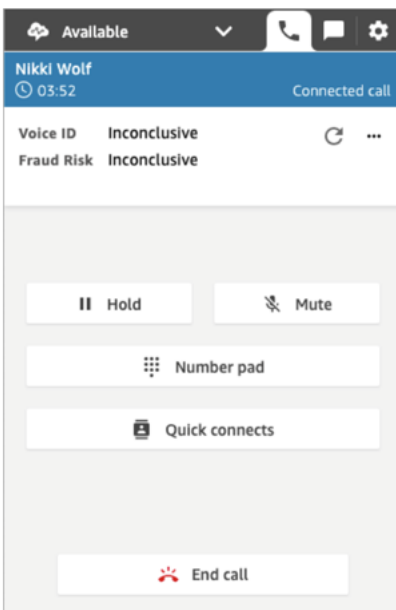

Troubleshooting Issues when using the Contact Control Panel (CCP)

Troubleshooting Contact Control Panel (CCP) issues requires support from your network operations, system administrator, and virtual desktop (VDI) solution teams to collect the appropriate level of information to identify root cause and drive resolution. To help determine the appropriate resources to engage, it's important to break issues down into those with similar symptoms. The following guidance has been helpful in assisting Amazon Connect customers in resolving CCP issues with their operations support teams.

Contents

- [Use the Endpoint Test Utility](#)
- [Common Contact Control Panel \(CCP\) Issues](#)
- [Download CCP logs](#)
- [Troubleshooting Tools and Information](#)
- [Mobile phones \(iPhone, Android\) and iPads are not supported](#)
- [Problem using the CCP: Agents can't make an outbound call](#)
- [Internal firewall prevents access to chat or case attachments](#)
- [Humming sound in headset: Verify the headset and browser sample rates](#)
- [One-way audio from customers?](#)

Use the Endpoint Test Utility

To validate connectivity to Amazon Connect, or when your agents are experiencing problems with the Contact Control Panel (CCP), we recommend using the [Amazon Connect Endpoint Test Utility](#).

The Amazon Connect Endpoint Test Utility performs the following checks:

- Validates that the browser being used supports WebRTC.
- Determines if the browser has appropriate access to media devices (microphone, speakers, etc).
- Performs latency tests for all active Amazon Connect Regions.
- Performs latency tests to a specific Amazon Connect instance, if provided.
- Validates network connectivity across required ports for media streams.

The complete results are available for download as a JSON file. You can copy the results to include in a support ticket. You can also load the results file into the tool by selecting the **Load previous results** option. This option displays the contents of the file visually and makes it easier to analyze the results. Additionally, you can download a bookmark specifically for the provided instance to make future tests easier to run.

Parameters to customize the Endpoint Test Utility

You can use the Endpoint Test Utility as is without any customizations. However, if you want to customize it, use the following URL parameters:

- **lng**: Change the language of the tool. Currently supported languages are English, Spanish, and French. It accepts the following values:
 - en (default)
 - es
 - fr
- **autoRun**: Run the tool automatically. It accepts the following values:
 - true
 - false (default)
- **connectInstanceUrl**: Not used by default. You can specify the Amazon Connect instance in the URL. It must start with **https**.
- **regions**: A comma-separated list of region codes for the AWS Regions that you want to test. For example `regions=us-east-1,us-west-2`.

Example customized URL:

```
https://tools.connect.aws/endpoint-test/?  
lng=es&autoRun=true&connectInstanceUrl=https://  
myinstance.awsapps.com&regions=us-east-1,us-west-2
```

Common Contact Control Panel (CCP) Issues

The following are common issues encountered when using the Amazon Connect CCP.

- **CCP does not initialize/connect**—The most common causes are missing port/IP allowlist entries, not allowing browser microphone access, or not answering your external device. Be sure that you

have added to the allowlist all IPs covered in the [Set up your network](#) section of this guide, and that you have allowed microphone access to your browser when prompted.

- **Session expired message upon initial log in**

If you see the **Session expired** message while logging in, you probably just need to refresh the session token. Go to your identity provider and log in. Refresh the Amazon Connect page. If you still get this message, contact your IT team.

- **Periodic connection errors**—The most common cause is network contention, or there may have been an `ipranges.json` update and the new entries have not been added to the allowlist. For more information, see the [Set up your network](#) section of this guide.
- **Missed calls, state change delays, and CCP unresponsive**—In most cases, this is intermittent and directly correlated with resource contention in the agent's workstation, network, or both. This can be made worse, or caused directly, by a poor, unstable, or strained connection to AWS resources at the private WAN/LAN, public WAN levels, or local workstation resource contention.

The following are common issues with call quality when using the CCP. Call quality encompasses a large range of potential causes and is best approached by first identifying the types of issues that you're having.

- **Latency/cross-talk**—in a voice connection manifests as a delay between when something is said and when the person on the other end hears it. In some use cases that require a lot of conversation, high latency can create situations in which both parties are talking over each other. The PSTN (public switched telephone network) and agent latency need to be calculated in this scenario to identify contributing factors and take action to reduce PSTN latency, agent latency, or both. For more information, see the PSTN and agent connection latency section of this documentation.
- **One way audio**—is when the agent can't hear the caller or the caller can't hear them. This is normally indicative of an issue with the agent's workstation at the hardware, network, resource levels, or all three. It and can also be related to browser microphone permissions or headset issues. For more information, see the [How to determine whether a workstation is the source of problems](#) section of this guide.
- **Volume increase or decrease**— can happen at the beginning or intermittently during the call, and it's important to differentiate the two for troubleshooting purposes. Typically, this relates to forwarding calls to or from Amazon Connect that inherit this from an issue with the third party transfer.

- **Audio choppy, cutting out, echo, reverb, or other signal noise**—could also manifest as a robotic sound or other distortion making it difficult for either the agent, caller, or both parties to understand what’s being said. This is normally indicative of an issue with the agent's workstation at the hardware, network, resource levels, or all three. For more information, see the [How to determine whether a workstation is the source of problems](#) section of this guide.
- **Wobble**—is the effect that media codecs can have on audio that manifests as the slowing down and speeding up of audio to combat high jitter and latency. This is normally indicative of an issue with the agent's workstation at the hardware, network, resource levels, or all three. For more information, see the [How to determine whether a workstation is the source of problems](#) section of this guide.
- **Disconnects**—can happen at any point in the call. It is important to note when during the call that the disconnections occur to identify a pattern. For example, disconnects on call transfers to a specific external number typically relate to forwarding calls to or from Amazon Connect that inherit this from an issue with the third party transfer. They can also be related to circular transfers, which means transferring calls out of Amazon Connect and back in the same call.

Download CCP logs

The Contact Control Panel logs store agent actions and timing.

To download CCP logs

1. On the agent's desktop, in their CCP, choose **Settings, Download logs**.

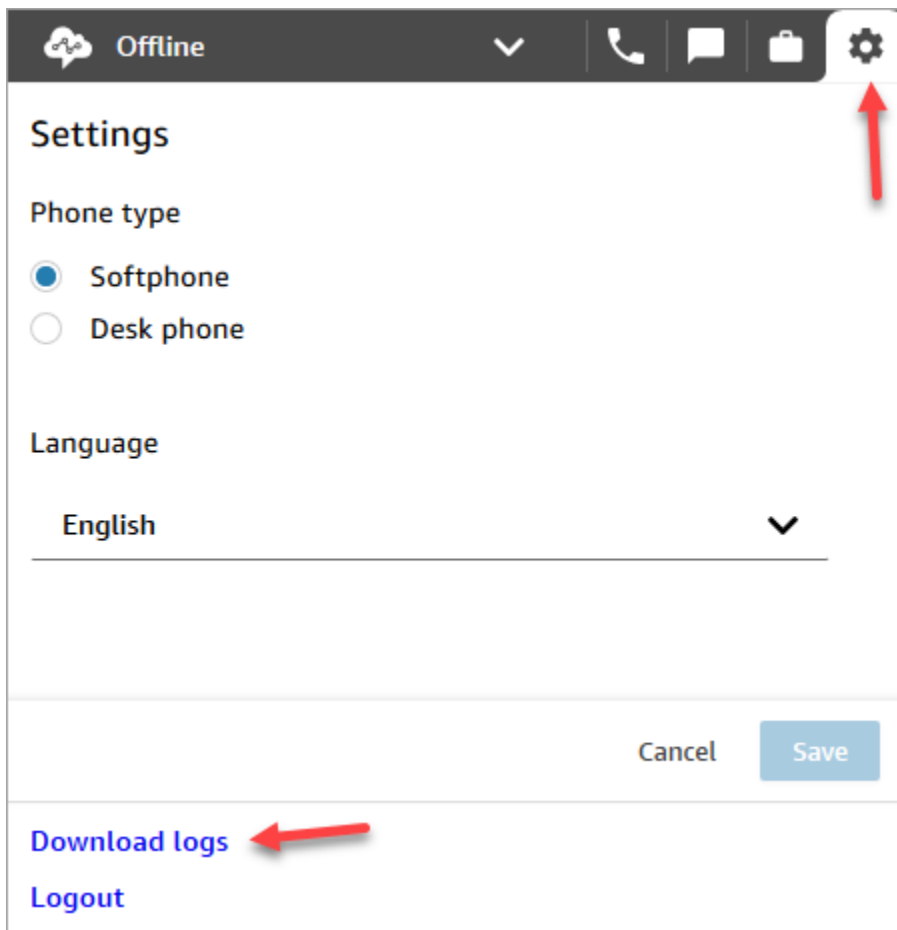

2. The `agent-log.txt` file is saved to your browser's default directory. After the file is downloaded, you can change the name of the file the same way you rename any other file on your computer. You can't customize the file name before the file is downloaded.

Troubleshooting Tools and Information

The following tools and information can be helpful with troubleshooting issues with Amazon Connect.

- **Instance ARN**—Provide your instance ARN (Amazon Resource Name) when you contact AWS support so that they can see the activity in your Amazon Connect instance. You can find the ARN for your instance on the Overview page that you access by choosing the alias of the instance from the Amazon Connect console.
- **Call recordings**—are very useful, not only to illustrate and determine reported behavior, but also to rule out audio issues from the agent's side. Recordings in Amazon Connect are done at the instance side of the interaction, before the audio traverses the agent connection. This allows you

to determine if the audio issue was isolated to the agent's side of the interaction or if it existed in the audio received by the agent. You can find call recordings associated with a contact in the Contact Search report.

- **Contact IDs from the contact record**—Provide when you contact AWS support.
- **Agent desktop performance/process logs**—can help rule out local resource/network contention.
- **Contact Control Panel (CCP) logs**—to track agent actions and timing. To download CCP logs, choose the settings cogwheel in the CCP, and then choose **Download logs**. The logs are saved to your browser's default download directory.
- **Network utilization logging/monitoring**—specifically for latency and dropped packets on the same network segment as your agents.
- **Private WAN/LAN network diagram**—outlining connection paths to the edge router to AWS to explain network traversal.
- **Firewall allowlist access**—to verify that IP/port ranges are added to the allowlist as described in [Set up your network](#).
- **Audio capturing and analytic tools**—for latency calculations from the agent's workstation.
- **AWS region latency test tools**—use the [Endpoint Test Utility tool](#).

Gathering Helpful Information using the Streams API

For tracking and troubleshooting issues at scale, collecting data surrounding overall call quality is recommended. Anytime poor call quality is experienced, agents can note the current time and corresponding disposition code by using the disposition key chart, as shown in the following chart. Alternatively, you can use the Streams API to incorporate your own report and issue feature in the custom CCP to write these dispositions with corresponding call information to a database, like Amazon DynamoDB. For more information about the Amazon Connect Streams API, see the GitHub repository at <https://github.com/aws/amazon-connect-streams>.

Example Agent Issue Report Disposition

The following example disposition keys are listed by symptom, scenario, and severity.

Symptom

- **S**—Softphone error
- **M**—Missed calls

- **L**—Latency causes poor quality
- **P**—Starts off OK, gets progressively worse over time
- **D**—Disconnected calls
- **W**—One way audio; for example, the agent can hear the customer, but the customer cannot hear the agent
- **V**—Volume too quiet or too loud
- **C**—Choppy/cuts in and out intermittently

Scenario

- **O**—Outbound call
- **I**—Inbound call
- **T**—Three-way call

Severity

- **1**—Small impact, but can use the CCP effectively
- **2**—Medium impact, communication is difficult, but can still service calls
- **3**—Large impact, cannot use the CCP to take calls

Examples

- 5:45PM agentName LT2 (latency on a three-way call with medium impact).
- 6:05PM agentName DO3 (disconnected outbound call with large impact).
- 6:34PM agentName MI3 (missed inbound call with large impact).

Analyzing the Data

The following guidelines can assist you in analyzing the data to identify issues in your environment.

- Use the Contact record / Contact search report to identify the contact IDs for the contacts during which call quality issues occurred. The contact record includes a link to the associated call recording, and additional details that you can use for symptom verification and to provide to your AWS support representative.

- Use the agent name and timestamp in the contact record to get a sense of the types of issues you're experiencing and their prevalence by agent, symptom, scenario, and severity over time. This will allow you to see if issues are happening around the same time, surround a specific event, or are isolated to specific agents or agent actions. You can also easily identify and access associated call recordings and associated contact IDs available if you need to engage support.
- Correlate data sources, such as local network logs, CPU/disk/memory utilization and process monitor logs from the operating system on the client workstation. This lets you correlate events by agent over time to rule out local resource contention as a cause or contributor.
- Analyze data by symptom and scenario reported per minute or per hour to create heat maps of an issue by type and severity by agent over time. Doing this is especially helpful in environmental troubleshooting as you may find clustered impacts associated with scheduled activity like backups or large file transfers.
- If you can't find any evidence of local resource contention or derive any noteworthy correlations, you can use the contact IDs collected to open a support case. If issues experienced are intermittent in nature, they most likely relate to issues with the agent's workstation, network connectivity, or both.

Validation Testing

Voice quality issues can have many contributing sources. It's important to run controlled tests and monitor the same environment or workstation as those reporting the issue, and be able to reproduce the same use cases. Consider the following general testing recommendations for measuring and gathering data to investigate voice quality issues.

PSTN and Agent Connection Latency

For troubleshooting cross-talk issues, you need to differentiate and measure agent and raw PSTN latency contributions, as they require different remediation efforts.

- [overall_latency] is the total latency experienced between caller and agent. This latency can be calculated as $[overall_latency] = [agent_latency] + [pstn_latency]$.
- [pstn_latency] is the latency between Amazon Connect endpoint and the caller. This latency can be calculated as $[pstn_latency] = [overall_latency] - [agent_connection_latency]$. This latency can be improved by using a different Amazon Connect Region location or avoiding external and circular transfers to geographically distant endpoint locations.

- [agent_latency] is the latency between Amazon Connect endpoint and the agent. This latency can be calculated as $[agent_latency] = [overall_latency] - [recording_latency]$. This latency can be improved by using AWS Direct Connect for agents on-premises, avoiding the use of VPN connections, improving private WAN/LAN performance/durability, or using an Amazon Connect Region location closer to your agents. Depending on your use case, selecting a different Region selection may also increase [pstn_latency].

Amazon Connect leverages CloudFront for connectivity. Not all CloudFront ranges are advertised over AWS Direct Connect. This means not all URLs generated by Amazon Connect are reachable over a Public Virtual Interface.

- [redirect_latency] is the latency resulting in redirecting audio to an external device. This latency can be calculated by measuring [overall_latency] once with redirect and once without and take the difference between the two.
- [forward_latency] is the latency resulting in forward calls to or from Amazon Connect. This latency can be calculated by measuring [overall_latency], once with forward and once without, and take the difference between the two.

Measuring Latency

- Reproduce your use case. Any deviations need to be measured and accounted for, because they skew test results.
- Match production controls and environment as much as possible. Use the same flows, phone numbers, and endpoint locations.
- Note the geographical locations of your callers, agents, and external transfer destinations, where applicable. If you are servicing multiple countries, each country should be tested individually to provide the same test coverage that your agents experience in production.
- Note mobile and land line use in your tests. Mobile networks can add latency and need to be measured and considered for customer, agent, and transfer endpoints, where applicable.
- Reproduce the business use case. If the agents use conference and transfer, be sure to test those scenarios. If circular transfers occur, which are not recommended, be sure to test those as well.
- Reproduce the agent environment by including the workstation environment, located on the same network segment, and using equipment your agents would use.

Requirements for Testing Latency

To perform effective testing for latency, the following are required:

- Call recording enabled to capture [agent_latency]. Without call recording, you can calculate only [overall_latency].
- A customer phone source. For testing, confirm call quality on an actual call from a customer.
- An agent phone, if redirecting audio to an external device. You must be able to record the input and output of this device.
- A third-party transfer endpoint, if applicable. Testing is best when performed on actual calls or transfers from a third party.
- An agent workstation with sound recording or analysis software.
- Reproducible use cases. Troubleshooting can be difficult for issues that cannot be reproduced.
- NTP or other method to sync timestamps to facilitate identifying specific contacts and when they occurred, especially when activity is occurring across multiple time zones.

Testing Inbound Calls Using a Soft Phone

This process allows you to complete a latency test scenario in about 15 seconds. Analyzing the results and marking timestamps takes approximately 1-2 minutes per recording.

1. Go to a quiet location.
2. Configure agent workstation to play audio from external speakers and make sure they are turned up.
3. Use the agent workstation to log in to the CCP.
4. Start recording using an audio capturing tool on the agent workstation.
5. From the customer's phone source, use a speaker phone to call the incoming number for your Amazon Connect instance. This could really just be any external phone source to simulate a customer call.
6. Answer the incoming call using the soft phone on the agent workstation.
7. Make sure that the customer phone is not muted.
8. On the customer side, use an object or your hand, tap loudly on the desk or table, and then immediately mute the customer phone.
9. Wait 3 or more seconds. Repeat steps 7-8 at least 3 times.
- 10 Stop recording on the agent workstation.

11. Open the recording in your audio analysis tool. You should be able to see both the initial tapping sound that you made on the desk, and the tapping sound on the agent line on the other end. Take the three deltas and average for your [overall_latency].
12. Optionally, to calculate [agent_latency], open the associated Amazon Connect call recording in your audio analysis tool. You should be able to see both the initial tapping sound and the sound when it arrives to the agent at the other end. Take the three deltas and average for your [recording_latency]. $[agent_latency] = [overall_latency] - [recording_latency]$. Repeat as needed.

Modify the test plan as necessary to fit your use case. As the steps change, the process of recording and analyzing the audio is the same. If you need to test conferences and transfers, take measurements as normal, and then take another measurement when the conference is active with the third party transfer endpoint.

Interpreting the Test Results

The impact of increasing [overall_latency] begins to be noticeable at approximately 300ms and can result in crosstalk above 500ms. The impact, and what level of latency is considered acceptable, depends on your use case. For recommended remediation efforts for decreasing latency, see the [PSTN and Agent Connection Latency](#).

Mobile phones (iPhone, Android) and iPads are not supported

The default version of the Contact Control Panel (CCP) does not work with mobile devices such as iPhones and iPads.

You can set up your CCP to forward the audio portion of the call to your mobile device. For instructions, see [Forward calls to a mobile device \(iPhone, Android\)](#).

Problem using the CCP: Agents can't make an outbound call

The top reason most agents can't make outbound calls from the CCP is because their instance of Amazon Connect has not been set up to make outbound calls.

To enable agents to make outbound calls

1. Open the Amazon Connect console at <https://console.aws.amazon.com/connect/>.

2. On the instances page, choose the instance alias. The instance alias is also your **instance name**, which appears in your Amazon Connect URL. The following image shows the **Amazon Connect virtual contact center instances** page, with a box around the instance alias.

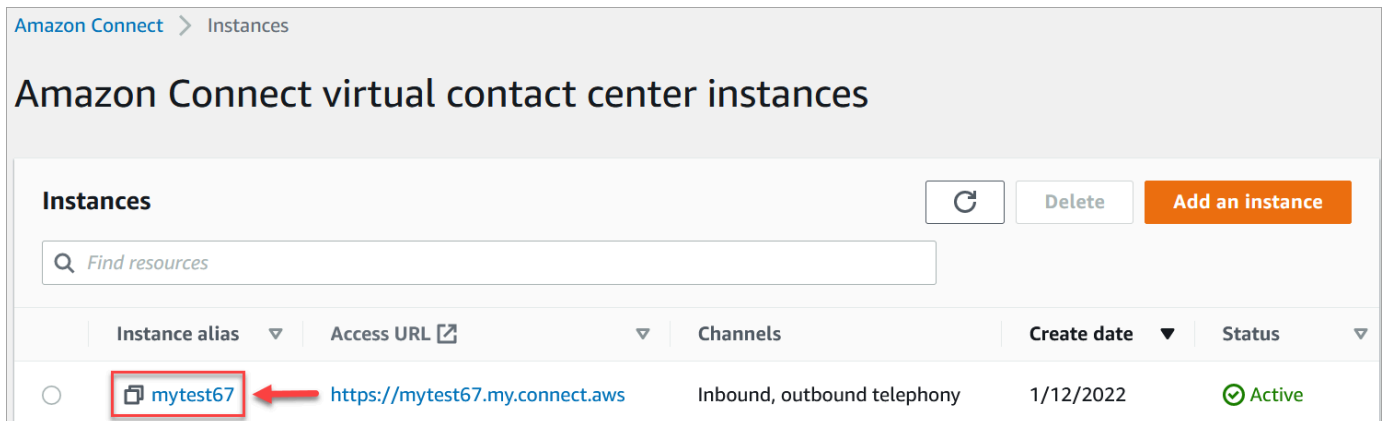

3. In the navigation pane, choose **Telephony**.
4. To enable outbound calling from your contact center, choose **I want to make outbound calls with Amazon Connect**.
5. Choose **Save**.

Internal firewall prevents access to chat or case attachments

This topic is for developers who need to investigate issues that may occur when using attachments with the chat channel in Amazon Connect, or when using attachments to upload files to cases.

The following issues may cause attachments to not display for your agents using Amazon Connect chat or Amazon Connect Cases.

Internal firewall settings are preventing access

Check that your firewall isn't preventing agents from accessing the files in your Amazon S3 bucket. You may need to add the Amazon S3 bucket where your files are stored to your domain allowlist. For more information, see [Set up your network](#).

Attachments are too large, too many, or don't meet file type requirements

Check that the attachments meet the size, number, and file type requirements. For more information, see [Amazon Connect feature specifications](#).

To calculate the size of an attachment (artifactSizeInBytes), use a third-party tool such as [File.size](#).

Humming sound in headset: Verify the headset and browser sample rates

If the agent's audio device does not support up to 48khz and the browser asserts a sample rate of 48khz, audio issues such as an audible humming sound may be present in the agent's outgoing audio. This has been seen with Firefox but not with Chrome.

Perform the following steps to verify your headset and browser sample rates.

Verify Firefox sample rate

1. Open the agent's CCP in FireFox, and set their status to **Available**.
2. Accept a call.
3. Open a second Firefox tab, and type **about:support** in the Search box.
4. Scroll down the page to **Media**.
5. Verify that the sample rates for the input and output devices are **48000**, as shown in the following image.

The screenshot shows the Firefox 'about:support' page. The 'Media' section is expanded, showing 'Audio Backend' as 'wasapi' and 'Preferred Sample Rate' as '48000'. Below this are two tables: 'Output Devices' and 'Input Devices'. In the 'Output Devices' table, the row for 'Headset Earphone (2- Plantronics Blackwire 5220 Series)' is highlighted with a red box, showing a 'Rate' of 48000. In the 'Input Devices' table, the row for 'Headset Microphone (Plantronics Blackwire 5220 Series)' is highlighted with a red box, also showing a 'Rate' of 48000.

Media									
Audio Backend	wasapi								
Max Channels	2								
Preferred Sample Rate	48000								
Roundtrip latency (standard deviation)	NaNms (NaN)								
Output Devices									
Name	Group	Vendor	State	Preferred	Format	Channels	Rate	Latency	
LG FULL HD (Intel(R) Display Audio)	INTELAUDIO\FUNC_01&VEN_8086&DEV_280B&SUBSYS_80860101&REV_1000\4&30c8f51a&0&0&0201		Enabled	None	default: F32LE, support: S16LE F32LE	2	default: 48000, support: 48000 - 48000	144 - 480	
Speaker (Conexant ISST Audio)	INTELAUDIO\FUNC_01&VEN_14F1&DEV_2008&SUBSYS_103C83B6&REV_1001\4&30c8f51a&0&0&0001		Enabled	None	default: F32LE, support: S16LE F32LE	2	default: 48000, support: 48000 - 48000	144 - 480	
Crestron (Intel(R) Display Audio)			Disabled	None	default: F32LE, support: S16LE F32LE	2	default: 48000, support: 48000 - 48000	0 - 0	
Headset Earphone (2- Plantronics Blackwire 5220 Series)	USB\VID_047F&PID_C053&MI_00\7&27d65d0&0&0&0000		Enabled	All	default: F32LE, support: S16LE F32LE	2	default: 48000, support: 48000 - 48000	144 - 480	
DELL U3415W (Intel(R) Display Audio)			Disabled	None	default: F32LE, support: S16LE F32LE	2	default: 48000, support: 48000 - 48000	0 - 0	
Input Devices									
Name	Group	Vendor	State	Preferred	Format	Channels	Rate	Latency	
Line In (Conexant ISST Audio)	INTELAUDIO\FUNC_01&VEN_14F1&DEV_2008&SUBSYS_103C83B6&REV_1001\4&30c8f51a&0&0&0001		Unplugged	None	default: F32LE, support: S16LE F32LE	2	default: 48000, support: 48000 - 48000	0 - 0	
Headset Microphone (Plantronics Blackwire 5220 Series)	USB\VID_047F&PID_C053&MI_00\7&8a32c9c&0&0&0000		Disabled	None	default: F32LE, support: S16LE F32LE	1	default: 48000, support: 48000 - 48000	0 - 0	
Headphones (Conexant ISST Audio)	INTELAUDIO\FUNC_01&VEN_14F1&DEV_2008&SUBSYS_103C83B6&REV_1001\4&30c8f51a&0&0&0001		Disabled	None	default: F32LE, support: S16LE F32LE	2	default: 48000, support: 48000 - 48000	0 - 0	
Headset Microphone (2- Plantronics Blackwire 5220 Series)	USB\VID_047F&PID_C053&MI_00\7&27d65d0&0&0&0000		Enabled	All	default: F32LE, support: S16LE F32LE	1	default: 48000, support: 48000 - 48000	144 - 480	

Verify Chrome sample rate

1. Open the agent's CCP in Chrome, and set their status to **Available**.

2. Accept a call.
3. Open a second Chrome tab, and type **chrome://about** in the Search box.
4. Scroll down the page and choose **chrome://media-internals**.
5. On the **Audio** tab, choose the **Input Controllers** and verify that the sample rate is **48000**. Then verify the sample rate for the Output Controllers.

← → ↻ Chrome chrome://media-internals

Players Audio Video Capture Audio Focus

Copy all to clipboard

General Information

Property	Value
AudioServiceLaunchOnStartup	"Disabled"
AudioServiceOutOfProcess	"Enabled"
AudioServiceOutOfProcessKillAtHang	"Enabled, timeout = <undefined> seconds"
AudioServiceSandbox	"Enabled"

Input Controllers

Controller 1:0

Output Controllers

Controller 0:0

Controller 2:0

Controller 3:0

Output Streams

Stream 3:1

Controller 1:0 Properties

Copy to clipboard

Property	Value
channel_layout	"MONO"
channels	1
device_id	"default"
device_type	"pcm_low_latency"
effects	"NO_EFFECTS"
frames_per_buffer	480
render_process_id	297
sample_rate	48000
status	"started"
web_contents_title	"Amazon Connect Contact Control Panel"

One-way audio from customers?

If an agent can hear the customer, but the customer can't hear the agent, this may be the result of an application taking exclusive control of agent's mic/speaker.

You can search the internet for articles that explain how to turn off exclusive-mode for a Windows audio playback device. For example, [Turning off Exclusive Mode in Windows 10 Home Edition](#).

To fix sound problems on a Mac, see [Change the sound input settings on Mac](#).

Release notes for Amazon Connect

We recommend subscribing to the RSS feed so updates to these notes are delivered to your Inbox. Click the **RSS** link (under the topic title **Release notes**) to subscribe.

June 2024 Updates

Amazon Connect outbound campaigns performance dashboard

You can use the outbound campaigns performance dashboard to understand the performance of your outbound campaigns across voice contacts. For more information, see [Outbound campaigns performance dashboard](#).

Route contact within a queue to a specific agent

You can now offer a contact in a queue to a specific agent or set of agents based on user ID; if the agent is not available within a given period of time, you can expire off the routing criteria to instead offer the contact to any available agent in queue. For more information, see [Routing using agent proficiencies](#).

Amazon Q in Connect recommends step-by-step guides

Amazon Q in Connect, a generative-AI powered assistant for contact center agents, recommends step-by-step guides in real-time. Agents use step-by-step guides to quickly take action to resolve customer issues. For more information, see [Integrate Amazon Q in Connect with step-by-step guides](#).

In addition, see the following new APIs that are part of this release:

- [CreateContentAssociation](#)
- [DeleteContentAssociation](#)
- [GetContentAssociation](#)
- [ListContentAssociations](#)

Updated look and feel for the Amazon Connect agent workspace

The Amazon Connect agent workspace features an updated user interface to improve the productivity and focus for your agents. The updated user interface is designed to be more intuitive and highly responsive, and it increases the visual consistency across capabilities. It provides your agents with a more streamlined user experience.

With this launch, you can also easily build and embed third-party applications that have a consistent look and feel with the agent workspace by using Cloudscape Design System components. For more information, see [Access third-party applications in the agent workspace](#).

May 2024 Updates

Multi-party calls

Agents in a multi-party call can add participants to the call after the customer has disconnected. Agents can use quick connects or the number pad on the Contact Control Panel to add participants.

Some examples:

- After a customer disconnects from a multi-party call, the agent can add another agent or supervisor to the call to continue the discussion.
- If a customer is accidentally dropped from a multi-party call, the agent can reinstate the customer without restarting the multi-party call by manually adding all the participants.

Note

You must enable multi-party calling to use this feature. For more information about enabling multi-party calling, see [Update telephony options](#).

Amazon Connect supports multiple features in Apple Messages for Business

As part of the Apple Messages for Business integration, Amazon Connect supports the ability to send Attachments, use Apple Forms, leverage Apple Pay, access iMessage Apps, and provide

authentication support. For more information on how to enable Apple Messages for Business, see [Enable Apple Messages for Business](#).

Set the forecast time zone

You can generate, view, and download forecasts in the time zone where your business operates. Amazon Connect automatically adjusts forecasts to account for daylight saving changes. For example, if your contact center receives contacts from 8AM-8PM US Eastern time, then forecasts will automatically switch from 8AM-8PM Eastern Daylight Time (EDT) to 8AM-8PM Eastern Standard Time (EST) on November 3, 2024.

Time zone support in forecasts simplifies the day-to-day experience for managers. For more information, see [Set the forecast time zone](#).

Updated AmazonConnectServiceLinkedRolePolicy service-linked role managed policy

Updated the service-linked role managed policy with the Amazon Q in Connect API action `wisdom:ListContentAssociations`. For a description of the additional action, see [Amazon Connect updates to AWS managed policies](#).

New flow and flow module analytics

You can use the following historical metrics for flows and flow modules to identify emergent issues, monitor usage patterns, and measure the impact of configuration changes across your customer or internal facing experiences:

- [Average flow time](#)
- [Flows started](#)
- [Flows outcome](#)
- [Flows outcome percentage](#)
- [Maximum flow time](#)
- [Minimum flow time](#)

These metrics are available in the Amazon Connect admin website. You can also access them programmatically by using the [GetMetricDataV2](#) API.

You can use the [flows dashboard](#) to view and compare real-time and historical aggregated performance, trends, and insights using custom-defined time periods (for example, week over week), charts, and tables. The flows dashboard can help you answer questions such as "how many contacts dropped out of my contact center before reaching a queue?" or "how long does it take for contacts to navigate through my self-service voice flow?"

Create rules for monitoring flow metrics

You can configure rules to automatically create a task, send an email, or generate an Amazon EventBridge event whenever a flow or flow module metric breaches the threshold you define. For example, you can create a rule to assign a task to a contact center administrator whenever the dropped rate (that is, a percentage of contacts that dropped from a flow) for your inbound welcome flow exceeds 10% over a trailing 4 hour window. For more information, see [Create alerts on real-time metrics](#).

New Amazon Connect Cases APIs

Amazon Connect Cases provides attached file APIs that make it easy to upload attachments, check attachments details, and delete attachments from cases. For more information on enabling and working with attachments, see [Enable attachments](#) and [Uploading Attached Files](#). To view the attached file APIs, see [Files actions](#).

Amazon Connect Contact Lens provides generative AI-powered agent performance evaluations (Preview)

Amazon Connect Contact Lens provides managers with generative AI-powered recommendations for answers to questions in agent evaluation forms, enabling them to perform evaluations faster and more accurately. For more information, see [Evaluate performance using generative AI \(preview\)](#).

New metrics available on the Historical metrics page

The following metrics are available on the **Historical metrics** page in the Amazon Connect admin website. For a description of each metric, see [Historical metrics definitions](#).

- Abandonment rate
- Agent non-response without customer abandons

- Average contact duration
- Average conversation duration
- Average customer hold time all contacts
- Average agent greeting time
- Average agent interruptions
- Average holds
- Average agent interruption time
- Average non-talk time
- Average resolution time
- Average talk time
- Average agent talk time
- Average customer talk time
- Agent talk time percent
- Customer talk time percent
- Talk time percent
- Non-talk time percent
- Contacts handled (connected to agent timestamp)
- Contacts queued (enqueue timestamp)
- Callback attempts
- Contacts abandoned in X
- Contacts answered in X
- Contacts resolved in X

April 2024 Updates

New definitions for NextContactId and PreviousContactId

NextContactId and PreviousContactID have new definitions. For more information, see [ContactTraceRecord](#).

Use screen recording with multiple agents connecting to the same desktop in your environment

You can enable agent screen recording when your VDI environment is configured to allow multiple agents to connect concurrently to the same Windows instance (multi-session VDI). This makes it even easier and more cost effective for you to help agents improve their performance when using Amazon Connect in a multi-session VDI environment.

To use this update, download the latest version of the screen recording client application. For the download location, see [Amazon Connect Client Application](#).

Voice contacts rejected by an agent have a state of REJECTED

Voice contacts rejected by an agent used to have a state of ERROR for Contact State in the Agent Event Stream. Now they have a state of REJECTED, which is the same as chat and task contacts. This is also reflected on Real-time metrics for the agent.

March 2024 Updates

Contact Lens enables you to automatically fill and submit evaluations

Contact Lens enables you to automatically fill and submit evaluations, using insights and metrics from conversational analytics. For more information on creating a rule that submits an automated evaluation, see [Create a rule that submits an automated evaluation](#).

Amazon Connect allows you to create rich, interactive chat experiences for customers using step-by-step guides

Amazon Connect allows you to create rich, interactive chat experiences for customers using step-by-step guides, that help resolve issues faster and improve the customer experience. For more information, see [How to deploy step-by-step guides in chats](#).

Amazon Connect agent workspace supports third-party applications in general availability

The Amazon Connect agent workspace now supports third-party applications in general availability. Agents can use Amazon Connect's native agent applications (Q in Connect, Cases, Customer Profiles, and Step-by-step Guides) alongside internal or custom-built agent applications,

all within a unified agent workspace. For more information, see [Integrate third-party applications \(3p apps\) in the agent workspace](#), [Screen pop applications](#), the [Agent Workspace developer guide](#), the [Amazon Connect API reference guide](#), and the [Amazon AppIntegrations API reference](#).

GA for generative AI-powered post-contact summaries

Released generative AI-powered post-contact summaries for general availability. This feature summarizes long customer conversations into succinct, coherent, and context rich contact summaries. For example, a summary might say "The customer didn't receive a reimbursement for a last minute flight cancellation and the agent didn't offer a partial reimbursement as per the SOP." Use these summaries to help supervisors improve the customer experience by getting faster insights when reviewing contacts, saving time on quality and compliance reviews, and more quickly identifying opportunities to improve agent performance.

For more information, see [View generative AI-powered post-contact summaries](#).

Hierarchy-based access control (Preview)

In addition to tags, you can enable granular access controls for users by [configuring agent](#) hierarchies within the Amazon Connect admin website. Assigning hierarchies to a user allows you to define organizational groups that a user belongs to, and you can restrict users from accessing others outside their hierarchy by configure granular permissions. For example, you can configure hierarchy groups and levels for a BPO, such as Acme Corp, and only users assigned to hierarchy groups under Acme Corp will be able to see or edit these users. To learn more about using agent hierarchies to enforce granular access controls for users, see the [Hierarchy access control \(Preview\)](#).

February 2024 Updates

Amazon Connect provides case management metrics

Amazon Connect Cases provides the following metrics for case management:

- [Average case resolution time](#)
- [Average contacts per case](#)
- [Cases created](#)
- [Cases reopened](#)
- [Cases resolved](#)
- [Cases resolved on first contact](#)

- [Current cases](#)

These metrics give you insights into case volumes and performance. You can view new reports using the historical metrics dashboard in the Amazon Connect admin website to analyze case resolution performance based on point in time snapshots or specific time intervals.

Amazon Connect Cases provides audit history on cases

Amazon Connect Cases provides audit history on cases, allowing you to see which users worked on a case, what changes they made, and the order in which those changes occurred. This launch makes it easier for contact center agents and managers to understand what happened on a case for improved collaboration, quality assurance, and compliance. For information on how to enable the feature for your users, see [Assign permissions](#). Also, see [GetCaseAuditEvents](#) in the *Amazon Connect API Reference*.

January 2024 Updates

GA for Amazon Connect outbound campaigns voice dialing API

Released the [PutDialRequestBatch](#) for general availability. This API enables you to use your own list management capability to set up the contact strategy (for example, campaign start and end times, do-not-call times, maximum contact attempts) while programmatically using Amazon Connect predictive dialer with machine learning (ML)-powered answering machine detection. This helps increase live-party connections.

Barge for chat: Managers can join ongoing chats between agents and customers

Managers can join and participate in ongoing chats between agents and customers, ensuring that even the most complex customer issues are resolved quickly and accurately. For more information, see [Barge live voice and chat conversations](#). Also see updates to the [MonitorContact](#) and [SendEvent](#) APIs.

GetRecommendations and QueryAssistant APIs will be discontinued starting June 1, 2024

Two Amazon Q in Connect APIs—[GetRecommendations](#) and [QueryAssistant](#)—will be discontinued starting June 1, 2024. To receive generative responses after March 1, 2024, you will need to create

a new Assistant in the Amazon Connect console and integrate the Amazon Q in Connect JavaScript library (amazon-q-connectjs) into your applications.

High-quality voice experiences for agents using Citrix Virtual Desktop Infrastructure (VDI) environments.

Amazon Connect allows you to deliver high-quality voice experiences when your agents use Citrix Virtual Desktop Infrastructure (VDI) environments. Your agents can leverage the Citrix remote desktop application to offload audio processing to the agent's local device and to automatically redirect audio to Amazon Connect, resulting in a simpler agent experience and improved audio quality over challenging networks. For more information, see [Citrix VDI with Amazon Connect audio optimization](#).

Granular access controls using resource tags for historical metrics reports

You can apply granular permissions to resource metrics that are included in historical metrics reports. For more information, see [Apply tag-based access control to historical metrics reports](#).

December 2023 Updates

Update to third-party applications preview

Added support for third-party applications (preview) to listen to Amazon Connect contact and agent events.

Expanded AWS Regions to support: US East (N. Virginia), US-West (Oregon), Africa (Capetown), Asia Pacific (Seoul), Asia Pacific (Singapore), Asia Pacific (Sydney), Asia Pacific (Tokyo), Canada (Central), Europe (Frankfurt), and Europe (London).

Amazon Connect provides granular access controls using resource tags configured for hours of operation and prompts in the Amazon Connect admin website

Provide granular access controls using resource tags configured for hours of operation and prompts in the Amazon Connect admin website. For example, you can tag hours of operation with `Division:HumanResources`, and then only let HR administrators see and edit those work hours.

Prompts are audio files, such as on-hold music, that can be customized and configured to play within call flows. For example, you can tag celebrity prompts with `Department:Insurance`, and then only let administrators from your insurance line of business access those prompts.

Amazon Connect provides an API to programmatically update the priority of contacts

Programmatically update the priority of contacts, such as voice calls, callbacks, chats, and tasks, in addition to the existing [Change routing priority/age](#) flow block. With this API, you can update a contact's or customer's position in a queue directly from your custom monitoring dashboards. For more information, see the [UpdateContactRoutingData](#) API.

Route contacts according to the proficiency of agents

You create and use agent proficiencies for routing a contact to the best available agent in a queue. Each proficiency indicates an agent's level of expertise in a predefined attribute such as language fluency, skillset, or customer issue types they support. For more information, see [Routing using agent proficiencies](#).

Added Amazon Connect Cloudformation resources

Added [AWS::Connect::PredefinedAttribute](#) and [AWS::Connect::User UserProficiency](#) Cloudformation resources.

Amazon Connect Contact Lens provides an API to programmatically search for contacts

Programmatically search for contacts using filters such as contact attributes (time range, agent, channel, queue, etc.) and keywords within a conversation. Using this API, you can build custom user interfaces that enable managers and agents to search for completed or in progress contacts. For more information, see the [SearchContacts](#) API.

Pause and resume tasks

You can pause and resume all tasks that aren't expired, disconnected, or scheduled for a later time. This enables agents to free up an active slot so they can receive more critical tasks when their current task is stalled, for example, because of a missing approval or waiting on an external

input. For more information, see [Concepts: Pause and resume tasks](#). Also see the [PauseContact](#) and [ResumeContact](#) APIs.

Manage your cases and set up escalation workflows using the rules designer in the Amazon Connect UI

you can create rules to automatically create a task, update a case, or send email alerts to a manager whenever a case is created or updated. In addition, you can create rules leveraging Amazon Connect Contact Lens to automatically create a case for post-conversation follow-up, such as when negative customer sentiment or specific key words are detected in a conversation.

For more information, see [Monitor and update cases](#), [Amazon Connect Cases - rules integration onboarding](#), [Create a rule that creates a case](#), [Create a rule that ends associated tasks from a case](#), and [Create a rule that updates a case](#).

Get a more granular view of your Amazon Connect bill and usage

You can get detailed billing reports in AWS Cost Explorer and AWS Cost & Usage Reports by using cost allocation tags (key:value pairs) to aggregate the data. You can gain more insights into your Amazon Connect bill and better organize your bill by lines of business/departments (for example, support, banking, sales, claims), types of issues, phone numbers, environments, and more.

For more information, see [Set up granular billing for a detailed view of your Amazon Connect usage](#). Also see [TagContact](#) and [UntagContact](#) in the *Amazon Connect API Reference*.

Customer Profiles calculated attributes that turn customer data into actionable insights

Amazon Connect Customer Profiles enables contact center managers to create calculated attributes that turn customer behavior data (contacts, orders, web visits) into actionable customer insights such as a customer's preferred channel to drive dynamic routing, personalize IVRs, and provide agents with more relevant customer context. For more information, see the [Amazon Connect admin website](#) documentation.

Contacts Answered/Abandoned in X

On the **Real-time metrics** page, you can define custom thresholds for [Contacts Abandoned in X](#) and [Contacts answered in X](#), where X is a time range that you specify.

November 2023 Updates

Customer Profiles provides a generative AI powered customer data mapping capability

Customer Profiles provides a generative AI powered customer data mapping capability that significantly reduces the time needed to create unified profiles, which allows you to create more personalized customer experiences more efficiently. For more information, see [Generative AI powered data mapping](#).

No-code UI builder for step-by-step guides

This feature allows you to create and manage the UI pages shown to agents in step-by-step guides. Using a drag-and-drop interface you are able to define static and dynamic content for the agent's UI. This includes layouts, styles, and dynamic data, which enables you to control the look and feel of your agent's experience. With this capability, you are able to define what gets displayed in your agent's UI during the step-by-step guided experience. For more information, see the [No-code UI builder](#) documentation.

Added Amazon Q in Connect

Amazon Q in Connect is a generative AI customer service assistant. It is an LLM-enhanced evolution of Amazon Connect Wisdom that delivers real-time recommendations to help contact center agents resolve customer issues quickly and accurately.

Amazon Q in Connect automatically detects customer intent during calls and chats using conversational analytics and natural language understanding (NLU). It then provides agents with immediate, real-time generative responses and suggested actions. It also provides links to relevant documents and articles.

For more information, see [Use Amazon Q in Connect for generative AI-powered agent assistance in real-time](#) and the [Amazon Q in Connect API Reference](#).

Amazon Connect Contact Lens provides real-time conversational analytics for chat

Contact Lens provides real-time conversational analytics for chat, extending the machine learning-powered post-contact analytics (for example, sentiment analysis, automated contact

categorization, and more) to real-time contact scenarios. These capabilities enable contact center managers to help detect customer issues during in-progress chat contacts, and help them resolve customer issues faster. For example, managers can get a real-time email alert when customer sentiment for a chat contact turns negative, allowing them to join the in-progress contact and help resolve the customer issue.

For more information, see [Analyze conversations using conversational analytics](#). In addition, see the [ListRealtimeContactAnalysisSegmentsV2](#) action in the *Amazon Connect API Reference*.

Amazon Connect Contact Lens provides generative AI-powered post-contact summaries (Preview)

Contact Lens provides generative AI-powered post-contact summaries, enabling contact center managers to more efficiently monitor and help improve contact quality and agent performance.

Contact Lens already labels parts of contact transcripts as issue, outcome, and action item. With this launch, Contact Lens condenses a long customer conversation into a concise and coherent summary (for example, customer didn't receive reimbursement for last minute flight cancellation, and the agent didn't offer partial reimbursement as per the SOP). This enables managers to help reduce the overall time spent on evaluating contact quality and agent performance, as they no longer have to read long contact transcripts or listen to call recordings.

For more information, see [View generative AI-powered post-contact summaries](#).

Amazon Connect supports in-app, web, and video calling

The Amazon Connect in-app, web, and video calling capabilities enable your customers to contact you without ever leaving your web or mobile application. You can use these capabilities to pass contextual information to Amazon Connect. This enables you to personalize the customer experience based on attributes such as the customer's profile or other information, like actions previously taken within the app.

For more information, see [Set up in-app, web, and video calling capabilities](#). In addition, see the [StartWebRTCContact](#) action in the *Amazon Connect API Reference*.

Amazon Connect supports two-way SMS

Amazon Connect supports two-way Short Messaging Service (SMS) capabilities, making it easy for you to resolve customer issues by text messaging. SMS offers a ubiquitous and convenient channel for customers to get help, while enabling you to deliver personalized experiences at a lower cost.

To get started, claim your two-way SMS number from Amazon Pinpoint SMS and associate the number with your Amazon Connect instance. Amazon Connect SMS uses the same automation, routing, configuration, analytics, and agent experience as calls and chats, making it easy to deliver seamless omnichannel customer experiences.

For more information, see [Set up SMS messaging](#). In addition, see the following new actions in the [Amazon Connect API Reference Guide](#).

- AssociateFlow
- DisassociateFlow
- GetFlowAssociation
- ImportPhoneNumber
- ListFlowAssociations
- SendChatIntegrationEvent

Analytics data lake (Preview)

You can use Analytics data lake as a central location to query various types of data from Amazon Connect. This data includes contact records and Contact Lens conversational analytics. Data is refreshed around every 24 hours. You can use the Analytics data lake to create custom reports or run SQL queries.

For more information, see [Access Analytics data lake](#). In addition, see new actions in the [Analytics data lake actions](#) topic in the *Amazon Connect API Reference*.

Added metrics to the GetMetricDataV2 action

Added the following agent and contact performance metrics to the [GetMetricDataV2](#) action:

- [After contact work time](#)
- [Agent interaction and hold time](#)
- [Agent interaction time](#)
- [Contact flow time](#)
- [Contact handle time](#)
- [Contacts hold agent disconnect](#)

- [Contacts hold customer disconnect](#)
- [Contacts put on hold](#)
- [Customer hold time](#)
- [Contacts transferred out external](#)
- [Contacts transferred out internal](#)
- [Agent answer rate](#)
- [Agent idle time](#)
- [Error status time](#)
- [Non-Productive Time](#)
- [Online time](#)
- [Agent outbound connecting time](#)
- [Agent on contact time](#)
- [Non-adherent time](#): This metric is available in AWS Regions where Forecasting, capacity planning, and scheduling is available.

Customer Profiles block enhancements

You can access more customer information, including orders, cases, assets, custom attributes, and calculated attributes through the Customer Profiles Flow block. For more information, see [Flow block: Customer profiles](#).

View and manage applied service quotas for Amazon Connect using AWS Service Quotas

Service Quotas allows you to view both default and applied quota values for resources used by each of your Amazon Connect instances. When requesting a quota increase, Service Quotas allows you to indicate both the Amazon Connect quota and desired value. For quotas that support resource level adjustability you can also specify your Amazon Connect instance. For more information, see [Amazon Connect service quotas](#).

Added an action to AmazonConnectServiceLinkedRolePolicy

Updated AmazonConnectServiceLinkedRolePolicy with an action for Amazon Q in Connect. For a description of the additional action, see [Amazon Connect updates to AWS managed policies](#).

Amazon Connect provides a Contact Lens conversational analytics dashboard

Amazon Connect provides a pre-built Contact Lens conversational analytics dashboard that enables customers to understand why customers are contacting, the trends of contact drivers over time, and the performance of each of those call drivers (for example, average handle time for call driver “where’s my stuff?”). For more information, see [Contact Lens conversational analytics dashboard](#).

Amazon Connect provides a pre-built queue performance dashboard

Amazon Connect provides a pre-built queue performance dashboard that helps contact center managers analyze, track, and improve contact center performance. This dashboard enables managers to view and compare real-time and historical aggregated queue performance using custom-defined time periods (for example, week over week), a summary chart, and a time series graph. For more information, see [Queue performance dashboard](#).

Amazon Connect prompts configuration page provides CloudTrail coverage

The prompts configuration user interface has been updated to make it more efficient for you to manage prompts. In addition, when you add, update or delete a prompt from the Amazon Connect admin website, a record of that activity is available in AWS CloudTrail for visibility, reporting, and compliance. For example, you may notice a discrepancy in the IVR prompt that customers hear when they call your support line. To investigate, you can leverage AWS CloudTrail to answer questions such as, "who saved this recording?" and "when was this prompt changed?" For more information about the new prompts page, see [Create prompts](#).

Amazon Connect enables integration with your preferred file scanning application to detect malware

You can integrate Amazon Connect with your preferred file scanning application to detect malware or other unwanted content in attachments before they can be shared in a chat or uploaded to a case. This capability provides an additional layer of protection for your customers and organization by preventing malicious files from being shared and downloaded. For more information, see [Set up attachment scanning](#).

Amazon Connect outbound campaigns voice dialing API

You can create contacts for all high-volume voice outreach by using the [BatchPutContact](#) API. This API makes it easier for you to track outcomes of all campaign calls by using the Amazon Connect [contact record](#).

Amazon Connect Cases supports author name on comments

You can programmatically add and view author comments by using the [CreateRelatedItem](#) and [SearchRelatedItems](#) APIs.

Updated AmazonConnectCampaignsServiceLinkedRolePolicy service-linked role managed policy

Updated the service-linked role managed policy for outbound campaigns. For a description of the additional actions, see [Amazon Connect updates to AWS managed policies](#).

Added Create persistent chat association flow block and CreatePersistentContactAssociation API

You can set up a chat to be persistent either when the chat session is initially created or at any time during the lifetime of the chat. To set up persistent chat after the chat session has started, use the new [CreatePersistentContactAssociation](#) API or include the new [Create persistent contact association](#) block in your flow.

Optimization to how the CCP detects and handles stale WebSocket connections

When an agent initializes the CCP, a WebSocket connection is opened and it is used during subsequent contact handling. If that agent experiences poor network conditions, this may result in the agent becoming unreachable without the backend detecting it. With this release the WebSocket connections for these agents are detected as stale and cleaned in 1-2 minutes.

Amazon Connect can identify, within about 2 minutes, a situation where a chat customer and an agent are on a chat contact, and the agent becomes unreachable (for example, as a result of losing wifi or losing power to their local machine), allowing the backend to run the chat disconnect flow. Before this optimization, it could take up to 10 minutes to run any chat disconnect flows.

Added new service-linked role policy and service-linked role

Added `AmazonConnectSynchronizationServiceRolePolicy` service-linked role policy and `AWSServiceRoleForAmazonConnectSynchronization` service-linked role for managed synchronization. The policy and role provide access to read, create, update, and delete Amazon Connect resources and is used to automatically synchronize AWS resources across AWS regions. For more information, see [AWS managed policy: AmazonConnectSynchronizationServiceRolePolicy](#) and [Using service-linked roles for Amazon Connect Managed Synchronization](#).

Added Contact Lens conversational analytics metrics to the `GetMetricDataV2` API

You can analyze aggregate agent and contact performance using Contact Lens conversational analytics metrics in the [GetMetricDataV2](#). The following new metrics were added: **non-talk time percent**, **talk time percent**, **talk time agent percent**, and **talk time customer percent**. For descriptions of these metrics, see [Historical metrics definitions](#).

Added configuration management across AWS Regions for Amazon Connect Global Resiliency customers

Amazon Connect Global Resiliency customers can use the [ReplicateInstance](#) API to copy configuration information for resources such as users, routing profiles, queues, and flows across AWS Regions. The API also automatically matches the service quotas for these resources across AWS Regions as part of the replication process. For more information, see [Create a replica of your existing Amazon Connect instance](#).

Added the [BatchGetFlowAssociation](#) API. Use this API to obtain a list of flow-associations for the resource identifiers provided in the API request. For example, you can list which phone numbers are associated with which flows in an Amazon Connect instance.

October 2023 Updates

Added actions to `AmazonConnectServiceLinkedRolePolicy`

Updated `AmazonConnectServiceLinkedRolePolicy` with actions for Amazon Connect Customer Profiles. For a description of the additional actions, see [Amazon Connect updates to AWS managed policies](#).

Third-party applications preview

You can integrate third-party applications into the agent workspace. For more information, see [Integrate third-party applications \(3p apps\) in the agent workspace](#) and the [Amazon Connect agent workspace third-party developer guide](#).

Added actions to AmazonConnectServiceLinkedRolePolicy

Note

In November 2023 we released Amazon Q. It includes real-time agent assist functionality formerly known as Amazon Connect Wisdom, along with generative AI-powered recommended responses, actions, and links to more information.

Updated AmazonConnectServiceLinkedRolePolicy with actions for Amazon Connect Wisdom. For a description of the additional actions, see [Amazon Connect updates to AWS managed policies](#).

Added the UpdatePhoneNumberMetadata API

Use the [UpdatePhoneNumberMetadata](#) to update the metadata for a phone number, such as the phone number description.

Add as many as four access control tags to a single security profile

Adding additional access control tags will make a given security profile more restrictive. For example, if you add four access control tags like `BPO:AcmeCorp`, `Specialty:Claims`, `Department:Billing`, and `City:NewYork`, the user would only be able to see resources containing all four of these tags. For more information, see [Tag-based access control](#).

Added actions to AmazonConnectServiceLinkedRolePolicy

Updated AmazonConnectServiceLinkedRolePolicy with actions for Amazon Connect Customer Profiles. For a description of the additional actions, see [Amazon Connect updates to AWS managed policies](#).

CTI Adapter upgrade for third-party cookies

This upgrade prevents the blocking of third-party cookies from impacting Amazon Connect across Chrome and all supported browsers. For more information, see [Amazon Connect CTI Adapter for Salesforce](#) release notes and [Using Amazon Connect with third-party cookies](#).

Create and customize up to 15 communications widgets

You can create and customize up to 15 communications widgets per Amazon Connect instance. For more information, see [Add a chat user interface to your website](#).

Access the trailing 90 days of historical agent and contact metrics

You can access the trailing 90 days of historical agent and contact metrics (for example, [Service level X](#), [Average handle time](#)) by using the [GetMetricDataV2](#) API. You can also make requests spanning up to 35 days with data categorized by customizable time intervals such as 15 minutes, hourly, or weekly.

In addition, added the following metrics to the GetMetricDataV2 API. These metrics are not available in Amazon Connect admin website.

- [Abandonment rate](#)
- [Agent non-response without customer abandons](#)
- [Average customer hold time all contacts](#)
- [Average resolution time](#)
- [Contacts resolved in X](#)

Added actions to AmazonConnectServiceLinkedRolePolicy

Note

In November 2023 we released Amazon Q. It includes real-time agent assist functionality formerly known as Amazon Connect Wisdom, along with generative AI-powered recommended responses, actions, and links to more information.

Updated AmazonConnectServiceLinkedRolePolicy with actions for Amazon Connect Wisdom. For a description of the additional actions, see [Amazon Connect updates to AWS managed policies](#).

September 2023 Updates

Released Amazon Connect Client Application v1.0.2.38

Released Amazon Connect Client Application v1.0.2.38. This version contains minor fixes and improvements. For more information, see [Amazon Connect Client Application](#).

Added "View my contacts" permission

Added a new security profile permission: View my contacts. On the **Contact search** page, agents who have this permission can access the contacts that they've handled. If you're using Contact Lens, agents can also review the analyzed recording and transcripts of the contact. For more information, see [Security profile permissions for Contact Lens](#).

Streams API upgrade for third-party cookies

This upgrade prevents the blocking of third-party cookies from impacting Amazon Connect across Chrome and all supported browsers. For more information, see [Using Amazon Connect with third-party cookies](#).

Create alerts on real-time metrics

You can create rules that automatically send emails or tasks to managers based on the values of real-time metrics. This enables you to alert managers on contact center operations that could potentially impact the end-customer experience.

For more information, see [Create alerts on real-time metrics](#).

"Maximum contacts in queue" includes all channels

If you have a queue that combines more than one channel, and you set a custom value for **Maximum contacts in queue**, the queue stops accepting new contacts after that number is reached, regardless of the distribution of contacts. For example, if you set the value to 50, and the first 50 contacts are chats, then voice calls are not routed to this queue.

For more information, see [Set the Maximum contacts in queue limit](#).

Manage contacts from the Contact details page

On the **Contact details** page of an in-progress contact, you can manage a contact by transferring, rescheduling, or ending the contact. For more information, see [Manage contacts from the Contact details page](#).

Upload file attachments to cases

Agents can upload file attachments to cases. For more information, see [Enable attachments to share files using chat and upload files to cases](#). For a list of supported file types, see [Amazon Connect feature specifications](#).

In addition, when agents leave comments on cases, their name is included.

Search for in-progress contacts

You can search for in-progress contacts on the **Contact search** page. For more information, see [Search for in-progress contacts](#).

Subscribe to the Contact Data Updated event in the contact event stream

You can subscribe to an event type called CONTACT_DATA_UPDATED. The Contact object includes an UpdatedProperties field. This enables you to monitor for changes to scheduled timestamp for tasks, and changes to user-defined attributes on the contact record. In addition, hierarchy groups information in the AgentInfo object is included for CONTACT_DATA_UPDATED, CONNECTED_TO_AGENT, and DISCONNECTED event types. For more information, see [Contact events data model](#).

APIs to programmatically configure views in step-by-step guides

Amazon Connect provides APIs to programmatically create and manage view resources used in step-by-step guides. View resources define what gets displayed in your agent's UI during a step-by-step guide. For more information, see the [View resource](#) documentation.

Support for UIFN in more than 60 countries

Amazon Connect supports Universal International Freephone number (UIFN) in more than 60 countries that are registered with the International Telecommunications Union, an organization

that supports the administration of the UIFN service. Amazon Connect allows you to enable UIFNs in as many countries as you need, with a requirement of at least 5 countries. For more information, see [UIFN service - Inbound only](#).

August 2023 Updates

Voice dialing for outbound campaigns, no agents required

You can use Amazon Connect outbound campaigns for high-volume outreach with no agents required. A new dialer type called "Agentless" makes it easier to proactively communicate with your customers for use cases such as personalized voice notifications and appointment reminders. For more information, see [Create an outbound campaign](#) and the [CreateCampaign](#) API.

Amazon Connect Cases supports nine additional languages

Amazon Connect Cases supports nine additional languages. You can view the Amazon Connect Cases user interface in any language supported by Amazon Connect regardless of your AWS Region. For more information, see [Amazon Connect Cases](#).

Granular access controls using resource tags for the agent activity audit report

You can apply granular permissions to the agent activity audit report in the Amazon Connect historical metrics UI using resource tagging and tag-based access controls. For more information, see [Agent activity audit tag-based access control](#) and [Tag-based access control](#).

Enhanced user bulk edit

You can update up to 100 user records on the Amazon Connect admin website in less than half the time it used to take to make bulk updates. This enhancement is especially useful during contact surges when you may need to change the routing profile for many agents. For more information, see [Edit users in bulk](#).

Amazon Connect scheduling supports agent group activities

Amazon Connect scheduling allows contact center managers to more efficiently create and manage activities for groups of agents. For more information, see [Add shift activities in draft or published schedules](#).

GA for global sign-in and agent distribution capabilities

Released the following Amazon Connect Global Resiliency capabilities for general availability: global sign-in and agent distribution across Amazon Connect Regions. This release includes:

- A global sign-in endpoint that enables agents to sign in once and be logged into multiple AWS Regions. This eliminates the need to log off / log back into either region separately
- An API action to provision agents that are "global" and available in both Regions.
- An API action to distribute agents across these AWS Regions by percentage in 10% increments (for example, 100% in US East (N. Virginia) and 0% in US West (Oregon), or 50% in each Region). This provides you with the flexibility to slowly shift agents across Regions or all at the same time.
- Custom and embedded Contact Control Panel enhancements that enable agents to process contacts from their current active Region without needing to know which Region is active at any given time.

For more information, see [Set up your agent's experience with Amazon Connect Global Resiliency](#).

Also see the following new APIs:

- [AssociateTrafficDistributionGroupUser](#)
- [DisassociateTrafficDistributionGroupUser](#)
- [ListTrafficDistributionGroupUsers](#)

Updated [UpdateTrafficDistribution](#) with `SignInConfig` and `AgentConfig` parameters.

To create a CloudFormation template for traffic distribution groups, see the following topic:

- [AWS::Connect::TrafficDistributionGroup](#)

100 rows on real-time metrics tables

You can now view up to 100 rows in the real-time metrics tables on the **Real-time metrics** page. Previously, the maximum was 50 rows. For more information about real-time metrics, see [Real-time metrics reports](#).

Sorting on column header names

You now have the ability to sort by choosing a column header, rather than choosing the smaller arrow next to the header text. For more information about real-time metrics, see [Real-time metrics reports](#).

Route based on time since last inbound contact

Added an option to specify that selected agents with this routing profile will not have their routing order impacted by outbound contacts. For more information, see [Create a routing profile](#).

July 2023 Updates

Customize the names of flow blocks

To help you distinguish blocks in a flow, you can customize the names of blocks. For example, you might rename a *Play Prompt* flow block to *Welcome message* or a *Get customer input* flow block to *Hotel booking Lex bot*. The following GIF shows how to customize the name of a flow block.

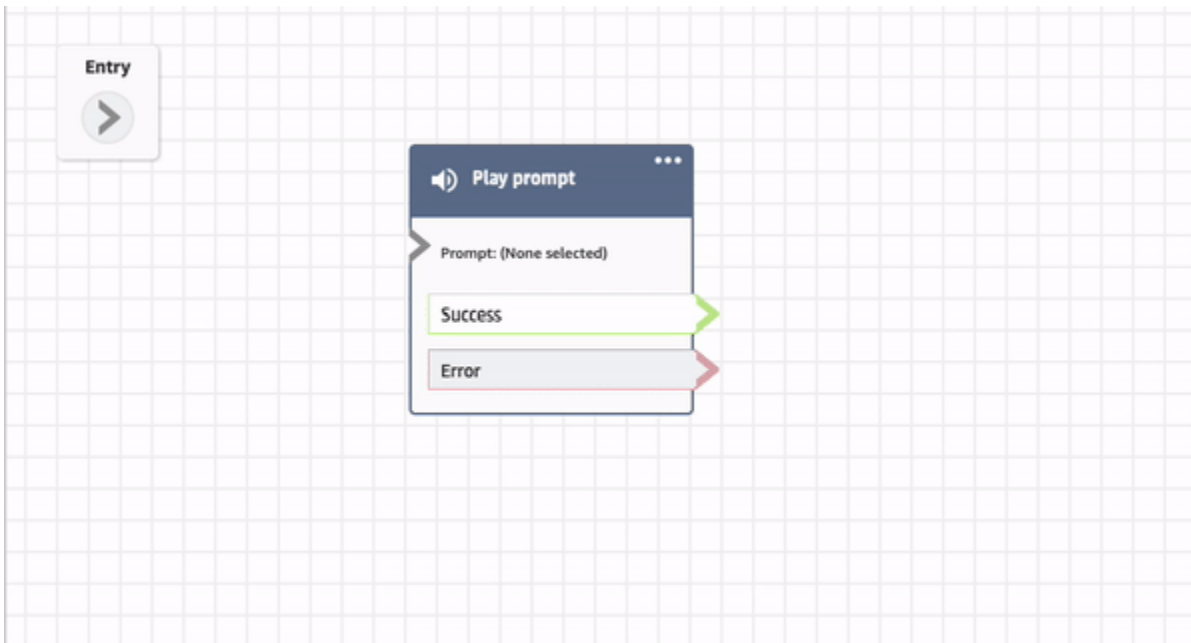

For more information, see [Customize the name of a block](#).

Archive, restore, and delete flows and modules

You can archive, restore, and delete flows and modules by using the Amazon Connect admin website. This makes it easier to manage flows and modules that are not in use or no longer needed.

For example, flows used only during certain times of the year can be archived when not in use and then unarchived when needed. When a flow or module has been archived, you can then permanently delete it so it is no longer available within your list of flows and modules. For more information, see [Archive, delete, and restore flows](#).

Undo and redo actions in the flow designer

You can undo and redo actions in the flow designer. Choose the undo and redo items on the toolbar. Or, with your cursor on the flow designer canvas, use the shortcut keys: Ctrl+Z to undo, Ctrl+Y to redo. For more information, see [Undo and redo actions in the flow designer](#).

Add notes to a flow block

To add notes to a block, on the toolbar choose Annotation. Or, with your cursor on the flow designer canvas, use the shortcut keys: Ctrl + Alt +N. A yellow box opens for you to type up to 1000 characters. This enables you to leave comments that others can view. For more information, see [Add notes to a block](#).

The following GIF shows how to move notes around the flow designer and attach them to a block.

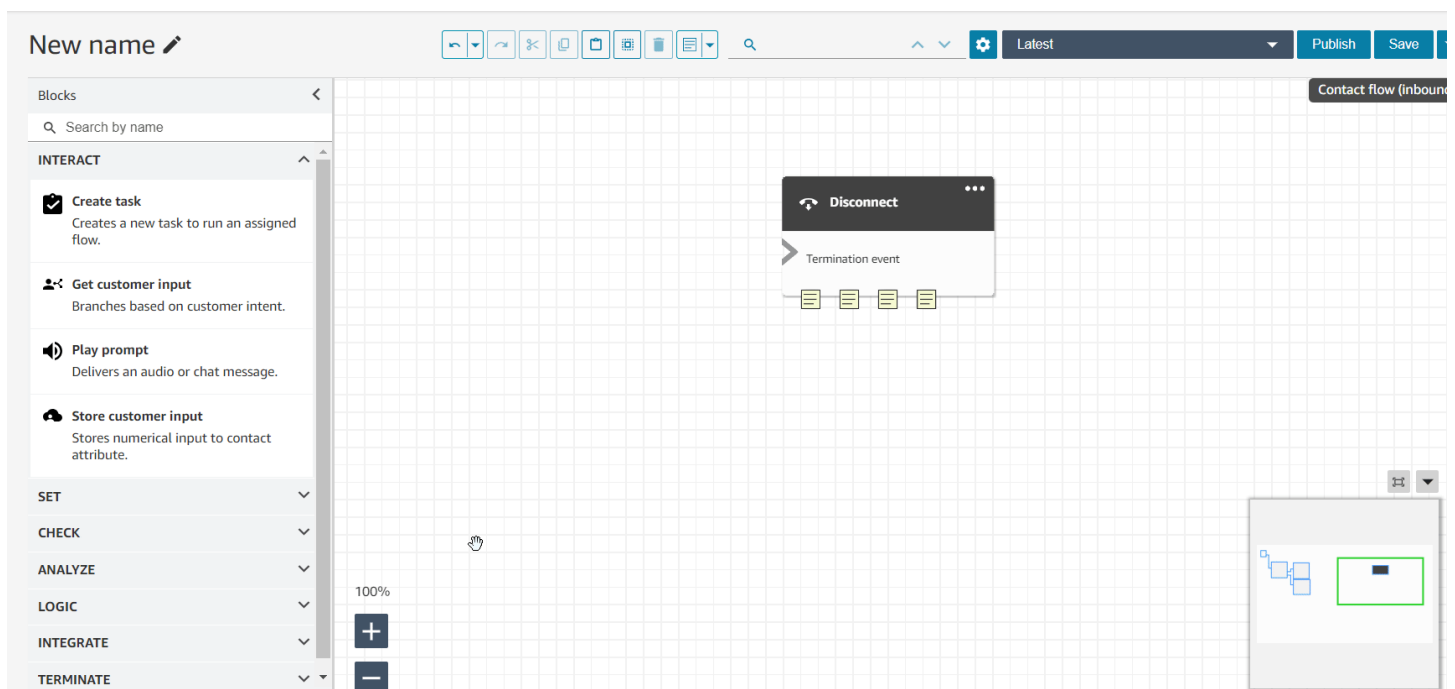

Use the mini-map to navigate a flow

On the flow designer, the mini-map view to helps you easily navigate the flow. The drag-to-move mini-map has visual highlights that enable you to quickly move to any point in the flow. For more information, see [Use the mini-map to navigate a flow](#).

The following GIF shows an example of how you can use the mini-map to navigate a large flow.

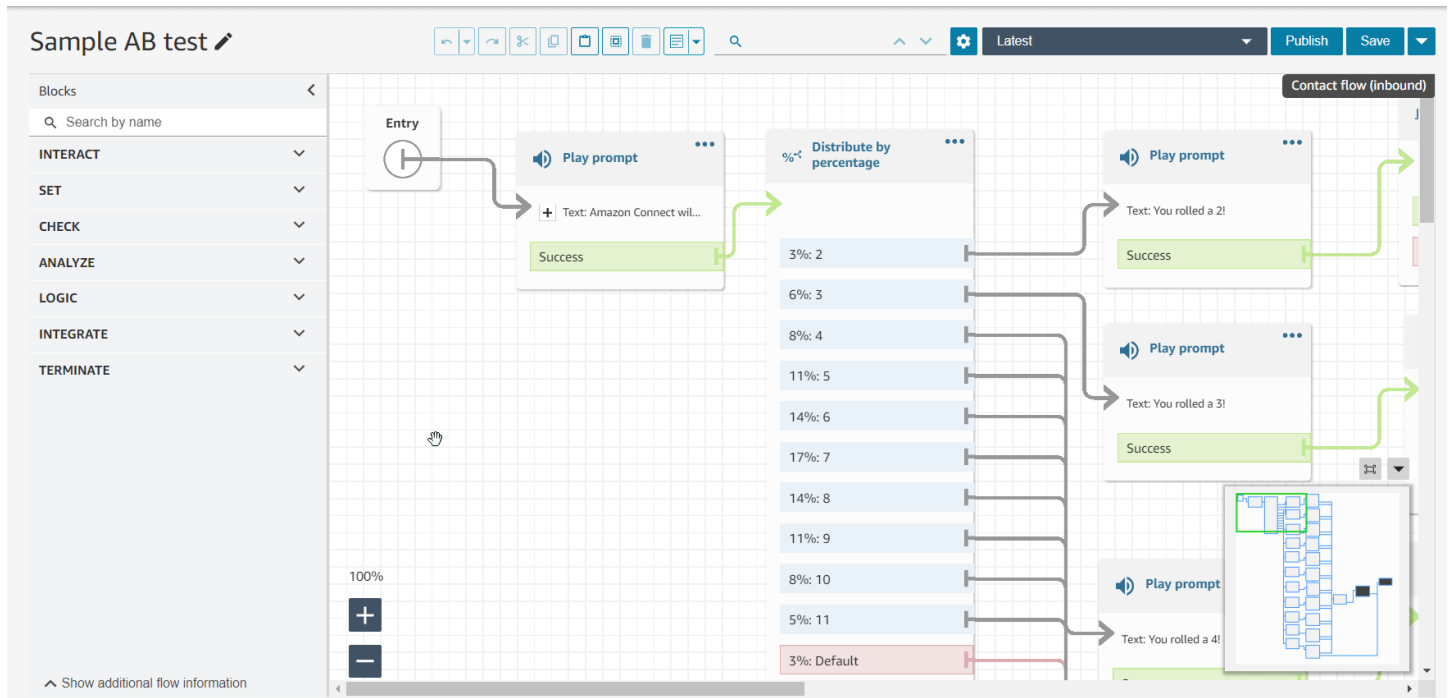

Restrict attributes to specific flows

Released a new type of attributes called a flow attribute. Flow attributes are restricted to the flow in which they are configured. They are useful in situations where you don't want to persist the data throughout the contact, such as when you need to use sensitive information like the customer's credit card number to do a Lambda data dip. For more information, see [Flow attributes](#).

Import time off balances

You can import time off balances for your users. You can also set the group allowance for time off by hour, for each calendar day, for specific time off activities. Amazon Connect uses the time off balance to automatically approve or decline time off requests based on the agent's available net balance and the group allowance for time off. For more information, see [Import an agent's time off balance in a .csv file](#) and [Set group allowance for time off](#).

Schedule flexible days and shift activities based on shift length

The following scheduling functionality has been released:

- You can generate agent schedules that have the appropriate number of activities, such as breaks or meals, depending on the duration of the shift. The required number of breaks and meals are automatically placed in schedules that are compliant to various regional labor laws.
- You can generate agent schedules that include flexible days, that is, days that will be optionally scheduled if there's a need. Amazon Connect can automatically generate flexible schedules that are compliant to agent's contracts and regional labor laws, thereby saving time for schedulers.

For more information, see [Create shift profiles](#).

Amazon Connect Customer Profiles supports rule-based matching and merging

Amazon Connect Customer Profiles supports rule-based resolution to match and merge similar profiles into unified ones. This enables you to enhance customer service by granting agents and automated systems access to relevant customer information. As a result, interactions become faster and more personalized for customers. For more information, see [Use Identity Resolution to consolidate similar profiles](#).

Released Amazon Connect Client Application v1.0.1.33

The Amazon Connect Client Application is used to [record agent screens](#). With this newer version you no longer need to restart your desktop after installing the client application. For the download location, see the [Amazon Connect Client Application](#) topic.

Amazon Connect Cases provides case assignment

Case assignment helps organizations reduce the time to resolve customer issues by clearly tracking case activities and resolution ownership. Agents can associate a case with a queue or an individual agent for resolution. Agents can view and filter cases assigned to their queue, and managers can directly assign cases to individual agents. For more information, see [Set up case assignment](#).

Contact Lens Conversational Analytics metrics in the API

You can analyze aggregate agent and contact performance using Contact Lens Conversational Analytics metrics in the [GetMetricDataV2](#) API. The list of metrics include Average contact duration, Average conversation duration, Average greeting time agent, Average holds, Average interruptions agent, Average interruption time agent, Average non-talk time, Average talk time, Average talk time agent, and Average talk time customer. For more information, see [Historical metrics definitions](#) and [GetMetricDataV2](#).

Amazon Connect Wisdom supports real-time recommendations for chat conversations

Note

In November 2023 we released Amazon Q. It includes real-time agent assist functionality formerly known as Amazon Connect Wisdom, along with generative AI-powered recommended responses, actions, and links to more information.

Amazon Connect Wisdom delivers ML-powered, real-time recommended information to help chat agents quickly solve customer needs.

Delete queues and routing profiles programmatically

You can delete queues and routing profiles programmatically. For more information, see the following topics:

- [DeleteQueue](#) action
- [delete-queue](#) AWS CLI
- [DeleteRoutingProfile](#) action
- [delete-routing-profile](#) AWS CLI

To create an AWS CloudFormation template for queues and routing profiles, see the following topics:

- [AWS::Connect::Queue](#)

- [AWS::Connect::RoutingProfile](#)

June 2023 Updates

Agents can change their audio device settings in the CCP and agent workspace

You can configure the Contact Control Panel (CCP) or agent workspace to enable agents to select their preferred device for microphone input and audio output, such as voice media and new contact notifications. For more information, see [How to use the CCP to change your audio device settings](#).

Amazon Connect Chat: New interactive message types

Amazon Connect Chat supports new interactive message types: quick replies and carousels. With quick replies, customers are presented with a list of response options (for example, **Yes**, **No**) that they can easily click to reply. Carousels present a set of interactive messages in a horizontally-scrolling format. Your customers can scroll through them and select the best option. For more information, see [Add interactive messages to chat](#).

GetMetricDataV2 API: Region availability and new functionality

The [GetMetricDataV2](#) API is available in the AWS GovCloud (US-West) Region. GetMetricDataV2 is now released in all AWS Regions where Amazon Connect is offered. This API enables you to access the trailing 35 days of historical agent and contact metrics (for example, service level, average handle time) with customizable filters and groupings.

You can use GetMetricDataV2 to build custom dashboards to measure queue and agent performance over time. For example, you can identify the number of contacts that were disconnected by an agent versus disconnected by a customer hanging up. For more information, see [GetMetricDataV2](#).

Search for existing tags within an Amazon Connect instance

Amazon Connect provides the ability to search for existing tags within an instance, both programmatically via API and within the UI. When tagging resources, you can search from pre-existing key:value pairs before creating new ones. For more information, see the [SearchResourceTags](#) API.

Added screen recording capabilities to Contact Lens

Amazon Connect Contact Lens provides screen recording capabilities, making it easy for you to help agents improve their performance. With screen recording, you can identify areas for agent coaching (for example, long contact handle duration or non-compliance with business processes) by not only listening to customer calls or reviewing chat transcripts, but also watching the agent's actions while they are handling a contact. For more information, see [Set up and review agent screen recordings](#).

Amazon Connect scheduling allows agents to manage time off requests

Amazon Connect scheduling allows contact center agents to manage their time off requests in a self-serve manner. For more information, see [Create a time off request](#).

Real-time data export of unified customer profiles to an Amazon Kinesis Data Stream

Amazon Connect Customer Profiles supports real-time data export of unified customer profiles to an Amazon Kinesis Data Stream. Companies can enable data streaming and automatically receive data for new profiles and updates to existing profiles into their Amazon Kinesis Data Stream. For more information, see [Set up real-time export](#).

May 2023 Updates

Added theme detection to Contact Lens

Contact Lens provides a machine learning powered capability for businesses to help identify top contact drivers by grouping customer conversations into themes. For more information, see [Use theme detection to discover issues](#).

New APIs for managing prompts

You can programmatically create and manage prompts using APIs, for example, to extract prompts stored in Amazon Connect and add them to your Amazon S3 bucket. AWS CloudTrail, AWS CloudFormation, and tagging are supported. For more information, see [Prompt actions](#) in the *Amazon Connect API Reference Guide*. Also see [AWS::Connect::Prompt](#) in the *AWS CloudFormation User Guide*.

Added supervisor alerts on agent performance

Amazon Connect Contact Lens provides supervisor alerts on agent performance. This enables you to identify which contacts (for example, those with an evaluation score less < 50%) that require supervisors follow-up with agents on their team. For more information, see [Create supervisor alerts on agent performance](#).

Interactive messages: Rich formatting in chat titles and subtitles

You can add rich formatting to the titles and subtitles of your chat messages. For example, you can add links, italics, bold, numbered lists, and bulleted lists. You use [markdown](#) to format your text. For more information, see [Rich formatting in titles and subtitles](#) in the *Add interactive messages to chat* topic.

April 2023 Updates

GA for Amazon Connect evaluation capabilities

Released Amazon Connect evaluation capabilities for general availability. Use these capabilities to:

- [Create evaluation forms](#)
- [Evaluate agent performance](#)
- [Create rules](#) that trigger an action (such as send email or tasks) based on evaluation results
- [Search evaluation forms and evaluations](#)

To manage evaluation forms programmatically, see the [Evaluation](#) actions in the *Amazon Connect API Reference*. To create a shared template for evaluation forms, see the `AWS::Connect::EvaluationForm` resource in the *AWS CloudFormation User Guide*.

New API: Use `CreateParticipant` to customize chat flow experiences

Added the [CreateParticipant](#) API which you can use to customize chat flow experiences. You use it to integrate custom participants. For more information, see [Customize chat flow experiences by integrating custom participants](#).

Customer Profiles displays case information in the agent workspace

Using Amazon Connect Customer Profiles inside the agent workspace, agents can see cases from third-party case management solutions and Amazon Connect Cases inside a particular customer profile. For more information, see [Use Customer Profiles](#) and [Access Customer Profiles in the agent workspace](#).

Added Cross-channel concurrency

You can configure an agent's routing profile to receive contacts from multiple channels at the same time. For example, while an agent is on a voice contact, they can be offered contacts from any other channels enabled in the routing profile, such as chats and tasks.

For more information, see [Create a routing profile](#). Also see the [CrossChannelBehavior](#) API.

Set Voice ID block supports fraud watchlist ID

Updated the [Set Voice ID block](#) so it supports fraud watchlist ID for fraud detection.

Search, sort, and filter published agent schedules

Schedulers can quickly search, sort, and filter agent schedules from within the published schedule calendar. For more information, see [How supervisors view published schedules](#).

March 2023 Updates

Added Wisdom support for Microsoft SharePoint Online

Note

In November 2023 we released Amazon Q. It includes real-time agent assist functionality formerly known as Amazon Connect Wisdom, along with generative AI-powered recommended responses, actions, and links to more information.

You can choose Microsoft SharePoint Online as knowledge base for Wisdom articles. For more information, see [Enable Amazon Q in Connect for your instance](#). Also see the [AppIntegrationsConfiguration](#) API in the *Amazon Q in Connect API Reference*.

Create step-by-step guides for your agents

Inside the out-of-the-box Amazon Connect agent workspace, you can create workflows that walk agents through custom UI pages that suggest what to do at a given moment during a customer interaction. You can create guides that help agents identify customer issues and recommend subsequent actions, as well as surface screen-pops and forms for submitting transactions and disposition codes. For more information, see [Step-by-step Guides](#).

Added support for nested JSON in Invoke AWS Lambda function flow block

The Invoke AWS Lambda function flow block supports JSON responses. For more information, see [Flow block: Invoke AWS Lambda function](#).

Added Show View flow block

This block is used to configure UI based workflows that you can surface to users in front end applications. For more information, see [Flow block: Show view](#).

Added staff level shift profile

You can assign a shift profile to individual agents. This is useful to do when, for example, you have part-time agents who are in the same staffing group as your full-time agents, but they require their own shift profile. For more information, see the **Associate to shift profile** option described in [Create staff rules for scheduling](#).

Added support for multiple fraudster watchlists

Every domain has a default watchlist where all existing fraudsters are placed by default. You can create and manage custom watchlists to be evaluated against for known fraudster detection. For more information, see [Known fraudster detection](#), and see new actions in the [Amazon Connect Voice ID API Reference](#).

Search and sort schedules in the Schedule Manager

Schedulers can quickly search for schedule names using partial keywords or sort the schedule list based on start date, end date, creation date, or updated date. For more information, see [Search and sort a schedule](#).

Added the ability to configure multiple IAM roles that can be assigned to a single user when using SAML 2.0

You can configure multiple IAM roles that can be assigned to a single user when using SAML 2.0 which enables you to support user access from multiple identity providers simultaneously. For example, if you are migrating identity providers, you can configure multiple IAM roles associated to a single user and that user will be able to access Amazon Connect from either provider. To learn more about configuring IAM roles for SAML 2.0 in Amazon Connect, see the [Configure SAML with IAM for Amazon Connect](#) documentation.

Added panel template for interactive chat messages

With a panel template, you can present customers with up to 10 choices under one question in a chat message. For more information, see [Add interactive messages to chat](#).

Added GetMetricDataV2 API

Added the [GetMetricDataV2](#) API to the *Amazon Connect API Reference Guide*. This API enables you to programmatically access trailing 14 days of historical agent and contact metrics data. It extends the capabilities of the [GetMetricData](#) API, provides new [historical metrics](#) (for example, the number of [contacts disconnected](#), and the number of [callback attempts](#)), and provides the ability to filter metrics with more granularity.

February 2023 Updates

Added new attribute type ENHANCED_CONTACT_MONITORING to Describe, List and Update Instance Attribute APIs

This release updates the APIs: `DescribeInstanceAttribute`, `ListInstanceAttributes`, and `UpdateInstanceAttribute`. You can use it to programmatically enable/disable enhanced contact monitoring using attribute type `ENHANCED_CONTACT_MONITORING` on the specified Amazon Connect instance. For more information, see [DescribeInstanceAttribute](#), [ListInstanceAttributes](#), and [UpdateInstanceAttribute](#).

Added the DeleteDomain API for Cases

For more information, see the [DeleteDomain](#) API in the *Amazon Connect Cases API Reference Guide*.

Added RelatedContactId to StartTaskContact API

You can link together an unlimited number of task contacts using the RelatedContactID parameter supported in the StartTaskContact API. For more information, see [Linked tasks](#) and the [StartTaskContact](#) API in the *Amazon Connect API Reference Guide*.

Amazon Connect Cases integrates with AWS PrivateLink

For more information, see [Creating an interface VPC endpoint for Amazon Connect](#).

Added support for more granular access controls (using resource tags) to view real-time metrics for agents, queues, and routing profiles

You can enable more granular access controls for real-time metrics by configuring resource tags and access control tags within security profiles in the Amazon Connect admin website. For more information, see [Real-time tag-based access control](#) and [Tag based access control in Amazon Connect](#).

Added support to provide more granular permissions to metrics reports, including new permissions for real-time metrics, historical metrics, and agent activity audit

You can configure more granular permissions to metrics and reports from within security profiles in the Amazon Connect admin website. For more information, see [Permissions required to view real-time metrics reports](#) and [Agent activity audit permissions](#).

Added support to provide visibility into an agent's next activity

You can view an agent's next activity in the real-time metrics agent table in the Amazon Connect real-time metrics UI and by using the public API. For more information, see the [NextStatus API reference](#).

Apply S3 Object Lock for the call recordings bucket

You can use Amazon S3 Object Lock in combination with your call recording bucket to help prevent call recordings from being deleted or overwritten for a fixed amount of time, or indefinitely. For more information, see [How to set up S3 Object Lock for immutable call recordings](#).

CloudFormation templates for instance management

You can use CloudFormation templates to manage Amazon Connect instances for associating Amazon Lex and Lex V2 bots, Lambda functions, security keys, and approved origins—along with the rest of your AWS infrastructure—in a secure, efficient, and repeatable way. For more information, see [Amazon Connect resource type reference](#) in the *AWS CloudFormation User Guide*.

January 2023 Updates

Added long lasting, persistent chat experiences

Amazon Connect makes it easier for you to deliver long lasting, persistent chat experiences for your customers. Persistent chats enable customers to resume previous conversations with the context, metadata, and transcripts carried over, eliminating the need for customers to repeat themselves and allowing agents to provide personalized service with access to the entire conversation history. To set up persistent chat experiences, provide a previous contact ID when calling the [StartChatContact](#) API to create a new chat contact.

For more information, see [Enable persistent chat](#). Also see changes to [StartChatContact](#) in the *Amazon Connect API Reference Guide*, and see the new `RelatedContactId` parameter in the [GetTranscript](#) API in the *Amazon Connect Participant Service API Reference Guide*.

December 2022 Updates

Added message receipts feature for chat messages

The message receipts feature allows customers to receive *Message delivered* and *Read* receipts after they send a chat message. For more information, see [Enable message Delivered and Read receipts in your chat user interface](#). Also see the [SendEvent](#) action, and the [Item](#), [MessageMetadata](#), and [Receipt](#) data types in the *Amazon Connect Participant Service API Reference Guide*.

Updates to [GetCurrentMetricData](#) and [GetCurrentUserData](#)

For the [GetCurrentMetricData](#) API, added support for routing profile filter, sort criteria, and grouping by routing profiles. For the [GetCurrentUserData](#) API, added support for routing profiles, user hierarchy groups, and agents as filters, and next status and agent status name. For both APIs, added `ApproximateTotalCount`.

Added chat timeouts for chat participants

When a chat conversation between an agent and a customer has been inactive (no messages sent) for a certain amount of time, you may want to consider a chat participant to be idle, and you may even want to automatically disconnect an agent from the chat. To set up chat timeout timers, see [Set up chat timeouts for chat participants](#).

Microsoft Edge Chromium support

Amazon Connect now supports Microsoft Edge Chromium. For more information about supported browsers, see [Browsers supported by Amazon Connect](#).

Amazon Connect supports JSON as a content type for chat messages

By supporting JSON as a content type, Amazon Connect provides you with a way to pass additional information over chat to provide rich personalized experiences. For example, rendering updates to a custom UI, customer-built interactive messages, language translation capabilities, and passing customer metadata to a third party bot. For more information, see [StartChatContact](#) in the *Amazon Connect API Reference Guide*, and [SendMessage](#) in the *Amazon Connect Participant Service API Reference Guide*.

Added topic on Amazon Connect availability by Region

For more information, see [Availability of Amazon Connect services by Region](#).

Contact Lens granular data redaction

When you set up Contact Lens sensitive data redaction, you can choose which entities you want to redact, and how you want the redaction to appear in the transcript. For more information, see [Enable redaction of sensitive data](#).

Additional Contact Lens language support and Region availability

Contact Lens now [supports the following languages](#): English - New Zealand, English - South Africa. It is also [available in the following Regions](#): Africa (Cape Town), Asia Pacific (Seoul), Asia Pacific (Singapore).

Released Barge to allow contact center managers to join ongoing calls

Barge allows managers to join and participate in an ongoing customer service call between a contact center agent and customer. After joining the call, a manager can speak with the customer, add participants, and even choose to remove an agent if needed. For more information, see [Barge live conversations](#).

Added user hierarchy to bulk user upload

You can assign the user hierarchy in the .csv file when you add users in bulk. For more information, see [Add users in bulk](#).

Granular access controls using resource tags for users, security profiles, routing profiles, and queues

You can now enable more granular access controls for security profiles, users, routing profiles, and queues by configuring resource tags within the Amazon Connect console. You can add resource tags to filter and organize these resources logically, and configure access control tags within security profiles to enforce granular permissions. For more information, see [Tagging resources in Amazon Connect](#) and [Tag based access controls in Amazon Connect](#).

Bulk user import now includes agent hierarchy and tags

Amazon Connect now allows you to configure hierarchies and resource tags for users in bulk. You can now assign agent hierarchies and resource tags to each agent using the CSV bulk upload template which is available on the user management page. For more information, see [Tagging resources in Amazon Connect](#).

Released Rules Function language

The Rules Function language is a JSON-based representation of a series of rule conditions. Use it to programmatically add conditions to rules. For more information, see [Amazon Connect Rules Function language](#) in the *Amazon Connect API Reference Guide*.

GA for Rules APIs

Released a set of Rules APIs that enable you to programmatically create and manage rules. For more information, see [Rules actions](#) in the *Amazon Connect API Reference*.

Search contacts by agent's first or last name is available in AWS GovCloud

November 2022 Updates

Create step-by-step guides for your agents

Inside the out-of-the-box Connect agent workspace, you can now create workflows that walk agents through custom UI pages that suggest what to do at a given moment during a customer interaction. You can create guides that help agents identify customer issues and recommend subsequent actions, as well as surface screen-pops and forms for submitting transactions and disposition codes. For more information, see [Agent Workspace guided experience](#).

GA for Forecasting, capacity planning, and scheduling

Amazon Connect provides a set of services powered by machine learning that help you optimize your contact center by offering the following:

- Forecasting. Analyze and predict contact volume based on historical data.
- Scheduling. Generate agent schedules for day-to-day workloads that are flexible, and meet business and compliance requirements.
- Capacity planning. Predict how many agents your contact center will require.

For more information, see [Forecasting, capacity planning, and scheduling](#).

Released Contact Lens evaluation forms for preview

You can create evaluation forms, and then make them available to managers to review conversations alongside contact details, recordings, transcripts, and summaries, without the need to switch applications. Conversational analytics automatically pre-populates evaluation scores for criteria like script adherence, sensitive data collection, and customer greetings. For more information, see [Evaluate performance \(Preview\)](#).

Released Contact Lens conversational analytics capabilities for Amazon Connect chat

Amazon Connect Contact Lens provides conversational analytics capabilities for Amazon Connect chat, extending the machine learning powered analytics to better assess chat contacts. For more information, see [Analyze conversations using Amazon Connect Contact Lens](#).

Added configurable Lex timeouts in chat

You can configure how long to wait for a response from a customer in a chatbot conversation before the session expires. For more information, see *Configurable time-outs for chat input* in the [Get customer input](#) topic.

Create rules that send email notifications

You can create Contact Lens rules that send email notifications to people in your organization. For more information, see [Create Contact Lens rules that send email notifications](#).

Added MonitorContact API

Added a new API for programmatically initiating monitoring of ongoing contacts. For more information, see [MonitorContact API](#).

Manage saved reports (admin)

You can view and delete all saved reports in your instance, including reports that were not created by you or that are not currently published. For more information, see [Manage saved reports \(admin\)](#).

Search for profiles using multiple search keys

In addition to searching for profiles with a single search key (i.e., a key-values(s) pair), the SearchProfiles API has been enhanced to support searching for profiles using multiple keys and logical operators. This new functionality allows you to use between 1 and 5 search keys with AND or OR logic to find profiles with attributes that match the search criteria. For more information, see the [SearchProfiles API reference](#).

Delete quick connects using the Amazon Connect console

In addition to deleting quick connects programmatically, you can now delete them using the Amazon Connect console. For more information, see [Delete quick connects](#).

Added DismissUserContact API

Added a new API for programmatically clearing the notifications agents receive after they have missed or rejected a contact, making them eligible to be routed new contacts. This API can also be used to clear similar notifications when an agent encounters an error with accepting the contact or is handling After Contact Work. For more information, see the [DismissUserContact API reference](#).

October 2022 Updates

Add secondary email address and mobile number to user accounts

For more information, see [Add users to Amazon Connect](#).

Emojis for chat messages

Added support for emojis for your customer's chat experience. Agents and customers can now send emojis when composing a chat message, enabling them to visually convey sentiment or emphasis during a chat conversation. For more information, see [Enable text formatting for your customer's chat experience](#).

Released support for Enhanced 911 (E911)

Enhanced 911 (E911) enables location information to be sent to 911 dispatch when a 911 call is placed. In addition to connecting a user with 911 emergency services, customers in the United States can build E911 capabilities to automatically provide the caller's address information to 911 dispatchers. For more information, see [Set up US emergency calling in Amazon Connect](#).

GA for Amazon Connect Global Resiliency

Released Amazon Connect Global Resiliency for General Availability. Global Resiliency enables you to provide customer service anywhere in the world with the highest reliability, performance, and efficiency, while meeting international regulatory requirements. For more information, see [Set up Amazon Connect Global Resiliency](#).

Added Ctrl+Shift+F to search flow block titles and metadata

Press **Ctrl+Shift+F** to display a search box in the flow designer, and then search the block titles and metadata. To hide the search box, go to **Settings, Toolbar**, and set the toggle.

The following GIF shows how to use the search box to find flow blocks that have **attributes** in their title. It also shows how to display or hide the search box using the toggle.

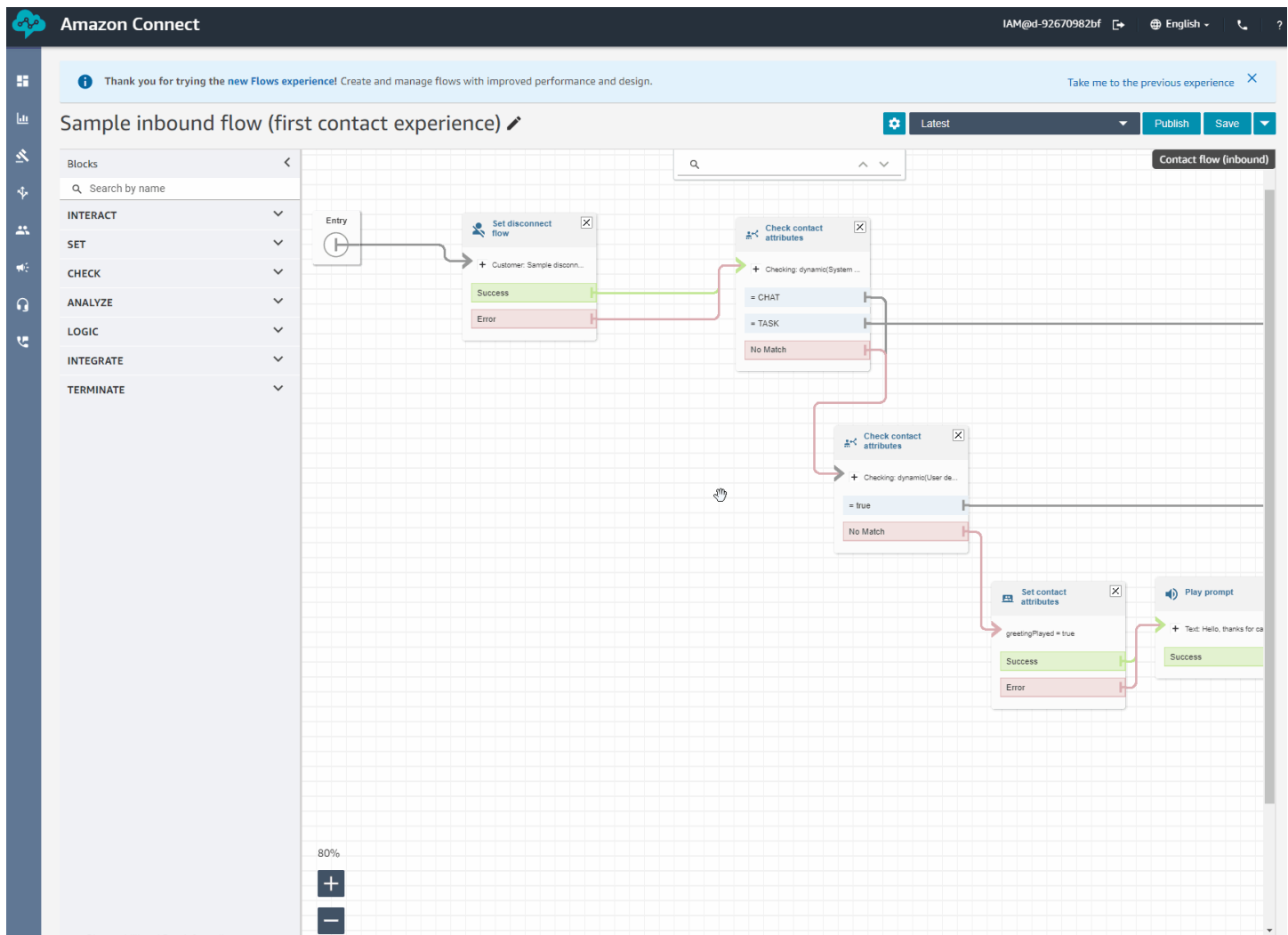

Released Amazon Connect Cases for General Availability

Amazon Connect Cases allows your agents to quickly track and manage customer issues that require multiple interactions, follow-up tasks, and teams in your contact center. For more information, see [Amazon Connect Cases](#) and [Amazon Connect Cases API Reference](#).

September 2022 Updates

Searching for a contact? Choose from a list of categories

When you search a contact and filter results by Contact Lens categories, you can pick from a list of categories, rather than manually typing the name of a category.

Updated flow designer

We've released a number of improvements to the flow designer experience to make building and editing flows easier.

- Updated look and feel of block dock, blocks, and flow designer canvas.

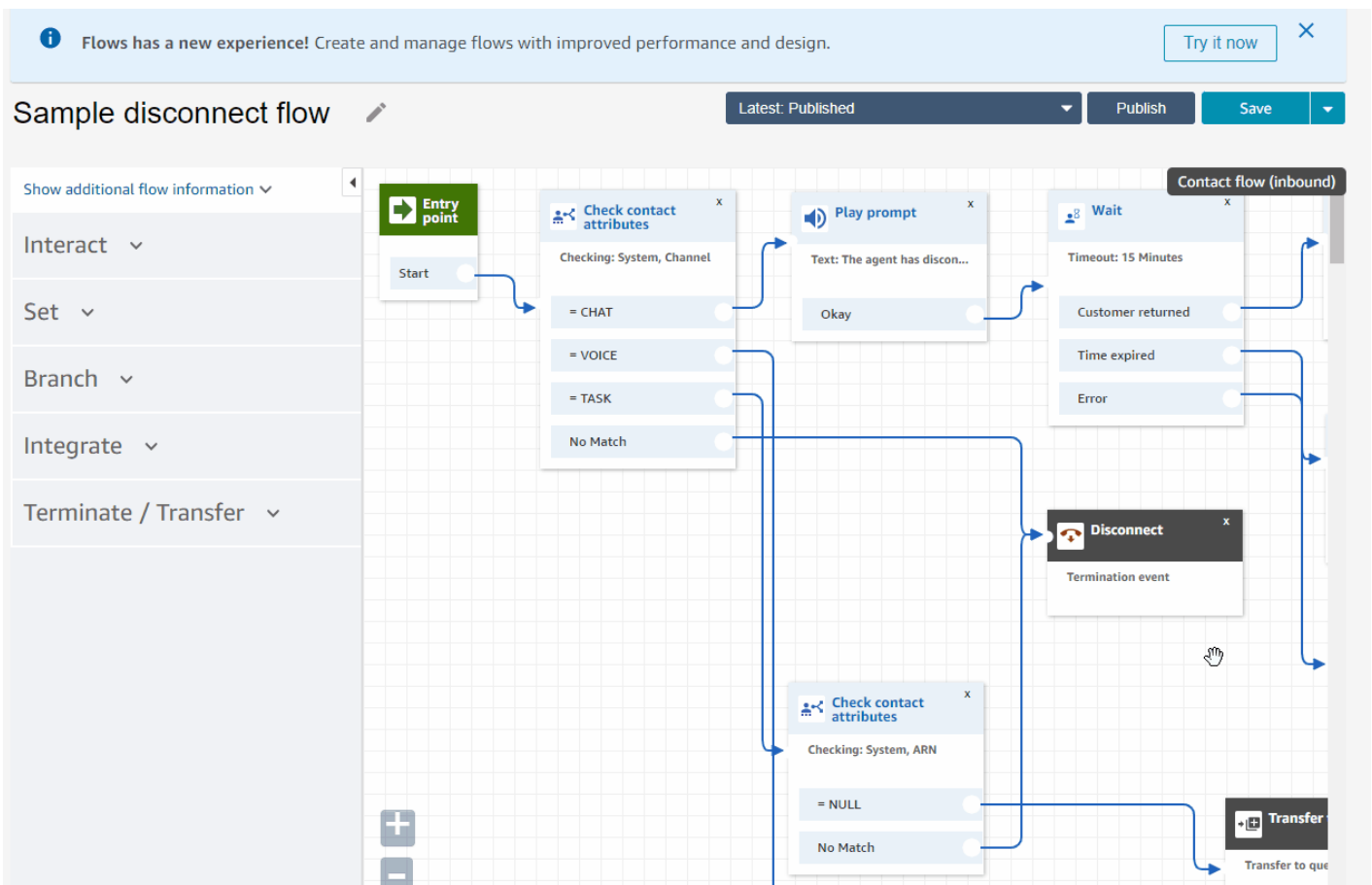

- Import / Export uses a standard flow language so you can interchangeably build flows in APIs or in the UI.

Important

To copy and paste flows and blocks in the updated flow designer, the flow must be in the new flow language. To convert a legacy flow into the new format, you have two options:

- Option 1: In the flow designer user interface, opt in to the updated flow designer. Your legacy flows are automatically converted.
- Option 2: Manually [import](#) a legacy flow using the updated flow designer.

This option is most useful for scenarios where you have stored your flows in JSON offline. For example, for configuration control, you may have flow configurations in an offline data store. To copy a part of that flow and paste it into the updated flow designer, you need to import it into the updated flow designer. The importing process converts it to the new flow language. After that, you can copy and paste within the updated flow designer. If you want to keep using your offline data store as a source of truth, update the flow with the new format.

- You can use **Search** to filter blocks in the block dock.

Test Flow

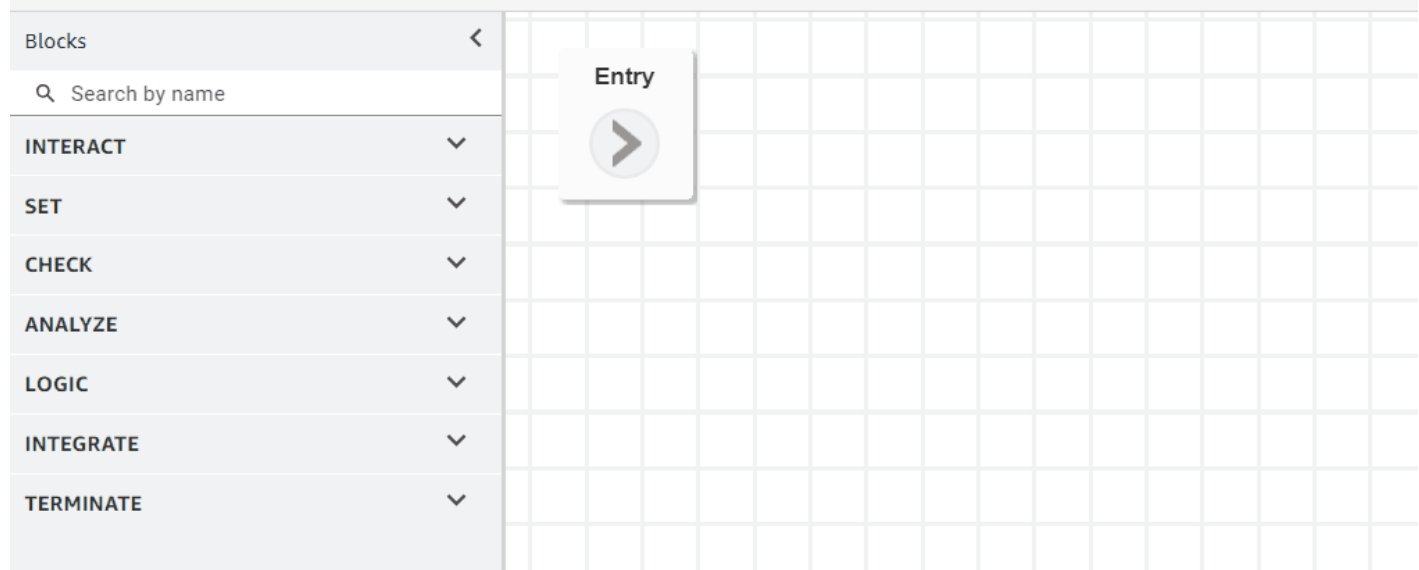

- Multi-line block metadata allows you to click and expand to see block configurations.

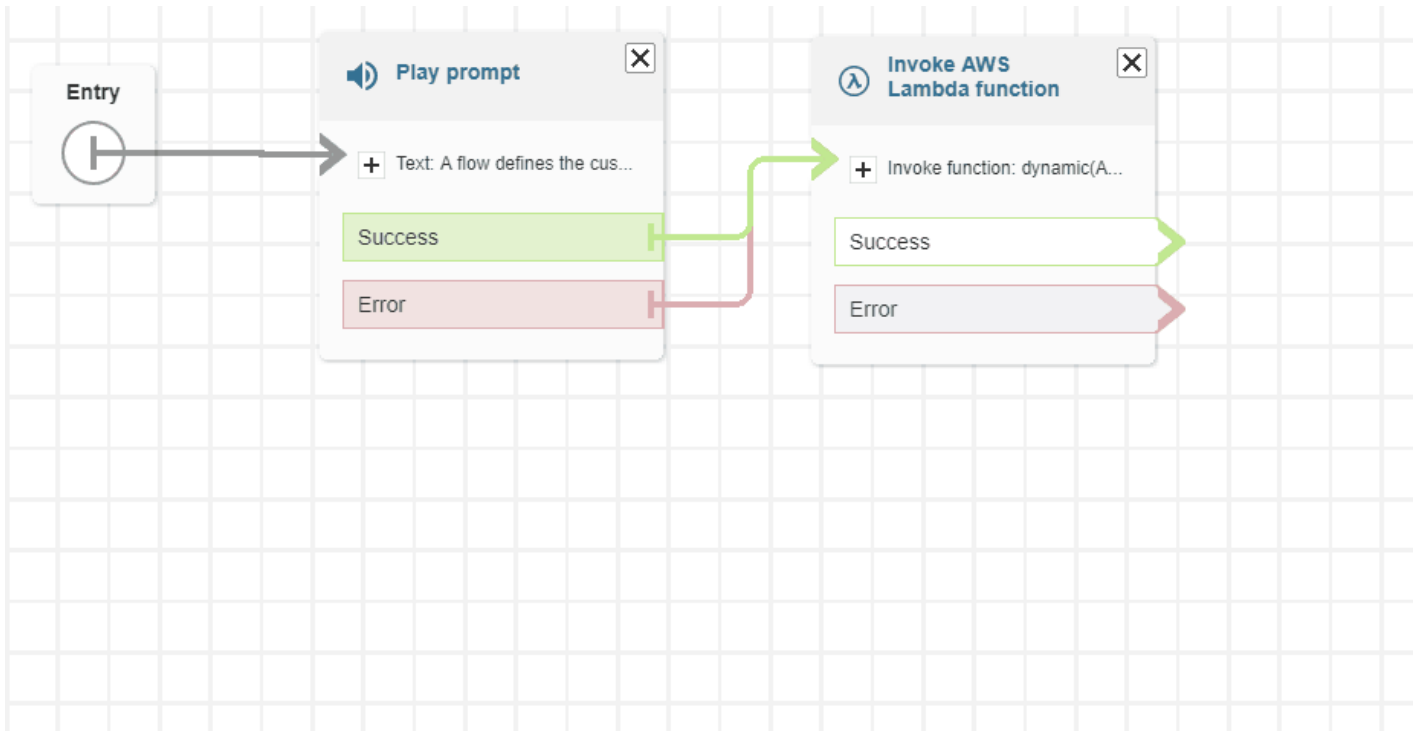

- Color-coded branches and connectors help you distinguish paths.

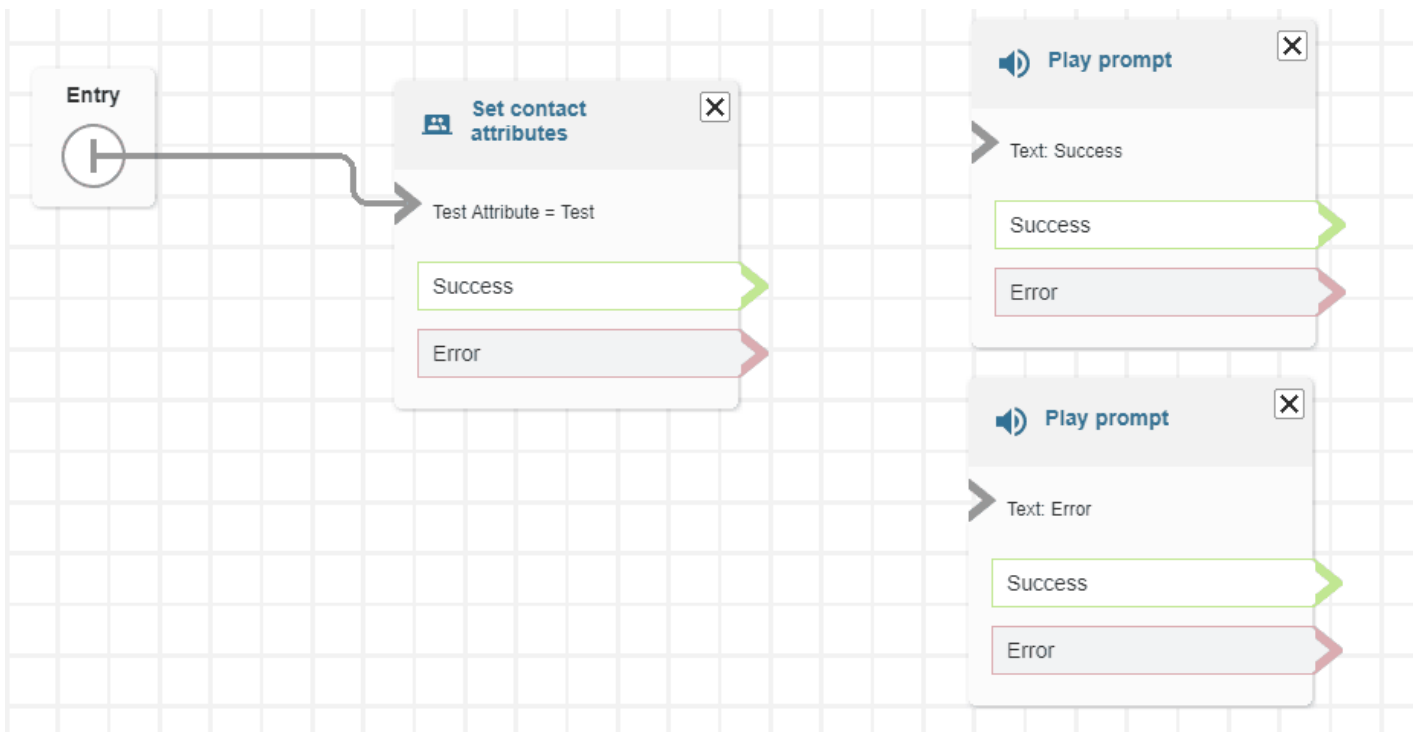

- Improved zooming.

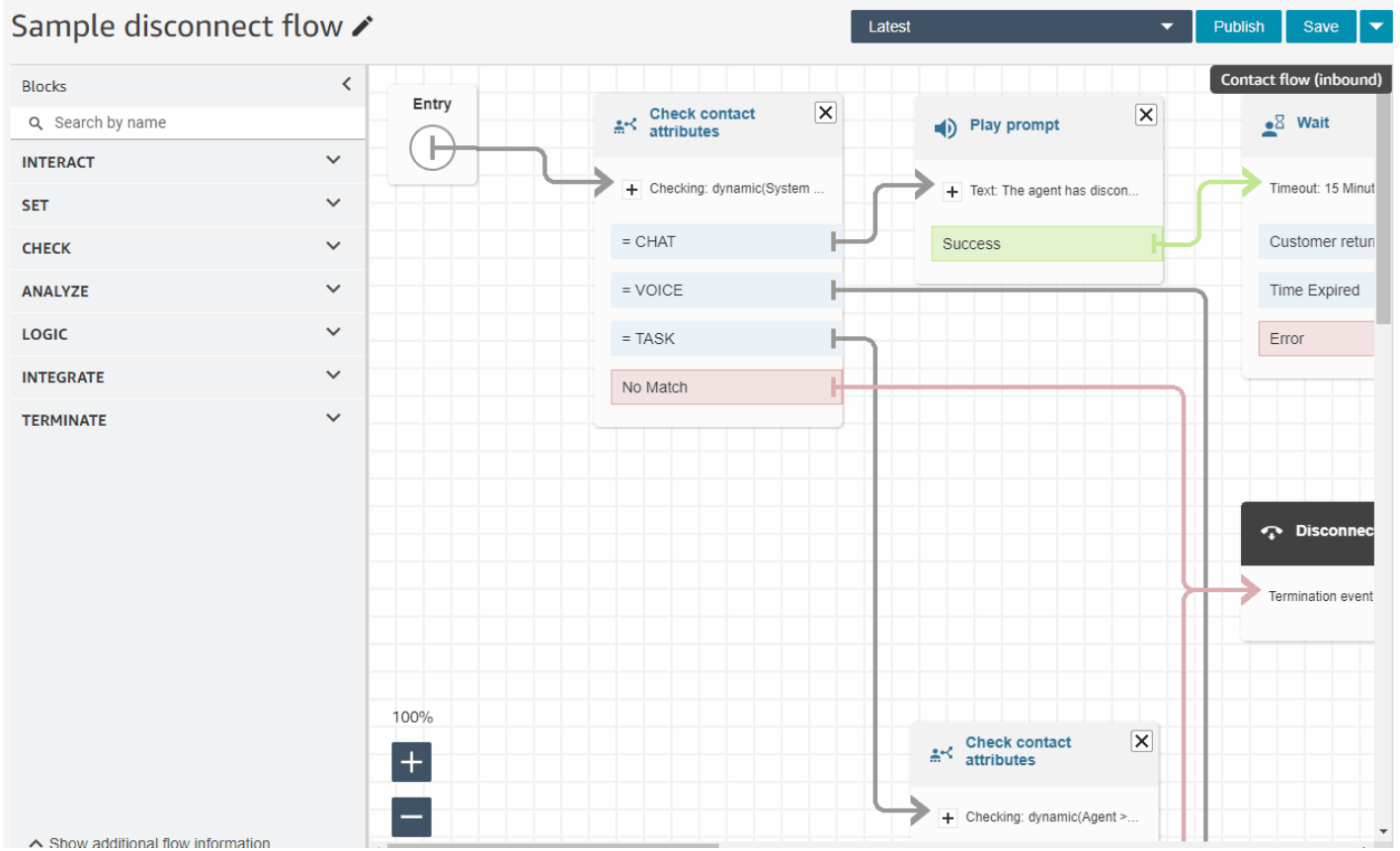

- Flow/module metadata appears at the bottom of the block dock.

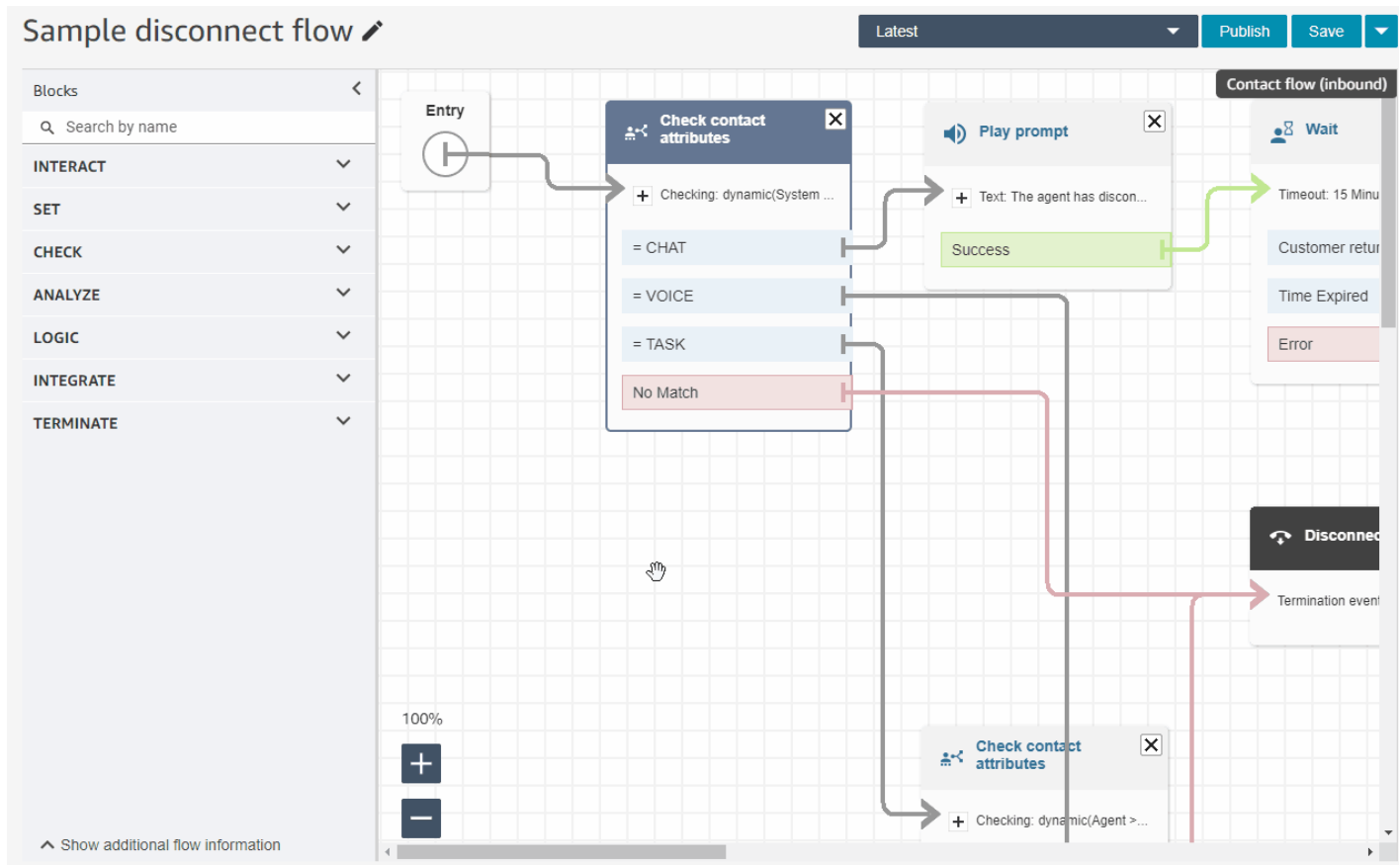

- New, more intuitive categories (**Check**, **Analyze**, and **Logic**) to make it easier to find the blocks you are looking for.

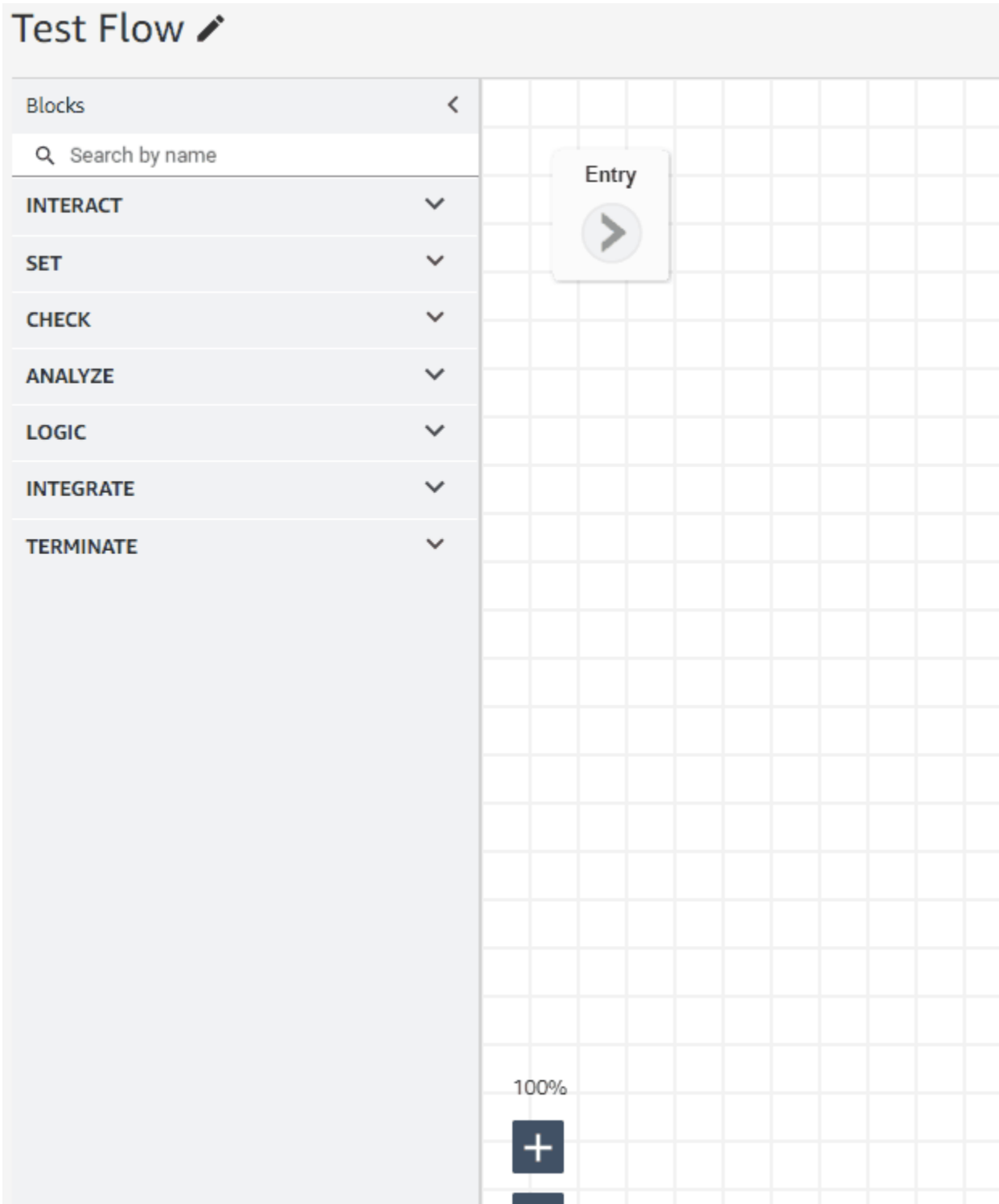

- Updated user interface in the block **Property** pages.

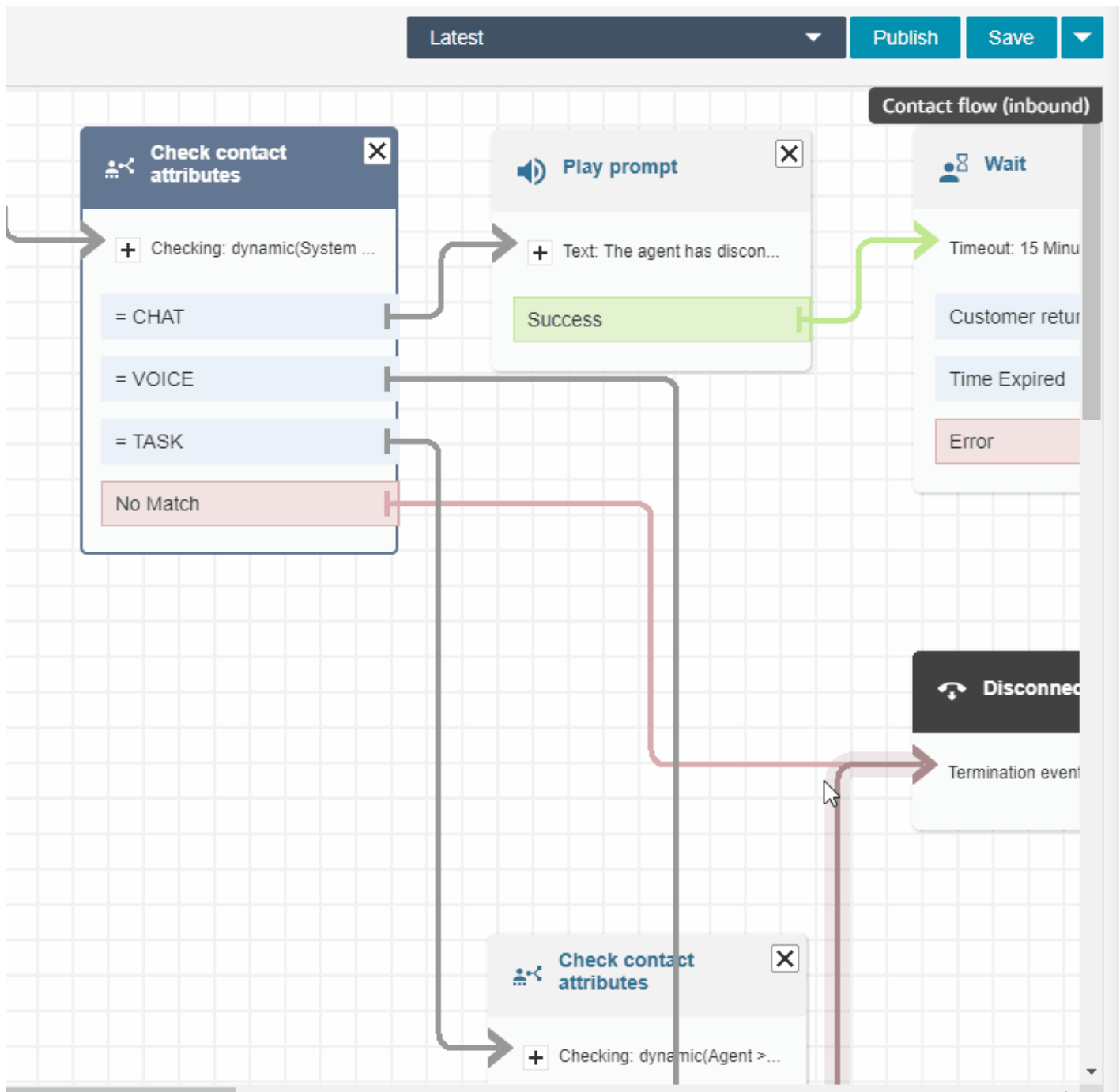

Search for Amazon Connect users by first name, last name, login, and more

You can search for Amazon Connect users by first name, last name, user login, agent hierarchy, security profile, and routing profile. For example, you can search for all Amazon Connect users who have the first name "Jane."

Queue dashboard

You can visualize historical queue data by using time series graphs to help identify patterns, trends, and outliers specifically for **Service Level**, **Contacts Queued**, and **Average Handle Time**. For more information, see [Visualize: Queue dashboard](#).

August 2022 Updates

Contact search: Apply "Match any" or "Match all" to Contact Lens category searches

When you search for contacts, and filter by Contact Lens categories, you can apply **Match any** or **Match all** to the search. For example, you can search contacts with both "category A" and "category B," or with either one of the two categories.

Evaluate calls for voice spoofing

Use Voice ID to evaluate calls for voice spoofing. For more information, see [Voice spoofing detection](#) and the [Amazon Connect Voice ID API Reference](#).

Added SearchSecurityProfiles API

Added a new API for programmatically searching security profiles. For more information, see https://docs.aws.amazon.com/connect/latest/APIReference/API_SearchSecurityProfiles.html.

Released Schedule Adherence (Preview)

Contact center supervisors or managers track schedule adherence to understand when agents are following the schedule that you have created. This helps ensure you achieve your service level targets, while improving agent productivity and customer satisfaction. For more information, see [Schedule Adherence](#).

July 2022 Updates

Search for contacts by using the agent's first or last name

You can search for contacts using the agent's first or last name. The filter name is **Agent**.

Search contacts by agent's first or last name

The following image shows the Agent filter, and the option to choose agents by name.

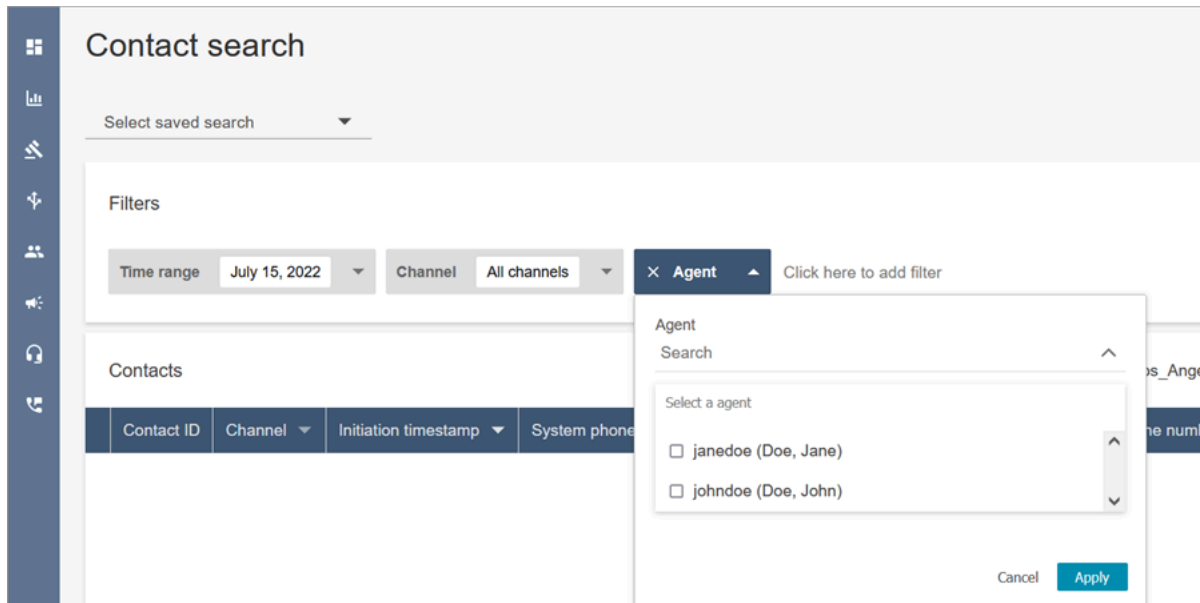

Required permissions to "Agent" search filter

To use the **Agent** filter on the **Contact search** page, in your Amazon Connect security profile you must have **Users - View** permissions, as shown in the following image:

Users and permissions ⓘ			
Type	All	View	Edit
Users	<input type="checkbox"/>	<input checked="" type="checkbox"/>	<input checked="" type="checkbox"/>
Agent hierarchy	<input type="checkbox"/>	<input checked="" type="checkbox"/>	<input checked="" type="checkbox"/>
Security profiles	<input type="checkbox"/>	<input checked="" type="checkbox"/>	<input checked="" type="checkbox"/>
Agent status	<input type="checkbox"/>	<input checked="" type="checkbox"/>	<input checked="" type="checkbox"/>

When you have **Users - View** permissions, on the **Contact search** page the **Agent** filter appears, as shown in the following image:

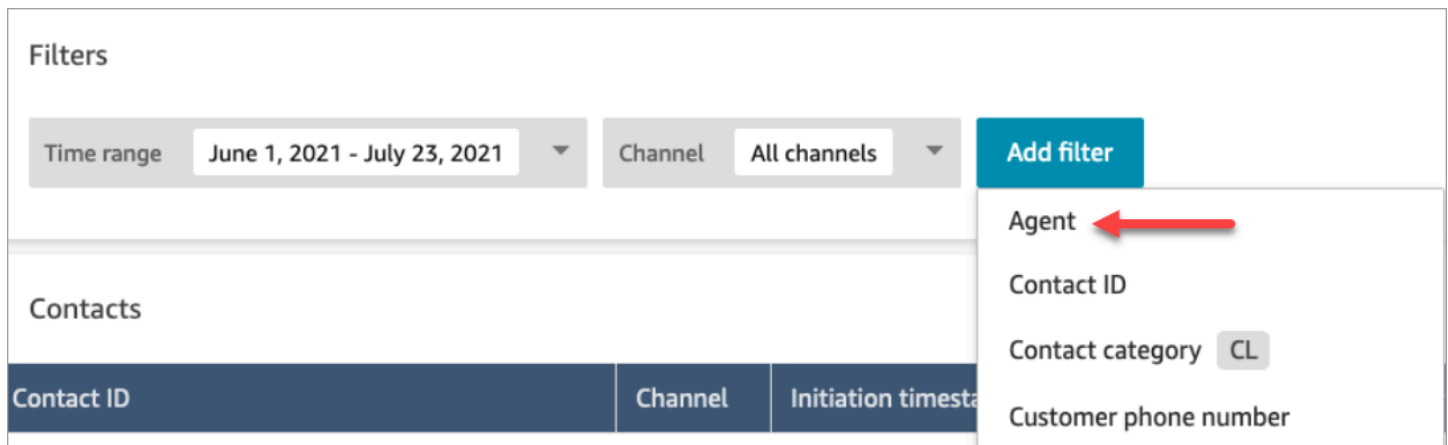

Without **User - View** permissions, the **Agent** filter is not visible, and searching contacts by Agent login is not supported, as shown in the following image:

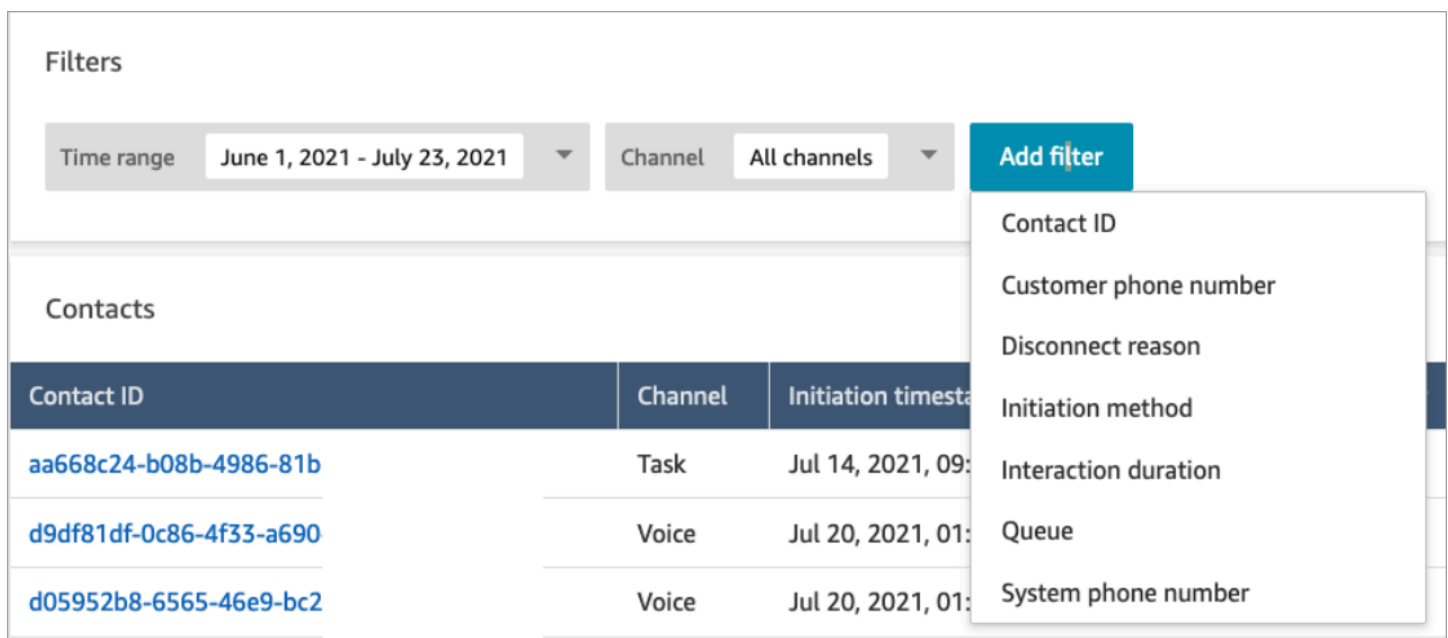

Released updates for rich text format rendering

On the **Contact Search** and **Contact Detail** pages, you can now view chat transcripts that have rich text formatting, such as bold or italic font, bullet points, numbered lists, and hyperlinks. For more information about getting started with Amazon Connect Chat, see [Set up your customer's chat experience](#).

View call transcript using the CCP or agent application

Agents can view call unredacted transcripts in the CCP and agent application. For more information, see [View a call transcript during ACW](#).

June 2022 Updates

Support for Lex intent confidence scores and sentiment analysis

You can further personalize the automated self-service customer experience using Amazon Lex intent confidence scores and sentiment analysis as a branch within your flows. For more information, see the [Get customer input](#) block. For a list of new contact attributes, see [Amazon Lex contact attributes](#).

Metrics Updates

The following updates were released in June 2022.

15 minute scheduled reports

You can now schedule historical metrics to refresh every 15 minutes. To select 15-minute schedules, select generate this report **Hourly** every .25 hours (this is the top most option in the second dropdown), for the previous .25 hours. The following image shows the values that you need to select.

Recurrence

Delivery Options

Generate this report

Hourly ▼ every **0.25** ▼ hours

Starting at **01 AM** ▼

Time zone
UTC

UTC ▼

For the previous **0.25** ▼ hours

Create **Cancel**

Filter Real-Time Metrics Agent Table by Agent

You can now filter the agent table on the Real-Time Metrics page by agent. This filter functions the same as the existing queues, routing profiles, and agent hierarchy filters.

Table Settings ✕

Time range Filters Metrics

The setting will determine the main rows (primary grouping) in the table.

Filter primary groupings by

Agents ▲

- Queues
- Routing profiles
- Agent hierarchy
- Agents**

Cancel Apply

New contact transferred related metrics

We are upgrading the existing [Contacts transferred in](#) and [Contacts transferred out](#) historical metrics to have consistent definitions. We are adding [Contacts transferred in by agent](#) and [Contacts transferred out by agent](#) for more granular contact transferred related metrics.

Changes to real-time metrics agent tables

We are rolling out a new service to maintain the high availability from metrics that you expect from Amazon Connect. Due to this change, the agent tables are sorted by [agent status](#) instead of by agent login.

Additionally, the queues and routing profiles table are sorted by agents online instead of by queue or routing profile name.

Faster reload times for the Real-time metrics page

We are upgrading the performance of the **Real-time metrics** page so reload times are faster. The page will have the same functionality and user experience as the existing **Real-time metrics** page.

Released Amazon Connect Cases (Preview)

Amazon Connect Cases (Preview) allows your agents to quickly track and manage customer issues that require multiple interactions, follow-up tasks, and teams in your contact center. For more information, see [Amazon Connect Cases \(Preview\)](#) and [Amazon Connect Cases API Reference \(Preview\)](#).

GA for Amazon Connect outbound campaigns

Released Amazon Connect outbound campaigns, formerly known as High-volume outbound communications. This release includes a set of APIs for creating and managing outbound campaigns. For more information, see [Enable Amazon Connect outbound campaigns](#) and [Amazon Connect Outbound Campaigns API Reference](#).

Released GetCurrentUserData API

Released the [GetCurrentUserData](#) API. It enables you to return the real-time active user data from the specified Amazon Connect instance.

Released task templates

You can now create custom task templates, making it easy for agents to consistently capture the relevant and required information to create or complete tasks. For more information, see [Create task templates](#). For information about using the API to programmatically create and manage task templates, see the [Amazon Connect API Reference](#) and the [Amazon Connect Resource Type Reference](#) in the *AWS CloudFormation User Guide*.

New API to transfer contacts

Added a new API that you can use to transfer contacts from one agent or queue to another agent or queue at any point after a contact is created. You can transfer a contact to another queue by providing the flow which orchestrates the contact to the destination queue. This gives you more control over contact handling and helps you adhere to the service level agreement (SLA) guaranteed to your customers.

For information, see [TransferContact](#) in the *Amazon Connect API Reference*.

May 2022 Updates

Updated workflow for outbound campaigns

Updated the workflow for onboarding to outbound campaigns using the Amazon Connect and Amazon Pinpoint user interface. For more information, see [Enable outbound campaigns](#).

Voice ID expires speakers

For BIPA Compliance, Amazon Connect Voice ID automatically expires speakers that have not been accessed for enrollment, re-enrollment, or successful authentication for three years. You can see a speaker's last access time by looking at the `LastAccessedAt` attribute returned by the [DescribeSpeaker](#) and [ListSpeakers](#) APIs.

For more information, see [What data is stored?](#) in the [Use real-time caller authentication with Voice ID](#) topic.

April 2022 Updates

New API to change an agent's current status

Amazon Connect provides an API to programmatically change the current status of an agent. [Agent statuses](#) are used to determine when an agent is **Available** to be routed contacts in Amazon Connect, versus when they are set to **Offline** or a custom status such as **Lunch** or **Break** and should not be routed contacts. For more information, see [PutUserStatus](#) in the [Amazon Connect API Reference](#).

New API to search for users by name, agent hierarchies, and tags

Added API to search for user records in your Amazon Connect instance. This new API provides a programmatic and flexible way to search for users by first name, last name, username, routing profile, security profile, agent hierarchies or tags. For example, you can now use this API to search for all users tagged with a `Department:key` value pair. You can also quickly find a list of all users assigned to a specific security profile, routing profile, or agent hierarchy. For more information, see the [Amazon Connect API Reference](#).

New APIs to claim and configure phone numbers

Added new APIs to claim new phone numbers and configure them programmatically. Using these APIs, you can programmatically search for and claim available phone numbers, associate phone numbers to flows, or release phone numbers that are no longer needed. Additionally, the phone number APIs come with support for AWS CloudFormation. For more information, see the [Amazon Connect API Reference](#) and the [Amazon Connect Resource Type Reference](#) in the *AWS CloudFormation User Guide*.

Telephony: Multi-party calls

You can enable Amazon Connect to allow up to six parties on a call: the agent, the caller, and four more participants. (By default, Amazon Connect allows agents to have up to three parties on a call: the agent, and caller, and another participant.) For more information, see [Update instance settings](#). For more information, see [Host multi-party calls](#).

For information about new functionality on the existing Connection and Contact API in Amazon Connect Streams, see the [Amazon Connect Streams Readme](#).

The following sections describes how managing multi-party calls differs from managing three-party calls.

Contents

- [New behavior with multi-party calls](#)
- [Comparison: Three-party and multi-party calls](#)

New behavior with multi-party calls

- All agents see all of the connections in a call.
- All agents have exactly the same capabilities as any other agent on the call. This takes into affect the moment an agent accepts the invitation to join the call.
- Before a warm transfer is complete, an agent can start talking to the caller as well as disconnect any other agent on the call.

Comparison: Three-party and multi-party calls

The following table summarizes the differences between the agent's experience using the Contact Control Panel (CCP) for three-party calls and multi-party calls.

- Primary agent: the first agent on the call.
- Secondary agent: any agent other than the first agent on the call.

Three-party calls	Multi-party calls
Agent can control hold, resume, and disconnect only the parties they added.	All agents are have the same call control capabilities.
Agent can add one other participant to an existing call, for a total of three participants (the agent, the caller, and another participant).	Any agent on the call can add additional participants, as long as the total number of participants on the call, including themselves, does not exceed six.
Agent can put only the party they added on hold.	Any agent on the call can put any party on hold.
When a primary agent places a secondary agent on hold, the secondary agent can't take themselves off hold.	Any agent on the call can take themselves off hold.
Secondary agent can talk to the primary agent during hold.	Secondary agents cannot talk to each other until they are taken off hold.
Primary agent can only mute themselves. Secondary agent can only mute themselves.	Any agent on the call can mute any other participant on the call.
When an agent disconnects (leaves or is disconnected), call control continues to be available to the remaining agent(s) on the call.	When an agent disconnects, control of the call is transferred to the remaining agents.
Only the primary agent can disconnect a party on the call. The secondary agent can	All agents have the capability to disconnect any other party.

Three-party calls	Multi-party calls
disconnect the caller only if the primary agent has disconnected.	
The primary agent can see two connections (caller and another party), while a secondary agent sees only the transfer connection.	All agents can see all connections.
An agent only sees internal transfer for another agent on the call.	An agent sees the quick connect ID for other agents, instead of just internal transfer .
Not applicable.	When an party is being dialed, an agent on a multi-party call cannot add another party until the prior dial operation is completed (party added or call leg terminated).

Play prompts from an Amazon S3 bucket

Added the ability to source prompts from an Amazon S3 bucket. You can store as many voice prompts as needed in Amazon S3 and access them in real time by using contact attributes in the following contact blocks that play prompts: [Get customer input](#), [Loop prompts](#), [Play prompt](#), and [Store customer input](#).

For more information, see the [Play prompt](#) block. For information about the policy required for Amazon Connect to access the Amazon S3 bucket, see [Set up prompts to play from an S3 bucket](#).

CloudTrail support for queues and routing profiles

Amazon Connect records all changes made to users, routing profiles, and queues as events in AWS CloudTrail. For example, you can identify who took which action, what resources were acted upon, and when an event occurred. For more information, see [the section called "Logging service API calls"](#).

March 2022 Updates

Rich messaging for chat

Added support for rich messaging for your customer's chat experience. Agents and customers can use bold, italics, bulleted lists, numbered lists, hyperlinks, and attachments. For more information, see [Enable text formatting for your customer's chat experience](#).

Customer Profiles: Object type mapping user interface

Added a user interface for creating object type mapping by using the Amazon Connect admin console. For more information, see [Create an object type mapping](#).

February 2022 Updates

Added bulk ingestion of data for Customer Profiles

Added support for the bulk ingestion of data for Customer Profiles. For more information, see *Bulk ingestion of data* in the [Set up integration for Salesforce, ServiceNow, Marketo, or Zendesk](#) topic.

New CloudWatch metrics for chat

Added the following Amazon CloudWatch metrics for chat: **ConcurrentActiveChats**, **ConcurrentActiveChatsPercentage**, **ChatBreachingActiveChatQuota**, and **SuccessfulChatsPerInterval**. For more information, see [Monitoring your instance using CloudWatch](#).

January 2022 Updates

Configure maximum chat duration up to 7 days

You can configure the maximum chat duration to last up to 7 days. For more information, see the `ChatDurationInMinutes` parameter in the [StartChatContact](#) API.

Add custom vocabularies to Contact Lens

Improve the accuracy of speech recognition for product names, brand names, and domain-specific terminology, by expanding and tailoring the vocabulary of the speech-to-text engine in Contact Lens. For more information, see [Add custom vocabularies](#).

Earlier Updates

December 2021 Updates

Communications widgets support browser notifications

The communications widget supports browser notifications for desktop devices. For more information, see [Browser notifications](#).

Ingest data into Customer Profiles from Segment and Shopify

For more information, see [Set up integration for Segment](#) and [Set up integration for Shopify](#).

November 2021 Updates

Released unified agent application

Amazon Connect released the unified agent application to improve the agent experience and customer interactions. For more information, see [Agent training guide](#).

Released key highlights

Amazon Connect Contact Lens provides the option for you to view key highlights. The highlights show only those lines where Contact Lens has identified an issue, outcome, or action item in the transcript. For more information, see [View key highlights](#).

Released Identity Resolution to consolidate similar profiles

Amazon Connect Customer Profiles offers Identity Resolution, a feature that is designed to automatically detect similar customer profiles by comparing name, email address, phone number, date of birth, and address. For example, two or more profiles with spelling mistakes, such as "John Doe" and "Jhn Doe," can be detected as belonging to the same customer "John Doe" using clustering and matching machine learning (ML) algorithms. Once a group of profiles are detected to be similar, admins can configure how profiles should be merged together by setting up consolidation rules by using the [Amazon Connect admin console](#) or [Amazon Connect Customer Profiles APIs](#).

Amazon Connect Customer Profiles stores contact history at no charge

Amazon Connect Customer Profiles now provides contact history and customer information together in unified customer profiles at no charge, helping contact center managers personalize

the contact center experience. In new instances, Customer Profiles is enabled by default. For more information, see [Step 4: Data Storage](#) in the *Create an Amazon Connect instance* topic.

Added modular flows to help you create common functions

Flow modules are reusable sections of a flow. You can create them to extract repeatable logic across your flows, and create common functions. For more information, see [Flow modules for reusable functions](#).

New APIs to archive/unarchive and delete contact flows

Added new APIs that provide a programmatic and flexible way to manage your library of flows at scale. For example, flows used only during certain times of the year can be archived when not in use and then unarchived when needed. You can now also delete a flow so it is no longer available for use. For more information, see the [Amazon Connect API Reference](#).

Search contacts by custom contact attributes

Added support for searching contacts by custom contact attributes (also called user-defined attributes). For more information, see [Search by custom contact attributes](#).

Added Customer profiles block

Added the [Customer profiles](#) block. It enables you to retrieve, create, and update a customer profile.

Released Contact APIs

Added APIs so you can get and update contact details programmatically. For example, you can describe contact details such as queue information, chat attachments, task references, and update contact information such as task name. For more information, see [DescribeContact](#), [UpdateContact](#), and [ListReferences](#) in the *Amazon Connect API Reference*.

Released scheduled tasks

Added the ability to schedule tasks up to six days in the future to follow-up on customer issues when promised. You can also update the scheduled date and time using the [UpdateContactSchedule](#) API. For more information, see the [Create task](#) block and the [Create a task](#) topic in the *Agent training guide*.

Released security profiles APIs

Added APIs so you can create and manage security profiles programmatically. Security profiles help you manage who can access the Amazon Connect dashboard and Contact Control Panel (CCP), and who can perform specific tasks. For more information, see the [Amazon Connect API Reference](#).

Changes to real-time metrics agent tables

We are rolling out a new service to maintain the high availability from metrics that you expect from Amazon Connect. Due to this change, the agent tables are sorted by [agent status](#) instead of by agent login.

Additionally, the queues and routing profiles table are sorted by agents online instead of by queue or routing profile name.

Added new metrics

Added following new historical metrics: **Contacts transferred in by agent** and **Contacts transferred out by agent**. Added new real-time metrics: **Transferred in by agent** and **Transferred out by agent**. For more information, see [Historical metrics definitions](#) and [Real-time metrics definitions](#).

October 2021 Updates

Released real-time chat message streaming

You can subscribe to a real-time stream of chat messages. For more information, see [Enable real-time chat message streaming](#).

Released HoursOfOperation APIs for General Availability

Released the Amazon Connect HoursOfOperation APIs for general availability (GA). Also launched AWS CloudFormation support for Users, User Hierarchies, and Hours of Operation. For more information, see the [Amazon Connect API Reference](#) and the [AWS CloudFormation User Guide](#).

September 2021 Updates

Released Amazon Connect Wisdom General Availability

Note

In November 2023 we released Amazon Q. It includes real-time agent assist functionality formerly known as Amazon Connect Wisdom, along with generative AI-powered recommended responses, actions, and links to more information.

For more information, see [Use Amazon Q in Connect for generative AI-powered agent assistance in real-time](#) and the [Amazon Q in Connect API Reference](#).

Amazon Connect Voice ID - General Availability

For more information, see [Use real-time caller authentication with Voice ID](#) and the [Amazon Connect Voice ID API Reference](#).

Preview release of Amazon Connect outbound campaigns

Added content for the preview release of outbound campaigns. By using Amazon Pinpoint Journeys and Amazon Connect, you can now create outbound campaigns for voice, SMS, and email. For more information, see [Enable outbound campaigns](#).

New Amazon AppIntegrations Service APIs

New DataIntegration APIs for the Amazon AppIntegrations Service: `CreateDataIntegration`, `DeleteDataIntegration`, `GetDataIntegration`, `ListDataIntegrationAssociations`, `ListDataIntegrations`, `UpdateDataIntegration`.

For more information, see [Amazon AppIntegrations Service API Reference](#).

Display name and contact attributes in chat

You can now personalize the chat experience, as you can specify the name of your customer that interacts using the chat user interface. You can also securely pass the contact attributes to capture information about the contact which can be used in the flow to further personalize the experience. For more information, see [Pass the customer display name when a chat initializes](#) and [Pass contact attributes when a chat initializes](#).

Preview of agent application

Launched an updated UI for the agent application preview that combines Customer Profiles and the Contact Control Panel (CCP). For more information, see [Access Customer Profiles in the agent application](#).

Added Create task block

Added the **Create task** block. It creates a new task, sets the tasks attributes, and initiates a flow to start the task. For more information, see [Flow block: Create task](#).

August 2021 Updates

Improved user interface for Amazon Connect console

Released a redesigned and improved user interface for the Amazon Connect console, making it easier and faster to manage Amazon Connect instances. For more information, see [Create an Amazon Connect instance](#).

APIs for Hours of Operation and Agent Status (Preview)

Released for ungated preview new APIs for managing hours of operation and agent status. For more information, see [Amazon Connect Service API Reference](#).

Contact Lens: Build rules that generate tasks and EventBridge events

Contact Lens rules now allow you to automatically generate tasks and EventBridge events based on uttered keywords, sentiment scores, customer attributes, and other criteria. For more information, see [Create rules with Contact Lens](#).

Networking: Allow AWS Global Accelerator

When using SAML Sign-In to your Amazon Connect instance, you now need to add the AWS Global Accelerator domain, *. [awsglobalaccelerator.com](#), to your allow list. For more information, see [Set up your network](#).

July 2021 Updates

"Next status" feature for the CCP

In busy contact centers, it can be difficult for agents to take a break or go offline when contacts are being quickly routed to them. To help agents manage their time, we have released a feature that

lets agents pause new contacts being routed to them while they finish their current contacts. When all their slots are cleared, Amazon Connect automatically sets agents to the next status, such as **Lunch**.

For details about how agents use this feature, see [Set your "Next status" in the CCP](#).

Metrics: No changes due to "Next status"

When an agent is in **Next status**, their metrics are the same as when their status is **Available**.

For example, an agent is handling one contact and chooses **Next status**. Here's what you'll see in the real-time metrics report:

- Agent Activity state = On Contact
- Agent - Staffed = 1

Non-productive time (NPT) is not incremented when an agent is in **Next status** because the agent is still **Available**. NPT increments only when the agent actually enters the non-productive status, such as **Lunch**.

Agent event stream has new NextAgentStatus field

When an agent sets their status to **Next status**, Amazon Connect populates a new `NextAgentStatus` field with the next status selected by the agent.

At the same time, the `AgentStatus` field continues to display `Available`.

The following code snippet shows what the agent event stream looks like when an agent has set their CCP to **Next status: Lunch**.

```
"CurrentAgentSnapshot":
{
  "AgentStatus": {
    "ARN": "example-ARN",
    "Name": "Available",
    "StartTimestamp": "2019-08-13T20:52:30.704Z"
  },
  "NextAgentStatus": {
    "Name": "Lunch",
    "ARN": "example-ARN2",
```

```
    "EnqueueTimestamp": "2019-08-13T20:58:00.004Z",  
  }  
}
```

When an agent has not selected a **Next status**, the field is null, as shown in the following snippet:

```
"CurrentAgentSnapshot": {  
  "AgentStatus": {  
    "ARN": "example-ARN",  
    "Name": "Available",  
    "StartTimestamp": "2019-08-13T20:52:30.704Z"  
  },  
  "NextAgentStatus": null  
}
```

Amazon Connect Streams API and "Next status"

The feature has the following effect:

- If you integrate with Amazon Connect Streams API and your agents interact directly with the native CCP user interface, your agents will start using this new feature immediately.
- If you integrate with Amazon Connect Streams API but your agents don't interact directly with the native CCP user interface, your contact center will continue to have the previous behavior when `agent.setState()` is called: an agent will not be able to select an NPT or Offline status while connected to at least one contact.

If you are handling state change logic yourself from Amazon Connect Streams, you will need to make additional changes explained in the [Amazon Connect Streams README](#).

Contact search: To search contacts by Agent login requires Users - View permissions in your security profile

To use the **Agent** filter on the **Contact search** page, in your Amazon Connect security profile you must have **Users - View** permissions, as shown in the following image:

Users and permissions ⓘ			
Type	All	View	Edit
Users	<input type="checkbox"/>	<input checked="" type="checkbox"/>	<input checked="" type="checkbox"/>
Agent hierarchy	<input type="checkbox"/>	<input checked="" type="checkbox"/>	<input checked="" type="checkbox"/>
Security profiles	<input type="checkbox"/>	<input checked="" type="checkbox"/>	<input checked="" type="checkbox"/>
Agent status	<input type="checkbox"/>	<input checked="" type="checkbox"/>	<input checked="" type="checkbox"/>

When you have **Users - View** permissions, on the **Contact search** page the **Agent** filter appears, as shown in the following image:

ⓘ The contact search page has a brand new experience. Now you can select your search timeframe by the hour. You can use multi-select for agent names, contact queues, contact flows, and more. Also, we've extended the time range of search from two weeks to eight weeks. The [previous version](#) of the contact search page will be completely removed on November 19, 2021.

Filters

Time range: June 1, 2021 - July 23, 2021 | Channel: All channels | **Add filter**

- Agent
- Contact ID
- Contact category
- Customer phone number
- Disconnect reason
- Initiation method
- Interaction duration
- Non-talk time
- Queue
- Sentiment Score
- System phone number
- Words or phrases

Contact ID	Channel	Initiation timestamp	Queue	Agent
aa668c24-b08b-4986-81br	Task	Jul 14, 2021, 09:00		
d9df81df-0c86-4f33-a690-	Voice	Jul 20, 2021, 01:00	BasicQueue	agent1
d05952b8-6565-46e9-bc2l	Voice	Jul 20, 2021, 01:00		
9020830f-81c8-4ec1-8e52	Voice	Jul 20, 2021, 01:00	BasicQueue	agent1
5c5fed3d-7030-4355-86d4	Task	Jul 14, 2021, 09:00	BasicQueue	
5ea1aebb-4831-467f-a65e	Voice	Jul 14, 2021, 09:00	BasicQueue	
db95419c-3268-48b7-916-	Voice	Jun 15, 2021, 11:00	BasicQueue	

Without **User - View** permissions, the **Agent** filter is not visible, and searching contacts by Agent login is not supported, as shown in the following image:

Filters

Time range Channel **Add filter**

Contacts

Contact ID	Channel	Initiation timestamp
aa668c24-b08b-4986-81b	Task	Jul 14, 2021, 09:...
d9df81df-0c86-4f33-a690	Voice	Jul 20, 2021, 01:...
d05952b8-6565-46e9-bc2	Voice	Jul 20, 2021, 01:...

- Contact ID
- Customer phone number
- Disconnect reason
- Initiation method
- Interaction duration
- Queue
- System phone number

June 2021 Updates

Apple Messages for Business GA

Released Apple Messages for Business for general availability (GA). For more information, see [Enable Apple Messages for Business](#).

Quick connects management API GA

Released Amazon Connect quick connects management API for general availability (GA). For more information, see [Amazon Connect Service API Reference](#). The quick connects API also supports AWS CloudFormation. For more information, see [Amazon Connect Resource Type Reference](#) in the AWS CloudFormation User Guide.

Support for Amazon Lex V2 console and APIs

For more information on using the Amazon Lex V2 console with Amazon Connect, see [Add an Amazon Lex bot](#). Added these three APIs: AssociateLexBot, DisassociateLexBot, and ListLexBots. See the [Amazon Connect Service API Reference](#).

Chat: Increase to chat agent concurrency

Chat agents can now handle up to 10 concurrent chat contacts. For more information, see [Create a routing profile](#).

May 2021 Updates

Added contact events

Subscribe to a near real-time stream of contact events (for example, call is queued) in your Amazon Connect contact center. For more information, see [Amazon Connect contact events](#).

Contact search

The following changes were release for Contact search:

- Download increase: You are able to download 3,000 rows of search results to a CSV file, instead of 1,000 rows. This increase applies to contacts that occurred after Dec 01, 2020.
- Contact search supports Disconnect Reason as a new filter on the **Contact search** page.

The following image shows how **Disconnect reason** appears in the user interface as a filter.

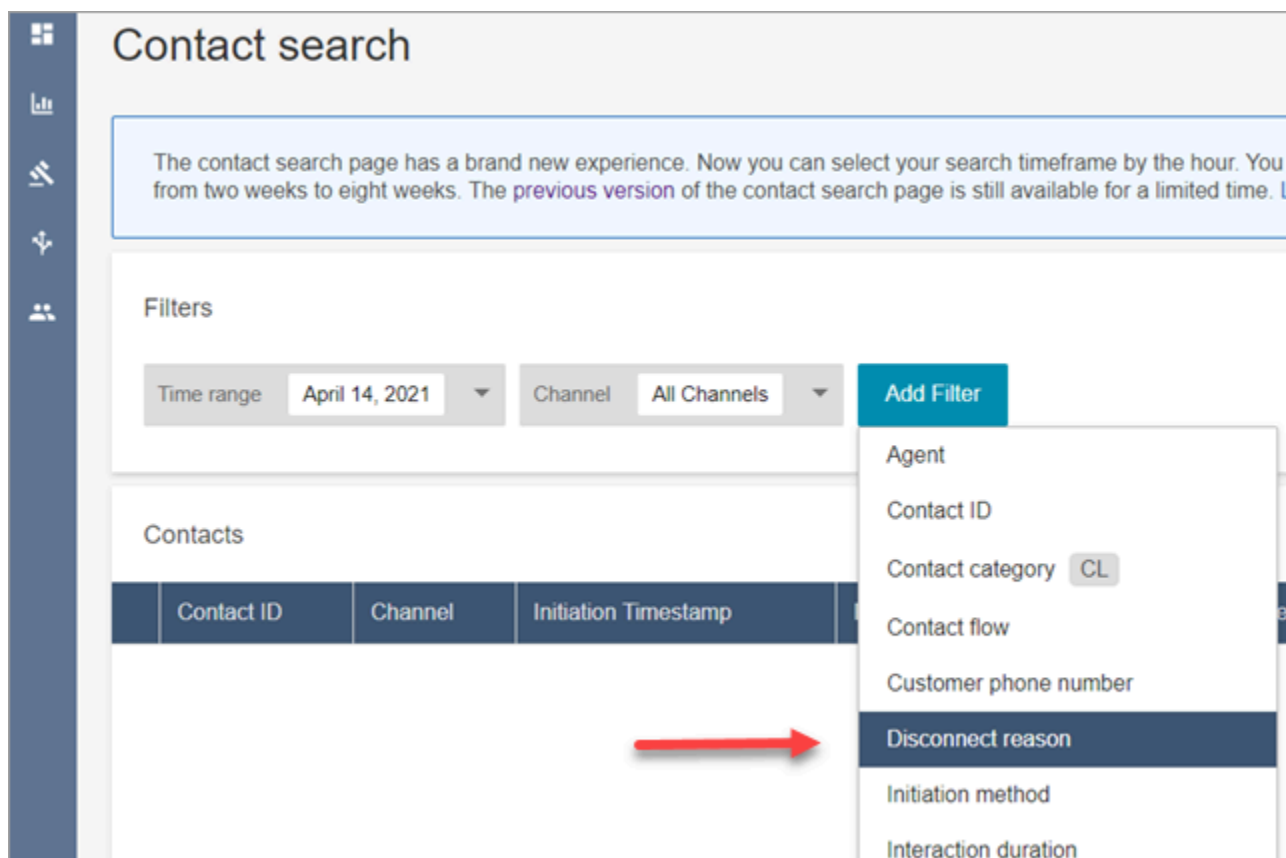

The following image shows how you can filter by type of disconnect reason. For a definition of each disconnect reason, see the [ContactTraceRecord](#) section of the *Contact records data model* topic.

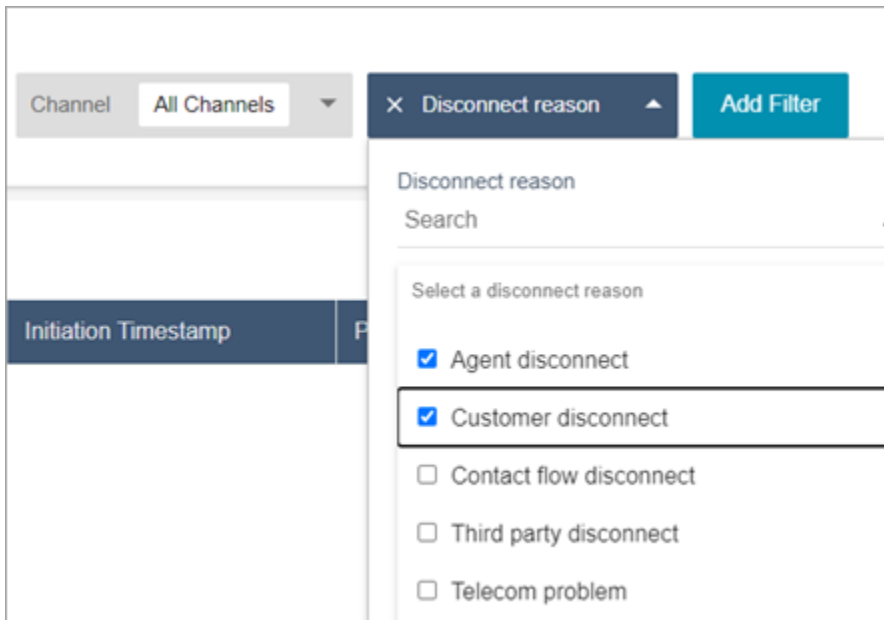

The following image shows how you add **Disconnect reason** as a column to your search results.

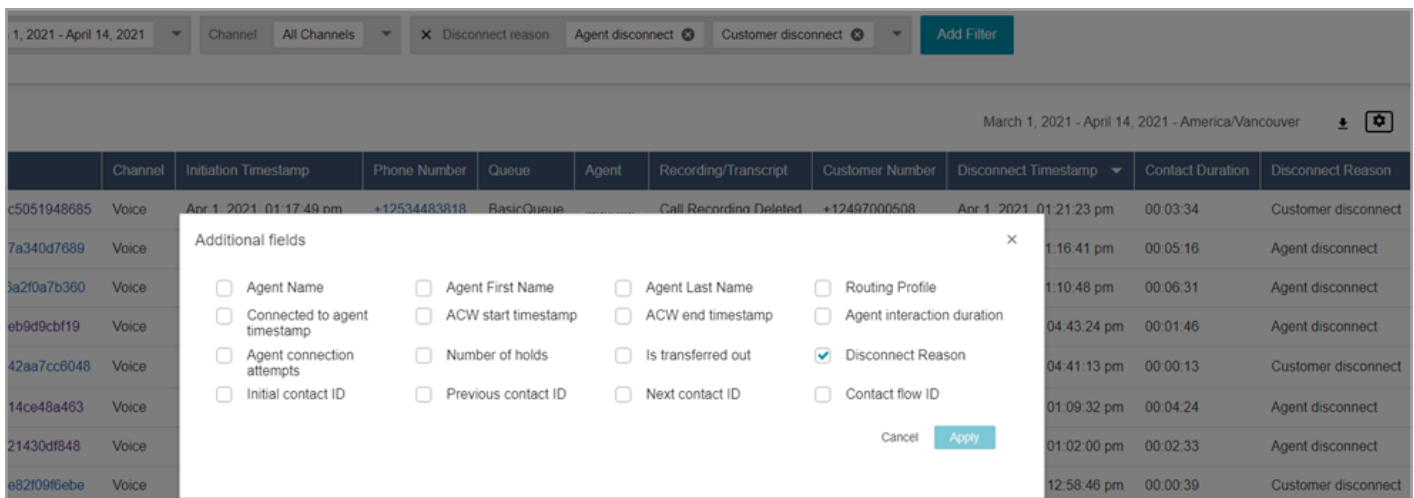

April 2021 Updates

Customer Profiles: Identity resolution

Added identity resolution APIs to Customer Profiles. For more information, see the [GetMatches](#) and [MergeProfiles](#) APIs in the Amazon Connect Customer Profiles API reference.

Contact Lens: Use category tags to navigate transcript

For more information, see [Tap or click category tags to navigate through transcript](#).

Fixes for chat metrics

We released fixes for the following issues identified in chat metrics:

- Amazon Connect incorrectly reported that chat contacts that were created from disconnect flows were created from transfer flows.
- When these fixes, Amazon Connect correctly reflects in the contact records and agent event stream that these chat contacts were created from disconnect flows.

There is no impact to voice or task contacts.

Chat contacts created through disconnect flows no longer increment the following metrics:

- [Contact flow time](#)
- [Contacts incoming](#)
- [Contacts handled incoming](#)
- [Contacts transferred in](#)

In addition, note the following fixes for contact records and the agent event stream for chat contacts:

- Contact records: There was an issue in the Attributes section of a chat contact record where the initiation method is **API** for both disconnect and transfer contacts. With this fix, the initiation method correctly reflects **Disconnect** and **Transfer**, respectively.
- Agent event stream: Chat contacts created from disconnect flows now have **Disconnect** as the initiation method.

March 2021 Updates

Amazon Connect is now available in the Canada (Central) Region

Amazon Connect is now available in the Canada (Central) Region. You can claim toll-free and local telephone numbers from Canadian telephony suppliers. For a list of countries where the Canada (Central) Region is supported, see [Region requirements for phone numbers](#). For a list of Contact Lens features available in the Canada (Central) Region, see [Availability of Contact Lens features by Region](#).

Domain for new Amazon Connect instances is "my.connect.aws"

The domain for the Amazon Connect access URL has changed to **my.connect.aws**.

For example:

- Current: `https://[instance name].awsapps.com/connect/`
- New: `https://[instance name].my.connect.aws/`

How does this change impact logging in to Amazon Connect?

The current access URL continues to work for Amazon Connect instances created before the release of the **my.connect.aws** domain. Any Amazon Connect instances created after the release automatically use the new domain.

Also, if you create new Amazon Connect instances after the release of the new domain, you must add new domains to your allowlist. These domains are **in addition** to the ones that are currently required.

Currently required domains added to your allow list:

- `{myInstanceName}.awsapps.com/connect/ccp-v2`
- `{myInstanceName}.awsapps.com/connect/api`
- `*.cloudfront.net`

New additional domains to add to your allowlist:

- `{myInstanceName}.my.connect.aws/ccp-v2`
- `{myInstanceName}.my.connect.aws/api`
- `*.static.connect.aws`

For more information, see [Set up your network](#).

Schedule for domain change

The change has been rolled out to all Regions.

March 2021

The following updates were released in March 2021.

When customizing a historical metrics report, you have the option to select a 15 minutes interval, in addition to the current option of a 30 minutes interval.

The 15 minutes interval works the same as the 30 minutes interval. For example, you can query up to three days of data at a time, for the past 35 days.

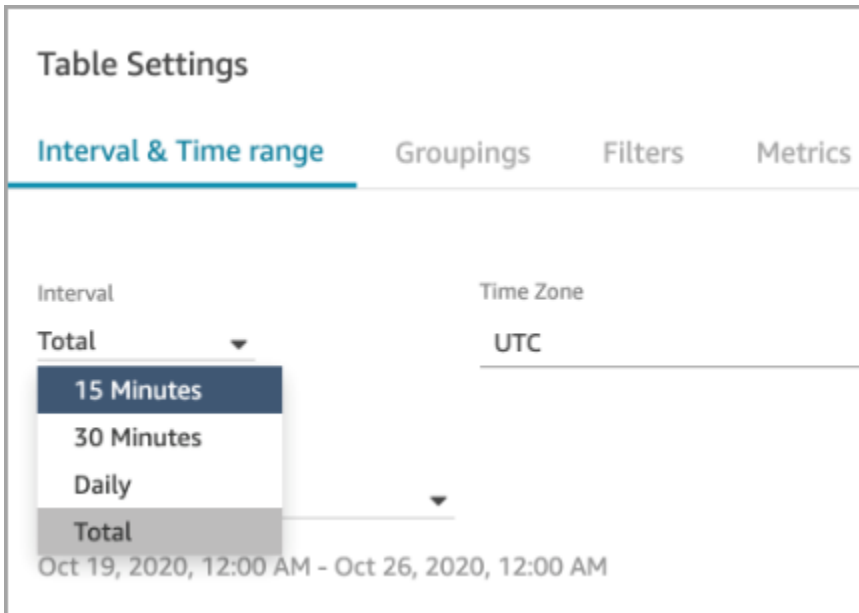

Chat: Add a chat user interface your website

Added a communications widget that you can customize and secure so it can only be launched from your widget. For more information, see [Set up your customer's chat experience](#).

Provided an open source example. For more information, see [Download and customize our open source example](#).

Amazon Connect Endpoint Test Utility

To help you validate connectivity to Amazon Connect, or troubleshoot when your agents are experiencing problems with the Contact Control Panel (CCP), we've added the Amazon Connect Endpoint Test Utility. For more information, see [Use the Endpoint Test Utility](#).

February 2021 Updates

Contact Lens: Availability of real-time analytics

Contact Lens real-time analytics is available in Europe (London), Europe (Frankfurt), and Asia (Tokyo). For more information, see [Contact Lens features by Region](#).

Ingest data into Customer Profiles using Amazon S3

Added the ability to create and ingest data from Amazon S3. For more information, see [Create and ingest customer data into Customer Profiles by using Amazon S3](#).

Disconnect reason in contact record stream

The Amazon Connect contact records stream now includes **DisconnectReason** for voice calls and tasks. **DisconnectReason** indicates whether an agent or customer disconnected the call, or whether a telecom or network issue caused a call to disconnect. You can also determine whether a task was completed by an agent or an automatic flow, or it expired. For more information, see [ContactTraceRecord](#).

Custom service levels

Added the ability to create custom service levels. For details, see [New metric groupings and categories](#).

Metrics updates

The following updates were released in February 2021.

New metric groupings and categories

With the release of [custom service level metrics](#), we also made the following changes:

- On the **Table settings** pages, pre-set and [custom service level metrics](#) are in a new group called **Contact Service Levels**.
- Historical metrics on the **Table settings** page are grouped into categories.
- The order of metric columns on historical metrics reports changed to match the order of the metrics on the **Table settings** page.

Following is more information about these changes.

Real-time metrics: New Contact Service Level category

A new category of metrics appears on the **Table settings** page: **Contact Service Level**.

The following image shows this new category on the **Table settings** page, in an expandable group. Choose the arrow next to the group to view and select the metrics you want to add to your report.

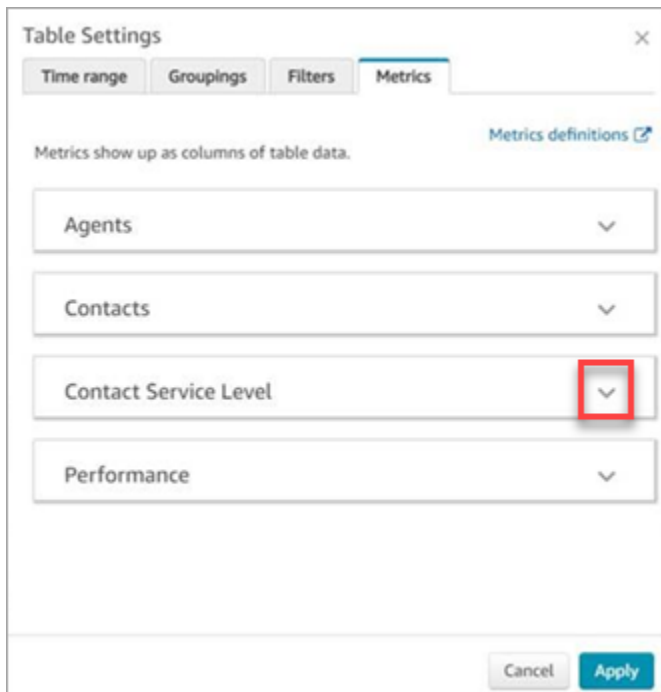

Use the **Contact Service Level** category to choose pre-set service level metrics, and to create custom service level metrics.

The following image shows the user interface for creating custom service level metrics.

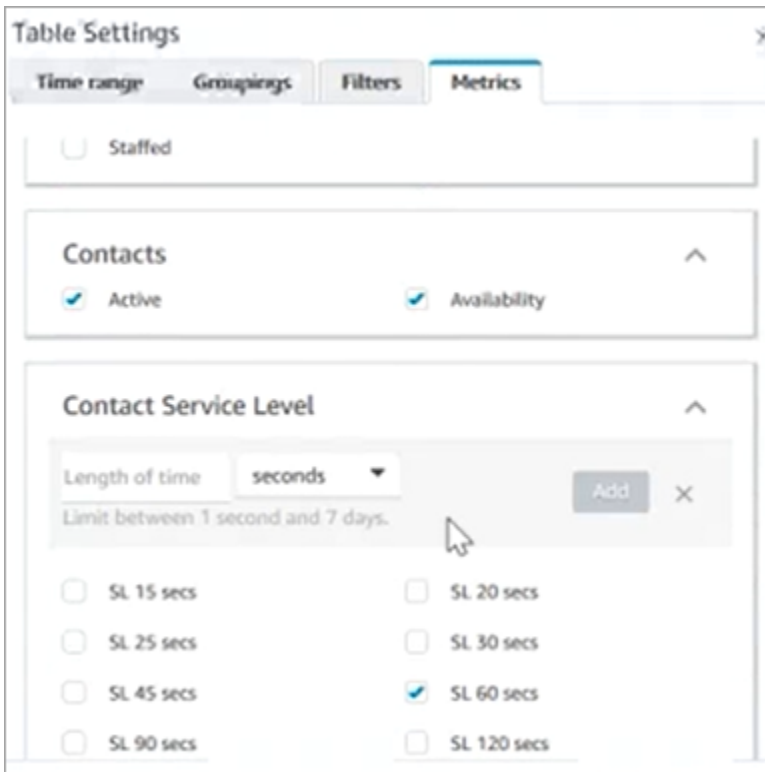

Historical metrics: New categories for metrics

To make it easier to find the historical metrics you want to add to a report, metrics on the **Table settings** page are grouped into the following categories:

- Agents
- Contacts Abandoned
- Contact Service Level: This group contains preset and custom service levels.
- Contacts Answered
- Performance

Choose **Add Custom SL** to add custom service levels to your historical metrics report.

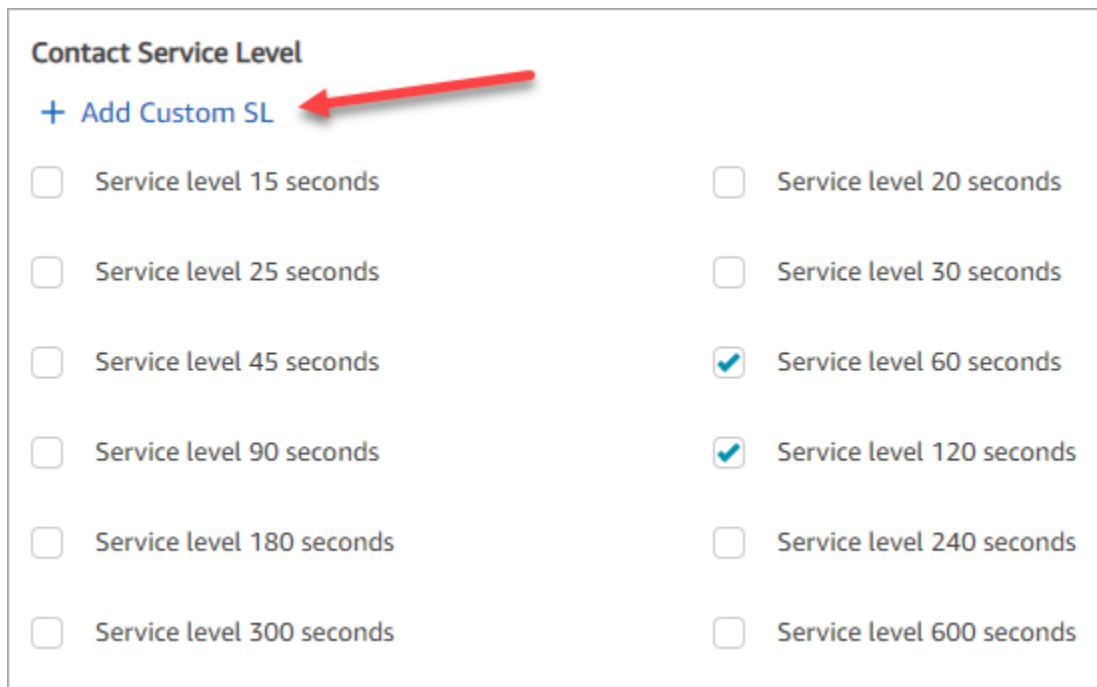

Contact Service Level

[+ Add Custom SL](#)

<input type="checkbox"/> Service level 15 seconds	<input type="checkbox"/> Service level 20 seconds
<input type="checkbox"/> Service level 25 seconds	<input type="checkbox"/> Service level 30 seconds
<input type="checkbox"/> Service level 45 seconds	<input checked="" type="checkbox"/> Service level 60 seconds
<input type="checkbox"/> Service level 90 seconds	<input checked="" type="checkbox"/> Service level 120 seconds
<input type="checkbox"/> Service level 180 seconds	<input type="checkbox"/> Service level 240 seconds
<input type="checkbox"/> Service level 300 seconds	<input type="checkbox"/> Service level 600 seconds

The order of the metric columns on the historical metrics reports has changed

The order of the metric columns on the historical metrics reports matches the updated grouping scheme and order of the metrics on the **Table settings** page.

This change supports the addition of [custom service level metrics](#). It also allows us to make future improvements for where, for example, control of how a report looks resides on the **Real-time metrics** page and the **Historical metrics** page, not the **Table settings** page.

Note how metric columns now appear on reports:

- When you open the **Real-time metrics** page, custom service levels appear at the end of the **Performance** group.
- Metrics on existing **Scheduled reports** (the processed documents that arrive in your Amazon S3 buckets) are not re-ordered automatically. However, if you update an existing report, the metrics are re-ordered to match the order on the **Table settings** page.
- **Service level metrics:**
 - Real-time metrics reports: Service level metrics are always added to the end of the **Performance** group, in ascending order.
 - Historical metrics reports: When you add custom service level metrics, they are added to the end of the report in the order they were created.

Custom service level metrics

You have the ability to add custom service level metrics. You can also choose from additional durations, such as minutes, hours, or days.

The maximum duration for a custom service level is 7 days. That's because in Amazon Connect you can't have a contact that goes longer than 7 days.

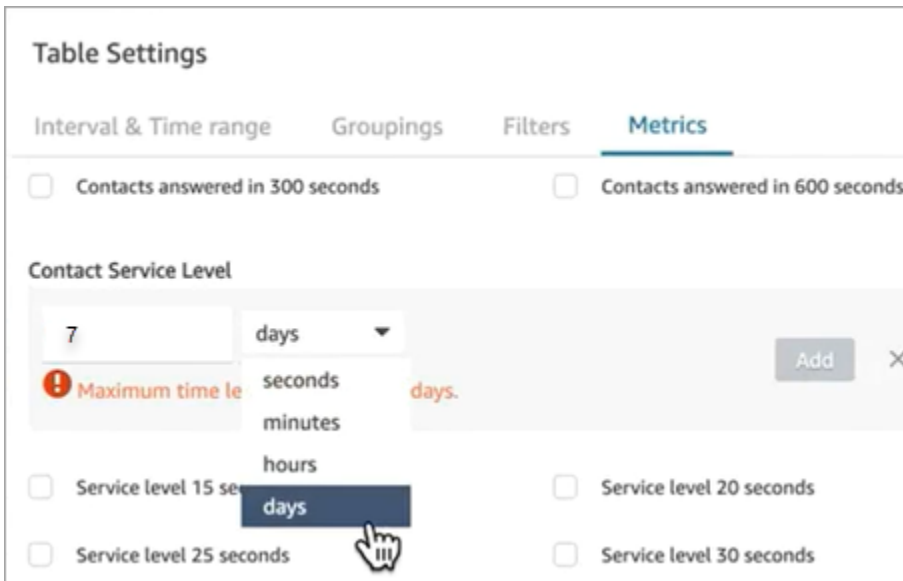

Group by channel in a historical metrics report

To group by channel on historical metrics reports

1. On the navigation menu, choose **Analytics and optimization, Historical metrics**, and then choose a report.
2. Choose **Settings**.
3. On the **Table Settings** page, choose the **Groupings** tab. Add **Channel**, and choose **Apply**.

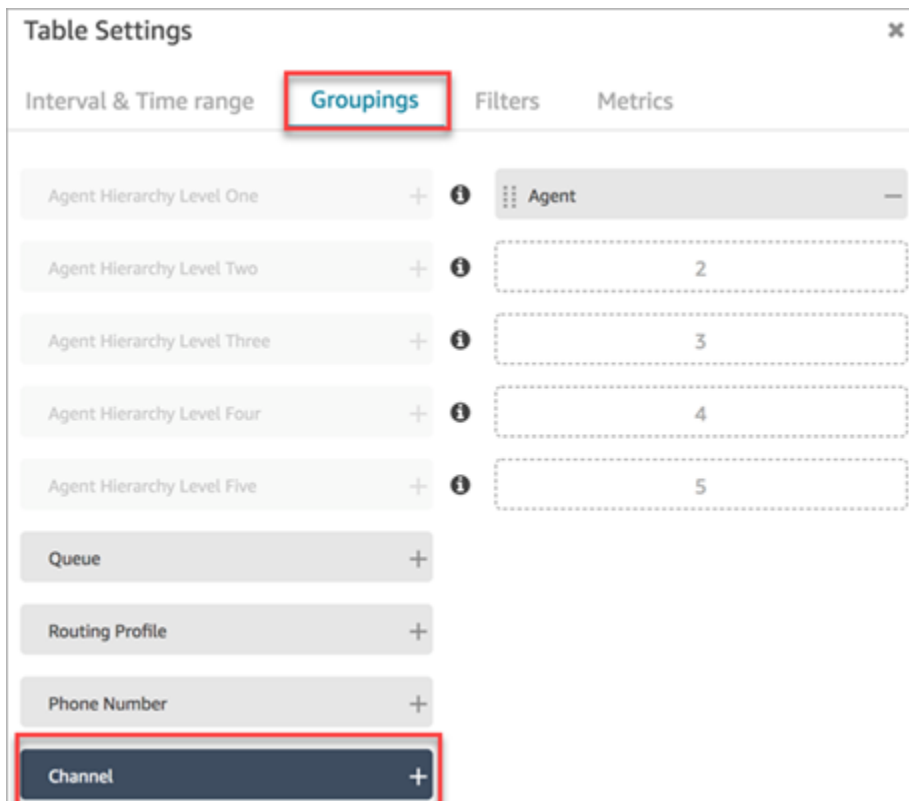

4. The table shows a column for **Channel**, as shown in the following image.



January 2021 Updates

CCP: Change your audio settings

Added the ability to change audio settings from the Contact Control Panel (CCP). This applies to organizations using a customized CCP. For more information, see [How to use the CCP or agent workspace to change your audio device settings](#).

Queue APIs (Preview)

Added APIs so you can programmatically create and manage queues. For more information, see [Amazon Connect Service API Reference](#).

Amazon AppIntegrations APIs - GA

Released Amazon AppIntegrations APIs for general availability (GA). For more information, see [Amazon AppIntegrations Service API Reference](#).

December 2020 Updates

Quick Connect APIs (Preview)

Added APIs so you can programmatically create and manage quick connects. For more information, see [Amazon Connect Service API Reference](#).

Chat: Support for attachments

Added support for chat attachments. For more information, see [Enable attachments to share files using chat and upload files to cases](#).

Added the following APIs:

- [CompleteAttachmentUpload](#)
- [GetAttachment](#)
- [StartAttachmentUpload](#)

Configurable DTMF timeouts for Lex bots

For more information, see [Configurable fields for DTMF input](#).

Tasks

Added support for tasks, allowing you to prioritize, assign, track, and even automate tasks across the disparate tools agents use to support customers. For more information, see [Concepts: Tasks in Amazon Connect](#).

Amazon Connect APIs

Added an Amazon Connect API that provides the ability to create tasks (StartTaskContact), and a set of preview APIs.

Preview APIs:

- CreateIntegrationAssociation

- DeleteIntegrationAssociation
- ListIntegrationAssociations
- CreateUseCase
- DeleteUseCase
- ListUseCases

Amazon AppIntegrations APIs (Preview)

Added the Amazon AppIntegrations APIs (Preview), which enables you to configure and reuse connections to external applications. For more information, see [Amazon AppIntegrations Service API Reference \(Preview\)](#).

Customer Profiles

Added Amazon Connect Customer Profiles, enabling agents to create a customer profile for every new contact that comes in. You can also integrate with external applications that provide customer profile data. For more information, see [Use Customer Profiles](#) and the [Amazon Connect Customer Profiles API Reference](#).

Real-time analytics using Contact Lens

Added real-time analytics for Contact Lens so you can detect and resolve customer issues more proactively while the call is in progress. For more information, see [Analyze conversations using conversational analytics](#) and the [Amazon Connect Contact Lens API Reference](#).

Amazon Connect Voice ID (Preview)

Added Amazon Connect Voice ID (Preview), which provides for real-time caller authentication. For more information, see [Use real-time caller authentication with Voice ID](#).

Amazon Connect Wisdom (Preview)

Note

In November 2023 we released Amazon Q. It includes real-time agent assist functionality formerly known as Amazon Connect Wisdom, along with generative AI-powered recommended responses, actions, and links to more information.

Added Amazon Connect Wisdom (Preview), which enables agents to search and find content across multiple repositories, such as frequently asked questions (FAQs), wikis, articles, and step-by-step instructions for handling different customer issues.

Amazon Connect with Apple Messages for Business (Preview)

Added support for using Amazon Connect with Apple Messages for Business. For more information, see [Enable Apple Messages for Business](#).

November 2020 Updates

Telephony call metadata attributes

- Added call attributes to improve fraud detection and routing. For more information, see [Telephony call metadata attributes \(call attributes\)](#).

View historical changes

- The ability to **View historical changes** on the resource configuration pages is now available for the London Region. The following differences appear as the changes are rolled out to other Regions.
 - Total results: The number feature in the **View historical changes** search page, and page numbers, are replaced with **Previous** and **Next** icons.
 - The Username filter requires the entire login name.

Chat

- Added interactive message templates. For more information, see [Add interactive messages to chat](#).

APIs

- Added APIs so you can programmatically manage your agent hierarchies and agent groups. For more information, see [Amazon Connect Service API Reference](#).
- Added the following APIs (in an ungated preview release):
 - CreateInstance

- DescribeInstance
- ListInstances
- DeleteInstance
- UpdateInstanceAttribute
- UpdateInstanceStorageConfig

October 2020 Updates

The following updates were released in October 2020:

Flows

- Added chat support for whisper flows. For more information, see [Flow block: Set whisper flow](#).

Metrics

- Released the following real-time metrics:
 - [Avg callback connecting time](#)
 - [Avg incoming connecting time](#)
 - [Avg outbound connecting time](#)

Released the following historical metrics:

- [Agent API connecting time](#)
- [Agent callback connecting time](#)
- [Agent incoming connecting time](#)
- [Agent outbound connecting time](#)
- [Average agent API connecting time](#)
- [Average agent callback connecting time](#)
- [Average agent incoming connecting time](#)
- [Average agent outbound connecting time](#)
- In real-time metrics reports, added one-click drill-downs. These allow you to drill down into queue and routing profile data in one click. For more information, see [Use one-click drill-downs for Routing profiles and Queues tables](#).

- Added the **Restrict contact access** permission which enables you to manage a user's access to results on the **Contact search** page based on their agent hierarchy group. For more information, see [Search for contacts](#).
- Added **ContactDetails** and **References** to the contact record. For more information, see [Contact records data model](#).

September 2020 Updates

The following updates were released in September 2020:

Service quotas

- Updated the service quotas for the following Amazon Connect Participant Service APIs:
 - [CreateParticipantConnection](#)
 - [DisconnectParticipant](#)
 - [GetTranscript](#)

Flows

- Added the Amazon Connect Flow language, a JSON-based representation of a series of flow actions, and the criteria for moving between them. For more information, see [Flow language](#).

APIs

Added the following APIs for flows:

- [CreateContactFlow](#)
- [DescribeContactFlow](#)
- [UpdateContactFlowContent](#)
- [UpdateContactFlowName](#)

Added the following API to list prompts:

- [ListPrompts](#)

Added the following APIs for routing profiles:

- [AssociateRoutingProfileQueues](#)
- [CreateRoutingProfile](#)
- [DescribeRoutingProfile](#)
- [DisassociateRoutingProfileQueues](#)
- [ListRoutingProfileQueues](#)
- [UpdateRoutingProfileConcurrency](#)
- [UpdateRoutingProfileName](#)
- [UpdateRoutingProfileQueues](#)

August 2020 Updates

The following updates were released in August 2020:

Flows

- Added the ability to automatically use the best sounding voice available from Amazon Polly for text-to-speech. For more information, see [Amazon Polly best sounding voice](#).
- Added the ability to select, cut, copy, and paste flows. For more information, see [Copy and paste flows](#).

Telephony

- Added the ability for all customers to enable/disable media support for outbound phone calls. For more information, see [Step 3: Set telephony](#) in the [Create an Amazon Connect instance](#) topic.

Monitoring

- Added logging of Amazon Connect Participant Service calls with AWS CloudTrail. For more information, see [Logging Amazon Connect API calls with AWS CloudTrail](#).

Contact Lens for Amazon Connect

- Updated the security profile permissions for the redaction feature. For more information, see [Security profile permissions for Contact Lens](#).

July 2020 Updates

The following updates were released in July 2020:

Flows

- The **Set voice** block supports speaking styles with neural text-to-speech (TTS) voices. For more information, see [Flow block: Set voice](#).

APIs

- Added [StartContactRecording](#), [StopContactRecording](#), [SuspendContactRecording](#), [ResumeContactRecording](#) to the Amazon Connect Service API.

Contact Lens for Amazon Connect

- Updated Contact Lens for Amazon Connect for general availability. This feature lets you analyze customer-agent conversations, by using speech transcription, natural language processing, and intelligent search capabilities. For more information, see [Analyze conversations using conversational analytics](#).

Metrics

- Fixed content that was added in June 2020 that said **Agent idle time**, **Agent on contact time**, and **Occupancy** had been deprecated. That was incorrect. Rather, they are no longer available for queue groupings only.
- Corrected how **Occupancy** is calculated. The correct calculation is:

$(\text{Agent on contact (wall clock time)} / (\text{Agent on contact (wall clock time)} + \text{Agent idle time}))$

June 2020 Updates

The following updates were released in June 2020:

June 2020: Changes for omnichannel support

Group by channel

To group queues or routing profiles by channel on real-time metrics reports

1. On the navigation menu, choose **Analytics and optimization, Real-time metrics**, and then select either **Queues** or **Routing profiles**.

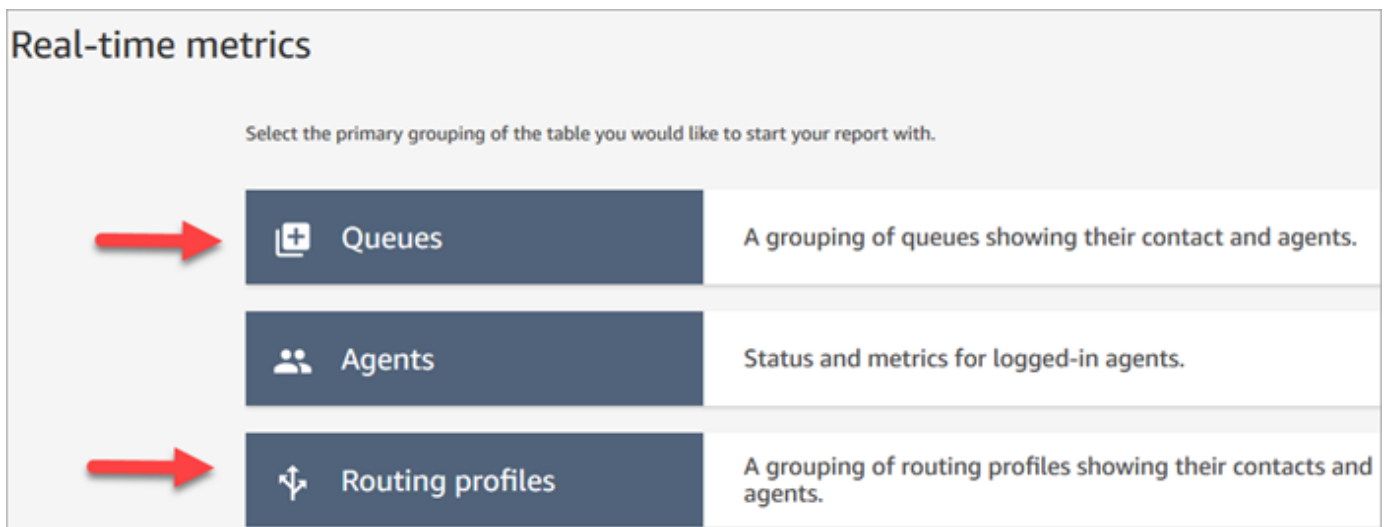

2. Choose **Settings**.

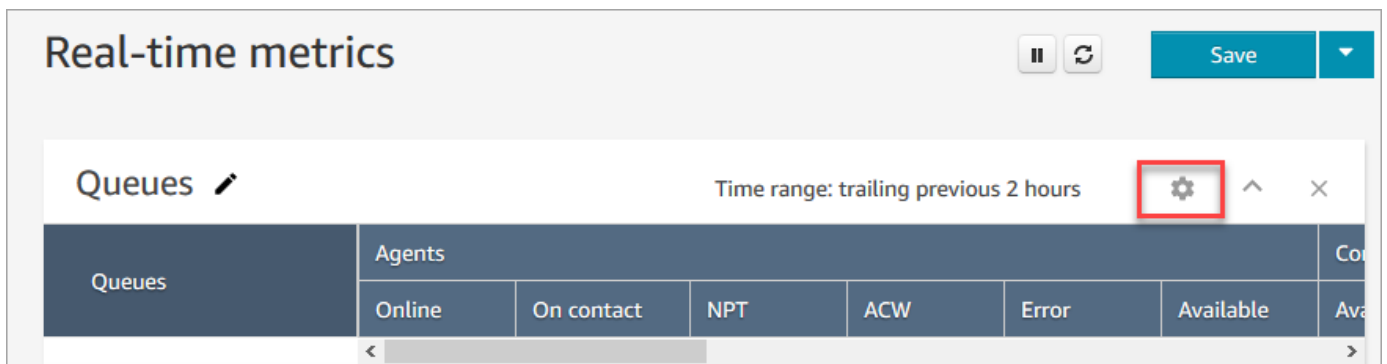

3. On the **Table Settings** page, choose the **Groupings** tab and then select **Queues grouped by channels**. Or, if you're setting up a **Routing profiles** report, choose **Routing profiles grouped by channels**.

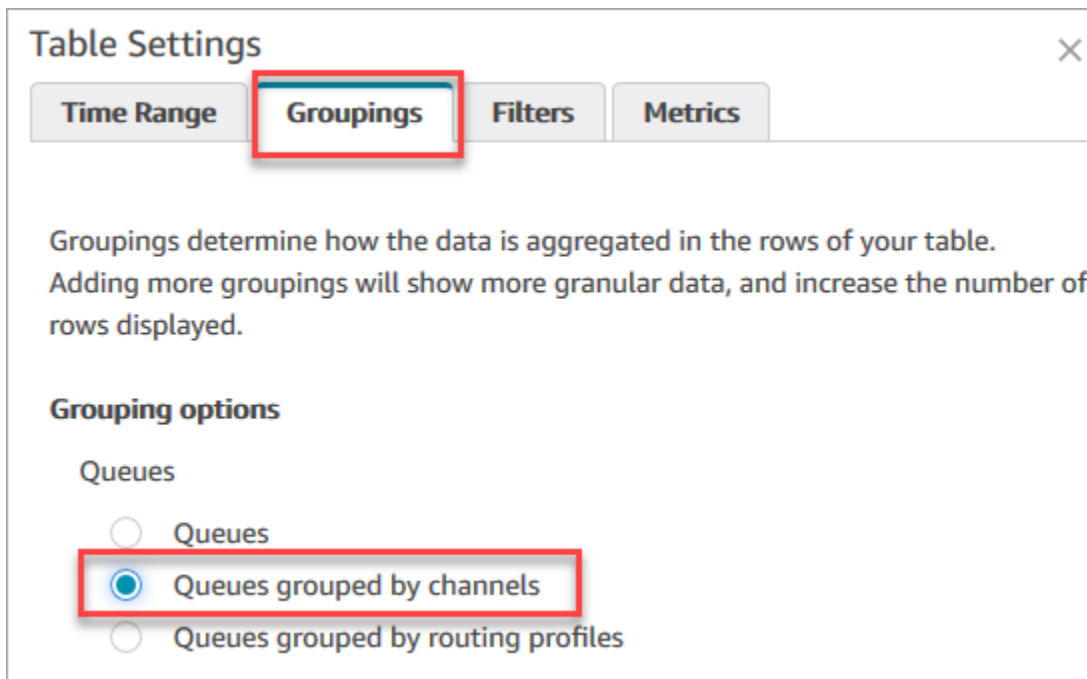

4. Choose **Apply**.
5. The table shows a column for **Channel**.

Group by queue in historical metrics reports

In the historical metrics report, when you group or filter metrics by **Queue**, the results for the following metrics aren't accurate:

- Agent idle time (not supported in queue grouping as of June, 2020)
- Agent on contact time (not supported in queue grouping as of June, 2020)
- Occupancy (not supported in queue grouping as of June, 2020)

Because of this, on the **Table Settings** page, **Metrics** tab, these metrics are inactive, as shown in the following image:

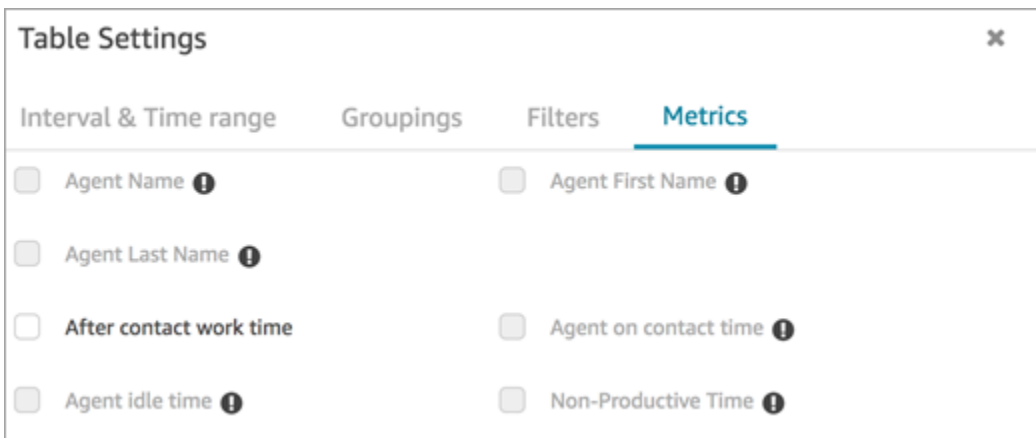

In addition, in the historical metrics report, Amazon Connect displays a hyphen (-) in place of results for these metrics, and the cells are inactive (gray).

Interval	Time range
Total	Mar 12, 2020, 12:00 AM - Mar 19, 2020, 12:00 AM

Agent	Agent on contact time	Agent idle time
AnswerRates	-	-
ConcurrentOccupancy	-	-
ContactsIncoming	-	-

Effect of queue grouping on saved and scheduled reports

If the **Queue** grouping or filter is used on the following reports, note these effects:

- **Dashboards and reports.** The columns for these metrics don't appear in the saved reports when *grouped* by Queue. When the saved report is *filtered* by Queue, however, it shows "-".
- **Scheduled reports.** These reports continue to run successfully, but no results are returned for these metrics.

Agent on contact time (not supported in queue grouping as of June, 2020)

On historical metrics reports when an agent handles multiple chats concurrently, **Agent on contact time** shows wall clock time: the amount of time spent chatting. However, there isn't a metric that shows the time an agent spends chatting with each contact.

In addition, no results are returned when you use the **Queue** grouping or filter with **Agent on contact time**.

Agent idle time (not supported in queue grouping as of June, 2020)

The **Agent idle time** metric divides the idle time into each queue associated with the agent. When contacts are grouped or filtered by **Queue**, however, Amazon Connect doesn't provide an accurate view into the how the agent is working. Because of this, Amazon Connect doesn't show **Agent idle time** when you apply the **Queue** grouping or filter to your report.

Occupancy (not supported in queue grouping as of June, 2020)

With the addition of chat, the **Occupancy** metric is now defined as the percentage of time that an agent was active on contacts. This percentage is calculated as follows:

- $(\text{Agent on contact (wall clock time)} / (\text{Agent on contact (wall clock time)} + \text{Agent idle time}))$

Because **Agent idle time** is now inaccurate when contacts are grouped or filtered by **Queues**, the **Occupancy** metric is also inaccurate. As a result, when contacts are grouped or filtered by **Queues**, **Occupancy** doesn't appear on the report.

Occupancy no longer appears on the **Dashboard** page.

Contact Control Panel (CCP)

- Released the following improvements:
 - DTMF input is passed to all lines in a three-way call. Any party can enter DTMF input.
 - Resolved an issue where the DTMF tone degraded when agents interacted with Quick connect and/or Number pad during a session.
 - Resolved an issue where quick connects sometimes did not appear on a page, even after an agent refreshed it.
 - Improved the experience when a manager "listens in" to multiple chat conversations. Updated the unread message count on the CCP to include messages sent by the customer and those sent by the agent. Previously, the unread message count only included messages sent by the customer.
- Published instructions for upgrading to the latest CCP. For more information, see [Upgrade to the latest CCP](#).

- Published a training video that explains how to use the CCP. For more information, see [Training video: How to use the CCP](#).

Flows

- The **Set disconnect flow** block supports voice conversations. For more information, see [Flow block: Set disconnect flow](#).
- The **Set Voice** block supports Amazon Polly Neural Text-to-Speech (NTTS) voices. For more information, see [Flow block: Set voice](#).
- The **Get queue metrics** block can return metrics by channel, for example, by voice or chat. For more information, see [Flow block: Get queue metrics](#).

May 2020 Update

The following updates were released in May 2020:

Flows

- Added the ability to select multiple blocks at the same time and rearrange them as a group within a flow. For more information, see [Create an inbound flow](#).

April 2020 Update

The following updates were released in April 2020:

Telephony

- Added early media support for outbound phone calls. Enabled by default, an agent hears tones and audio messages played by phone companies—such as busy signals, failure to connect errors, or other informational messages—through their headset or audio device. For more information, see [Step 3: Set telephony](#) in the [Create an Amazon Connect instance](#) topic.
- Added the barge-in-enabled session attribute to the [Get customer input](#) block so customers can interrupt Amazon Lex bots with their voice.

March 2020 Update

The following updates were released in March 2020:

Flows

- Updated the [Store customer input](#) block to allow you to specify a custom terminating keypress.

Metrics

- Announced [June 2020: Changes for omnichannel support](#).

Networking

- Updated softphone requirements in [Set up your network](#).

February 2020 Update

The following updates were released in February 2020:

Service Quotas

- Adjusted [Amazon Connect service quotas](#) for new accounts.

Flows

Updated the following blocks so you can set contact attributes:

- [Set customer queue flow](#)
- [Set hold flow](#)
- [Set whisper flow](#)

January 2020 Update

The following updates were released in January 2020:

Contact Control Panel (CCP)

The following updates were made to the updated Contact Control Panel (ccp-v2):

- Agents can now transfer a contact by double-clicking a quick connect. For more information, see [Transfer calls to a quick connect or external phone number](#).
- The number pad now retains the previously selected country flag so agents don't need to select it every time.
- All strings in the CCP user interface are now localized in available languages.
- Resolved an issue where the color of the call status bar incorrectly displayed as green during a conference call when the call was in the Joined state. It is now blue.
- Resolved an issue where the agent's name was displayed in error messages for missed chats, rather than the customer's name.

Networking

- Updated [Set up your network](#) to include requirements for the updated Contact Control Panel (ccp-v2).

December 2019 Update

The following update was released in December 2019:

Monitoring

- Added Contact Lens for Amazon Connect for preview. This feature enables you search conversations for keywords, sentiment scores, and non-talk time. For more information, see [Analyze conversations using conversational analytics](#).
- Added logging of Amazon Connect API calls with AWS CloudTrail. For more information, see [Logging Amazon Connect API calls with AWS CloudTrail](#).

November 2019 Update

The following updates were released in November 2019:

Omnichannel Support

- Added support for chat communications. For more information, see [Concepts](#).

November 2019

Name changes for "Missed" and "Agent status" and "On call"

The following real-time metrics were renamed:

Old name	New name
Missed	Agent non-response
Agent status	Agent activity
On call	On contact

For each metric, existing saved reports automatically start displaying the new name; you don't need to do anything for the new name to appear in your reports.

The column order for a saved report containing one of these metrics stays the same. For example, if you previously saved a report where **Agent status** was the third metric, now when you open that saved report, **Agent activity** is the name for the third metric.

For **Missed**, only the name of the metric changed; the underlying calculation stayed the same. We've changing the name of this metric to **Agent non-response** so it better reflects its definition:

- **Agent non-response** increments whenever a contact is offered to an agent, and the agent doesn't respond to the contact for whatever reason.

For example, the agent could have intentionally let the timer run out, or the agent could have forgotten to grant microphone access in the Contact Control Panel and never heard the ring. In these situations, Amazon Connect doesn't drop the contact. Instead, the routing engine will offer it to another available agent, while the customer continues to wait in queue. This means a single contact could result in multiple **Agent non-responses** before an agent responds and handles the contact.

For **On call**, the name change to **On Contact** applies to the Real-time metrics UI only. You can continue using `AGENTS_ON_CALL` with the `GetCurrentMetricData` API to retrieve data for this metric.

Label updates for "Agent activity" and "Contact state"

Labels are the values returned in a report. For example, in the following image **Available** and **Basic Routing Profile** are labels.

Real-time metrics				
Agents ✎				
Agent Login	Agent			
	Status	Duration	Agent Hierarchy	Routing Profile
[blurred]	Available ▾	138:57:42	-	Basic Routing Profile
[blurred]	Available ▾	167:47:25	-	Blended Agent Profile
[blurred]	Available ▾	20:49:43	-	Basic Routing Profile

For **Agent Activity** and **Contact State**, we renamed some of the labels that describe what the agent's current activity is and what's happening with the contact they are currently working on. This way, the labels in the Real-Time Metrics report are more consistent with the labels the agent sees in the Contact Control Panel. They also align with the data returned about these different states in other parts of Amazon Connect.

When the name of **Agent Status** changed to **Agent Activity**, the following labels changed, too:

Scenario	Before: Agent Status Labels	After: Agent Activity Labels	Notes
Agent is logged in but offline	Not shown	Not shown	
Agent switches to Available in the CCP	Available	Available	
Agent has an incoming call	CallIncoming	Incoming	ContactState = Incoming contact

Scenario	Before: Agent Status Labels	After: Agent Activity Labels	Notes
Agent has an incoming callback	CallbackIncoming	Incoming	ContactState = Inbound callback
Agent accepted a callback, which is now making an outbound call to the customer	Calling	On Contact	ContactState = Outbound callback
Agent makes outbound call (regardless of what status the agent chose in their CCP)	Calling	On Contact	ContactState = Outbound contact
Agent missed a phone call due to timer expired	MissedCallAgent	Missed	
Agent is interacting with customer on phone call (regardless of what status the agent chose in their CCP)	On call	On Contact	
Agent puts customer on hold while on phone call (regardless of what status the agent chose in their CCP)	On call	On Contact	
After agent hangs up call	After call work	After contact work	

Scenario	Before: Agent Status Labels	After: Agent Activity Labels	Notes
Agent is on Lunch (a custom status)	Lunch	Lunch	
Supervisor's activity state if they are monitoring some agent	Monitoring	Monitoring	
Agent's activity state if they are connected to customer while being monitored by a supervisor	On call	On Contact	

The following table shows the how the labels changed for **Contact State**.

Scenario	Label Name Before	Label Name After
Agent is logged in but offline		
Agent switches to Available in the CCP	-	-
Agent has an incoming call	-	Incoming contact
Agent has an incoming callback	-	Inbound callback
Agent accepted a callback, which is now making an outbound call to the customer	Initial	Outbound callback

Scenario	Label Name Before	Label Name After
Agent makes outbound call (regardless of what status the agent chose in their CCP)	Initial	Outbound contact
Agent missed a phone call due to timer expired	Missed call	Missed contact
Agent is interacting with customer on phone call (regardless of what status the agent chose in their CCP)	Busy	Connected
Agent puts customer on hold while on phone call (regardless of what status the agent chose in their CCP)	OnHold	On hold
After agent hangs up call	After call work	After contact work
Agent is on Lunch (a custom status)	-	-
Supervisor's contact state if they are monitoring an agent	Monitoring	Monitoring

Flows

Added the following flow blocks:

-
-

Updated the following flow blocks for chat:

-
-

-
-

User Management

- Added that you can use AWS Identity and Access Management (IAM) with Amazon Connect. For more information, see [Identity and access management for Amazon Connect](#).

Live Media Streaming

- Added that you can capture customer audio for the entire interaction with your contact center. For more information, see [Set up live media streaming of customer audio](#).

API

- Added [StartChatContact](#), [ListTagsForResource](#), [TagResource](#), [UntagResource](#) to the Amazon Connect Service API.
- Added the [Amazon Connect Participant Service](#) API. These APIs are used chat participants, such as agents and customers.

Contact Control Panel (CCP)

- Updated the CCP so it supports chat. For more information, see [Agent training guide for the CCP and agent workspace](#).

October 2019 Update

The following update was released in October 2019:

Metrics

- The real time metric **On call** is now incremented whenever an agent is handling a contact who is connected, on hold, in After Contact Work, or the agent is dialog out to a customer.

This metric is available in the Queues tables and Routing Profile tables on the **Real time metrics** page. It's also returned by the `GetCurrentMetricData` API as `AGENTS_ON_CALL`.

June 2019 Update

The following update was released in June 2019:

Flows

- Added flow versioning so you can choose between a saved or published version when you roll back.

May 2019 Updates

The following updates were released in May 2019:

Metrics and Reporting

- Improved the error messages you might encounter when creating, editing, or deleting a scheduled report.
- In the Historical metrics report UI, changed **Contacts missed** to **Agent non-response**. This metric appears as **Contacts missed** in scheduled reports and exported CSV files.
- In the agent event stream, fixed the formatting of the timestamp millisecond so you can better order and analyze the data. To learn more, see [Amazon Connect agent event streams](#).

Contact Control Panel

- Resolved an issue where calling a destroy action (such as `connection.destroy`) using the [Amazon Connect Streams API](#) resulted in different behavior depending on which leg of the conversation it was called from: the agent or the customer. Now calling a destroy action results in the same behavior for both: a busy conversation is moved to After Call Work (ACW) and a conversation in any other state is cleared. If you used the native Contact Control Panel instead of the Amazon Connect Streams API, you weren't impacted by this issue.

April 2019 Updates

The following updates were released in April 2019:

Contact Control Panel

- Resolved an issue where the hold flow didn't run in this case:

- The agent missed a call and then set themselves back to Available.
- Then they were re-routed the same call.
- The agent put that customer on hold while handling the call.

However, taking the customer off hold worked as expected and no other impact occurred.

- Resolved an issue where the [Amazon Connect Streams API](#) returned `softphoneAutoAccept = FALSE` even though **Auto-Accept Call** was enabled for the agent.

March 2019 Update

The following updates were released in March 2019:

Metrics and Reporting

- Improved the error messages you might encounter when running real-time metrics reports. For example, if you manually configure a real-time metrics report to contain more than 100 queues, we'll display this message: "You've hit the maximum limit of 100 queues. Please reconfigure your report to contain no more than 100 queues." To learn more, see [No metrics or too few rows in a queues report?](#)

Contact Control Panel

- Resolved an issue where, in rare cases, an agent already handling an outbound call could have been incorrectly presented with an additional queued callback, even though they are only allowed to handle one contact at a time. Since that agent would have been on contact and not idle, the agent wouldn't have been able to accept the queued callback.

In these cases, the outbound call was not impacted; the agent wouldn't have noticed any differences in the CCP. The callback was presented to another agent instead of being dropped.

February 2019 Updates

The following updates were released in February 2019:

Updates by category

- [Contact Routing](#)

- [Flows](#)
- [Metrics and Reporting](#)
- [Contact Control Panel \(CCP\)](#)

Contact Routing

- Resolved an issue where in rare cases some contacts were not routed to the agent that was available for the longest time.
- Resolved an issue in the user interface where the value displayed for **No. of agents staffed** for the **Basic Routing Profile** on the **Routing Profiles** page was incorrect. The correct number of agents for the routing profile was displayed on the **User Management** page.

Flows

- Resolved an issue with the flow editor when adding intents in Chrome.
- Resolved an issue where routing priority and age for queued callbacks were not saved.
- Resolved an issue where contact attributes for an outbound whisper flow were not saved.

Metrics and Reporting

- Added **EnqueueTimestamp**, **Duration**, and **DequeueTimestamp** to the contact record for callback contacts.
- Resolved an issue where **InitiationTimestamp** for callback contacts did not match the time that the callback was created.
- Resolved an issue where users were given an incorrect message when they did not have permissions to edit a report.

Contact Control Panel (CCP)

- Resolved an issue where callbacks were not ringing in the CCP.

January 2019 Updates

The following updates were released in January 2019:

Updates by category

- [Contact Routing](#)
- [Flows](#)
- [Metrics and Reporting](#)

Contact Routing

- Resolved an issue where in rare cases agent transfers were failing.

Flows

- Resolved an issue where agent transfers were failing.
- Resolved an issue that resulted in periodic delays in publishing flow logs.

Metrics and Reporting

- Resolved an issue in real-time metrics reports where the page showed the wrong calculation for **Avg queue answer time**.
- Resolved an issue where some events were missing from an agent event stream.

December 2018 Updates

The following updates were released in December 2018:

Updates by category

- [Metrics and Reporting](#)
- [Contact Control Panel \(CCP\)](#)

Metrics and Reporting

- Resolved an issue where agent event streams were missing agent snapshots during login and logout events.
- Resolved an issue where the contact record detail page displayed timestamps using the timezone selected on the search page.

- Resolved an issue where the AfterContactWork status was overridden.
- Resolved an issue where the timestamps are incorrect if an agent accidentally disconnects while placing a customer on hold.

Contact Control Panel (CCP)

- Resolved an intermittent issue with initialization when an agent configuration is corrupted or null.
- Resolved an issue where pressing Enter to transfer a call did not work.

November 2018 Updates

The following updates were released in November 2018:

Updates by category

- [General](#)
- [Flows](#)
- [Metrics and Reporting](#)

General

- Resolved an issue with auditing.
- Resolved an issue that sometimes resulted in agents being placed in a default state when a contact disconnected when attempting to connect to an agent.
- Resolved an issue that sometimes resulted in newly created agents not being able to log in correctly if the log in attempt occurred immediately after user account was created.

Flows

- Added the new Loop block, which lets you loop through segments of a flow, such as requesting customer information additional times if valid data is not entered.

Metrics and Reporting

- Resolved an issue where callbacks handled were included in the count for incoming contacts in historical reports, but not counted in scheduled reports. Callbacks handled are no longer included in the count for Incoming contacts handled in historical reports.
- Improved performance of report generation for reports with a large number of queues and agents in an instance.
- Resolved an issue with how ACW was reported, and backfilled data in customer instances to correct the ACW data for September, October, and November.

October 2018 Updates

The following updates were released in October 2018:

Updates by category

- [General](#)
- [Metrics and Reporting](#)
- [API](#)

General

- Resolved an issue that sometimes resulted in stuck media sessions.

Metrics and Reporting

- Resolved an issue that sometimes resulted in agent names not being displayed correctly in historical reports.
- Resolved an issue that sometimes resulted in the data related to agent Auxiliary states were incorrectly overwritten.

API

- Resolved an issue where the `GetCurrentMetrics` operation returned the metric `OLDEST_CONTACT_AGE` in milliseconds instead of seconds.

September 2018 Updates

The following updates were released in September 2018:

Updates by category

- [General](#)
- [API](#)

General

- Improved page loading times for the **User management** page.
- Resolved an issue that sometimes caused issues loading the **Queues** page when there were a large number of quick connects associated with a queue.

API

- Released the [UpdateContactAttributes](#) operation for the Amazon Connect API.

August 2018 Updates

The following updates were released in August 2018:

Updates by category

- [General](#)
- [Contact Routing](#)
- [Metrics and Reporting](#)

General

- Added a restriction of 64 characters for the password length for the administrator account created during instance creation.
- Resolved an issue where the **Hours of operation** page would not load when no days were selected for a saved Hours of operation configuration.

Contact Routing

- Increased the timeout for whispers to 2 minutes for outbound and queued callbacks so that agents have longer to prepare for the incoming call.

Metrics and Reporting

- Modified how the value for the Contacts abandoned metric so that calls that transfer to callbacks are not counted as abandoned contacts.

July 2018 Updates

The following updates were released in July 2018:

Updates by category

- [New Features](#)
- [General](#)
- [Metrics and Reporting](#)
- [Flows](#)

New Features

- [Outbound caller ID number](#)
- [Add an Amazon Lex bot to Amazon Connect](#)
- [User Management APIs](#)
- [Manage contacts in a queue](#)

General

- Added an error message when attempting to create an admin user during instance creation using "Administrator" as the user name. The user name Administrator is reserved for internal use, and cannot be used to create a user account in Amazon Connect.
- Added support for directory user names that include consecutive dashes.

- Added pagination when displaying security profiles in your instance so that more than 25 security profiles can be displayed.
- Performance optimizations to reduce latency when using the `StartOutboundVoiceContact` API.

Metrics and Reporting

- Resolved an issue in real-time metrics reports where applied filters were not displayed in the settings page when an additional filter was applied. The settings page now displays the applied filters correctly.

Flows

- Added drop-down menus for contact attributes to make it easier to reference attributes in a flow.

June 2018 Updates

The following updates were released in June 2018:

Updates by category

- [General](#)
- [Telephony and Voice](#)
- [Flows](#)
- [Metrics and Reporting](#)
- [Contact Control Panel \(CCP\)](#)

General

- Changed the font in the UI to Amazon Ember for better readability.

Telephony and Voice

- Introduced support for using Amazon Lex bots with Amazon Connect in the US West (Oregon) Region.

- Fixed a bug that in some cases caused a call to drop when a Loop prompt occurred at the same as a call connecting to an agent.

Flows

- Renamed the **Set queue** block to **Set working queue**.
- Added a **Copy to clipboard** button next to the ARN of a flow so you can easily copy the ARN. Choose **Show additional flow information** under the name of the flow in the designer to display the ARN.
- Added a new **Call phone number** block, which lets you choose the phone number from your instance to display as the caller ID in an outbound whisper flow. For more information, see [Outbound caller ID number](#).
- Released contact attributes for system metrics, including a new **Get metrics** block in flows. For more information, see [Route based on number of contacts in a queue](#).

Metrics and Reporting

- Fixed an issue that caused incorrect rendering of the search field in the filters settings for some historical metrics reports.
- Fixed an issue in downloaded reports where the phone number would be blank instead of listing the phone number for calls that were callbacks.
- Login/Logout reports now support 20,000 rows per report generation, up from 10,000.

Contact Control Panel (CCP)

- Added a mute button to the CCP and a mute function to the Streams API so agents can mute and unmute active calls.

April and May 2018 Updates

The following updates were released in April and May 2018:

Updates by category

- [General](#)
- [Telephony and Voice](#)

- [Flows](#)
- [Metrics and Reporting](#)
- [Contact Control Panel \(CCP\)](#)

General

- New [Amazon Polly voices](#) are now automatically made available in Amazon Connect as soon as they are launched. You can use new voices, such as Matthew and Léa, in your flows.
- Updated password enforcement for Amazon Connect user accounts to match requirements for the Amazon Connect admin account created during instance creation.
- Resolved an issue that sometimes resulted in the email addresses not being saved when updating an existing user account.

Telephony and Voice

- Service optimizations to reduce latency and improve caller ID for Japanese telephony.
- Customers can now place calls to Jersey and Guernsey in the Channel Islands.
- Added support for keypad numeric input to an Amazon Lex bots when used in an Amazon Connect contact flow. For more information, see [Amazon Connect Now Supports Keypad Input with an Amazon Lex Chatbot](#).
- Reduced latency for the contact control panel, improving the agent user experience.

Flows

- Resolved an issue with publishing a flow in the case where an **AWS Lambda function block** is used in a flow, and the input type for a parameter was changed from **Send attribute** with a **System** attribute is changed to **Send text**. These flows now publish successfully.
- Agent and customer whispers are now maintained with queued callbacks.
- Attributes now correctly persist with queue callbacks.
- Contact attributes are now maintained when using a **Loop prompt** block in a queue flow.

Metrics and Reporting

- Data for scheduled reports is now delayed by 15 minutes to allow for most recent data to be incorporated in to reports. Previously, in some cases, report data for the final 15 minute period during the scheduled report interval did not get included in scheduled reports. This applies to all report types.
- In metric calculations, the time that an incoming call rings is attributed to idle time if the agent is in idle state before an incoming call.
- The metric **Agent on contact time** now includes time that an agent spent in an auxiliary busy state.
- Published new documentation about metrics.

Contact Control Panel (CCP)

- Added a **Save** button to the settings menu for the CCP when an agent is using a desk phone. The **Save** button saves the deskphone configuration between sessions.
- Agent username is now available as part of agent configuration data in the [Amazon Connect Streams API](#).
- Contact attributes are now available when using the streams.js (Streams API) for screenpops after queued callbacks.
- Fixed issue where for some auto-accept calls, the agent continued to hear ringing after accepting and joining the call.

Upcoming changes to the Contact Control Panel (CCP)

We are releasing an update to the look and feel of the Contact Control Panel (CCP). This update is designed to make the application more intuitive and responsive for your agents.

Note

The layout and functionality of the CCP is not changing as part of this visual refresh. For examples of what the updated CCP looks like, see [Before and after examples of the visual refresh](#).

If you have any questions about the upcoming visual refresh, contact AWS Support or your Technical Account Manager.

Depending on how you access the CCP, you may already be able to preview the changes or start using the updated user interface. The update has been released to customers who use the following:

- CCP-V2, that is, your URL ends with `/ccp-v2`
- The pre-built CCP embedded by using the Amazon Connect Streams API
- The Amazon Connect Salesforce CTI Adapter

You do not need take any action to opt-in unless you want to preview the changes before they are automatically released to you.

How to preview the updated CCP

Complete the following steps to preview the updated CCP for your use case.

If you use the Amazon Connect Streams API

Note

You must use [Amazon Connect Streams version 2.14.3](#) or later version to preview the visual refresh of the CCP. Upgrading your Amazon Connect Streams version is **not required** to automatically receive the updated CCP at a later date.

If you embed the pre-built CCP by using the Amazon Connect Streams API, complete the following steps to use the updated CCP user interface in your Amazon Connect instance:

- Update the `ccpUrl` in your [initCCP](#) call to include `"?visual-refresh=true"`. For example:

```
connect.core.initCCP(containerDiv, {
  ccpUrl: "example-instance.my.connect.aws/ccp-v2/?visual-refresh=true",
  ...
});
```

- Or, if you are using [initApp](#) to initialize the CCP as an agent app, you can update your code as follows:

```
connect.agentApp.initApp(
  "ccp",
```



```
"ccp-container",
connectUrl + "/ccp-v2?visual-refresh=true",
...
);
```

- It is easy to add `if` or other conditional logic for additional flexibility. For example, if you want to enable the updated user interface on only your developer Amazon Connect instance for now, you can use the following logic:

```
let ccpUrl = connectUrl + "/ccp-v2/";
if (isDevInstance(connectUrl)) {
  ccpUrl += "?visual-refresh=true";
}

connect.core.initCCP(containerDiv, {
  ccpUrl
  ...
});
```

The following image shows an example of how the updated CCP user interface will look when embedded into a custom agent application.

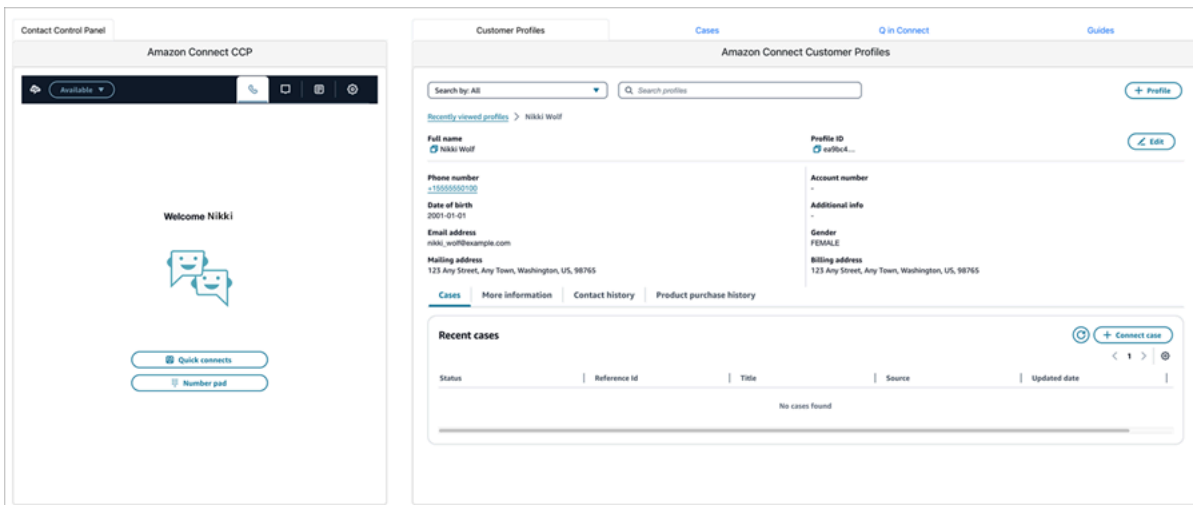

If you use the standalone CCP-V2

If you are using CCP-V2 as a [standalone agent application](#), you can preview the updated CCP user interface by changing the URL in your browser:

From:

- <https://instancename.my.connect.aws/ccp-v2/>

To:

- <https://instancename.my.connect.aws/ccp-v2?visual-refresh=true>

When you refresh or navigate away from the page, Amazon Connect reverts the user interface back to the previous look and feel.

Before and after examples of the visual refresh

The images in this section show you how the current CCP user interface compares with the upcoming CCP. The updated CCP user interface features stronger color contrast, updated visual style of buttons, updated iconography, and more responsive and visually consistent elements across interfaces.

Before visual refresh: Default state

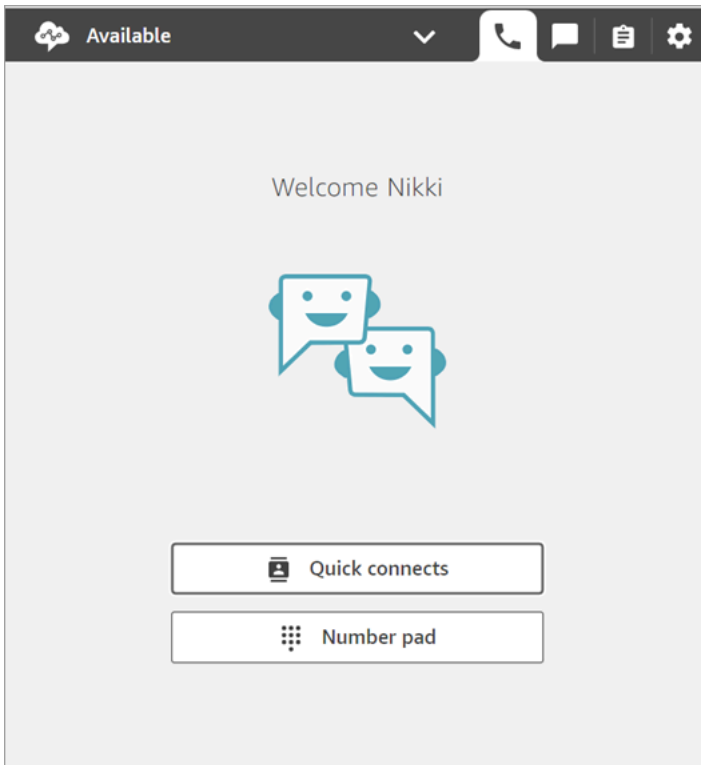

After visual refresh: Default state

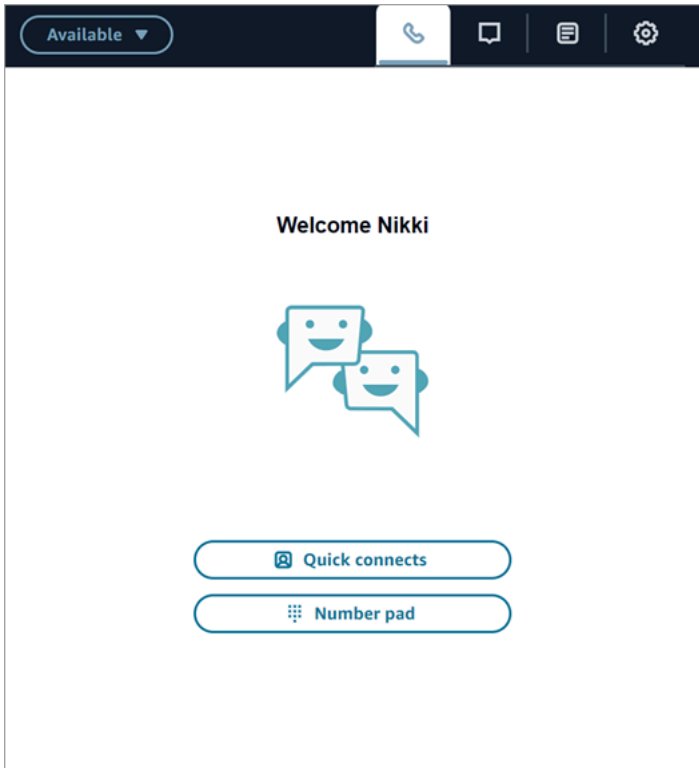

Before visual refresh: Incoming contact

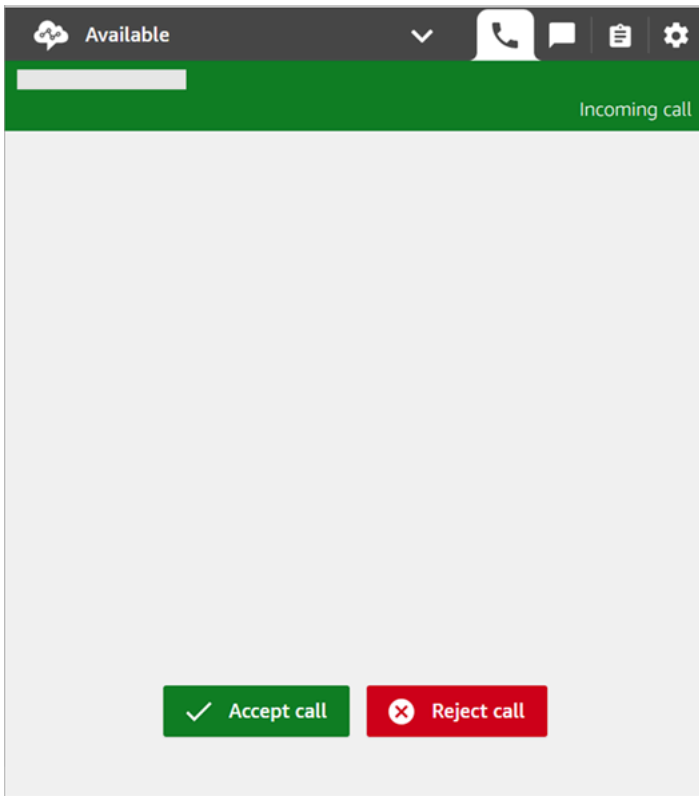

After visual refresh: Incoming contact

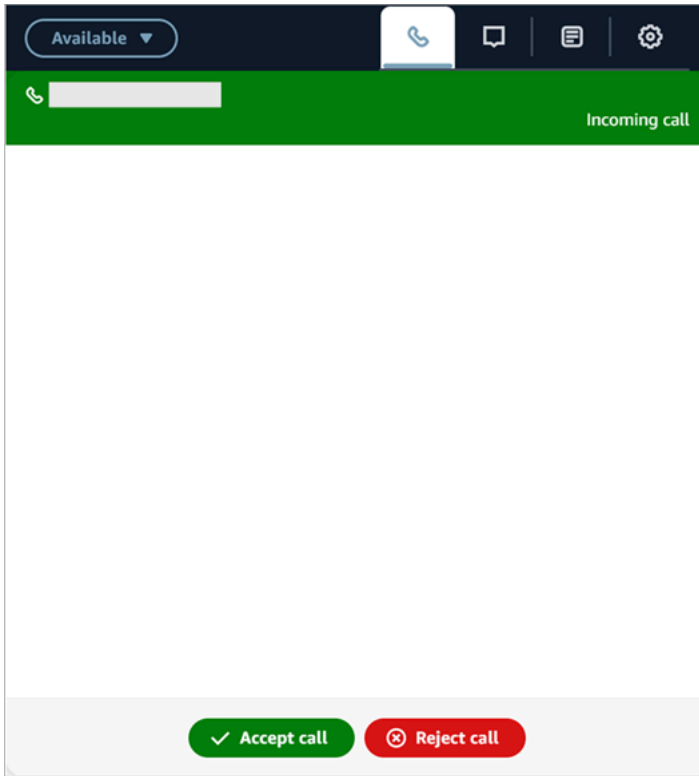

Before visual refresh: Ongoing call

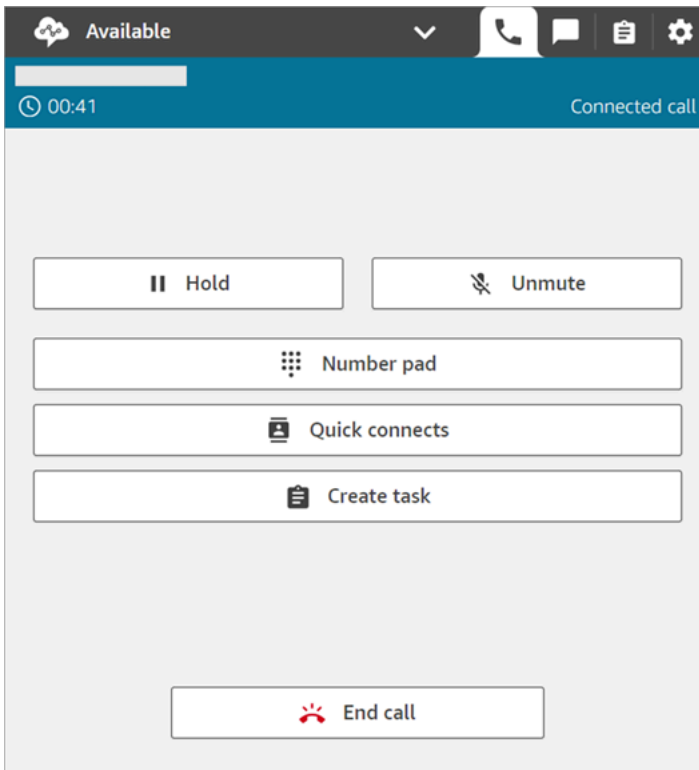

After visual refresh: Ongoing call

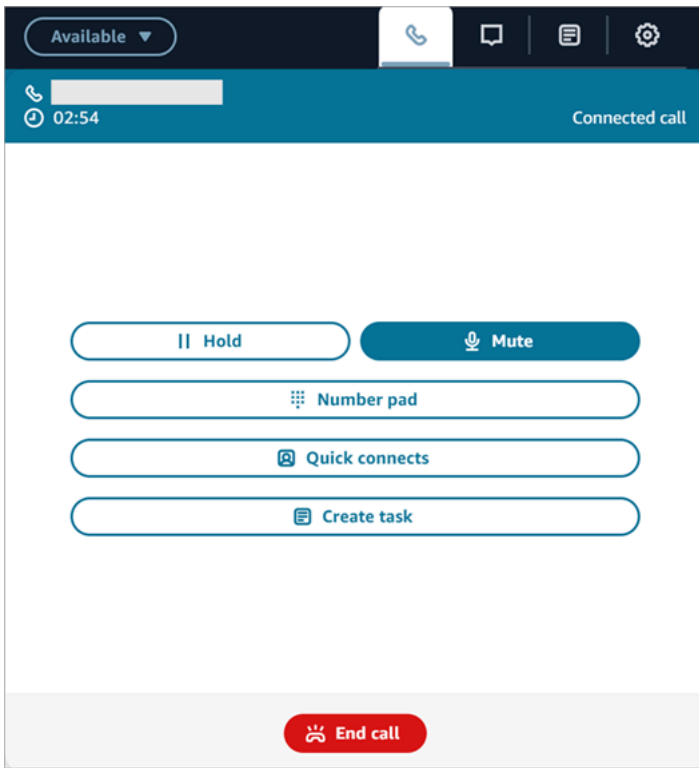

Before visual refresh: After contact work

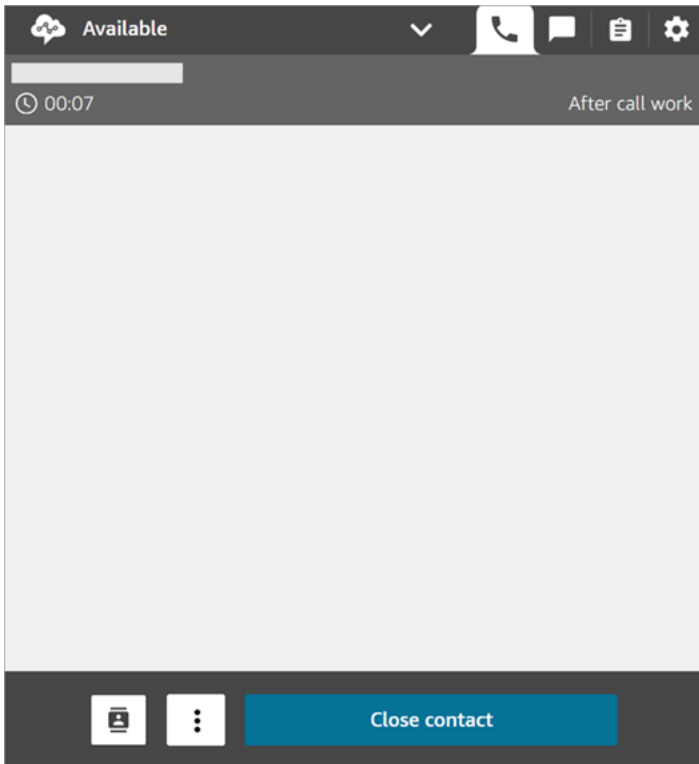

After visual refresh: After contact work

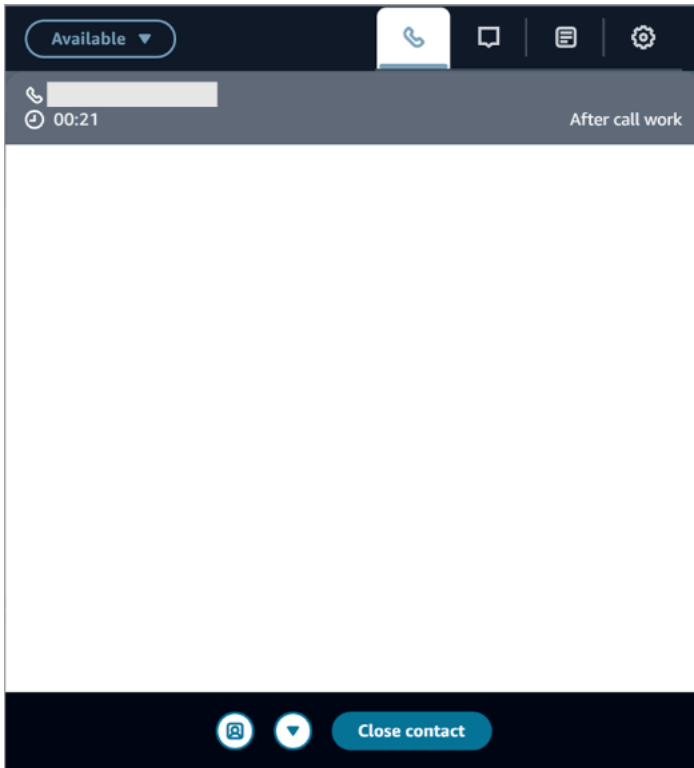

Before visual refresh: Number pad

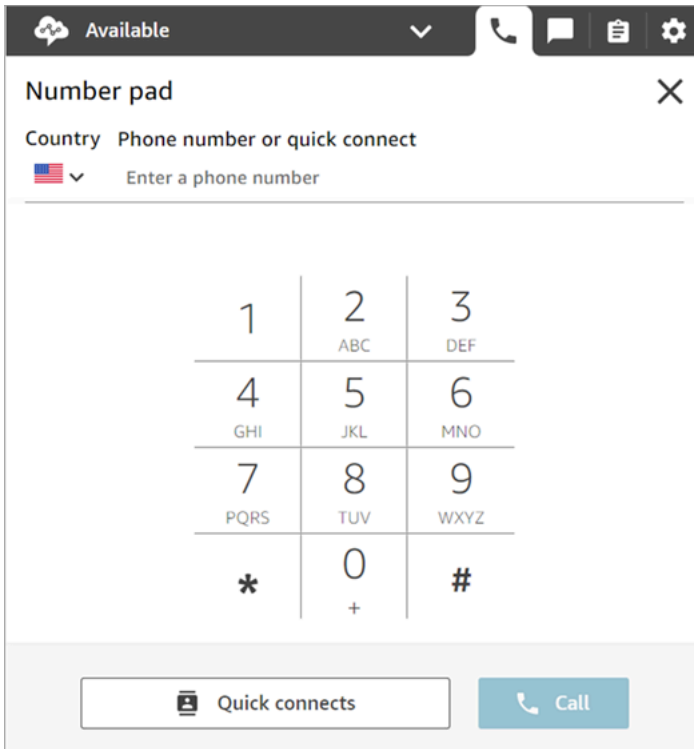

After visual refresh: Number pad

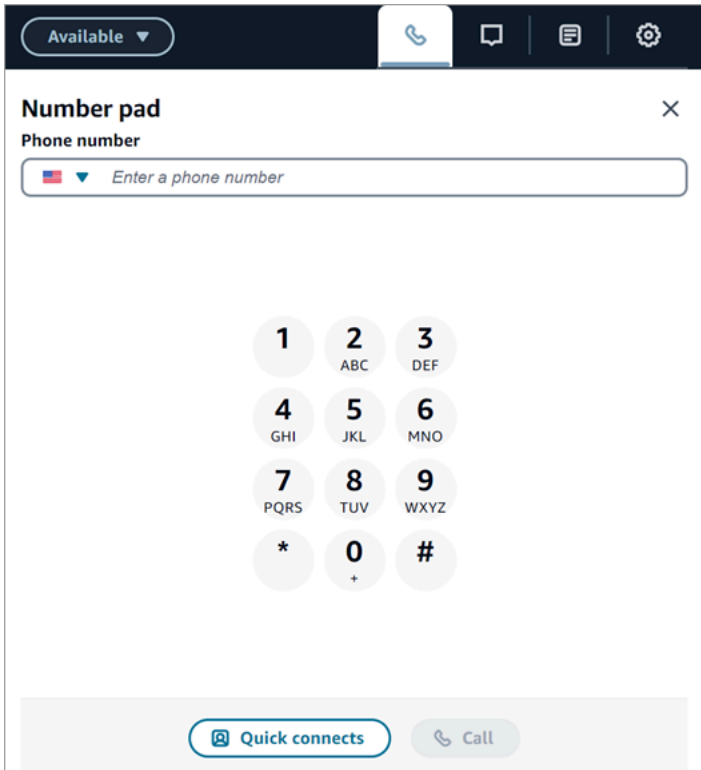

Before visual refresh: Ongoing chat

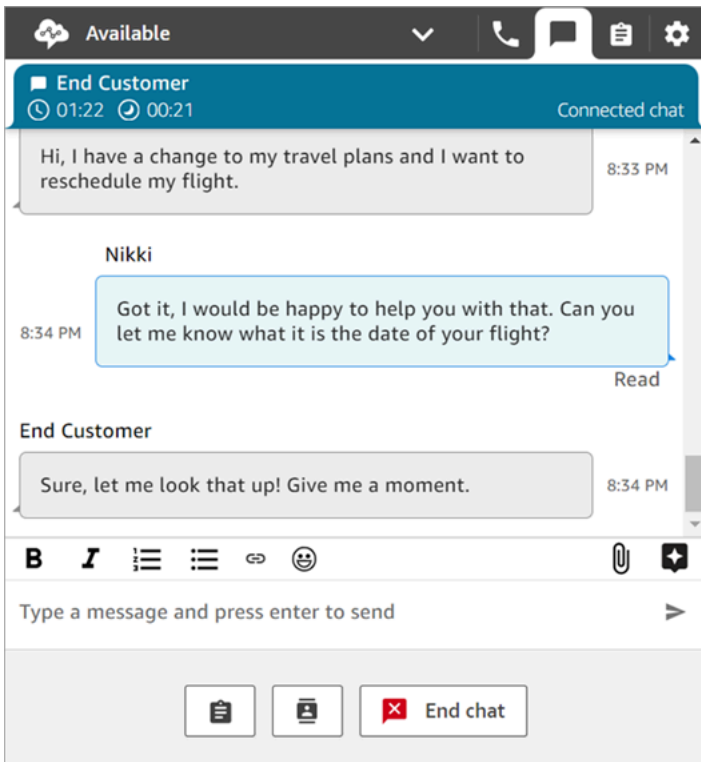

After visual refresh: Ongoing chat

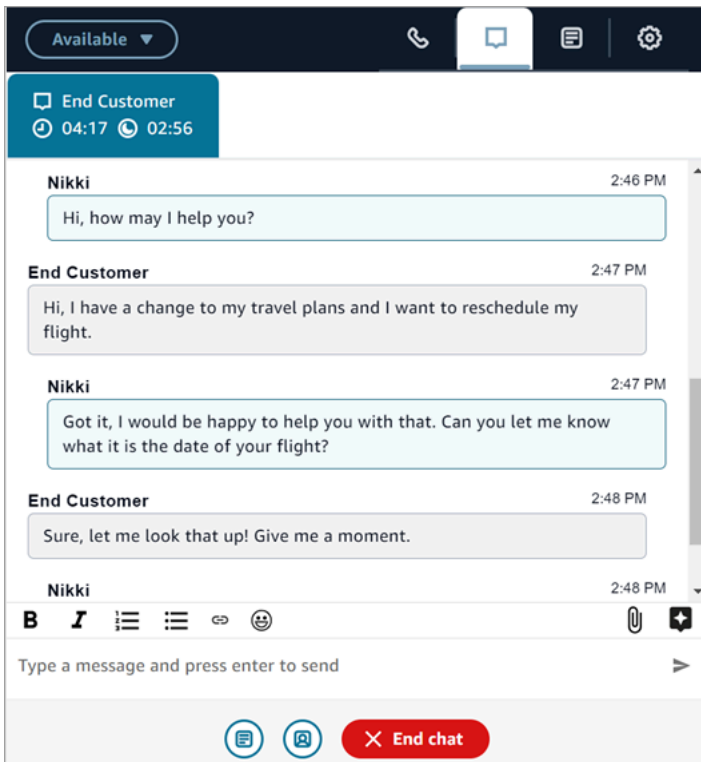

After visual refresh: Salesforce adapter, default state

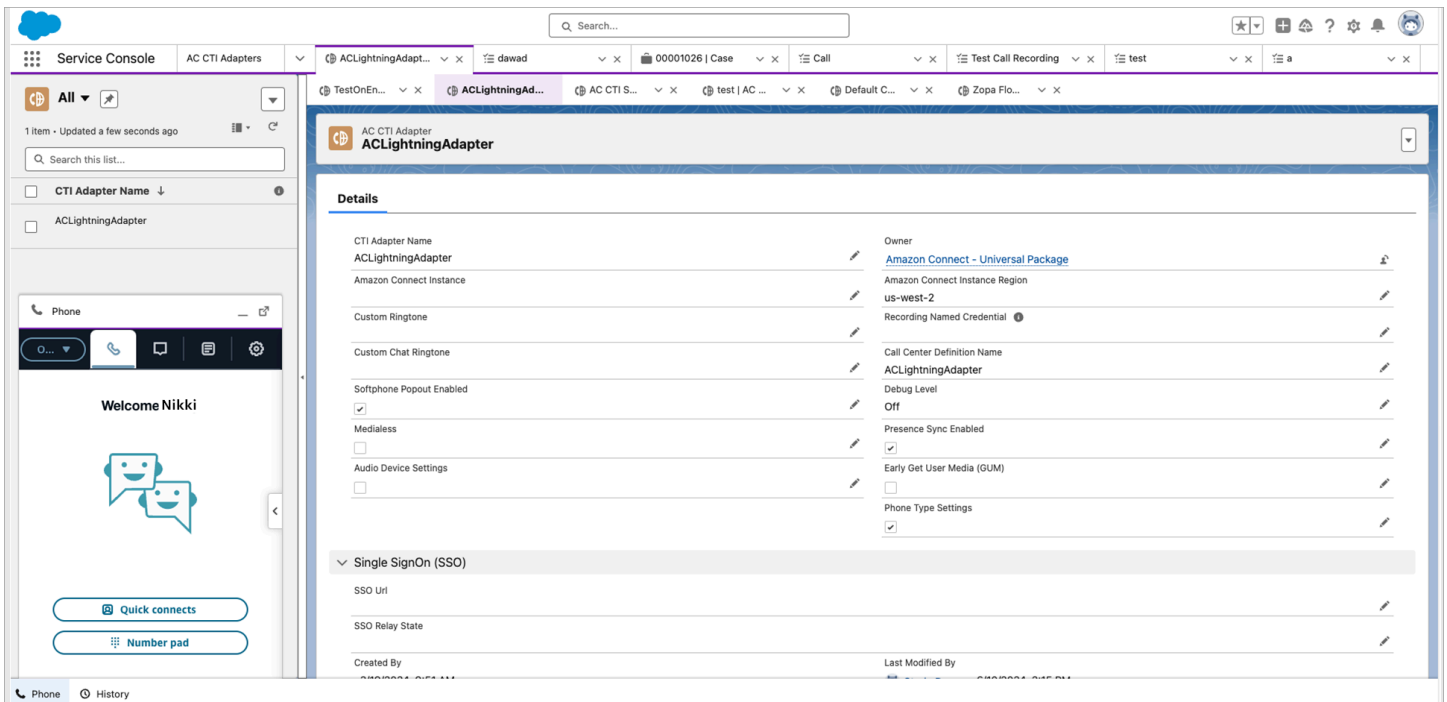

After visual refresh: Salesforce adapter, ongoing call

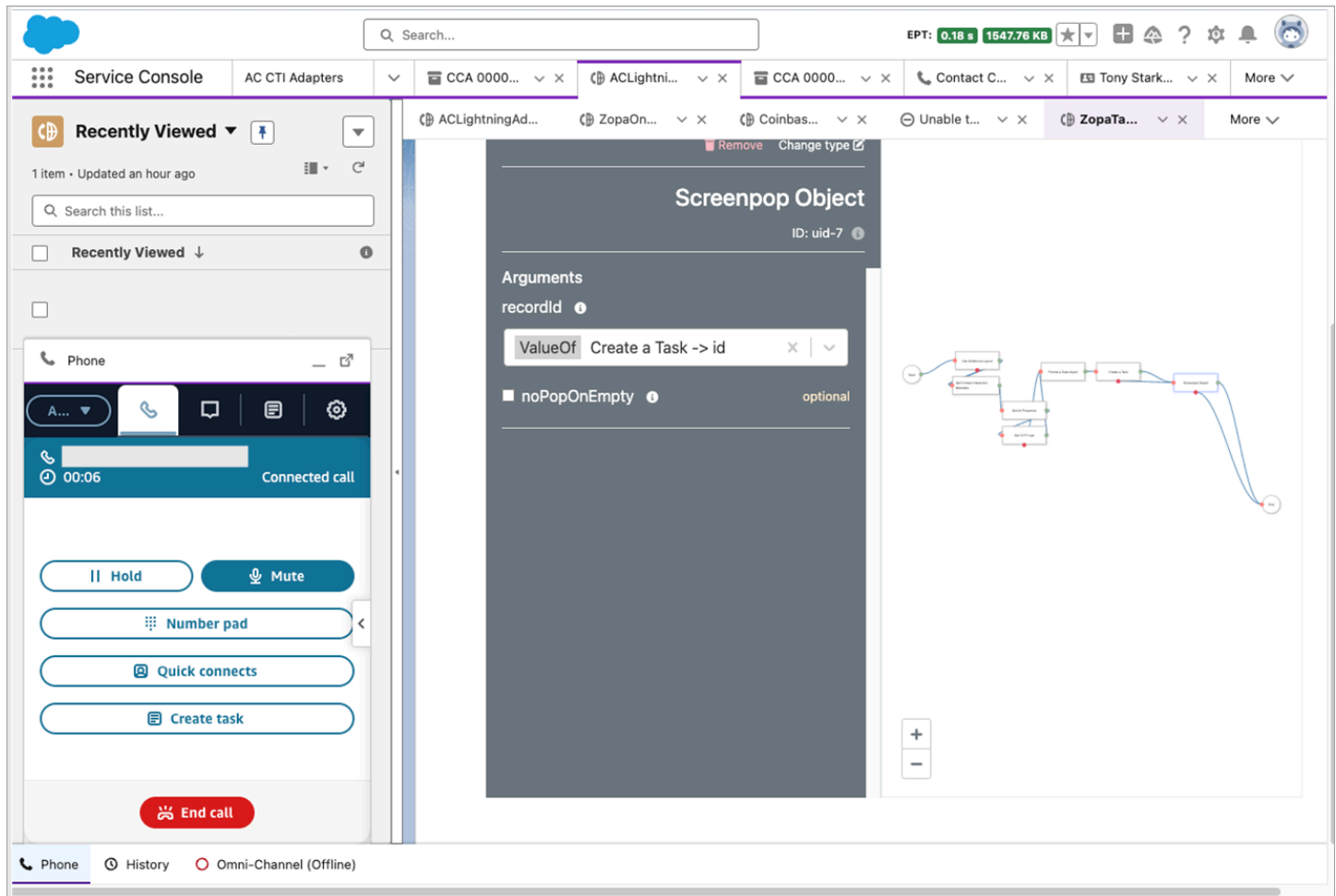

CCP on the Agent Workspace

If you use the CCP with the Amazon Connect Agent Workspace, the visual refresh is available in all [AWS Regions where the agent workspace is available](#). For more information about the visual refresh, see [Customize the Amazon Connect Agent Workspace](#) and the related What's New announcement published on June 4, 2024: [Amazon Connect agent workspace launches refreshed look and feel](#).

The following image shows the updated CCP on the agent workspace.

The screenshot displays the Amazon Connect agent interface. On the left, a sidebar lists agents: Maria Garcia (00:39), Sofia Martínez (00:53), Mary Major (00:42), Adjust Ricard Smith's p... (06:45), and Nikki Wolf (01:33). The main workspace shows a call with Maria Garcia, including a customer profile table, a list of call history items (e.g., 'Review transaction history', 'Temporary block debit card ending in ...8537'), and a 'Call back via Mobile App' notification. The right-hand panel features a search bar and a 'Suggestions' section with a response to a customer query: 'Yes, I think it's fraud'. The response includes an apology and a solution: 'This is how you can Lock and Unlock a customer credit card: 1. Go to the service system, 2. Choose "Manage Debit Card Settings", 3. Lock the card'.

Amazon Connect Document history

The following table describes important changes in each release of the Amazon Connect Administrator Guide. For notification about updates to this documentation, subscribe to the RSS feed.

Change	Description	Date
Route contact within a queue to a specific agent	You can now offer a contact in a queue to a specific agent or set of agents based on user ID; if the agent is not available within a given period of time, you can expire off the routing criteria to instead offer the contact to any available agent in queue.	June 28, 2024

	<p>For more information, see Routing using agent proficiencies.</p>	
Amazon Connect outbound campaigns performance dashboard	<p>You can use the outbound campaigns performance dashboard to understand the performance of your outbound campaigns across voice contacts. For more information, see Outbound campaigns performance dashboard.</p>	June 28, 2024
Amazon Q in Connect recommends step-by-step guides	<p>Amazon Q in Connect, a generative-AI powered assistant for contact center agents, recommends step-by-step guides in real-time . Agents use step-by-step guides to quickly take action to resolve customer issues. For more information, see Integrate Amazon Q in Connect with step-by-step guides. In addition, see the following new APIs that are part of this release: CreateContentAssociation, DeleteContentAssociation, GetContentAssociation, ListContentAssociations</p>	June 27, 2024

[Updated AmazonConnectReadOnlyAccess managed policy](#)

Updated the managed policy due to the renaming of the Amazon Connect action `connect:GetFederationTokenTokens` to `connect:AdminGetEmergencyAccessToken`. This change is backwards compatible and the use of either action name will continue to work in your policies. For more information, see [Amazon Connect updates to AWS managed policies](#).

June 15, 2024

[Updated look and feel for the Amazon Connect agent workspace](#)

you can also easily build and embed third-party applications that have a consistent look and feel with the agent workspace by using Cloudscape Design System components. For more information, see [Access third-party applications in the agent workspace](#).

June 3, 2024

[Set the forecast time zone](#)

You can generate, view, and download forecasts in the time zone where your business operates. Amazon Connect automatically adjusts forecasts to account for daylight saving changes. For example, if your contact center receives contacts from 8AM-8PM US Eastern time, then forecasts will automatically switch from 8AM-8PM Eastern Daylight Time (EDT) to 8AM-8PM Eastern Standard Time (EST) on November 3, 2024. Time zone support in forecasts simplifies the day-to-day experience for managers. For more information, see [Set the forecast time zone](#).

May 29, 2024

[Updated AmazonConnectServiceLinkedRolePolicy service-linked role managed policy](#)

Updated the service-linked role managed policy with Amazon Cognito user pools permissions to use select read operations and Amazon Connect Customer Profiles permissions to put data into Customer Profiles . For a description of the additional actions, see [Amazon Connect updates to AWS managed policies](#).

May 23, 2024

[Updated AmazonConnectServiceLinkedRolePolicy service-linked role managed policy](#)

Updated the service-linked role managed policy with the Amazon Q in Connect API action `ListContentAssociations`. For a description of the additional action, see [Amazon Connect updates to AWS managed policies](#).

May 20, 2024

[New flow and flow module analytics](#)

Added the following historical metrics for flows and flow modules: Average flow time, Flows started, Flows outcome, Flows outcome percentage, Maximum flow time, and Minimum flow time. For a description of each metric, see [Historical metrics definitions](#). Added the flows dashboard. Added the ability to create a rule when a flow or flow module breaches a rule you define.

May 15, 2024

[New metrics available on the Historical metrics page](#)

May 2, 2024

The following metrics are available on the **Historical metrics** page in the Amazon Connect admin website: Abandonment rate, Agent non-response without customer abandons, Average contact duration, Average conversation duration, Average customer hold time all contacts, Average agent greeting time, Average agent interruptions, Average holds, Average agent interruption time, Average non-talk time, Average resolution time, Average talk time, Average agent talk time, Average customer talk time, Agent talk time percent, Customer talk time percent, Talk time percent, Non-talk time percent, Contacts handled (connected to agent timestamp), Contacts queued (enqueue timestamp), Callback attempts, Contacts abandoned in X, Contacts answered in X, Contacts resolved in X. For a description of each metric, see [Historical metrics definitions](#).

[Voice contacts rejected by an agent have a state of REJECTED](#)

Voice contacts rejected by an agent used to have a state of ERROR for Contact State in the Agent Event Stream. Now they have a state of REJECTED, which is the same as chat and task contacts. This is also reflected on Real-time metrics for the agent.

April 2, 2024

[Combined Amazon Connect API reference guides](#)

Combined all the API reference guides for Amazon Connect services (for example, Amazon Q in Connect, Cases, Outbound Campaigns, Voice ID) into the main Amazon Connect API reference guide. Published redirects so existing bookmarks continue to work. See the [Amazon Connect API Reference](#).

March 27, 2024

[GA for generative AI-powered post-contact summaries](#)

Released generative AI-powered post-contact summaries for general availability. This feature summarizes long customer conversations into succinct, coherent, and context rich contact summaries. For example, a summary might say "The customer didn't receive a reimbursement for a last minute flight cancellation and the agent didn't offer a partial reimbursement as per the SOP." For more information, see [View generative AI-powered post-contact summaries](#).

March 25, 2024

[Historical metrics for case management](#)

Amazon Connect Cases provides the following metrics for case management: [Average case resolution time](#), [Average contacts per case](#), [Cases created](#), [Cases reopened](#), [Cases resolved](#), [Cases resolved on first contact](#), [Current cases](#).

February 29, 2024

[Added topic on best practices for outbound campaigns](#)

For more information, see [Best practices for Amazon Connect outbound campaigns](#).

February 19, 2024

[Amazon Connect Cases provides audit history on cases](#)

For information on how to enable the feature for your users, see [Assign permissions](#). Also, see [GetCaseAuditEvents](#) in the *Amazon Connect API Reference*.

February 2, 2024

[Added topic on managing chat across Regions](#)

For more information, see [Manage chat across Regions](#).

February 2, 2024

[Added topic on opt out of using your data for service improvement](#)

Learn which Amazon Connect services use your customer's content that you provide to train models and continuously improve your experience, and how to opt out if desired. For more information, see [Opt out of using your data for service improvement](#).

January 19, 2024

[Added topic on best practices for using PutDialRequestBatch for outbound campaign calling](#)

For more information, see [Best practices for using PutDialRequestBatch for outbound campaign calling](#).

January 19, 2024

[GA for Amazon Connect outbound campaigns voice dialing API](#)

Released the [PutDialRequestBatch](#) for general availability. This API enables you to use your own list management capability to set up the contact strategy (for example, campaign start and end times, do-not-call times, maximum contact attempts) while programmatically using Amazon Connect predictive dialer with machine learning (ML)-powered answering machine detection. This helps increase live-party connections.

January 12, 2024

[Barge for chat: Managers can join ongoing chats between agents and customers](#)

Managers can join and participate in ongoing chats between agents and customers, ensuring that even the most complex customer issues are resolved quickly and accurately. For more information, see [Barge live voice and chat conversations](#) . Also see updates to the [MonitorContact](#) and [SendEvent](#) APIs.

January 12, 2024

[High-quality voice experiences for agents using Citrix Virtual Desktop Infrastructure \(VDI\) environments.](#)

Your agents can leverage the Citrix remote desktop application to offload audio processing to their local device and to automatically redirect audio to Amazon Connect. For more information, see [Citrix VDI with Amazon Connect audio optimization](#).

January 10, 2024

[GetRecommendations and QueryAssistant APIs will be discontinued starting June 1, 2024](#)

Two Amazon Q in Connect APIs—[GetRecommendations](#) and [QueryAssistant](#)—will be discontinued starting June 1, 2024. To receive generative responses after March 1, 2024, you will need to create a new Assistant in the Amazon Connect console and integrate the Amazon Q in Connect JavaScript library (amazon-q-connectjs) into your applications.

January 10, 2024

[Granular access controls using resource tags for historical metrics reports](#)

You can apply granular permissions to resource metrics that are included in historical metrics reports. For more information, see [Apply tag-based access control to historical metrics reports](#).

January 3, 2024

[Pause and resume tasks](#)

You can pause and resume all tasks that aren't expired, disconnected, or scheduled for a later time. This enables agents to free up an active slot so they can receive more critical tasks when their current task is stalled, for example, because of a missing approval or waiting on an external input. For more information, see [Concepts: Pause and resume tasks](#). Also see the [PauseContact](#) and [ResumeContact](#) APIs.

December 15, 2023

[More granular billing reports](#)

Apply contact tags to obtain more detailed billing reports in AWS Cost Explorer and AWS Cost & Usage Reports. For more information, see [Set up granular billing for a detailed view of your Amazon Connect usage](#). Also see [TagContact](#) and [UntagContact](#) in the *Amazon Connect API Reference*.

December 15, 2023

[New metrics: Contacts Answered/Abandoned in X](#)

On the **Real-time metrics** page, you can define custom thresholds for [Contacts abandoned in X](#) and [Contacts answered in X](#), where X is a time range that you specify.

December 4, 2023

[Updated AmazonConnectServiceLinkedRolePolicy service-linked role managed policy](#)

Updated the service-linked role managed policy to use Amazon Pinpoint phone numbers to allow Amazon Connect to send SMS. For a description of the additional actions, see [Amazon Connect updates to AWS managed policies](#).

November 28, 2023

[No-code UI builder for step-by-step guides](#)

This feature allows you to create and manage the UI pages shown to agents in step-by-step guides. Using a drag-and-drop interface you are able to define static and dynamic content for the agent's UI. This includes layouts, styles, and dynamic data, which enables you to control the look and feel of your agent's experience. With this capability, you are able to define what gets displayed in your agent's UI during the step-by-step guided experience. For more information, see the [No-code UI builder](#) documentation.

November 28, 2023

[Customer Profiles provides a generative AI powered customer data mapping capability](#)

Customer Profiles provides a generative AI powered customer data mapping capability that significantly reduces the time needed to create unified profiles, which allows you to create more personalized customer experiences more efficiently. For more information, see [Generative AI powered data mapping](#).

November 28, 2023

[Analytics data lake \(Preview\)](#)

You can use Analytics data lake as a central location to query various types of data from Amazon Connect. This data includes contact records and Contact Lens conversational analytics. Data is refreshed around every 24 hours. You can use the Analytics data lake to create custom reports or run SQL queries. For more information, see [Access Analytics data lake](#). For a list of new actions, see the [Analytics data lake actions](#) topic in the *Amazon Connect API Reference*.

November 28, 2023

[Amazon Connect supports two-way SMS](#)

Amazon Connect supports two-way Short Messaging Service (SMS) capabilities, making it easy for you to resolve customer issues by text messaging. SMS offers a ubiquitous and convenient channel for customers to get help, while enabling you to deliver personalized experiences at a lower cost. For more information, see [Set up SMS messaging](#). For a list of new actions, see the [Release notes](#).

November 28, 2023

[Amazon Connect provides in-app, web, and video calling](#)

The Amazon Connect in-app, web, and video calling capabilities enable your customers to contact you without ever leaving your web or mobile application. You can use these capabilities to pass contextual information to Amazon Connect. This enables you to personalize the customer experience based on attributes such as the customer's profile or other information, like actions previously taken within the app. For more information, see [Set up in-app, web, and video calling capabilities](#) and the [StartWebRTCContact](#) action in the *Amazon Connect API Reference*.

November 28, 2023

[Amazon Connect Contact Lens provides real-time conversational analytics for chat](#)

Contact Lens provides real-time conversational analytics for chat, extending the machine learning-powered post-contact analytics (for example, sentiment analysis, automated contact categorization, and more) to real-time contact scenarios. For more information, see [Analyze conversations using conversational analytics](#) and the [ListRealtimeContactAnalysisSegmentsV2](#) action in the *Amazon Connect API Reference*.

November 28, 2023

[Amazon Connect Contact Lens provides generative AI-powered post-contact summaries \(Preview\)](#)

Contact Lens provides generative AI-powered post-contact summaries, enabling contact center managers to more efficiently monitor and help improve contact quality and agent performance. For more information, see [View generative AI-powered post-contact summaries \(Preview\)](#).

November 28, 2023

[Added Amazon Q in Connect](#)

Amazon Q in Connect is a generative AI–customer service assistant. It is an LLM-enhanced evolution of Amazon Connect Wisdom that delivers real-time recommendations to help contact center agents resolve customer issues quickly and accurately. For more information, see [Use Amazon Q in Connect for generative AI–powered agent assistance in real-time](#) and the [Amazon Q in Connect API Reference](#).

November 28, 2023

[Create quick responses](#)

Quick responses provide pre-written answers to common customer inquiries during a chat conversation. The responses can save time and reduce customer frustration. For more information, see [Create quick responses for use with chat contacts](#) and [Search for quick responses in CCP](#).

November 17, 2023

[View and manage applied service quotas for Amazon Connect using AWS Service Quotas](#)

Service Quotas allows you to view both default and applied quota values for resources used by each of your Amazon Connect instances. When requesting a quota increase, Service Quotas allows you to indicate both the Amazon Connect quota and desired value. For quotas that support resource level adjustability you can also specify your Amazon Connect instance. For more information, see [Amazon Connect service quotas](#)

November 16, 2023

[Added an action to AmazonConnectServiceLinkedRolePolicy](#)

Updated AmazonConnectServiceLinkedRolePolicy with an action for Amazon Q in Connect. For a description of the additional action, see [Amazon Connect updates to AWS managed policies](#).

November 15, 2023

[Amazon Connect prompts configuration page provides CloudTrail coverage](#)

The prompts configuration user interface has been updated to make it more efficient for you to manage prompts. In addition, when you add, update or delete a prompt from the Amazon Connect admin website, a record of that activity is available in AWS CloudTrail for visibility, reporting, and compliance. For more information about the new prompts page, see [Create prompts](#).

November 10, 2023

[Amazon Connect enables integration with your preferred file scanning application to detect malware](#)

You can integrate Amazon Connect with your preferred file scanning application to detect malware or other unwanted content in attachments before they can be shared in a chat or uploaded to a case. This capability provides an additional layer of protection for your customers and organization by preventing malicious files from being shared and downloaded. For more information, see [Set up attachment scanning](#).

November 9, 2023

[Updated AmazonConnectCampaignsServiceLinkedRolePolicy service-linked role managed policy](#)

Updated the service-linked role managed policy for outbound campaigns. For a description of the additional actions, see [Amazon Connect updates to AWS managed policies](#).

November 8, 2023

[Amazon ConnectAmazon Connect outbound campaigns voice dialing API](#)

Amazon Connect outbound campaigns supports high-volume voice outreach by using the [BatchPutContact](#) API. You can use your own list management capability to set up the contact strategy (for example, campaign start and end times, do-not-call times, maximum contact attempts), while programmatically using the Amazon Connect predictive dialer with machine learning (ML)-powered answering machine detection. This increases live-party connections and reduces the amount of time agents waste with unanswered calls. You can also track outcomes of all campaign calls using the Amazon Connect contact record.

November 8, 2023

[Amazon Connect Cases supports author name on comments](#)

You can programmatically add and view author comments by using the [CreateRelatedItem](#) and [SearchRelatedItems](#) APIs.

November 8, 2023

[Added new service-linked role policy and service-linked role](#)

Added AmazonConnectSynchronizationServiceRolePolicy service-linked role policy and AWSServiceRoleForAmazonConnectSynchronization service-linked role for managed synchronization. The policy and role provide access to read, create, update, and delete Amazon Connect resources and is used to automatically synchronize AWS resources across AWS regions. For more information, see [AWS managed policy: AmazonConnectSynchronizationServiceLinkedRolePolicy](#) and [Using service-linked roles for Amazon Connect Managed Synchronization](#).

November 3, 2023

[Added Create persistent chat association flow block and new API](#)

You can set up a chat to be persistent either when the chat session is initially created or at any time during the lifetime of the chat. To set up persistent chat after the chat session has started, use the new [CreatePersistentContactAssociation](#) API or include the new [Create persistent contact association](#) block in your flow.

November 3, 2023

[Added configuration management across AWS Regions for Amazon Connect Global Resiliency customers](#)

Amazon Connect Global Resiliency customers can use the [ReplicateInstance](#) API to copy configuration information for resources such as users, routing profiles, queues, and flows across AWS Regions. The API also automatically matches the service quotas for these resources across AWS Regions as part of the replication process. For more information, see [Create a replica of your existing Amazon Connect instance](#). Added the [BatchGetFlowAssociation](#) API. Use this API to obtain a list of flow-associations for the resource identifiers provided in the API request. For example, you can list which phone numbers are associated with which flows in an Amazon Connect instance.

November 2, 2023

[Added Contact Lens conversational analytics metrics in the API](#)

You can analyze aggregate agent and contact performance using Contact Lens conversational analytics metrics in the [GetMetricDataV2](#). The following new metrics were added: **non-talk time percent**, **talk time percent**, **talk time agent percent**, and **talk time customer percent**. For descriptions of these metrics, see [Historical metrics definitions](#).

November 2, 2023

[Added actions to AmazonConnectServiceLinkedRolePolicy](#)

Updated AmazonConnectServiceLinkedRolePolicy with actions for Amazon Connect Customer Profiles. For a description of the additional actions, see [Amazon Connect updates to AWS managed policies](#).

October 30, 2023

[Increased quota for GetProfileObjectType](#)

Changed default limit for GetProfileObjectType from 5 to 10.

October 28, 2023

Third-party applications preview	You can integrate third-party applications into the agent workspace. For more information, see Third-party applications (3p apps) in the agent workspace (Preview) and the Amazon Connect agent workspace third-party developer guide .	October 27, 2023
Added actions to AmazonConnectServiceLinkedRolePolicy	Updated AmazonConnectServiceLinkedRolePolicy with actions for Amazon Connect Wisdom. For a description of the additional actions, see Amazon Connect updates to AWS managed policies .	October 25, 2023
Updated the definition of Contact handle time	Contact handle time includes the time agents spend in an Offline status making outbound calls.	October 23, 2023
Added UpdatePhoneNumberMetadata API	Use the UpdatePhoneNumberMetadata to update the metadata for a phone number, such as the phone number description.	October 23, 2023
Outbound calling restrictions	Added a new topic that explains restrictions that are in place for outbound calling with Amazon Connect: Outbound calling restrictions .	October 16, 2023

[Add as many as four access control tags to a single security profile](#)

Adding additional access control tags will make a given security profile more restrictive. For example, if you add four access control tags like `BPO:AcmeCorp` , `Specialty:Claims` , `Department:Billing` , and `City:NewYork` , the user would only be able to see resources containing all four of these tags. For more information, see [Tag-based access control configuration limitations](#).

October 16, 2023

[Updated default rate limit for GetContactAttribute and UpdateContactAttribute](#)

For new Amazon Connect instances, the default rate limit for `GetContactAttribute` and `UpdateContactAttribute` has been updated. For more information, see [API throttling quotas](#).

October 6, 2023

[Added actions to AmazonConnectServiceLinkedRolePolicy](#)

Updated `AmazonConnectServiceLinkedRolePolicy` with actions for Amazon Connect Customer Profiles. For a description of the additional actions, see [Amazon Connect updates to AWS managed policies](#).

October 6, 2023

[Create and customize up to 15 communications widgets](#)

You can create and customize up to 15 communications widgets per Amazon Connect instance. For more information, see [Add a chat user interface to your website.](#)

October 5, 2023

[Access trailing 90 days of historical agent and contact metrics](#)

You can access the trailing 90 days of historical agent and contact metrics (for example, [Service level](#), [Average handle time](#) by using the [GetMetricDataV2](#) API. You can also make requests spanning up to 35 days with data categorized by customizable time intervals such as 15 minutes, hourly, or weekly. Also added five new metrics to the GetMetricDataV2 API. They are not available in the Amazon Connect admin website. For a list, see the [Release notes.](#)

October 3, 2023

[Amazon Connect Client Application v1.0.2.38 is available](#)

Released Amazon Connect Client Application v1.0.2.38 . This version contains minor fixes and improvements. For more information, see [Amazon Connect Client Application.](#)

September 29, 2023

Added actions to AmazonConnectServiceLinkedRolePolicy	Updated AmazonConnectServiceLinkedRolePolicy with actions for Amazon Connect Wisdom. For a description of the additional actions, see Amazon Connect updates to AWS managed policies .	September 29, 2023
Added "View my contacts" permission	Added a new security profile permission: View my contacts. On the Contact search page, agents who have this permission can access the contacts that they've handled. If you're using Contact Lens, agents can also review the analyzed recording and transcripts of the contact. For more information, see Security profile permissions for Contact Lens .	September 25, 2023
Streams API upgrade for third-party cookies	This upgrade prevents the blocking of third-party cookies from impacting Amazon Connect across Chrome and all supported browsers. For more information, see Use Amazon Connect Streams API for third-party cookies .	September 22, 2023

[Create alerts on real-time metrics](#)

You can create rules that automatically send emails or tasks to managers based on the values of real-time metrics. This enables you to alert managers on contact center operations that could potentially impact the end-customer experience. For more information, see [Create alerts on real-time metrics](#).

September 20, 2023

["Maximum contacts in queue" includes all channels](#)

If you have a queue that combines more than one channel, and you set a custom value for **Maximum contacts in queue**, the queue stops accepting new contacts after that number is reached, regardless of the distribution of contacts. For example, if you set the value to 50, and the first 50 contacts are chats, then voice calls are not routed to this queue. For more information, see [Set the Maximum contacts in queue limit](#).

September 15, 2023

[Manage contacts from the Contact details page](#)

On the **Contact details** page of an in-progress contact, you can manage a contact by transferring, rescheduling, or ending the contact. For more information, see [Manage contacts from the Contact details page](#).

September 14, 2023

[Upload file attachments to cases](#)

Agents can upload file attachments to cases. For more information, see [Enable attachments](#). For a list of supported file types, see [Feature specifications](#).

September 11, 2023

[Subscribe to the CONTACT_D ATA_UPDATED event type in the contact event stream](#)

You can subscribe to an event type called CONTACT_D ATA_UPDATED . The Contact object includes an UpdatedProperties field. This enables you to monitor for changes to scheduled timestamp for tasks, and changes to user-defined attributes on the contact record. In addition, hierarchy groups information in the AgentInfo object is included for CONTACT_DATA_UPDATED , CONNECTED_TO_AGENT , and DISCONNECTED event types. For more information, see [Contact events data model](#).

September 11, 2023

[Search for in-progress contacts](#)

You can search for in-progress contacts on the **Contact search** page. For more information, see [Search for in-progress contacts](#).

September 11, 2023

[APIs to programmatically configure views in step-by-step guides](#)

Amazon Connect provides APIs to programmatically create and manage view resources used in step-by-step guides. View resources define what gets displayed in your agent's UI during a step-by-step guide. For more information, see the [View resource](#) documentation.

September 7, 2023

[Support for UIFN in more than 60 countries](#)

Amazon Connect supports Universal International Freephone number (UIFN) in more than 60 countries that are registered with the International Telecommunications Union, an organization that supports the administration of the UIFN service. Amazon Connect allows you to enable UIFNs in as many countries as you need, with a requirement of at least 5 countries. For more information, see [UIFN service](#).

September 1, 2023

[Voice dialing for outbound campaigns, no agents required](#)

You can use Amazon Connect outbound campaigns for high-volume outreach with no agents required. A new dialer type called "Agentless" makes it easier to proactively communicate with your customers for use cases such as personalized voice notifications and appointment reminders. For more information, see [Create an outbound campaign](#) and the [CreateCampaign](#) API.

August 31, 2023

[Amazon Connect Cases supports nine additional languages](#)

For more information, see [Amazon Connect Cases](#) in the *Languages supported by Amazon Connect* topic.

August 28, 2023

[Granular access controls using resource tags for the agent activity audit report](#)

You can apply granular permissions to the agent activity audit report in the Amazon Connect historical metrics UI using resource tagging and tag-based access controls. For more information, see [tag-based access controls for agent activity audit](#) and [tag-based access controls in Amazon Connect](#).

August 25, 2023

Enhanced user bulk edit	You can now update up to 100 user records on the Amazon Connect admin website in less than half the time it used to take to make bulk updates. This enhancement is especially useful during contact surges when you may need to change the routing profile for many agents. For more information, see Edit users in bulk .	August 24, 2023
Amazon Connect scheduling supports agent group activities	Amazon Connect scheduling allows contact center managers to more efficiently create and manage activities for groups of agents. For more information, see Add shift activities in draft or published schedules .	August 24, 2023
GA for global sign-in and agent distribution capabilities	Released the following Amazon Connect Global Resiliency capabilities for general availability: global sign-in and agent distribution across Amazon Connect Regions. For more information, see Set up your agent's experience with Amazon Connect Global Resiliency . For a list of new APIs associated with this release, see the Release notes for Amazon Connect .	August 10, 2023

[Sorting on column header names](#)

You now have the ability to sort by choosing a column header, rather than choosing the smaller arrow next to the header text. For more information about real-time metrics, see [Real-time metrics reports](#).

August 8, 2023

[100 rows on real-time metrics tables](#)

You can now view up to 100 rows in the real-time metrics tables on the **Real-time metrics** page. Previously, the maximum was 50 rows. For more information about real-time metrics, see [Real-time metrics reports](#).

August 8, 2023

[Route based on time since last inbound contact](#)

Added an option to specify that selected agents with this routing profile will not have their routing order impacted by outbound contacts. For more information, see [Create a routing profile](#).

August 4, 2023

[Use the mini-map to navigate a flow](#)

On the flow designer, the mini-map view helps you easily navigate the flow. The drag-to-move mini-map has visual highlights that enable you to quickly move to any point in the flow. For more information, see [Use the mini-map to navigate a flow](#).

July 31, 2023

[Undo and redo actions in the flow designer](#)

For more information, see [Undo and redo actions in the flow designer](#).

July 31, 2023

[Restrict attributes to specific flows](#)

Released a new type of attributes called a flow attribute. Flow attributes are restricted to the flow in which they are configured. They are useful in situations where you don't want to persist the data throughout the contact, such as when you need to use sensitive information like the customer's credit card number to do a Lambda data dip. For more information, see [Flow attributes](#).

July 31, 2023

[Customize the names of flow blocks](#)

To help you distinguish blocks in a flow, you can customize the names of blocks. For example, you might rename a *Play Prompt* flow block to *Welcome message* or a *Get customer input* flow block to *Hotel booking Lex bot*. For more information, see [Set custom flow block name](#).

July 31, 2023

[Archive, restore, and delete flows and modules](#)

You can archive, restore, and delete flows and modules by using the Amazon Connect admin website. This makes it easier to manage flows and modules that are not in use or no longer needed. For example, flows used only during certain times of the year can be archived when not in use and then unarchived when needed. When a flow has been archived, you can then permanently delete the flow so it is no longer available within your list of flows. For more information, see [Archive, restore, and delete flows and modules](#).

July 31, 2023

[Add notes to a block](#)

For more information, see [Add notes to a block](#).

July 31, 2023

[Added permissions for using Wisdom page in console](#)

For more information, see [Required permissions for using custom IAM policies to manage access to the Amazon Connect console](#).

July 28, 2023

[Streamlined the left nav in the documentation](#)

Streamlined the left navigation menu in the Amazon Connect Administrator Guide to make it easier to navigate.

July 27, 2023

[Schedule flexible days and shift activities based on shift length](#)

You can generate agent schedules that have the appropriate number of activities, such as breaks or meals, depending on the duration of the shift. The required number of breaks and meals are automatically placed in schedules that are compliant to various regional labor laws. You can generate agent schedules that include flexible days, that is, days that will be optionally scheduled if there's a need. Amazon Connect can automatically generate flexible schedules that are compliant to agent's contracts and regional labor laws, thereby saving time for schedulers. For more information, see [Create shift profiles](#).

July 27, 2023

[Import time off balances](#)

You can import time off balances for your users. You can also set the group allowance for time off by hour, for each calendar day, for specific time off activities. Amazon Connect uses the time off balance to automatically approve or decline time off requests based on the agent's available net balance and the group allowance for time off. For more information, see [Import an agent's time off balance in a .csv file](#) and [Set group allowance for time off](#).

July 27, 2023

[Amazon Connect Customer Profiles supports rule-based matching and merging](#)

Amazon Connect Customer Profiles supports rule-based resolution to match and merge similar profiles into unified ones. This enables you to enhance customer service by granting agents and automated systems access to relevant customer information. As a result, interactions become faster and more personalized for customers. For more information, see [Use Identity Resolution to consolidate similar profiles](#).

July 27, 2023

[Amazon Connect Client Application v1.0.1.33 is available](#)

Released Amazon Connect Client Application v1.0.1.33 . With this newer version you no longer need to restart your desktop after installing the client application. For the download location, see the [Amazon Connect Client Application](#) topic.

July 21, 2023

[Amazon Connect Cases provides case assignment](#)

Case assignment helps organizations reduce the time to resolve customer issues by clearly tracking case activities and resolution ownership. Agents can associate a case with a queue or an individual agent for resolution. Agents can view and filter cases assigned to their queue, and managers can directly assign cases to individual agents. For more information, see [Set up case assignment](#).

July 20, 2023

[Updated ordering and porting numbers in Brazil](#)

Process and ID requirements have changed. For more information, see [Brazil](#) in the *Region requirements for ordering and porting phone numbers* topic.

July 19, 2023

[Contact Lens Conversational Analytics metrics in the API](#)

You can analyze aggregate agent and contact performance using Contact Lens Conversational Analytics metrics in the [GetMetricDataV2](#) API. The list of metrics include Average contact duration, Average conversation duration, Average greeting time agent, Average holds, Average interruptions agent, Average interruption time agent, Average non-talk time, Average talk time, Average talk time agent, and Average talk time customer. For more information, see [Historical metrics definitions](#) and [GetMetricDataV2](#).

July 18, 2023

[Amazon Connect Wisdom supports real-time recommendations for chat conversations](#)

Amazon Connect Wisdom delivers ML-powered, real-time recommended information to help chat agents quickly solve customer needs.

July 17, 2023

[Delete queues and routing profiles programmatically](#)

You can delete queues and routing profiles programmatically. For more information, see the following topics in the Amazon Connect API Reference: [DeleteQueue](#) and [DeleteRoutingProfile](#). Or see the following CLI topics: [delete-queue](#) and [delete-routing-profile](#). To create an AWS CloudFormation template for queues and routing profiles, see the following topics: [AWS::Connect::Queue](#) and [AWS::Connect::RoutingProfile](#).

July 13, 2023

[Agents can change their audio device settings in the CCP and agent workspace](#)

You can configure the Contact Control Panel (CCP) or agent workspace to enable agents to select their preferred device for microphone input and audio output, such as voice media and new contact notifications. For more information, see [How to use the CCP to change your audio device settings](#).

June 30, 2023

[New interactive message types](#)

Amazon Connect Chat supports new interactive message types: quick replies and carousels. With quick replies, customers are presented with a list of response options (for example, **Yes**, **No**) that they can easily click to reply. Carousels present a set of interactive messages in a horizontally-scrolling format. Your customers can scroll through them and select the best option. For more information, see [Add interactive messages to chat](#).

June 29, 2023

[Search for existing tags within an Amazon Connect instance](#)

Amazon Connect provides the ability to search for existing tags within an instance, both programmatically via API and within the UI. When tagging resources, you can search from pre-existing key:value pairs before creating new ones. For more information, see the [SearchResourceTags](#) API.

June 27, 2023

[Added screen recording capabilities](#)

Amazon Connect Contact Lens provides screen recording capabilities, making it easy for you to help agents improve their performance. With screen recording, you can identify areas for agent coaching (for example, long contact handle duration or non-compliance with business processes) by not only listening to customer calls or reviewing chat transcripts, but also watching the agent's actions while they are handling a contact. For more information, see [Set up and review agent screen recordings](#).

June 16, 2023

[Amazon Connect scheduling allows agents to manage time off requests](#)

Amazon Connect scheduling now allows contact center agents to manage their time off requests in a self-serve manner. For more information, see [Create time off](#).

June 15, 2023

[Real-time data export of unified customer profiles to an Amazon Kinesis Data Stream](#)

Amazon Connect Customer Profiles supports real-time data export of unified customer profiles to an Amazon Kinesis Data Stream. Companies can enable data streaming and automatically receive data for new profiles and updates to existing profiles into their Amazon Kinesis Data Stream. For more information, see [Set up real-time export](#).

June 8, 2023

[GetMetricDataV2 API: Region availability and new functionality](#)

The [GetMetricDataV2](#) API is available in the AWS GovCloud (US-West) Region. GetMetricDataV2 is now available in all AWS Regions where Amazon Connect is offered. This API enables you to access the trailing 35 days of historical agent and contact metrics (for example, service level, average handle time) with customizable filters and groupings. You can use GetMetricDataV2 to build custom dashboards to measure queue and agent performance over time. For example, you can identify the number of contacts that were disconnected by an agent versus disconnected by a customer hanging up. For more information, see [GetMetricDataV2](#).

June 6, 2023

[Contact Lens theme detection](#)

Contact Lens provides a machine learning powered capability for businesses to help identify top contact drivers by grouping customer conversations into themes. For more information, see [Use theme detection to discover issues](#).

May 24, 2023

[Troubleshoot monitoring agent conversations](#)

Added [feature specifications](#) for monitoring agent conversations. Added when the multi-party calls and enhanced monitoring feature is and is not enabled on your instance, the number of people who can be on the same agent call at the same time. Added a new topic to help you troubleshoot problems that may occur when supervisors monitor live agent conversations. For more information, see [Troubleshoot monitoring agent conversations with Amazon Connect](#).

May 18, 2023

[New APIs for managing prompts](#)

You can programmatically create and manage prompts using APIs, for example, to extract prompts stored in Amazon Connect and add them to your Amazon S3 bucket. AWS CloudTrail, AWS CloudFormation, and tagging are supported. For more information, see [Prompt actions](#) in the *Amazon Connect API Reference Guide*. Also see [AWS::Connect::Prompt](#) in the *AWS CloudFormation User Guide*.

May 18, 2023

[Added security information for forecasting, capacity planning, and scheduling capabilities](#)

For more information, see [Data protection in Amazon Connect](#).

May 16, 2023

[Updated GetMetricDataV2](#)

GetMetricDataV2 API supports metric data up to the last 35 days. For more information, see [GetMetricDataV2](#).

May 11, 2023

[Rich formatting in chat titles and subtitles](#)

You can add rich formatting to the titles and subtitles of your chat messages. For example, you can add links, italics, bold, numbered lists, and bulleted lists. You use [markdown](#) to format your text. For more information, see [Rich formatting in titles and subtitles](#) in the *Add interactive messages to chat* topic.

May 2, 2023

[GA for Amazon Connect evaluation capabilities](#)

Released Amazon Connect evaluation capabilities for general availability. This release includes the capabilities to [create rules based on evaluation results](#), and [search for evaluations and evaluation forms](#). For more information, see [Evaluate agent performance](#). To manage evaluation forms programmatically, see the [Evaluation](#) actions in the *Amazon Connect API Reference*. To create a shared template for evaluation forms, see the `AWS::Connect::EvaluationForm` resource in the *AWS CloudFormation User Guide*.

April 25, 2023

[Added new CreateParticipant API](#)

Added the [CreateParticipant](#) API which you can use to customize chat flow experiences. You use it to integrate custom participants. For more information, see [Customize chat flow experiences by integrating custom participants](#).

April 21, 2023

[Customer Profiles displays case information in the agent workspace](#)

Using Amazon Connect Customer Profiles inside the agent workspace, agents can see cases from third-party case management solutions and Amazon Connect Cases inside a particular customer profile. For more information, see [Use Customer Profiles](#) and [Access Customer Profiles in the agent workspace](#).

April 19, 2023

[Updated Set recording and analytics flow block topic](#)

Added information that explains how to disable Contact Lens conversational analytics. See [Configuration tips](#) in the *Flow block: Set recording and analytics behavior* topic.

April 14, 2023

[Updated Service quotas page](#)

Clarified how long it takes for quota increases to be processed. Corrected **Scheduled reports per instance** to indicate it is not adjustable. For more information, see [Amazon Connect service quotas](#).

April 13, 2023

[Added Wisdom support for Microsoft SharePoint Online](#)

You can choose Microsoft SharePoint Online as knowledge base for Wisdom articles.

April 12, 2023

Update to Set Voice ID block	Updated the Set Voice ID block so it supports fraud watchlist ID for fraud detection.	April 10, 2023
Added Cross-channel concurrency	You can configure an agent's routing profile to receive contacts from multiple channels at the same time. For example, while an agent is on a voice contact, they can be offered contacts from any other channels enabled in the routing profile, such as chats and tasks. For more information, see Create a routing profile . Also see the CrossChannelBehavior API.	April 10, 2023
Search, sort, and filter published agent schedules	Schedulers can quickly search, sort, and filter agent schedules from within the published schedule calendar. For more information, see Search and sort a schedule .	April 4, 2023

[Added staff level shift profile](#)

You can assign a shift profile to individual agents. This is useful to do when, for example, you have part-time agents who are in the same staffing group as your full-time agents, but they require their own shift profile. For more information, see the **Associate to shift profile** option described in [Create staff rules for scheduling](#).

March 31, 2023

[Updated Set up outbound caller ID](#)

As of March 31, 2023, Amazon Connect no longer sets CNAM configurations. For more information, see [CNAM](#) in the *Set up outbound caller ID* topic.

March 30, 2023

[Create step-by-step guides for your agents](#)

Inside the out-of-the-box Amazon Connect agent workspace, you can create workflows that walk agents through custom UI pages that suggest what to do at a given moment during a customer interaction. You can create guides that help agents identify customer issues and recommend subsequent actions, as well as surface screen-pops and forms for submitting transactions and disposition codes. For more information, see [Agent Workspace guided experience](#).

March 27, 2023

[Added support for nested JSON in Invoke AWS Lambda function flow block](#)

The Invoke AWS Lambda function flow block supports JSON responses. For more information, see [Flow block: Invoke AWS Lambda function](#).

March 27, 2023

[Added support for multiple fraudster watchlists](#)

Every domain has a default watchlist where all existing fraudsters are placed by default. You can create and manage custom watchlists to be evaluated against for known fraudster detection. For more information, see [Known fraudster detection](#), and see new actions in the [Amazon Connect Voice ID API Reference](#).

March 27, 2023

[Added Show View flow block](#)

This block is used to configure UI based workflows that you can surface to users in front end applications. For more information, see [Flow block: Show view](#).

March 27, 2023

[Search and sort schedules in the Schedule Manager](#)

Schedulers can quickly search for schedule names using partial keywords or sort the schedule list based on start date, end date, creation date, or updated date. For more information, see [Search and sort a schedule](#).

March 24, 2023

[Configure multiple IAM roles that can be assigned to a single user when using SAML 2.0](#)

You can configure multiple IAM roles that can be assigned to a single user when using SAML 2.0 which enables you to support user access from multiple identity providers simultaneously. For example, if you are migrating identity providers, you can configure multiple IAM roles associated to a single user and that user will be able to access Amazon Connect from either provider. To learn more about configuring IAM roles for SAML 2.0 in Amazon Connect, see the [Configure SAML with IAM for Amazon Connect](#) documentation.

March 17, 2023

[Panel template for interactive chat messages](#)

With a panel template, you can present customers with up to 10 choices under one question in a chat message. For more information, see [Add interactive messages to chat](#).

March 10, 2023

[Added GetMetricDataV2 API](#)

Added the [GetMetricDataV2](#) API to the *Amazon Connect API Reference Guide*. This API enables you to programmatically access trailing 14 days of historical agent and contact metrics data. It extends the capabilities of the [GetMetricData](#) API, provides new [historical metrics](#) (for example, the number of [contacts disconnected](#), and the number of [callback attempts](#)), and provides the ability to filter metrics with more granularity.

March 8, 2023

[Added permission for managing Amazon Connect Customer Profiles Service Linked Roles](#)

Added `iam:CreateServiceLinkedRole` which allows you to create service-linked roles for Customer Profiles.

March 7, 2023

[Updated Set up US emergency calling](#)

Updated the steps involved in setting up US emergency calling. For more information, see [Set up US emergency calling in Amazon Connect](#).

March 6, 2023

[Added the DeleteDomain API for Cases](#)

For more information, see the [DeleteDomain](#) API in the *Amazon Connect Cases API Reference Guide*.

February 24, 2023

[Added new attribute type ENHANCED_CONTACT_MONITORING to Describe, List and Update Instance Attribute APIs](#)

This release updates the APIs: [DescribeInstanceAttribute](#), [ListInstanceAttributes](#), and [UpdateInstanceAttribute](#). You can use it to programmatically enable/disable enhanced contact monitoring using attribute type ENHANCED_CONTACT_MONITORING on the specified Amazon Connect instance. For more information, see [DescribeInstanceAttribute](#), [ListInstanceAttributes](#), and [UpdateInstanceAttribute](#).

February 24, 2023

[Added RelatedContactId to StartTaskContact API](#)

You can link together an unlimited number of task contacts using the RelatedContactID parameter supported in the StartTaskContact API. For more information, see [Linked tasks](#) and the [StartTaskContact](#) API in the *Amazon Connect API Reference Guide*.

February 24, 2023

[Amazon Connect Cases integrates with AWS PrivateLink](#)

For more information, see [Amazon Connect and interface VPC endpoints \(AWS PrivateLink\)](#).

February 20, 2023

[Added CONTACT_EVALUATIONS to ResourceType](#)

In the *Amazon Connect API Reference Guide*, added CONTACT_EVALUATIONS as a valid value to the ResourceType parameter. This affects the following APIs: [AssociateInstanceStorageConfig](#), [DescribeInstanceStorageConfig](#), [DisassociateInstanceStorageConfig](#), [ListInstanceStorageConfig](#), and [UpdateInstanceStorageConfig](#).

February 20, 2023

[Added support to provide visibility into an agent's next activity](#)

You can view an agent's next activity in the real-time metrics agent table in the Amazon Connect real-time metrics UI and by using the public API. For more information, see the [NextStatus API reference](#).

February 17, 2023

[Added support to provide more granular permissions to metrics reports, including new permissions for real-time metrics, historical metrics, and agent activity audit](#)

You can configure more granular permissions to metrics and reports from within security profiles in the Amazon Connect admin website. For more information, see [Permissions required to view real-time metrics reports](#) and [Agent activity audit permissions](#).

February 17, 2023

[Added support for more granular access controls \(using resource tags\) to view real-time metrics for agents, queues, and routing profiles](#)

You can enable more granular access controls for real-time metrics by configuring resource tags and access control tags within security profiles in the Amazon Connect admin website. For more information, see [Real-time tag-based access control](#) and [Tag based access control in Amazon Connect](#).

February 17, 2023

[S3 Object Lock for the call recordings bucket](#)

You can use Amazon S3 Object Lock in combination with your call recording bucket to help prevent call recordings from being deleted or overwritten for a fixed amount of time, or indefinitely. For more information, see [How to set up S3 Object Lock for immutable call recordings](#).

February 3, 2023

[CloudFormation templates for instance management](#)

You can use CloudFormation templates to manage Amazon Connect instances for associating Amazon Lex and Lex V2 bots, Lambda functions, security keys, and approved origins—along with the rest of your AWS infrastructure—in a secure, efficient, and repeatable way. For more information, see [Amazon Connect resource type reference](#) in the *AWS CloudFormation User Guide*.

February 2, 2023

[Added information about key highlights](#)

To learn about the agent's key highlights experience in the Contact Control Panel, see [Design a flow for key highlights](#).

January 30, 2023

[Updated Concurrent post-chat analytics jobs quota](#)

Changed **Concurrent post-chat analytics jobs** quota from 100 to 200. For more information, see [Contact Lens service quotas](#).

January 27, 2023

[Added persistent chat](#)

Customers often start a chat, then leave the conversation and return later to continue chatting. This may happen many times over the course of several days, months, or even years. To support long running chats like these, you enable persistent chat. For more information, see [Enable persistent chat](#). Also see changes to [StartChatContact](#) in the *Amazon Connect API Reference Guide*, and see the [GetTranscript](#) API the *Amazon Connect Participant Service API Reference Guide*.

January 20, 2023

[Added documentation requirements Brazil, Caribbean, Iceland, and other numbers](#)

Updated documentation requirements for Austria, France, and Japan as well. For more information, see [Region requirements for ordering and porting phone numbers](#).

January 13, 2023

[Added documentation requirements for porting Argentina numbers](#)

For more information, see [Region requirements for ordering and porting phone numbers](#).

January 9, 2023

[Updates to GetCurrentMetricData and GetCurrentUserData](#)

For the [GetCurrentMetricData](#) API, added support for routing profile filter, sort criteria, and grouping by routing profiles. For the [GetCurrentUserData](#) API, added support for routing profiles, user hierarchy groups, and agents as filters, and next status and agent status name. For both APIs, added ApproximateTotalCount.

December 23, 2022

[Added message receipts feature for chat messages](#)

The message receipts feature allows customers to receive *Message delivered* and *Read* receipts after they send a chat message. For more information, see [Enable message Delivered and Read receipts in your chat user interface](#). Also see the [SendEvent](#) action, and the [Item](#), [MessageMetadata](#), and [Receipt](#) data types in the *Amazon Connect Participant Service API Reference Guide*.

December 23, 2022

[Microsoft Edge Chromium support](#)

Amazon Connect now supports Microsoft Edge Chromium. For more information about supported browsers, see [Browsers supported by Amazon Connect](#).

December 22, 2022

[Added chat timeouts for chat participants](#)

When a chat conversation between an agent and a customer has been inactive (no messages sent) for a certain amount of time, you may want to consider a chat participant to be idle, and you may even want to automatically disconnect an agent from the chat. To set up chat timeout timers, see [Set up chat timeouts for chat participants](#).

December 22, 2022

[Updated definition of DequeueTimestamp](#)

For the updated definition, see [Contact records data model](#).

December 21, 2022

[Amazon Connect supports JSON as a content type for chat messages](#)

By supporting JSON as a content type, Amazon Connect provides you with a way to pass additional information over chat to provide rich personalized experiences. For example, rendering updates to a custom UI, customer-built interactive messages, language translation capabilities, and passing customer metadata to a third party bot. For more information, see [StartChatContact](#) in the *Amazon Connect API Reference Guide*, and [SendMessage](#) in the *Amazon Connect Participant Service API Reference Guide*.

December 21, 2022

[Added feature availability by Region](#)

Added Amazon Connect features (such as Agent workspace, Tasks, and Wisdom), and the Regions where they are available. For more information, see [Availability of Amazon Connect services by Region](#).

December 20, 2022

[Added topic on Amazon Connect availability by Region](#)

For more information, see [Availability of Amazon Connect services by Region](#).

December 16, 2022

[Contact Lens granular data redaction](#)

When you set up Contact Lens sensitive data redaction, you can choose which entities you want to redact, and how you want the redaction to appear in the transcript. For more information, see [Enable redaction of sensitive data](#).

December 15, 2022

[Released Barge to allow contact center managers to join ongoing calls](#)

Barge allows managers to join and participate in an ongoing customer service call between a contact center agent and customer. After joining the call, a manager can speak with the customer, add participants, and even choose to remove an agent if needed. For more information, see [Barge live conversations](#).

December 14, 2022

[Additional Contact Lens language support and Region availability](#)

Documented that Contact Lens [supports the following languages](#): English - New Zealand, English - South Africa. It is also [available in the following Regions](#): Africa (Cape Town), Asia Pacific (Seoul), Asia Pacific (Singapore).

December 14, 2022

[Added user hierarchy to bulk user upload](#)

You can assign the user hierarchy in the .csv file when you add users in bulk. For more information, see [Add users in bulk](#).

December 13, 2022

[Granular access controls using resource tags for users, security profiles, routing profiles, and queues](#)

You can now enable more granular access controls for security profiles, users, routing profiles, and queues by configuring resource tags within the Amazon Connect console. You can add resource tags to filter and organize these resources logically, and configure access control tags within security profiles to enforce granular permissions. For more information, see [Tagging resources in Amazon Connect](#) and [Tag based access controls in Amazon Connect](#).

December 9, 2022

[Bulk user import now includes agent hierarchy and tags](#)

Amazon Connect now allows you to configure hierarchies and resource tags for users in bulk. You can now assign agent hierarchies and resource tags to each agent using the CSV bulk upload template which is available on the user management page. For more information, see [Tagging resources in Amazon Connect](#).

December 9, 2022

Rules Function language	The Rules Function language is a JSON-based representation of a series of rule conditions. Use it to programmatically add conditions to rules. For more information, see Amazon Connect Rules Function language in the <i>Amazon Connect API Reference Guide</i> .	December 7, 2022
Search contacts by agent's first or last name is available in AWS GovCloud	For more information, see Search contacts by agent's first or last name .	December 5, 2022
GA for Rules APIs	Released a set of Rules APIs that enable you to programmatically create and manage rules. For more information, see Rules actions in the <i>Amazon Connect API Reference</i> .	December 5, 2022
GA for Forecasting, scheduling, and capacity planning	Released Forecasting, scheduling, and capacity planning for General Availability. These features help you have the right number of agents working at the right times to achieve your operational goals. For more information, see Forecasting, capacity planning, and scheduling .	November 29, 2022

[Create step-by-step guides for your agents](#)

Inside the out-of-the-box Connect agent workspace, you can now create workflows that walk agents through custom UI pages that suggest what to do at a given moment during a customer interaction. You can create guides that help agents identify customer issues and recommend subsequent actions, as well as surface screen-pops and forms for submitting transactions and disposition codes. For more information, see [Agent Workspace guided experience](#).

November 29, 2022

[Contact Lens supports chat](#)

Amazon Connect Contact Lens provides conversational analytics capabilities for Amazon Connect chat, extending the machine learning powered analytics to better assess chat contacts. For more information, see [Analyze conversations using Amazon Connect Contact Lens](#).

November 29, 2022

[Added evaluation form features to Contact Lens \(Preview\)](#)

You can create evaluation forms, and then make them available to managers to review conversations alongside contact details, recordings, transcripts, and summaries, without the need to switch applications. Conversational analytics automatically pre-populates evaluation scores for criteria like script adherence, sensitive data collection, and customer greetings. For more information, see [Evaluate performance \(Preview\)](#).

November 29, 2022

[Added configurable Lex timeouts in chat](#)

You can configure how long to wait for a response from a customer in a chatbot conversation before the session expires. For more information, see *Configurable time-outs for chat input* in the [Get customer input](#) topic.

November 22, 2022

[Create rules that send email notifications](#)

You can create Contact Lens rules that send email notifications to people in your organization. For more information, see [Create Contact Lens rules that send email notifications](#).

November 17, 2022

Added MonitorContact API	Added a new API for programmatically initiating monitoring of ongoing contacts. For more information, see MonitorContact API .	November 17, 2022
Search for profiles using multiple search keys	In addition to searching for profiles with a single search key (i.e., a key-values(s) pair), the SearchProfiles API has been enhanced to support searching for profiles using multiple keys and logical operators. This new functionality allows you to use between 1 and 5 search keys with AND or OR logic to find profiles with attributes that match the search criteria.. For more information, see the SearchProfiles API reference .	November 14, 2022
Increased Cases domain quota from 2 to 5	Increased the default maximum number of Cases domains per AWS account from 2 to 5. For more information, see Amazon Connect Cases service quotas .	November 9, 2022
Added new fields to the GetFederationToken response payload	Added <code>SignInUrl</code> , <code>UserArn</code> , and <code>UserId</code> to the GetFederationToken response payload.	November 9, 2022

Added ability to disable case templates through the UpdateTemplate API	Disabling templates prevents users from creating cases by using the template. For more information, see the Amazon Connect Cases API Reference .	November 9, 2022
Renamed external quick connects to phone number quick connects	For more information, see Types of quick connects .	November 8, 2022
Delete quick connects using the Amazon Connect console	For more information, see Delete quick connects .	November 4, 2022
Added DismissUserContact API	Added a new API for programmatically clearing the notifications agents receive after they have missed or rejected a contact, making them eligible to be routed new contacts. This API can also be used to clear similar notifications when an agent encounters an error with accepting the contact or is handling After Contact Work. For more information, see the DismissUserContact API reference .	November 1, 2022
Added secondary email address and mobile number to user account	You can now add a secondary email address and mobile number to a user account. For more information, see Add users to Amazon Connect .	October 28, 2022

[Enhanced 911 \(E911\)](#)

Enhanced 911 (E911) enables location information to be sent to 911 dispatch when a 911 call is placed. In addition to connecting a user with 911 emergency services, customers in the United States can build E911 capabilities to automatically provide the caller's address information to 911 dispatchers. For more information, see [Set up US emergency calling in Amazon Connect.](#)

October 21, 2022

[GA for Amazon Connect Global Resiliency](#)

Released Amazon Connect Global Resiliency for General Availability. It enables you to provide customer service anywhere in the world with the highest reliability, performance, and efficiency, while meeting international regulatory requirements. For more information, see [Set up Amazon Connect Global Resiliency.](#)

October 19, 2022

[Corrected Wisdom service quota](#)

The originally published quota for **Content per knowledge base** was incorrect. Corrected the documentation to indicate the quota is 5,000.

October 17, 2022

Feature specifications for the integration association resource	For more information, see Integration association resource feature specifications .	October 13, 2022
Added Ctrl+Shift+F to search flow block titles and metadata	For more information, see the Release notes .	October 10, 2022
GA for Amazon Connect Cases	We've released Amazon Connect Cases for General Availability. Amazon Connect Cases allows your agents to quickly track and manage customer issues that require multiple interactions, follow-up tasks, and teams in your contact center. For more information, see Amazon Connect Cases and Amazon Connect Cases API Reference .	October 3, 2022
Updated flow designer	We've released a number of improvements to the flow designer experience to make building and editing flows easier. For a detailed list of changes, see Updated flow designer in the <i>Release notes</i> .	September 24, 2022

Search for Amazon Connect users by first name, last name, and more	You can search for Amazon Connect users by first name, last name, user login, agent hierarchy, security profile, and routing profile. For example, you can search for all Amazon Connect users who have the first name "Jane."	September 22, 2022
Visualize historical queue data	You can now visualize historical queue data by using time series graphs to help identify patterns, trends, and outliers specifically for Service Level, Contacts Queued, and Average Handle Time . For more information, see Visualize: Queue dashboard .	September 21, 2022
Voice spoofing	Use Voice ID to evaluate calls for voice spoofing. For more information, see Voice spoofing detection and the Amazon Connect Voice ID API Reference .	August 29, 2022
Released SearchSecurityProfiles API	Added a new API for programmatically searching security profiles. For more information, see SearchSecurityProfiles .	August 19, 2022

Released Schedule Adherence (Preview)	Contact center supervisors or managers track schedule adherence to understand when agents are following the schedule that you have created. This helps ensure you achieve your service level targets, while improving agent productivity and customer satisfaction. For more information, see Schedule Adherence .	August 1, 2022
Attachments per chat conversation now at 35	Updated the limit for attachments per chat conversations from 5 to 35. See Feature specifications .	July 20, 2022
Added Voice ID Flow language actions	Added topics for the following Voice ID Flow language actions: CheckOutboundCallStatus , CheckVoiceld , and StartVoiceldStream .	July 19, 2022
Search for contacts by using the agent's first or last name	You can search for contacts using the agent's first or last name. The filter name is Agent .	July 15, 2022

[Released updates for rich text format rendering](#)

On the **Contact Search** and **Contact Detail** pages, you can now view chat transcripts that have rich text formatting, such as bold or italic font, bullet points, numbered lists, and hyperlinks. For more information about getting started with Amazon Connect Chat, see [Set up your customer's chat experience](#).

July 13, 2022

[View call transcript in CCP or agent application](#)

For more information, see [View a call transcript during ACW](#).

July 7, 2022

[Added feature specifications for Contact Lens](#)

For more information, see [Amazon Connect Contact Lens feature specifications](#).

July 1, 2022

[Support for Lex intent confidence scores and sentiment analysis](#)

You can further personalize the automated self-service customer experience using Amazon Lex intent confidence scores and sentiment analysis as a branch within your flows. For more information, see the [Get customer input](#) block. For a list of new contact attributes see [Amazon Lex contact attributes](#).

June 29, 2022

[GA for Amazon Connect Outbound Campaigns](#)

Released Amazon Connect Outbound Campaigns, formally known as High-volume outbound communications, for General Availability. This release includes a set of APIs for creating and managing outbound campaigns. For more information, see [Enable Amazon Connect outbound campaigns](#) and [Amazon Connect Amazon Connect Outbound Campaigns API Reference](#).

June 20, 2022

[Amazon Connect Cases \(Preview\)](#)

Amazon Connect Cases (Preview) allows your agents to quickly track and manage customer issues that require multiple interactions, follow-up tasks, and teams in your contact center. For more information, see [Amazon Connect Cases \(Preview\)](#) and [Amazon Connect Cases API Reference \(Preview\)](#).

June 20, 2022

[Updated Amazon Lex bot per instance quota](#)

Updated the Amazon Lex bot per instance quota from 50 to 70. For more information, see [Amazon Connect service quotas](#).

June 7, 2022

New GetCurrentUserData API	Released the GetCurrentUserData API. It enables you to return the real-time active user data from the specified Amazon Connect instance.	June 6, 2022
Released task templates	You can now create custom task templates, making it easy for agents to consistently capture the relevant and required information to create or complete tasks. For more information, see Create task templates . For information about using the API to programmatically create and manage task templates, see the Amazon Connect API Reference and the Amazon Connect Resource Type Reference in the <i>AWS CloudFormation User Guide</i> .	June 2, 2022
New API to transfer contacts	Added a new API that you can use to transfer contacts from one agent or queue to another agent or queue at any point after a contact is created. For information, see TransferContact in the <i>Amazon Connect API Reference</i> .	June 2, 2022

[Updated workflow for outbound campaigns](#)

Updated the workflow for onboarding to outbound campaigns using the Amazon Connect and Amazon Pinpoint user interface. For more information, see [Enable outbound campaigns](#).

May 27, 2022

[Voice ID expires speakers](#)

For BIPA Compliance, Amazon Connect Voice ID automatically expires speakers that have not been accessed for enrollment, re-enrollment, or successful authentication for three years. You can see a speaker's last access time by looking at the `LastAccessedAt` attribute returned by the [DescribeSpeaker](#) and [ListSpeakers](#) APIs, and the [What data is stored?](#) section of the Amazon Connect Admin Guide.

May 25, 2022

[Search Voice ID results](#)

Added topic [Search and review Voice ID results](#).

April 28, 2022

[New API to change agent's current status](#)

Amazon Connect provides an API to programmatically change the current status of an agent. [Agent statuses](#) are used to determine when an agent is **Available** to be routed contacts in Amazon Connect, versus when they are set to **Offline** or a custom status such as **Lunch** or **Break** and should not be routed contacts. For more information, see [PutUserStatus](#) in the [Amazon Connect API Reference](#).

April 28, 2022

[New APIs](#)

Added API to search for user records by first name, last name, username, routing profile, security profile, agent hierarchies or tags. Added API to claim new phone numbers and configure them programmatically. For more information, see the [Amazon Connect API Reference](#).

April 25, 2022

[Multi-party calls](#)

You can enable Amazon Connect to allow up to six parties on a call: the agent, the caller, and four more participants. For more information, including a comparison of how multi-party calling differs from the default three-party calling, see [Telephony: Multi-party calls](#).

April 6, 2022

[Play prompts from an Amazon S3 bucket](#)

Added the ability to source prompts from an Amazon S3 bucket. This enables you to store as many voice prompts as needed in Amazon S3 and access them in real time using contact attributes in the following flow blocks that play prompts: [Get customer input](#), [Loop prompts](#), [Play prompt](#), and [Store customer input](#).

April 5, 2022

[Real-time contact analysis segment streams](#)

Added support for accessing Contact Lens analytics in near real-time. For more information, see [Use streaming for real-time contact analysis](#).

March 28, 2022

Rich messaging for chat	Added support for rich messaging for your customer's chat experience. Agents and customers can use bold, italic, bulleted lists, numbered list, hyperlinks, and attachments. For more information, see Enable text formatting for your customer's chat experience .	March 13, 2022
Object type mapping user interface	Added a user interface for creating object type mapping by using the Amazon Connect admin console. For more information, see Create an object type mapping .	March 8, 2022
Updates to AmazonConnectServiceLinkedRolePolicy	Added actions for Amazon CloudWatch metrics. For more information, see Amazon Connect updates to AWS managed policies .	February 22, 2022
Added bulk ingestion of data for Customer Profiles	For more information, see <i>Bulk ingestion of data</i> in the Set up integration for Salesforce, ServiceNow, Marketo, or Zendesk topic.	February 21, 2022
New quotas for APIs	For StartChatContact , StartContactStreaming , StopContactStreaming , a RateLimit of 5 requests per second, and a BurstLimit of 8 requests per second.	February 11, 2022

New CloudWatch metrics for chat	Added the following Amazon CloudWatch metrics for chat: ConcurrentActiveChats , ConcurrentActiveChatsPercentage , ChatBreachingActiveChatQuota , and SuccessfulChatsPerInterval . For more information, see Monitoring your instance using CloudWatch .	February 11, 2022
Documented Rules feature specifications	Documented the feature specifications for Amazon Connect Rules. For more information, see Amazon Connect Rules feature specifications .	January 28, 2022
Documented Identity Resolution quotas	Documented three quotas for Identity Resolution. For more information, see Customer Profiles quotas .	January 28, 2022
Configure maximum chat duration	You can configure the total duration per chat to be up to 7 days, including wait time. For more information, see the <code>ChatDurationInMinutes</code> parameter in the StartChatContact API.	January 27, 2022
Contact Lens supports custom vocabularies	For more information, see Add custom vocabularies .	January 25, 2022
Released tagging support for UserHierarchyGroup resource	For more information, see CreateUserHierarchyGroup .	January 20, 2022

Communications widget supports browser notifications	For more information, see Browser notifications .	December 21, 2021
Integrate Customer Profiles with Segment and Shopify	For more information, see Set up integration for Segment and Set up integration for Shopify .	December 20, 2021
Updated compliance for tasks	Tasks is in compliance with GDPR, and is approved for SOC, PIC, HITRUST, ISO, and HIPAA.	December 17, 2021
Released unified agent application	Amazon Connect released the unified agent application to improve the agent experience and customer interactions. For more information, see Agent training guide .	November 30, 2021
Released key highlights	Amazon Connect Contact Lens provides the option for you to view key highlights. The key highlights show only those lines where Contact Lens has identified an issue, outcome, or action item in the transcript. For more information, see View key highlights .	November 30, 2021
Documented Average API Connecting Time	Documented the real-time metric Average API Connecting Time . For more information, see Average API Connecting Time .	November 26, 2021

[Released Identity Resolution to consolidate similar profiles](#)

Amazon Connect Customer Profiles offers Identity Resolution, a feature that is designed to automatically detect similar customer profiles by comparing name, email address, phone number, date of birth, and address. For more information, see [Use Identity Resolution to consolidate similar profiles](#) and the [Amazon Connect Customer Profiles API Reference](#).

November 24, 2021

[Updated Customer Profiles service quotas](#)

Amazon Connect Customer Profiles now supports 1000 objects per profile (increased from 100), and 50MB Maximum size of all objects for a profile (increased from 5MB). For more information, see [Amazon Connect Customer Profiles service quotas](#).

November 23, 2021

[Amazon Connect Customer Profiles stores contact history at no charge](#)

Amazon Connect Customer Profiles now provides contact history and customer information together in unified customer profiles at no charge, helping contact center managers personalize the contact center experience. In new instances, Customer Profiles is enabled by default. For more information, see [Step 4: Data Storage](#) in the *Create an Amazon Connect instance* topic.

November 23, 2021

[New APIs to archive/unarchive and delete flows](#)

Added new APIs that provide a programmatic and flexible way to manage your library of flows at scale. For example, flows used only during certain times of the year can be archived when not in use and then unarchived when needed. You can now also delete a flow so it is no longer available for use. For more information, see the [Amazon Connect API Reference](#).

November 22, 2021

Added modular flows to help you create common functions	Flow modules are reusable sections of a flow. You can create them to extract repeatable logic across your flows, and create common functions. For more information, see Flow modules for reusable functions .	November 22, 2021
Search contacts by custom contact attributes	Added support for searching contacts by custom contact attributes (also called user-defined attributes). For more information, see Search by custom contact attributes .	November 15, 2021
Added Customer profiles block	Added the Customer profiles block. It enables you to retrieve, create, and update a customer profile.	November 15, 2021
Updated AmazonConnect_FullAccess	Added permissions for managing Amazon Connect Customer Profiles. See Amazon Connect updates to AWS managed policies .	November 12, 2021
Released security profiles APIs	Added APIs so you can create and manage security profiles programmatically. For more information, see the Amazon Connect API Reference .	November 12, 2021

[Released scheduled tasks](#)

Added the ability to schedule tasks up to six days in the future to follow-up on customer issues when promised. You can also update the scheduled date and time using the [UpdateContactSchedule](#) API. For more information, see the [Create task](#) block and the [Create a task](#) topic in the *Agent training guide*.

November 12, 2021

[Released Contact APIs](#)

Added APIs so you can get and update contact details programmatically. For example, you can describe contact details such as queue information, chat attachments, task references, and update contact information such as task name. For more information, see [DescribeContact](#), [UpdateContact](#), and [ListReferences](#) in the *Amazon Connect API Reference*.

November 12, 2021

[Changes to real-time metrics agent tables](#)

We are rolling out a new service to maintain the high availability from metrics that you expect from Amazon Connect. Due to this change, the agent tables are sorted by [agent status](#) instead of by agent login. Additionally, the queues and routing profiles table are sorted by agents online instead of by queue or routing profile name.

November 12, 2021

[Added actions to AmazonConnectServiceLinkedRolePolicy](#)

Added actions for Amazon Connect Customer Profiles. See [Amazon Connect updates to AWS managed policies](#).

November 12, 2021

[Added new metrics](#)

Added following new historical metrics: **Contacts transferred in by agent** and **Contacts transferred out by agent**. Added new real-time metrics: **Transferred in by agent** and **Transferred out by agent**. See [Historical metrics definitions](#) and [Real-time metrics definitions](#).

November 9, 2021

[Released real-time chat message streaming](#)

You can subscribe to a real-time stream of chat messages. For more information, see [Enable real-time chat message streaming](#).

October 29, 2021

Cross-service confused deputy prevention for Customer Profiles	Updated Cross-service confused deputy prevention with more sample policies you can apply for Amazon Connect Customer Profiles.	October 26, 2021
GA for HoursOfOperation APIs	Released the Amazon Connect HoursOfOperation APIs for general availability (GA). Also launched AWS CloudFormation support for Users, User Hierarchies, and Hours of Operation. For more information, see the Amazon Connect API Reference and the AWS CloudFormation User Guide .	October 22, 2021
Example: Programmatically integrate S3 with Customer Profiles	Added a topic that shows how to programmatically integrate S3 with Customer Profiles .	October 21, 2021
Cross-service confused deputy prevention	Added a topic with example policies you can apply for Cross-service confused deputy prevention .	October 18, 2021
How long unanswered callbacks stay in queue	In the Set up queued callback topic, clarified that unanswered queued callbacks stay in queue at least 7 days and up to 14 days before Amazon Connect automatically removes them.	October 13, 2021

Updated endpoint for client-side metrics	In the Set up your network topic, changed the endpoint for client-side metrics from *.execute-api.{region}.amazonaws.com to *.telemetry.connect.{region}.amazonaws.com .	October 11, 2021
Corrected errors in Service quota topic	Corrected errors in the Service quotas topic: For Amazon Connect Wisdom, Maximum size per document is 1MB not 10MB. For Amazon Connect Customer Profiles, the name of the quota is Object Types per domain not Objects per domain. Updated the Amazon Connect Voice ID quotas table with correct information.	October 8, 2021
Preview release of outbound campaigns	Added content for the preview release of outbound campaigns. By using Amazon Pinpoint Journeys and Amazon Connect, you can now create outbound campaigns for voice, SMS, and email. For more information, see Enable outbound campaigns .	September 27, 2021

[New Amazon AppIntegrations Service APIs](#)

New DataIntegration APIs for the Amazon AppIntegrations Service: CreateDataIntegration , DeleteDataIntegration , GetDataIntegration , ListDataIntegrationAssociations , ListDataIntegrations , UpdateDataIntegration . For more information, see [Amazon AppIntegrations Service API Reference](#).

September 27, 2021

[Amazon Connect Wisdom - General Availability](#)

In November 2023 we released Amazon Q. It includes real-time agent assist functionality formerly known as Amazon Connect Wisdom, along with generative AI-powered recommended responses, actions, and links to more information.

September 27, 2021

[Amazon Connect Voice ID - General Availability](#)

For more information, see [Use real-time caller authentication with Voice ID](#) and the [Amazon Connect Voice ID API Reference](#).

September 27, 2021

[Added new service-linked role policy](#)

Added AmazonConnectVoiceIDFullAccess . Use this AWS managed policy so you can set up your users to use Voice ID. This policy provides full access to Amazon Connect Voice ID through the AWS console, SDK, or other means. For more information, see [AWS managed policy: AmazonConnectVoiceIDFullAccess](#).

September 27, 2021

[Added new service-linked role policy](#)

Added AmazonConnectCampaignsServiceLinkedRolePolicy , a new service-linked role policy for outbound campaigns. The policy provides access to retrieve all the outbound campaigns. For more information, see [Enable outbound campaigns](#).

September 27, 2021

[Display name and contact attributes in chat](#)

You can now personalize the chat experience, as you can specify the name of your customer that interacts using the chat user interface. You can also securely pass the contact attributes to capture information about the contact which can be used in the flow to further personalize the experience. For more information, see [Pass the customer display name when a chat initializes](#) and [Pass contact attributes when a chat initializes](#).

September 17, 2021

[Preview of agent application](#)

Launched an updated UI for the agent application preview that combines Customer Profiles and the Contact Control Panel (CCP). For more information, see [Access Customer Profiles in the agent application](#).

September 16, 2021

[Added Create task block](#)

Added the **Create task** block. It creates a new task, sets the tasks attributes, and initiates a flow to start the task. For more information, see [Flow block: Create task](#).

September 16, 2021

[More languages for Contact Lens](#)

Contact Lens now supports the following languages for post-call and real-time analytics: Japanese, Korean, and Mandarin. The following languages are supported for real-time analytics: French (Canada), French (France), Portuguese (Brazil), German (Germany), and Italian (Italy). For more information, see [Contact Lens for Amazon Connect](#) in the *Languages supported by Amazon Connect* topic.

September 13, 2021

[Updated historical metrics definitions](#)

Updated the definitions of **Contacts transferred in** and **Contacts transferred out**. For more information, see [Historical metrics definitions](#).

September 10, 2021

[Improved user interface for Amazon Connect console](#)

Released a redesigned user interface for the Amazon Connect console, making it easier and faster to manage Amazon Connect instances . For more information, see [Create an Amazon Connect instance](#).

August 27, 2021

[Customer Profiles is HIPAA compliant](#)

Customer Profiles is now HIPAA compliant. Removed note stating it is not.

August 23, 2021

Porting numbers in Singapore	Updated documentation requirements. For more information, see Singapore in the <i>Region requirements for ordering and porting phone numbers</i> topic.	August 10, 2021
APIs for hours of operation and agent status	Released for ungated preview new APIs for managing hours of operation and agent status. For more information, see Amazon Connect Service API Reference .	August 6, 2021
Contact Lens rules create tasks and EventBridge events	Contact Lens rules now allow you to generate tasks and EventBridge events based on uttered keywords, sentiment scores, customer attributes, and other criteria. For more information, see Build rule with Contact Lens .	August 5, 2021
Countries you can call by default	We have updated the list of countries you can call by default when you create a new instance in a given Region. For more information, see Countries you can call .	August 4, 2021

[Add AWS Global Accelerator to your allowlist](#)

When using SAML Sign-In to your Amazon Connect instance, you now need to add the AWS Global Accelerator domain, *. **awsglobalaccelerator.com**, to your allowlist. For more information, see [Set up your network](#).

August 3, 2021

[New "Next status" feature](#)

To help agents manage their time, we have released a feature that lets agents pause new contacts being routed to them while they finish their current contacts. For more information, see ["Next status" feature for the CCP](#).

July 30, 2021

[Update to Contact search functionality](#)

To use the **Agent** filter on the **Contact search** page, in your Amazon Connect security profile you must have **Users - View** permissions. For more information, see [Contact search: To search contacts by Agent login requires Users - View permissions in your security profile](#).

July 23, 2021

[Added two task metrics sent to CloudWatch](#)

Amazon Connect sends the following two new metrics to CloudWatch: ConcurrentTasks and ConcurrentTasksPercentage. For more information, see [Monitoring your instance using CloudWatch](#).

July 7, 2021

Updated required permissions for custom IAM policies	Added permissions for Amazon Lex. For more information, see Amazon Connect updates to AWS managed policies .	June 29, 2021
Apple Messages for Business GA	Released Apple Messages for Business for general availability (GA). For more information, see Enable Apple Messages for Business .	June 28, 2021
Quick connects management API GA	Released Amazon Connect quick connects management API for general availability (GA). For more information, see Amazon Connect Service API Reference . The quick connects API also supports AWS CloudFormation. For more information, see Amazon Connect Resource Type Reference in the AWS CloudFormation User Guide.	June 24, 2021
Added service quota for Amazon Lex V2 bot aliases per instance = 100	For more information about service quotas, see Amazon Connect service quotas .	June 17, 2021

Support for Amazon Lex V2 console and APIs	For information on using the Amazon Lex V2 console, see Add an Amazon Lex bot . Added these three APIs: AssociateLexBot, DisassociateLexBot, and ListLexBots. See the Amazon Connect Service API Reference .	June 15, 2021
Coming soon: Faster load times for Real-time metrics page	Rollout to all Regions July 19, 2021, to September 19, 2021, subject to change. For more information, see Upcoming change: Faster reload times for the Real-time metrics page .	June 11, 2021
Coming soon: New DataIntegration APIs	On May 20, 2021, we published that new DataIntegration APIs were added to the Amazon AppIntegrations service. These APIs are not yet available.	June 8, 2021
Chat agent concurrency increased	Increased chat agent concurrency from 5 to 10. For more information, see Create a routing profile .	June 7, 2021
Object type mapping for Customer Profiles	Added object type mapping for the Customer Profiles standard profile. For more information, see the Object type mapping for the standard profile .	June 1, 2021

Channels supported by blocks	Added a topic that lists all the blocks and which channels each one supports. For more information, see the Channels each block supports .	May 18, 2021
Added contact events	For more information, see the Amazon Connect contact events .	May 12, 2021
Announced upcoming change to Agent audit report	In a future release, you'll be able to download the Agent audit report. For more information, see the Upcoming changes: Download the Agent audit report .	May 4, 2021
Added identity resolution APIs (preview) to Customer Profiles.	For more information, see the GetMatches and MergeProfiles APIs in the Amazon Connect Customer Profiles API reference.	April 30, 2021
Added topic on how to apply permissions that restrict which AWS resources can be associated with Amazon Connect.	For more information, see Restrict AWS resources that can be associated with Amazon Connect .	April 28, 2021
Added chapter on architectural guidance, authored by AWS Solution Architects	For more information, see Architectural guidance for Amazon Connect .	April 28, 2021
Announced upcoming fix to agent event stream	For more information, see Upcoming change: Fix for agent event stream .	April 27, 2021

[Revised the topics on porting phone numbers](#)

For more information, see [Port your phone number](#).

April 24, 2021

[Using Customer Profiles with CCP out-of-the-box is in un gated preview](#)

For more information, see [Access the Customer Profiles Agent UI](#).

April 22, 2021

[Announced upcoming changes for Contact search](#)

For more information, see [Upcoming changes: Contact search](#).

April 20, 2021

[Added NLB endpoint for Canada \(Central\) Region](#)

Updated [Set up your network](#) with the NLB endpoint for Canada (Central) Region.

April 15, 2021

[Amazon Connect is now available in the Canada \(Central\) Region](#)

You can claim toll-free and local telephone numbers from Canadian telephony suppliers . For a list of countries that support the Canada (Central) Region, see [Region requirements for phone numbers](#). Also see [Availability of Contact Lens features by Region](#).

March 31, 2021

[Announced upcoming fixes for chat metrics](#)

Currently Amazon Connect incorrectly reports that chat contacts that were created from disconnect flows were created from transfer flows. When the fixes are released, Amazon Connect will correctly reflect in the contact records and agent event stream that these chat contacts were created from disconnect flows. For more information, see [Upcoming change: Fixes for chat metrics](#) in the Release notes.

March 25, 2021

[Completed release of new domain name](#)

The domain for the Amazon Connect access URL has changed to **my.connect.aws**. For more information, see [March 2021 Updates](#) in the Release notes.

March 22, 2021

[Default service quota for reports per instance](#)

Updated the default service quota for reports per instance to 2000. This default applies to accounts created in October, 2020 or later. For more information, see [Amazon Connect service quotas](#).

March 16, 2021

[Identification requirements for ordering and porting phone numbers](#)

Added identification requirements for ordering phone numbers. Added requirements for ordering and porting phone numbers from Argentina, Chile, Mexico, Peru, and Puerto Rico. For more information, see [Region requirements for phone numbers](#).

March 11, 2021

[Use the Amazon Connect Endpoint Test Utility](#)

To help you validate connectivity to Amazon Connect, or troubleshoot when your agents are experiencing problems with the Contact Control Panel (CCP), we added the Amazon Connect Endpoint Test Utility. For more information, see [Use the Endpoint Test Utility](#).

March 5, 2021

[Add a chat user interface to your website.](#)

Added a communications widget that you can customize and add to your website. Also provided an open source example to help you get started with adding chat to your website. For more information, see [Set up your customer's chat experience](#).

March 5, 2021

[Content Lens real-time analytics is available in Europe \(London\), Europe \(Frankfurt\), and Asia \(Tokyo\).](#)

For more information, see [Availability of Contact Lens features by Region](#).

February 26, 2021

Added ability to create and ingest data into Customer Profiles from Amazon S3	For more information, see Create and ingest data into Customer Profiles from Amazon S3 .	February 25, 2021
Added DisconnectReason to the contact record stream	The Amazon Connect contact records stream now includes DisconnectReason for voice calls and tasks. For more information, see ContactTraceRecord .	February 19, 2021
Added custom service levels	Added the ability to create custom service levels, and update the metrics user interface. For details, see New metric groups and categories .	February 16, 2021
Queue APIs (Preview)	Added APIs so you can programmatically create and manage queues. Queue APIs (Preview) .	January 29, 2021
Amazon AppIntegrations APIs - GA	Released Amazon AppIntegrations APIs for general availability (GA). For more information, see Amazon AppIntegrations APIs - GA .	January 29, 2021
New Contact search page	Updated the Contact search page. For more information, see Search for contacts .	January 5, 2021

Amazon Connect Service API Reference	Added APIs so you can programmatically create and manage quick connects. For more information, see Amazon Connect Service API Reference .	December 22, 2020
Chat: Support for sharing attachments	Added support for sharing chat attachments. For more information, see Chat: Support for attachments .	December 21, 2020
Configurable DTMF timeouts for Lex bots	Added support for configurable DTMF timeouts for Lex bots. For more information, see Configurable DTMF timeouts for Lex bots .	December 4, 2020
Amazon Connect with Apple Messages for Business (Preview)	Added support for using Amazon Connect with Apple Messages for Business. For more information, see Amazon Connect with Apple Messages for Business (Preview)	December 3, 2020
Tasks	Added support for tasks, allowing you to prioritize, assign, track, and even automate tasks across the disparate tools agents use to support customers. For more information, see Tasks .	December 1, 2020

Real-time analytics using Contact Lens for Amazon Connect	Added real-time analytics for Contact Lens so you can detect and resolve customer issues more proactively while the call is in progress. For more information, see Analyze Conversations with Contact Lens for Amazon Connect .	December 1, 2020
Amazon Connect Wisdom (Preview)	In November 2023 we released Amazon Q. It includes real-time agent assist functionality formerly known as Amazon Connect Wisdom, along with generative AI-powered recommended responses, actions, and links to more information.	December 1, 2020
Amazon Connect Voice ID (Preview)	Added Amazon Connect Voice ID (Preview), which provides for real-time caller authentication. For more information, see Amazon Connect Voice ID (Preview) .	December 1, 2020
Amazon Connect Customer Profiles	Added Amazon Connect Customer Profiles, enabling agents to create a customer profile for every new contact that comes in. You can also integrate with external applications that provide customer profile data. For more information, see Amazon Connect APIs .	December 1, 2020

Amazon Connect APIs	Added an Amazon Connect API that provides the ability to create tasks (StartTaskContact), and added a set of preview APIs. For more information, see Amazon Connect APIs .	December 1, 2020
Amazon Connect supports interact messages for chat	Added interactive message templates. For more information, see Add interactive messages to chat .	November 24, 2020
Telephony call metadata attributes	Added call attributes to improve fraud detection and routing. For more information, see Telephony call metadata attributes (call attributes) .	November 20, 2020
APIs to manage user hierarchies	Added APIs so you can programmatically manage your agent hierarchies and agent groups. For more information, see Amazon Connect Service API Reference .	November 18, 2020
Service quotas	Noted that up to 700 quick connects can be added to a queue. See Feature specifications . (This update was published erroneously and has since been removed.)	October 5, 2020

Security	Added new topic on Required permissions for managing access to the Amazon Connect console .	September 24, 2020
Quick filters	Added new topic that explains how to use quick filters in real-time metrics reports. For more information, see Use quick filters to drill into Routing profiles and Queues tables .	September 23, 2020
Service quotas	Updated the service quotas for the following Amazon Connect Participant Service APIs: <code>CreateParticipantConnection</code> , <code>DisconnectParticipant</code> , and <code>GetTranscript</code> . For more information, see Amazon Connect Participant Service API throttling quotas .	September 22, 2020
Show agent queues in a Queues table.	By default, agent queues don't appear in a Queues table in a historical metrics report. You can choose to show them. For more information, see Show agent queues in a Queues table .	September 18, 2020
Migrate contact flows to a different instance	You can migrate hundreds of flows using a set of flow APIs. For more information, see Migrate contact flows to a different instance .	September 18, 2020

[Languages supported by Amazon Connect](#)

Learn about which languages are supported in the Amazon Connect console, Contact Control Panel, Contact Lens, Amazon Lex, and Amazon Polly. For more information, see [Languages supported by Amazon Connect](#).

September 18, 2020

[Amazon Connect Flow language](#)

You can use the Amazon Connect Flow language to efficiently update flows that you're migrating from one instance to another, and Write flows rather than drag blocks onto the flow designer. For more information, see [Amazon Connect Flow language](#) in the *Amazon Connect API Reference Guide*.

September 18, 2020

[Option 2 \(not recommended\): Allow IP address ranges](#)

Removed tip from *Option 2: Allow IP address ranges*, that said if you don't see an entry for your region, use GLOBAL. For more information, see [Option 2 \(not recommended\): Allow IP address ranges](#).

September 11, 2020

Option 1 (recommended): Replace Amazon EC2 and CloudFront IP range requirements with a domain allowlist	<p>Updated Option 1, second row of table, with a line break between {myInstanceName}.awsapps.com/connect/api and *.cloudfront.net. For more information, see Option 1 (recommended): Replace Amazon EC2 and CloudFront IP range requirements with a domain allowlist.</p>	September 11, 2020
Amazon Connect resource-level policy examples	<p>Changed title of "Amazon Connect resource-based policy examples" topic to "Amazon Connect resource-level policy examples." For more information, see Amazon Connect resource-level policy examples.</p>	September 8, 2020

Earlier updates

Change	Description	Date
<p>Updated the Consult and Contact consulted metrics to indicate they were deprecated May 2019.</p>	<p>For more information, see Consult and Contacts consulted.</p>	August 27, 2020
<p>Added topic on setting up agent-to-agent transfers.</p>	<p>For more information, see Set up agent-to-agent transfers.</p>	August 19, 2020
<p>Added section on requirements for custom termination points.</p>	<p>For more information, see Request numbers, international numbers, or termination points.</p>	August 18, 2020

Change	Description	Date
Removed the "Known differences" section from I use the Amazon Connect Streams API .	For more information, see I use the Amazon Connect Streams API .	August 3, 2020
Changed the name of the Metrics chapter to Monitor metrics & run reports .	For more information, see Real-time and historical metrics, dashboards, and reports .	July 16, 2020
Clarified that the following metrics are no longer supported in queue grouping: Agent on contact time, Agent idle time, Occupancy . Previously we stated that these metrics had been deprecated.	For more information, see June 2020: Changes for omnichannel support .	July 8, 2020
Updated the Set disconnect flow block, which now supports voice conversations.	For more information, see Set disconnect flow .	June 29 2020
Added upcoming metric changes: new real-time and historical metrics for inbound and outbound contact time	For more information, see Real-time and historical metrics, dashboards, and reports .	June 26, 2020
Added how to upgrade CCP	For more information, see Upgrade to the latest CCP .	June 16, 2020
Added video on using CCP	For more information, see Training video: How to use the CCP .	June 16, 2020

Change	Description	Date
Deprecated metrics: Agent on contact time, Agent idle time, Occupancy.	For more information, see June 2020: Changes for omnichannel support .	June 12, 2020
Added topic on quick connects work	For more information, see How quick connects work .	May 21, 2020
Added how to get administrative support, and added a topic on inherited permissions	For more information, see Get administrative support for Amazon Connect and About inherited permissions .	April 16, 2020
Added how to customize your CCP to log out agents automatically when they close the CCP window	For more information, see CCPv1: Log out agents automatically when they close their CCP .	April 16, 2020
Updated the Get customer input block to support timeout values for voice input	For more information, see Get customer input .	April 8, 2020
Added terminating keypress	For more information, see Store customer input .	March 31, 2020
Added NLB endpoints and required domain for softphones	For more information, see Set up your network .	March 23, 2020
Announced upcoming changes for metrics	For more information, see June 2020: Changes for omnichannel support .	March 23, 2020
Added topic on region requirements for phone numbers	For more information, see Region requirements for ordering and porting phone numbers .	March 11, 2020

Change	Description	Date
Added tutorials	For more information, see Tutorials: An introduction to Amazon Connect .	March 6, 2020
Added topic on emergency admin access	For more information, see Emergency admin login .	March 3, 2020
Added topics on saving, sharing, and publishing reports	For more information, see Save custom reports , Share custom reports , View a shared report , and Publish reports .	January 22, 2020
Updated flow block definitions	For more information, see .	January 17, 2020
Added a section about queued callbacks in metrics reporting.	For more information, see About queued callbacks in metrics .	January 17, 2020
Updated networking guidance for the updated CCP (ccp-v2)	For more information, see Set up your network .	January 15, 2020
Add a topic on logging Amazon Connect API calls with AWS CloudTrail	For more information, see Logging Amazon Connect API calls with AWS CloudTrail .	December 13, 2019
Added a section on analyzing conversations	For more information, see Analyze conversations using conversational analytics .	December 02, 2019
Added information about live media streaming	For more information, see Set up live media streaming of customer audio .	November 21, 2019

Change	Description	Date
Added information about chat	For more information, see Web and mobile messaging . Also added these topics: Best practices for Amazon Connect , About agent status , About contact states , and Additional resources for Amazon Connect .	November 21, 2019
Added topic on using IAM	For more information, see Identity and access management for Amazon Connect .	November 14, 2019
Added dimensions	Added dimensions to the Amazon Connect metrics sent to CloudWatch. See Monitoring your instance using CloudWatch .	October 22, 2019
Added a networking topic	Consolidated networking content into Set up your network . Updated the guidance.	September 30, 2019
Updated metrics topics	Improved the descriptions of the real-time metrics definitions. Added categories to the historical metrics definitions.	August 30, 2019
Updated historical metrics report section	Added categories to the historical metrics definitions.	August 27, 2019
Re-organized the content	Re-organized the content so it's task-based.	July 19, 2019

Change	Description	Date
Added information about the updated Transfer to phone number block	You can use the updated Transfer to phone number block to transfer callers to a phone number external to your Amazon Connect instance, and then optionally resume the flow after the call with the external party ends. For more information, see Resume a flow after transfer .	February 18, 2019
Adding information about live media streaming for customer audio streams	You can capture customer audio during interactions with your contact center and send it to a Kinesis video stream. For more information, see Set up live media streaming of customer audio .	December 21, 2018
Added content about agent queues	You can use agent queues to route calls directly to a specific agent. For more information, see Transfer contacts to a specific agent .	December 21, 2018
Added information about using Amazon Connect in the Asia Pacific (Tokyo) Region.	For more information, Claim phone numbers for Amazon Connect in the Asia Pacific (Tokyo) Region .	December 10, 2018
Added information about how to determine agent ACW time from agent event streams	For more information, see Determine how long an agent spends doing ACW .	October 30, 2018

Change	Description	Date
Added troubleshooting and best practices	Troubleshooting Issues when using the Contact Control Panel (CCP) covers best practices for agent connectivity using the CCP and troubleshooting connectivity and call quality issues in Amazon Connect.	October 18, 2018
Added information about service-linked roles in Amazon Connect	For more information, see Use service-linked roles for Amazon Connect .	October 17, 2018
Added information about queue to queue transfers	You can use the new options of the Transfer to queue block to enable transferring calls that are already in a queue to another queue. For more information, see Manage contacts in a queue .	July 31, 2018
Added information about the Call phone number block	Updated the content about flows to include the new Call phone number block, including how to use the block in a flow. For more information, see Outbound caller ID number .	July 2, 2018
Added information about contact attributes and the Get queue metrics block	For more information, see Use Amazon Connect contact attributes .	June 18, 2018
Added information about new metrics sent to Amazon CloudWatch Logs.	Monitoring your instance using CloudWatch includes additional metrics.	April 19, 2018

Change	Description	Date
Added information about using SAML for identity management	You can configure your instance to use SAML for identity management. You can also use SAML to enable single sign-on. For more information, see Configure SAML with IAM for Amazon Connect .	March 30, 2018
Added information about agent call transfers	You can enable call transfers from an agent to another agent, to a queue, or to an external number.	December 10, 2017
Added information about manager listen-in	You can configure and enable a manager to listen in on agent calls. For more information, see Set up live monitoring for voice and/or chat .	December 10, 2017
Added information about flow logs	For more information, see Enable flow logs .	November 16, 2017
Added information about flow import/export	For more information, see Import/export flows .	November 16, 2017
Added information about agent event streams	For more information, see Amazon Connect agent event streams .	November 16, 2017
Added information about porting your current phone number to Amazon Connect	For more information, see Port your current phone number to Amazon Connect .	November 10, 2017

Change	Description	Date
Added information about Login/Logout reports	For more information, see Login/Logout reports .	November 1, 2017
Initial release	Initial release of the <i>Amazon Connect Administrator Guide</i> .	March 28, 2017

Amazon Connect Glossary

Channel

How a customer contacts your business: voice (a phone call), chat (a web site or app), and task.

Contact attribute

A piece of data about a contact. You can use this data to personalize the customer experience, make routing decisions about contacts as they progress through your contact center or retrieve real-time metrics about the queues and agents in your contact center to dynamically route contacts based on queue and agent availability.

Flow

Flows define the experience your customers have when they interact with your contact center. These are similar in concept to Interactive Voice Response (IVR). Flows are comprised of blocks, with each block defining a step or interaction in your contact center. For example, there are blocks to play a prompt, get input from a customer, branch based on customer input, or invoke an Lambda function or Amazon Lex bot.

Instance

A virtual contact center. It is 100% cloud-based and can scale to support any sized business. An Amazon Connect instance is not aligned to an EC2 instance or any other hardware concept.

Letter of Authorization

Letter of Authorization (LOA) is a legal document in which you assert to the carrier for Amazon Connect that you have the authority to port phone numbers from your current carrier to the carrier for Amazon Connect. Traditionally, this is a paper document requiring an actual signature.

Losing carrier

Also the customer's current carrier. This is the carrier that currently owns the telephone number. The losing carrier will review all information presented on the Letter of Authorization (LOA) and will validate if it matches the information that they have on file for the customer.

Mutually agreed date and time

After the LOA has been approved by the losing carrier, the losing and winning carriers agree upon a date and time to perform the porting activity.

Omnichannel

A unified contact experience across multiple communication channels, such as voice and chat. Admins can build experiences once, and enable them for voice and chat. Managers monitor and adjust queues from one dashboard. Agents handle all customers using one interface.

Phone number portability

Number portability allows telephone customers to transfer their numbers to other carriers. Carriers and countries may have unique processes and procedures required.

Queue

A waiting area that holds contacts to be answered by agents.

Winning carrier

Also the carrier for Amazon Connect. This is the carrier that the phone number is being ported to, and will own the phone number after the porting is completed.