



Multi-tenant SaaS authorization and API access control: Implementation options and best practices

# AWS Prescriptive Guidance



# **AWS Prescriptive Guidance: Multi-tenant SaaS authorization and API access control: Implementation options and best practices**

Copyright © 2024 Amazon Web Services, Inc. and/or its affiliates. All rights reserved.

Amazon's trademarks and trade dress may not be used in connection with any product or service that is not Amazon's, in any manner that is likely to cause confusion among customers, or in any manner that disparages or discredits Amazon. All other trademarks not owned by Amazon are the property of their respective owners, who may or may not be affiliated with, connected to, or sponsored by Amazon.

---

# Table of Contents

<b>Introduction</b> .....	<b>1</b>
Targeted business outcomes .....	2
Tenant isolation and multi-tenant authorization .....	3
<b>Types of access control</b> .....	<b>4</b>
RBAC .....	4
ABAC .....	4
RBAC-ABAC hybrid approach .....	5
Access control model comparison .....	5
<b>Implementing a PDP</b> .....	<b>7</b>
Using Amazon Verified Permissions .....	7
Cedar overview .....	9
Example 1: Basic ABAC with Verified Permissions and Cedar .....	10
Example 2: Basic RBAC with Verified Permissions and Cedar .....	16
Example 3: Multi-tenant access control with RBAC .....	19
Example 4: Multi-tenant access control with RBAC and ABAC .....	25
Example 5: UI filtering with Verified Permissions and Cedar .....	29
Using OPA .....	31
Rego overview .....	33
Example 1: Basic ABAC with OPA and Rego .....	34
Example 2: Multi-tenant access control and user-defined RBAC with OPA and Rego .....	38
Example 3: Multi-tenant access control for RBAC and ABAC with OPA and Rego .....	42
Example 4: UI filtering with OPA and Rego .....	44
Using a custom policy engine .....	47
<b>Implementing a PEP</b> .....	<b>48</b>
Requesting an authorization decision .....	48
Evaluating an authorization decision .....	49
<b>Design models for multi-tenant SaaS architectures</b> .....	<b>50</b>
Using Amazon Verified Permissions .....	50
Using a centralized PDP with PEPs on APIs .....	50
Using the Cedar SDK .....	52
Using OPA .....	52
Using a centralized PDP with PEPs on APIs .....	52
Using a distributed PDP with PEPs on APIs .....	55
Using a distributed PDP as a library .....	57

<b>Amazon Verified Permissions multi-tenant design considerations</b> .....	<b>58</b>
Tenant onboarding and user tenant registration .....	59
Per-tenant policy store .....	59
One shared multi-tenant policy store .....	65
Tiered deployment model .....	70
<b>OPA multi-tenant design considerations</b> .....	<b>72</b>
Comparing centralized and distributed deployment patterns .....	72
Tenant isolation with the OPA document model .....	73
Tenant onboarding .....	75
<b>DevOps, monitoring, logging, and retrieving data for a PDP</b> .....	<b>78</b>
Retrieving external data for a PDP in Amazon Verified Permissions .....	79
Retrieving external data for a PDP in OPA .....	81
OPA bundling .....	81
OPA replication (pushing data) .....	81
OPA dynamic data retrieval .....	82
Using an authorization service for implementation with OPA .....	82
Recommendations for tenant isolation and privacy of data .....	83
Amazon Verified Permissions .....	84
OPA .....	84
<b>Best practices</b> .....	<b>85</b>
Select an access control model that works for your application .....	85
Implement a PDP .....	85
Implement PEPs for every API in your application .....	85
Consider using Amazon Verified Permissions or OPA as a policy engine for your PDP .....	85
Implement a control plane for OPA for DevOps, monitoring, and logging .....	86
Configure logging and observability features in Verified Permissions .....	86
Use a CI/CD pipeline to provision and update policy stores and policies in Verified Permissions .....	86
Determine whether external data is required for authorization decisions, and select a model to accommodate it .....	87
<b>FAQ</b> .....	<b>88</b>
<b>Next steps</b> .....	<b>92</b>
<b>Resources</b> .....	<b>93</b>
<b>Document history</b> .....	<b>95</b>
<b>Glossary</b> .....	<b>96</b>
# .....	96

---

A .....	97
B .....	100
C .....	102
D .....	105
E .....	109
F .....	111
G .....	113
H .....	114
I .....	115
L .....	118
M .....	119
O .....	123
P .....	126
Q .....	128
R .....	129
S .....	132
T .....	136
U .....	137
V .....	138
W .....	138
Z .....	139

# Multi-tenant SaaS authorization and API access control: Implementation options and best practices

*Tabby Ward, Thomas Davis, Gideon Landeman, and Tomas Riha, Amazon Web Services (AWS)*

May 2024 ([document history](#))

Authorization and API access control are a challenge for many software applications—in particular, for multi-tenant software as a service (SaaS) applications. This complexity is evident when you consider the proliferation of microservice APIs that must be secured and the large number of access conditions that arise from different tenants, user characteristics, and application states. To address these issues effectively, a solution must enforce access control across the many APIs presented by microservices, Backend for Frontend (BFF) layers, and other components of a multi-tenant SaaS application. This approach must be accompanied by a mechanism that is capable of making complex access decisions based on many factors and attributes.

Traditionally, API access control and authorization were handled by custom logic in the application code. This approach was error prone and not secure, because developers who had access to this code could accidentally or deliberately change authorization logic, which could result in unauthorized access. Auditing the decisions made by custom logic in the application code was difficult, because auditors would have to immerse themselves in the custom logic to determine its effectiveness in upholding any particular standard. Furthermore, API access control was generally unnecessary, because there weren't as many APIs to secure. The paradigm shift in application design to favor microservices and service-oriented architectures has increased the number of APIs that must use a form of authorization and access control. In addition, the need to maintain tenant-based access in a multi-tenant SaaS application presents additional authorization challenges to preserve tenancy. The best practices outlined in this guide provide several benefits:

- Authorization logic can be centralized and written in a high-level declarative language that is not specific to any programming language.
- Authorization logic is abstracted from the application code and can be applied as a repeatable pattern to all APIs in an application.
- The abstraction prevents accidental changes by developers to authorization logic.
- Integration into a SaaS application is consistent and simple.
- The abstraction prevents the need to write custom authorization logic for each API endpoint.

- Audits are simplified, because an auditor no longer needs to review the code to determine permissions.
- The approach outlined in this guide supports the use of multiple access control paradigms depending on the requirements of an organization.
- This authorization and access control approach provides a simple and straightforward way to maintain tenant data isolation at the API layer in a SaaS application.
- The best practices provide a consistent approach to onboarding and offboarding tenants with regard to authorization.
- This approach offers different authorization deployment models (pooled or silo), which have both advantages and disadvantages, as discussed in this guide.

## Targeted business outcomes

This prescriptive guidance describes repeatable design patterns for authorization and API access controls that can be implemented for multi-tenant SaaS applications. This guidance is intended for any team that develops applications with complex authorization requirements or strict API access control needs. The architecture details the creation of a policy decision point (PDP) or policy engine and the integration of policy enforcement points (PEP) in APIs. Two specific options for creating a PDP are discussed: using Amazon Verified Permissions with the Cedar SDK and using the Open Policy Agent (OPA) with the Rego policy language. The guide also discusses making access decisions based upon an attribute-based access control (ABAC) model or role-based access control (RBAC) model, or a combination of both models. We recommend that you use the design patterns and concepts provided in this guide to inform and standardize your implementation of authorization and API access control in multi-tenant SaaS applications. This guidance helps achieve the following business outcomes:

- **Standardized API authorization architecture for multi-tenant SaaS applications** – This architecture distinguishes between three components: the policy administration point (PAP) where policies are stored and managed, the policy decision point (PDP) where those policies are evaluated to reach an authorization decision, and the policy enforcement point (PEP) that enforces that decision. The hosted authorization service, Verified Permissions, serves as both a PAP and a PDP. Alternatively, you can build your PDP yourself by using an open source engine such as Cedar or OPA.
- **Decoupling of authorization logic from applications** – Authorization logic, when embedded in application code or implemented through an ad hoc enforcement mechanism, can be subject

to accidental or malicious changes that cause unintentional cross-tenant data access or other security breaches. To help mitigate these possibilities, you can use a PAP, such as Verified Permissions, to store authorization policies independently of the application code, and to apply strong governance to the management of those policies. Policies can be maintained centrally in a high-level declarative language, which makes maintaining authorization logic far simpler than when you embed policies in multiple sections of application code. This approach also ensures that updates are applied consistently.

- **Flexible approach to access control models** – Role-based access control (RBAC), attribute-based access control (ABAC), or a combination of both models are all valid approaches to access control. These models attempt to meet the authorization requirements for a business by using different approaches. This guide compares and contrasts these models to help you select a model that works for your organization. The guide also discusses how these models apply to different authorization policy languages, such as OPA/Rego and Cedar. The architectures discussed in this guide enable either or both models to be adopted successfully.
- **Strict API access control** – This guide provides a method to secure APIs consistently and pervasively in an application with minimal effort. This is particularly valuable for service-oriented or microservice application architectures that generally use a large number of APIs to facilitate intra-application communications. Strict API access control helps increase the security of an application and makes it less vulnerable to attack or exploitation.

## Tenant isolation and multi-tenant authorization

This guide refers to the concepts of tenant isolation and multi-tenant authorization. *Tenant isolation* refers to explicit mechanisms that you use in a SaaS system to ensure that each tenant's resources, even when they operate on shared infrastructure, are isolated. *Multi-tenant authorization* refers to authorizing inbound actions and preventing them from being implemented on the wrong tenant. A hypothetical user could be authenticated and authorized, and still access the resources of another tenant. Authentication and authorization won't block this access—you need to implement tenant isolation to achieve this objective. For a more extensive discussion of the differences between these two concepts, see the *Tenant isolation* section of the [SaaS Architecture Fundamentals](#) whitepaper.



# Types of access control

You can use two broadly defined models to implement access control: role-based access control (RBAC) and attribute-based access control (ABAC). Each model has advantages and disadvantages, which are briefly discussed in this section. The model you should use depends on your specific use case. The architecture discussed in this guide supports both models.

## RBAC

Role-based access control (RBAC) determines access to resources based on a role that usually aligns with business logic. Permissions are associated with the role as appropriate. For instance, a *marketing* role would authorize a user to perform *marketing* activities within a restricted system. This is a relatively simple access control model to implement because it aligns well to easily recognizable business logic.

The RBAC model is less effective when:

- You have unique users whose responsibilities encompass several roles.
- You have complex business logic that makes roles difficult to define.
- Scaling up to a large size requires constant administration and mapping of permissions to new and existing roles.
- Authorizations are based on dynamic parameters.

## ABAC

Attribute-based access control (ABAC) determines access to resources based on attributes. Attributes can be associated with a user, resource, environment, or even application state. Your policies or rules reference attributes and can use basic Boolean logic to determine whether a user is permitted to perform an action. Here's a basic example of permissions:

*In the payments system, all users in the Finance department are allowed to process payments at the API endpoint /payments during business hours.*

Membership in the Finance department is a user attribute that determines access to /payments. There is also a resource attribute associated with the /payments API endpoint that permits access

only during business hours. In ABAC, whether or not a user can process a payment is determined by a policy that includes the Finance department membership as a user attribute, and the time as a resource attribute of /payments.

The ABAC model is very flexible in allowing dynamic, contextual, and granular authorization decisions. However, the ABAC model is difficult to implement initially. Defining rules and policies as well as enumerating attributes for all relevant access vectors require a significant upfront investment to implement.

## RBAC-ABAC hybrid approach

Combining RBAC and ABAC can provide some of the advantages of both models. RBAC, being aligned so closely to business logic, is simpler to implement than ABAC. To provide an additional layer of granularity when making authorization decisions, you can combine ABAC with RBAC. This hybrid approach determines access by combining a user's role (and its assigned permissions) with additional attributes to make access decisions. Using both models enables simple administration and assignment of permissions while also permitting increased flexibility and granularity pertaining to authorization decisions.

## Access control model comparison

The following table compares the three access control models discussed previously. This comparison is meant to be informative and high-level. Using an access model in a specific situation might not necessarily correlate to the comparisons made in this table.

Factor	RBAC	ABAC	Hybrid
Flexibility	Medium	High	High
Simplicity	High	Low	Medium
Granularity	Low	High	Medium
Dynamic decisions and rules	No	Yes	Yes
Context-aware	No	Yes	Somewhat

**Implementation  
effort**

Low

High

Medium

# Implementing a PDP

The policy decision point (PDP) can be characterized as a policy or rules engine. This component is responsible for applying policies or rules and returning a decision on whether a particular access is permitted. A PDP can function with role-based access control (RBAC) and attribute-based access control (ABAC) models; however, a PDP is a requirement for ABAC. A PDP allows authorization logic in application code to be offloaded to a separate system. This can simplify application code. It also provides an easy-to-use repeatable interface for making authorization decisions for APIs, microservices, Backend for Frontend (BFF) layers, or any other application component.

The following sections discuss three methods for implementing a PDP. However, this is not a complete list.

## PDP implementation methods:

- [Implementing a PDP by using Amazon Verified Permissions](#)
- [Implementing a PDP by using OPA](#)
- [Using a custom policy engine](#)

## Implementing a PDP by using Amazon Verified Permissions

Amazon Verified Permissions is a scalable, fine-grained permissions management and authorization service that you can use to implement a policy decision point (PDP). As a policy engine, it can help your application verify user actions in real time and highlight permissions that are overly privileged or invalid. It helps your developers build more secure applications faster by externalizing authorization and centralizing policy management and administration. By separating authorization logic from application logic, Verified Permissions supports policy decoupling.

By using Verified Permissions to implement a PDP and implementing least privilege and continual verification within applications, developers can align their application access with [Zero Trust](#) principles. Additionally, security and audit teams can better analyze and audit who has access to which resources within an application. Verified Permissions uses [Cedar](#), which is a purpose-built and security-first, open source policy language, to define policy-based access controls based on role-based access control (RBAC) and attribute-based access control (ABAC) for more granular, context-aware access control.

Verified Permissions provides some useful features for SaaS applications, such as the ability to enable multi-tenant authorization by using multiple identity providers such as Amazon Cognito, Google, and Facebook. Another Verified Permissions feature that is particularly helpful for SaaS applications is support for custom roles on a per-tenant basis. If you're designing a customer relationship management (CRM) system, one tenant might define granularity of access by sales opportunities based on one particular set of criteria. Another tenant might have another definition. The underlying permissions systems in Verified Permissions can support these variations, which makes it an excellent candidate for SaaS use cases. Verified Permissions also supports the ability to write policies that apply to all tenants, so it is straightforward to apply guardrail policies to prevent unauthorized access as a SaaS provider.

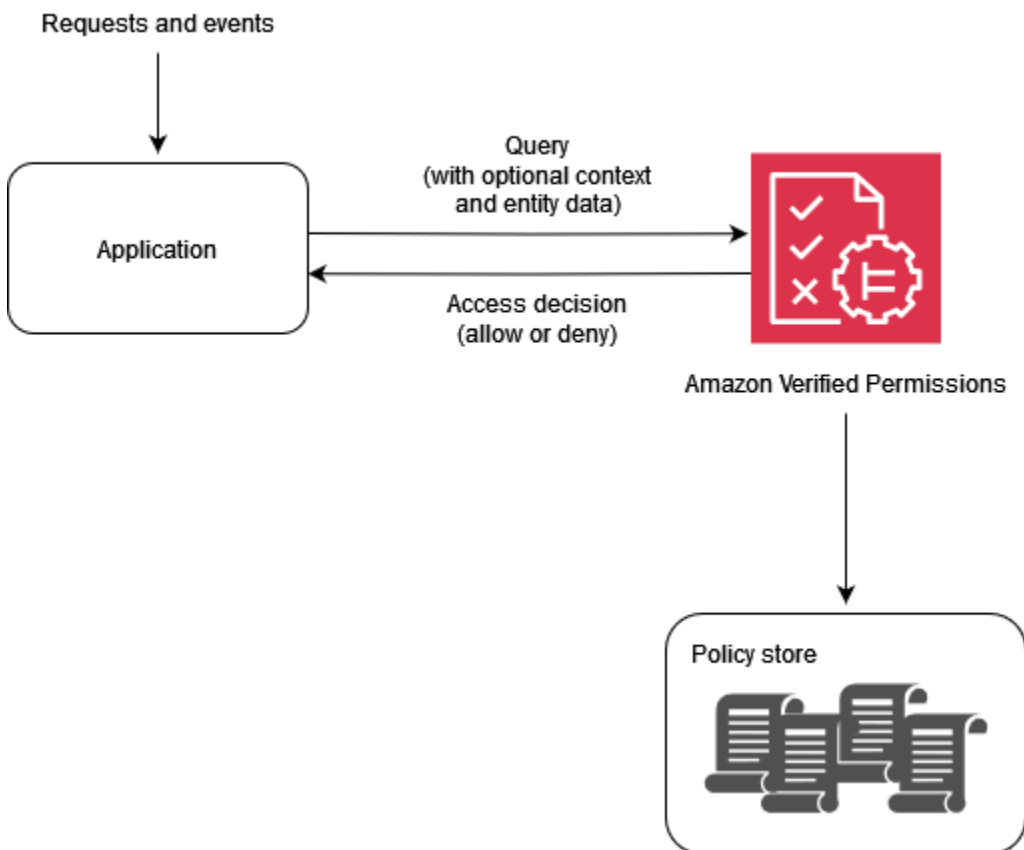

## Why use Verified Permissions?

Use Verified Permissions with an identity provider such as [Amazon Cognito](#) for a more dynamic, policy-based access management solution for your applications. You can build applications that help users share information and collaborate while maintaining the security, confidentiality, and privacy of their data. Verified Permissions helps reduce operational costs by providing you with a fine-grained authorization system to enforce access based on the roles and attributes of your

identities and resources. You can define your policy model, create and store policies in a central location, and evaluate access requests in milliseconds.

In Verified Permissions, you can express permissions by using a simple, human-readable declarative language called Cedar. Policies that are written in Cedar can be shared across teams regardless of the programming language used by each team's application.

## What to consider when you use Verified Permissions

In Verified Permissions, you can create policies and automate them as part of provisioning. You can also create policies at runtime as part of application logic. As a best practice, you should use a continuous integration and continuous deployment (CI/CD) pipeline to administer, modify, and track policy versions when you create policies as part of tenant onboarding and provisioning. Alternatively, an application can administer, modify, and track policy versions; however, application logic doesn't inherently perform this functionality. To support these capabilities in your application, you must explicitly design your application to implement this functionality.

If it's necessary to provide external data from other sources to reach an authorization decision, this data must be retrieved and provided to Verified Permissions as part of the authorization request. Additional context, entities, and attributes are not retrieved by default with this service.

## Cedar overview

Cedar is a flexible, extensible, and scalable policy-based access control language that helps developers express application permissions as policies. Administrators and developers can define policies that permit or forbid users to act on application resources. Multiple policies can be attached to a single resource. When a user of your application tries to perform an action on a resource, your application requests authorization from the Cedar policy engine. Cedar evaluates the applicable policies and returns an ALLOW or DENY decision. Cedar supports authorization rules for any type of principal and resource, allows for role-based access control (RBAC) and attribute-based access control (ABAC), and supports analysis through automated reasoning tools.

Cedar lets you separate your business logic from the authorization logic. When you make requests from your application's code, you call Cedar's authorization engine to determine whether the request is authorized. If it's authorized (the decision is ALLOW), your application can perform the requested operation. If it isn't authorized (the decision is DENY), your application can return an error message. Major features of Cedar include:

- **Expressiveness** – Cedar is purpose-built to support authorization use cases and was developed with human readability in mind.
- **Performance** – Cedar supports indexing policies for quick retrieval, and provides fast and scalable real-time evaluation with bounded latency.
- **Analysis** – Cedar supports analysis tools that can optimize your policies and verify your security model.

For more information, see the [Cedar website](#).

## Example 1: Basic ABAC with Verified Permissions and Cedar

In this example scenario, Amazon Verified Permissions is used to determine which users are allowed to access information in a fictional Payroll microservice. This section includes Cedar code snippets to demonstrate how you can use Cedar to render access control decisions. These examples aren't intended to provide a full exploration of the capabilities provided by Cedar and Verified Permissions. For a more thorough overview of Cedar, see the [Cedar documentation](#).

In the following diagram, we would like to enforce two general business rules that are associated with the `viewSalary` GET method: *Employees can view their own salary* and *Employees can view the salary of anyone who reports to them*. You can enforce these business rules by using Verified Permissions policies.

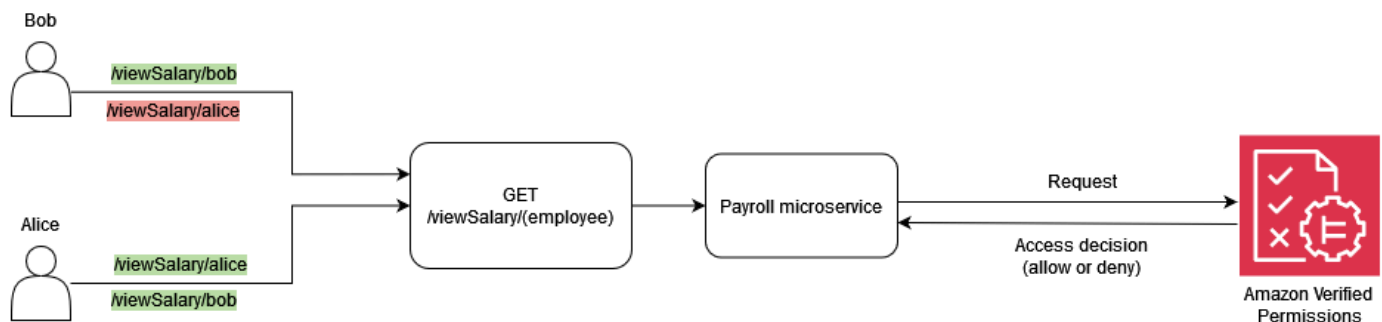

*Employees can view their own salary.*

In Cedar, the basic construct is an *entity*, which represents a principal, action, or a resource. To make an authorization request and start an evaluation with a Verified Permissions policy, you need to provide a *principal*, an *action*, a *resource*, and a *list of entities*.

- The principal (`principal`) is the logged in user or role.
- The action (`action`) is the operation that is evaluated by the request.

- The resource (`resource`) is the component that the action is accessing.
- The list of entities (`entityList`) contains all the required entities needed to evaluate the request.

To satisfy the business rule *Employees can view their own salary*, you can provide a Verified Permissions policy such as the following.

```
permit (  
    principal,  
    action == Action::"viewSalary",  
    resource  
)  
when {  
    principal == resource.owner  
};
```

This policy evaluates to ALLOW if the Action is `viewSalary` and the resource in the request has an attribute `owner` that is equal to the principal. For example, if Bob is the logged in user who requested the salary report and is also the owner of the salary report, the policy evaluates to ALLOW.

The following authorization request is submitted to Verified Permissions to be evaluated by the sample policy. In this example, Bob is the logged in user who makes the `viewSalary` request. Therefore, Bob is the principal of the entity type `Employee`. The action Bob is trying to perform is `viewSalary`, and the resource that `viewSalary` will display is `Salary-Bob` with the type `Salary`. In order to evaluate if Bob can view the `Salary-Bob` resource, you need to provide an entity structure that links the type `Employee` with a value of Bob (the principal) to the `owner` attribute of the resource that has the type `Salary`. You provide this structure in an `entityList`, where the attributes associated with `Salary` include an `owner`, which specifies an `entityIdentifier` that contains the type `Employee` and value Bob. Verified Permissions compares the `principal` provided in the authorization request to the `owner` attribute that is associated with the `Salary` resource to make a decision.

```
{  
  "policyStoreId": "PAYROLLAPP_POLICYSTOREID",  
  "principal": {  
    "entityType": "PayrollApp::Employee",  
    "entityId": "Bob"  }}
```



```
},
"action": {
  "actionType": "PayrollApp::Action",
  "actionId": "viewSalary"
},
"resource": {
  "entityType": "PayrollApp::Salary",
  "entityId": "Salary-Bob"
},
"entities": {
  "entityList": [
    {
      "identifier": {
        "entityType": "PayrollApp::Salary",
        "entityId": "Salary-Bob"
      },
      "attributes": {
        "owner": {
          "entityIdentifier": {
            "entityType": "PayrollApp::Employee",
            "entityId": "Bob"
          }
        }
      }
    },
    {
      "identifier": {
        "entityType": "PayrollApp::Employee",
        "entityId": "Bob"
      },
      "attributes": {}
    }
  ]
}
}
```

The authorization request to Verified Permissions returns the following as output, where the attribute decision is either ALLOW or DENY.

```
{
  "determiningPolicies":
    [
      {
```

```
        "determiningPolicyId": "PAYROLLAPP_POLICystoreID"
      }
    ],
    "decision": "ALLOW",
    "errors": []
  }
```

In this case, because Bob was trying to view his own salary, the authorization request sent to Verified Permissions evaluates to `ALLOW`. However, our objective was to use Verified Permissions to enforce two business rules. The business rule that states the following should also be true:

*Employees can view the salary of anyone who reports to them.*

To satisfy this business rule, you can provide another policy. The following policy evaluates to `ALLOW` if the action is `viewSalary` and the resource in the request has an attribute `owner.manager` that is equal to the principal. For example, if Alice is the logged in user who requested the salary report and Alice is the manager of the report's owner, the policy evaluates to `ALLOW`.

```
permit (
  principal,
  action == Action::"viewSalary",
  resource
)
when {
  principal == resource.owner.manager
};
```

The following authorization request is submitted to Verified Permissions to be evaluated by the sample policy. In this example, Alice is the logged in user who makes the `viewSalary` request. Therefore Alice is the principal and the entity is of the type `Employee`. The action Alice is trying to perform is `viewSalary`, and the resource that `viewSalary` will display is of the type `Salary` with a value of `Salary-Bob`. In order to evaluate if Alice can view the `Salary-Bob` resource, you need to provide an entity structure that links the type `Employee` with a value of `Alice` to the `manager` attribute, which must then be associated with the `owner` attribute of the type `Salary` with a value of `Salary-Bob`. You provide this structure in an `entityList`, where the attributes associated with `Salary` include an `owner`, which specifies an `entityIdentifier` that contains the type `Employee` and value `Bob`. Verified Permissions first checks the `owner` attribute, which evaluates to the type `Employee` and the value `Bob`. Then, Verified Permissions evaluates the

manager attribute that's associated with Employee and compares it to the provided principal to make an authorization decision. In this case, the decision is ALLOW because the principal and resource.owner.manager attributes are equivalent.

```
{
  "policyStoreId": "PAYROLLAPP_POLICYSTOREID",
  "principal": {
    "entityType": "PayrollApp::Employee",
    "entityId": "Alice"
  },
  "action": {
    "actionType": "PayrollApp::Action",
    "actionId": "viewSalary"
  },
  "resource": {
    "entityType": "PayrollApp::Salary",
    "entityId": "Salary-Bob"
  },
  "entities": {
    "entityList": [
      {
        "identifier": {
          "entityType": "PayrollApp::Employee",
          "entityId": "Alice"
        },
        "attributes": {
          "manager": {
            "entityIdentifier": {
              "entityType": "PayrollApp::Employee",
              "entityId": "None"
            }
          }
        }
      },
      {
        "parents": []
      }
    ],
    {
      "identifier": {
        "entityType": "PayrollApp::Salary",
        "entityId": "Salary-Bob"
      },
      "attributes": {
        "owner": {
          "entityIdentifier": {
```

```
        "entityType": "PayrollApp::Employee",
        "entityId": "Bob"
      }
    },
    "parents": []
  },
  {
    "identifier": {
      "entityType": "PayrollApp::Employee",
      "entityId": "Bob"
    },
    "attributes": {
      "manager": {
        "entityIdentifier": {
          "entityType": "PayrollApp::Employee",
          "entityId": "Alice"
        }
      }
    },
    "parents": []
  }
]
}
```

So far in this example, we provided the two business rules associated with the `viewSalary` method, *Employees can view their own salary* and *Employees can view the salary of anyone who reports to them*, to Verified Permissions as policies to satisfy the conditions of each business rule independently. You can also use a single Verified Permissions policy to satisfy the conditions of both business rules:

*Employees can view their own salary and the salary of anyone who reports to them.*

When you use the previous authorization request, the following policy evaluates to `ALLOW` if the action is `viewSalary` and the resource in the request has an attribute `owner.manager` that is equal to the `principal`, or an attribute `owner` that is equal to the `principal`.

```
permit (
  principal,
  action == PayrollApp::Action::"viewSalary",
  resource
```

```

)
when {
  principal == resource.owner.manager ||
  principal == resource.owner
};

```

For example, if Alice is the logged in user who requests the salary report, and if Alice is either the manager of the owner or the owner of the report, then the policy evaluates to ALLOW.

For more information about using logical operators with Cedar policies, see the [Cedar documentation](#).

## Example 2: Basic RBAC with Verified Permissions and Cedar

This example uses Verified Permissions and Cedar to demonstrate basic RBAC. As mentioned previously, Cedar's basic construct is an entity. Developers define their own entities and can optionally create relationships between entities. The following example includes three type of entities: Users, Roles, and Problems. Students and Teachers can be considered entities of the type Role, and each User can be associated with zero or any of the Roles.

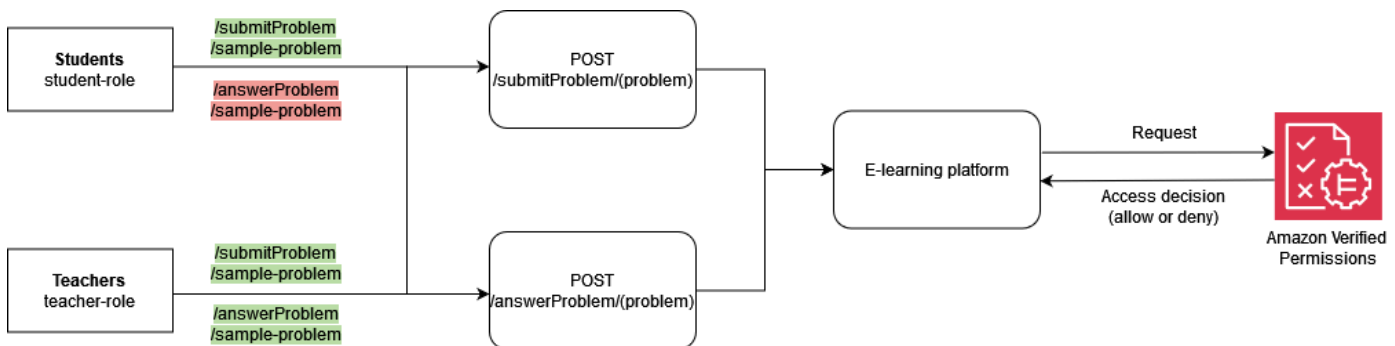

In Cedar, these relationships are expressed by linking the Role Student to the User Bob as its parent. This association logically groups all the student users in one group. For more information about grouping in Cedar, see the [Cedar documentation](#).

The following policy evaluates to the decision ALLOW for the action submitProblem, for all principals that are linked to the logical group Students of the type Role.

```

permit (
  principal in ElearningApp::Role::"Students",
  action == ElearningApp::Action::"submitProblem",
  resource

```

```
);
```

The following policy evaluates to the decision `ALLOW` for the action `submitProblem` or `answerProblem`, for all principals that are linked to the logical group `Teachers` of the type `Role`.

```
permit (  
  principal in ElearningApp::Role::"Teachers",  
  action in [  
    ElearningApp::Action::"submitProblem",  
    ElearningApp::Action::"answerProblem"  
  ],  
  resource  
);
```

In order to evaluate requests with these policies, the evaluation engine needs to know whether the principal referenced within the authorization request is a member of the appropriate group. Therefore, the application has to pass relevant group membership information to the evaluation engine as part of the authorization request. This is done through the `entities` property, which enables you to provide the Cedar evaluation engine with attribute and group membership data for the principal and resource involved in the authorization call. In the following code, group membership is indicated by defining `User::"Bob"` as having a parent called `Role::"Students"`.

```
{  
  "policyStoreId": "ELEARNING_POLICYSTOREID",  
  "principal": {  
    "entityType": "ElearningApp::User",  
    "entityId": "Bob"  
  },  
  "action": {  
    "actionType": "ElearningApp::Action",  
    "actionId": "answerProblem"  
  },  
  "resource": {  
    "entityType": "ElearningApp::Problem",  
    "entityId": "SomeProblem"  
  },  
  "entities": {  
    "entityList": [  
      {  
        "identifier": {  
          "entityType": "ElearningApp::User",
```

```

        "entityId": "Bob"
    },
    "attributes": {},
    "parents": [
        {
            "entityType": "ElearningApp::Role",
            "entityId": "Students"
        }
    ]
},
{
    "identifier": {
        "entityType": "ElearningApp::Problem",
        "entityId": "SomeProblem"
    },
    "attributes": {},
    "parents": []
}
]
}
}

```

In this example, Bob is the logged in user who makes the `answerProblem` request. Therefore, Bob is the principal and the entity is of the type `User`. The action Bob is trying to perform is `answerProblem`. In order to evaluate if Bob can perform the `answerProblem` action, you need to provide an entity structure that links the entity `User` with a value of Bob and assigns his group membership by listing a parent entity as `Role::"Students"`. Because entities in the user group `Role::"Students"` are allowed only to perform the action `submitProblem`, this authorization request evaluates to DENY.

On the other hand, if the type `User` that has a value of Alice and is a part of the group `Role::"Teachers"` tries to perform the `answerProblem` action, the authorization request evaluates to ALLOW, because the policy dictates that principals in the group `Role::"Teachers"` are allowed to perform the action `answerProblem` on all resources. The following code shows this type of authorization request that evaluates to ALLOW.

```

{
    "policyStoreId": "ELEARNING_POLICYSTOREID",
    "principal": {
        "entityType": "ElearningApp::User",
        "entityId": "Alice"
    }
}

```

```
},
"action": {
  "actionType": "ElearningApp::Action",
  "actionId": "answerProblem"
},
"resource": {
  "entityType": "ElearningApp::Problem",
  "entityId": "SomeProblem"
},
"entities": {
  "entityList": [
    {
      "identifier": {
        "entityType": "ElearningApp::User",
        "entityId": "Alice"
      },
      "attributes": {},
      "parents": [
        {
          "entityType": "ElearningApp::Role",
          "entityId": "Teachers"
        }
      ]
    },
    {
      "identifier": {
        "entityType": "ElearningApp::Problem",
        "entityId": "SomeProblem"
      },
      "attributes": {},
      "parents": []
    }
  ]
}
}
```

### Example 3: Multi-tenant access control with RBAC

To elaborate on the previous RBAC example, you can expand your requirements to include SaaS multi-tenancy, which is a common requirement for SaaS providers. In multi-tenant solutions, resource access is always provided on behalf of a given tenant. That is, users of Tenant A cannot view the data of Tenant B, even if that data is logically or physically collocated in a system. The



following example illustrates how you can implement tenant isolation by using multiple [Verified Permissions policy stores](#), and how you can employ user roles to define permissions within the tenant.

Using the Per Tenant Policy Store design pattern is a best practice for maintaining tenant isolation while implementing access control with Verified Permissions. In this scenario, Tenant A and Tenant B user requests are verified against separate policy stores, `DATAMICROSERVICE_POLICystore_A` and `DATAMICROSERVICE_POLICystore_B`, respectively. For more information about Verified Permissions design considerations for multi-tenant SaaS applications, see the [Verified Permissions multi-tenant design considerations](#) section.

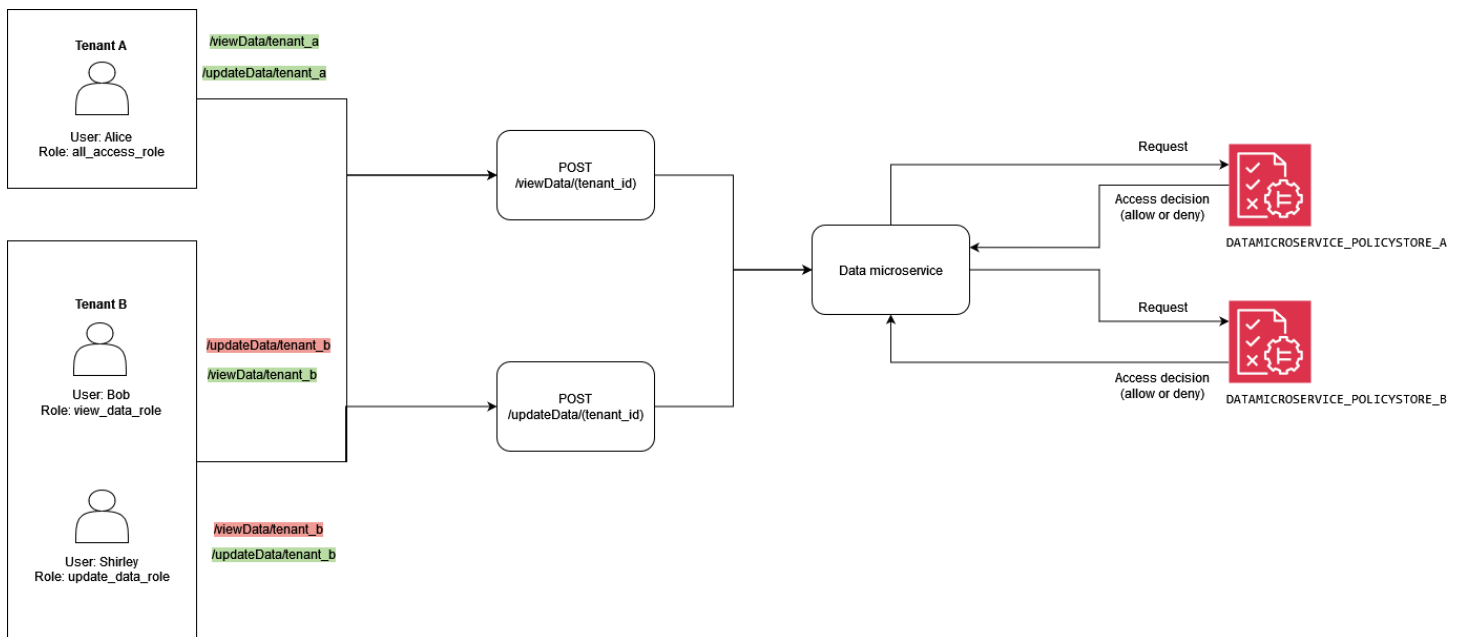

The following policy resides in the `DATAMICROSERVICE_POLICystore_A` policy store. It verifies that the principal will be a part of the group `allAccessRole` of type `Role`. In this case, the principal will be allowed to perform the `viewData` and `updateData` actions on all resources that are associated with Tenant A.

```
permit (
  principal in MultitenantApp::Role::"allAccessRole",
  action in [
    MultitenantApp::Action::"viewData",
    MultitenantApp::Action::"updateData"
  ],
  resource
);
```

The following policies reside in the `DATAMICROSERVICE_POLICystore_B` policy store. The first policy verifies that the principal is part of the `updateDataRole` group of type `Role`. Assuming that is the case, it gives permission to principals to perform the `updateData` action on resources that are associated with Tenant B.

```
permit (  
    principal in MultitenantApp::Role:"updateDataRole",  
    action == MultitenantApp::Action:"updateData",  
    resource  
);
```

This second policy mandates that principals that are a part of the `viewDataRole` group of type `Role` should be allowed to perform the `viewData` action on resources that are associated with Tenant B.

```
permit (  
    principal in MultitenantApp::Role:"viewDataRole",  
    action == MultitenantApp::Action:"viewData",  
    resource  
);
```

The authorization request made from Tenant A needs to be sent to the `DATAMICROSERVICE_POLICystore_A` policy store and verified by the policies that belong to that store. In this case, it's verified by the first policy discussed earlier as part of this example. In this authorization request, the principal of type `User` with a value of `Alice` is requesting to perform the `viewData` action. The principal belongs to the group `allAccessRole` of type `Role`. Alice is trying to perform the `viewData` action on the `SampleData` resource. Because Alice has the `allAccessRole` role, this evaluation results in an `ALLOW` decision.

```
{  
  "policyStoreId": "DATAMICROSERVICE_POLICystore_A",  
  "principal": {  
    "entityType": "MultitenantApp::User",  
    "entityId": "Alice"  
  },  
  "action": {  
    "actionType": "MultitenantApp::Action",  
    "actionId": "viewData"  
  },  
  "resource": {
```

```
    "entityType": "MultitenantApp::Data",
    "entityId": "SampleData"
  },
  "entities": {
    "entityList": [
      {
        "identifier": {
          "entityType": "MultitenantApp::User",
          "entityId": "Alice"
        },
        "attributes": {},
        "parents": [
          {
            "entityType": "MultitenantApp::Role",
            "entityId": "allAccessRole"
          }
        ]
      },
      {
        "identifier": {
          "entityType": "MultitenantApp::Data",
          "entityId": "SampleData"
        },
        "attributes": {},
        "parents": []
      }
    ]
  }
}
```

If, instead, you view a request made from Tenant B by User Bob, you will see something like the following authorization request. The request is sent to the `DATAMICROSERVICE_POLICYSTORE_B` policy store because it originates from Tenant B. In this request, the principal Bob wants to perform the action `updateData` on the resource `SampleData`. However, Bob is not a part of a group that has access to the action `updateData` on that resource. Therefore, the request results in a DENY decision.

```
{
  "policyStoreId": "DATAMICROSERVICE_POLICYSTORE_B",
  "principal": {
    "entityType": "MultitenantApp::User",
    "entityId": "Bob"
  }
}
```

```

},
"action": {
  "actionType": "MultitenantApp::Action",
  "actionId": "updateData"
},
"resource": {
  "entityType": "MultitenantApp::Data",
  "entityId": "SampleData"
},
"entities": {
  "entityList": [
    {
      "identifier": {
        "entityType": "MultitenantApp::User",
        "entityId": "Bob"
      },
      "attributes": {},
      "parents": [
        {
          "entityType": "MultitenantApp::Role",
          "entityId": "viewDataRole"
        }
      ]
    },
    {
      "identifier": {
        "entityType": "MultitenantApp::Data",
        "entityId": "SampleData"
      },
      "attributes": {},
      "parents": []
    }
  ]
}
}
}

```

In this third example, User `Alice` tries to perform the `viewData` action on the resource `SampleData`. This request is directed to the `DATAMICROSERVICE_POLICYSTORE_A` policy store because the principal `Alice` belongs to Tenant A. `Alice` is a part of the group `allAccessRole` of the type `Role`, which permits her to perform the `viewData` action on resources. As such, the request results in an `ALLOW` decision.

```
{
  "policyStoreId": "DATAMICROSERVICE_POLICystore_A",
  "principal": {
    "entityType": "MultitenantApp::User",
    "entityId": "Alice"
  },
  "action": {
    "actionType": "MultitenantApp::Action",
    "actionId": "viewData"
  },
  "resource": {
    "entityType": "MultitenantApp::Data",
    "entityId": "SampleData"
  },
  "entities": {
    "entityList": [
      {
        "identifier": {
          "entityType": "MultitenantApp::User",
          "entityId": "Alice"
        },
        "attributes": {},
        "parents": [
          {
            "entityType": "MultitenantApp::Role",
            "entityId": "allAccessRole"
          }
        ]
      },
      {
        "identifier": {
          "entityType": "MultitenantApp::Data",
          "entityId": "SampleData"
        },
        "attributes": {},
        "parents": []
      }
    ]
  }
}
```

## Example 4: Multi-tenant access control with RBAC and ABAC

To enhance the RBAC example in the previous section, you can add attributes to users to create a RBAC-ABAC hybrid approach for multi-tenant access control. This example includes the same roles from the previous example, but adds the user attribute `account_lockout_flag` and the context parameter `uses_mfa`. The example also takes a different approach to implementing multi-tenant access control by using both RBAC and ABAC, and uses one shared policy store instead of a different policy store for each tenant.

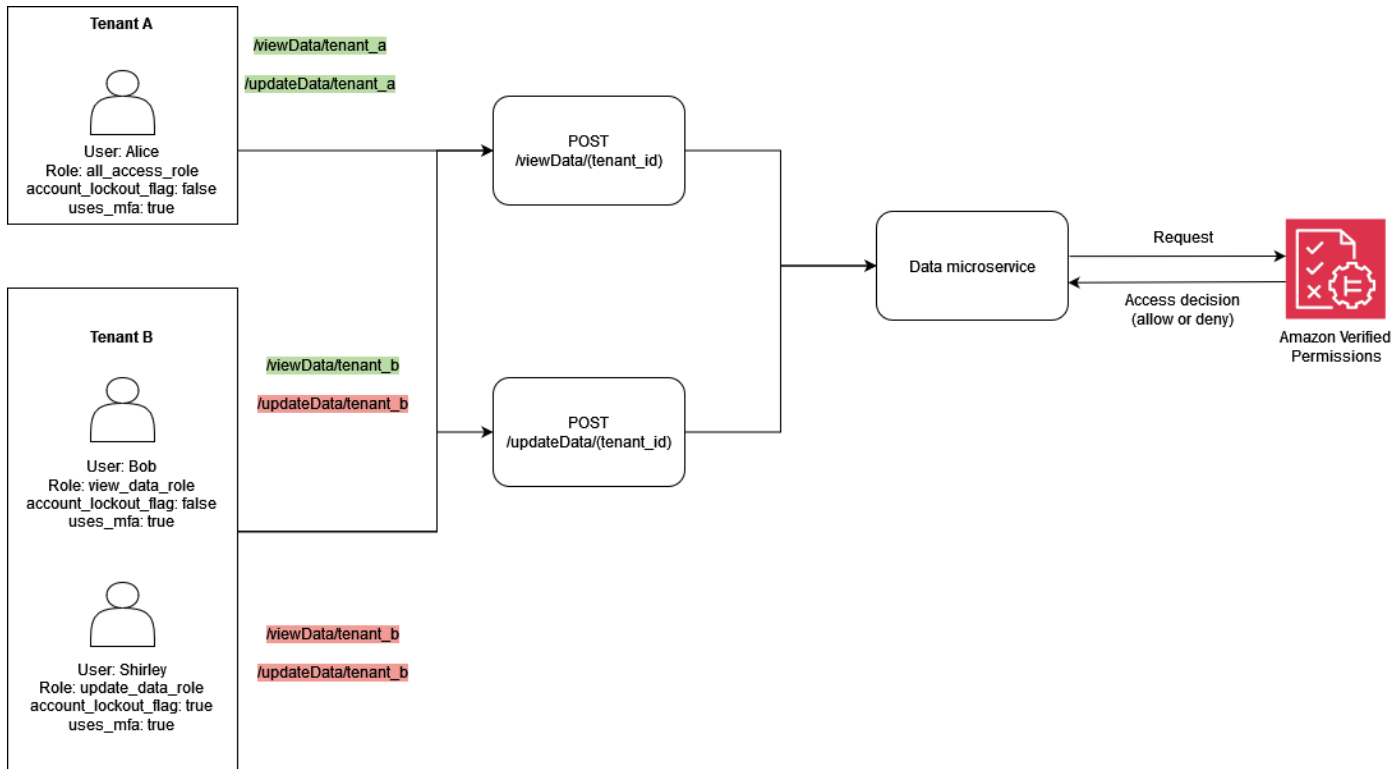

This example represents a multi-tenant SaaS solution in which you need to provide authorization decisions for Tenant A and Tenant B, similar to the previous example.

To implement the user lock feature, the example adds the attribute `account_lockout_flag` to the `User` entity principal in the authorization request. This flag locks user access to the system and will DENY all privileges to the locked out user. The `account_lockout_flag` attribute is associated with the `User` entity and is in effect for the `User` until the flag is actively revoked across multiple sessions. The example uses the `when` condition to evaluate `account_lockout_flag`.

The example also adds details about the request and session. The context information specifies that the session has been authenticated by using multi-factor authentication. To implement this validation, the example uses the `when` condition to evaluate the `uses_mfa` flag as part of

the context field. For more information about best practices for adding context, see the [Cedar documentation](#).

```
permit (  
  principal in MultitenantApp::Role::"allAccessRole",  
  action in [  
    MultitenantApp::Action::"viewData",  
    MultitenantApp::Action::"updateData"  
  ],  
  resource  
)  
when {  
  principal.account_lockout_flag == false &&  
  context.uses_mfa == true &&  
  resource in principal.Tenant  
};
```

This policy prevents access to resources unless the resource is in the same group as the requesting principal's Tenant attribute. This approach to maintaining tenant isolation is referred to as the *One Shared Multi-Tenant Policy Store* approach. For more information about Verified Permissions design considerations for multi-tenant SaaS applications, see the [Verified Permissions multi-tenant design considerations](#) section.

The policy also ensures that the principal is a member of `allAccessRole` and restricts actions to `viewData` and `updateData`. Additionally, this policy verifies that `account_lockout_flag` is false and that the context value for `uses_mfa` evaluates to true.

Similarly, the following policy ensures that both the principal and resource are associated with the same tenant, which prevents cross-tenant access. This policy also ensures that the principal is a member of `viewDataRole` and restricts actions to `viewData`. Additionally, it verifies that the `account_lockout_flag` is false and that the context value for `uses_mfa` evaluates to true.

```
permit (  
  principal in MultitenantApp::Role::"viewDataRole",  
  action == MultitenantApp::Action::"viewData",  
  resource  
)  
when {  
  principal.account_lockout_flag == false &&  
  context.uses_mfa == true &&  
  resource in principal.Tenant  
};
```

```
};
```

The third policy is similar to the previous one. The policy requires the resource to be a member of the group that corresponds to the entity that's represented by `principal.Tenant`. This ensures that both the principal and resource are associated with Tenant B, which prevents cross-tenant access. This policy ensures that the principal is a member of `updateDataRole` and restricts actions to `updateData`. Additionally, this policy verifies that the `account_lockout_flag` is false and that the context value for `uses_mfa` evaluates to true.

```
permit (
  principal in MultitenantApp::Role::"updateDataRole",
  action == MultitenantApp::Action::"updateData",
  resource
)
when {
  principal.account_lockout_flag == false &&
  context.uses_mfa == true &&
  resource in principal.Tenant
};
```

The following authorization request is evaluated by the three policies discussed earlier in this section. In this authorization request, the principal of type `User` and with a value of `Alice` makes an `updateData` request with the role `allAccessRole`. Alice has the attribute `Tenant` whose value is `Tenant::"TenantA"`. The action Alice is trying to perform is `updateData`, and the resource it will be applied to is `SampleData` of the type `Data`. `SampleData` has `TenantA` as a parent entity.

According to the first policy in the `<DATAMICROSERVICE_POLICYSTOREID>` policy store, Alice can perform the `updateData` action on the resource, assuming that the conditions in the `when` clause of the policy are met. The first condition requires the `principal.Tenant` attribute to evaluate to `TenantA`. The second condition requires the principal's attribute `account_lockout_flag` to be false. The final condition requires the context `uses_mfa` to be true. Because all three conditions are met, the request returns an `ALLOW` decision.

```
{
  "policyStoreId": "DATAMICROSERVICE_POLICYSTORE",
  "principal": {
    "entityType": "MultitenantApp::User",
    "entityId": "Alice"
```



```
},
"action": {
  "actionType": "MultitenantApp::Action",
  "actionId": "updateData"
},
"resource": {
  "entityType": "MultitenantApp::Data",
  "entityId": "SampleData"
},
"context": {
  "contextMap": {
    "uses_mfa": {
      "boolean": true
    }
  }
},
"entities": {
  "entityList": [
    {
      "identifier": {
        "entityType": "MultitenantApp::User",
        "entityId": "Alice"
      },
      "attributes": {
        {
          "account_lockout_flag": {
            "boolean": false
          },
          "Tenant": {
            "entityIdentifier": {
              "entityType": "MultitenantApp::Tenant",
              "entityId": "TenantA"
            }
          }
        }
      }
    },
    {
      "parents": [
        {
          "entityType": "MultitenantApp::Role",
          "entityId": "allAccessRole"
        }
      ]
    }
  ],
}
```

```
{
  "identifier": {
    "entityType": "MultitenantApp::Data",
    "entityId": "SampleData"
  },
  "attributes": {},
  "parents": [
    {
      "entityType": "MultitenantApp::Tenant",
      "entityId": "TenantA"
    }
  ]
}
```

## Example 5: UI filtering with Verified Permissions and Cedar

You can also use Verified Permissions to implement RBAC filtering of UI elements based on authorized actions. This is extremely valuable for applications that have context-sensitive UI elements that might be associated with specific users or tenants in the case of a multi-tenant SaaS application.

In the following example, Users of the Role `viewer` are not allowed to perform updates. For these users, the UI should not render any update buttons.

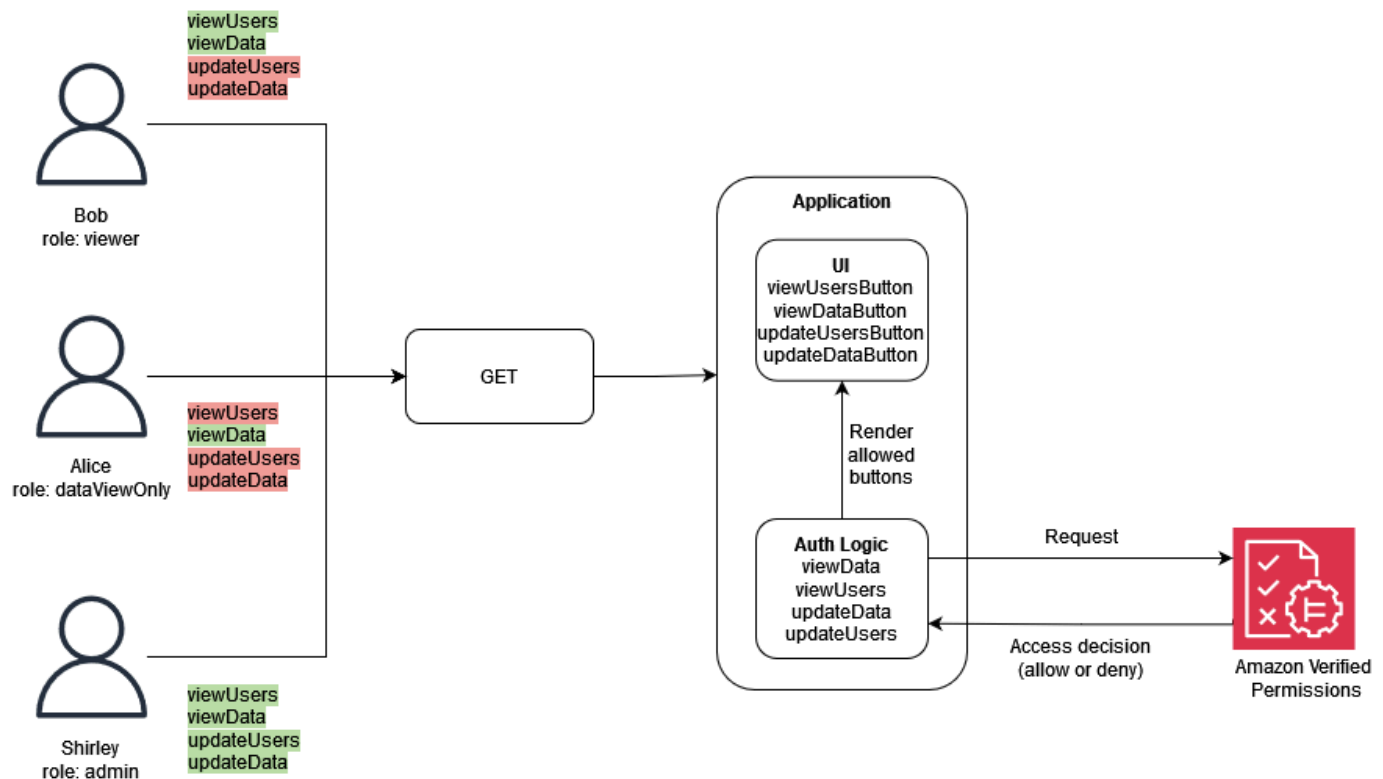

In this example, a single-page web application has four buttons. Which buttons are visible depends on the Role of the user who is currently logged in to the application. As the single-page web application renders the UI, it queries Verified Permissions to determine which actions the user is authorized to perform, and then generates the buttons based on the authorization decision.

The following policy specifies that the type Role with a value of viewer can view both users and data. An ALLOW authorization decision for this policy requires a viewData or viewUsers action, and also requires a resource to be associated with the type Data or Users. An ALLOW decision permits the UI to render two buttons: viewDataButton and viewUsersButton.

```
permit (
  principal in GuiAPP::Role::"viewer",
  action in [GuiAPP::Action::"viewData", GuiAPP::Action::"viewUsers"],
  resource
)
when {
  resource in [GuiAPP::Type::"Data", GuiAPP::Type::"Users"]
};
```

The following policy specifies that the type Role with a value of viewerDataOnly can only view data. An ALLOW authorization decision for this policy requires a viewData action, and also requires

a resource to be associated with the type `Data`. An `ALLOW` decision permits the UI to render the button `viewDataButton`.

```
permit (  
  principal in GuiApp::Role::"viewerDataOnly",  
  action in [GuiApp::Action::"viewData"],  
  resource in [GuiApp::Type::"Data"]  
);
```

The following policy specifies that the type `Role` with a value of `admin` can edit and view data and users. An `ALLOW` authorization decision for this policy requires an action of `updateData`, `updateUsers`, `viewData`, or `viewUsers`, and also requires a resource to be associated with the type `Data` or `Users`. An `ALLOW` decision permits the UI to render all four buttons: `updateDataButton`, `updateUsersButton`, `viewDataButton`, and `viewUsersButton`.

```
permit (  
  principal in GuiApp::Role::"admin",  
  action in [  
    GuiApp::Action::"updateData",  
    GuiApp::Action::"updateUsers",  
    GuiApp::Action::"viewData",  
    GuiApp::Action::"viewUsers"  
  ],  
  resource  
)  
when {  
  resource in [GuiApp::Type::"Data", GuiApp::Type::"Users"]  
};
```

## Implementing a PDP by using OPA

The Open Policy Agent (OPA) is an open-source, general-purpose policy engine. OPA has many use cases, but the use case relevant for PDP implementation is its ability to decouple authorization logic from an application. This is called *policy decoupling*. OPA is useful in implementing a PDP for several reasons. It uses a high-level declarative language called Rego to draft policies and rules. These policies and rules exist separately from an application and can render authorization decisions without any application-specific logic. OPA also exposes a RESTful API to make retrieving authorization decisions simple and straightforward. To make an authorization decision, an application queries OPA with JSON input, and OPA evaluates the input against the specified

policies to return an access decision in JSON. OPA is also capable of importing external data that might be relevant in making an authorization decision.

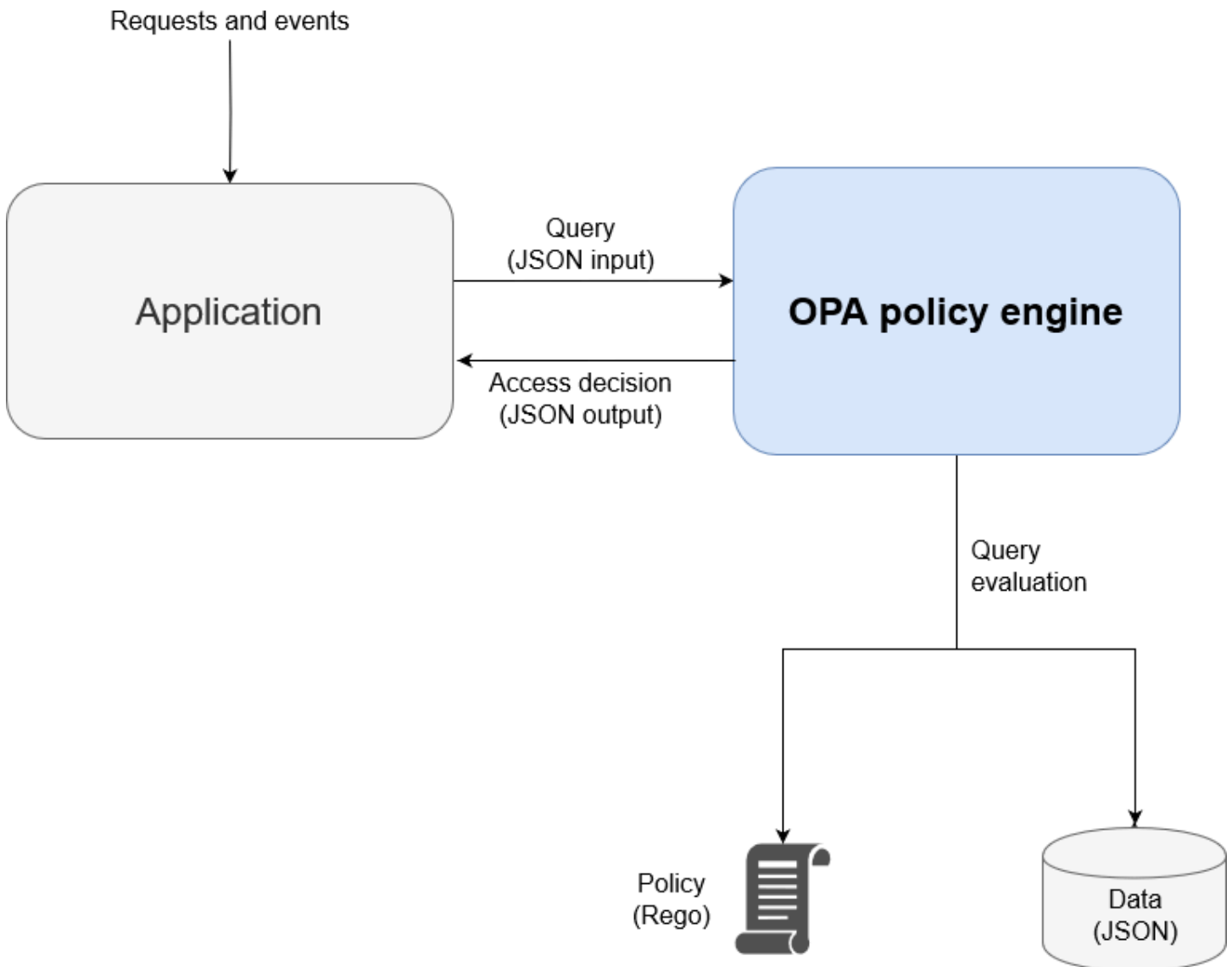

OPA has several advantages over custom policy engines:

- OPA and its policy evaluation with Rego provide a flexible, pre-built policy engine that requires only the insertion of policies and any data necessary to make authorization decisions. This policy evaluation logic would have to be recreated in a custom policy engine solution.
- OPA simplifies authorization logic by having policies written in a declarative language. You can modify and administer these policies and rules independently of any application code, without application development skills.
- OPA exposes a RESTful API, which simplifies integration with policy enforcement points (PEPs).

- OPA provides built-in support for validating and decoding JSON Web Tokens (JWTs).
- OPA is a recognized authorization standard, which means that documentation and examples are plentiful if you need assistance or research to solve a particular problem.
- Adopting an authorization standard such as OPA allows policies written in Rego to be shared across teams regardless of the programming language used by a team's application.

There are two things that OPA doesn't provide automatically:

- OPA doesn't have a robust control plane for updating and managing policies. OPA does provide some basic patterns for implementing policy updates, monitoring, and log aggregation by exposing a management API, but integration with this API must be handled by the OPA user. As a best practice, you should use a continuous integration and continuous deployment (CI/CD) pipeline to administer, modify, and track policy versions and manage policies in OPA.
- OPA can't retrieve data from external sources by default. An external source of data for an authorization decision could be a database that holds user attributes. There is some flexibility in how external data is provided to OPA – it can be cached locally in advance or retrieved dynamically from an API when an authorization decision is requested – but getting this information is not something OPA can do on your behalf.

## Rego overview

Rego is a general-purpose policy language, which means that it works for any layer of the stack and any domain. The primary purpose of Rego is to accept JSON/YAML inputs and data that are evaluated to make policy-enabled decisions about infrastructure resources, identities, and operations. Rego enables you to write policy about any layer of a stack or domain without requiring a change or extension of the language. Here are some examples of decisions that Rego can make:

- Is this API request allowed or denied?
- What is the hostname of the backup server for this application?
- What is the risk score for this proposed infrastructure change?
- Which clusters should this container be deployed to for high availability?
- What routing information should be used for this microservice?

---

To answer these questions, Rego employs a basic philosophy about how these decisions can be made. The two key tenets when drafting policy in Rego are:

- Every resource, identity, or operation can be represented as JSON or YAML data.
- Policy is logic that is applied to data.

Rego helps software systems make authorization decisions by defining logic about how inputs of JSON/YAML data are evaluated. Programming languages such as C, Java, Go, and Python are the usual solution to this problem, but Rego was designed to focus on the data and inputs that represent your system, and the logic for making policy decisions with this information.

## Example 1: Basic ABAC with OPA and Rego

This section describes a scenario where OPA is used to make access decisions about which users are allowed to access information in a fictional Payroll microservice. Rego code snippets are provided to demonstrate how you can use Rego to render access control decisions. These examples are neither exhaustive nor a full exploration of Rego and OPA capabilities. For a more thorough overview of Rego, we recommend that you consult the [Rego documentation](#) on the OPA website.

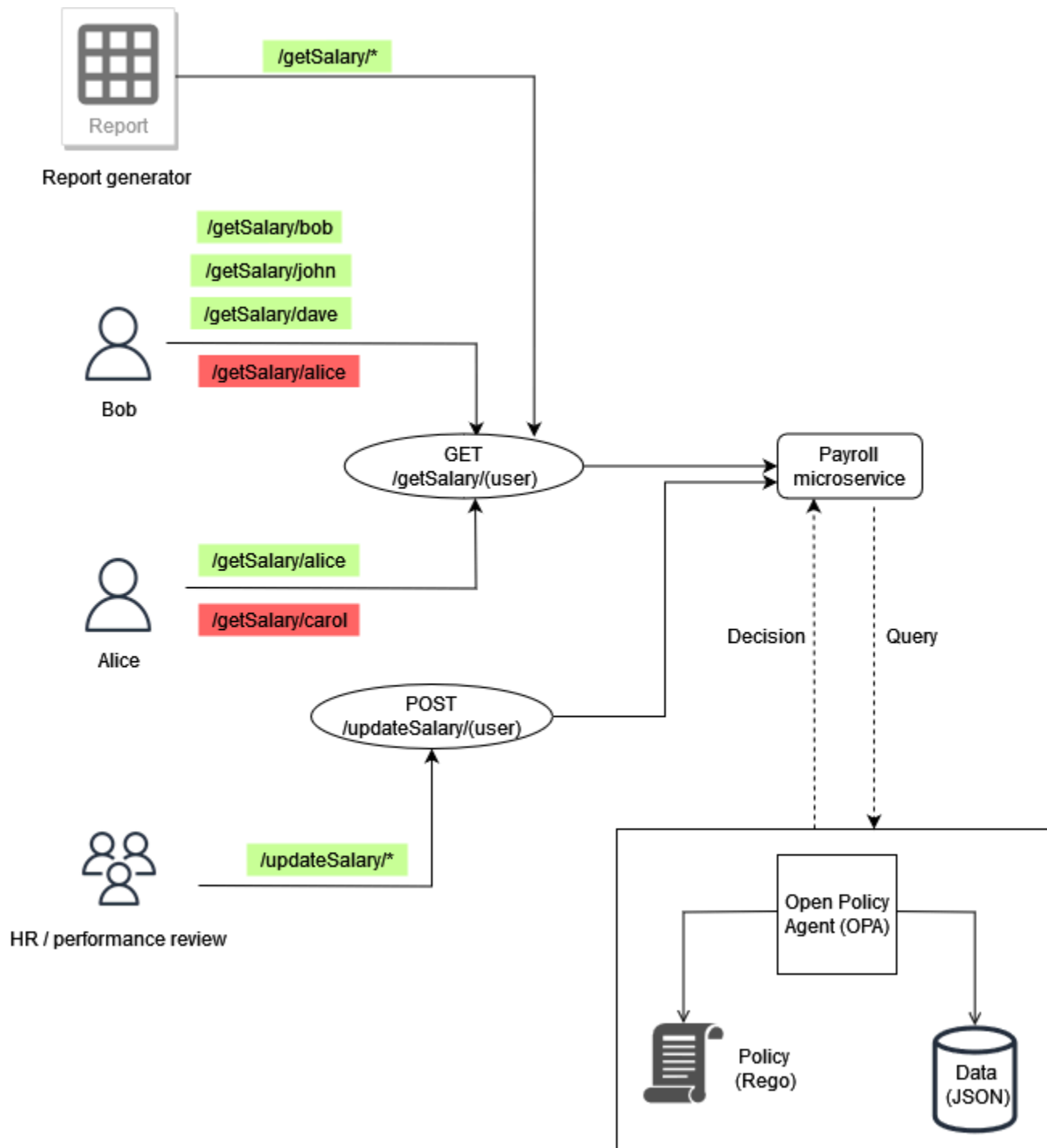

## Basic OPA rules example

In the previous diagram, one of the access control rules enforced by OPA for the Payroll microservice is:

*Employees can read their own salary.*



If Bob tries to access the Payroll microservice to see his own salary, the Payroll microservice can redirect the API call to the OPA RESTful API to make an access decision. The Payroll service queries OPA for a decision with the following JSON input:

```
{
  "user": "bob",
  "method": "GET",
  "path": ["getSalary", "bob"]
}
```

OPA selects a policy or policies based on the query. In this case, the following policy, which is written in Rego, evaluates the JSON input.

```
default allow = false
allow = true {
  input.method == "GET"
  input.path = ["getSalary", user]
  input.user == user
}
```

This policy denies access by default. It then evaluates the input in the query by binding it to the global variable `input`. The dot operator is used with this variable to access the variable's values. The Rego rule `allow` returns true if the expressions in the rule are also true. The Rego rule verifies that the method in the input is equal to `GET`. It then verifies that the first element in the list `path` is `getSalary` before assigning the second element in the list to the variable `user`. Lastly, it checks that the path being accessed is `/getSalary/bob` by checking that the `user` making the request, `input.user`, matches the `user` variable. The rule `allow` applies if-then logic to return a Boolean value, as shown in the output:

```
{
  "allow": true
}
```

## Partial rule using external data

To demonstrate additional OPA capabilities, you can add requirements to the access rule you are enforcing. Let's assume that you want to enforce this access control requirement in the context of the previous illustration:

*Employees can read the salary of anyone who reports to them.*

In this example, OPA has access to external data that can be imported to help make an access decision:

```
"managers": {
  "bob": ["dave", "john"],
  "carol": ["alice"]
}
```

You can generate an arbitrary JSON response by creating a partial rule in OPA, which returns a set of values instead of a fixed response. This is an example of a partial rule:

```
direct_report[user_ids] {
  user_ids = data.managers[input.user][_]
}
```

This rule returns a set of all users that report to the value of `input.user`, which, in this case, is bob. The `[_]` construct in the rule is used to iterate over the values of the set. This is the output of the rule:

```
{
  "direct_report": [
    "dave",
    "john"
  ]
}
```

Retrieving this information can help determine whether a user is a direct report of a manager. For some applications, returning dynamic JSON is preferable to returning a simple Boolean response.

## Putting it all together

The last access requirement is more complex than the first two because it combines the conditions specified in both requirements:

*Employees can read their own salary and the salary of anyone who reports to them.*

To fulfill this requirement, you can use this Rego policy:

```
default allow = false

allow = true {
  input.method == "GET"
  input.path = ["getSalary", user]
  input.user == user
}

allow = true {
  input.method == "GET"
  input.path = ["getSalary", user]
  managers := data.managers[input.user][_ ]
  contains(managers, user)
}
```

The first rule in the policy allows access for any user who tries to see their own salary information, as discussed previously. Having two rules with the same name, `allow`, functions as a logical **or** operator in Rego. The second rule retrieves the list of all direct reports associated with `input.user` (from the data in the previous diagram) and assigns this list to the `managers` variable. Lastly, the rule checks whether the user who is trying to see their salary is a direct report of `input.user` by verifying that their name is contained in the `managers` variable.

The examples in this section are very basic and do not provide a complete or thorough exploration of the capabilities of Rego and OPA. For more information, review the [OPA documentation](#), see the [OPA GitHub README](#) file, and experiment in the [Rego playground](#).

## Example 2: Multi-tenant access control and user-defined RBAC with OPA and Rego

This example uses OPA and Rego to demonstrate how access control can be implemented on an API for a multi-tenant application with custom roles defined by tenant users. It also demonstrates how access can be restricted based on a tenant. This model shows how OPA can make granular permission decisions based on information that is provided in a high-level role.

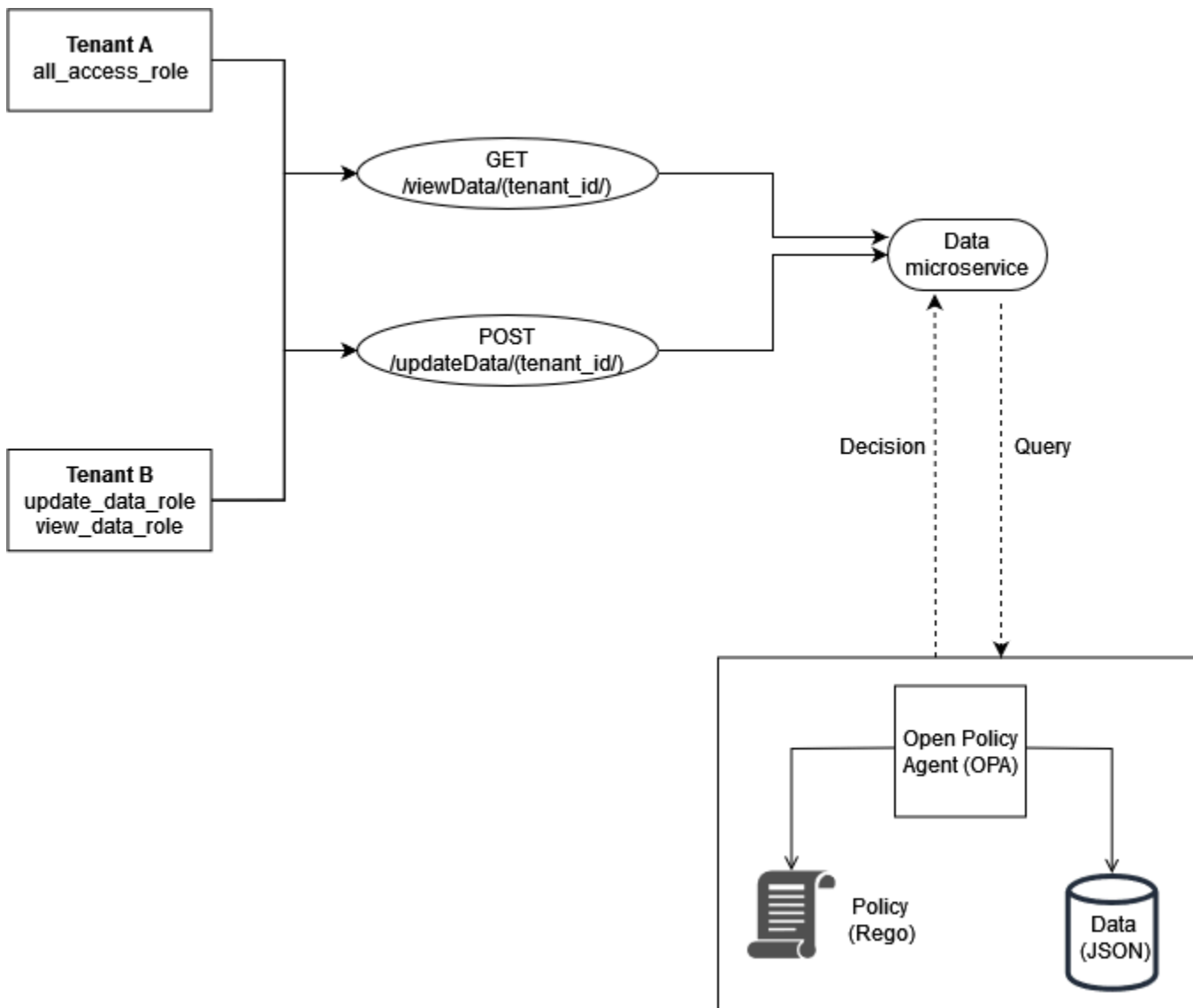

The roles for the tenants are stored in external data (RBAC data) that is used to make access decisions for OPA:

```
{
  "roles": {
    "tenant_a": {
      "all_access_role": ["viewData", "updateData"]
    },
    "tenant_b": {
      "update_data_role": ["updateData"],
      "view_data_role": ["viewData"]
    }
  }
}
```

```
}
```

These roles, when defined by a tenant user, should be stored in an external data source or an identity provider (IdP) that can act as a source of truth when mapping tenant-defined roles to permissions and to the tenant itself.

This example uses two policies in OPA to make authorization decisions and to examine how these policies enforce tenant isolation. These policies use the RBAC data defined earlier.

```
default allowViewData = false
allowViewData = true {
  input.method == "GET"
  input.path = ["viewData", tenant_id]
  input.tenant_id == tenant_id
  role_permissions := data.roles[input.tenant_id][input.role][_ ]
  contains(role_permissions, "viewData")
}
```

To show how this rule will function, consider an OPA query that has the following input:

```
{
  "tenant_id": "tenant_a",
  "role": "all_access_role",
  "path": ["viewData", "tenant_a"],
  "method": "GET"
}
```

An authorization decision for this API call is made as follows, by combining the *RBAC data*, the *OPA policies*, and the *OPA query input*:

1. A user from Tenant A makes an API call to `/viewData/tenant_a`.
2. The Data microservice receives the call and queries the `allowViewData` rule, passing the input shown in the OPA query input example.
3. OPA uses the queried rule in OPA policies to evaluate the input provided. OPA also uses the data from RBAC data to evaluate the input. OPA does the following:
  - a. Verifies that the method used to make the API call is GET.
  - b. Verifies that the path requested is `viewData`.

- c. Checks that the `tenant_id` in the path is equal to the `input.tenant_id` associated with the user. This ensures that tenant isolation is maintained. Another tenant, even with an identical role, is unable to be authorized in making this API call.
  - d. Pulls a list of role permissions from the roles' external data and assigns them to the variable `role_permissions`. This list is retrieved by using the tenant-defined role that is associated with the user in `input.role`.
  - e. Checks `role_permissions` to see whether it contains the permission `viewData`.
4. OPA returns the following decision to the Data microservice:

```
{
  "allowViewData": true
}
```

This process shows how RBAC and tenant awareness can contribute to making an authorization decision with OPA. To further illustrate this point, consider an API call to `/viewData/tenant_b` with the following query input:

```
{
  "tenant_id": "tenant_b",
  "role": "view_data_role",
  "path": ["viewData", "tenant_b"],
  "method": "GET"
}
```

This rule would return the same output as OPA query input although it is for a different tenant who has a different role. This is because this call is for `/tenant_b` and the `view_data_role` in RBAC data still has the `viewData` permission associated with it. To enforce the same type of access control for `/updateData`, you can use a similar OPA rule:

```
default allowUpdateData = false
allowUpdateData = true {
  input.method == "POST"
  input.path = ["updateData", tenant_id]
  input.tenant_id == tenant_id
  role_permissions := data.roles[input.tenant_id][input.role][_]
  contains(role_permissions, "updateData")
}
```

This rule is functionally the same as the `allowViewData` rule, but it verifies a different path and input method. The rule still ensures tenant isolation and checks that the tenant-defined role grants the API caller permission. To see how this might be enforced, examine the following query input for an API call to `/updateData/tenant_b`:

```
{
  "tenant_id": "tenant_b",
  "role": "view_data_role",
  "path": ["updateData", "tenant_b"],
  "method": "POST"
}
```

This query input, when evaluated with the `allowUpdateData` rule, returns the following authorization decision:

```
{
  "allowUpdateData": false
}
```

This call will not be authorized. Although the API caller is associated with the correct `tenant_id` and is calling the API by using an approved method, the `input.role` is the tenant-defined `view_data_role`. The `view_data_role` doesn't have the `updateData` permission; therefore, the call to `/updateData` is unauthorized. This call would have been successful for a `tenant_b` user who has the `update_data_role`.

## Example 3: Multi-tenant access control for RBAC and ABAC with OPA and Rego

To enhance the RBAC example in the previous section, you can add attributes to users.

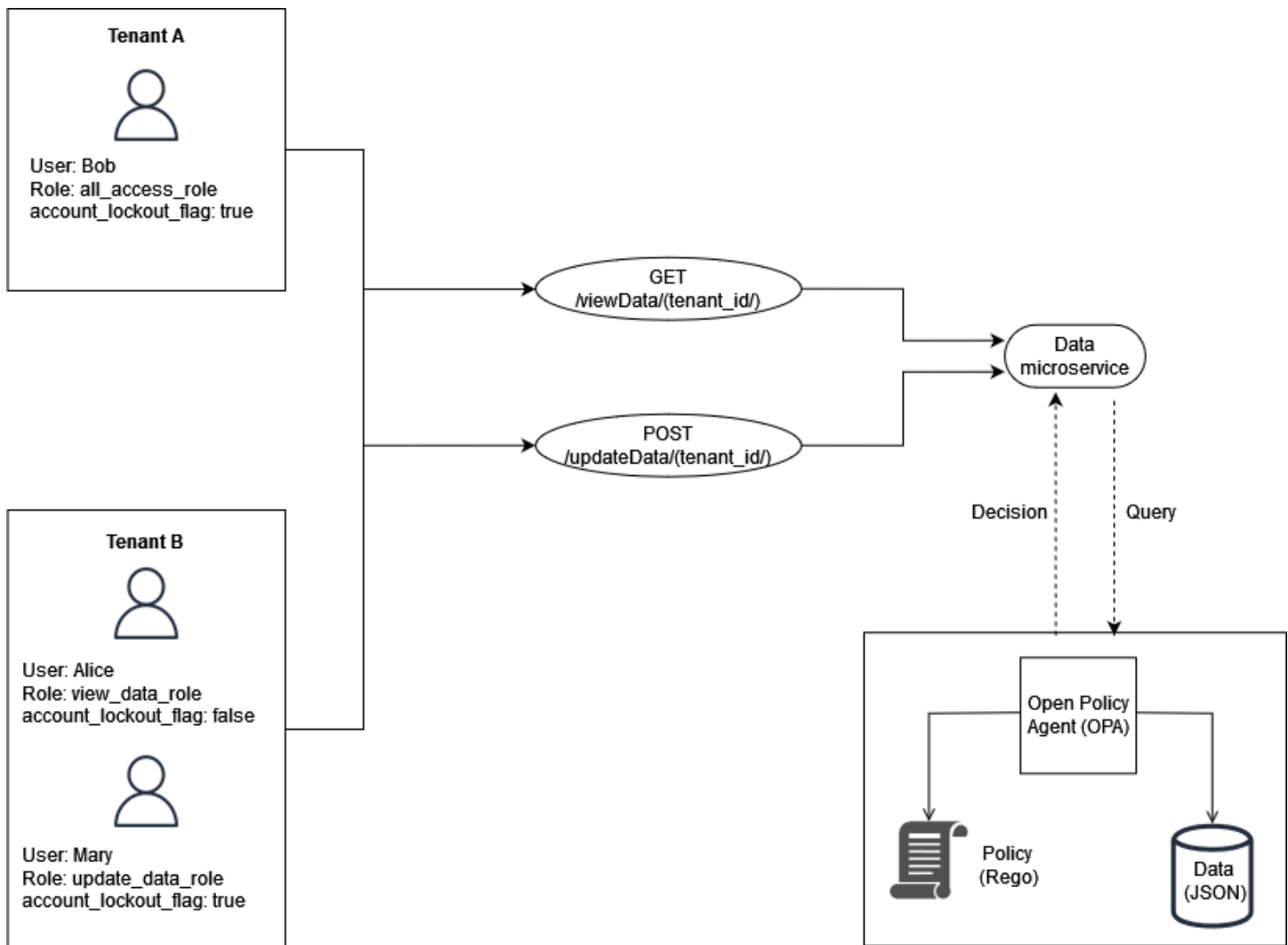

This example includes the same roles from the previous example, but adds the user attribute `account_lockout_flag`. This is a user-specific attribute that isn't associated with any particular role. You can use the same RBAC external data that you used previously for this example:

```
{
  "roles": {
    "tenant_a": {
      "all_access_role": ["viewData", "updateData"]
    },
    "tenant_b": {
      "update_data_role": ["updateData"],
      "view_data_role": ["viewData"]
    }
  }
}
```



```
}
```

The `account_lockout_flag` user attribute can be passed to the Data service as part of the input to an OPA query for `/viewData/tenant_a` for the user Bob:

```
{
  "tenant_id": "tenant_a",
  "role": "all_access_role",
  "path": ["viewData", "tenant_a"],
  "method": "GET",
  "account_lockout_flag": "true"
}
```

The rule that is queried for the access decision is similar to the previous examples, but includes an additional line to check for the `account_lockout_flag` attribute:

```
default allowViewData = false
allowViewData = true {
  input.method == "GET"
  input.path = ["viewData", tenant_id]
  input.tenant_id == tenant_id
  role_permissions := data.roles[input.tenant_id][input.role][_ ]
  contains(role_permissions, "viewData")
  input.account_lockout_flag == "false"
}
```

This query returns an authorization decision of `false`. This is because the `account_lockout_flag` attribute is `true` for Bob, and the Rego rule `allowViewData` denies access although Bob has the correct role and tenant.

## Example 4: UI filtering with OPA and Rego

The flexibility of OPA and Rego supports the ability to filter UI elements. The following example demonstrates how an OPA partial rule can make authorization decisions about which elements should be displayed in a UI with RBAC. This method is one of many different ways you can filter UI elements with OPA.

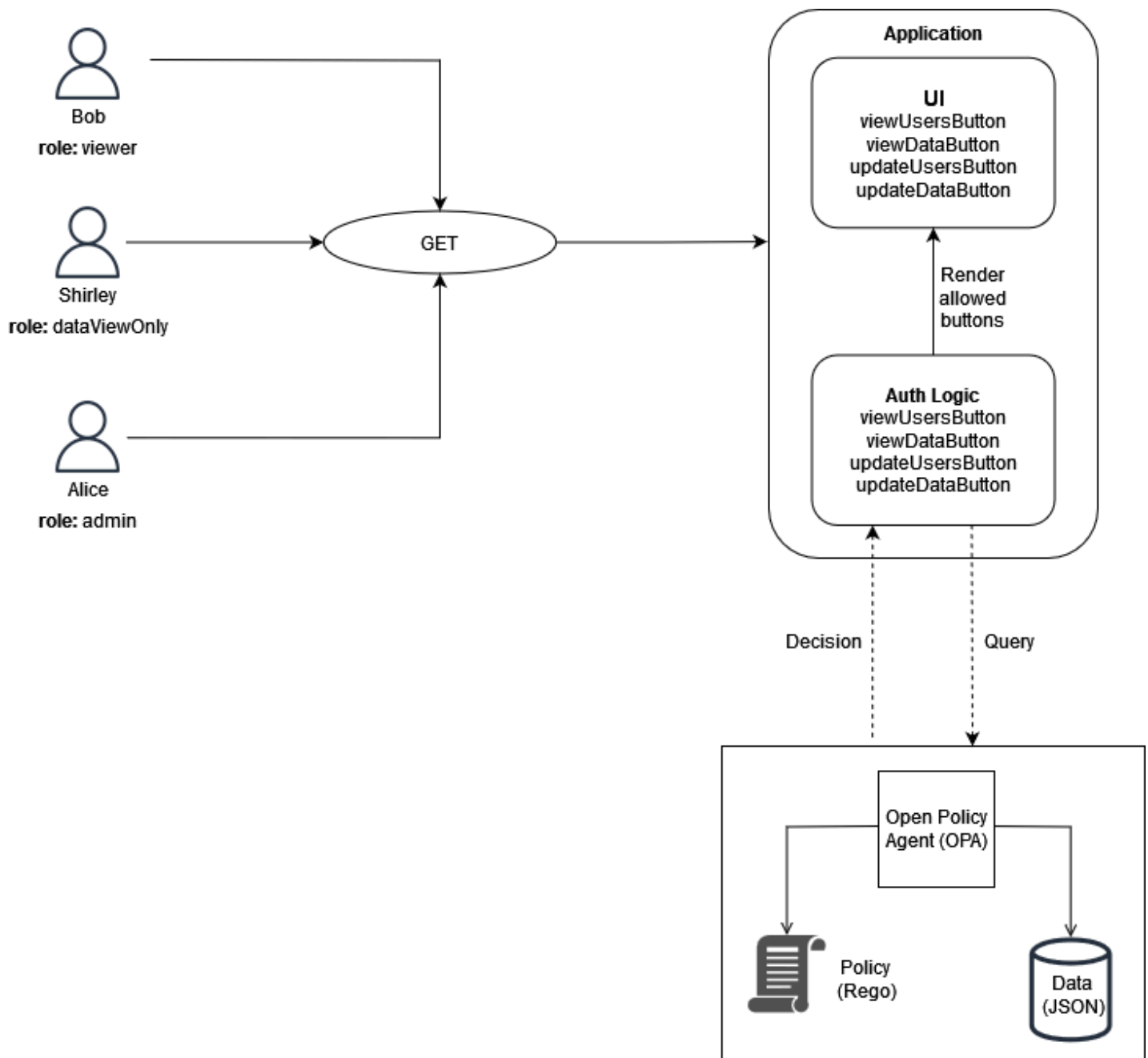

In this example, a single-page web application has four buttons. Let's say that you want to filter Bob's, Shirley's, and Alice's UI so that they can see only the buttons that correspond to their roles. When the UI receives a request from the user, it queries an OPA partial rule to determine which buttons should be displayed in the UI. The query passes the following as input to OPA when Bob (with the role viewer) makes a request to the UI:

```
{
  "role": "viewer"
}
```

```
}
```

OPA uses external data structured for RBAC to make an access decision:

```
{
  "roles": {
    "viewer": ["viewUsers", "viewData"],
    "dataViewOnly": ["viewData"],
    "admin": ["viewUsers", "viewData", "updateUsers", "updateData"]
  }
}
```

The OPA partial rule uses both the external data and the input to produce a list of allowed actions:

```
user_permissions[permissions] {
  permissions := data.roles[input.role][_ ]
}
```

In the partial rule, OPA uses the `input.role` specified as part of the query to determine which buttons should be displayed. Bob has the role `viewer`, and the external data specifies that viewers have two permissions: `viewUsers` and `viewData`. Therefore, the output of this rule for Bob (and for any other users who have a `viewer` role) is as follows:

```
{
  "user_permissions": [
    "viewData",
    "viewUsers"
  ]
}
```

The output for Shirley, who has the `dataViewOnly` role, would contain a `permissions` button: `viewData`. The output for Alice, who has the `admin` role, would contain all of these permissions. These responses are returned to the UI when OPA is queried for `user_permissions`. The application can then use this response to hide or display the `viewUsersButton`, `viewDataButton`, `updateUsersButton`, and the `updateDataButton`.

## Using a custom policy engine

An alternative method for implementing a PDP is to create a custom policy engine. The goal of this policy engine is to decouple authorization logic from an application. The custom policy engine is responsible for making authorization decisions, similar to Verified Permissions or OPA, to achieve policy decoupling. The primary difference between this solution and using Verified Permissions or OPA is that the logic for writing and evaluating policies is custom-built for a custom policy engine. Any interactions with the engine must be exposed through an API or some other method to enable authorization decisions to reach an application. You can write a custom policy engine in any programming language or use other mechanisms for policy evaluation, such as the [Common Expression Language \(CEL\)](#).

## Implementing a PEP

A policy enforcement point (PEP) is responsible for receiving authorization requests that are sent to the policy decision point (PDP) for evaluation. A PEP can be anywhere in an application where data and resources must be protected, or where authorization logic is applied. PEPs are relatively simple compared with PDPs. A PEP is responsible only for requesting and evaluating an authorization decision and doesn't require any authorization logic. PEPs, unlike PDPs, cannot be centralized in a SaaS application. This is because authorization and access control are required to be implemented throughout an application and its access points. PEPs can be applied to APIs, microservices, Backend for Frontend (BFF) layers, or any point in the application where access control is desired or required. Making PEPs pervasive in an application ensures that authorization is verified often and independently at multiple points.

To implement a PEP, the first step is to determine where access control enforcement should occur in an application. Consider this principle when deciding where PEPs should be integrated into your application:

*If an application exposes an API, there should be authorization and access control on that API.*

This is because in a microservices-oriented or service-oriented architecture, APIs serve as separators between different application functions. It makes sense to include access control as logical *checkpoints* between application functions. **We strongly recommend that you include PEPs as a prerequisite for access to each API in a SaaS application.** It is also possible to integrate authorization at other points in an application. In monolithic applications, it might be necessary to have PEPs integrated within the logic of the application itself. There is no single location where PEPs should be included, but consider using the API principle as a starting point.

## Requesting an authorization decision

A PEP must request an authorization decision from the PDP. The request can take several forms. The easiest and most accessible method for requesting an authorization decision is to send an authorization request or query to a RESTful API that is exposed by the PDP (OPA or Verified Permissions). If you're using Verified Permissions, you can also call the **IsAuthorized** method by using the AWS SDK to retrieve an authorization decision. The only function of a PEP in this pattern is to forward the information that the authorization request or query needs. This can be as simple as forwarding a request received by an API as input to the PDP. There are other methods for

creating PEPs. For example, you can integrate an OPA PDP locally with an application written in the Go programming language as a library instead of using an API.

## Evaluating an authorization decision

PEPs need to include logic to evaluate the results of an authorization decision. When PDPs are exposed as APIs, the authorization decision is likely in JSON format and returned by an API call. The PEP must evaluate this JSON code to determine whether the action being taken is authorized. For example, if a PDP is designed to provide a Boolean *allow* or *deny* authorization decision, the PEP might simply check this value, and then return HTTP status code 200 for *allow* and HTTP status code 403 for *deny*. This pattern of incorporating a PEP as a prerequisite for accessing an API is an easily implemented and highly effective pattern for implementing access control across a SaaS application. In more complicated scenarios, the PEP might be responsible for evaluating arbitrary JSON code returned by the PDP. The PEP must be written to include whatever logic is necessary to interpret the authorization decision that the PDP returns. Because a PEP is likely to be implemented in many different places in your application, we recommend that you package your PEP code as a reusable library or artifact in your programming language of choice. This way, your PEP can be easily integrated at any point in your application with minimal rework.

# Design models for multi-tenant SaaS architectures

There are many ways to implement API access control and authorization. This guide focuses on three design models that are effective for multi-tenant SaaS architectures. These designs serve as a high-level reference for the implementation of policy decision points (PDPs) and policy enforcement points (PEPs), to form a cohesive and ubiquitous authorization model for applications.

## Design models:

- [Design models for Amazon Verified Permissions](#)
- [Design models for OPA](#)

## Design models for Amazon Verified Permissions

### Using a centralized PDP with PEPs on APIs

The centralized policy decision point (PDP) with policy enforcement points (PEPs) on APIs model follows industry best practices to create an effective and easily maintained system for API access control and authorization. This approach supports several key principles:

- Authorization and API access control are applied at multiple points in the application.
- Authorization logic is independent of the application.
- Access control decisions are centralized.

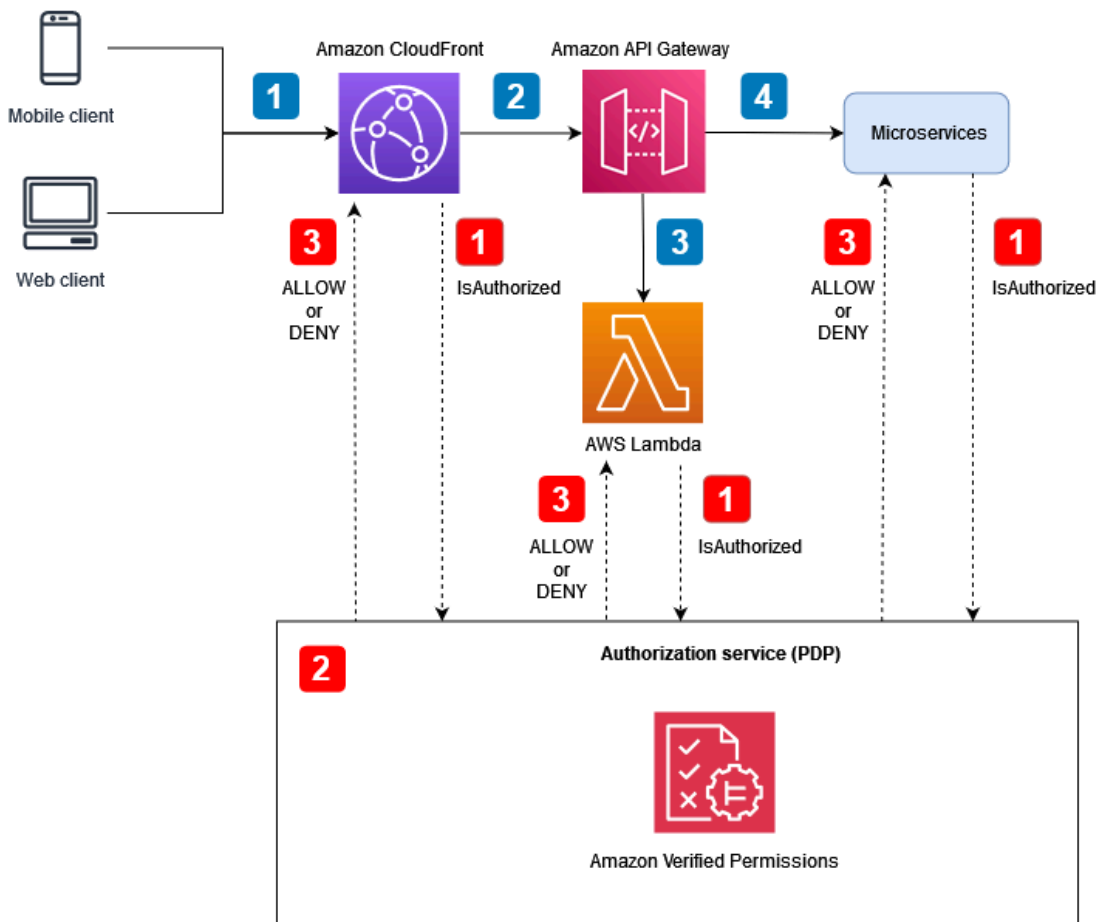

### Application flow (illustrated with blue numbered callouts in the diagram):

1. An authenticated user with a JSON Web Token (JWT) generates an HTTP request to Amazon CloudFront.
2. CloudFront forwards the request to Amazon API Gateway, which is configured as a CloudFront origin.
3. An API Gateway custom authorizer is called to verify the JWT.
4. Microservices respond to the request.

### Authorization and API access control flow (illustrated with red numbered callouts in the diagram):

1. The PEP calls the authorization service and passes request data, including any JWTs.
2. The authorization service (PDP), in this case Verified Permissions, uses the request data as query input and evaluates it based on the relevant policies specified by the query.
3. The authorization decision is returned to the PEP and evaluated.



This model uses a centralized PDP to make authorization decisions. PEPs are implemented at different points to make authorization requests to the PDP. The following diagram shows how you can implement this model in a hypothetical multi-tenant SaaS application.

In this architecture, PEPs request authorization decisions at the service endpoints for Amazon CloudFront and Amazon API Gateway and for each microservice. The authorization decision is made by the authorization service, Amazon Verified Permissions (the PDP). Because Verified Permissions is a fully managed service, you don't have to manage the underlying infrastructure. You can interact with Verified Permissions by using a RESTful API or the AWS SDK.

You can also use this architecture with custom policy engines. However, any advantages gained from Verified Permissions must be replaced with logic that's provided by the custom policy engine.

A centralized PDP with PEPs on APIs provides an easy option to create a robust authorization system for APIs. This simplifies the authorization process and also provides an easy-to-use, repeatable interface for making authorization decisions for APIs, microservices, Backend for Frontend (BFF) layers, or other application components.

## Using the Cedar SDK

Amazon Verified Permissions uses the Cedar language to manage fine-grained permissions in your custom applications. With Verified Permissions, you can store Cedar policies in a central location, take advantage of low latency with millisecond processing, and audit permissions across different applications. You can also optionally integrate the Cedar SDK directly into your application to provide authorization decisions without using Verified Permissions. This option requires additional custom application development to manage and store policies for your use case. However, it can be a viable alternative, particularly in cases where access to Verified Permissions is intermittent or not possible because of inconsistent internet connectivity.

## Design models for OPA

### Using a centralized PDP with PEPs on APIs

The centralized policy decision point (PDP) with policy enforcement points (PEPs) on APIs model follows industry best practices to create an effective and easily maintained system for API access control and authorization. This approach supports several key principles:

- Authorization and API access control are applied at multiple points in the application.
- Authorization logic is independent of the application.

- Access control decisions are centralized.

This model uses a centralized PDP to make authorization decisions. PEPs are implemented at all APIs to make authorization requests to the PDP. The following diagram shows how you can implement this model in a hypothetical multi-tenant SaaS application.

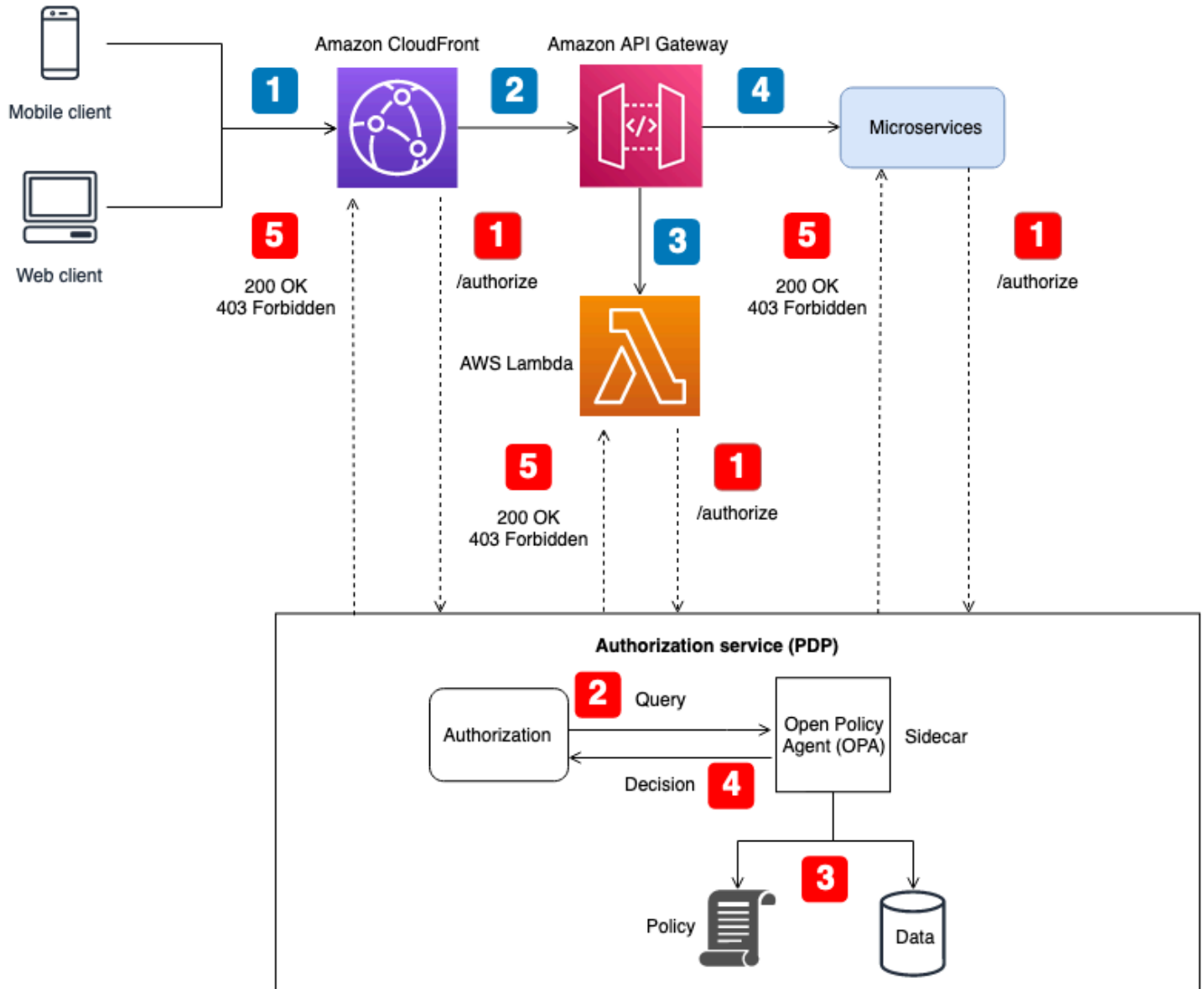

**Application flow** (illustrated with blue numbered callouts in the diagram):

1. An authenticated user with a JWT generates an HTTP request to Amazon CloudFront.
2. CloudFront forwards the request to Amazon API Gateway, which is configured as a CloudFront origin.

3. An API Gateway custom authorizer is called to verify the JWT.
4. Microservices respond to the request.

**Authorization and API access control flow** (illustrated with red numbered callouts in the diagram):

1. The PEP calls the authorization service and passes request data, including any JWTs.
2. The authorization service (PDP) takes the request data and queries an OPA agent REST API, which is running as a sidecar. The request data serves as an input to the query.
3. OPA evaluates the input based on the relevant policies specified by the query. Data is imported to make an authorization decision if necessary.
4. OPA returns a decision to the authorization service.
5. The authorization decision is returned to the PEP and evaluated.

In this architecture, PEPs request authorization decisions at the service endpoints for Amazon CloudFront and Amazon API Gateway, and for each microservice. The authorization decision is made by an authorization service (the PDP) with an OPA sidecar. You can operate this authorization service as a container or as a traditional server instance. The OPA sidecar exposes its RESTful API locally so the API is accessible only to the authorization service. The authorization service exposes a separate API that is available to PEPs. Having the authorization service act as an intermediary between PEPs and OPA allows for the insertion of any transformation logic between PEPs and OPA that may be necessary—for example, when the authorization request from a PEP doesn't conform to the query input expected by OPA.

You can also use this architecture with custom policy engines. However, any advantages gained from OPA must be replaced with logic provided by the custom policy engine.

A centralized PDP with PEPs on APIs provides an easy option to create a robust authorization system for APIs. It's simple to implement and also provides an easy-to-use, repeatable interface for making authorization decisions for APIs, microservices, Backend for Frontend (BFF) layers, or other application components. However, this approach might create too much latency in your application, because authorization decisions require calling a separate API. If network latency is a problem, you might consider a distributed PDP.

## Using a distributed PDP with PEPs on APIs

The distributed policy decision point (PDP) with policy enforcement points (PEPs) on APIs model follows industry best practices to create an effective system for API access control and authorization. As with the centralized PDP with PEPs on APIs model, this approach supports the following key principles:

- Authorization and API access control are applied at multiple points in the application.
- Authorization logic is independent of the application.
- Access control decisions are centralized.

You might wonder why access control decisions are centralized when the PDP is distributed. Although the PDP might exist in multiple places in an application, it must use the same authorization logic to make access control decisions. All PDPs provide the same access control decisions given the same inputs. PEPs are implemented at all APIs to make authorization requests to the PDP. The following figure shows how this distributed model can be implemented in a hypothetical multi-tenant SaaS application.

In this approach, PDPs are implemented in multiple places in the application. For application components that have onboard compute capabilities that can run OPA and support a PDP, such as a containerized service with a sidecar or an Amazon Elastic Compute Cloud (Amazon EC2) instance, PDP decisions can be integrated directly into the application component without having to make a RESTful API call to a centralized PDP service. This has the benefit of reducing the latency that you might encounter in the centralized PDP model, because not every application component has to make additional API calls to obtain authorization decisions. However, a centralized PDP is still necessary in this model for application components that do not have onboard compute capabilities that enable direct integration of a PDP—such as the Amazon CloudFront or Amazon API Gateway service.

The following diagram shows how this combination of a centralized PDP and a distributed PDP can be implemented in a hypothetical multi-tenant SaaS application.

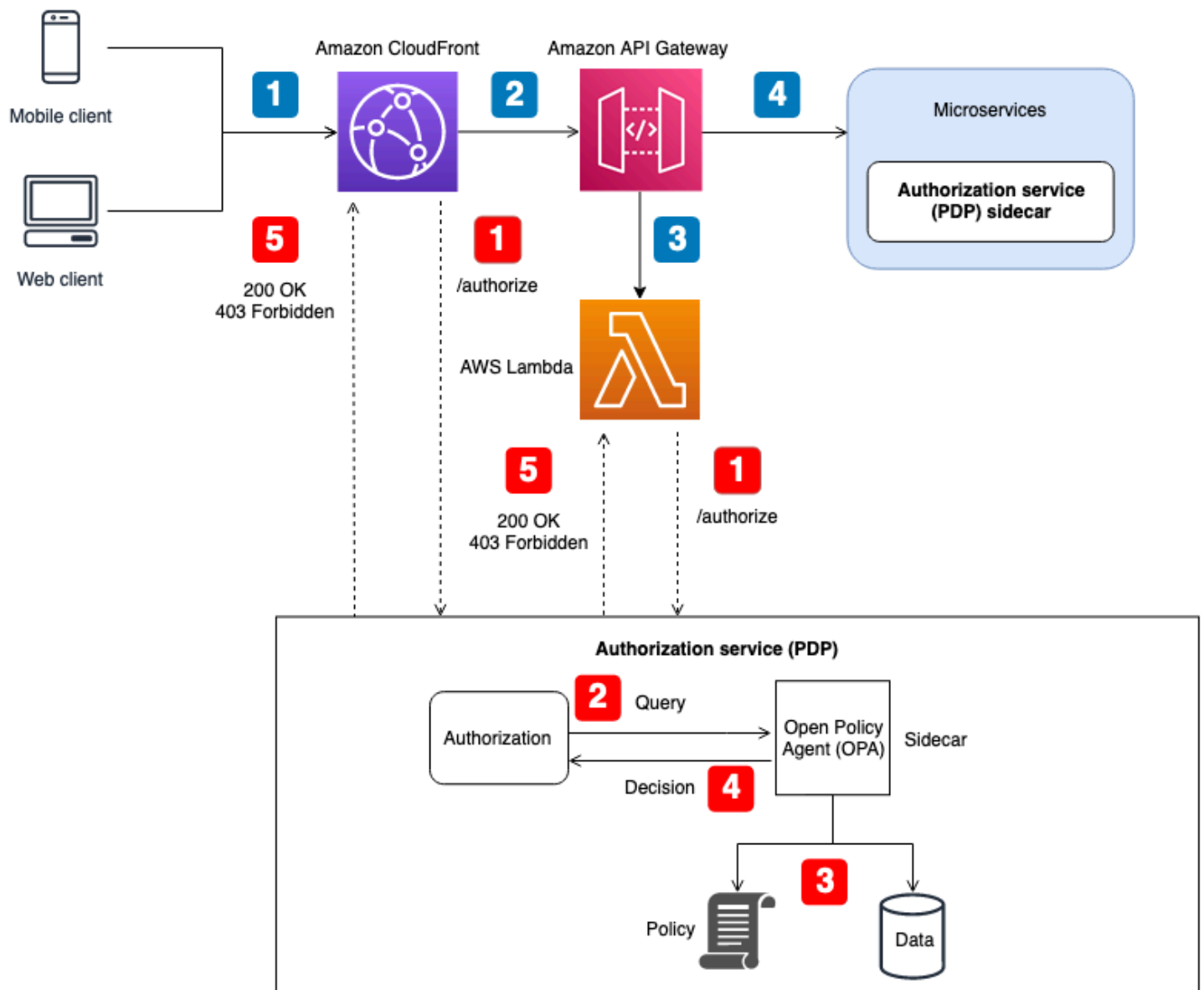

**Application flow** (illustrated with blue numbered callouts in the diagram):

1. An authenticated user with a JWT generates an HTTP request to Amazon CloudFront.
2. CloudFront forwards the request to Amazon API Gateway, which is configured as a CloudFront origin.
3. An API Gateway custom authorizer is called to verify the JWT.
4. Microservices respond to the request.

**Authorization and API access control flow** (illustrated with red numbered callouts in the diagram):

1. The PEP calls the authorization service and passes request data, including any JWTs.
2. The authorization service (PDP) takes the request data and queries an OPA agent REST API, which is running as a sidecar. The request data serves as an input to the query.
3. OPA evaluates the input based on the relevant policies specified by the query. Data is imported to make an authorization decision if necessary.
4. OPA returns a decision to the authorization service.
5. The authorization decision is returned to the PEP and evaluated.

In this architecture, PEPs request authorization decisions at the service endpoints for CloudFront and API Gateway, and for each microservice. The authorization decision for microservices is made by an authorization service (the PDP) that operates as a sidecar with the application component. This model is possible for microservices (or services) that run on containers or Amazon Elastic Compute Cloud (Amazon EC2) instances. Authorization decisions for services such as API Gateway and CloudFront would still require contacting an external authorization service. Regardless, the authorization service exposes an API that is available to PEPs. Having the authorization service act as an intermediary between PEPs and OPA allows for the insertion of any transformation logic between PEPs and OPA that might be necessary—for example, when the authorization request from a PEP doesn't conform to the query input expected by OPA.

You can also use this architecture with custom policy engines. However, any advantages gained from OPA must be replaced with logic provided by the custom policy engine.

A distributed PDP with PEPs on APIs provides an option to create a robust authorization system for APIs. It's simple to implement and provides an easy-to-use, repeatable interface for making authorization decisions for APIs, microservices, Backend for Frontend (BFF) layers, or other application components. This approach also has the advantage of reducing the latency that you might encounter in the centralized PDP model.

## Using a distributed PDP as a library

You can also request authorization decisions from a PDP that is made available as a library or package for use within an application. OPA can be used as a Go third-party library. For other programming languages, adopting this model generally means that you must create a custom policy engine.

# Amazon Verified Permissions multi-tenant design considerations

There are several design options to consider when you implement authorization by using Amazon Verified Permissions in a multi-tenant SaaS solution. Before exploring these options, let's clarify the difference between *isolation* and *authorization* in a multi-tenant SaaS context. [Isolating](#) a tenant prevents inbound and outbound data from being exposed to the wrong tenant. Authorization ensures that a user has the permissions to access a tenant.

In Verified Permissions, policies are stored in a policy store. As described in the [Verified Permissions documentation](#), you can either isolate the policies of tenants by using a separate policy store for each tenant, or allow tenants to share policies by using a single policy store for all tenants. This section discusses the advantages and disadvantages of these two isolation strategies, and describes how they can be deployed by using a tiered deployment model. For additional context, see the Verified Permissions documentation.

Although the criteria discussed in this section focus on Verified Permissions, the general concepts are rooted in the [isolation mindset](#) and the guidance it provides. SaaS applications must always consider [tenant isolation](#) as part of their design, and this general principle of isolation extends to including Verified Permissions in a SaaS application. This section also references core SaaS isolation models such as the [siload SaaS model](#) and the [pooled SaaS model](#). For additional information, see the [core isolation concepts](#) in the AWS Well-Architected Framework, SaaS Lens.

Key considerations when designing multi-tenant SaaS solutions are tenant isolation and tenant onboarding. Tenant isolation impacts security, privacy, resiliency, and performance. Tenant onboarding impacts your operational processes as it relates to operational overhead and observability. Organizations that go through a SaaS journey or implement multi-tenant solutions must always prioritize how tenancy will be handled by the SaaS application. Although a SaaS solution might lean toward a particular isolation model, consistency is not necessarily required across the entire SaaS solution. For example, the isolation model you choose for the frontend components of your application might not be the same as the isolation model you choose for a microservice or authorization services.

## Design considerations:

- [Tenant onboarding and user tenant registration](#)
- [Per-tenant policy store](#)

- [One shared multi-tenant policy store](#)
- [Tiered deployment model](#)

## Tenant onboarding and user tenant registration

SaaS applications observe the concept of [SaaS identities](#) and follow the general best practice of [binding a user identity to a tenant identity](#). Binding involves storing a tenant identifier as a claim or attribute for the user in the identity provider. This shifts the responsibility of mapping identities to tenants from each application to the user registration process. Each authenticated user then has the correct tenant identity as part of the JSON Web Token (JWT).

Similarly, the selection of the correct policy store for an authorization request should not be determined by application logic. To determine which policy store a particular authorization request should use, maintain a mapping of users to policy stores, or tenants to policy stores. These mappings are typically maintained in a data store such as Amazon DynamoDB or Amazon Relational Database Service (Amazon RDS) that your application references. You can also provide or supplement these mappings by data in an identity provider (IdP). The relationship between tenants, users, and policy stores is then usually provided to a user through a JWT that contains all the relationships that are necessary for an authorization request.

This example shows how the JWT might appear for the user Alice, who belongs to the tenant TenantA and uses the policy store with the policy store ID ps-43214321 for authorization.

```
{
  "sub": "1234567890",
  "name": "Alice",
  "tenant": "TenantA",
  "policyStoreId": "ps-43214321"
}
```

## Per-tenant policy store

The per-tenant policy store design model in Amazon Verified Permissions associates each tenant in a SaaS application with its own policy store. This model is similar to the SaaS [silo isolation](#) model. Both models mandate the creation of tenant-specific infrastructure and have similar benefits and disadvantages. The primary benefits of this approach are infrastructure-enforced tenant



isolation, support for unique authorization models on a per-tenant basis, elimination of [noisy neighbor](#) concerns, and a reduced scope of impact for failure in policy updates or deployments. The disadvantages of this approach include more complex tenant onboarding processes, deployments, and operations. Per-tenant policy store is the recommended approach if the solution has unique policies per tenant.

The per-tenant policy store model can provide a highly siloed approach to tenant isolation, if your SaaS application requires it. You can also use this model with [pool isolation](#), but your Verified Permissions implementation won't share the standard benefits of the broader pool isolation model such as simplified management and operations.

In a per-tenant policy store, tenant isolation is achieved by mapping a tenant's policy store identifier to the SaaS Identity of the user during the user registration process, as discussed earlier. This approach strongly ties the tenant's policy store to the user principal and provides a consistent way to share the mapping throughout the entire SaaS solution. You can provide the mapping to a SaaS application by maintaining it as part of an IdP or in an external data source such as DynamoDB. This also ensures that the principal is part of the tenant and that the policy store of the tenant is used.

This example shows how the JWT that contains the `policyStoreId` and `tenant` of a user is passed from the an API endpoint to the policy evaluation point in an AWS Lambda authorizer, which routes the request to the correct policy store.

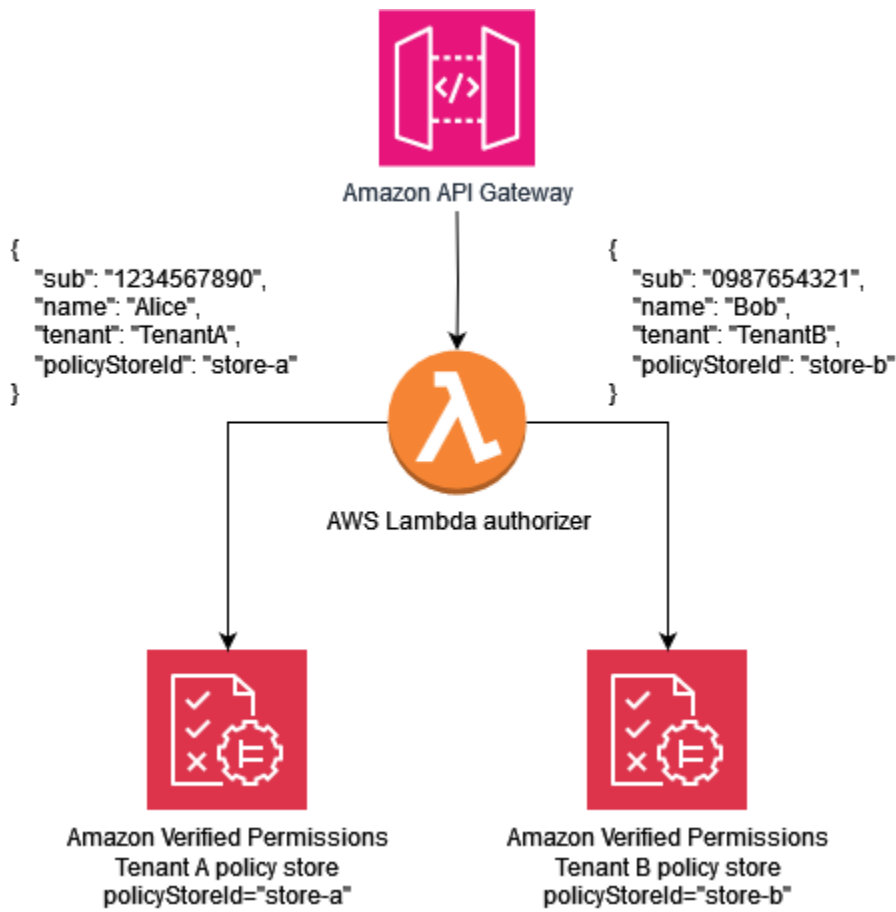

The following sample policy illustrates the per-tenant policy store design paradigm. The user Alice belongs to TenantA. The policyStoreId store-a is also mapped to the tenant identity of Alice, and enforces the use of the correct policy store. This ensures that the policies of TenantA are used.

#### **Note**

The per-tenant policy store model isolates the policies of tenants. Authorization enforces the actions users are allowed to perform on their data. The resources involved in any hypothetical application that uses this model should be isolated by using other isolation mechanisms, as defined in the [AWS Well-Architected Framework, SaaS Lens documentation](#).

In this policy, Alice has permissions to view the data of all resources.

```
permit (
```

```
principal == MultiTenantApp::User::"Alice",  
action == MultiTenantApp::Action::"viewData",  
resource  
);
```

To make an authorization request and start an evaluation with a Verified Permissions policy, you need to provide the policy store ID that corresponds to the unique ID mapped to the tenant, `store-a`.

```
{  
  "policyStoreId":"store-a",  
  "principal":{  
    "entityType":"MultiTenantApp::User",  
    "entityId":"Alice"  
  },  
  "action":{  
    "actionType":"MultiTenantApp::Action",  
    "actionId":"viewData"  
  },  
  "resource":{  
    "entityType":"MultiTenantApp::Data",  
    "entityId":"my_example_data"  
  },  
  "entities":{  
    "entityList":[  
      [  
        {  
          "identifier":{  
            "entityType":"MultiTenantApp::User",  
            "entityId":"Alice"  
          },  
          "attributes":{},  
          "parents":[]  
        },  
        {  
          "identifier":{  
            "entityType":"MultiTenantApp::Data",  
            "entityId":"my_example_data"  
          },  
          "attributes":{},  
          "parents":[]  
        }  
      ]  
    }  
  }  
}
```

```
    ]
  ]
}
}
```

The user Bob belongs to Tenant B, and the policyStoreId store-b is also mapped to the tenant identity of Bob, which enforces the use of the correct policy store. This ensures that the policies of Tenant B are used.

In this policy, Bob has permissions to customize the data of all resources. In this example, customizeData might be an action that is specific only to Tenant B, so the policy would be unique for Tenant B. The per-tenant policy store model inherently supports custom policies on a per-tenant basis.

```
permit (
  principal == MultiTenantApp::User::"Bob",
  action == MultiTenantApp::Action::"customizeData",
  resource
);
```

To make an authorization request and start an evaluation with a Verified Permissions policy, you need to provide the policy store ID that corresponds to the unique ID mapped to the tenant, store-b.

```
{
  "policyStoreId":"store-b",
  "principal":{
    "entityType":"MultiTenantApp::User",
    "entityId":"Bob"
  },
  "action":{
    "actionType":"MultiTenantApp::Action",
    "actionId":"customizeData"
  },
  "resource":{
    "entityType":"MultiTenantApp::Data",
    "entityId":"my_example_data"
  },
  "entities":{
    "entityList":[
      [
```

```
{
  "identifier":{
    "entityType":"MultiTenantApp::User",
    "entityId":"Bob"
  },
  "attributes":{},
  "parents":[]
},
{
  "identifier":{
    "entityType":"MultiTenantApp::Data",
    "entityId":"my_example_data"
  },
  "attributes":{},
  "parents":[]
}
]
]
}
```

With Verified Permissions, it is possible, but not required, to integrate an IdP with a policy store. This integration allows for policies to explicitly reference the principal in the identity store as the policies' principal. For more information about how to integrate with Amazon Cognito as an IdP for Verified Permissions, see the [Verified Permissions documentation](#) and [Amazon Cognito documentation](#).

When you integrate a policy store with an IdP, you can use only one [identity source](#) per policy store. For example, if you choose to integrate Verified Permissions with Amazon Cognito, you have to mirror the strategy used for tenant isolation of Verified Permissions policy stores and Amazon Cognito user pools. The policy stores and user pools also have to be in the same AWS account.

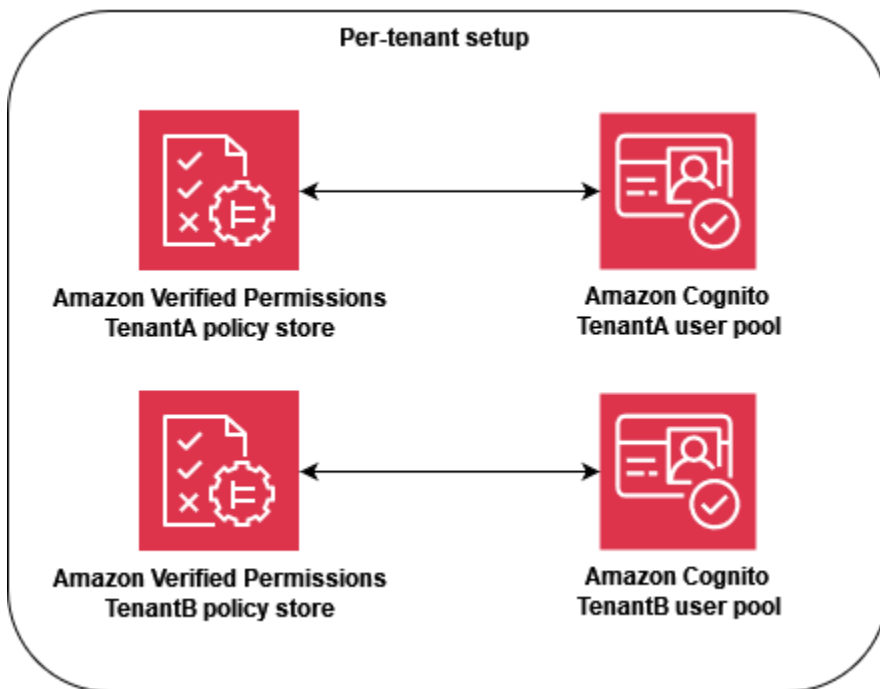

On an operational level, the per-tenant policy store has an audit advantage, because you can easily query the [logged activity in](#) AWS CloudTrail independently for each tenant. However, we still recommend that you log additional custom metrics on a per-tenant dimension to Amazon CloudWatch.

The per-tenant policy store approach also requires close attention to two [Verified Permissions quotas](#) to ensure that they don't interfere with the operations of your SaaS solution. These quotas are *Policy stores per Region per account* and *IsAuthorized requests per second per Region per account*. You can request increases for both quotas.

For a more detailed example of how to implement the per-tenant policy store model, see the AWS blog post [SaaS access control using Amazon Verified Permissions with a per-tenant policy store](#).

## One shared multi-tenant policy store

The one shared multi-tenant policy store design model uses a single multi-tenant policy store in Amazon Verified Permissions for all tenants in the SaaS solution. The primary benefit of this approach is simplified management and operations, particularly because you don't have to create additional policy stores during tenant onboarding. The disadvantages of this approach include an increased scope of impact from any failure or mistakes in policy updates or deployments, and a greater exposure to [noisy neighbor](#) effects. Furthermore, we don't recommend this approach if

your solution requires unique policies for each tenant. In this case, use the per-tenant policy store model instead to guarantee that the policies of the correct tenant are used.

The one shared multi-tenant policy store approach is similar to the SaaS [pooled isolation](#) model. It can provide a pooled approach to tenant isolation, if your SaaS application requires it. You can also use this model if your SaaS solution applies [siloed isolation](#) to its microservices. When you choose a model, you should evaluate the requirements for tenant data isolation and the structure of Verified Permissions policies that are necessary for a SaaS application independently.

To enforce a consistent way of sharing the tenant identifier across your entire SaaS solution, it's a good practice to map the identifier to the user's SaaS identity during user registration, as discussed previously. You can provide this mapping to a SaaS application by maintaining it as part of an IdP or in an external data source such as DynamoDB. We also recommend that you map the shared policy store ID to users. Although the ID isn't used as part of tenant isolation, this is a good practice because it facilitates future changes.

The following example shows how the API endpoint sends a JWT for the users Alice and Bob, who belong to different tenants but share the policy store with the policy store ID `store-multi-tenant` for authorization. Because all tenants share a single policy store, you don't need to maintain the policy store ID in a token or database. Because all tenants share a single policy store ID, you can provide the ID as an environment variable that your application can use to make calls to the policy store.

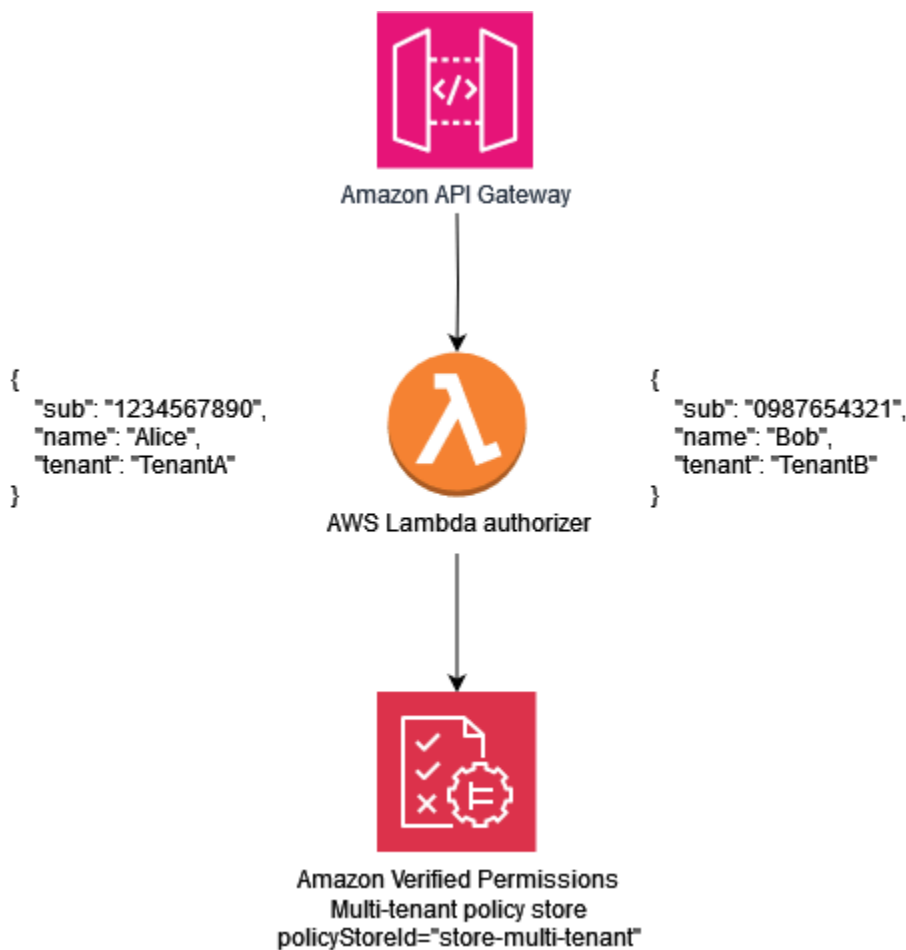

The following sample policy illustrates the one shared multi-tenant policy design paradigm. In this policy, the principal `MultiTenantApp::User` that has the parent `MultiTenantApp::Role Admin` has permissions to view the data of all resources.

```

permit (
  principal in MultiTenantApp::Role::"Admin",
  action == MultiTenantApp::Action::"viewData",
  resource
);

```

Because a single policy store is in use, the Verified Permissions policy store must ensure that a tenancy attribute that's associated with the principal matches the tenancy attribute that's associated with the resource. This can be accomplished by including the following policy in the policy store, to ensure that all authorization requests that don't have matching tenancy attributes on the resource and principal are rejected.

```

forbid(

```



```
    principal,  
    action,  
    resource  
  )  
  unless {  
    resource.Tenant == principal.Tenant  
  };  
};
```

For an authorization request that uses a one shared multi-tenant policy store model, the policy store ID is the identifier of the shared policy store. In the following request, the User Alice is allowed access because she has a Role of Admin, and the Tenant attributes associated with the resource and principal are both TenantA.

```
{  
  "policyStoreId":"store-multi-tenant",  
  "principal":{  
    "entityType":"MultiTenantApp::User",  
    "entityId":"Alice"  
  },  
  "action":{  
    "actionType":"MultiTenantApp::Action",  
    "actionId":"viewData"  
  },  
  "resource":{  
    "entityType":"MultiTenantApp::Data",  
    "entityId":"my_example_data"  
  },  
  "entities":{  
    "entityList":[  
      {  
        "identifier":{  
          "entityType":"MultiTenantApp::User",  
          "entityId":"Alice"  
        },  
        "attributes": {  
          {  
            "Tenant": {  
              "entityIdentifier": {  
                "entityType":"MultitenantApp::Tenant",  
                "entityId":"TenantA"  
              }  
            }  
          }  
        }  
      }  
    ]  
  }  
}
```

```
    }
  },
  "parents": [
    {
      "entityType": "MultiTenantApp::Role",
      "entityId": "Admin"
    }
  ]
},
{
  "identifier": {
    "entityType": "MultiTenantApp::Data",
    "entityId": "my_example_data"
  },
  "attributes": {
    {
      "Tenant": {
        "entityIdentifier": {
          "entityType": "MultitenantApp::Tenant",
          "entityId": "TenantA"
        }
      }
    }
  },
  "parents": []
}
]
}
}
```

With Verified Permissions, it is possible, but not required, to integrate an IdP with a policy store. This integration allows for policies to explicitly reference the principal in the identity store as the policies' principal. For more information about how to integrate with Amazon Cognito as an IdP for Verified Permissions, see the [Verified Permissions documentation](#) and [Amazon Cognito documentation](#).

When you integrate a policy store with an IdP, you can use only one [identity source](#) per policy store. For example, if you choose to integrate Verified Permissions with Amazon Cognito, you have to mirror the strategy used for tenant isolation of Verified Permissions policy stores and Amazon Cognito user pools. The policy stores and user pools also have to be in the same AWS account.

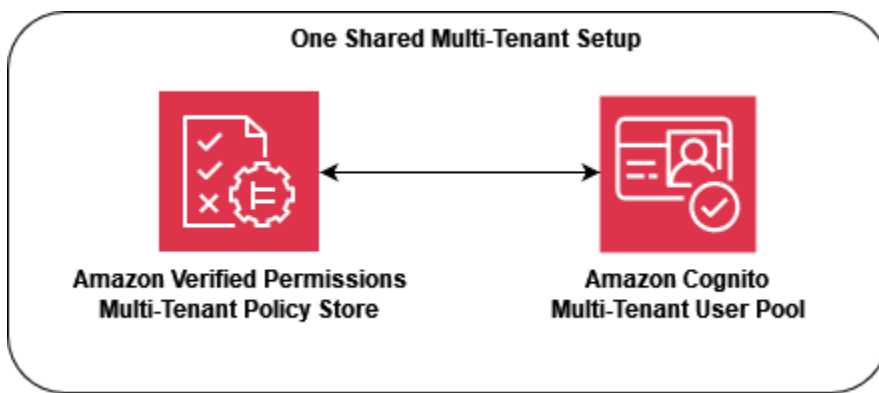

From operational and audit perspectives, the one shared multi-tenant policy store model has a disadvantage in that the [logged activity in AWS CloudTrail](#) requires more involved queries to filter out individual activity on the tenant, because each logged CloudTrail call uses the same policy store. In this scenario, it is helpful to log additional custom metrics on a per-tenant dimension to Amazon CloudWatch to ensure an appropriate level of observability and audit capability.

The one shared multi-tenant policy store approach also requires close attention to [Verified Permissions quotas](#) to ensure that they don't interfere with the operations of your SaaS solution. In particular, we recommend that you monitor the *IsAuthorized requests per second per Region per account* quota to ensure that its limitations are not exceeded. You can request an increase to this quota.

## Tiered deployment model

By creating a tiered deployment model, you can isolate high-priority “Enterprise Tier” tenants from the potentially higher volume of “Standard Tier” customers. In this model, you can roll out any changes deployed to policies in policy stores separately for each tier, which isolates each tier of customers from changes made outside of their tier. In the tiered deployment model, the policy stores are typically created as part of initial infrastructure provisioning for each tier instead of being deployed when a tenant is onboarded.

If your solution primarily uses a pooled isolation model, you might require additional isolation or customization. For example, you can create a “Premium Tier” where each tenant would get their own tenant tier infrastructure, which creates a siloed model by deploying a pooled instance with only one tenant. This could take the form of “Premium Tier Tenant A” and “Premium Tier Tenant B” infrastructures that are completely separated, including policy stores. This approach results in a siloed isolation model for the highest level of customers.

In the tiered deployment model, each policy store should follow the same isolation model, although it's deployed separately. Because there are multiple policy stores being used, you need to enforce a consistent way of sharing the policy store identifier that's associated with the tenant across the entire SaaS solution. As with the per-tenant policy store model, it's a good practice to map the tenant identifier to the user's SaaS identity during user registration.

The following diagram shows three tiers: Standard Tier, Enterprise Tier, and Premium Tier 1. Each tier is deployed separately in its own infrastructure and uses one shared policy store within the tier. The Standard and Enterprise Tiers contain multiple tenants. TenantA and TenantB are in the Standard Tier, and TenantC and TenantD are in the Enterprise Tier.

Premium Tier 1 contains only TenantP, so you can serve the premium tenant as if the solution had a fully siloed isolation model and provide features such as customized policies. Onboarding a new premium tier customer would result in the creation of a Premium Tier 2 infrastructure.

**Note**

The application, deployment, and tenant onboarding in the premium tier are identical to the standard and enterprise tiers. The only difference is that the premium tier onboarding workflow begins with the provisioning of a new tier infrastructure.

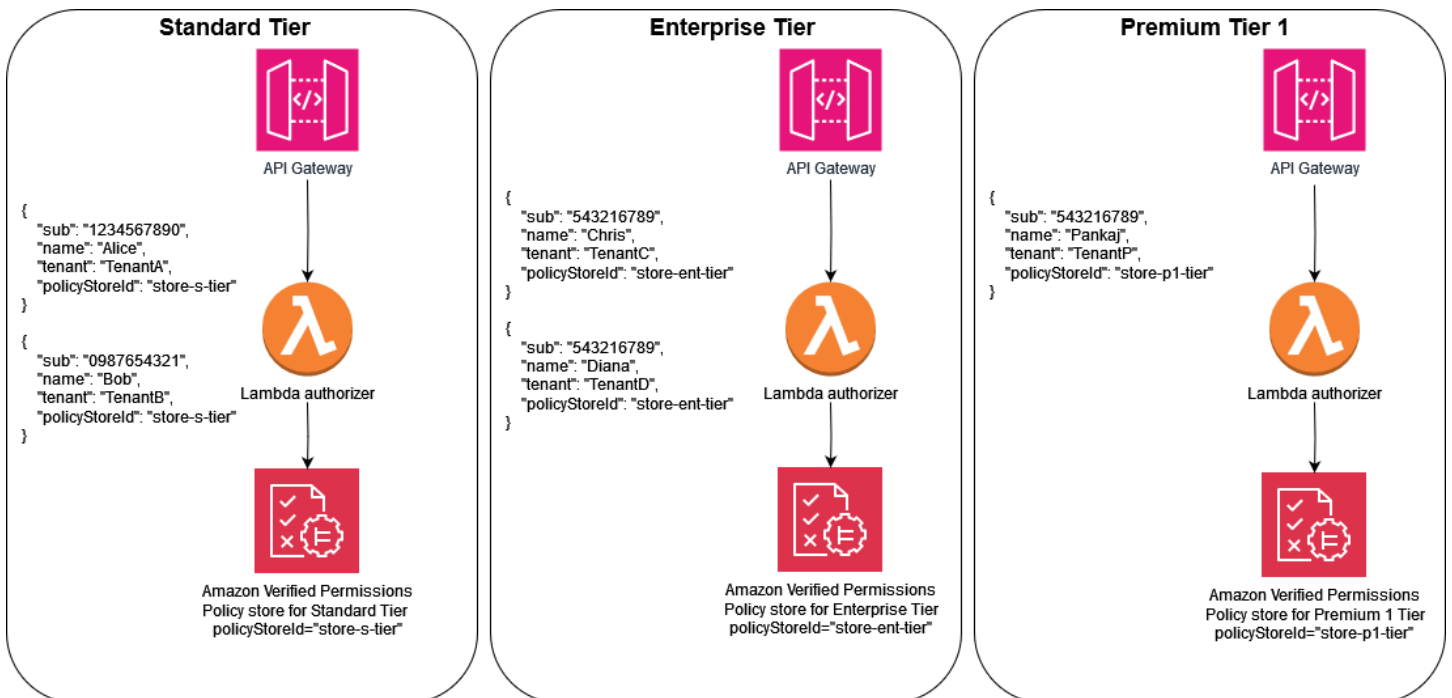

# OPA multi-tenant design considerations

The Open Policy Agent (OPA) is a flexible service that can be applied to numerous use cases where applications are required to make policy and authorization decisions. Using OPA with multi-tenant SaaS applications requires the consideration of unique criteria to ensure that key SaaS best practices such as tenant isolation remain a part of OPA's implementation. These criteria include OPA deployment patterns, tenant isolation and the OPA document model, and tenant onboarding. Each of these affects the optimal design for OPA as it pertains to multi-tenant applications.

Although the discussion in this section focuses on OPA, the general concepts are rooted in the [isolation mindset](#) and the guidance it provides. SaaS applications must always consider tenant isolation as part of their design, and this general principle of isolation extends to including OPA in a SaaS application. OPA, if used appropriately, can be a key part of how isolation is enforced in SaaS applications. This section also references core SaaS isolation models such as the [siloed SaaS model](#) and the [pooled SaaS model](#). For additional information, see the [core isolation concepts](#) in the AWS Well-Architected Framework, SaaS Lens.

## Design considerations:

- [Comparing centralized and distributed deployment patterns](#)
- [Tenant isolation with the OPA document model](#)
- [Tenant onboarding](#)

## Comparing centralized and distributed deployment patterns

You can deploy OPA in a centralized or distributed deployment pattern, and the ideal method for a multi-tenant application depends on the use case. For examples of these patterns, see the [Using a centralized PDP with PEPs on APIs](#) and [Using a distributed PDP and PEPs on APIs](#) sections earlier in this guide. Because OPA can be deployed as a daemon in an operating system or container, it can be implemented in multiple ways to support a multi-tenant application.

In a centralized deployment pattern, OPA is deployed as a container or daemon with its RESTful API available to other services in the application. When a service requires a decision from OPA, the central OPA RESTful API is called to produce this decision. This approach is simple to deploy and maintain, because there is only a single deployment of OPA. The downside of this approach is that it doesn't provide any mechanism to maintain the separation of tenant data. Because there is only a single deployment of OPA, all tenant data that's used in an OPA decision, including any

external data that's referenced by OPA, must be available to OPA. You can maintain tenant data isolation with this approach, but it must be enforced by OPA's policy and document structure or access to external data. A centralized deployment pattern also requires a higher latency, because each authorization decision must make a RESTful API call to another service.

In a distributed deployment pattern, OPA is deployed as a container or daemon alongside the multi-tenant application's services. It could be deployed as a sidecar container or as a daemon that runs locally on the operating system. To retrieve a decision from OPA, the service makes a RESTful API call to the local OPA deployment. (Because OPA can be deployed as a Go package, you can use Go natively to retrieve a decision instead of using a RESTful API call.) Unlike the centralized deployment pattern, the distributed pattern requires a much more robust effort to deploy, maintain, and update because it is present across multiple areas of the application. A benefit of the distributed deployment pattern is the ability to maintain the isolation of tenant data, particularly for applications that use a [siload SaaS model](#). Tenant-specific data can be isolated in OPA deployments that are specific to that tenant, because OPA in a distributed model is deployed alongside the tenant. Additionally, a distributed deployment pattern has much lower latency than a centralized deployment pattern, because each authorization decision can be made locally.

When you choose an OPA deployment pattern in your multi-tenant application, make sure to evaluate the criteria that are most critical for your application. If your multi-tenant application is sensitive to latency, a distributed deployment pattern offers better performance at the expense of more complex deployment and maintenance. Although you can manage some of this complexity through DevOps and automation, it still requires additional effort when compared with a centralized deployment pattern.

If your multi-tenant application uses a siload SaaS model, you can use a distributed OPA deployment pattern to mimic the siload approach to tenant data isolation. This is because when OPA runs alongside each tenant-specific application service, you can customize each OPA deployment to only contain data that's associated with that tenant. Siloing OPA data in a centralized OPA deployment pattern isn't possible. If you use either a centralized deployment pattern or a distributed pattern in conjunction with a [pooled SaaS model](#), tenant data isolation must be maintained in the OPA document model.

## Tenant isolation with the OPA document model

OPA uses documents to make decisions. These documents can contain tenant-specific data, so you must consider how to maintain tenant data isolation. OPA documents consist of base documents

and virtual documents. Base documents contain data from the the outside world. This includes data provided to OPA directly, data about the OPA request, and data that might be passed to OPA as input. Virtual documents are computed by policy and include OPA policies and rules. For more information, see the [OPA documentation](#).

To design a document model in OPA for a multi-tenant application, you must first consider what type of base documents you will need to make a decision in OPA. If these base documents contain tenant-specific data, you must take measures to ensure that this data isn't accidentally exposed to cross-tenant access. Fortunately, in many cases, tenant-specific data isn't required to make a decision in OPA. The following example shows a hypothetical OPA document model that allows access to an API based on which tenant owns the API, and whether the user is a member of the tenant, as indicated in the input document.

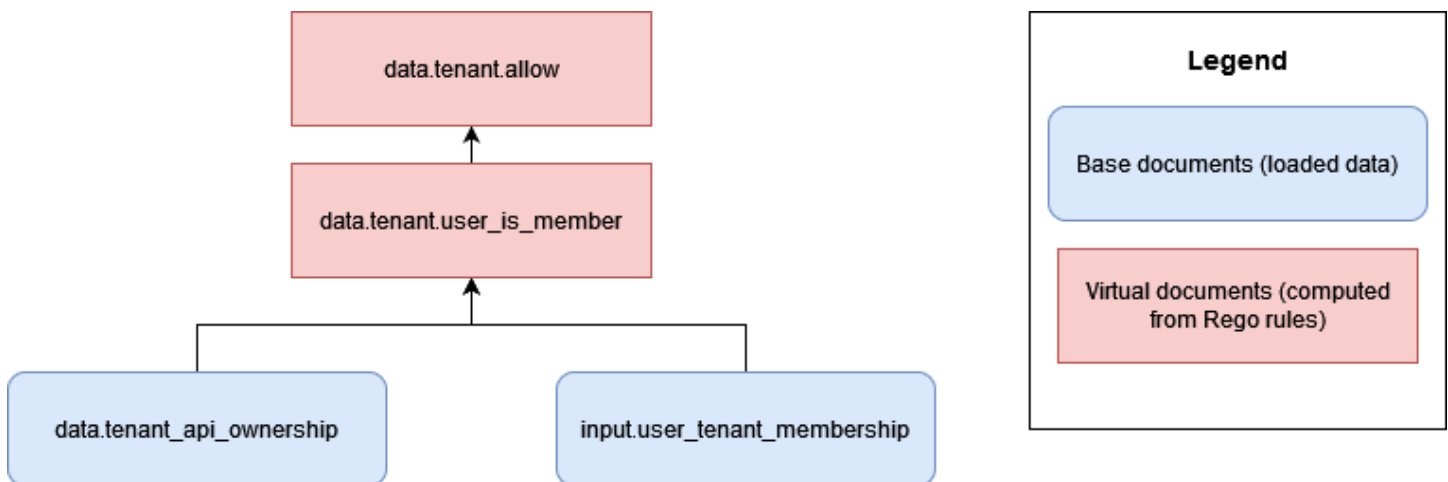

In this approach, OPA doesn't have access to any tenant-specific data except for information about which tenants own an API. In this case, there is no concern over OPA facilitating cross-tenant access, because the only information OPA uses to make an access decision is a user's association with a tenant and the tenant's association with APIs. You could apply this type of OPA document model to a siloed SaaS model, because each tenant would have ownership of independent resources.

However, in many RBAC authorization approaches, there is the potential for cross-tenant exposure of information. In the following example, a hypothetical OPA document model allows access to an API based on whether a user is a member of a tenant, and whether the user has the correct role to access the the API.

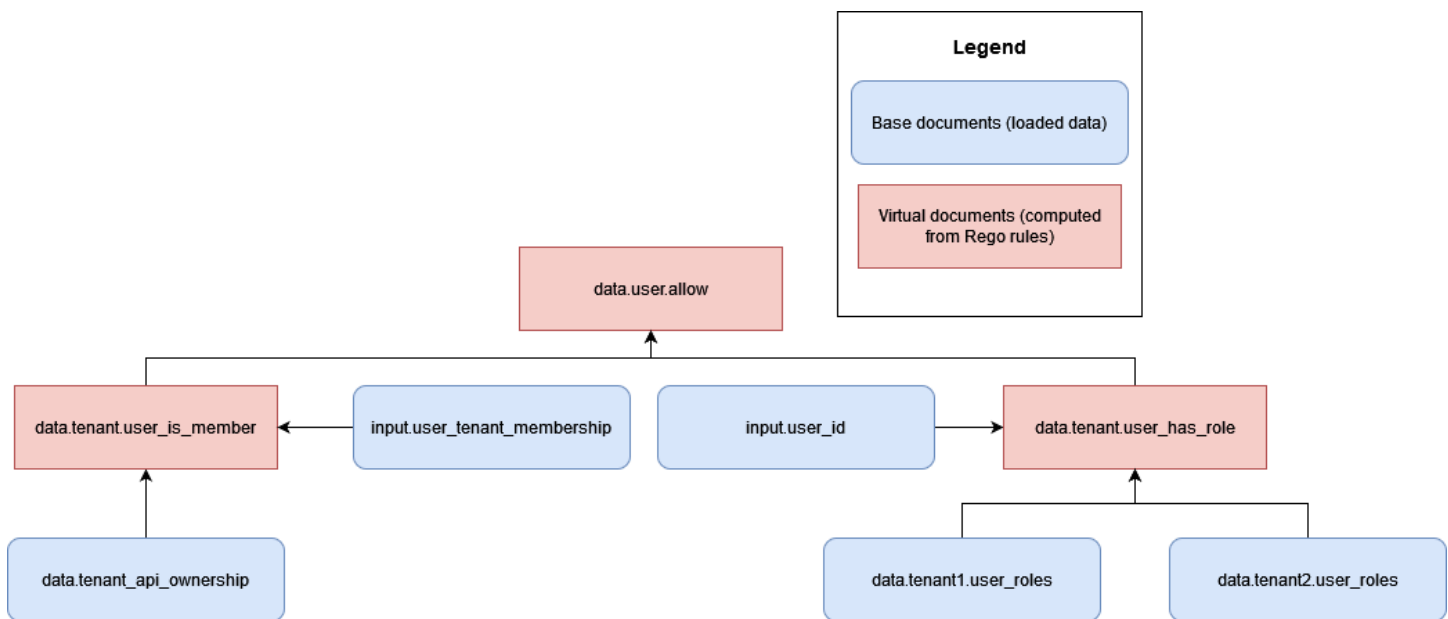

This model introduces a risk of cross-tenant access, because multiple tenants' roles and permissions in `data.tenant1.user_roles` and `data.tenant2.user_roles` must now be made accessible to OPA to make authorization decisions. To maintain tenant isolation and the privacy of role mapping, this data should not reside within OPA. RBAC data should reside in an external data source such as a database. Furthermore, OPA should not be used to map predefined roles to specific permissions, because this makes it difficult for tenants to define their own roles and permissions. It also makes your authorization logic rigid and in need of constant update. For guidance on how to safely incorporate RBAC data into the OPA decision-making process, see the section [Recommendations for tenant isolation and data privacy](#) later in this guide.

You can easily maintain tenant isolation in OPA by not storing any tenant-specific data as an asynchronous base document. An asynchronous base document is data that is stored in memory and can be periodically updated, in OPA. Other base documents, such as OPA input, are passed synchronously and are available only at decision time. For example, providing tenant-specific data as part of OPA input to a query would not constitute a breach of tenant isolation, because that data is available only synchronously during the process of making a decision.

## Tenant onboarding

The structure of OPA documents must allow for straightforward tenant onboarding without introducing cumbersome requirements. You can organize virtual documents in the OPA document model hierarchy with packages, and these packages can contain many rules. When you plan an OPA document model for a multi-tenant application, first determine which data is necessary for OPA



to make a decision. You can provide data as input, pre-load it into OPA, or provide it from external data sources at decision time or periodically. For more information about using external data with OPA, see the section [Retrieving external data for a PDP in OPA](#) later in this guide.

After you determine the data that is required to make a decision in OPA, consider how to implement OPA rules organized as packages, to make decisions with that data. For example, in a siloed SaaS model where each tenant might have unique requirements for how authorization decisions are made, you could implement tenant-specific OPA packages of rules.

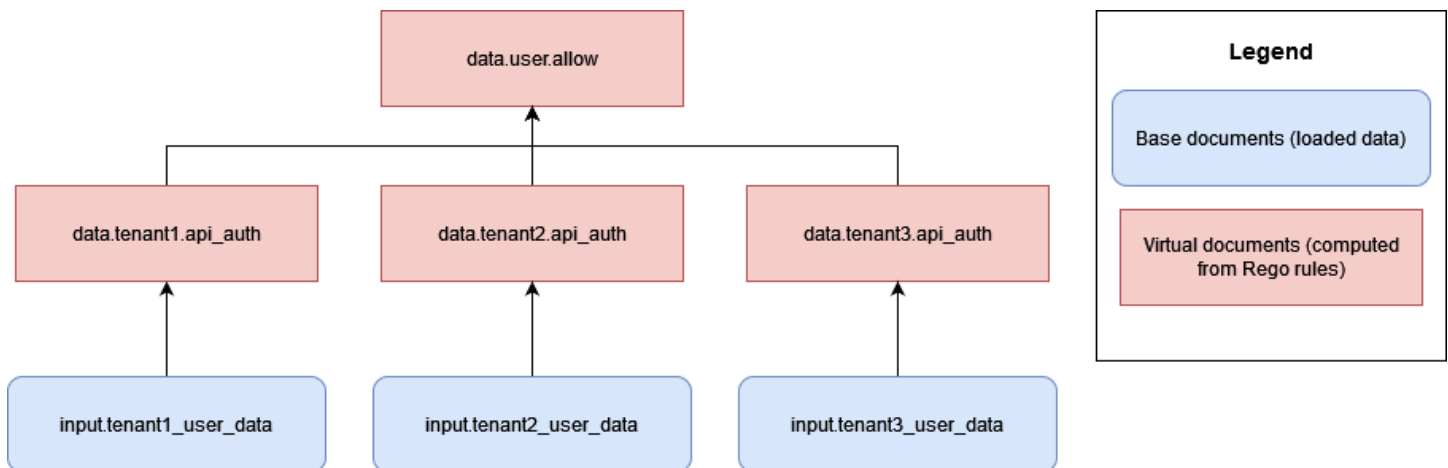

The downside of this approach is that you must add a new set of OPA rules, specific for each tenant, for each tenant that you add to your SaaS application. This is cumbersome and difficult to scale, but might be unavoidable depending on the requirements of your tenants.

Alternatively, in a pooled SaaS model, if all tenants make authorization decisions based on the same rules and use the same data structure, you could use standard OPA packages that have generally applicable rules to make it easier to onboard tenants and scale your OPA implementation.

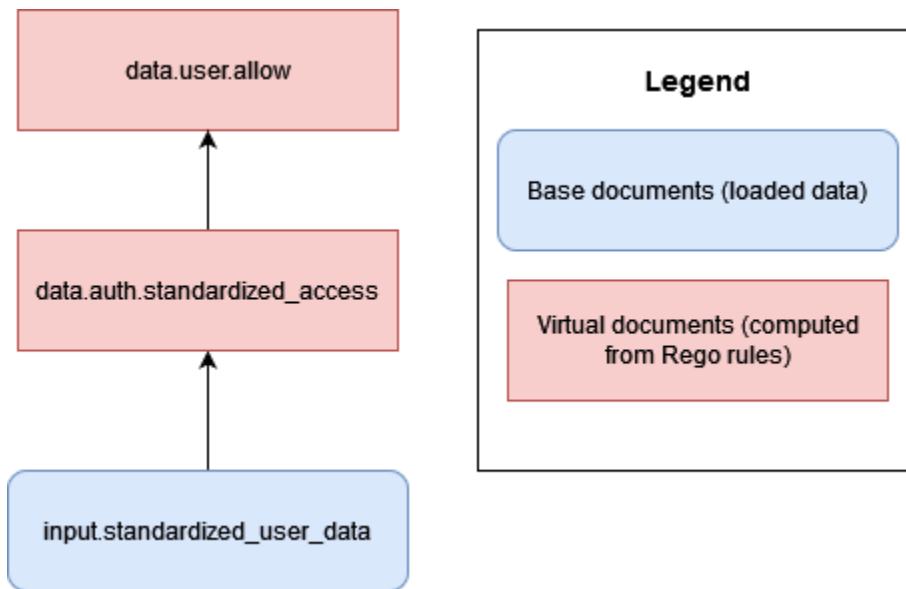

Where possible, we recommend that you use generalized OPA rules and packages (or virtual documents) to make decisions based on standardized data provided by each tenant. This approach makes OPA easily scalable, because you only change the data provided to OPA for each tenant—not how OPA provides its decisions through its rules. It is only necessary to introduce a rules-per-tenant model when individual tenants require unique decisions or have to provide OPA with different data than other tenants.

# DevOps, monitoring, logging, and retrieving data for a PDP

In this proposed authorization paradigm, policies are centralized in the authorization service. This centralization is deliberate because one of the goals of the design models discussed in this guide is to achieve *policy decoupling*, or the removal of authorization logic from other components in the application. Both Amazon Verified Permissions and the Open Policy Agent (OPA) provide mechanisms for updating policies when changes to authorization logic are necessary.

In the case of Verified Permissions, mechanisms for programmatically updating policies are offered by the AWS SDK (see the [Amazon Verified Permissions API Reference Guide](#)). Using the SDK, you can push new policies on demand. Additionally, because Verified Permissions is a managed service, you don't have to manage, configure, or maintain control planes or agents to perform updates. However, we recommend that you use a continuous integration and continuous deployment (CI/CD) pipeline to administer the deployment of Verified Permissions policy stores and policy updates using the AWS SDK.

Verified Permissions provides easy access to observability features. It can be configured to log all access attempts to AWS CloudTrail, Amazon CloudWatch log groups, Amazon Simple Storage Service (Amazon S3) buckets, or Amazon Data Firehose delivery streams to enable a quick response to security incidents and audit requests. Additionally, you can monitor the health of the Verified Permissions service through the AWS Health Dashboard. Because Verified Permissions is a managed service, its health is maintained by AWS, and you can configure observability features by using other AWS managed services.

In the case of OPA, REST APIs offer ways to programmatically update policies. You can configure the APIs to pull new versions of policy bundles from established locations or to push policies on demand. Additionally, OPA offers a basic discovery service where new agents can be configured dynamically and managed centrally by a control plane that distributes discovery bundles. (The control plane for OPA must be set up and configured by the OPA operator.) We recommend that you create a robust CI/CD pipeline for versioning, verifying, and updating policies, whether the policy engine is Verified Permissions, OPA, or another solution.

For OPA, the control plane also provides options for monitoring and auditing. You can export the logs that contain OPA's authorization decisions to remote HTTP servers for log aggregation. These decision logs are invaluable for auditing purposes.

If you are considering adopting an authorization model where access control decisions are decoupled from your application, make sure that your authorization service has effective monitoring, logging, and CI/CD management capabilities for onboarding new PDPs or updating policies.

## Topics

- [Retrieving external data for a PDP in Amazon Verified Permissions](#)
- [Retrieving external data for a PDP in OPA](#)
- [Recommendations for tenant isolation and privacy of data](#)

## Retrieving external data for a PDP in Amazon Verified Permissions

Amazon Verified Permissions doesn't support retrieving external data for a PDP, but it can store user-provided data as part of its schema. As in OPA, if all data for an authorization decision can be provided as part of an authorization request or as part of a JSON Web Token (JWT) that is passed as part of the request, no additional configuration is required. However, you can provide additional data from external sources to Verified Permissions through the authorization request as part of an application's authorizer service that calls Verified Permissions. For example, an application's authorizer service can query an external source such as DynamoDB or Amazon RDS for data, and these services can then include the externally provided data as part of an authorization request.

The following diagram shows an example of how additional data can be retrieved and incorporated into a Verified Permissions authorization request. It might be necessary to use this method to retrieve data such as RBAC role mappings, to retrieve additional attributes that are relevant to resources or principals, or in cases where data resides in different parts of an application and cannot be provided through an identity provider (IdP) token.

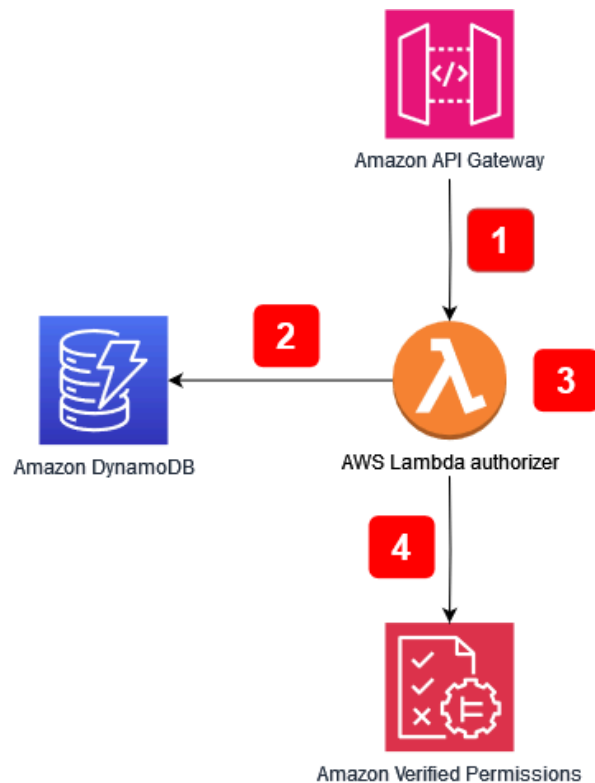

### Application flow:

1. The application receives an API call to Amazon API Gateway and forwards the call to the AWS Lambda authorizer.
2. The Lambda authorizer calls Amazon DynamoDB to retrieve additional data about the principal that made the request.
3. The Lambda authorizer incorporates the additional data into the authorization request that was made to Verified Permissions.
4. The Lambda authorizer makes an authorization request to Verified Permissions and receives an authorization decision.

The diagram includes a feature of Amazon API Gateway called a [Lambda authorizer](#). Although this feature might not be available for APIs that are provided by other services or applications, you can replicate the general model of using an authorizer to fetch additional data to incorporate into a Verified Permissions authorization request across a multitude of use cases.

## Retrieving external data for a PDP in OPA

For OPA, if all data required for an authorization decision can be provided as input or as part of a JSON Web Token (JWT) passed as a component of the query, no additional configuration is required. (It is relatively simple to pass JWTs and SaaS context data to OPA as part of query input.) OPA can accept arbitrary JSON input in what is called the *overload input* approach. If a PDP requires data beyond what can be included as input or a JWT, OPA provides several options for retrieving this data. These include bundling, pushing data (replication), and dynamic data retrieval.

### OPA bundling

The OPA bundling feature supports the following process for external data retrieval:

1. The policy enforcement point (PEP) requests an authorization decision.
2. OPA downloads new policy bundles, including external data.
3. The bundling service replicates data from data source(s).

When you use the bundling feature, OPA periodically downloads policy and data bundles from a centralized bundle service. (OPA doesn't provide the implementation and setup of a bundle service.) All policies and external data that are pulled from the bundle service are stored in memory. This option will not work if the external data size is too large to be stored in memory, or if the data changes too frequently.

For more information about the bundling feature, see the [OPA documentation](#).

### OPA replication (pushing data)

The OPA replication approach supports the following process for external data retrieval:

1. The PEP requests an authorization decision.
2. The data replicator pushes data to OPA.
3. The data replicator replicates data from data source(s).

In this alternative to the bundling approach, data is pushed to, instead of being periodically pulled by, OPA. (OPA doesn't provide the implementation and setup of a replicator.) The push approach has the same data size limitations as the bundling approach, because OPA stores all the data in

memory. The primary advantage of the push option is that you can update data in OPA with deltas instead of replacing all the external data each time. This makes the push option more appropriate for datasets that change frequently.

For more information about the replication option, see the [OPA documentation](#).

## OPA dynamic data retrieval

If the external data to be retrieved is too large to be cached in OPA's memory, the data can be dynamically pulled from an external source during the evaluation of an authorization decision. When you use this approach, data is always up to date. This approach has two drawbacks: network latency and accessibility. Currently, OPA can retrieve data at runtime only through an HTTP request. If the calls that go to an external data source cannot return data as an HTTP response, they require a custom API or some other mechanism to provide this data to OPA. Because OPA can retrieve data only through HTTP requests, and the speed of retrieving the data is pivotal, we recommend that you use an AWS service such as Amazon DynamoDB to hold external data when possible.

For more information about the pull approach, see the [OPA documentation](#).

## Using an authorization service for implementation with OPA

When you fetch external data by using bundling, replication, or a dynamic pull approach, we recommend that the authorization service facilitate this interaction. This is because the authorization service can retrieve external data and transform it into JSON for OPA to make authorization decisions. The following diagram shows how an authorization service can function with these three external data retrieval approaches.

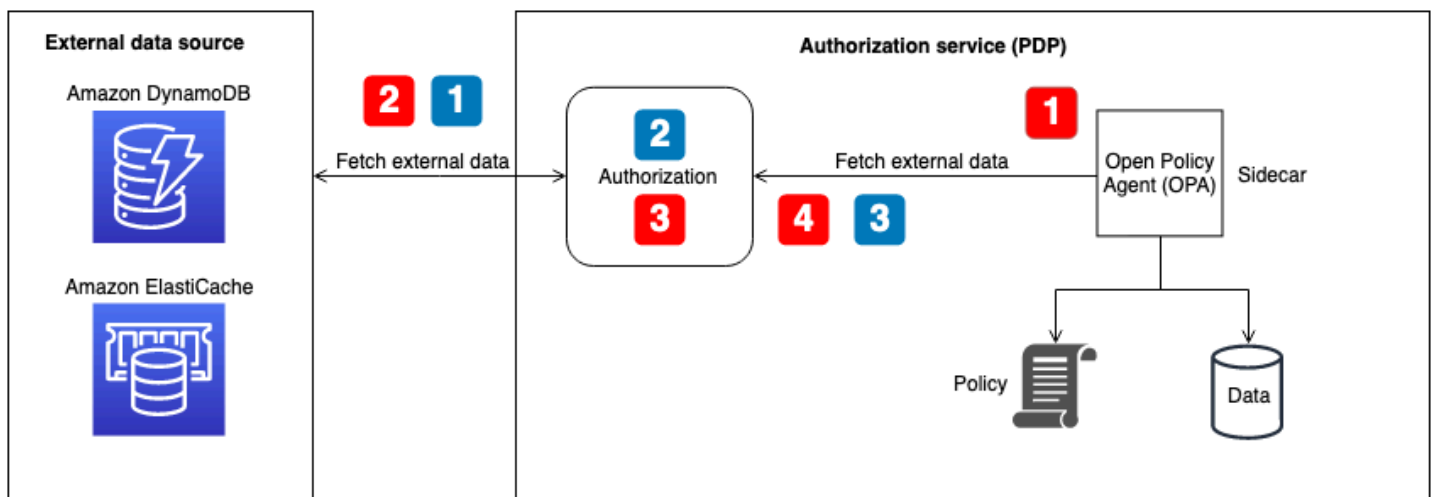

## Retrieving external data for OPA flow – bundle or dynamic data retrieval at decision time

(illustrated with red numbered callouts in the diagram):

1. OPA calls the local API endpoint for the authorization service, which is configured as a bundle endpoint or the endpoint for dynamic data retrieval during authorization decisions.
2. The authorization service queries or calls the external data source to retrieve external data. (For a bundle endpoint, this data should also contain OPA policies and rules. Bundle updates replace everything—both data and policies—in OPA's cache.)
3. The authorization service performs any transformation necessary on the returned data to turn it into the expected JSON input.
4. The data is returned to OPA. It is cached in memory for bundle configuration and used immediately for dynamic authorization decisions.

**Retrieving external data for OPA flow – replicator** (illustrated with blue numbered callouts in the diagram):

1. The replicator (part of the authorization service) calls the external data source and retrieves any data to be updated in OPA. This can include policies, rules, and external data. This call can be on a set cadence, or it can happen in response to data updates in the external source.
2. The authorization service performs any transformations necessary on the returned data to turn it into the expected JSON input.
3. The authorization service calls OPA and caches the data in memory. The authorization service can selectively update data, policies, and rules.

## Recommendations for tenant isolation and privacy of data

The previous section provided several approaches for using external data with OPA and Amazon Verified Permissions to assist in making authorization decisions. Where possible, we recommend that you use the overload input approach for passing SaaS context data to OPA to make authorization decisions instead of storing data in OPA's memory. This use case doesn't apply to AWS Cloud Map, because it doesn't support storing external data in the service.

In role-based access control (RBAC) or RBAC and attribute-based access control (ABAC) hybrid models, the data provided solely by an authorization request or query might be insufficient, because roles and permissions have to be referenced to make authorization decisions. **To maintain**



**tenant isolation and the privacy of role mapping, this data should not reside within OPA.**

RBAC data should reside in an external data source such as a database or should be passed as part of claims in a JWT from an IdP. In Verified Permissions, RBAC data can be maintained as part of policies and schema in the per-tenant policy store model, because each tenant has its own logically separated policy store. However, **in the one shared multi-tenant policy store model, role mapping data should not reside within Verified Permissions to maintain tenant isolation.**

Furthermore, OPA and Verified Permissions shouldn't be used to map predefined roles to specific permissions, because this makes it difficult for tenants to define their own roles and permissions. It also makes your authorization logic rigid and in need of constant update. The exception to this guideline is the per-tenant policy store model in Verified Permissions, because this model allows each tenant to have its own policies that can be evaluated independently on a per-tenant basis.

## Amazon Verified Permissions

The only place where Verified Permissions can store potentially private RBAC data is in the schema. This is acceptable in the per-tenant policy store model, because each tenant has its own logically separated policy store. However, it could compromise tenant isolation in the one shared multi-tenant policy store model. In cases where this data is required to make an authorization decision, it should be retrieved from an external source such as DynamoDB or Amazon RDS and incorporated into the Verified Permissions authorization request.

## OPA

Secure approaches with OPA for maintaining the privacy and tenant isolation of RBAC data include using dynamic data retrieval or replication to get external data. This is because you can use the authorization service illustrated in the previous diagram to provide only tenant-specific or user-specific external data for making an authorization decision. For example, you can use a replicator to provide RBAC data or a permissions matrix to the OPA cache when a user logs in, and have the data be referenced based on a user provided in the input data. You can use a similar approach with dynamically pulled data to retrieve only the relevant data for making authorization decisions. Furthermore, in the dynamic data retrieval approach, this data doesn't have to be cached in OPA. The bundling approach isn't as effective as the dynamic retrieval approach at maintaining tenant isolation, because it updates everything in the OPA cache and can't process precise updates. The bundling model is still a good approach for updating OPA policies and non-RBAC data.

## Best practices

This section lists some of the high-level takeaways from this guide. For detailed discussions on each point, follow the links to the corresponding sections.

### Select an access control model that works for your application

This guide discusses several [access control models](#). Depending on your application and business requirements, you should select a model that works for you. Consider how you can use these models to fulfill your access control needs, and how your access control needs might evolve, requiring changes to your selected approach.

### Implement a PDP

The [policy decision point \(PDP\)](#) can be characterized as a policy or rules engine. This component is responsible for applying policies or rules and returning a decision on whether a particular access is permitted. A PDP allows authorization logic in application code to be offloaded to a separate system. This can simplify application code. It also provides an easy-to-use idempotent interface for making authorization decisions for APIs, microservices, Backend for Frontend (BFF) layers, or any other application component. A PDP can be used to enforce tenancy requirements consistently across an application.

### Implement PEPs for every API in your application

The implementation of a [policy enforcement point \(PEP\)](#) requires determining where access control enforcement should occur in an application. As a first step, locate the points in your application where you can incorporate PEPs. Consider this principle when deciding where to add PEPs:

*If an application exposes an API, there should be authorization and access control on that API.*

### Consider using Amazon Verified Permissions or OPA as a policy engine for your PDP

Amazon Verified Permissions has advantages over custom policy engines. It is a scalable, fine-grained permissions management and authorization service for the applications that you build. It supports writing policies in the high-level declarative open-source language Cedar. As a result,

implementing a policy engine by using Verified Permissions requires less development effort than implementing your own solution. In addition, Verified Permissions is fully managed, so you don't have to manage the underlying infrastructure.

The Open Policy Agent (OPA) has advantages over custom policy engines. OPA and its policy evaluation with Rego provide a flexible, pre-built policy engine that supports writing policies in a high-level declarative language. This makes the level of effort required for implementing a policy engine significantly less than building your own solution. Furthermore, OPA is quickly becoming a well-supported authorization standard.

## Implement a control plane for OPA for DevOps, monitoring, and logging

Because OPA doesn't provide a means to update and track changes to authorization logic through source control, we recommend that you [implement a control plane](#) to perform these functions. This will allow for updates to be more easily distributed to OPA agents, particularly if OPA is operating in a distributed system, which will reduce the administrative burden of using OPA. Additionally, a control plane can be used to collect logs for aggregation and to monitor the status of OPA agents.

## Configure logging and observability features in Verified Permissions

Verified Permissions provides easy access to observability features. You can configure the service to log all access attempts to AWS CloudTrail, Amazon CloudWatch log groups, S3 buckets, or Amazon Data Firehose delivery streams to enable a quick response to security incidents and audit requests. Additionally, you can monitor the health of the service through the AWS Health Dashboard. Because Verified Permissions is a managed service, its health is maintained by AWS, and you can configure its observability features by using other AWS managed services.

## Use a CI/CD pipeline to provision and update policy stores and policies in Verified Permissions

Verified Permissions is a managed service, so you don't have to manage, configure, or maintain control planes or agents to perform updates. However, we still recommend that you use a

continuous integration and continuous deployment (CI/CD) pipeline to administer the deployment of Verified Permissions policy stores and policy updates by using the AWSSDK. This effort can remove manual effort and reduce the likelihood of operator errors when you make changes to Verified Permissions resources.

## Determine whether external data is required for authorization decisions, and select a model to accommodate it

If a PDP can make authorization decisions based solely on data that is contained in a JSON Web Token (JWT), it is usually not necessary to import external data to assist in making these decisions. If you use Verified Permissions or OPA as a PDP, it can also accept additional input that is passed as part of the request, even if this data isn't included in a JWT. For Verified Permissions, you can use a context parameter for the additional data. For OPA, you can use JSON data as overload input. If you use a JWT, context or overload input methods are generally far easier than maintaining external data in another source. If more complex external data is required to make authorization decisions, [OPA offers several models for retrieving external data](#), and Verified Permissions can supplement data in its authorization requests by referencing external sources with an authorization service.

## FAQ

This section provides answers to commonly raised questions about implementing API access control and authorization in multi-tenant SaaS applications.

### **Q. What is the difference between authorization and authentication?**

**A.** Authentication is the process of verifying who a user is. Authorization grants permissions to users to access a specific resource.

### **Q. What is the difference between authorization and tenant isolation in a SaaS application?**

**A.** Tenant isolation refers to explicit mechanisms that are used in a SaaS system to ensure that each tenant's resources, even when operating on shared infrastructure, are isolated. Multi-tenant authorization refers to the authorization of inbound actions and preventing them from being implemented on the wrong tenant. A hypothetical user could be authenticated and authorized, but might still be able to access the resources of another tenant. Nothing about authentication and authorization necessarily blocks this access, but tenant isolation is required to achieve this objective. For more information about these two concepts, see the [tenant isolation](#) discussion in the *AWS SaaS Architecture Fundamentals* whitepaper.

### **Q. Why do I need to consider tenant isolation for my SaaS application?**

**A.** SaaS applications have multiple tenants. A tenant can be a customer organization or any external entity that uses that SaaS application. Depending on how the application is designed, this means that tenants may be accessing shared APIs, databases, or other resources. It is important to maintain tenant isolation—that is, constructs that tightly control access to resources, and block any attempt to access resources of another tenant—to prevent users from one tenant accessing another tenant's private information. SaaS applications are often designed to make sure that tenant isolation is maintained throughout an application and that tenants can access only their own resources.

### **Q. Why do I need an access control model?**

**A.** Access control models are used to create a consistent method of determining how to grant access to resources in an application. This can be done by assigning roles to users that are closely aligned with business logic, or it can be based on other contextual attributes such as the time of day or whether a user meets a predefined condition. Access control models form the basic logic your application uses when making authorization decisions to determine the user permissions.

**Q. Is API access control necessary for my application?**

**A.** Yes. APIs should always verify that the caller has the appropriate access. Pervasive API access control also ensures that access is only granted based on tenants so that appropriate isolation can be maintained.

**Q. Why are policy engines or PDPs recommended for authorization?**

**A.** A policy decision point (PDP) allows authorization logic in application code to be offloaded to a separate system. This can simplify application code. It also provides an easy-to-use idempotent interface for making authorization decisions for APIs, microservices, Backend for Frontend (BFF) layers, or any other application component.

**Q. What is a PEP?**

**A.** A policy enforcement point (PEP) is responsible for receiving authorization requests that are sent to the PDP for evaluation. A PEP can be anywhere in an application where data and resources must be protected, or where authorization logic is applied. PEPs are relatively simple compared to PDPs. A PEP is responsible only for requesting and evaluating an authorization decision and does not require any authorization logic to be incorporated into it.

**Q. How should I choose between Amazon Verified Permissions and OPA?**

**A.** To choose between Verified Permissions and Open Policy Agent (OPA), always keep your use case and your unique requirements in mind. Verified Permissions provides a fully managed way to define fine-grained permissions, audit permissions across applications, and centralize the policy administration system for your applications while meeting your application latency requirements with millisecond processing. OPA is an open source, general-purpose policy engine that also can help you unify policy across your application stack. In order to run OPA you need to host it in your AWS environment, typically with a container or AWS Lambda functions.

Verified Permissions uses the open source Cedar policy language, whereas OPA uses Rego. Therefore, familiarity with one of these languages might sway you to choose that solution. However, we recommend that you read about both languages and then work back from the problem you're trying to solve to find the best solution for your use case.

**Q. Are there open-source alternatives to Verified Permissions and OPA?**

**A.** There are a few open-source systems that are similar to Verified Permissions and the Open Policy Agent (OPA), such as the [Common Expression Language \(CEL\)](#). This guide focuses on on

both Verified Permissions, as a scalable permissions management and fine-grained authorization service, and OPA, which is widely adopted, documented, and adaptable to many different types of applications and authorization requirements.

**Q. Do I need to write an authorization service to use OPA, or can I interact with OPA directly?**

**A.** You can interact with OPA directly. An authorization service in the context of this guidance refers to a service that translates authorization decision requests into OPA queries, and vice versa. If your application can query and accept OPA responses directly, there is no need to introduce this additional complexity.

**Q. How do I monitor my OPA agents for uptime and auditing purposes?**

**A.** OPA provides logging and basic uptime monitoring, although its default configuration will likely be insufficient for enterprise deployments. For more information, see the [DevOps, monitoring, and logging](#) section earlier in this guide.

**Q. How can I monitor Verified Permissions for uptime and auditing purposes?**

**A.** Verified Permissions is an AWS managed service, and can be monitored for availability through the AWS Health Dashboard. Additionally, Verified Permissions is capable of logging to AWS CloudTrail, Amazon CloudWatch Logs, Amazon S3, and Amazon Data Firehose.

**Q. Which operating systems and AWS services can I use to run OPA?**

**A.** You can [run OPA on macOS, Windows, and Linux](#). OPA agents can be configured on Amazon Elastic Compute Cloud (Amazon EC2) agents as well as containerization services such as Amazon Elastic Container Service (Amazon ECS) and Amazon Elastic Kubernetes Service (Amazon EKS).

**Q. Which operating systems and AWS services can I use to run Verified Permissions?**

**A.** Verified Permissions is an AWS managed service and is operated by AWS. No additional configuration, installation, or hosting is necessary to use Verified Permissions except for the capability to make authorization requests to the service.

**Q. Can I run OPA on AWS Lambda?**

**A.** You can run OPA on Lambda as a Go library. For information about how you can do this for an [API Gateway Lambda authorizer](#), see the AWS blog post [Creating a custom Lambda authorizer using Open Policy Agent](#).

**Q. How should I decide between a distributed PDP and centralized PDP approach?**

**A.** This depends on your application. It will most likely be determined based on the latency difference between a distributed and centralized PDP model. We recommend that you build a proof of concept and test your application's performance to verify your solution.

**Q. Can I use OPA for use cases besides APIs?**

**A.** Yes. The OPA documentation provides examples for [Kubernetes](#), [Envoy](#), [Docker](#), [Kafka](#), [SSH and sudo](#), and [Terraform](#). Additionally, OPA can return arbitrary JSON responses to queries by using Rego partial rules. Depending on the query, OPA can be used to answer many questions with JSON responses.

**Q. Can I use Verified Permissions for use cases besides APIs?**

**A.** Yes. Verified Permissions can provide an ALLOW or DENY response for any authorization request it receives. Verified Permissions can provide authorization responses for any application or service that requires authorization decisions.

**Q. Can I create policies in Verified Permissions by using the IAM policy language?**

**A.** No. You must use the Cedar policy language to author policies. Cedar is designed to support permissions management for customer application resources, whereas the AWS Identity and Access Management (IAM) policy language evolved to support access control for AWS resources.



## Next steps

The complexity of authorization and API access control for multi-tenant SaaS applications can be overcome by adopting a standardized, language-agnostic approach to making authorization decisions. These approaches incorporate policy decision points (PDPs) and policy enforcement points (PEPs) that enforce access in a flexible and pervasive manner. Multiple approaches to access control—such as role-based access control (RBAC), attribute-based access control (ABAC), or a combination of the two—can be incorporated into a cohesive access control strategy. Removing authorization logic from an application eliminates the overhead of including ad hoc solutions in application code to address access control. The implementation and best practices discussed in this guide are intended to inform and standardize an approach to the implementation of authorization and API access control in multi-tenant SaaS applications. You can use this guidance as the first step in gathering information and designing a robust access control and authorization system for your application. **Next steps:**

- Review your authorization and tenant isolation needs, and select an access control model for your application.
- Build a proof of concept for testing by using either [Amazon Verified Permissions](#) or [Open Policy Agent \(OPA\)](#), or by writing your own custom policy engine.
- Identify APIs and locations in your application where PEPs should be implemented.

# Resources

## References

- [Amazon Verified Permissions documentation](#) (AWS documentation)
- [How to use Amazon Verified Permissions for authorization](#) (AWS blog post)
- [Implement a Custom Authorization Policy Provider for ASP.NET Core Apps using Amazon Verified Permissions](#) (AWS blog post)
- [Manage Roles and entitlements with PBAC using Amazon Verified Permissions](#) (AWS blog post)
- [SaaS access control using Amazon Verified Permissions with a per-tenant policy store](#) (AWS blog post)
- [The OPA official documentation](#)
- [Why Enterprises Must Embrace The Most Recently Graduated CNCF Project – Open Policy Agent](#) (Forbes article by Janakiram MSV, February 8, 2021)
- [Creating a custom Lambda authorizer using Open Policy Agent](#) (AWS blog post)
- [Realize policy as code with AWS Cloud Development Kit through Open Policy Agent](#) (AWS blog post)
- [Cloud governance and compliance on AWS with policy as code](#) (AWS blog post)
- [Using Open Policy Agent on Amazon EKS](#) (AWS blog post)
- [Compliance as Code for Amazon ECS using Open Policy Agent, Amazon EventBridge, and AWS Lambda](#) (AWS blog post)
- [Policy-based countermeasures for Kubernetes – Part 1](#) (AWS blog post)
- [Using API Gateway Lambda authorizers](#) (AWS documentation)

## Tools

- [The Cedar Playground](#) (for testing Cedar in a browser)
- [Cedar Github repository](#)
- [Cedar Language Reference](#)
- [The Rego Playground](#) (for testing Rego in a browser)
- [OPA GitHub repository](#)

## Partners

- [Identity and Access Management Partners](#)
- [Application Security Partners](#)
- [Cloud Governance Partners](#)
- [Security and Compliance Partners](#)
- [Security Operations and Automation Partners](#)
- [Security Engineering Partners](#)

## Document history

The following table describes significant changes to this guide. If you want to be notified about future updates, you can subscribe to an [RSS feed](#).

Change	Description	Date
<a href="#">Added details and examples for Amazon Verified Permissions</a>	Added detailed discussions, examples, and code for using Amazon Verified Permissions to implement a PDP. New sections include: <ul style="list-style-type: none"><li>• <a href="#">Implementing a PDP by using Amazon Verified Permissions</a></li><li>• <a href="#">Design models for Amazon Verified Permissions</a></li><li>• <a href="#">Amazon Verified Permissions multi-tenant design considerations</a></li><li>• <a href="#">Retrieving external data for a PDP in Amazon Verified Permissions</a></li></ul>	May 28, 2024
<a href="#">Clarified information</a>	Clarified the <a href="#">distributed PDP with PEPs on APIs</a> design model.	January 10, 2024
<a href="#">Added brief information about new AWS service</a>	Added information about <a href="#">Amazon Verified Permissions</a> , which provides the same functionality and benefits as OPA.	May 22, 2023
<a href="#">=</a>	Initial publication	August 17, 2021

# AWS Prescriptive Guidance glossary

The following are commonly used terms in strategies, guides, and patterns provided by AWS Prescriptive Guidance. To suggest entries, please use the **Provide feedback** link at the end of the glossary.

## Numbers

### 7 Rs

Seven common migration strategies for moving applications to the cloud. These strategies build upon the 5 Rs that Gartner identified in 2011 and consist of the following:

- Refactor/re-architect – Move an application and modify its architecture by taking full advantage of cloud-native features to improve agility, performance, and scalability. This typically involves porting the operating system and database. Example: Migrate your on-premises Oracle database to the Amazon Aurora PostgreSQL-Compatible Edition.
- Replatform (lift and reshape) – Move an application to the cloud, and introduce some level of optimization to take advantage of cloud capabilities. Example: Migrate your on-premises Oracle database to Amazon Relational Database Service (Amazon RDS) for Oracle in the AWS Cloud.
- Repurchase (drop and shop) – Switch to a different product, typically by moving from a traditional license to a SaaS model. Example: Migrate your customer relationship management (CRM) system to Salesforce.com.
- Rehost (lift and shift) – Move an application to the cloud without making any changes to take advantage of cloud capabilities. Example: Migrate your on-premises Oracle database to Oracle on an EC2 instance in the AWS Cloud.
- Relocate (hypervisor-level lift and shift) – Move infrastructure to the cloud without purchasing new hardware, rewriting applications, or modifying your existing operations. You migrate servers from an on-premises platform to a cloud service for the same platform. Example: Migrate a Microsoft Hyper-V application to AWS.
- Retain (revisit) – Keep applications in your source environment. These might include applications that require major refactoring, and you want to postpone that work until a later time, and legacy applications that you want to retain, because there's no business justification for migrating them.

- **Retire** – Decommission or remove applications that are no longer needed in your source environment.

## A

### ABAC

See [attribute-based access control](#).

### abstracted services

See [managed services](#).

### ACID

See [atomicity, consistency, isolation, durability](#).

### active-active migration

A database migration method in which the source and target databases are kept in sync (by using a bidirectional replication tool or dual write operations), and both databases handle transactions from connecting applications during migration. This method supports migration in small, controlled batches instead of requiring a one-time cutover. It's more flexible but requires more work than [active-passive migration](#).

### active-passive migration

A database migration method in which the source and target databases are kept in sync, but only the source database handles transactions from connecting applications while data is replicated to the target database. The target database doesn't accept any transactions during migration.

### aggregate function

A SQL function that operates on a group of rows and calculates a single return value for the group. Examples of aggregate functions include SUM and MAX.

### AI

See [artificial intelligence](#).

### AIOps

See [artificial intelligence operations](#).

## anonymization

The process of permanently deleting personal information in a dataset. Anonymization can help protect personal privacy. Anonymized data is no longer considered to be personal data.

## anti-pattern

A frequently used solution for a recurring issue where the solution is counter-productive, ineffective, or less effective than an alternative.

## application control

A security approach that allows the use of only approved applications in order to help protect a system from malware.

## application portfolio

A collection of detailed information about each application used by an organization, including the cost to build and maintain the application, and its business value. This information is key to [the portfolio discovery and analysis process](#) and helps identify and prioritize the applications to be migrated, modernized, and optimized.

## artificial intelligence (AI)

The field of computer science that is dedicated to using computing technologies to perform cognitive functions that are typically associated with humans, such as learning, solving problems, and recognizing patterns. For more information, see [What is Artificial Intelligence?](#)

## artificial intelligence operations (AIOps)

The process of using machine learning techniques to solve operational problems, reduce operational incidents and human intervention, and increase service quality. For more information about how AIOps is used in the AWS migration strategy, see the [operations integration guide](#).

## asymmetric encryption

An encryption algorithm that uses a pair of keys, a public key for encryption and a private key for decryption. You can share the public key because it isn't used for decryption, but access to the private key should be highly restricted.

## atomicity, consistency, isolation, durability (ACID)

A set of software properties that guarantee the data validity and operational reliability of a database, even in the case of errors, power failures, or other problems.

## attribute-based access control (ABAC)

The practice of creating fine-grained permissions based on user attributes, such as department, job role, and team name. For more information, see [ABAC for AWS](#) in the AWS Identity and Access Management (IAM) documentation.

## authoritative data source

A location where you store the primary version of data, which is considered to be the most reliable source of information. You can copy data from the authoritative data source to other locations for the purposes of processing or modifying the data, such as anonymizing, redacting, or pseudonymizing it.

## Availability Zone

A distinct location within an AWS Region that is insulated from failures in other Availability Zones and provides inexpensive, low-latency network connectivity to other Availability Zones in the same Region.

## AWS Cloud Adoption Framework (AWS CAF)

A framework of guidelines and best practices from AWS to help organizations develop an efficient and effective plan to move successfully to the cloud. AWS CAF organizes guidance into six focus areas called perspectives: business, people, governance, platform, security, and operations. The business, people, and governance perspectives focus on business skills and processes; the platform, security, and operations perspectives focus on technical skills and processes. For example, the people perspective targets stakeholders who handle human resources (HR), staffing functions, and people management. For this perspective, AWS CAF provides guidance for people development, training, and communications to help ready the organization for successful cloud adoption. For more information, see the [AWS CAF website](#) and the [AWS CAF whitepaper](#).

## AWS Workload Qualification Framework (AWS WQF)

A tool that evaluates database migration workloads, recommends migration strategies, and provides work estimates. AWS WQF is included with AWS Schema Conversion Tool (AWS SCT). It analyzes database schemas and code objects, application code, dependencies, and performance characteristics, and provides assessment reports.



## B

### bad bot

A [bot](#) that is intended to disrupt or cause harm to individuals or organizations.

### BCP

See [business continuity planning](#).

### behavior graph

A unified, interactive view of resource behavior and interactions over time. You can use a behavior graph with Amazon Detective to examine failed logon attempts, suspicious API calls, and similar actions. For more information, see [Data in a behavior graph](#) in the Detective documentation.

### big-endian system

A system that stores the most significant byte first. See also [endianness](#).

### binary classification

A process that predicts a binary outcome (one of two possible classes). For example, your ML model might need to predict problems such as "Is this email spam or not spam?" or "Is this product a book or a car?"

### bloom filter

A probabilistic, memory-efficient data structure that is used to test whether an element is a member of a set.

### blue/green deployment

A deployment strategy where you create two separate but identical environments. You run the current application version in one environment (blue) and the new application version in the other environment (green). This strategy helps you quickly roll back with minimal impact.

### bot

A software application that runs automated tasks over the internet and simulates human activity or interaction. Some bots are useful or beneficial, such as web crawlers that index information on the internet. Some other bots, known as *bad bots*, are intended to disrupt or cause harm to individuals or organizations.

## botnet

Networks of [bots](#) that are infected by [malware](#) and are under the control of a single party, known as a *bot herder* or *bot operator*. Botnets are the best-known mechanism to scale bots and their impact.

## branch

A contained area of a code repository. The first branch created in a repository is the *main branch*. You can create a new branch from an existing branch, and you can then develop features or fix bugs in the new branch. A branch you create to build a feature is commonly referred to as a *feature branch*. When the feature is ready for release, you merge the feature branch back into the main branch. For more information, see [About branches](#) (GitHub documentation).

## break-glass access

In exceptional circumstances and through an approved process, a quick means for a user to gain access to an AWS account that they don't typically have permissions to access. For more information, see the [Implement break-glass procedures](#) indicator in the AWS Well-Architected guidance.

## brownfield strategy

The existing infrastructure in your environment. When adopting a brownfield strategy for a system architecture, you design the architecture around the constraints of the current systems and infrastructure. If you are expanding the existing infrastructure, you might blend brownfield and [greenfield](#) strategies.

## buffer cache

The memory area where the most frequently accessed data is stored.

## business capability

What a business does to generate value (for example, sales, customer service, or marketing). Microservices architectures and development decisions can be driven by business capabilities. For more information, see the [Organized around business capabilities](#) section of the [Running containerized microservices on AWS](#) whitepaper.

## business continuity planning (BCP)

A plan that addresses the potential impact of a disruptive event, such as a large-scale migration, on operations and enables a business to resume operations quickly.

## C

### CAF

See [AWS Cloud Adoption Framework](#).

### canary deployment

The slow and incremental release of a version to end users. When you are confident, you deploy the new version and replace the current version in its entirety.

### CCoE

See [Cloud Center of Excellence](#).

### CDC

See [change data capture](#).

### change data capture (CDC)

The process of tracking changes to a data source, such as a database table, and recording metadata about the change. You can use CDC for various purposes, such as auditing or replicating changes in a target system to maintain synchronization.

### chaos engineering

Intentionally introducing failures or disruptive events to test a system's resilience. You can use [AWS Fault Injection Service \(AWS FIS\)](#) to perform experiments that stress your AWS workloads and evaluate their response.

### CI/CD

See [continuous integration and continuous delivery](#).

### classification

A categorization process that helps generate predictions. ML models for classification problems predict a discrete value. Discrete values are always distinct from one another. For example, a model might need to evaluate whether or not there is a car in an image.

### client-side encryption

Encryption of data locally, before the target AWS service receives it.

## Cloud Center of Excellence (CCoE)

A multi-disciplinary team that drives cloud adoption efforts across an organization, including developing cloud best practices, mobilizing resources, establishing migration timelines, and leading the organization through large-scale transformations. For more information, see the [CCoE posts](#) on the AWS Cloud Enterprise Strategy Blog.

## cloud computing

The cloud technology that is typically used for remote data storage and IoT device management. Cloud computing is commonly connected to [edge computing](#) technology.

## cloud operating model

In an IT organization, the operating model that is used to build, mature, and optimize one or more cloud environments. For more information, see [Building your Cloud Operating Model](#).

## cloud stages of adoption

The four phases that organizations typically go through when they migrate to the AWS Cloud:

- Project – Running a few cloud-related projects for proof of concept and learning purposes
- Foundation – Making foundational investments to scale your cloud adoption (e.g., creating a landing zone, defining a CCoE, establishing an operations model)
- Migration – Migrating individual applications
- Re-invention – Optimizing products and services, and innovating in the cloud

These stages were defined by Stephen Orban in the blog post [The Journey Toward Cloud-First & the Stages of Adoption](#) on the AWS Cloud Enterprise Strategy blog. For information about how they relate to the AWS migration strategy, see the [migration readiness guide](#).

## CMDB

See [configuration management database](#).

## code repository

A location where source code and other assets, such as documentation, samples, and scripts, are stored and updated through version control processes. Common cloud repositories include GitHub or Bitbucket Cloud. Each version of the code is called a *branch*. In a microservice structure, each repository is devoted to a single piece of functionality. A single CI/CD pipeline can use multiple repositories.

## cold cache

A buffer cache that is empty, not well populated, or contains stale or irrelevant data. This affects performance because the database instance must read from the main memory or disk, which is slower than reading from the buffer cache.

## cold data

Data that is rarely accessed and is typically historical. When querying this kind of data, slow queries are typically acceptable. Moving this data to lower-performing and less expensive storage tiers or classes can reduce costs.

## computer vision (CV)

A field of [AI](#) that uses machine learning to analyze and extract information from visual formats such as digital images and videos. For example, AWS Panorama offers devices that add CV to on-premises camera networks, and Amazon SageMaker AI provides image processing algorithms for CV.

## configuration drift

For a workload, a configuration change from the expected state. It might cause the workload to become noncompliant, and it's typically gradual and unintentional.

## configuration management database (CMDB)

A repository that stores and manages information about a database and its IT environment, including both hardware and software components and their configurations. You typically use data from a CMDB in the portfolio discovery and analysis stage of migration.

## conformance pack

A collection of AWS Config rules and remediation actions that you can assemble to customize your compliance and security checks. You can deploy a conformance pack as a single entity in an AWS account and Region, or across an organization, by using a YAML template. For more information, see [Conformance packs](#) in the AWS Config documentation.

## continuous integration and continuous delivery (CI/CD)

The process of automating the source, build, test, staging, and production stages of the software release process. CI/CD is commonly described as a pipeline. CI/CD can help you automate processes, improve productivity, improve code quality, and deliver faster. For more information, see [Benefits of continuous delivery](#). CD can also stand for *continuous deployment*. For more information, see [Continuous Delivery vs. Continuous Deployment](#).

## CV

See [computer vision](#).

## D

### data at rest

Data that is stationary in your network, such as data that is in storage.

### data classification

A process for identifying and categorizing the data in your network based on its criticality and sensitivity. It is a critical component of any cybersecurity risk management strategy because it helps you determine the appropriate protection and retention controls for the data. Data classification is a component of the security pillar in the AWS Well-Architected Framework. For more information, see [Data classification](#).

### data drift

A meaningful variation between the production data and the data that was used to train an ML model, or a meaningful change in the input data over time. Data drift can reduce the overall quality, accuracy, and fairness in ML model predictions.

### data in transit

Data that is actively moving through your network, such as between network resources.

### data mesh

An architectural framework that provides distributed, decentralized data ownership with centralized management and governance.

### data minimization

The principle of collecting and processing only the data that is strictly necessary. Practicing data minimization in the AWS Cloud can reduce privacy risks, costs, and your analytics carbon footprint.

### data perimeter

A set of preventive guardrails in your AWS environment that help make sure that only trusted identities are accessing trusted resources from expected networks. For more information, see [Building a data perimeter on AWS](#).

## data preprocessing

To transform raw data into a format that is easily parsed by your ML model. Preprocessing data can mean removing certain columns or rows and addressing missing, inconsistent, or duplicate values.

## data provenance

The process of tracking the origin and history of data throughout its lifecycle, such as how the data was generated, transmitted, and stored.

## data subject

An individual whose data is being collected and processed.

## data warehouse

A data management system that supports business intelligence, such as analytics. Data warehouses commonly contain large amounts of historical data, and they are typically used for queries and analysis.

## database definition language (DDL)

Statements or commands for creating or modifying the structure of tables and objects in a database.

## database manipulation language (DML)

Statements or commands for modifying (inserting, updating, and deleting) information in a database.

## DDL

See [database definition language](#).

## deep ensemble

To combine multiple deep learning models for prediction. You can use deep ensembles to obtain a more accurate prediction or for estimating uncertainty in predictions.

## deep learning

An ML subfield that uses multiple layers of artificial neural networks to identify mapping between input data and target variables of interest.

## defense-in-depth

An information security approach in which a series of security mechanisms and controls are thoughtfully layered throughout a computer network to protect the confidentiality, integrity, and availability of the network and the data within. When you adopt this strategy on AWS, you add multiple controls at different layers of the AWS Organizations structure to help secure resources. For example, a defense-in-depth approach might combine multi-factor authentication, network segmentation, and encryption.

## delegated administrator

In AWS Organizations, a compatible service can register an AWS member account to administer the organization's accounts and manage permissions for that service. This account is called the *delegated administrator* for that service. For more information and a list of compatible services, see [Services that work with AWS Organizations](#) in the AWS Organizations documentation.

## deployment

The process of making an application, new features, or code fixes available in the target environment. Deployment involves implementing changes in a code base and then building and running that code base in the application's environments.

## development environment

See [environment](#).

## detective control

A security control that is designed to detect, log, and alert after an event has occurred. These controls are a second line of defense, alerting you to security events that bypassed the preventative controls in place. For more information, see [Detective controls](#) in *Implementing security controls on AWS*.

## development value stream mapping (DVSM)

A process used to identify and prioritize constraints that adversely affect speed and quality in a software development lifecycle. DVSM extends the value stream mapping process originally designed for lean manufacturing practices. It focuses on the steps and teams required to create and move value through the software development process.



## digital twin

A virtual representation of a real-world system, such as a building, factory, industrial equipment, or production line. Digital twins support predictive maintenance, remote monitoring, and production optimization.

## dimension table

In a [star schema](#), a smaller table that contains data attributes about quantitative data in a fact table. Dimension table attributes are typically text fields or discrete numbers that behave like text. These attributes are commonly used for query constraining, filtering, and result set labeling.

## disaster

An event that prevents a workload or system from fulfilling its business objectives in its primary deployed location. These events can be natural disasters, technical failures, or the result of human actions, such as unintentional misconfiguration or a malware attack.

## disaster recovery (DR)

The strategy and process you use to minimize downtime and data loss caused by a [disaster](#). For more information, see [Disaster Recovery of Workloads on AWS: Recovery in the Cloud](#) in the AWS Well-Architected Framework.

## DML

See [database manipulation language](#).

## domain-driven design

An approach to developing a complex software system by connecting its components to evolving domains, or core business goals, that each component serves. This concept was introduced by Eric Evans in his book, *Domain-Driven Design: Tackling Complexity in the Heart of Software* (Boston: Addison-Wesley Professional, 2003). For information about how you can use domain-driven design with the strangler fig pattern, see [Modernizing legacy Microsoft ASP.NET \(ASMX\) web services incrementally by using containers and Amazon API Gateway](#).

## DR

See [disaster recovery](#).

## drift detection

Tracking deviations from a baselined configuration. For example, you can use AWS CloudFormation to [detect drift in system resources](#), or you can use AWS Control Tower to [detect changes in your landing zone](#) that might affect compliance with governance requirements.

## DVSM

See [development value stream mapping](#).

# E

## EDA

See [exploratory data analysis](#).

## EDI

See [electronic data interchange](#).

## edge computing

The technology that increases the computing power for smart devices at the edges of an IoT network. When compared with [cloud computing](#), edge computing can reduce communication latency and improve response time.

## electronic data interchange (EDI)

The automated exchange of business documents between organizations. For more information, see [What is Electronic Data Interchange](#).

## encryption

A computing process that transforms plaintext data, which is human-readable, into ciphertext.

## encryption key

A cryptographic string of randomized bits that is generated by an encryption algorithm. Keys can vary in length, and each key is designed to be unpredictable and unique.

## endianness

The order in which bytes are stored in computer memory. Big-endian systems store the most significant byte first. Little-endian systems store the least significant byte first.

## endpoint

See [service endpoint](#).

## endpoint service

A service that you can host in a virtual private cloud (VPC) to share with other users. You can create an endpoint service with AWS PrivateLink and grant permissions to other AWS accounts or to AWS Identity and Access Management (IAM) principals. These accounts or principals can connect to your endpoint service privately by creating interface VPC endpoints. For more information, see [Create an endpoint service](#) in the Amazon Virtual Private Cloud (Amazon VPC) documentation.

## enterprise resource planning (ERP)

A system that automates and manages key business processes (such as accounting, [MES](#), and project management) for an enterprise.

## envelope encryption

The process of encrypting an encryption key with another encryption key. For more information, see [Envelope encryption](#) in the AWS Key Management Service (AWS KMS) documentation.

## environment

An instance of a running application. The following are common types of environments in cloud computing:

- development environment – An instance of a running application that is available only to the core team responsible for maintaining the application. Development environments are used to test changes before promoting them to upper environments. This type of environment is sometimes referred to as a *test environment*.
- lower environments – All development environments for an application, such as those used for initial builds and tests.
- production environment – An instance of a running application that end users can access. In a CI/CD pipeline, the production environment is the last deployment environment.
- upper environments – All environments that can be accessed by users other than the core development team. This can include a production environment, preproduction environments, and environments for user acceptance testing.

## epic

In agile methodologies, functional categories that help organize and prioritize your work. Epics provide a high-level description of requirements and implementation tasks. For example, AWS CAF security epics include identity and access management, detective controls, infrastructure security, data protection, and incident response. For more information about epics in the AWS migration strategy, see the [program implementation guide](#).

## ERP

See [enterprise resource planning](#).

## exploratory data analysis (EDA)

The process of analyzing a dataset to understand its main characteristics. You collect or aggregate data and then perform initial investigations to find patterns, detect anomalies, and check assumptions. EDA is performed by calculating summary statistics and creating data visualizations.

## F

### fact table

The central table in a [star schema](#). It stores quantitative data about business operations. Typically, a fact table contains two types of columns: those that contain measures and those that contain a foreign key to a dimension table.

### fail fast

A philosophy that uses frequent and incremental testing to reduce the development lifecycle. It is a critical part of an agile approach.

### fault isolation boundary

In the AWS Cloud, a boundary such as an Availability Zone, AWS Region, control plane, or data plane that limits the effect of a failure and helps improve the resilience of workloads. For more information, see [AWS Fault Isolation Boundaries](#).

### feature branch

See [branch](#).

## features

The input data that you use to make a prediction. For example, in a manufacturing context, features could be images that are periodically captured from the manufacturing line.

## feature importance

How significant a feature is for a model's predictions. This is usually expressed as a numerical score that can be calculated through various techniques, such as Shapley Additive Explanations (SHAP) and integrated gradients. For more information, see [Machine learning model interpretability with AWS](#).

## feature transformation

To optimize data for the ML process, including enriching data with additional sources, scaling values, or extracting multiple sets of information from a single data field. This enables the ML model to benefit from the data. For example, if you break down the "2021-05-27 00:15:37" date into "2021", "May", "Thu", and "15", you can help the learning algorithm learn nuanced patterns associated with different data components.

## few-shot prompting

Providing an [LLM](#) with a small number of examples that demonstrate the task and desired output before asking it to perform a similar task. This technique is an application of in-context learning, where models learn from examples (*shots*) that are embedded in prompts. Few-shot prompting can be effective for tasks that require specific formatting, reasoning, or domain knowledge. See also [zero-shot prompting](#).

## FGAC

See [fine-grained access control](#).

## fine-grained access control (FGAC)

The use of multiple conditions to allow or deny an access request.

## flash-cut migration

A database migration method that uses continuous data replication through [change data capture](#) to migrate data in the shortest time possible, instead of using a phased approach. The objective is to keep downtime to a minimum.

## FM

See [foundation model](#).

## foundation model (FM)

A large deep-learning neural network that has been training on massive datasets of generalized and unlabeled data. FMs are capable of performing a wide variety of general tasks, such as understanding language, generating text and images, and conversing in natural language. For more information, see [What are Foundation Models](#).

## G

### generative AI

A subset of [AI](#) models that have been trained on large amounts of data and that can use a simple text prompt to create new content and artifacts, such as images, videos, text, and audio. For more information, see [What is Generative AI](#).

### geo blocking

See [geographic restrictions](#).

### geographic restrictions (geo blocking)

In Amazon CloudFront, an option to prevent users in specific countries from accessing content distributions. You can use an allow list or block list to specify approved and banned countries. For more information, see [Restricting the geographic distribution of your content](#) in the CloudFront documentation.

### Gitflow workflow

An approach in which lower and upper environments use different branches in a source code repository. The Gitflow workflow is considered legacy, and the [trunk-based workflow](#) is the modern, preferred approach.

### golden image

A snapshot of a system or software that is used as a template to deploy new instances of that system or software. For example, in manufacturing, a golden image can be used to provision software on multiple devices and helps improve speed, scalability, and productivity in device manufacturing operations.

### greenfield strategy

The absence of existing infrastructure in a new environment. When adopting a greenfield strategy for a system architecture, you can select all new technologies without the restriction

of compatibility with existing infrastructure, also known as [brownfield](#). If you are expanding the existing infrastructure, you might blend brownfield and greenfield strategies.

## guardrail

A high-level rule that helps govern resources, policies, and compliance across organizational units (OUs). *Preventive guardrails* enforce policies to ensure alignment to compliance standards. They are implemented by using service control policies and IAM permissions boundaries. *Detective guardrails* detect policy violations and compliance issues, and generate alerts for remediation. They are implemented by using AWS Config, AWS Security Hub, Amazon GuardDuty, AWS Trusted Advisor, Amazon Inspector, and custom AWS Lambda checks.

## H

### HA

See [high availability](#).

### heterogeneous database migration

Migrating your source database to a target database that uses a different database engine (for example, Oracle to Amazon Aurora). Heterogeneous migration is typically part of a re-architecting effort, and converting the schema can be a complex task. [AWS provides AWS SCT](#) that helps with schema conversions.

### high availability (HA)

The ability of a workload to operate continuously, without intervention, in the event of challenges or disasters. HA systems are designed to automatically fail over, consistently deliver high-quality performance, and handle different loads and failures with minimal performance impact.

### historian modernization

An approach used to modernize and upgrade operational technology (OT) systems to better serve the needs of the manufacturing industry. A *historian* is a type of database that is used to collect and store data from various sources in a factory.

## holdout data

A portion of historical, labeled data that is withheld from a dataset that is used to train a [machine learning](#) model. You can use holdout data to evaluate the model performance by comparing the model predictions against the holdout data.

## homogeneous database migration

Migrating your source database to a target database that shares the same database engine (for example, Microsoft SQL Server to Amazon RDS for SQL Server). Homogeneous migration is typically part of a rehosting or replatforming effort. You can use native database utilities to migrate the schema.

## hot data

Data that is frequently accessed, such as real-time data or recent translational data. This data typically requires a high-performance storage tier or class to provide fast query responses.

## hotfix

An urgent fix for a critical issue in a production environment. Due to its urgency, a hotfix is usually made outside of the typical DevOps release workflow.

## hypercure period

Immediately following cutover, the period of time when a migration team manages and monitors the migrated applications in the cloud in order to address any issues. Typically, this period is 1–4 days in length. At the end of the hypercure period, the migration team typically transfers responsibility for the applications to the cloud operations team.

## I

## IaC

See [infrastructure as code](#).

## identity-based policy

A policy attached to one or more IAM principals that defines their permissions within the AWS Cloud environment.



## idle application

An application that has an average CPU and memory usage between 5 and 20 percent over a period of 90 days. In a migration project, it is common to retire these applications or retain them on premises.

## IIoT

See [Industrial Internet of Things](#).

## immutable infrastructure

A model that deploys new infrastructure for production workloads instead of updating, patching, or modifying the existing infrastructure. Immutable infrastructures are inherently more consistent, reliable, and predictable than [mutable infrastructure](#). For more information, see the [Deploy using immutable infrastructure](#) best practice in the AWS Well-Architected Framework.

## inbound (ingress) VPC

In an AWS multi-account architecture, a VPC that accepts, inspects, and routes network connections from outside an application. The [AWS Security Reference Architecture](#) recommends setting up your Network account with inbound, outbound, and inspection VPCs to protect the two-way interface between your application and the broader internet.

## incremental migration

A cutover strategy in which you migrate your application in small parts instead of performing a single, full cutover. For example, you might move only a few microservices or users to the new system initially. After you verify that everything is working properly, you can incrementally move additional microservices or users until you can decommission your legacy system. This strategy reduces the risks associated with large migrations.

## Industry 4.0

A term that was introduced by [Klaus Schwab](#) in 2016 to refer to the modernization of manufacturing processes through advances in connectivity, real-time data, automation, analytics, and AI/ML.

## infrastructure

All of the resources and assets contained within an application's environment.

## infrastructure as code (IaC)

The process of provisioning and managing an application's infrastructure through a set of configuration files. IaC is designed to help you centralize infrastructure management, standardize resources, and scale quickly so that new environments are repeatable, reliable, and consistent.

## industrial Internet of Things (IIoT)

The use of internet-connected sensors and devices in the industrial sectors, such as manufacturing, energy, automotive, healthcare, life sciences, and agriculture. For more information, see [Building an industrial Internet of Things \(IIoT\) digital transformation strategy](#).

## inspection VPC

In an AWS multi-account architecture, a centralized VPC that manages inspections of network traffic between VPCs (in the same or different AWS Regions), the internet, and on-premises networks. The [AWS Security Reference Architecture](#) recommends setting up your Network account with inbound, outbound, and inspection VPCs to protect the two-way interface between your application and the broader internet.

## Internet of Things (IoT)

The network of connected physical objects with embedded sensors or processors that communicate with other devices and systems through the internet or over a local communication network. For more information, see [What is IoT?](#)

## interpretability

A characteristic of a machine learning model that describes the degree to which a human can understand how the model's predictions depend on its inputs. For more information, see [Machine learning model interpretability with AWS](#).

## IoT

See [Internet of Things](#).

## IT information library (ITIL)

A set of best practices for delivering IT services and aligning these services with business requirements. ITIL provides the foundation for ITSM.

## IT service management (ITSM)

Activities associated with designing, implementing, managing, and supporting IT services for an organization. For information about integrating cloud operations with ITSM tools, see the [operations integration guide](#).

## ITIL

See [IT information library](#).

## ITSM

See [IT service management](#).

## L

### label-based access control (LBAC)

An implementation of mandatory access control (MAC) where the users and the data itself are each explicitly assigned a security label value. The intersection between the user security label and data security label determines which rows and columns can be seen by the user.

### landing zone

A landing zone is a well-architected, multi-account AWS environment that is scalable and secure. This is a starting point from which your organizations can quickly launch and deploy workloads and applications with confidence in their security and infrastructure environment. For more information about landing zones, see [Setting up a secure and scalable multi-account AWS environment](#).

### large language model (LLM)

A deep learning [AI](#) model that is pretrained on a vast amount of data. An LLM can perform multiple tasks, such as answering questions, summarizing documents, translating text into other languages, and completing sentences. For more information, see [What are LLMs](#).

### large migration

A migration of 300 or more servers.

## LBAC

See [label-based access control](#).

## least privilege

The security best practice of granting the minimum permissions required to perform a task. For more information, see [Apply least-privilege permissions](#) in the IAM documentation.

## lift and shift

See [7 Rs](#).

## little-endian system

A system that stores the least significant byte first. See also [endianness](#).

## LLM

See [large language model](#).

## lower environments

See [environment](#).

# M

## machine learning (ML)

A type of artificial intelligence that uses algorithms and techniques for pattern recognition and learning. ML analyzes and learns from recorded data, such as Internet of Things (IoT) data, to generate a statistical model based on patterns. For more information, see [Machine Learning](#).

## main branch

See [branch](#).

## malware

Software that is designed to compromise computer security or privacy. Malware might disrupt computer systems, leak sensitive information, or gain unauthorized access. Examples of malware include viruses, worms, ransomware, Trojan horses, spyware, and keyloggers.

## managed services

AWS services for which AWS operates the infrastructure layer, the operating system, and platforms, and you access the endpoints to store and retrieve data. Amazon Simple Storage Service (Amazon S3) and Amazon DynamoDB are examples of managed services. These are also known as *abstracted services*.

## manufacturing execution system (MES)

A software system for tracking, monitoring, documenting, and controlling production processes that convert raw materials to finished products on the shop floor.

## MAP

See [Migration Acceleration Program](#).

## mechanism

A complete process in which you create a tool, drive adoption of the tool, and then inspect the results in order to make adjustments. A mechanism is a cycle that reinforces and improves itself as it operates. For more information, see [Building mechanisms](#) in the AWS Well-Architected Framework.

## member account

All AWS accounts other than the management account that are part of an organization in AWS Organizations. An account can be a member of only one organization at a time.

## MES

See [manufacturing execution system](#).

## Message Queuing Telemetry Transport (MQTT)

A lightweight, machine-to-machine (M2M) communication protocol, based on the [publish/subscribe](#) pattern, for resource-constrained [IoT](#) devices.

## microservice

A small, independent service that communicates over well-defined APIs and is typically owned by small, self-contained teams. For example, an insurance system might include microservices that map to business capabilities, such as sales or marketing, or subdomains, such as purchasing, claims, or analytics. The benefits of microservices include agility, flexible scaling, easy deployment, reusable code, and resilience. For more information, see [Integrating microservices by using AWS serverless services](#).

## microservices architecture

An approach to building an application with independent components that run each application process as a microservice. These microservices communicate through a well-defined interface by using lightweight APIs. Each microservice in this architecture can be updated, deployed,

and scaled to meet demand for specific functions of an application. For more information, see [Implementing microservices on AWS](#).

### Migration Acceleration Program (MAP)

An AWS program that provides consulting support, training, and services to help organizations build a strong operational foundation for moving to the cloud, and to help offset the initial cost of migrations. MAP includes a migration methodology for executing legacy migrations in a methodical way and a set of tools to automate and accelerate common migration scenarios.

### migration at scale

The process of moving the majority of the application portfolio to the cloud in waves, with more applications moved at a faster rate in each wave. This phase uses the best practices and lessons learned from the earlier phases to implement a *migration factory* of teams, tools, and processes to streamline the migration of workloads through automation and agile delivery. This is the third phase of the [AWS migration strategy](#).

### migration factory

Cross-functional teams that streamline the migration of workloads through automated, agile approaches. Migration factory teams typically include operations, business analysts and owners, migration engineers, developers, and DevOps professionals working in sprints. Between 20 and 50 percent of an enterprise application portfolio consists of repeated patterns that can be optimized by a factory approach. For more information, see the [discussion of migration factories](#) and the [Cloud Migration Factory guide](#) in this content set.

### migration metadata

The information about the application and server that is needed to complete the migration. Each migration pattern requires a different set of migration metadata. Examples of migration metadata include the target subnet, security group, and AWS account.

### migration pattern

A repeatable migration task that details the migration strategy, the migration destination, and the migration application or service used. Example: Rehost migration to Amazon EC2 with AWS Application Migration Service.

### Migration Portfolio Assessment (MPA)

An online tool that provides information for validating the business case for migrating to the AWS Cloud. MPA provides detailed portfolio assessment (server right-sizing, pricing, TCO

comparisons, migration cost analysis) as well as migration planning (application data analysis and data collection, application grouping, migration prioritization, and wave planning). The [MPA tool](#) (requires login) is available free of charge to all AWS consultants and APN Partner consultants.

## Migration Readiness Assessment (MRA)

The process of gaining insights about an organization's cloud readiness status, identifying strengths and weaknesses, and building an action plan to close identified gaps, using the AWS CAF. For more information, see the [migration readiness guide](#). MRA is the first phase of the [AWS migration strategy](#).

## migration strategy

The approach used to migrate a workload to the AWS Cloud. For more information, see the [7 Rs](#) entry in this glossary and see [Mobilize your organization to accelerate large-scale migrations](#).

## ML

See [machine learning](#).

## modernization

Transforming an outdated (legacy or monolithic) application and its infrastructure into an agile, elastic, and highly available system in the cloud to reduce costs, gain efficiencies, and take advantage of innovations. For more information, see [Strategy for modernizing applications in the AWS Cloud](#).

## modernization readiness assessment

An evaluation that helps determine the modernization readiness of an organization's applications; identifies benefits, risks, and dependencies; and determines how well the organization can support the future state of those applications. The outcome of the assessment is a blueprint of the target architecture, a roadmap that details development phases and milestones for the modernization process, and an action plan for addressing identified gaps. For more information, see [Evaluating modernization readiness for applications in the AWS Cloud](#).

## monolithic applications (monoliths)

Applications that run as a single service with tightly coupled processes. Monolithic applications have several drawbacks. If one application feature experiences a spike in demand, the entire architecture must be scaled. Adding or improving a monolithic application's features also becomes more complex when the code base grows. To address these issues, you can

use a microservices architecture. For more information, see [Decomposing monoliths into microservices](#).

## MPA

See [Migration Portfolio Assessment](#).

## MQTT

See [Message Queuing Telemetry Transport](#).

## multiclass classification

A process that helps generate predictions for multiple classes (predicting one of more than two outcomes). For example, an ML model might ask "Is this product a book, car, or phone?" or "Which product category is most interesting to this customer?"

## mutable infrastructure

A model that updates and modifies the existing infrastructure for production workloads. For improved consistency, reliability, and predictability, the AWS Well-Architected Framework recommends the use of [immutable infrastructure](#) as a best practice.

# O

## OAC

See [origin access control](#).

## OAI

See [origin access identity](#).

## OCM

See [organizational change management](#).

## offline migration

A migration method in which the source workload is taken down during the migration process. This method involves extended downtime and is typically used for small, non-critical workloads.

## OI

See [operations integration](#).



## OLA

See [operational-level agreement](#).

## online migration

A migration method in which the source workload is copied to the target system without being taken offline. Applications that are connected to the workload can continue to function during the migration. This method involves zero to minimal downtime and is typically used for critical production workloads.

## OPC-UA

See [Open Process Communications - Unified Architecture](#).

## Open Process Communications - Unified Architecture (OPC-UA)

A machine-to-machine (M2M) communication protocol for industrial automation. OPC-UA provides an interoperability standard with data encryption, authentication, and authorization schemes.

## operational-level agreement (OLA)

An agreement that clarifies what functional IT groups promise to deliver to each other, to support a service-level agreement (SLA).

## operational readiness review (ORR)

A checklist of questions and associated best practices that help you understand, evaluate, prevent, or reduce the scope of incidents and possible failures. For more information, see [Operational Readiness Reviews \(ORR\)](#) in the AWS Well-Architected Framework.

## operational technology (OT)

Hardware and software systems that work with the physical environment to control industrial operations, equipment, and infrastructure. In manufacturing, the integration of OT and information technology (IT) systems is a key focus for [Industry 4.0](#) transformations.

## operations integration (OI)

The process of modernizing operations in the cloud, which involves readiness planning, automation, and integration. For more information, see the [operations integration guide](#).

## organization trail

A trail that's created by AWS CloudTrail that logs all events for all AWS accounts in an organization in AWS Organizations. This trail is created in each AWS account that's part of the

organization and tracks the activity in each account. For more information, see [Creating a trail for an organization](#) in the CloudTrail documentation.

### organizational change management (OCM)

A framework for managing major, disruptive business transformations from a people, culture, and leadership perspective. OCM helps organizations prepare for, and transition to, new systems and strategies by accelerating change adoption, addressing transitional issues, and driving cultural and organizational changes. In the AWS migration strategy, this framework is called *people acceleration*, because of the speed of change required in cloud adoption projects. For more information, see the [OCM guide](#).

### origin access control (OAC)

In CloudFront, an enhanced option for restricting access to secure your Amazon Simple Storage Service (Amazon S3) content. OAC supports all S3 buckets in all AWS Regions, server-side encryption with AWS KMS (SSE-KMS), and dynamic PUT and DELETE requests to the S3 bucket.

### origin access identity (OAI)

In CloudFront, an option for restricting access to secure your Amazon S3 content. When you use OAI, CloudFront creates a principal that Amazon S3 can authenticate with. Authenticated principals can access content in an S3 bucket only through a specific CloudFront distribution. See also [OAC](#), which provides more granular and enhanced access control.

### ORR

See [operational readiness review](#).

### OT

See [operational technology](#).

### outbound (egress) VPC

In an AWS multi-account architecture, a VPC that handles network connections that are initiated from within an application. The [AWS Security Reference Architecture](#) recommends setting up your Network account with inbound, outbound, and inspection VPCs to protect the two-way interface between your application and the broader internet.

## P

### permissions boundary

An IAM management policy that is attached to IAM principals to set the maximum permissions that the user or role can have. For more information, see [Permissions boundaries](#) in the IAM documentation.

### personally identifiable information (PII)

Information that, when viewed directly or paired with other related data, can be used to reasonably infer the identity of an individual. Examples of PII include names, addresses, and contact information.

### PII

See [personally identifiable information](#).

### playbook

A set of predefined steps that capture the work associated with migrations, such as delivering core operations functions in the cloud. A playbook can take the form of scripts, automated runbooks, or a summary of processes or steps required to operate your modernized environment.

### PLC

See [programmable logic controller](#).

### PLM

See [product lifecycle management](#).

### policy

An object that can define permissions (see [identity-based policy](#)), specify access conditions (see [resource-based policy](#)), or define the maximum permissions for all accounts in an organization in AWS Organizations (see [service control policy](#)).

### polyglot persistence

Independently choosing a microservice's data storage technology based on data access patterns and other requirements. If your microservices have the same data storage technology, they can encounter implementation challenges or experience poor performance. Microservices are more easily implemented and achieve better performance and scalability if they use the data store

best adapted to their requirements. For more information, see [Enabling data persistence in microservices](#).

#### portfolio assessment

A process of discovering, analyzing, and prioritizing the application portfolio in order to plan the migration. For more information, see [Evaluating migration readiness](#).

#### predicate

A query condition that returns `true` or `false`, commonly located in a `WHERE` clause.

#### predicate pushdown

A database query optimization technique that filters the data in the query before transfer. This reduces the amount of data that must be retrieved and processed from the relational database, and it improves query performance.

#### preventative control

A security control that is designed to prevent an event from occurring. These controls are a first line of defense to help prevent unauthorized access or unwanted changes to your network. For more information, see [Preventative controls](#) in *Implementing security controls on AWS*.

#### principal

An entity in AWS that can perform actions and access resources. This entity is typically a root user for an AWS account, an IAM role, or a user. For more information, see *Principal* in [Roles terms and concepts](#) in the IAM documentation.

#### privacy by design

A system engineering approach that takes privacy into account through the whole development process.

#### private hosted zones

A container that holds information about how you want Amazon Route 53 to respond to DNS queries for a domain and its subdomains within one or more VPCs. For more information, see [Working with private hosted zones](#) in the Route 53 documentation.

#### proactive control

A [security control](#) designed to prevent the deployment of noncompliant resources. These controls scan resources before they are provisioned. If the resource is not compliant with the control, then it isn't provisioned. For more information, see the [Controls reference guide](#) in the

AWS Control Tower documentation and see [Proactive controls](#) in *Implementing security controls on AWS*.

### product lifecycle management (PLM)

The management of data and processes for a product throughout its entire lifecycle, from design, development, and launch, through growth and maturity, to decline and removal.

### production environment

See [environment](#).

### programmable logic controller (PLC)

In manufacturing, a highly reliable, adaptable computer that monitors machines and automates manufacturing processes.

### prompt chaining

Using the output of one [LLM](#) prompt as the input for the next prompt to generate better responses. This technique is used to break down a complex task into subtasks, or to iteratively refine or expand a preliminary response. It helps improve the accuracy and relevance of a model's responses and allows for more granular, personalized results.

### pseudonymization

The process of replacing personal identifiers in a dataset with placeholder values. Pseudonymization can help protect personal privacy. Pseudonymized data is still considered to be personal data.

### publish/subscribe (pub/sub)

A pattern that enables asynchronous communications among microservices to improve scalability and responsiveness. For example, in a microservices-based [MES](#), a microservice can publish event messages to a channel that other microservices can subscribe to. The system can add new microservices without changing the publishing service.

## Q

### query plan

A series of steps, like instructions, that are used to access the data in a SQL relational database system.

## query plan regression

When a database service optimizer chooses a less optimal plan than it did before a given change to the database environment. This can be caused by changes to statistics, constraints, environment settings, query parameter bindings, and updates to the database engine.

## R

### RACI matrix

See [responsible, accountable, consulted, informed \(RACI\)](#).

### RAG

See [Retrieval Augmented Generation](#).

### ransomware

A malicious software that is designed to block access to a computer system or data until a payment is made.

### RASCI matrix

See [responsible, accountable, consulted, informed \(RACI\)](#).

### RCAC

See [row and column access control](#).

### read replica

A copy of a database that's used for read-only purposes. You can route queries to the read replica to reduce the load on your primary database.

### re-architect

See [7 Rs](#).

### recovery point objective (RPO)

The maximum acceptable amount of time since the last data recovery point. This determines what is considered an acceptable loss of data between the last recovery point and the interruption of service.

## recovery time objective (RTO)

The maximum acceptable delay between the interruption of service and restoration of service.

## refactor

See [7 Rs](#).

## Region

A collection of AWS resources in a geographic area. Each AWS Region is isolated and independent of the others to provide fault tolerance, stability, and resilience. For more information, see [Specify which AWS Regions your account can use](#).

## regression

An ML technique that predicts a numeric value. For example, to solve the problem of "What price will this house sell for?" an ML model could use a linear regression model to predict a house's sale price based on known facts about the house (for example, the square footage).

## rehost

See [7 Rs](#).

## release

In a deployment process, the act of promoting changes to a production environment.

## relocate

See [7 Rs](#).

## replatform

See [7 Rs](#).

## repurchase

See [7 Rs](#).

## resiliency

An application's ability to resist or recover from disruptions. [High availability](#) and [disaster recovery](#) are common considerations when planning for resiliency in the AWS Cloud. For more information, see [AWS Cloud Resilience](#).

## resource-based policy

A policy attached to a resource, such as an Amazon S3 bucket, an endpoint, or an encryption key. This type of policy specifies which principals are allowed access, supported actions, and any other conditions that must be met.

## responsible, accountable, consulted, informed (RACI) matrix

A matrix that defines the roles and responsibilities for all parties involved in migration activities and cloud operations. The matrix name is derived from the responsibility types defined in the matrix: responsible (R), accountable (A), consulted (C), and informed (I). The support (S) type is optional. If you include support, the matrix is called a *RASCI matrix*, and if you exclude it, it's called a *RACI matrix*.

## responsive control

A security control that is designed to drive remediation of adverse events or deviations from your security baseline. For more information, see [Responsive controls](#) in *Implementing security controls on AWS*.

## retain

See [7 Rs](#).

## retire

See [7 Rs](#).

## Retrieval Augmented Generation (RAG)

A [generative AI](#) technology in which an [LLM](#) references an authoritative data source that is outside of its training data sources before generating a response. For example, a RAG model might perform a semantic search of an organization's knowledge base or custom data. For more information, see [What is RAG](#).

## rotation

The process of periodically updating a [secret](#) to make it more difficult for an attacker to access the credentials.

## row and column access control (RCAC)

The use of basic, flexible SQL expressions that have defined access rules. RCAC consists of row permissions and column masks.



## RPO

See [recovery point objective](#).

## RTO

See [recovery time objective](#).

## runbook

A set of manual or automated procedures required to perform a specific task. These are typically built to streamline repetitive operations or procedures with high error rates.

# S

## SAML 2.0

An open standard that many identity providers (IdPs) use. This feature enables federated single sign-on (SSO), so users can log into the AWS Management Console or call the AWS API operations without you having to create user in IAM for everyone in your organization. For more information about SAML 2.0-based federation, see [About SAML 2.0-based federation](#) in the IAM documentation.

## SCADA

See [supervisory control and data acquisition](#).

## SCP

See [service control policy](#).

## secret

In AWS Secrets Manager, confidential or restricted information, such as a password or user credentials, that you store in encrypted form. It consists of the secret value and its metadata. The secret value can be binary, a single string, or multiple strings. For more information, see [What's in a Secrets Manager secret?](#) in the Secrets Manager documentation.

## security by design

A system engineering approach that takes security into account through the whole development process.

## security control

A technical or administrative guardrail that prevents, detects, or reduces the ability of a threat actor to exploit a security vulnerability. There are four primary types of security controls: [preventative](#), [detective](#), [responsive](#), and [proactive](#).

## security hardening

The process of reducing the attack surface to make it more resistant to attacks. This can include actions such as removing resources that are no longer needed, implementing the security best practice of granting least privilege, or deactivating unnecessary features in configuration files.

## security information and event management (SIEM) system

Tools and services that combine security information management (SIM) and security event management (SEM) systems. A SIEM system collects, monitors, and analyzes data from servers, networks, devices, and other sources to detect threats and security breaches, and to generate alerts.

## security response automation

A predefined and programmed action that is designed to automatically respond to or remediate a security event. These automations serve as [detective](#) or [responsive](#) security controls that help you implement AWS security best practices. Examples of automated response actions include modifying a VPC security group, patching an Amazon EC2 instance, or rotating credentials.

## server-side encryption

Encryption of data at its destination, by the AWS service that receives it.

## service control policy (SCP)

A policy that provides centralized control over permissions for all accounts in an organization in AWS Organizations. SCPs define guardrails or set limits on actions that an administrator can delegate to users or roles. You can use SCPs as allow lists or deny lists, to specify which services or actions are permitted or prohibited. For more information, see [Service control policies](#) in the AWS Organizations documentation.

## service endpoint

The URL of the entry point for an AWS service. You can use the endpoint to connect programmatically to the target service. For more information, see [AWS service endpoints](#) in *AWS General Reference*.

## service-level agreement (SLA)

An agreement that clarifies what an IT team promises to deliver to their customers, such as service uptime and performance.

## service-level indicator (SLI)

A measurement of a performance aspect of a service, such as its error rate, availability, or throughput.

## service-level objective (SLO)

A target metric that represents the health of a service, as measured by a [service-level indicator](#).

## shared responsibility model

A model describing the responsibility you share with AWS for cloud security and compliance. AWS is responsible for security *of* the cloud, whereas you are responsible for security *in* the cloud. For more information, see [Shared responsibility model](#).

## SIEM

See [security information and event management system](#).

## single point of failure (SPOF)

A failure in a single, critical component of an application that can disrupt the system.

## SLA

See [service-level agreement](#).

## SLI

See [service-level indicator](#).

## SLO

See [service-level objective](#).

## split-and-seed model

A pattern for scaling and accelerating modernization projects. As new features and product releases are defined, the core team splits up to create new product teams. This helps scale your organization's capabilities and services, improves developer productivity, and supports rapid

innovation. For more information, see [Phased approach to modernizing applications in the AWS Cloud](#).

## SPOF

See [single point of failure](#).

## star schema

A database organizational structure that uses one large fact table to store transactional or measured data and uses one or more smaller dimensional tables to store data attributes. This structure is designed for use in a [data warehouse](#) or for business intelligence purposes.

## strangler fig pattern

An approach to modernizing monolithic systems by incrementally rewriting and replacing system functionality until the legacy system can be decommissioned. This pattern uses the analogy of a fig vine that grows into an established tree and eventually overcomes and replaces its host. The pattern was [introduced by Martin Fowler](#) as a way to manage risk when rewriting monolithic systems. For an example of how to apply this pattern, see [Modernizing legacy Microsoft ASP.NET \(ASMX\) web services incrementally by using containers and Amazon API Gateway](#).

## subnet

A range of IP addresses in your VPC. A subnet must reside in a single Availability Zone.

## supervisory control and data acquisition (SCADA)

In manufacturing, a system that uses hardware and software to monitor physical assets and production operations.

## symmetric encryption

An encryption algorithm that uses the same key to encrypt and decrypt the data.

## synthetic testing

Testing a system in a way that simulates user interactions to detect potential issues or to monitor performance. You can use [Amazon CloudWatch Synthetics](#) to create these tests.

## system prompt

A technique for providing context, instructions, or guidelines to an [LLM](#) to direct its behavior. System prompts help set context and establish rules for interactions with users.

# T

## tags

Key-value pairs that act as metadata for organizing your AWS resources. Tags can help you manage, identify, organize, search for, and filter resources. For more information, see [Tagging your AWS resources](#).

## target variable

The value that you are trying to predict in supervised ML. This is also referred to as an *outcome variable*. For example, in a manufacturing setting the target variable could be a product defect.

## task list

A tool that is used to track progress through a runbook. A task list contains an overview of the runbook and a list of general tasks to be completed. For each general task, it includes the estimated amount of time required, the owner, and the progress.

## test environment

See [environment](#).

## training

To provide data for your ML model to learn from. The training data must contain the correct answer. The learning algorithm finds patterns in the training data that map the input data attributes to the target (the answer that you want to predict). It outputs an ML model that captures these patterns. You can then use the ML model to make predictions on new data for which you don't know the target.

## transit gateway

A network transit hub that you can use to interconnect your VPCs and on-premises networks. For more information, see [What is a transit gateway](#) in the AWS Transit Gateway documentation.

## trunk-based workflow

An approach in which developers build and test features locally in a feature branch and then merge those changes into the main branch. The main branch is then built to the development, preproduction, and production environments, sequentially.

## trusted access

Granting permissions to a service that you specify to perform tasks in your organization in AWS Organizations and in its accounts on your behalf. The trusted service creates a service-linked role in each account, when that role is needed, to perform management tasks for you. For more information, see [Using AWS Organizations with other AWS services](#) in the AWS Organizations documentation.

## tuning

To change aspects of your training process to improve the ML model's accuracy. For example, you can train the ML model by generating a labeling set, adding labels, and then repeating these steps several times under different settings to optimize the model.

## two-pizza team

A small DevOps team that you can feed with two pizzas. A two-pizza team size ensures the best possible opportunity for collaboration in software development.

# U

## uncertainty

A concept that refers to imprecise, incomplete, or unknown information that can undermine the reliability of predictive ML models. There are two types of uncertainty: *Epistemic uncertainty* is caused by limited, incomplete data, whereas *aleatoric uncertainty* is caused by the noise and randomness inherent in the data. For more information, see the [Quantifying uncertainty in deep learning systems](#) guide.

## undifferentiated tasks

Also known as *heavy lifting*, work that is necessary to create and operate an application but that doesn't provide direct value to the end user or provide competitive advantage. Examples of undifferentiated tasks include procurement, maintenance, and capacity planning.

## upper environments

See [environment](#).

## V

### vacuuming

A database maintenance operation that involves cleaning up after incremental updates to reclaim storage and improve performance.

### version control

Processes and tools that track changes, such as changes to source code in a repository.

### VPC peering

A connection between two VPCs that allows you to route traffic by using private IP addresses. For more information, see [What is VPC peering](#) in the Amazon VPC documentation.

### vulnerability

A software or hardware flaw that compromises the security of the system.

## W

### warm cache

A buffer cache that contains current, relevant data that is frequently accessed. The database instance can read from the buffer cache, which is faster than reading from the main memory or disk.

### warm data

Data that is infrequently accessed. When querying this kind of data, moderately slow queries are typically acceptable.

### window function

A SQL function that performs a calculation on a group of rows that relate in some way to the current record. Window functions are useful for processing tasks, such as calculating a moving average or accessing the value of rows based on the relative position of the current row.

### workload

A collection of resources and code that delivers business value, such as a customer-facing application or backend process.

## workstream

Functional groups in a migration project that are responsible for a specific set of tasks. Each workstream is independent but supports the other workstreams in the project. For example, the portfolio workstream is responsible for prioritizing applications, wave planning, and collecting migration metadata. The portfolio workstream delivers these assets to the migration workstream, which then migrates the servers and applications.

## WORM

See [write once, read many](#).

## WQF

See [AWS Workload Qualification Framework](#).

## write once, read many (WORM)

A storage model that writes data a single time and prevents the data from being deleted or modified. Authorized users can read the data as many times as needed, but they cannot change it. This data storage infrastructure is considered [immutable](#).

## Z

### zero-day exploit

An attack, typically malware, that takes advantage of a [zero-day vulnerability](#).

### zero-day vulnerability

An unmitigated flaw or vulnerability in a production system. Threat actors can use this type of vulnerability to attack the system. Developers frequently become aware of the vulnerability as a result of the attack.

### zero-shot prompting

Providing an [LLM](#) with instructions for performing a task but no examples (*shots*) that can help guide it. The LLM must use its pre-trained knowledge to handle the task. The effectiveness of zero-shot prompting depends on the complexity of the task and the quality of the prompt. See also [few-shot prompting](#).



## zombie application

An application that has an average CPU and memory usage below 5 percent. In a migration project, it is common to retire these applications.